

# NÜVÖ<sup>®</sup>

Whole Home Audio



## NV-I8GMS / NV-I8GXS Audio Distribution System

### Installation Guide





## ENGLISH

### Danger

Exposure to extremely high noise levels may cause a permanent hearing loss. Individuals vary considerably to noise induced hearing loss but nearly everyone will lose some hearing if exposed to sufficiently intense noise for a sufficient time. The U.S. Government's Occupational Safety and Health Administration (OSHA) has specified the following permissible noise level exposures:

DURATION PER DAY (HOURS)	8	6	4	3	2	1
SOUND LEVEL (dB)	90	93	95	97	100	103

According to OSHA, any exposure in the above permissible limits could result in some hearing loss. Ear plugs or protectors in the ear canal or over the ears must be worn when operating this amplification system in order to prevent a permanent hearing loss. If exposure in excess of the limits as put forth above, to insure against potentially harmful exposure to high sound pressure levels, it is recommended that all persons exposed to equipment capable of inducing high sound pressure levels, such as this amplification system, be protected by hearing protectors while this unit is in operation.

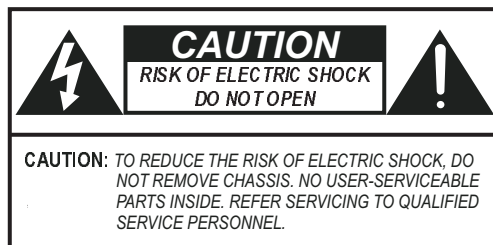

**AVIS: RISQUE DE CHOC ELECTRIQUE-NE PAS OUVRIR.**



THIS SYMBOL IS INTENDED TO ALERT THE USER TO THE PRESENCE OF NON-INSULATED "DANGEROUS VOLTAGE" WITHIN THE PRODUCT'S ENCLOSURE THAT MAY BE OF SUFFICIENT MAGNITUDE TO CONSTITUTE A RISK OF ELECTRIC SHOCK TO PERSONS.



THIS SYMBOL IS INTENDED TO ALERT THE USER TO THE PRESENCE OF IMPORTANT OPERATING AND MAINTENANCE (SERVICING) INSTRUCTIONS IN THE LITERATURE ACCOMPANYING THE UNIT.



APPARATUS SHALL NOT BE EXPOSED TO DRIPPING OR SPLASHING AND THAT NO OBJECTS FILLED WITH LIQUIDS, SUCH AS VASES, SHALL BE PLACED ON THE APPARATUS.

## IMPORTANT SAFETY INSTRUCTIONS

1. Read all safety and operating instructions before using this product.
2. All safety and operating instructions should be kept for future reference.
3. Read and understand all warnings listed on the operating instructions.
4. Follow all operating instructions to operate this product.
5. This product should not be used near water, i.e. bathtub, sink, swimming pool, wet basement, etc.
6. Only use dry cloth to clean this product.
7. Do not block any ventilation openings, It should not be placed flat against a wall or placed in a built-in enclosure that will impede the flow of cooling air.
8. Do not install this product near any heat sources ; such as, radiators, heat registers, stove or other apparatus (including heat producing amplifiers) that produce heat.
9. Do not defeat the safety purpose of the polarized or grounding-type plug. A polarized plug has two blades with one wider than the other. A grounding-type plug has two blades and a third grounding prong. The wide blade or the third prong are provided for your safety. If the provided plug does not fit into your outlet, consult an electrician for replacement of the obsolete outlet.
10. Protect the power cord being walked on or pinched, particularly at plugs, convenience receptacles and the point where they exit from the apparatus. Do not break the ground pin of the power supply cord.
11. Only use attachments specified by the manufacturer.
12. Use only with the cart, stand, tripod, bracket, or table specified by the manufacturer or sold with the apparatus. When a cart is used, use caution when moving cart/apparatus combination to avoid injury from tip-over.
13. Unplug this apparatus during lightning storms or when unused for long periods of time.
14. Care should be taken so that objects do not fall and liquids are not spilled into the unit through the ventilation ports or any other openings.
15. Refer all servicing to qualified service personnel. Servicing is required when the apparatus has been damaged in any way; such as, power-supply cord or plug is damaged, liquid has been spilled or objects have fallen into the apparatus, the apparatus has been exposed to rain or moisture, does not operate normally or has been dropped.
16. **WARNING:** To reduce the risk of fire or electric shock, do not expose this apparatus to rain or moisture.

## FRENCH

### Danger

L'exposition a des niveaux eleves de bruit peut provoquer une perte permanente de l'audition, Chaque organisme humain reagit differemment quant a la perte de l'audition, mais quasiment tout le monde subit une diminution de l'acuite auditive lors d'une exposition suffisamment longue au bruit intense. Les autorites competentes en reglementation de bruit ont defini les expositions tolerees aux niveaux de bruits:

DURE EN HEURES PAR JOUR	8	6	4	3	2	1
INIVEAU SONORE CONTINU EN dB	90	93	95	97	100	103

Selon les autorites, toute exposition dans les limites citees ci-dessus, peuvent provoquer certaines pertes d'audition. Des bouchons ou protections dans l'appareil auditif ou sur l'oreille doivent etre portes lors de l'utilisation de ce systeme d'amplification afin de prevenir le risque de perte permanente de l'audition, Dans le cas d'expositions superieures aux limites precitees il est recommande, afin de se premunir contre les expositions aux pressions acoustiques lvees potentiellement dangeure u ses, aux personnes exposees aux equipements capables de delivrer de telles puissances, tels ce systeme d'amplification en fonctionnement, de proteger l'appareil auditif.



CE SYMBOLE A POUR BUT D'AVERTIR L'UTILISATEUR DE LA PRESENCE DE VOLTAGE DANGEREUX NON-ISOLE A L'INTERIEUR DE CE PRODUIT QUI PEUT ETRE DE PUISSANCE SUFFISAMMENT IMPORTANTE POUR PROVOQUER UN CHOC ELECTRIQUE AUX PERSONNES.



CE SYMBOLE A POUR BUT D'AVERTIR L'UTILISATEUR DE LA PRESENCE D'INSTRUCTIONS D'UTILISATION ET DE MAINTENANCE DANS LES DOCUMENTS FOURNIS AVEC CE PRODUIT.



AFIN DE REDUIRE LES RISQUÉ D'INCENDIE ET DE DECHARGE ELECTRIQUE, NE PAS EXPOSER CET APPAREIL A LA PLUIE OU A L'HUMIDITE.

### IMPORTANTES INSTRUCTIONS DE SECURITE

1. Lire avec attention toutes les recommandations et précautions d'emploi avant d'utiliser ce produit.
2. Toutes les recommandations et précautions d'emploi doivent être conservées afin de pouvoir s'y reporter si nécessaire.
3. Lire et comprendre tous les avertissements énumérés dans les précautions d'emploi.
4. Suivre toutes les précautions d'emploi pour utiliser ce produit.
5. Ce produit ne doit pas être utilisé près d'eau, comme par exemple baignoires, éviers, piscine, sous-sol humides ... Etc.
6. Utiliser exclusivement un chiffon sec pour nettoyer ce produit.
7. Ne bloquer aucune ouverture de ventilation. Ne pas placer le produit tout contre un mur ou dans une enceinte fermée, cela générerait le flux d'air nécessaire au refroidissement.
8. Ne pas placer le produit près de toute source de chaleur telle que radiateurs, arrivées d'air chaud, fourneaux ou autres appareils générant de la chaleur (incluant les amplificateurs producteurs de chaleur) .
9. Ne pas négliger la sécurité que procure un branchement polarisé ou avec raccordement à la terre, Un branchement polarisé comprend deux fiches dont l'une est plus large que l'autre. Un branchement à la terre comprend deux fiches plus une troisième reliée à la terre. Si la fiche secteur fournie ne s'insère pas dans votre prise de courant. consulter un 'électricien afin de remplacer votre prise obsolète.
10. Protéger le cordon d'alimentation de tout écrasement ou pincement, particulièrement au niveau des fiches, des réceptacles utilisés et à l'endroit de sortie de l'appareil. Ne pas casser la fiche de terre du cordon d'alimentation.
11. Utiliser uniquement les accessoires spécifiés par le constructeur.
12. Utiliser uniquement avec le chariot de transport, le support, le trépied, la console ou la table spécifiés par le constructeur ou vendus avec l'appareil. Lors de l'utilisation d'un chariot, bouger avec précaution l'ensemble chariot/appareil afin d'éviter les dommages d'un renversement.
13. Débrancher cet appareil lors d'orages ou s'il n'est pas utilisé pendant une longue période.
14. Des précautions doivent être prises afin qu'aucun objet ne tombe et qu'aucun liquide ne se répande à l'intérieur de l'appareil par les orifices de ventilation ou n'importe quelle autre ouverture.
15. Pour toutes interventions techniques s'adresser à un technicien qualifié. L'intervention technique est nécessaire lorsque l'appareil a été endommagé de n'importe quelle façon, comme par exemple si le cordon secteur ou sa fiche sont détériorés, si du liquide a coulé ou si des objets sont tombés à l'intérieur de l'appareil, si l'appareil a été exposé à la pluie ou à l'humidité, s'il ne fonctionne pas normalement ou s'il est tombé.
16. ATTENTION: Pour réduire le risque d'incendie ou de choc électrique ne pas exposer l'appareil à la pluie ou à l'humidité.

## Table of Contents

Introduction .....	Page 3
Grand Concerto Back Panel .....	Page 4
NV-I8GCP 2.7" OLED Control Pad .....	Page 5
NV-E6GCP 1" OLED Control Pad .....	Page 6
NV-CTP36 Color Touch Pad .....	Page 7
NV-WCPS Wireless Control Pad .....	Page 8
NV-GRC1 Remote Control .....	Page 9
Installing Grand Concerto in Your Home	
I. CAT5 Termination .....	Page 10
II. Terminating Speaker Wire .....	Page 11
III. Installing the Grand Concerto Amplifier .....	Page 11
IV. Installing the NV-I8GEZP EZ Port .....	Page 11
V. Connecting the EZ Port to the Grand Concerto Amplifier .....	Page 12
VI. Attaching Audio Source Equipment .....	Page 12
Setting up the NuVo Sources for use with NuVoNet .....	Page 12
VII. Connecting the IR Emitters for Third-Party Source Components .....	Page 13
VIII. Expanding Grand Concerto to 16 Zones .....	Page 14
IX. Using the Grand Concerto Configurator Software .....	Page 14
1. Main Startup .....	Page 14
2. IR Libraries .....	Page 15
3. Defining Sources .....	Page 18
4. Macros .....	Page 19
5. Zones .....	Page 21
6. System Settings .....	Page 23
7. Update System .....	Page 25
X. Control Pad Setup .....	Page 26
XI. Using the Control Pad's MENU Button .....	Page 26
Favorites .....	Page 26
Sources .....	Page 27
Advanced Zone Control .....	Page 27
Setup .....	Page 28
Favorites 1-12 .....	Page 28
Zone Settings .....	Page 28
Source Settings .....	Page 30
System Settings .....	Page 30
XII. Grand Concerto Accessories	
The NV-I8DLS IR Learning Station Interface .....	Page 32
NV-MI1 Mute Interrupt Adaptor .....	Page 34
NV-LSI24 Local Source Interrupt .....	Page 35
NV-LSA40 Local Source Amplifier .....	Page 36
NV-LSA40PD Local Source Power Distribution Hub .....	Page 37
NV-D2120/D460 Auxiliary Amplifiers .....	Page 38
Grand Concerto Specifications .....	Page 39
Troubleshooting .....	Page 40

## Introduction

Congratulations on the purchase of your NuVo System. The Grand Concerto System represents NuVo's best. The Grand Concerto's state-of-the-art control and NuVoNet communication with the Grand Concerto Suite of audio components offer the highest value whole-home audio system available.

This installation manual outlines the installation and setup of your new Grand Concerto System. We recommend that you read this manual prior to installing your system. Proper installation and setup will insure years of audio enjoyment.

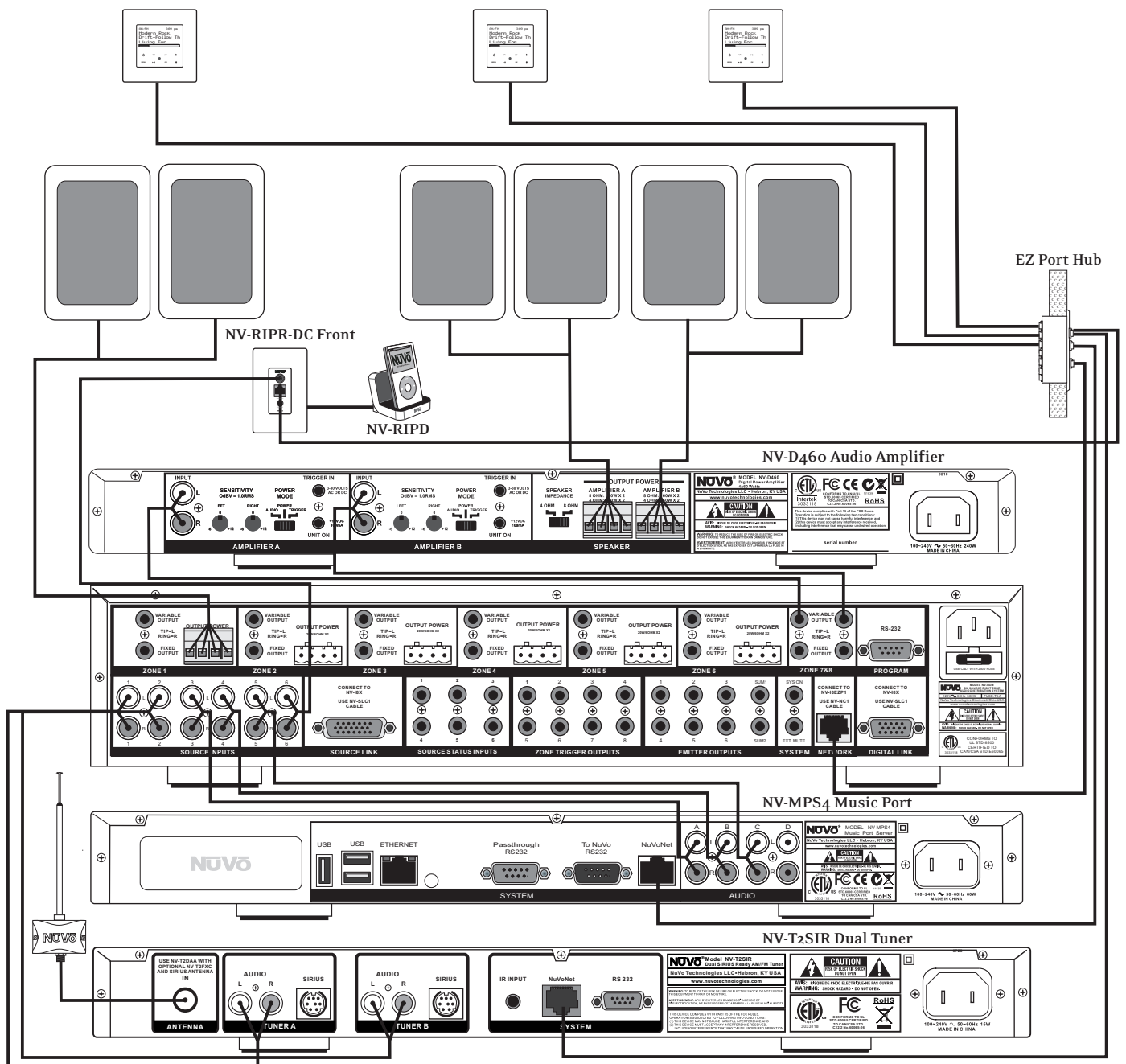

**Grand Concerto Suite Wiring Diagram**

## Grand Concerto Back Panel

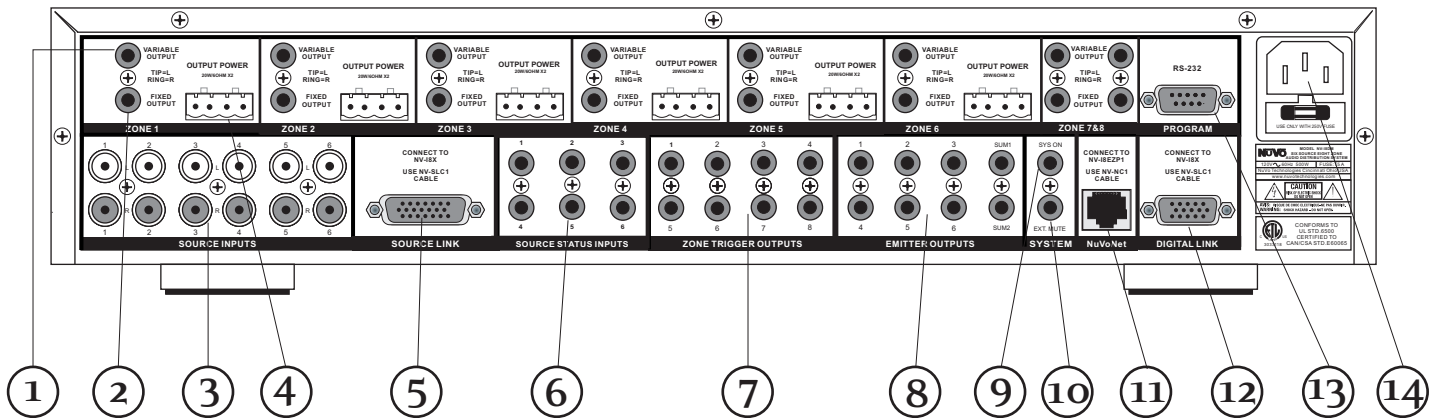

1. **Variable Output:** These preamp lineouts are used for sending an audio signal to an external power amplifier. This is useful for large areas that require additional pairs of speakers. Use the variable output when you want the additional amplifier to be controlled by the zone's Control Pad.
2. **Fixed Output:** These preamp lineouts are used for sending an audio signal to an external power amplifier when additional speakers are needed. This output is constant, so an amplifier connected to it will not change volume with that zone's Control Pad.
3. **Source Inputs:** The Grand Concerto will accept up to six audio sources. These are connected to the Grand Concerto amplifier with standard stereo RCA cables.
4. **Speaker Output:** Six of the Grand Concerto's eight zones are amplified. These outputs accept 16-gage, two-conductor speaker wire and provide 40 watts per channel of power.
5. **Source Link:** This connection is used in conjunction with the Grand Concerto Expander System to create 16 total zones. The source link cable is supplied with the Expander System.
6. **Source Status Inputs:** These inputs are currently inactive on the Grand Concerto. They are intended for future use.
7. **Zone Trigger Outputs:** These 12-volt outputs can be used to trigger an external device, such as an auxiliary power amplifier, for use in a specific zone.
8. **IR Emitter Outputs:** IR signals received from the keypads are passed through the IR outputs to the source equipment using the supplied IR emitters. Outputs 1-6 are routed to the corresponding sources, and the SUM outputs 1 and 2 are common and will pass all IR signals.
9. **SYS. ON:** This is a constant 12-volt output for turning on external equipment. There is no voltage output when the zones are off.
10. **EXT. MUTE:** This input is designed to temporarily mute any audio playing through the system when the doorbell or phone rings. This works in conjunction with the NuVō NV-MI1 mute interface accessory. It also acts as a trigger for whole-house paging through a phone system when set for this function in the Configurator Software.
11. **Network Input:** This RJ45 connection is the input for all zone information coming from the Grand Concerto Control Pads. The connection is made using the Network Cable supplied with the package.
12. **Digital Link:** This connection is used in conjunction with the Grand Concerto Expander System to create 16 total zones. The Digital Link cable is supplied with the Expander System.
13. **RS232:** The bidirectional RS232 is a serial communication port that allows the Grand Concerto System to be controlled by an external home automation device. It is also used for configuration and programming purposes.
14. **AC:** A detachable power cord connects the system to an external AC power supply.



## NV-I8GCP 2.7" OLED Control Pad

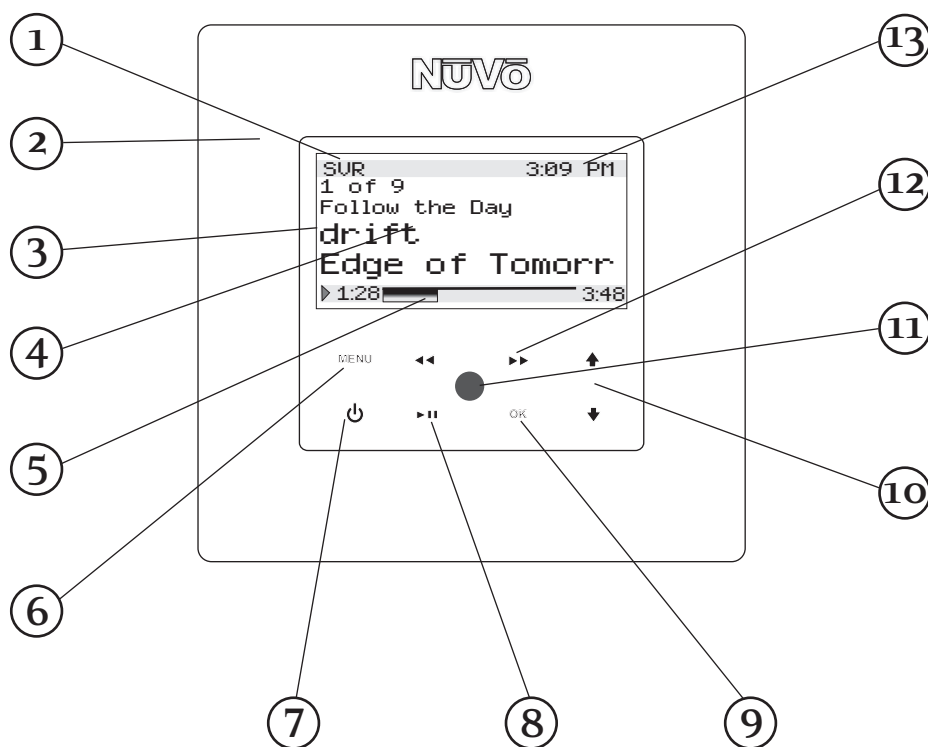

1. **Source indicator:** This indicates the current audio source playing in that zone. Source names can be customized in the Configurator Software with a 3 character designation.
2. **Cover plate:** Each Control Pad comes with white, ivory, almond, and black trim plates that attach magnetically to the face of the Control Pad. Additional styles of trim plates are available from NuVo.
3. **OLED Display:** The organic light emitting diode display is a highly functional eight line display.
4. **Now Playing/Menu Display:** This portion of the display serves two functions. In normal operation, it indicates the artist, station, metadata, and other source information. In Menu mode it uses a smaller font to display multiple lines of lines of information for browsing purposes.
5. **Volume Level Indicator:** This bar graph indicates both the audio volume level when the Control Pad is in normal play mode and the playback status of digital music files from the Music Port or NuVoDock for iPod.
6. **Menu:** Menu serves as access to music browsing, presets, and favorites, as well as specific zone setting parameters.
7. **Power:** This button turns the local zone on and off and turns all zones off simultaneously.
8. **Play/ Pause:** This IR programmable button toggles between the play and pause functions of the chosen source. When using the T2 Tuners, this button toggles through the Tuners receive modes. A third "press and hold" function can also be assigned to this button.
9. **OK:** The OK button also serves a dual function. In normal play mode, it scrolls through the available audio sources. In menu mode, it is used to select the highlighted menu item.
10. **Arrow Up and Down:** These arrows have a dual function. In normal play mode, they control volume level up and down. In menu mode, they scroll up and down through menu selections.
11. **IR Receiver:** The Control Pad has a built-in IR receiver for complete wireless control of all the audio source equipment.
12. **Forward/Reverse:** This is an IR programmable button for simple source transport. Typically it would track forward or back or tune up and down. A third "press and hold" function can also be assigned to this button.
13. **Time:** A feature of the Grand Concerto System is the ability to display the current time on each of the Control Pads.

## NV-E6GCP 1" OLED Control Pad

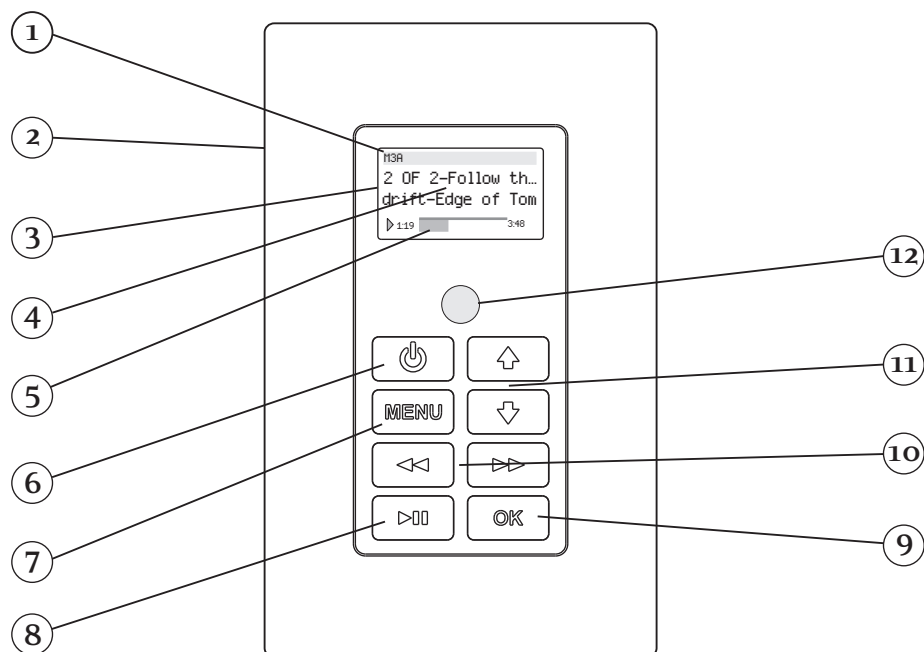

1. **Source Indicator:** This indicates the current audio source playing in that zone. Source names can be customized in the Configurator Software with a three-character designation.
2. **Wall Plate:** Each Control Pad comes with white, ivory, almond, and black trim plates that offer a screwless and elegant finished installation.
3. **OLED Display:** The organic light emitting diode display is a highly functional and vivid multi-line display.
4. **Now Playing/Menu Display:** This portion of the display serves two functions: In normal operation, it indicates the artist, station, metadata, and other source information, and in Menu mode, it displays multiple lines of information for browsing purposes.
5. **Volume Level Indicator:** This bar graph indicates the audio volume level when the Control Pad is in normal play mode. When in Menu Mode, it indicates the playback status of digital music files from the Music Port or NuVoDock for iPod.
6. **Power:** This button turns the local zone on and off and has the ability to turn all zones off simultaneously.
7. **Menu:** Menu serves as access to music browsing, presets, and favorites, as well as specific zone and system setting parameters.
8. **Play/Pause:** This IR programmable button toggles between the play and pause functions of the chosen source. When using the T2 Tuners, this button toggles through the Tuner's receive modes. A third "press and hold" function can also be assigned to this button for additional functionality.
9. **OK:** The OK button serves a dual function. In normal play mode, it scrolls through the available audio sources. In Menu mode, it is used to select the highlighted menu item.
10. **Forward/Reverse:** This is an IR programmable button for simple source transport functions. Typically, it would track forward and back or tune up and down. A third "press and hold" function can also be assigned to this button for additional functionality.
11. **Arrow Up and Down:** These arrows have a dual function. In normal play mode, they control the volume level up and down. In Menu mode, they scroll up and down through menu selections.
12. **IR Receiver:** The Control Pad has a built-in IR receiver for complete wireless control of all audio source equipment.

## NV-CTP36 Color Touch Pad

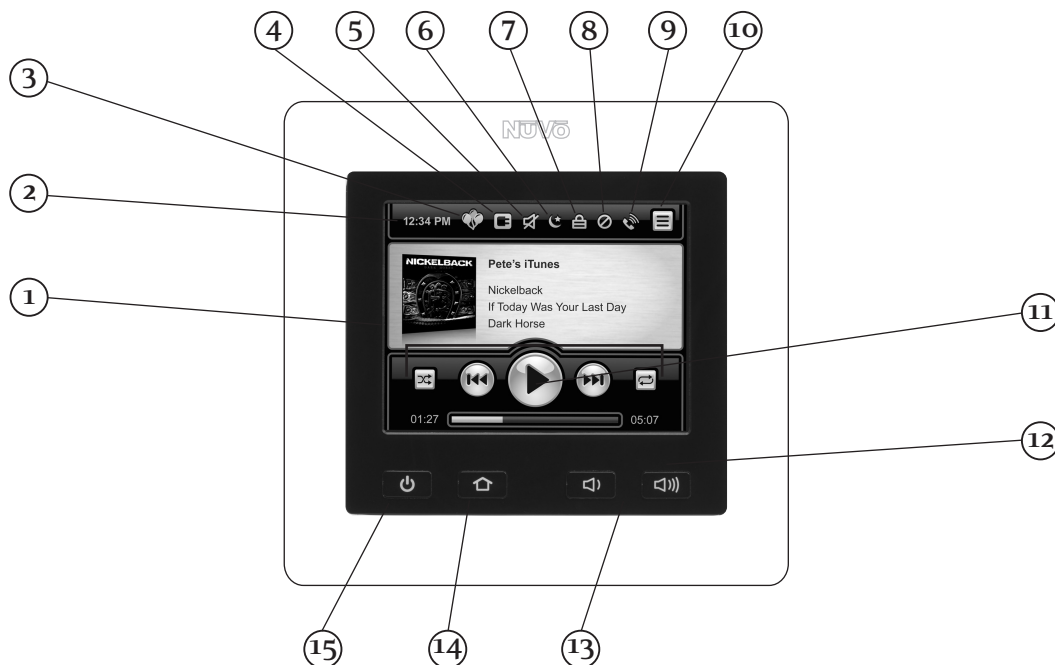

1. **Source Display:** This displays crucial information about the selected source, such as artist, album, track, title, frequency or station, and metadata for AM/FM and Satellite radio. Album art is also displayed when used with the Music Port source. When in menu mode, the menu control choices are displayed.
2. **Current Time:** A time display is distributed to all the zones in the System by NuVoNet. This is set when a configuration is downloaded to the System or it can be set in the System Menu.
3. **Party Mode:** This indicator will light when the system is in party mode (all zones turned on and operated from one Control Pad).
4. **Exclusive Source:** When this icon is lit, Exclusive Source is turned on. Exclusive Source locks out source control from other zones of the chosen source.
5. **Mute:** This icon will light when the zone is temporarily muted.
6. **Sleep:** This icon indicates that the zone is in "Sleep" mode, which is the ability to set an audio source to play for a specified amount of time.
7. **Lock:** This indicates that the zone is locked. In this state, a four-digit security code is required to unlock the zone's control features.
8. **Do Not Disturb:** This icon indicates that the zone is set for "Do Not Disturb". There are three Do Not Disturb choices; exclude the zone from Party Mode, Page Mode, and/or System Mute.
9. **Page:** This icon will light when the system is triggered to go into "Page Mode".
10. **Menu Button:** Menu serves as access to music browsing, presets, and favorites, as well as allowing access to specific zone and system control operations.
11. **Transport Functions:** These function buttons represent basic source control. They change in functionality with the chosen audio source.
12. **Playback Status/Volume Level Indicator:** This bar graph indicates the playback status of digital music files from music playback source devices such as the Music Port or NuVoDocks for iPod. The same bar graph display temporarily supports volume level display whenever a volume adjustment is being made.
13. **Volume Up and Down Buttons:** These buttons increase or decrease the zone's volume.
14. **Home Button:** This button returns the user to the Home screen (the view shown here).
15. **Power Button:** This button turns power to the zone on and off. When pushed and held it will turn off all of the zones in the system.

## NV-WCPS Wireless Control Pad

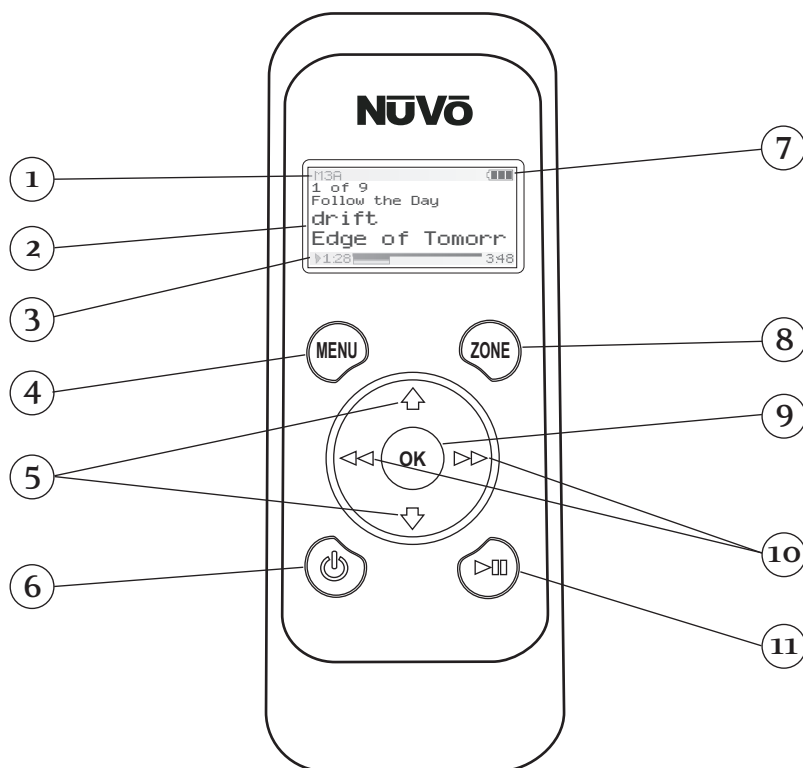

1. **Selected Source:** A three character abbreviation of the selected source appears in this portion of the Wireless Control Pad display.
2. **OLED Display:** The display is multi-line OLED (Organic Light Emitting Diode). It shows album, artist and track for personal music, and channel and frequency information for broadcast music. In menu mode, the display goes to eight lines of text.
3. **Playback Status/Volume Level Indicator:** This bar graph indicates the playback status of digital music files from music playback source devices such as the Music Port, or NuVoDocks for iPod. The same bar graph display temporarily supports volume level display whenever a volume adjustment is being made.
4. **Menu:** Menu serves as access to music browsing, presets, and favorites, as well as allowing access to specific zone and system control operations.
5. **Up and Down Arrows:** These are used to scroll up and down through the menus and control volume Up and Down in normal play mode.
6. **Power:** This button turns the local zone on and off, or turns all zones off simultaneously.
7. **Battery Display:** This indicates the current battery charge level.
8. **Zone Button:** When this button is pushed, a list of available listening zones is listed on the display. The user can change zone control by moving the highlight to the desired zone and pressing the OK button.
9. **OK:** The OK button serves a dual function. In normal play mode, it sequences through the available audio sources. In Menu mode, it is used to select the highlighted menu item.
10. **Forward and Back Arrows:** In NuVoNet communication, these buttons will track forward and back or tune up and down. For third-party sources, these are IR programmable buttons for simple source transport functions. An additional "press and hold" command can also be assigned to this button for additional functionality (IR commands can only be assigned to buttons in the Essentia Configurator software).
11. **Play/Pause:** This IR programmable button toggles between the play and pause functions of the chosen source. When controlling the T2 Tuners, this button toggles through the Tuner's receive modes. A third "press and hold" function can also be assigned to this button for additional functionality.

## NV-GRC1 Remote Control

1. **Power:** Each zone can be turned on and off, or all zones can be turned off with this button.
2. **Volume:** This serves two functions. In normal operation mode, it is a volume control, but when you are using the menu features of the Control Pad, it allows scrolling up and down.
3. **Function Buttons:** These buttons are currently inactive and designed for future use.
4. **Forward and Reverse:** These IR programmable buttons are designed for forward and reverse functions.
5. **Favorites:** A function of the Grand Concerto System is the ability to access user defined favorites for easy access. The first twelve are directly accessible using the RC1 Favorites buttons.
6. **DISP:** This button allows access to the Display dim menu available at each Control Pad.
7. **Function LED:** This LED (Light Emitting Diode) lights to indicate a button push.
8. **MUTE:** The RC1 remote provides a discrete mute function to quickly silence the zone's output.
9. **SOURCE/OK:** This is another dual function button. In normal playback mode it scrolls through the sources, or in menu mode it selects a highlighted menu choice.
10. **Play/Pause:** This IR programmable button toggles between the play and pause functions of the chosen source. When using the T2G Tuners, this button toggles through the Tuner's receive modes.
11. **MENU:** This button enters the menu features of the Control Pad. When in Menu mode the Volume up and down buttons scroll through the menu choices.
12. **Sleep:** This allows access to the sleep timer mode.
13. **G1 and G2:** These buttons are currently inactive.

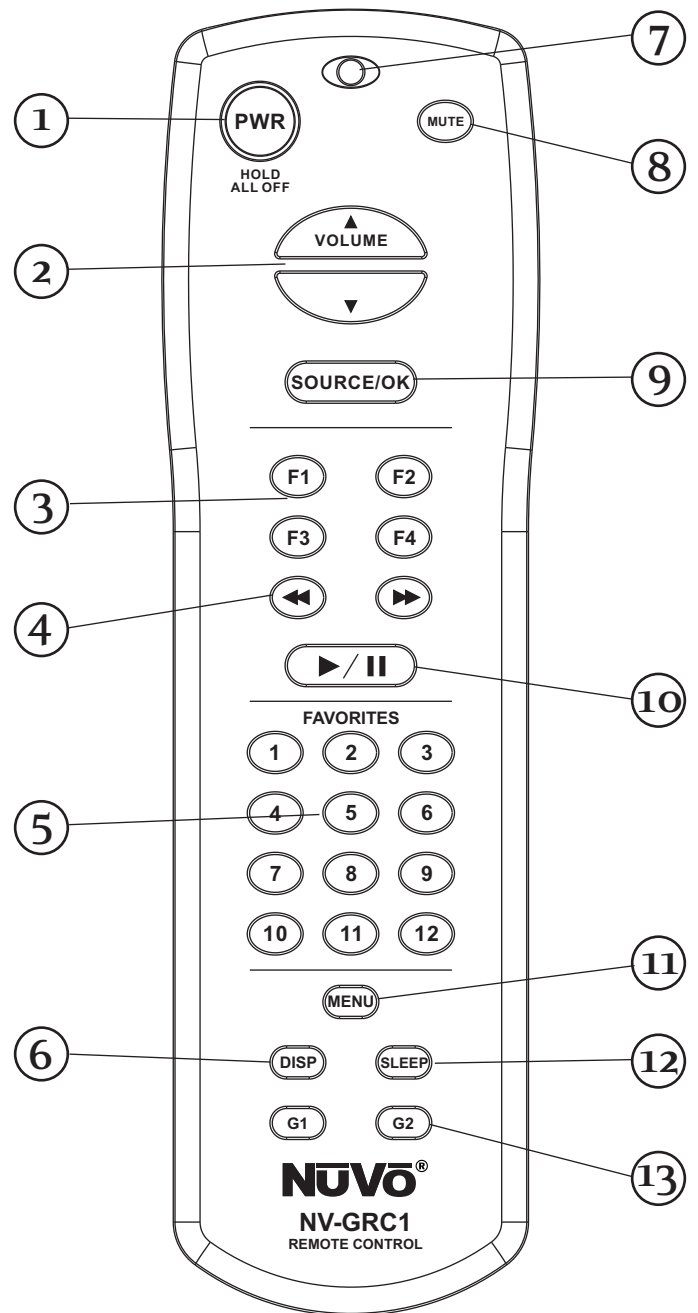

## Installing the Grand Concerto System in Your Home

### I. CAT5 Termination

The Grand Concerto System uses CAT5 cable for Control Pad control and either two or four-conductor 16-gauge speaker wire. All the wire is "homerun" from each zone to the location of the Grand Concerto amplifier and Audio Source equipment.

#### Complete CAT5 Crimping Instructions

The NuVo audio systems require CAT5, unshielded, twisted pair (UTP) for communication between the Control Pads and the main amplifier unit. Each end of the wire is terminated with an RJ45 connector.

The Grand Concerto System can accommodate 2,000 total feet of CAT5 cable. For the most reliable operation, it is best that no single run of CAT5 exceeds 250 feet.

The correct wiring scheme for the CAT5 cable is standard EIA/TIA 568A. Properly terminating the CAT5 cable is crucial for the operation of the system. It is very important to use a good quality crimp tool, and test each end to end run with a CAT5 wire tester to insure that your system operates flawlessly, Fig.1.

#### Step-by-Step Crimping Instructions:

- Strip a 2 to 3 inch portion of the insulation, exposing the 4 twisted pairs.
- Untwist the wires and fan them out individually. Arrange the wires into the correct color scheme as shown in Fig. 1.
- Flatten the wires in their correct order and trim them evenly across the top. Most crimp tools have a wire trimmer built-in. It is best to trim the wires to about 1/2" in length.
- While holding the wires flat between your thumb and forefinger, insert the wires into the RJ45 connector so each is in its own slot. Push the wire into the RJ45 so all 8 conductors touch the end of the connector. The insulation jacket should extend beyond the crimp point of the RJ45.
- Insert the RJ45 into the crimp tool receptacle and squeeze the tool firmly. Note that a ratchet type tool should tighten down until it no longer clicks.
- The RJ45 should be firmly crimped to the CAT5 insulation. It is necessary that the color scheme be repeated identically on each end of the wire.
- Test each termination with a CAT5 Tester before completing the installation.

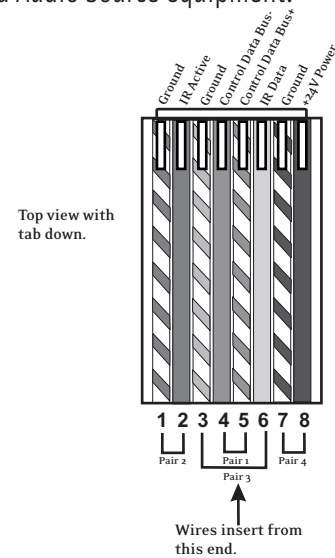
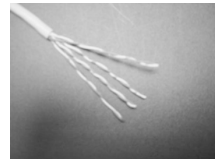

Fig. 1: EIA 568A wiring scheme for CAT5 Cable Pin #

1. Green Stripe
2. Green
3. Orange Stripe
4. Blue
5. Blue Stripe
6. Orange
7. Brown Stripe
8. Brown

Note: Colors listed as "stripe" are a white wire with a colored stripe.

Step 1



Step 2

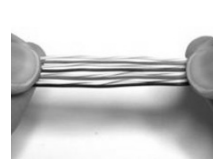

Step 3



Step 4

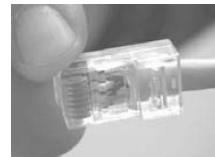

Step 5



Step 6

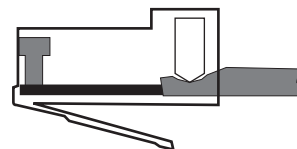

## II. Terminating the Speaker Wire (Fig. 2)

All the NuVo systems operate across a “homerun” wiring scheme using CAT5 for the zone Control Pad control communication, and a separate run of speaker wire for each zone from the speaker outputs to the zone speakers. We suggest 16 AWG 2 or 4-conductor speaker wires.

The speaker wire termination is done using a modular “Euro” connector. Each conductor is screwed down to the connector block and plugged into the appropriate speaker output on the back of the amplifier. The proper termination is Left channel: – and +; Right channel: – and +.

## III. Installing the Grand Concerto Amplifier

System setup works best when the amplifier is placed in the same location as the audio source equipment. This is typically in an audio rack, entertainment center, or a closet dedicated to housing the home audio/video equipment.

The amplifier should be plugged in and the power button on the front panel should be engaged before proceeding with the rest of the installation. This activates the internal protective circuitry of the Grand Concerto System.

## IV. Installing the NV-18GEZP EZ Port (Fig.3)

The EZ Port is a multi-connection hub designed to accept all the CAT5 wires from the controllers in the system. The location of the EZ Port should be determined by the location of the Grand Concerto amplifier. It is best to place in a wall behind the amplifier that would be easily accessible if necessary.

The EZ Port fits easily in most dual-gang size, low-voltage ring with an open back. These are often referred to as “mud rings”. Simply plug the terminated CAT5 wires into any of the 20 available jacks on the back of the EZ Port. The order in which the individual CAT5 wires are plugged in is not important, although it is strongly recommended that you label the CAT5 with the appropriate zone number for future reference. An accessory, NV-RM3U is useful for mounting the EZ Port in a rack.

Once you have plugged the CAT5 wires into the EZ Port, screw the EZ port into its construction bracket using the supplied mounting screws.

Fig. 2

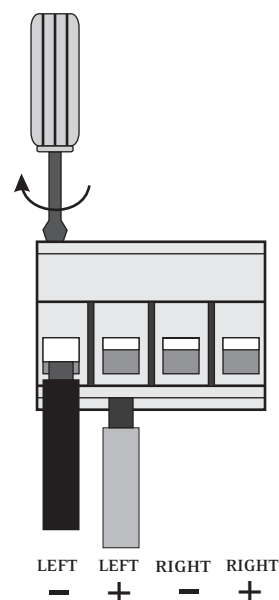
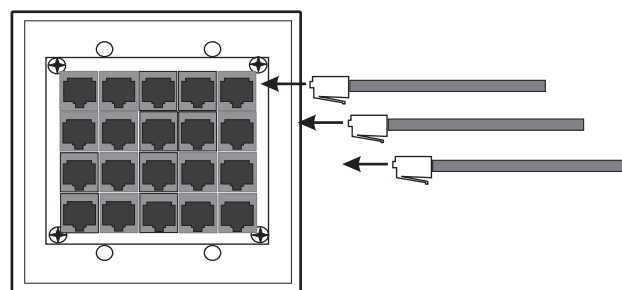

Fig. 3



## V. Connecting the EZ Port to the Grand Concerto Amplifier (Fig. 4)

When the EZ Port is installed, the only part visible should be the faceplate and seven RJ45 ports. The supplied pre-terminated network cable should then be plugged into the port labeled "Connect to NV-18GM" and into the "Network" connection on the back of the Grand Concerto Amplifier. Any CAT5 cable terminated using 568A or 568B network wiring will suffice should you need a longer connection. Remember, it is important to terminate the cable the same way on both ends.

Fig. 4

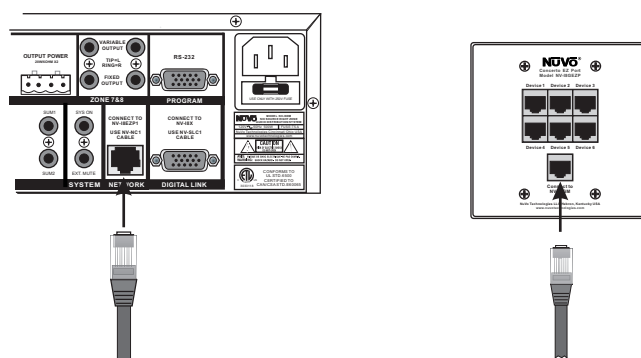

## VI. Attaching Audio Source Equipment (Fig. 5)

Each piece of audio equipment is connected to the Grand Concerto amplifier with standard stereo RCA cables. Attach an RCA cable to the corresponding audio output on the source equipment and to the desired source input on the back of the Grand Concerto amplifier. The numbered input for each source is important in the configuration of the system. This will be covered in detail in the Grand Concerto Configurator portion of this manual.

Fig. 5

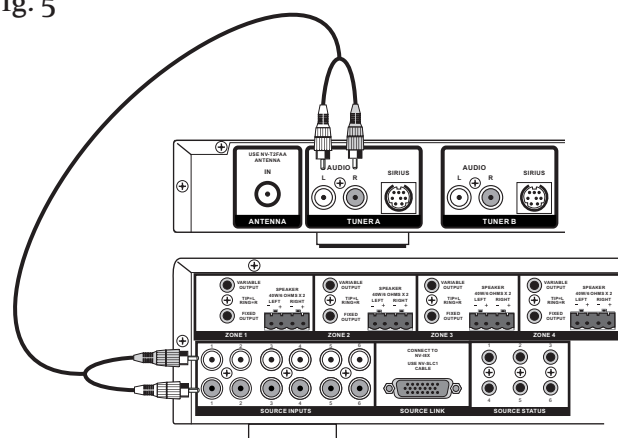

### Setting up the NuVo Sources for use with NuVoNet

A feature of the Grand Concerto System is its ability to automatically communicate with the T2 Tuners, Music Port and, and the NuVoDocks for iPod. The communication happens through the EZ Port connection hub, across a communication protocol called NuVoNet. Although software programming is not necessary for this function, configuring the installation through the Configurator Software prior to installation has distinct advantages and is highly recommended, see **IX. Grand Concerto Configurator Software**, pg. 11.

### T2 Tuners (Fig. 6)

When each model of the T2 Tuners are plugged in for the first time, the initial display, **Uninitialized State Detected (Press OK)** will appear. When the **OK** button is touched, the Tuner will prompt a regional tuning selection. It will then go to **Tuner A, Standalone, Source 1, Source 2, Source 3, Source 4, Source 5, and Source 6**. Stand Alone is automatically highlighted at initial startup.

Use the arrows to scroll to the appropriate source number. When the selection is made, the T2 will go to the same selection for Tuner B. When each output selection is complete, the Grand Concerto System NuVoNet will recognize that source.

**Please note that the Source selections will not be selectable until the appropriate audio connections are made between the T2 and the Grand Concerto amplifier.**



## Music Port MPS4 and MPS4-E

The Music Port and Music Port Elite source components use the IP connection to the home's network router for the source address selection. The Music Port Remote Config utility is accessed through an internet browser by entering the Music Port's IP address followed by /config, ie. 192.168.1.189/config. The Remote Config will open and a "Source Address" tab allows you to set the source number for each of the four Music Port audio outputs. These selections are saved to the Music Port's flash memory and when its NuVoNet output is connected to the EZ Port, the attached Grand Concerto System will recognize the Music Port sources.

## NuVoDock for iPod

Both the wired and wireless NuVoDocks for iPod use a simple rotary switch to set the appropriate source input. Up to two wireless NuVoDocks and 6 wired NuVoDocks can be used as individual sources through NuVoNet. The wired and wireless NuVoDocks consist of the dock for iPod playback and recharging and a receiver component designed to communicate with NuVoNet. Prior to plugging the receiver into the Grand Concerto EZ Port, set the Source rotary switch to the desired source number input. Once set, the Grand Concerto Control Pads will automatically display the iPod information when an iPod is plugged into the NuVoDock. Each NuVoDock and receiver must have a separate source number selected.

**Note that although the NuVoDock system has a 16 position rotary switch for source input, only positions 1-6 are used.**

## VII. Connecting the IR Emitters for Third-Party Source Components (Fig. 6)

IR commands for the source equipment are transferred from the Grand Concerto amplifier to the source equipment using the mini IR mouse emitters. Six of these are supplied with the Grand Concerto System. The emitter is plugged into the corresponding source IR output on the Grand Concerto and then placed over the IR receiver window on the source component. The IR outputs are individually routed to sources 1-6.

The SUM1 and SUM2 outputs will flash any IR command that is sent from any of the zones. This is most commonly used with an IR blaster designed to flash IR commands to a variety of components.

Fig. 6

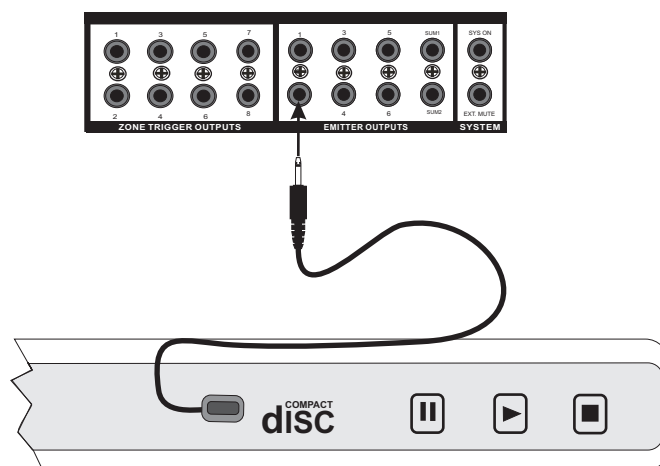

## NuVo T2G Tuner Direct Numeric Access (Fig. 7)

The NuVo T2G Tuners have the ability for direct IR access to numeric station tuning. This can be done through the T2G remote control or using a third party remote control that has been taught the T2G IR codes. To allow this control, it is necessary to link one of the Grand Concerto SUM IR outputs to the Direct IR input on the T2G using a stereo 3.5mm (1/8") mono patch cable. Once the connection is made, the T2G will respond to the numeric IR commands issued through the Grand Concerto Control Pad IR receivers.

Fig. 7

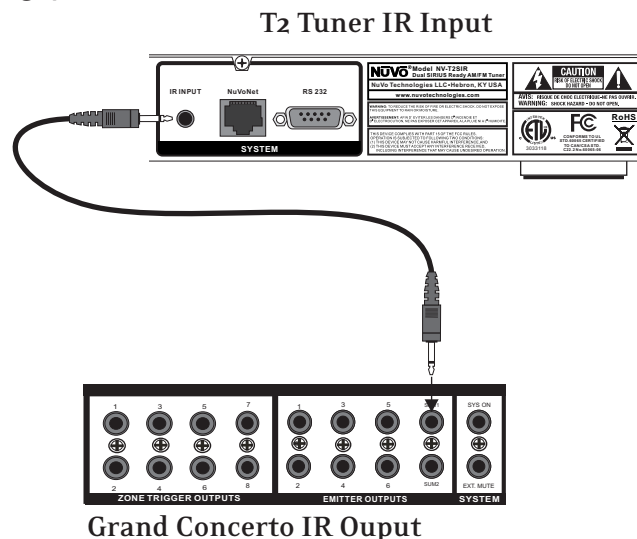

## VIII. Expanding Grand Concerto to 16 Zones (Fig. 8)

Eight additional listening zones can be added to the Grand Concerto System using the Grand Concerto Expander package. The expansion is easily done using the Source Link and Digital Link multi-pin outputs on the Grand Concerto main amplifier (NV-18DMS).

The necessary cables for this are supplied with the Expander package. No other connections are necessary except the AC power cord and the additional speaker terminations. The additional CAT5 wires for zones 9-16 plug into the Grand Concerto EZ Port.

Fig. 8

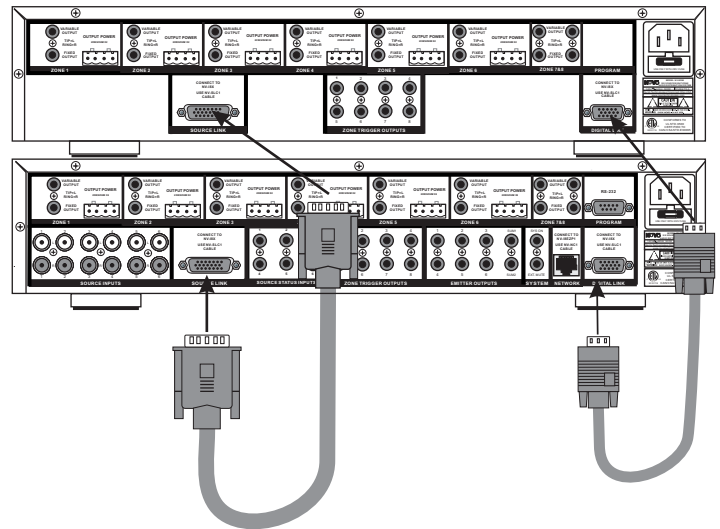

## IX. Using the Grand Concerto Configurator Software

The following section includes the optional NV-18DLS IR Learning Station. This is available as a package from NuVo Technologies or any Authorized NuVo Distributor. The Configurator Software is a PC program downloaded from the NuVo website Dealer Resource Center. Access to the Dealer Resource Center requires a NuVo issued login.

### 1. Main Startup (Fig. 9)

The Configurator is a tabbed Wizard-style interface designed to sequentially walk the installer through the system setup. When the program is launched, the Start tab is highlighted. This gives three choices for beginning a configuration. You can create a new file, open an existing file, or retrieve an existing file from a configured Grand Concerto System. Once configured, the finished program loaded into the Grand Concerto main amplifier can always be retrieved via the RS232 port and edited.

Once a configuration file has been opened, you can then click on the next button to continue. The Configurator will not let you continue beyond Start without either creating a new file or opening an existing file. It will also prevent moving forward through any of the tabs until the necessary information is completed in any one of the tabs.

Fig. 9

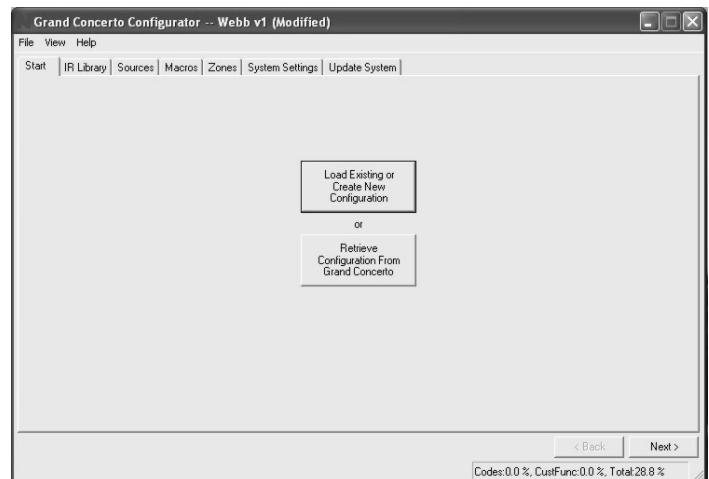

## 1.1 Open or Create Grand Concerto Configurator File (fig. 10)

When you click on this button, the program goes to a Config. File. There you can either open one of the existing configurations or specify the name of a new file. Configurations are saved with a .cfg extension.

## 1.2 Retrieve Configuration from Grand Concerto

To retrieve a configuration from an existing Grand Concerto installation, launch the Configurator Software. Make sure your computer is connected to the RS232 port on the back panel of the Grand Concerto amplifier. The Startup screen has two buttons. The first is used to open an existing configuration or to create a new one. The second asks to "Retrieve Existing Configuration From Grand Concerto." When you click on the "Retrieve" button, a progress window will appear.

If you have this configuration already stored on your computer's hard drive, you will see a dialog box asking if you wish to overwrite the existing file. If this file is not stored in your computer, this box will not appear.

Fig. 10

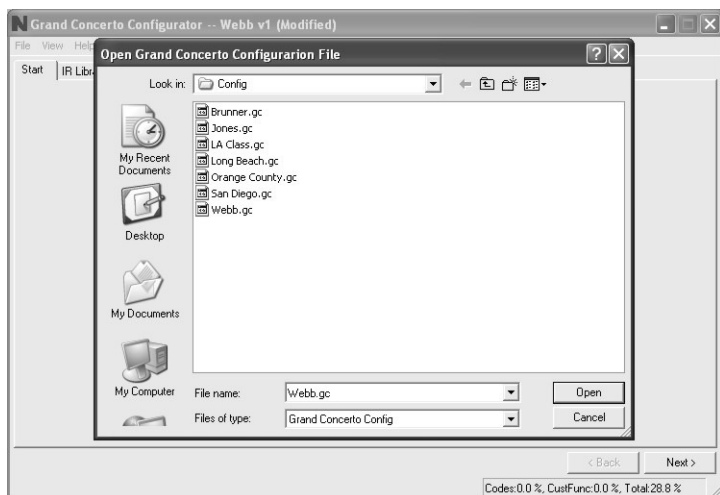

## 2. IR Libraries (Fig. 11)

The IR Library is a list of available components and their IR function codes. The Configurator Software stores captured IR codes in a single directory. Once captured or downloaded, the Configurator Software will permanently store it as an .irc file.

Fig. 11

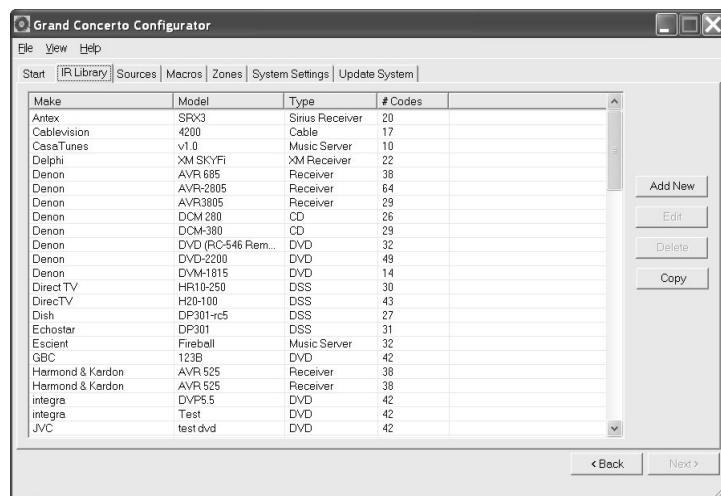

## 2.1 Adding a New Component to the IR Library (Fig. 12)

New component IR files are easily added by clicking on the Add New button. This brings up a new window titled Add New Component. In this window, you must first enter the manufacturer name and model. The Type drop-down menu contains a large list of components. Each is a template of common functions for that type of equipment. Clicking on the type that matches the component will add the type name in that field. If desired, you can add a type name that is not in the drop-down menu.

Clicking on OK will automatically add the selected component and associated functions to the IR Library.

Fig. 12

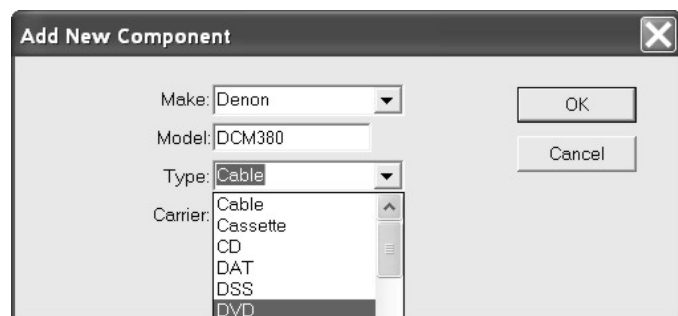

## Using the IR Learning Station Interface (Fig. 13)

To record new IR codes, you will need the IR Learning Station Interface. The IR Learning Station Interface is a powerful tool for setting up new IR Libraries for use with the Configurator Software, and is part of the IR Learning Station Package. Capturing function codes and adding them to the component IR Library is an easy process.

The Interface box is connected to your computer using one of the RS232 connection cables provided with the IR Learning Station package. Note that in many cases, personal notebook computers do not have a Db9 serial cable. In this case an RS232 to USB dongle cable will be necessary.

The back panel of the Interface box has two IR outputs for testing purposes. You can use the included IR emitter and attach it to the IR window on the face of the source component or to the built-in IR blaster, which, when aimed at the source equipment, will fire the IR command.

## 2.2 Recording IR codes (Fig. 14)

When a new component is added to the IR Library, it is necessary to record the IR codes associated with each function. To do this, connect the Learning Station Interface as described above. Double-click on the desired component from the IR Library page. This will open the IR Library Editor. This window lists the complete set of functions for that type of device.

To initiate the IR recording process, you can either double-click on a function to be recorded or highlight the function and click on the Record button. This will open the IR Library Record window. The window will indicate that the Configurator is "Waiting for IR Communications." To record a new code, simply point the component's remote control at the IR receiver on the NuVo IR Learning Station Interface. The first time you enter a code, the Configurator determines if it is a "toggling function," which means that the remote sends two commands back-to-back. This requires that the function button be pressed four times in succession.

Fig. 13

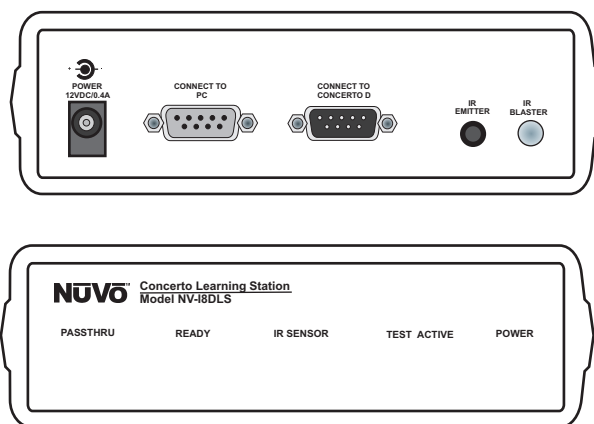

When the remote code is entered, the IR Library Record window will go from yellow to green and indicate that the capture was successful, and it will then return to yellow. Repeat this procedure three more times until the desired code is added to the IR Library Edit window. You will now see the number of code repeats and the duration of the code. A normal non-toggling remote will require two button pushes to successfully record a command, while a toggling remote will require four button pushes for each command.

If there is an error in recording the code, the display in the Record window will indicate that there was a communication error. If this occurs, click on the Record button and reenter the code.

Fig. 14

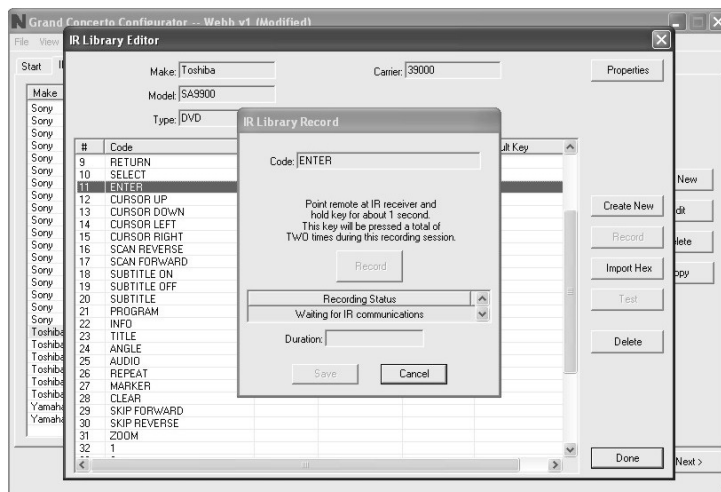

## 2.3 IR Library Default Key Assignment (Fig. 15)

Once the desired codes are added, assign them to the appropriate key on the Control Pad. Note that by design, the Control Pad has only 3 IR programmable function keys and Power ON/Power Off. Access to multiple preset choices will be covered later in the Macros section.

To assign default IR functions to the Control Pad buttons, right-click on each code and select "Keys." This opens a drop-down menu of the possible key selections for the Grand Concerto Control Pad. Select the appropriate key for that command and the Configurator will add it to the Default Key field for that command. The Play/Pause, Prev. and Next functions have an additional (Held) function. This allows an additional function assignment that is activated when the button is held. The Control Pad automatically displays the function being sent to the source component.

Once this sequence is completed, proceed to the next function command, and repeat the above steps. When you have assigned a default key for each IR, click on "Done" and that component's IR Library is complete.

You can also assign discrete power on and off commands. The Grand Concerto System will initiate the On command when a zone is turned on and in turn initiate the Off command when the zone All Off function (holding the Power button for three seconds) is initiated from any of the Control Pads.

Fig. 15

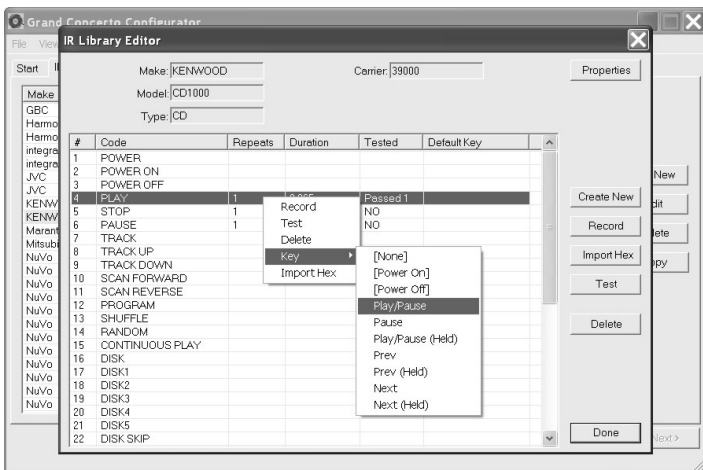

## 2.4 IR Library Test (Fig. 16)

An important feature of the Grand Concerto Configurator is the ability to test each IR code as it is added to the IR Library. This insures that every code will work reliably.

When a new code is added, while it is still highlighted, click on the test button, or double click on the highlighted code. This will open the IR Library Test window. Make sure that the IR Learning Interface box's IR emitter is either facing the IR receiver window of the source equipment or an IR emitter is plugged into one of the two IR emitter outputs and affixed to the IR receiver window of the source equipment. Clicking on the test button will cause the IR Learning interface to emit the code. The source equipment should respond appropriately to the command if it has been stored correctly. A test result box will open where you can record yes or no to the test. Three successful test results are required before the "Passed" count turns green. Clicking the "OK" button will save the results in the IR Library. The "Tested" column for that command will show the number of successful tests performed.

***Although not required, testing each code is highly recommended.***

Fig. 16

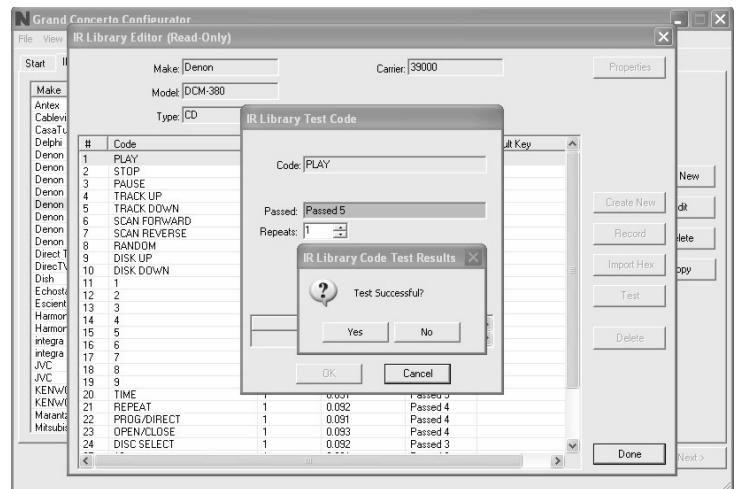

## 2.5 Adding a Function Code (Fig. 17)

If a required IR function is not in the list of those provided in the library template, it is possible to add a code to the list by clicking the "Create New" button. The pull-down menu contains a list of all standard IR codes. A name not found in the list can be typed in, but it is recommended that you use the names provided in the list. This conserves memory in the Grand Concerto. Clicking on the "OK" button proceeds directly to the IR recording process.

Fig. 17

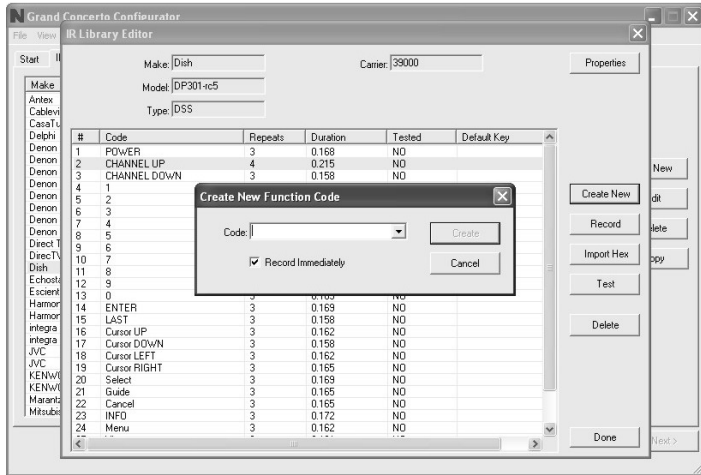

## 2.6 Cleaning Up an IR Library

Unused IR codes can be deleted from the list by highlighting the code and either clicking the "Delete" button or right-clicking and selecting "Delete."

When you are finished editing the library, select "Done."

## 3. Defining Sources

The "Sources" tab allows you to define the source component attached to each of the six source inputs. All six sources are not needed, but at least one source must be defined.

## 3.1 Select or Edit Source (Fig. 18)

Double-clicking on a blank source will open the "Select Source" window. This window assigns the appropriate source number input. The "Display Name" is the text that will be read on the Control Pad when that source is selected in any zone. The display name can contain only capital letters, numbers, and some punctuation. If an invalid key is typed, it will be ignored.

The "Make" field defines the manufacturer of the equipment. A drop-down menu allows you to choose a source from the IR Library. The "Model" field provides a drop-down menu that allows you to choose the specific piece of source equipment from the selected manufacturer.

An important feature of the "Select Source" window is the "Gain" level control. Different pieces of source equipment tend to have different levels of audio output signal. This slider control allows you to compensate for equipment that has an inherently lower volume level. By using this adjustment, when switching between sources, relative volume levels remain constant.

When the appropriate information has been completed, click "OK." This will add the updated source information to the "Source" window. When all the desired sources have been defined, go to "Next" and proceed to the "Macros" setup.

Fig. 18

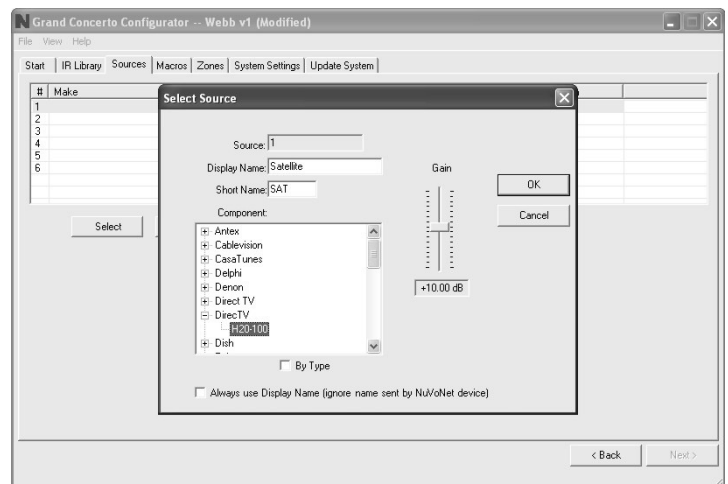

## Adding a NuVoNet Source (Fig. 19)

NuVoNet sources can be placed in the Configuration with the same procedure as third party IR controllable equipment. The Configurator program contains libraries for each of the NuVoNet components which have the appropriate button functions preassigned. Even though the components are assigned, you must still set the NuVoNet source inputs on each of the components, see **Setting Up the T2G Tuners, Music Port, and NuVoDock for iPod**, pg. 9.

Fig. 19

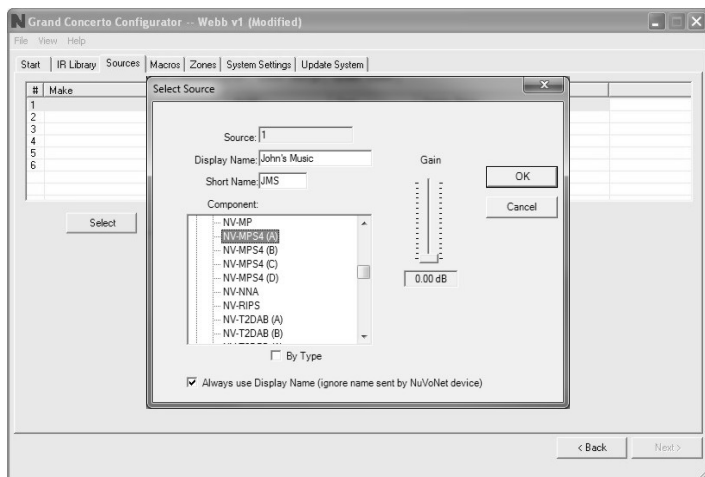

## 4. Macros (Fig. 20)

An important feature of the Configurator program is the ability to define source specific macro definitions for third party IR control. The Grand Concerto has a unique ability to store specific IR commands as preset names. The best example is cable or satellite. Using the Macro tab you can establish a preset name and set the appropriate IR commands to select a specific station (this will be covered in the **4.1 Edit Macro Definition** section). Macro definition only applies to third party non-NuVoNet sources.

Fig. 20

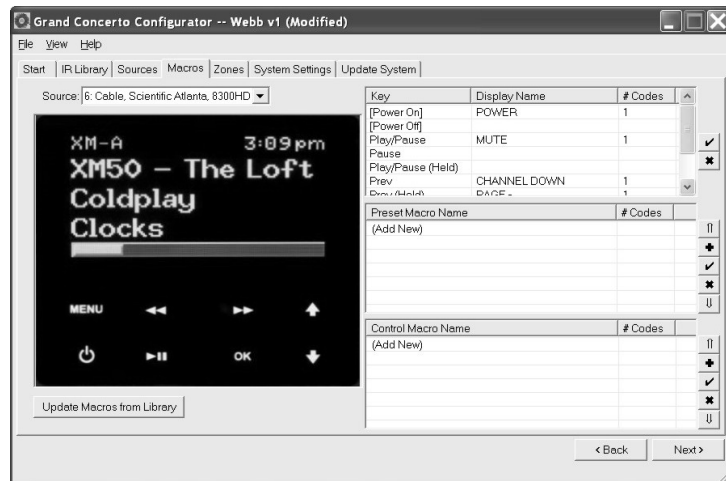

### 4.1 Edit Macro Definition (Fig. 21)

The Macro tab has a Source pull down menu that displays the six sources defined in their order 1-6. When a non-NuVoNet source is highlighted and selected, three separate points of definition appear on the right side of the screen. The left side of the screen is a representation of the Control Pad display. When the cursor is scrolled over the buttons on the Control Pad, a tool tip appears indicating the function command or commands that have been assigned to that button. Here you can double click on the button which opens the Macro Definition Window. When in Macro Definition, if you choose to, you can reassign new codes. You can also double click on the appropriate function in the window on the right side of the tab and access the Macro Definition window.

Fig. 21

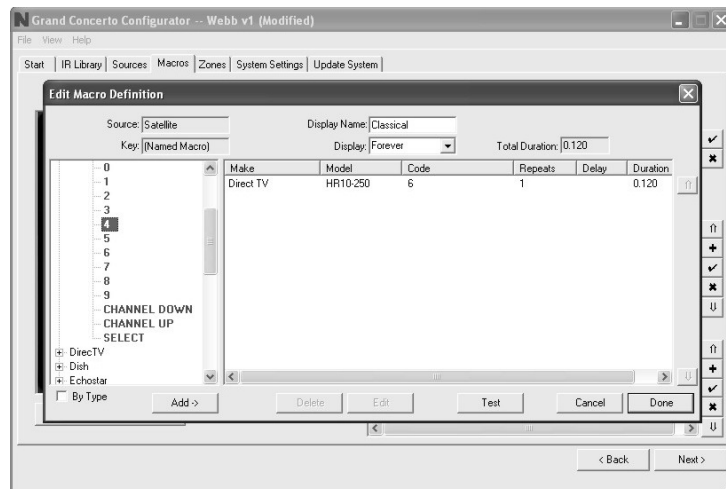

If the component had default keys defined in the IR Library, single IR code macros will be automatically created for each key. Hovering the mouse over each key in the Control Pad picture on the left side of the screen will bring up a tool-tip displaying the name of the macro assigned to that key. Clicking on the key highlights the macro on the right side of the screen. Double-clicking on a key in either display will allow you to change the default assignment or create a new one in the Edit Macro Definitions window, Fig. 21

### 4.1.1 Creating a Macro Preset String (Fig. 22)

An important function of the Macro tab is to create a menu of preset choices for third party components, such as satellite, cable and CD changers. When a non-NuVoNet source is selected, a Preset Macro window appears on the right side of the screen with open spaces for storing preset station choices. Up to 250 macros can be defined in this window. When a preset is added to a source, an additional Preset menu item will be added to that source browsing capability on the Control Pads. The preset menu is preceded by the three character source designation established in the Source tab.

To create a preset macro, double click on the first available preset macro selection, Fig. 20. This will open the Edit Macro Definition window. Once in that window you must type a name for the preset in the Display Name window. That will establish the preset name as it will appear in the preset menu. Note that the Display drop down menu directly below the Display Name window defaults to Forever. This is the desired choice for a preset and will keep the preset name on the Control Pad while that selection is being listened to.

The available IR codes for that source will be expanded in green on the left side of the Edit Macro Definition window. As you double click on a code, it will automatically be added to the macro string on the right. Up to 255 codes can be added to a single macro and the codes will fire in the order in which they are added to the string. Once the desired macro string is complete, click done and return to the main macro tab. The completed macro will appear in the Preset Macro window. To create a second preset, double click on the next space and repeat the Macro Definition steps.

Fig. 22



### 4.1.2 Editing Codes in a Macro (Fig. 23)

When in the Edit Macro Definition window, double-clicking on a macro step on the right side will open an "Edit Macro Code Settings" window. This allows you to change the delay time before the command is issued. The default delay is .25 seconds. This can be increased by .25-second increments up to 30.5 seconds. Often a command requires mechanical movement in the source equipment and, therefore, the delay is important before initiating the next command.

The number of repeats for each command can also be changed. This is equivalent to pushing and holding the button on the remote control.

Fig. 23

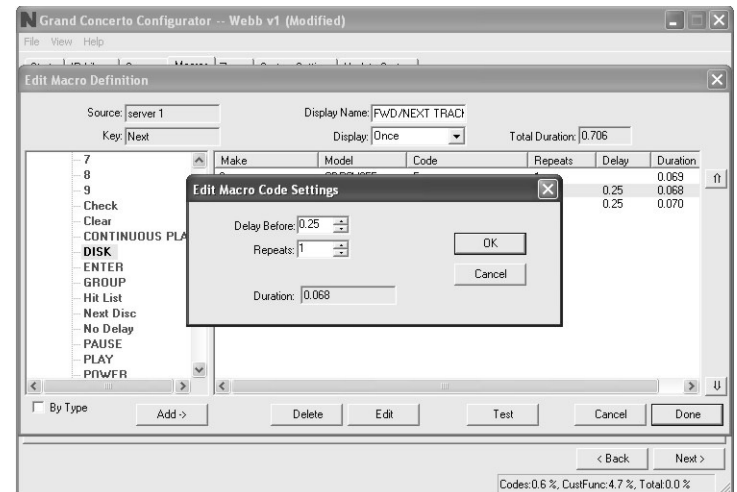



## Re-Ordering Macro Codes

After a code is added to a macro, highlighting a code and clicking on the ↑ or ↓ button will reorder the codes.

## Macros (updated)

After editing a macro, the macro list is updated to show the number of IR codes and the display name.

Note that the Macro tab has an additional button at the bottom that says "Update Macros From Library." If codes were edited in any way in an IR library after a source has been defined in the Source tab, this button will automatically pull those changes into the Macro Definition window.

### 4.1.3 Control Macros

An additional option within the Macro tab is the ability to establish multiple control macros. These macros are intended for instant access to control functions and are an optional feature. If a control macro is created, an additional source menu item is also created titled "Control" preceded by the three character "short name" assigned in the Source tab.

Creating a control macro is the same process outlined in **4.1.1 Creating a Preset Macro String** on page 17.

## 5. Zones (Fig. 24)

Up to 20 zones can be defined with the Grand Concerto. Each zone can be defined with unique properties.

You will notice that the zone tab contains 20 entries for zone Control Pads. The system can accommodate a total of 20 Control Pads by using the slave function in the "Edit Zone Properties" window. A slave Control Pad is homerun to the EZ Port, but automatically shares the same functions and works in tandem with the main zone Control Pad. Up to three slave Control Pads can operate on a single zone.

Fig. 24

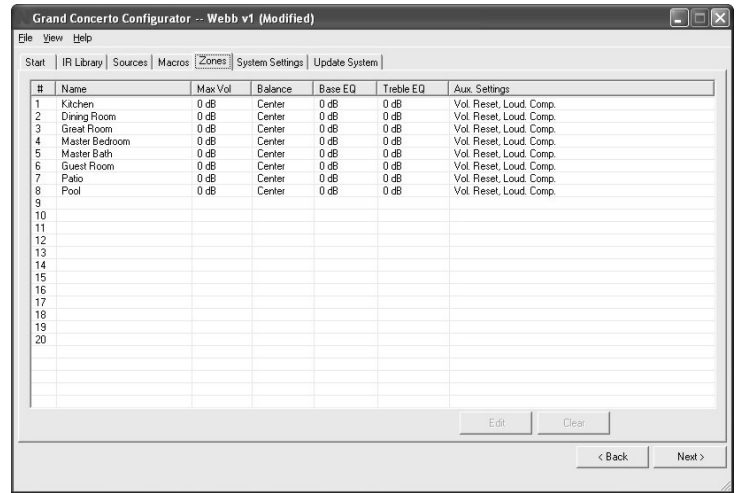

### 5.1 Edit Zone Properties (Fig. 25)

Double-clicking on a zone number opens the "Edit Zone Properties" window. Specific properties defining that zone are set here.

Fig. 25

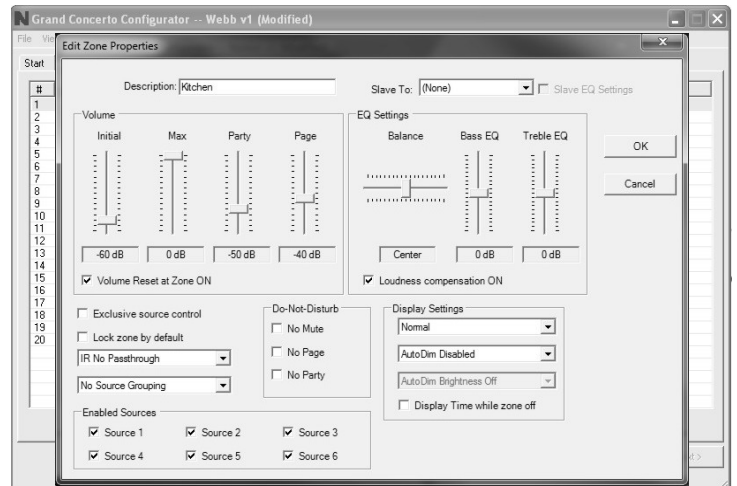

**Max Volume:** This allows the volume in a zone to be limited. This can be done either to avoid damage to low-power speakers or simply to prevent a certain room from being turned up too high (e.g., a teenager's bedroom).

**Party Volume:** This controls the reset volume level for each zone when the All On/Party Mode is initiated from any of the Control Pads. The range is -78dB to -30dB.

**Page Volume:** If you are using the paging feature of the Grand Concerto System, you can also set the specific volume level of the page zone by zone, by using this volume control. The range is -78dB to -30dB, with a default at -40dB.

**Balance:** The level of output to the left and right speakers is adjusted here. The default is center, but depending on the location of the speakers and the optimal listening area of the room, it may be advantageous to adjust the balance to either the left or the right.

**Bass and Treble:** Both bass and treble can be adjusted individually on a zone by zone basis. The EQ sweep is -18dB to +18dB. Keep in mind that these levels can also be set at the zone Control Pads with music playing. This will be covered later in the Control Pad menus.

**Volume Reset at Zone ON:** A zone-specific feature is the ability to have a zone automatically reset to a low volume level when the zone is turned on. This check box initiates that feature and is tied to the Zone Reset Volume level set above it. If this box is not checked, the zone will turn on at the last volume level.

**Loudness Compensation ON:** This box defaults to checked and enables an automatic bass and treble boost when the zone is at a low listening level. This EQ gradually flattens out as the zone volume is increased. Unchecking the box turns this function off.

**Exclusive Source Control:** Checking this box gives this zone exclusive "do not disturb" control of any chosen source. Other zones will have the ability to listen to that source, but they will not have any specific function control.

**IR Pass-through:** Each zone Control Pad has an IR receiver for wireless remote control. By its nature, IR is susceptible to external interference. To account for this, there is specific IR pass-through settings for each Control Pad. **IR Disabled** turns off the IR receiver completely and eliminates any possibility of a competing light source. This is useful in an environment in which the Control Pad receiver is competing with overwhelming sunlight. This will prevent IR communication throughout the system and therefore, it is better to eliminate that light source. **IR No Pass-through** prevents third-party remote control commands from being accepted, but still allows the NuVo NV-GRC1 remote control to operate the system. In some zones this is necessary when a third-party remote is often used to control a non-NuVo System source such as a TV. This would eliminate that remote control's commands from being received by the Control Pad and passed through to the source equipment.

**Source Grouping:** This allows for one zone to automatically listen to the same source as all other zones in the group. This is a very useful feature for a large open area where it is not practical for more than one source to be playing at one time. The advantage of the zone group is that each Control Pad within the group has the ability to turn on or off, mute, and control volume independently. This drop-down menu allows any zone to be assigned to a group, or as an individual zone with no group affiliation. Up to four distinct groups can be created.

**Lock Zone By Default:** This check box turns on a function that automatically prevents any functionality from the zone until the assigned security code is entered. Primarily, the function prevents an outside zone from being turned on except when the homeowner really wants to listen to it.

**Display Time While Zone Off:** Checking this box causes the Control Pad to automatically display the current time when the zone is turned off. In normal operation the time is always displayed in the upper right corner. The time is automatically set according to the computer when the configuration is downloaded to the Grand concerto.

**Do-Not-Disturb:** This Section is used to lock out system-wide commands from a specific zone.

**No Mute:** The Grand Concerto System has a small accessory called the Mi1, Mute Interrupt which is designed to mute all zones when the phone or doorbell rings. This is defeated on a zone by zone basis by checking the No Mute box.

**No Page:** The Grand Concerto System is capable of paging through audio source input 6. This involves a phone system that has a paging audio output and a means to provide a voltage trigger. This is controlled using the System Settings tab to set the voltage trigger and utilizing the Mute Interrupt, see Mute Interface page, 31. Setting the system's Mute input for paging or the Mi1 mute function is covered in the next tab.

**No Party:** Master and Party Mode refer to the ability to turn all zones on simultaneously. In some zones you may not want this function.

**Enabled Zone Sources:** These allow individual sources to be turned off for specific zones. A source that is turned off will not display in that zone. This is particularly useful in preventing child access to a source dedicated to adult listening.

**Display Settings:** The overall brightness and AutoDim feature for each Control Pad are set using these drop-down menus. The first menu is the display brightness. The choices are **Dimmest, Dim, Not So Bright, Normal, Bright, Brighter, Brightest**. The second menu sets the duration for the AutoDim feature. These range from **AutoDim Disabled, 15 Sec up to 1 Hour**. The next menu sets a specific **AutoDim level**. **AutoDim Brightness Off removes all display and backlighting**. Using **AutoDim Brightness Low, AutoDim Brightness Medium, or AutoDim Brightness High** reduces the level of brightness, but does not make the Control Pad completely dark.

**Slave To:** This drop-down menu is used to assign additional "slave" Control Pads to a zone. Up to 20 Control Pads can be used in an installation. The EZ Port hub is equipped with 20 RJ45 ports to accommodate all the system's Control Pads. This is a useful feature for large rooms where more than one Control Pad is desired. If slave Control Pads are used, we suggest that you disable the IR pass-through on those to prevent cross-communication. The Slave To function can also be used to tie two or more zones together under the control of a single Control Pad.

## 5.2 Zones (updated) (Fig. 26)

When the desired properties for each zone are set, click on OK. This will return you to the Zones tab. There you will see an updated list of the zones by the number they are assigned, as well as the specific parameters defined in the Zone Edit window.

Double-clicking on the zones will reopen the edit window, where any of the definition properties can be modified.

Fig. 26

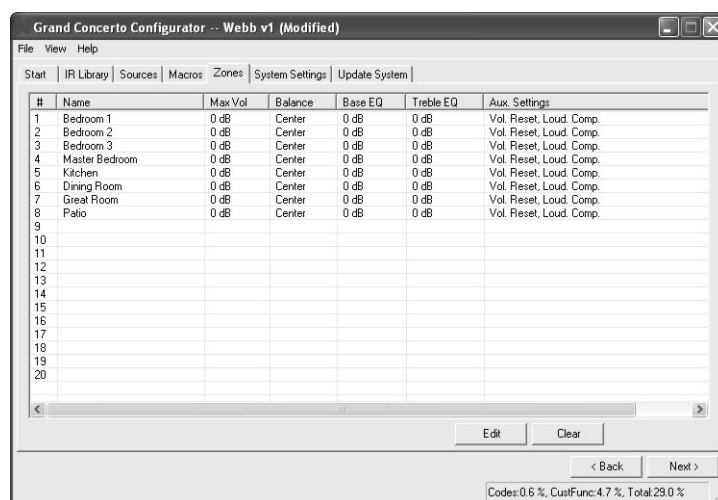

## 6. System Settings

This tab is used to define the way in which the External Mute input functions, for setting the zone lockout security code, set the clock for 24 hour display and if necessary to set a serial communication display.

### 6.1 External Mute: System Mute Trigger (Fig. 27)

The Grand Concerto System has an accessory, the NV-MI1 Mute Interface, which is designed to mute any music playing through the system when a doorbell or phone rings, see MI1 Mute Interface. When setting the System Mute Trigger, set the mute input to respond to the contact closure provided by the MI1.

Fig. 27

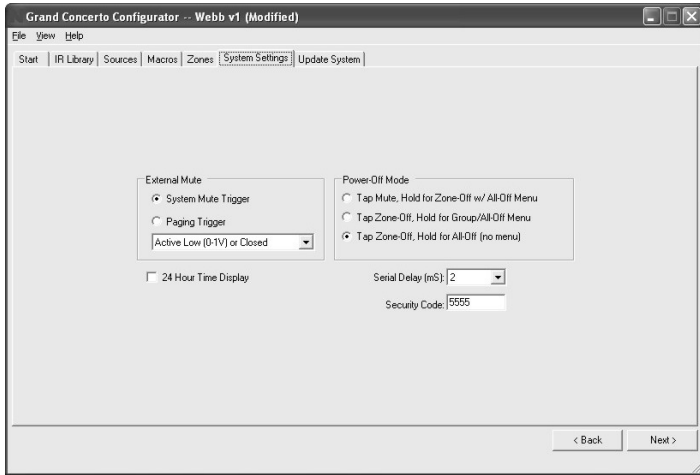

## 6.2 External Mute: Paging Trigger (Fig. 28)

The Grand Concerto System has a built-in solution for whole-house paging typically through a phone system. The Paging Trigger setting causes the system to mute across all the zones, and in turn, amplifies the page across all zones. Each Zone Edit utility in the Configurator Software or the menu at each Control Pad offers the capability of setting the page volume in each zone.

Fig. 28

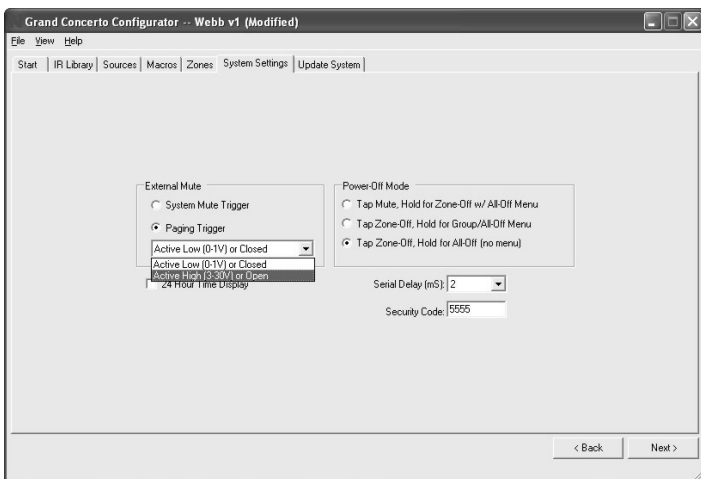

## 6.3 24 Hour Time Display and Power Off Mode

**24 Hour Time Display:** By checking the 24 Hour Time Display box the system will automatically go to a 24 hour clock on each of the zone Control Pads.

**Power Off Mode:** The Grand Concerto Configurator allows the option for three power off modes.

**Tap Mute/Hold for Zone-Off w/ All-Off Menu:** This mode causes a temporary zone mute when the Control Pad power button is tapped. When it is held a second menu will appear with the options to turn the zone off or turn all the zones off.

**Tap Zone-Off/Hold for Group/All-Off Menu:** In this mode a single tap of the power button turns the zone off and holding the power button causes a second menu that gives the option to turn off that zone's group or turn all the zones off.

**Tap Zone-Off/Hold for All-Off (no menu):** This is the default choice. In this mode, a tap turns the zone off and holding the power button turns all the zones off.

## 6.4 Serial Delay (Fig. 29)

This drop down menu provides a choice of delays measured in milliseconds. This is only necessary when you are using the RS232 communication for third party control of the Grand Concerto System. This utility slows the rate at which information is delivered to the home automation system from the Grand Concerto. This is sometimes necessary to allow the home automation's processor time to buffer the incoming information.

Fig. 29

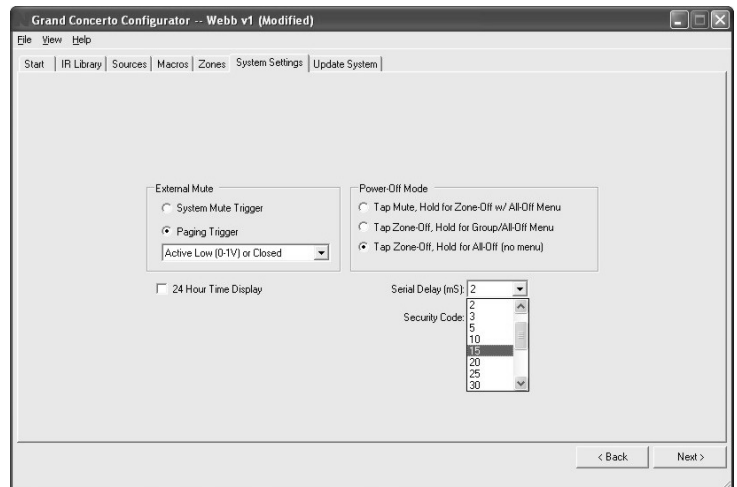

## 6.5 Security Code (Fig. 30)

A feature with the zone setup of the Grand Concerto System is the ability to lock the zone. This can be done as a default that will require a four-digit security code to unlock the zone Control Pad when the zone is turned on, or it can be done as a temporary setting from the Control Pad menu to lock the zone on its current listening choice. In either scenario, the security code must be set to unlock the zone. The security code can be any four digits or left at the default 5555.

Fig. 30

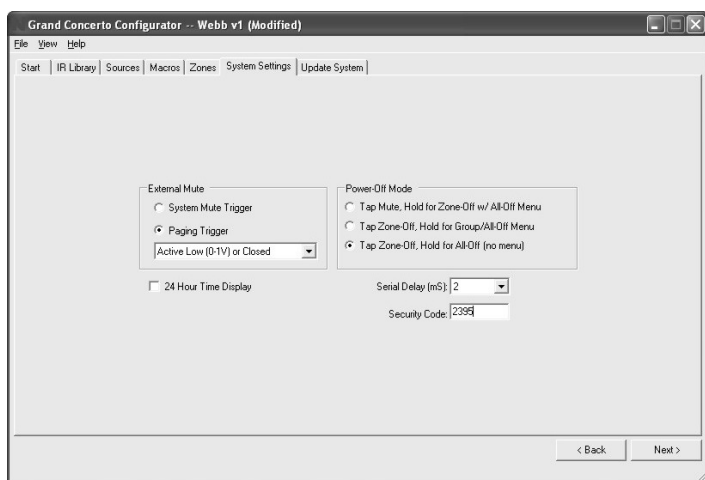

## 7. Update System (Fig. 31)

The finished configuration is now ready to be downloaded to the Grand Concerto amplifier. While downloading, a progress box will show download progress. Once complete, the configuration is permanently stored in flash memory. Configurations can always be retrieved and edited at a future date.

### Control Pad Firmware Update (Fig. 31a)

When first plugged in and addressed, the Control Pads will poll the main unit for the correct firmware version. If they are at a lesser version number, an upgrade notice will appear on the display. It is important to allow this process to complete. When the Control Pad is finished upgrading itself it will turn off. At that point, it is ready for zone control use.

Fig. 31



Fig. 31a

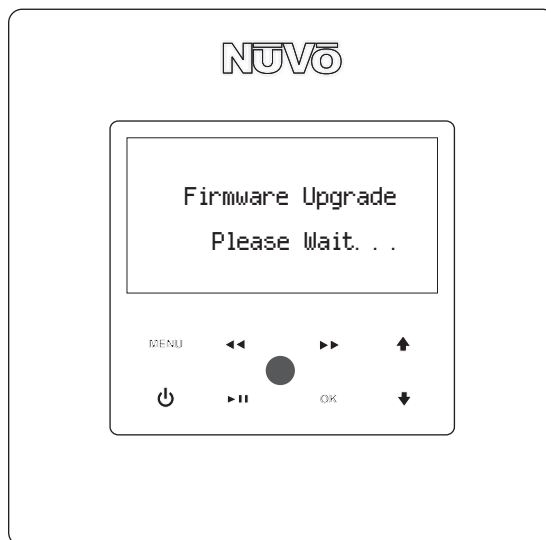

## X. Control Pad Setup

### Factory-new Installation

The system should be programmed with the Configurator prior to setting up the Control Pads for the first time. The Grand Concerto amplifier should be placed in its permanent location, plugged in, and turned on. When a Control Pad is plugged in for the first time, the following sequence will occur:

1. When first plugged in, **Grand Concerto V. X.XX** where X refers to the current firmware version number loaded in the Grand Concerto main amplifier unit. The Control Pad will then go to the **Zone Selection** menu.
2. While the Control Pad is in the **Zone Selection** mode, all the configured zone names will appear starting with the first. Setting the appropriate zone address is simply done by using the arrow buttons to scroll up or down to the appropriate zone and when the desired zone is highlighted, press the **OK** button.
3. The Control Pad will flash the version-number screen one more time and immediately turn off. When powered on, the addressed Control Pad will then go to the first established source.

At this point, the zone may be operated by the parameters set in the configuration. Zone settings may be modified using the MENU key.

### Reprogramming the Zone Address

This procedure allows an addressed Control Pad to be moved to a new location. Within the main menu of each zone, go to **Setup**. Within the Setup options, scroll to **Advanced Settings** and to **Zone Number**. All the used addresses will be grayed out. Any available addresses will be accessible. Scrolling to **None** will erase the current address of that Control Pad's zone. In this menu selection, the Control Pad can be reset to any available zone.

## XI. Using the Control Pad's MENU Button

Menu gives access to specific music selection and control for each source, as well as zone and system setting capability. When the MENU button is pushed, the display goes to an eight-line screen labeled Main Menu.

**MAIN MENU:** There are four Main Menu items that are consistent to all source selections and pertain to general system and zone control. They are **Favorites**, **Sources**, **Advanced Zone Control** and **Setup**, Fig. 32.

Fig. 32

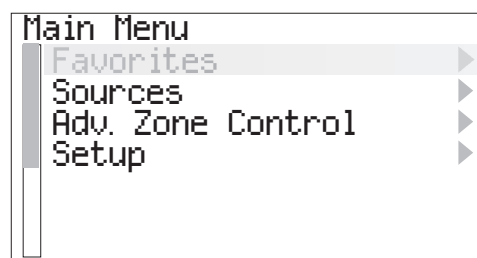

**Favorites:** Top-line favorites are global. Favorites or play lists set up within Windows Media Player and synced with the NuVo M3 Server or within an iPod can be added to the Favorites list. Potential members of this list can also include station presets for the NuVo T2G or other sources such as satellite or cable. When T2G or IR Macro Presets are assigned, the first twenty are placed in the Favorites menu. Assigning playlists within the Music Port or iPod to global favorites is done in the **Actions** menu, Fig. 33. This menu item automatically resides with the Music Port or iPod as a source choice. Once in the **Actions** menu, you will have the choice to add your selection to Favorites, Fig. 34.

Fig. 33

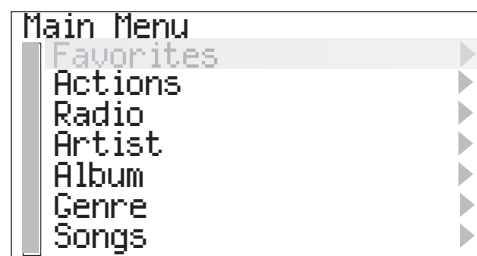
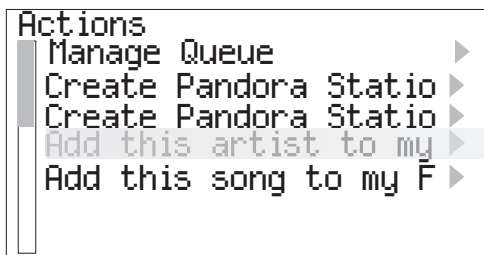
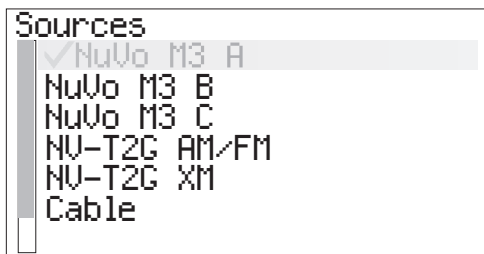

Fig. 34



**Sources:** This offers quick access to the six sources defined in the system. Third-party sources can be defined with a source name in the Grand Concerto Configurator Software, or they are labeled by the system as a generic source number. The NuVoNet sources have a predefined system name unless you choose to assign a customized name in the Configurator Software, fig. 356.

Fig. 35



**Advanced Zone Control:** Advanced Zone Control is designed for user access to temporary zone settings. Each of the zone parameters set in advanced zone control automatically reset when an All Off command is issued from a Control Pad, Fig. 36.

Fig. 36

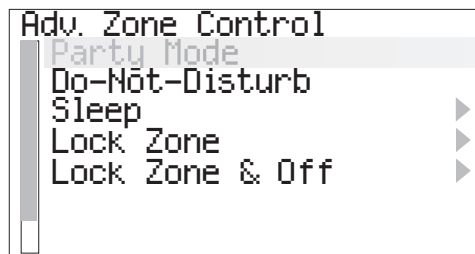

**Party Mode:** This setting is turned on and off with the OK button. When selected all the configured zones in the system will turn on and that Control Pad becomes the Host for the entire house. This function is defeated in an individual zone by initiating a function on that zone's Control Pad.

**Do-Not-Disturb:** This sets a temporary source lock on a chosen source within that zone. This selection is also turned on and off by pressing the OK button.

**Sleep Mode:** The Sleep Mode when set, allows music to play in that Control Pad's zone for a specified amount of time, Fig. 37. Once the time selection is made, the system will gradually ramp down in volume and the zone will turn itself off at the end of the selected time.

Fig. 37



**Lock Zone:** This temporarily locks the zone on the current source selection. It requires a four digit security code that must be set in the Settings Tab of the Configurator Software. The security code is entered on the Control Pad by using the up and down arrows to scroll to the first number and pressing OK. The display will then highlight the next number. Using the process described above, set the second, third and fourth numbers. Once the fourth number is set, the zone will remain locked until the security code is entered to unlock it, fig. 38.

**Lock Zone & Off:** This temporary lock works very much like Lock Zone, but is used to turn the zone off and requires the security code to turn the zone back on.

Fig. 38

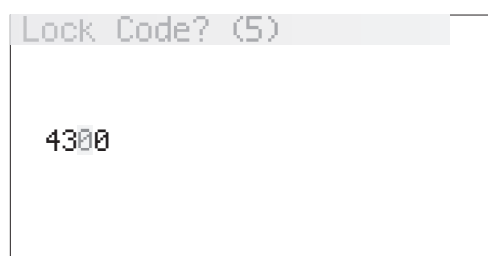

**Note that the security code is set in System Settings tab**

**Setup:** The Setup menu is for specific system setup. It consists of several subset menus, Fig. 39. These are defined in the next section.

Fig. 39

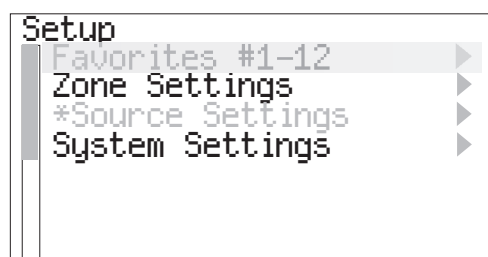

**Favorites #1-12:** Twelve global favorites can be defined for easy access from within the Main Menu or from the twelve numeric favorites from the Grand Concerto remote control. Any favorites, which include M3 and iPod play lists, tuner presets and specific disc selections can be selected in the Favorites setup and automatically added to the global list. The Grand Concerto Remote Control has a 12-button numeric Control Pad that provides direct access to the 12 assigned favorites. When a favorite is selected, the zone will automatically go to the appropriate source and music selection, Fig. 40.

Fig. 40

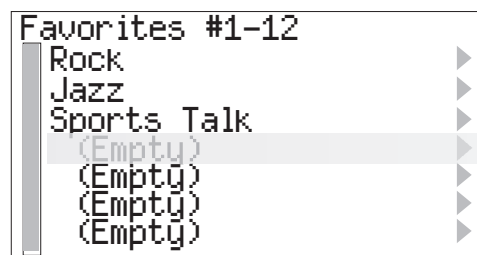

**Zone Settings:** This selection contains several zone specific controls, Fig. 41. Note that Advanced is grayed out and is preceded by an asterisk. This is an installer specific level that is accessed by holding the OK button for six seconds.

Fig. 41

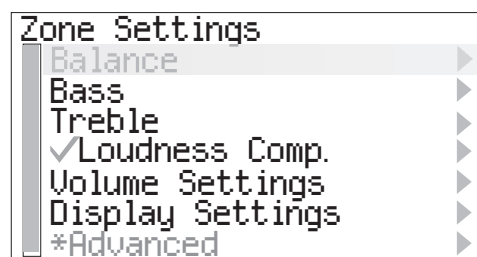



**Balance:** This controls the level of audio going to the left and right speakers. In some cases, when the listening area is not absolutely centered between the speakers, it is useful to adjust the center listening point left or right. This menu option gives the ability to adjust the sound left or right up to 18 steps in either direction.

**Bass:** This adjusts the frequency level from 100Hz and below. The default is flat, and the range is -18dB to +18dB.

**Treble:** This adjustment works within the same parameters as the bass and adjusts the frequency level from 10kHz and up.

**Loudness Compensation:** Loudness can be simply turned on or off by pressing the OK button.

**Volume Settings:** There are several default settings available in this menu. **Volume Reset** is turned on or off by pressing the OK button and controls whether the zone turns on at its previous volume level, or to a preset level, Fig. 42. If checked, the volume at zone on reverts to the level set in the next menu item, **Initial Volume**. Choosing to set at the current listening level, or selecting the default -60 dB level, controls this level.

**Maximum Volume** is an overall zone volume limit and is set in the same manner as Initial Volume. **Page Volume** controls the level at which a page is amplified in each zone, and **Party Volume** sets the initial volume level when the party or all-on function is initiated.

Fig. 42



**Advanced Zone Settings:** These are parameters for each zone. They can be easily established in the Configurator Software or here at each of the zone Control Pads, Fig 43.

Fig. 43

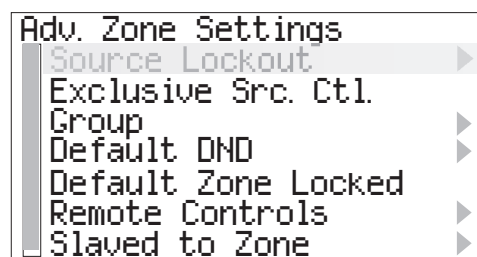

**Source Lockout:** Any source selected in this menu will be locked from access within that zone.

**Exclusive Src. Ctl.:** This sets a default that automatically grabs control of any source chosen within this zone. Other zones will be able to listen, but they will have no specific source control. This is a permanent zone setting.

**Group:** Source Group is a great NuVo feature for large, open-floor living spaces. In this menu option, any zone can be set to share source among a group of zones to prevent the likelihood of having more than one source playing in the same open space. The advantage to Source Group is that each zone area maintains individual on/off and volume capability.

**Default DND:** This prevents the global functions of all-on or party and whole-house page from a Control Pad's specific zone, Fig. 44.

Fig. 44

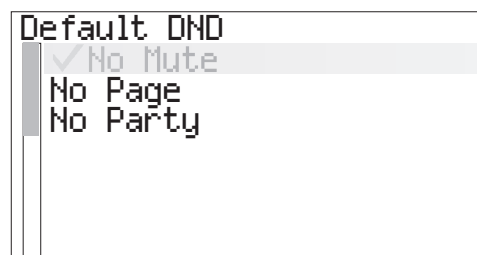

**Default Zone Locked:** A locked zone prevents anyone from turning the zone on and accessing music without first entering the security code.

**Remote Controls:** These settings affect the way the Control Pad receives commands from a handheld wireless remote. The NV-GRC1 is the system remote that comes with the Grand Concerto. It allows the same level of control as the Control Pad. At the default setting, **All Remotes Enabled**, this remote and any third-party IR remote will be received by the zone's Control Pad. In some instances, you may not want a third-party remote command to be received by the Control Pad. In this case, you would choose **NuVo Remote Only**. If the zone is in an area that is flooded with sunlight or receives interference from plasma displays, the best choice is **All Remotes Disabled**.

**Slaved to Zone:** A feature of Grand Concerto is the ability to slave zones together. This is most useful for controlling a zone with more than one Control Pad, or the converse, which is controlling more than one zone with one Control Pad. Simply scroll to the zone you wish to slave to and select it from the list, Fig. 45 .

Fig. 45

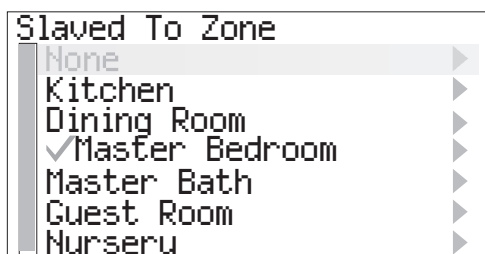

**Zone Number:** Each zone must be assigned a number or specific zone address. This is done by scrolling to the desired zone and selecting it. All used zone addresses will be grayed out. If you have defined zones in the Configurator Software, the actual zone names assigned in the Zone tab of the software will appear in the list. The zone list appears just as it does in the previous **Slaved Zone** menu. Scrolling to a different zone name and pressing OK will set a new zone address, or selecting NONE erases the zone address.

**Diagnostic Self Test:** This performs a short display parameter test when selected

**Source Settings:** Two choices reside in this menu, Fig. 46.

**Gain:** This lets you increase the audio input levels from the sources coming into the Grand Concerto. This is not necessary for the NuVoNet components, but if you use a satellite or cable set-top box as an audio source for the system, you will find that the audio level is inherently softer and will benefit by the gain setting. The default is 0dB, with a range up to 18.75dB.

**NuVoNet Source:** If you uncheck this selection, that source will not be polled by NuVoNet and will only be IR controllable.

Fig. 46

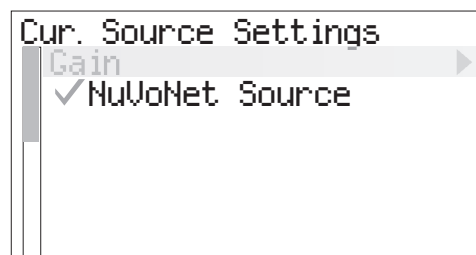

**System Settings:** This menu option controls system-wide settings, Fig 47.

Fig. 47

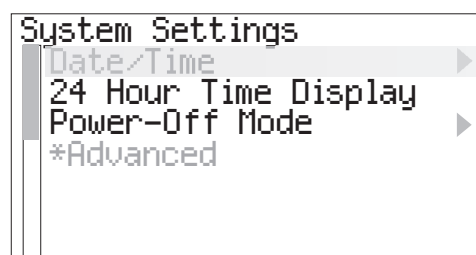

**Date/Time:** The Grand Concerto has an internal clock that allows each Control Pad to display the current time. Within this menu you can easily set **Year, Month, Day, Hour, and Minute.**

**24 Hour Time Display:** This is a simple on/off. When this menu item is turned on, the clock display on the Control Pads switches to 24 hour display.

**Power Off Mode:** This refers to three choices for the way in which each zone turns on and off. They involve a single tap of the power button and a hold function, Fig. 48.

**Mute/Off/ w/ Menu** is the first choice. This selection means that a tap of the power button mutes the zone, but does not turn it off. The hold function brings up a second menu that requests All Off, yes or no. No turns off just that zone, yes turns off all zones.

**Off/All-Off Menu:** In this mode, a tap of the power button turns the zone off and a second menu appears that gives to choice to turn off that zones group (if it is assigned to a source group) or to turn all zones off.

**Off/All-Off:** The is a tap of the power button to turn the zone off and a hold of the power button to turn all zones off.

Fig. 48

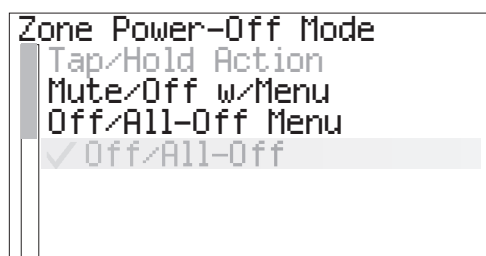

**Advanced:** Within the System settings menu are advanced functions intended for installers. The item is preceded by an asterisk and grayed which requires that the OK button is held for six seconds before the advanced functions are accessible, Fig. 49.

Fig. 49

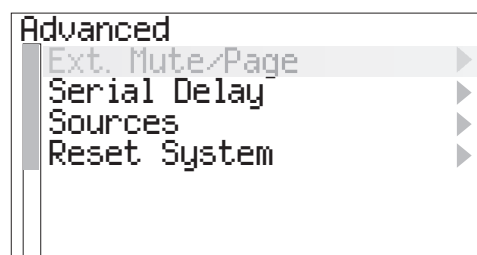

**External Mute/Page:** The EXT. MUTE input on the back panel of the Grand Concerto has a dual function. In normal mode, it is designed for the Mute Interface, NV-MI1 (see NV-MI1 Mute Interrupt Adaptor page, 31). It can also be configured for use with a paging phone system to enable whole-house paging. This requires a phone system that provides an audio output for paging that is plugged into source input 6 on the Grand Concerto (note that this feature eliminates the use of Source 6 as an audio source for the system). To use the Page function, you must select **Paging Mode**. There are two types of voltage triggers associated with the Page function. If the phone system you are using sends a voltage to trigger paging, selecting Paging Mode sets the mute input to react and mute all zones. If it triggers by creating a closure (dropping down to 0 voltage), you need to select **Active Low (Closed)**.

**Serial Delay:** This function is only used in conjunction with third party home automation systems. This function sets a delay in milliseconds between each of the function commands being streamed through the Grand Concerto RS232 port. This allows a slower home automation processor to buffer multiple commands from the Grand Concerto System.

**Sources:** This Allows unused source inputs to be turned off so they do not show up when you scroll through the sources at the Control Pads.

**Reset System:** This is a shortcut for resetting the zone addresses assigned to each Control Pad. Within the menu selection, **Yes** restores all Control Pads plugged into the system to the factory default.

## XII. Grand Concerto Accessories

### The NV-I8DLS IR Learning Station Interface

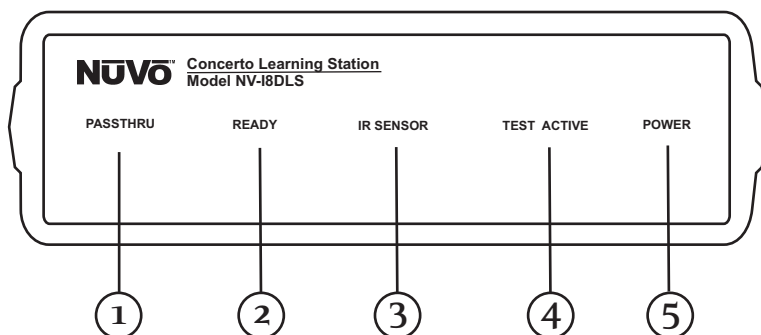

1. **PASSTHRU:** This LED (light emitting diode) remains lit when the Interface box is actively passing IR information through the system.
2. **READY:** When you are inputting IR codes into the Configurator using the Interface box, this LED will light when the system is ready to learn a new code.
3. **IR SENSOR:** This is the IR receiver used when capturing codes for new source equipment.
4. **TEST ACTIVE:** When you are testing an IR code, this LED lights momentarily when the code is actually firing.
5. **POWER:** This LED remains lit when the interface box is plugged into an AC electrical outlet.

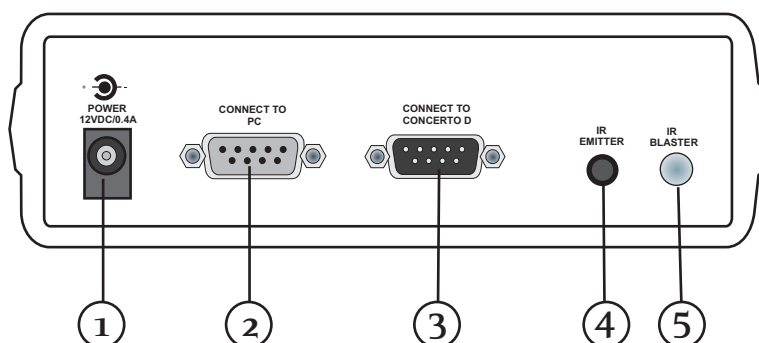

1. **AC Power:** A standard 12-volt power supply is included in the Learning Station Package. This will supply the necessary AC power for IR learning and testing.
2. **CONNECT TO PC:** Using one of the supplied RS232 cables, connect from the RS232 port on your computer to this input on the Learning Station Interface.
3. **CONNECT TO GRAND CONCERTO D:** Using the second RS232 cable, connect the Learning Station Interface to the Grand Concerto amplifier's RS232 port.
4. **IR EMITTER:** An IR mouse emitter is supplied with the Learning Station package. A feature of the Configurator Software is the ability to test each new code that is learned by the interface. The software will send the IR command to the source equipment via the IR emitter so you can have visual reference that the source equipment responded appropriately to the command.
5. **IR BLASTER:** Another built-in IR test method is the use of the blaster. The test process is the same in the Configuration program, but the IR Blaster allows you to point the back of the Interface box toward the source equipment IR receiver. This fires the IR command and eliminates the need for the mouse emitter.

## Capturing IR codes using the IR Learning Station Interface

The Grand Concerto Configurator Software is designed to store IR codes for audio equipment in an IR Library. When the codes are learned for a given piece of equipment, they are held in the library under that equipment's manufacturer name and model number. Once learned, any of the equipment in the library can be imported into a new Configuration.

To learn new equipment codes, the Learning Station Interface box must be connected to your computer at the RS232 port. Connect the male end of the RS232 cable to the back of the Interface box into the "CONNECT TO PC" input. At this point, it is not necessary to have the Interface box connected to the Grand Concerto amplifier.

When setting up a new source, each type of equipment has a pre-selected set of functions. By double-clicking on a function or clicking on the "Record" button in the software, you will open the record window. You will see the "READY" LED light on the interface box. Aim the source's remote control at the "IR SENSOR" on the Interface and press the desired function button on the remote. The IR learning window in the Configurator Software will indicate that the code has been successfully learned. **Note that the remote control should be held 8 to 10 inches from the Interface when learning.**

## NV-MI1 Mute Interrupt Adaptor (Fig. 50)

The Mute Interface is used in conjunction with System Mute input on the back of the Grand Concerto amplifier. It acts as relay for a voltage from up to two phone lines and two doorbell transformers. When a voltage is presented to the MI1, it sends a contact closure to the Grand Concerto System, which causes the system to mute momentarily. This is useful in allowing the telephone or doorbell to be heard when audio is playing in any of the zones.

The NuVo NV-MI1 Mute Interface Module is designed to automatically mute any audio playing through the System's speakers when the telephone or doorbell rings.

Fig. 50

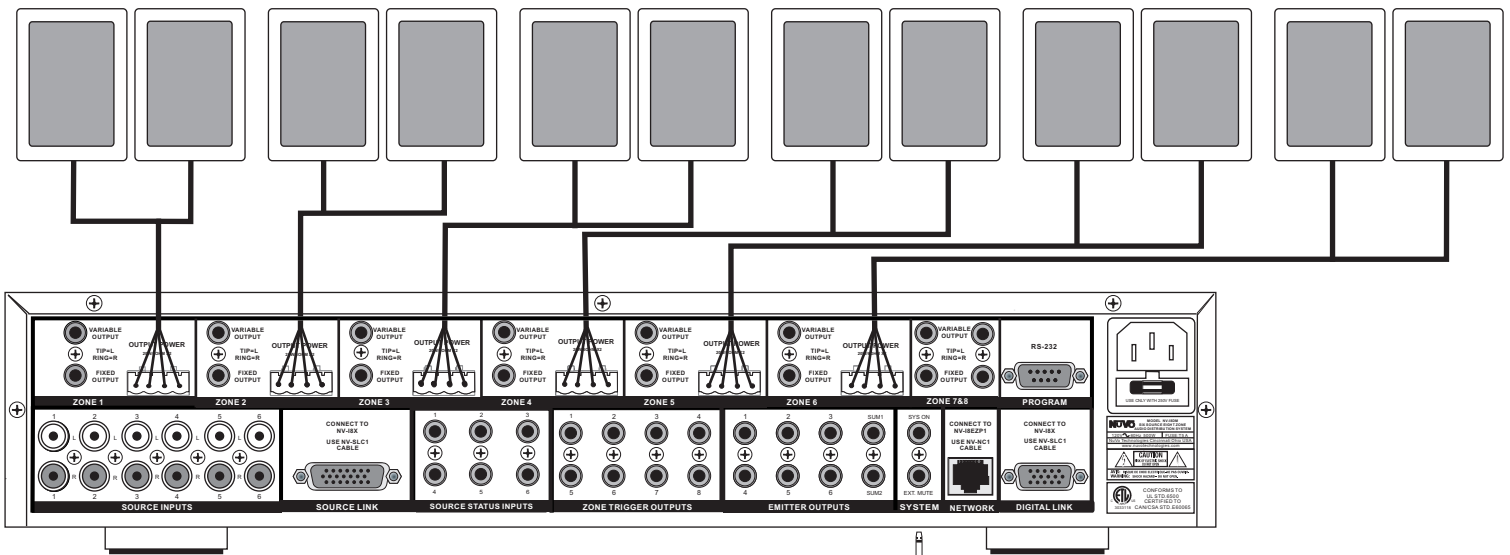

The MI1 connects to the NuVo amplifier using a standard mono patch cable with a mini-plug on each end. Plug one end into the EXT. MUTE input on the back of the amplifier and the other end into the input on the front of the MI1.

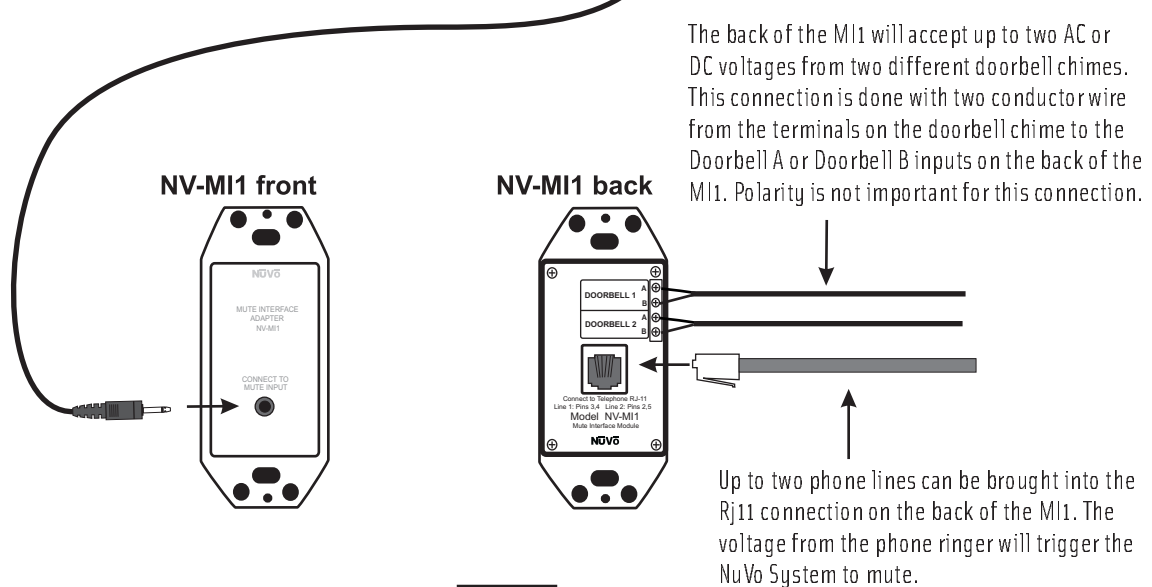

## NV-LSI24 Local Source Interrupt (Fig. 51)

The Local Source Interrupt enables an amplified local audio source to override the Grand Concerto System and play through the local zone in-wall speakers. The most common scenario for this is a television that would benefit from higher-quality speakers.

The back of the Grand Concerto Control Pad has two CAT5 inputs. One is labeled NuVoNet and is the CAT5 that runs to the EZ Port at the head end. The other is labeled NV-18GLSA. This is intended to react to the LSI24 accessory. It requires an RJ45 connection at the Control Pad end and the Brown and Brown Stripe pair as a voltage trigger.

Note that the Local Source Interrupt is a passive non-amplified device. The signal sent to it must be amplified.

Fig. 51

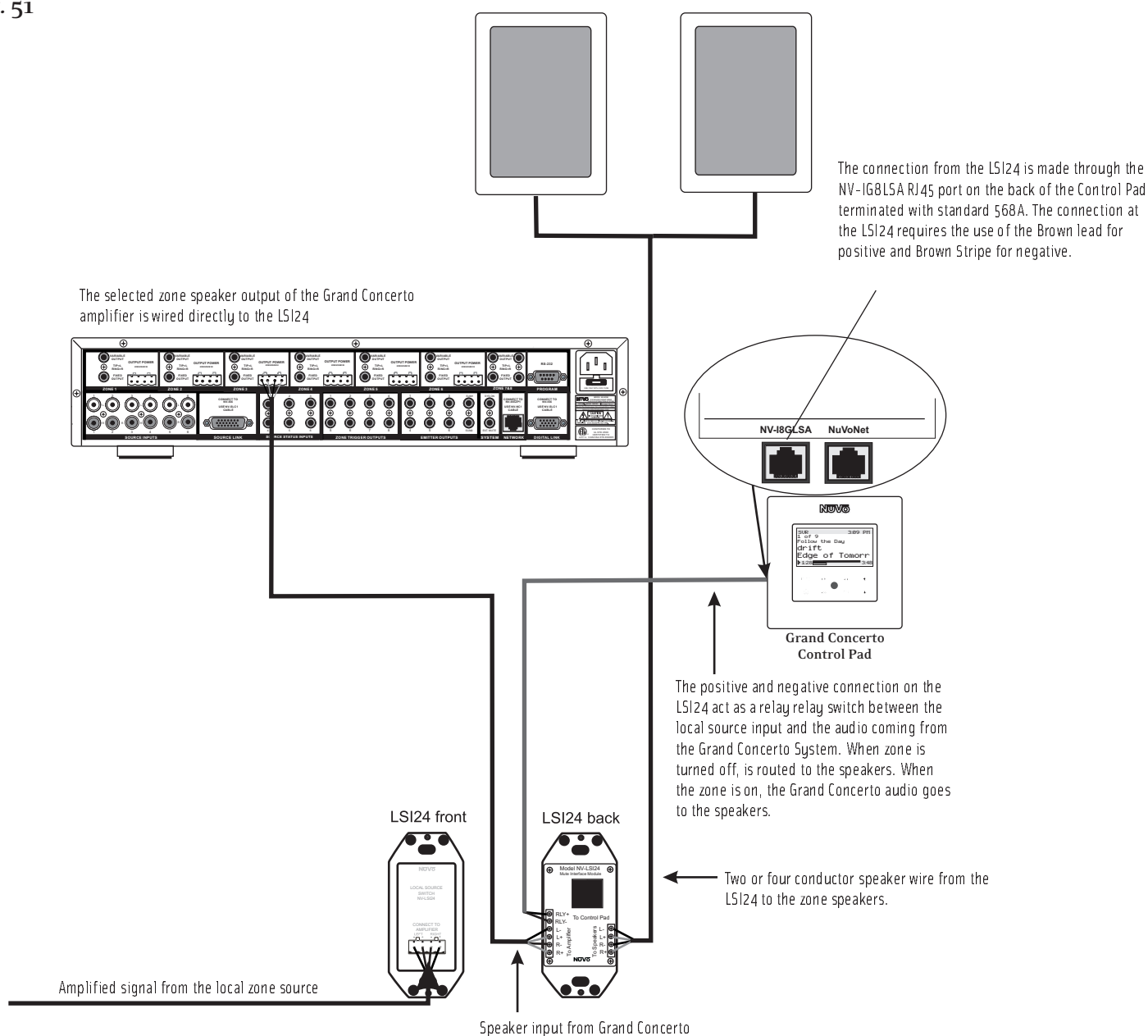

## NV-LSA40 Local Source Amplifier (Fig. 52)

The LSA40 is a 40 watt stereo amplifier designed to fit neatly in a single gang box or ring. Its active state provides a ready input for any line level audio signal. When connected to the Grand Concerto Control Pad, the Grand Concerto speaker output and the LSA40 share a common pair of speakers in a zone. The LSA40's internal A/B switch allows NuVo audio when the zone Control Pad is turned on and local audio through the LSA40 when the zone Control Pad is turned off.

Fig. 52

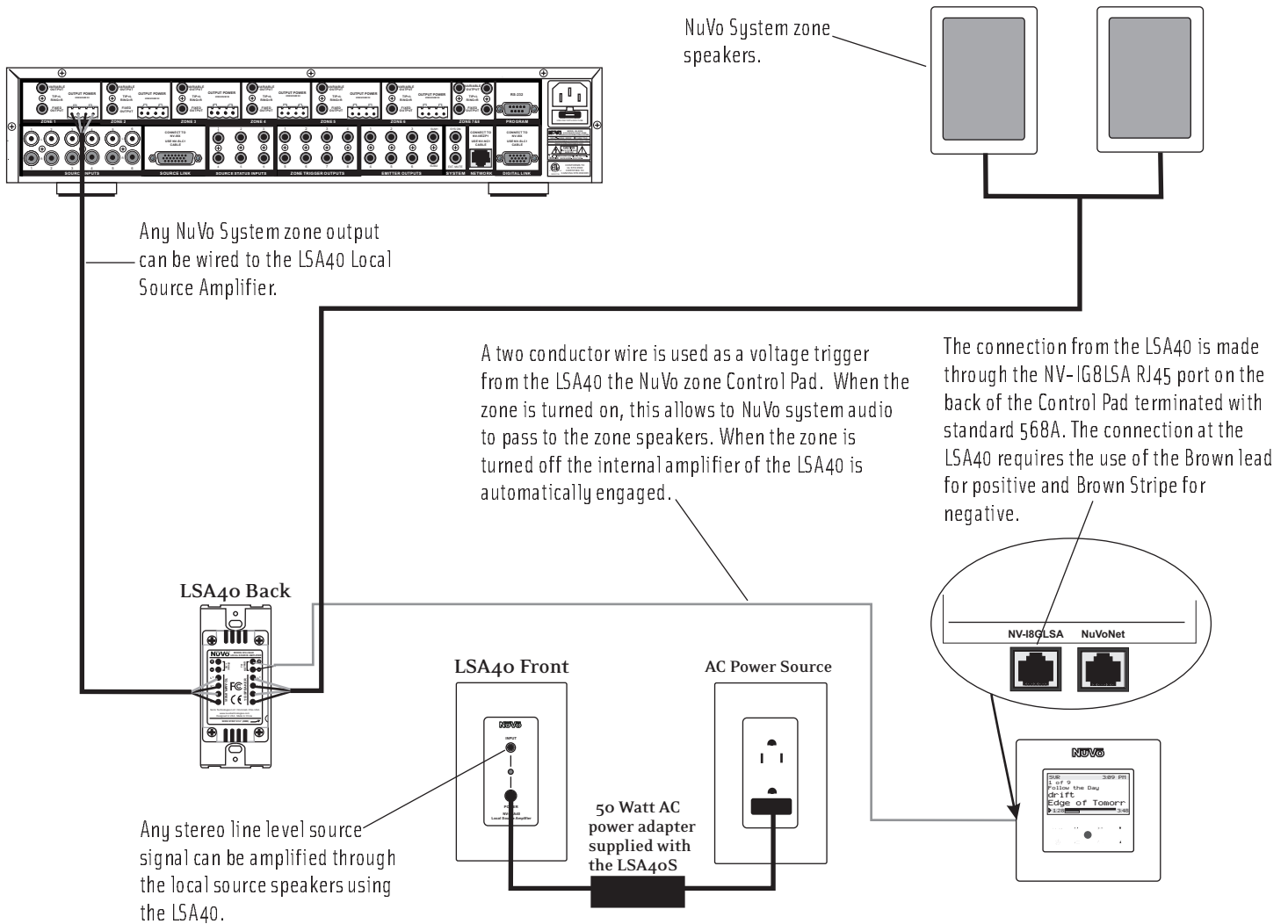



## NV-LSA40PD Local Source Power Distribution Hub (Fig. 53)

The LSA40PD Power Distribution Hub provides a compact method for distributing the necessary power to up to four LSA40 Local Source Amplifiers from one central location. The LSA40PD distributes the power over 16 AWG two conductor speaker wire to each of up to four individual LSA40 amplifiers. Connecting the LSA40 to the NuVo Control Pad and speakers is identical to the individual zone installation diagramed on page 33, Fig. 53. Note that if you are using the NV-LSA40PD the needed SKU for each zone amplifier is the LSA40 which is the local source amplifier with no power supply.

Fig. 53

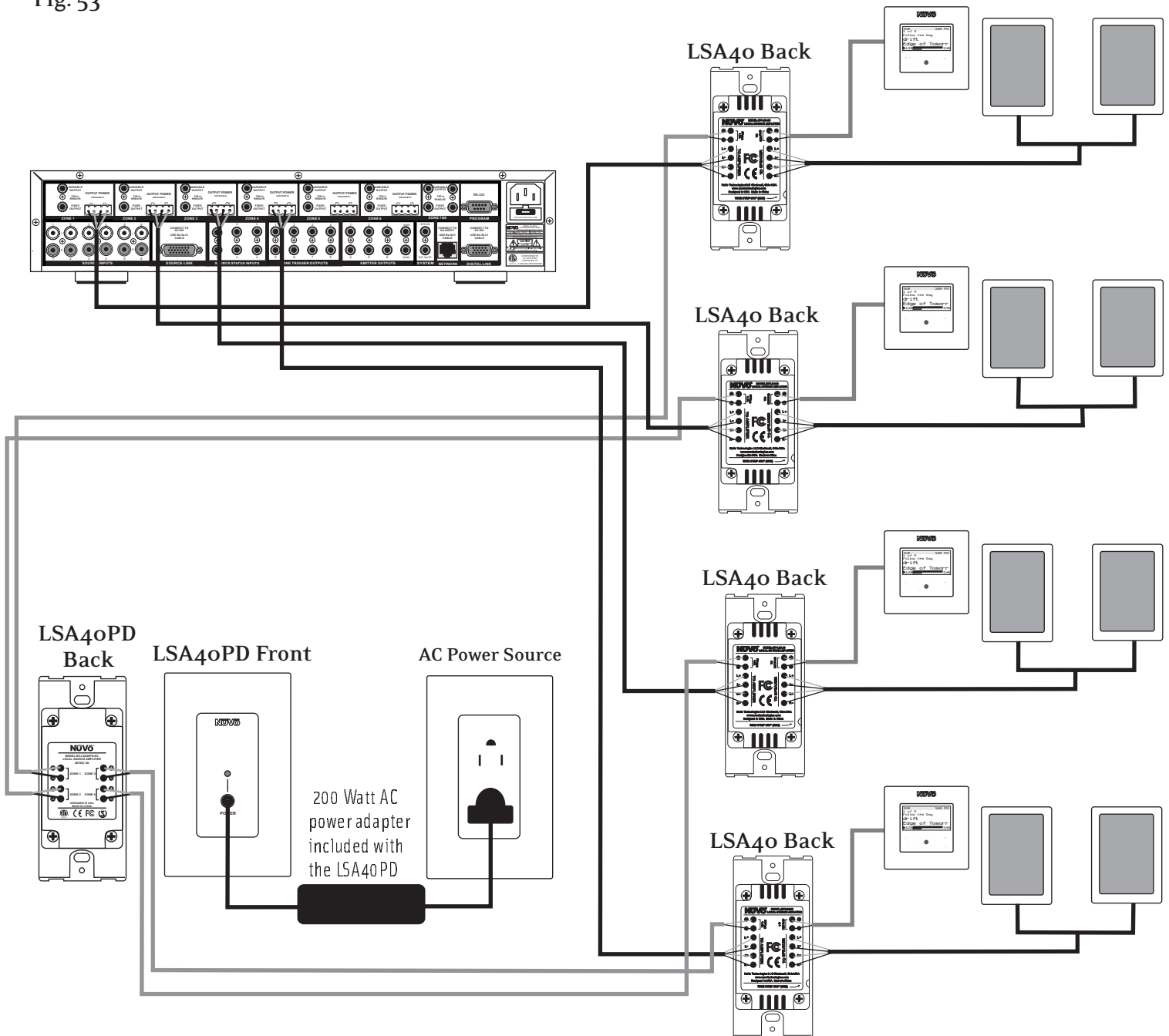

## NV-D2120 and D460 Auxiliary Audio Amplifiers (Fig. 54 & 55)

The NuVo stereo digital amplifiers are specifically designed for use with the NuVo Systems' lineouts. They can be used with either the fixed or variable outputs on each of the Grand Concerto amplifier zones. Keep in mind that the D2120 and D460 do not have volume control, so the fixed lineout will require some type of inline volume control. The connection is made using either an 1/8" (3.5mm) stereo to RCA patch cable.

The D2120 is a single 120 watt stereo amplifier. The audio input can come from any of the available zone lineouts. The D460 has two separate audio inputs for **Amplifier A** and **Amplifier B**. Either of these inputs can be used independently, and are especially useful for the non-amplified zones 7,8, 15, and 16.

There are two methods for triggering the NuVo amplifiers from the Grand Concerto outputs. One is to set the **POWER MODE** switch on the P2100 to **AUDIO** (extreme left) position and allow an incoming audio signal from the Grand Concerto System to turn on the amplifier. The second method is to place the **POWER MODE** switch in the **TRIGGER** (extreme right) position. This will turn on the amplifier when the Grand Concerto is powered on from its standby state. This requires a mono 1/8" (3.5mm) connection from the Grand Concerto's **SYS ON** output to the trigger input on the amplifier.

An additional feature of Grand Concerto is Zone-Specific Triggers that will trigger either of the amplifiers only when that zone is turned on. Utilizing the voltage trigger requires a mono 1/8" (3.5mm) patch cable from the specific Zone Trigger on the Grand Concerto to the **TRIGGER IN** on the amplifier, as shown in Fig. 54 & 55.

### RS232 Interface

The RS232 port allows external two-way communication with the Grand Concerto System. Home automation systems can be set up to operate Grand Concerto. The RS232 protocol document is available for download from the website Prozone at [www.nuvotechnologies.com/prozone](http://www.nuvotechnologies.com/prozone).

Fig. 54

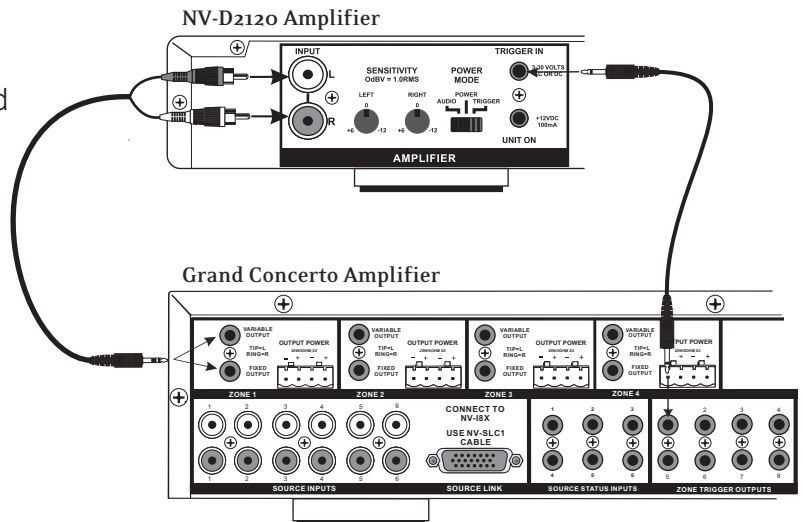
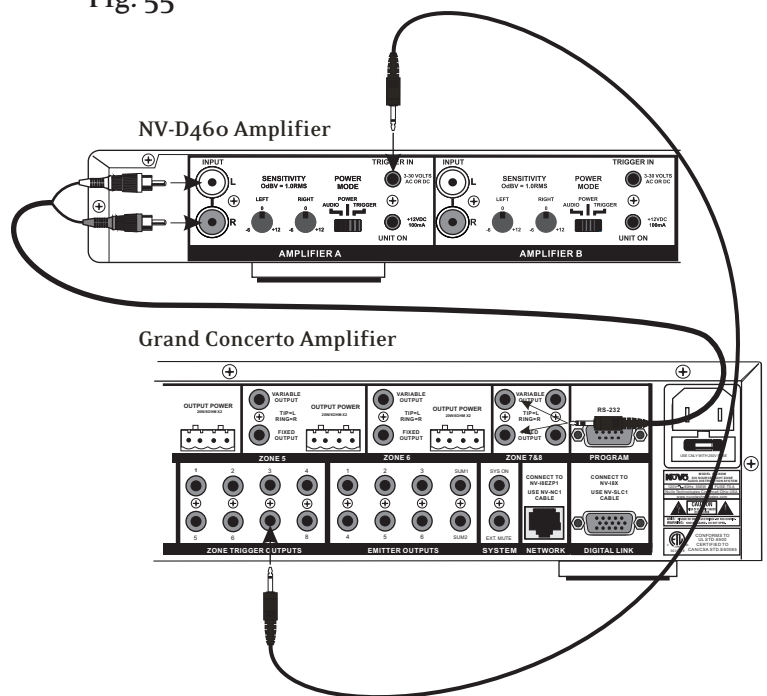

Fig. 55



## Grand Concerto Specifications

### Zones 1-6 Power Amplifier Outputs

Continuous Average Output Power	80W (40W x 2)
Two channels driven 30-20kHz @1% THD	
Rated Distortion (1/2 power)	0.40%
Rated Impedance	6 Ohms
Damping Factor	50+
Frequency Response	20-20kHz ± 2dB

### Zones 1-8 Preamplifier Outputs

Variable output	0-600mV
Fixed output	600mV
Impedance	600 Ohms

### Source Inputs 1-6

input Impedance	20K
Input Sensitivity for rated power	300mV RMS
Input Overload	3V RMS

### Emitter Outputs

Source Outputs	6
Sum Outputs	2
Output Drive Current	100mA
Output Drive Voltage	12V
Compatible with single and dual emitters	

### System

System On (output)	12V @ 50mA
External Mute (input)	3-12V DC

### Serial Port

Baud Rate	57,600
Data Bits	8
Stop Bits	1
No Parity	
No Flow Control	

### Zone Trigger Outputs

Output Power	12V @ 50mA
Outputs	8 (zones 1-8)

### Source Status

Output Power	3-15 VDC
Outputs	6 (Source 1-6)

### Power Requirements

Power Supply- North American	120VAC/ 50Hz
Power Supply- Export	240VAC/60Hz
Power Consumption all channels driven to full-rated power	600VA (480W)
Power Consumption average operating conditions	100VA (80W)
Power Consumption no signal	30VA (25W)
USA Safety Listing (UL 6500)	
Canada Safety Listing (CAN/CSA E60065.00)	
CE Listing/SEMKO (EN60065, EN55013, EN55020, EN6100-3-2, EN6100-3-3/A1)	

### Physical Specifications

Unit Size Millimeters	95 x 430 x 340 (LWH)
Unit Size Inches	3 3/4 x 17 x 13 3/8 (LWH)
Shipping Size Millimeters	600 x 475 x 380 (LWH)
Shipping Size Inches	23 5/8 x 18 3/4 x 15 (LWH)
Unit Weight Kilograms	9.4
Unit Weight Pounds	20.6
Shipping Weight Kilograms	15.5
Shipping Weight Pounds	34.0

NuVo reserves the right to change specifications without notice

## Grand Concerto Package Contents

### NV-18GMS Grand Concerto System

- NV-18GM Grand Concerto main amplifier
- 6 NV-18GCP Control Pads with white, ivory, almond and black screwless trim plates
- 1 NV-GRC1 Remote Control
- 6 NV-VEC Visible IR emitters
- 1 NV-18EZP EZ Port connection hub
- 1 NV-NC1 3 meter network cable
- 1 pr. NV-REM Rack Ear Mounts
- 1 NV-PC2NA Power Cable, 2 wire, North America

### NV-18GX5 Grand Concerto Expander System

- NV-18GX Grand Concerto Expander Amplifier
- 6 NV-18GCP Control Pads with white, ivory, almond and black screwless trim plates
- 1 NV-GRC1 Remote Control
- 1 NV-SLC Audio Link cable
- 1 NV-DLC Digital Link cable
- 1 pr. NV-REM Rack Ear Mounts
- 1 NV-PC2NA Power Cable, 2 wire, North America

## Troubleshooting

Symptom	Probable Cause	Remedy
When the Control Pad is plugged in there is a loud pop through the speakers and the Control Pad does not work.	Improperly wired CAT5 cable.	Check that you are using the 568A or B wiring standard (see section I: Crimping CAT5 wire). The best way to know is to use a CAT5 tester.
One of the zone Control Pads displays a "NuVoNet Not Detected" message.	Zone CAT5 is plugged into the Accessory jack on the back of the Control Pad instead of the NuVoNet jack. Improperly wired CAT5 Cable.	Check the CAT5 connection at the back of the Control Pad. Plug the Control Pad directly into the Network cable and into the NuVoNet input on the Grand Concerto.
The amplifier is plugged in and turned on, but the STAND BY LED is not lit and none of the system functions work.	This is most likely caused by a blown fuse on the power supply.	The fuse is accessed at the AC plug on the back of the amplifier. It requires a 4 amp time delay fuse.
All of the system's Control Pads display a "NuVoNet Not Detected" message.	The MCU card internal to the Grand Concerto is damaged, or the data (blue and blue stripe) conductors on one or more of the CAT5 cables are shorted or not making good contact in the RJ45	Remove all of the CAT5 connections from the system and test cables one at a time. If the issue is a shorted CAT5, the symptom will display when that cable is connected to the system. A damaged MCU must be replaced by NuVo.
With the Control Pads plugged in, the POWER LED on the front of the amplifier will not turn on.	One or more improperly wired CAT5 cables.	Make sure the amplifier is turned on. Test that the POWER LED on the amplifier turns on when the Network Cable is unplugged. Next, unplug all the CAT5 cables from the Allport and plug them back in one at a time until the bad cable(s) is discovered.
The IR repeater does not properly control the audio source equipment.	One or more of the IR emitters are not properly placed over the IR receiver on the audio source equipment, or the IR output number on the Grand Concerto does not correspond with the audio equipment you are controlling.	Reposition the LED end of the emitter on the face of the source equipment, so it is flashing directly over that source's IR receiver. Make sure the emitter plugged into IR Output #1 is actually going to source #1, and so on for sources 2-6.

## Troubleshooting

### Symptom

### Probable Cause

### Remedy

The IR repeater does not properly control the audio source equipment.

The NuVo IR output is not set at the best carrier frequency.

Within IR Library tab of the Configurator Software, each library has a "Properties" button. This button has a drop down menu that lets you select different carrier frequencies from 30kHz to 56kHz. This will default the library to the selected frequency. Cable and Satellite typically needs the 56kHz setting.

The IR repeater does not properly control the audio source equipment.

An External light source is interfering with IR communication through the system.

In the Configurator Software (see pg. 19, **IR Passthrough**), or in the Advanced Zone Setup menu (see pg. 27 **Remote Controls**), at any Control Pad, you have the ability by zone to "Disable" the IR receiver. This will prevent direct sunlight, or possibly, plasma and fluorescent light from affecting IR response through the other zone receivers.

When downloading a Configuration to the Grand Concerto Main amplifier, a "board not found" error message appears on the computer screen.

This occurs when the Grand Concerto is not plugged into an AC power source, or a faulty USB to RS232 conversion cable.

A communication error can be as simple as not plugging the Grand Concerto in prior to the download. Often the error is also corrected by closing and reopening the Configurator Software, or if you are using a USB to RS232 cable for communication, try a different cable. If these do not correct the error, it could be a faulty MCU board in the Grand Concerto.





**NuVo Technologies LLC Hebron, Kentucky USA**  
**[www.nuvotechnologies.com](http://www.nuvotechnologies.com)**