



**OmniTerm WBT**  
Windows-based Terminal

**User's Guide**

Version 2.1.0e

# Contents

Chapter 1 - Installation Procedures .....	1
Chapter 2 - Terminal Operation.....	2
2.1 - Initial Terminal Setup.....	2
2.2 - Terminal Manager .....	9
2.2.1 - Connections .....	10
2.2.2 - Configure .....	11
2.3 - Connection Navigation/Startup .....	14
2.3.1 - Hot Keys .....	14
2.3.2 - Terminal Startup Modes.....	15
2.3.3 - Startup Errors.....	18
Chapter 3 - ICA Client Settings .....	19
3.1 - Network Connection .....	20
3.2 - Dial-In Connection .....	25
3.2.1 - Port Settings .....	27
3.2.2 - Call Option .....	28
Chapter 4 - RDP Client Settings.....	29
Chapter 5 - Terminal Emulation Client Settings .....	31
Chapter 6 - Terminal Properties .....	46
6.1 - General Tab.....	47
6.2 - Input Tab .....	48
6.3 - Display Tab.....	49
6.4 - Network Tab .....	50
6.5 - Upgrade Tab.....	58
6.6 - Devices Tab.....	59
6.7 - Security Tab .....	78
6.8 - SysInfo Tab .....	83
6.9 - About Tab.....	84
Chapter 7 - Terminal Emulation Sessions .....	85
7.1 - Display Session .....	85
7.1.1 - File Menu .....	88
7.1.2 - Edit Menu.....	89
7.1.3 - View Menu .....	90
7.1.4 - Macro Menu .....	91
7.1.5 - Setting Menu.....	94
7.2 - Printer Session .....	100
7.2.1 - File Menu .....	101
7.2.2 - Help Menu.....	103
Chapter 8 - Terminal Firmware Upgrade.....	104
8.1 - Prepare FTP Server .....	104
8.2 - Update Procedure .....	105
8.3 - SNMP Manager Procedure.....	107
Chapter 9 - Web Browser.....	108
9.1 - File Menu.....	109
9.2 - Edit Menu .....	109
9.3 - View Menu.....	110
9.4 - Go Menu.....	111
9.5 - Favorites Menu.....	112
9.6 - Window Menu.....	112
Chapter 10 - Wireless Network Configuration .....	113
10.1 - Wireless Networking Concepts.....	113
10.2 - Install Wireless PCMCIA Card.....	113

10.3 - Configure Wireless Settings .....	114
10.4 - Wireless Communication Problems .....	118
Appendix A - AS/400 FTP Setup .....	119
Appendix B - AutoUpdate / AutoConfiguration .....	120
Appendix C - Advanced Terminal Customization .....	122
C.1 - Emulation Font Upload .....	122
C.2 - Boot-up Splash Screen Upload .....	125
C.3 - Remote Serial Number Update .....	126
C.4 - Registry Edits .....	127
C.4.1 - Disable Browser Address Bar .....	127
C.4.2 - Autostart Delay Feature .....	128

# Chapter 1 - Installation Procedures

The OmniTerm equipment package and stand assembly is described here. Refer to the Quick Start Guide to setup and configure your OmniTerm. See the body of this manual for safety and complete installation instructions.

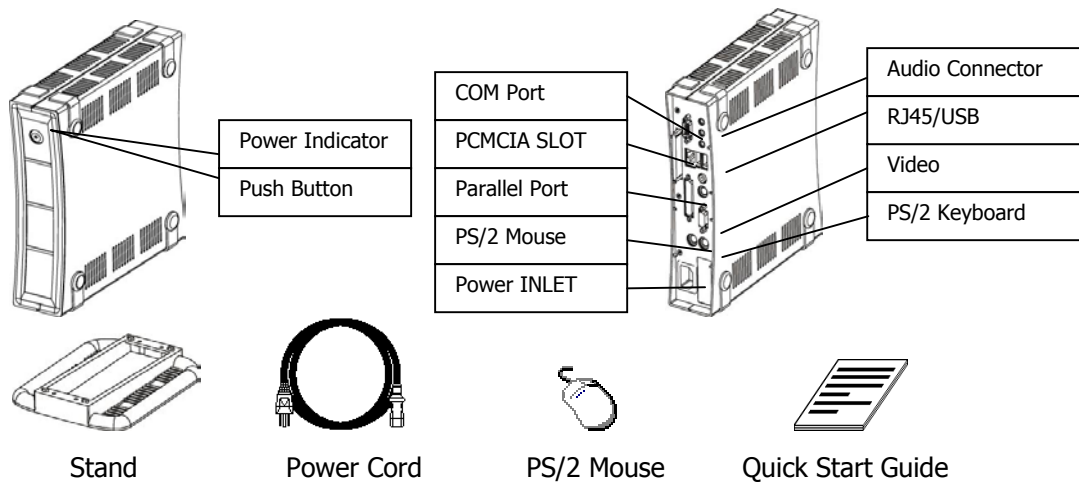

## Stand Assembly/Re-Assembly

- (1) Identify the front and rear orientation of the stand.
- (2) Attached the stand to the OmniTerm using the 4 screws provided.
- (3) The stand will be attached as shown.

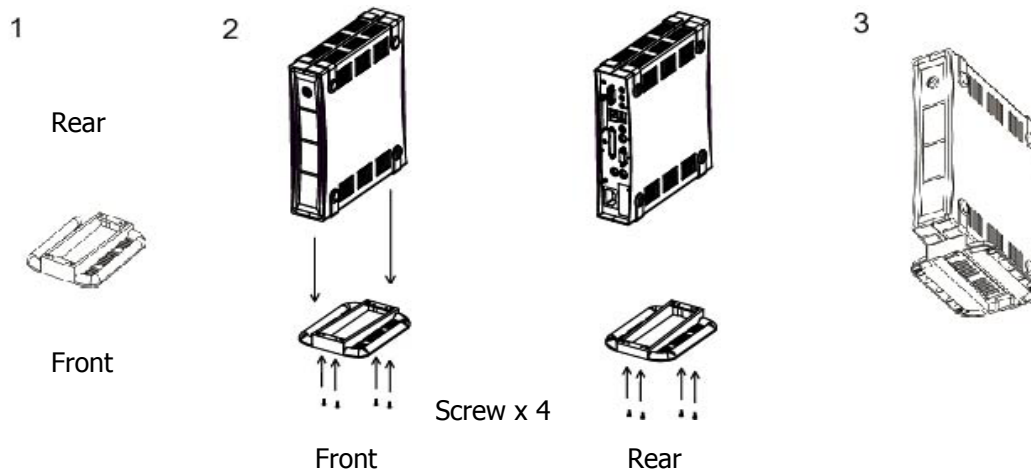



# Chapter 2 - Terminal Operation

## 2.1 - Initial Terminal Setup

When you power on the terminal for the first time, the Setup Wizard will be used for initial setup of the terminal's properties. Following are the dialog boxes of the setup wizard. This sequence is also invoked when the terminal is reset to initial conditions.

### Welcome Dialog Box

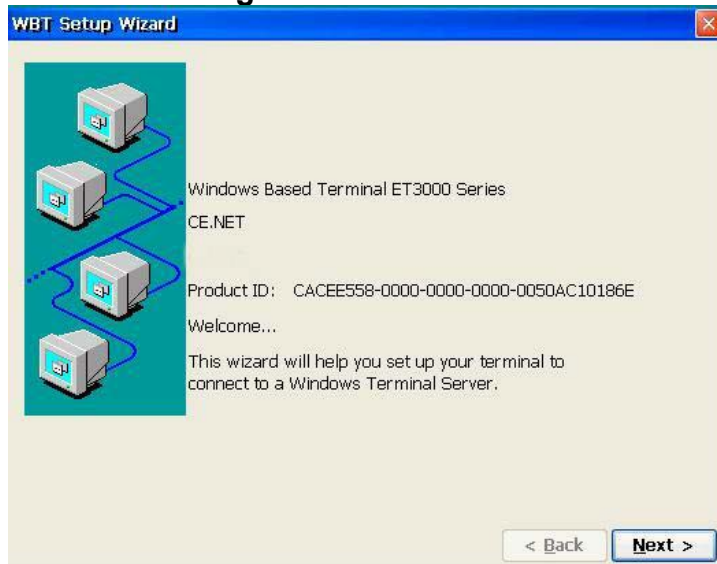

This dialog box provides product information. A 15-second countdown displays at the top. Click Next to continue, or wait for the countdown to end. Press **Esc** to bypass the following screens to use default settings (Network DHCP enabled, Display resolution of 640x480 @ 60Hz, no security, etc.) and proceed to the Terminal Manager screen (see section 2.2).

### EULA (End User License Agreement) Dialog Box

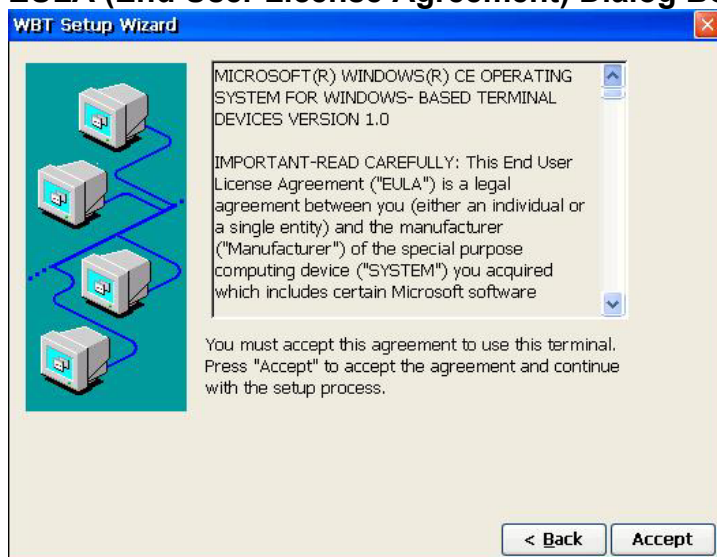

Please read the license agreement carefully. Click **Accept** to continue.

## IP Address Dialog Box

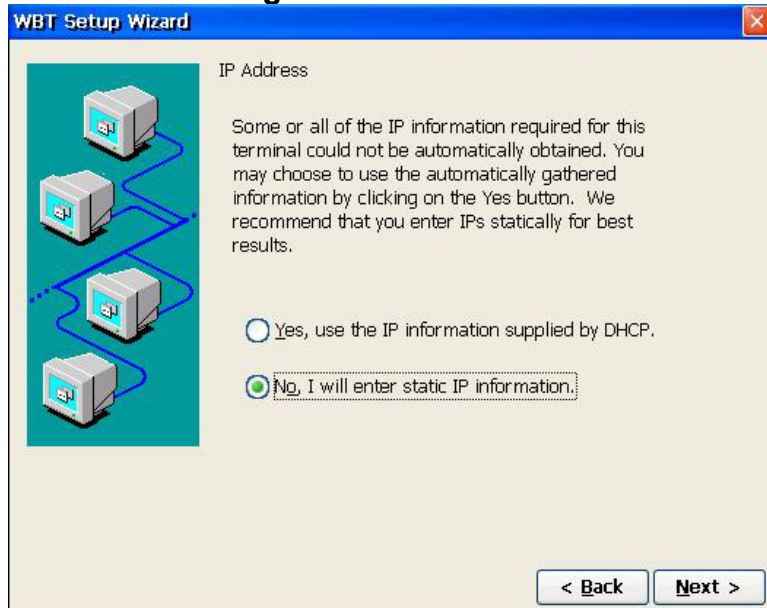

Click on one of the two buttons to select a method to supply the IP Address. The default is **No; I will enter static IP information**. If you select **Yes, use the IP information supplied by DHCP**, the next figure (Specify an IP Address Dialog Box) will be skipped.

## Specify an IP Address Dialog Box

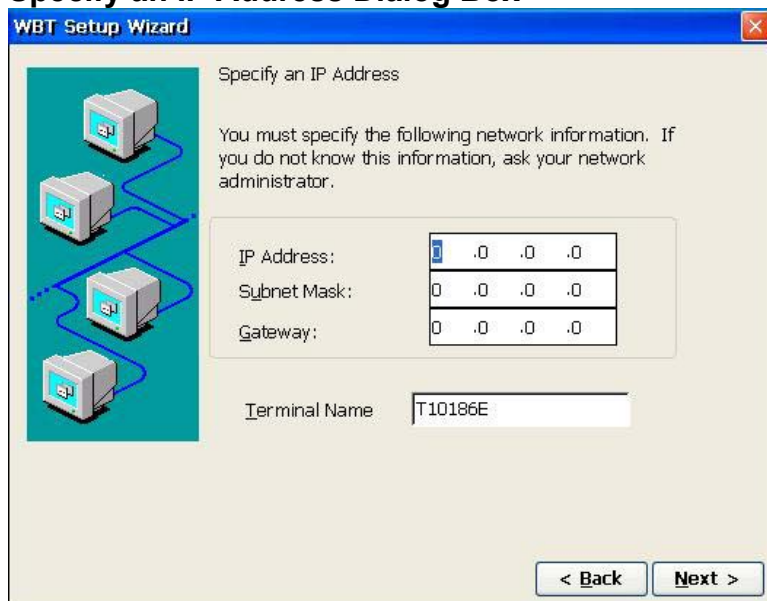

Enter the network information requested in the fields provided.

## Optional Information Dialog Box

The screenshot shows a window titled "WBT Setup Wizard" with a close button in the top right corner. On the left, there is a graphic of four computer monitors connected by blue lines. The main text reads: "Fill in the following optional information to configure the terminal's name resolution." Below this, there are two sections. The first section is for DNS, with a checkbox labeled "Enable DNS" (which is unchecked). Below the checkbox are three input fields: "Default Domain Name:", "Primary Server IP:", and "Secondary Server IP:". The second section is for WINS, with a checkbox labeled "Enable WINS" (which is unchecked). Below the checkbox are two input fields: "Primary Server IP:" and "Secondary Server IP:". At the bottom right, there are two buttons: "< Back" and "Next >".

If you use DNS (Domain Name System) or WINS (Windows Internet Name Service) to resolve names to IP addresses, select a check box and enter the required information. By default the check boxes are unselected. If DHCP is used, the DNS server is commonly specified and would not need to be entered here.

## Desktop Area and Refresh Frequency Dialog Box

The screenshot shows a window titled "WBT Setup Wizard" with a close button in the top right corner. On the left, there is a graphic of four computer monitors connected by blue lines. The main text reads: "Desktop Area and Refresh Frequency. The best available Desktop Area (resolution) and Refresh Frequency has been selected for you. You may choose other combinations from the list. To ensure your selection works with your monitor, click Test." Below this, there is a section titled "Desktop Area and Refresh Frequency" containing a scroll list with the text "640 x 480 @ 60Hz" and a "Test ..." button. At the bottom right, there are two buttons: "< Back" and "Next >".

Select from the scroll list to set the resolution. The default setting is **640x480@60Hz**. Always click **Test** to see the resolution selected temporarily and determine whether it works with your monitor.

### Local 'RDP' Printer Setup Dialog Box



Click **Open** to setup a local printer to be used with an RDP session. Click **Next** and the Finish dialog box will display.

### Local Printer Configuration Dialog Box

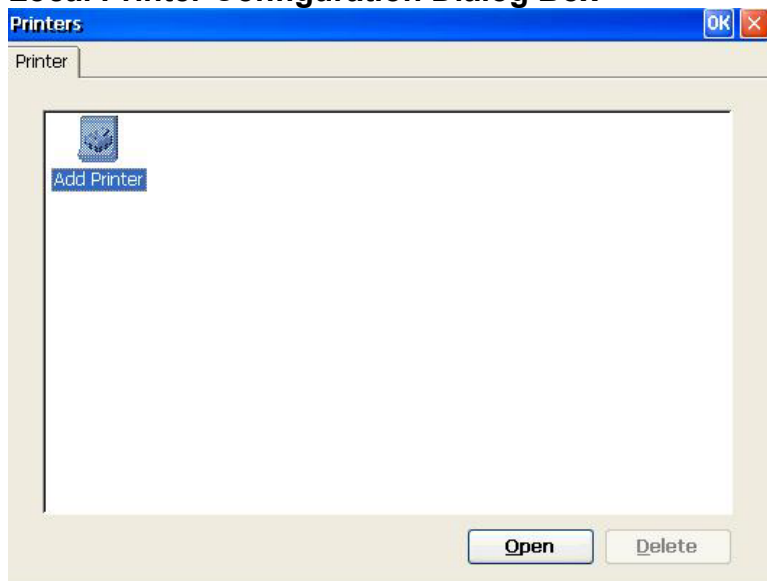

Click **Open** to setup a local printer. Click **Delete** to delete the local printer. Click **OK** to return to the Local Printer Setup dialog box.

## Select the Printer Port Message Box



Select the port you want your printer to use. Most users select LPT1 port for a local printer.

## Select the Printer Model Message Box

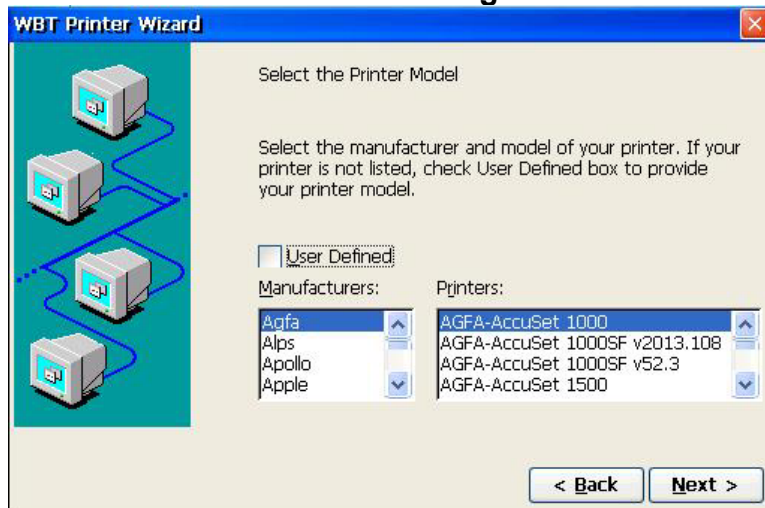

Select the manufacturer of your printer from the Manufacturers list. Then, choose the correct printer model from the Printers list.

### Name your Printer Dialog Box

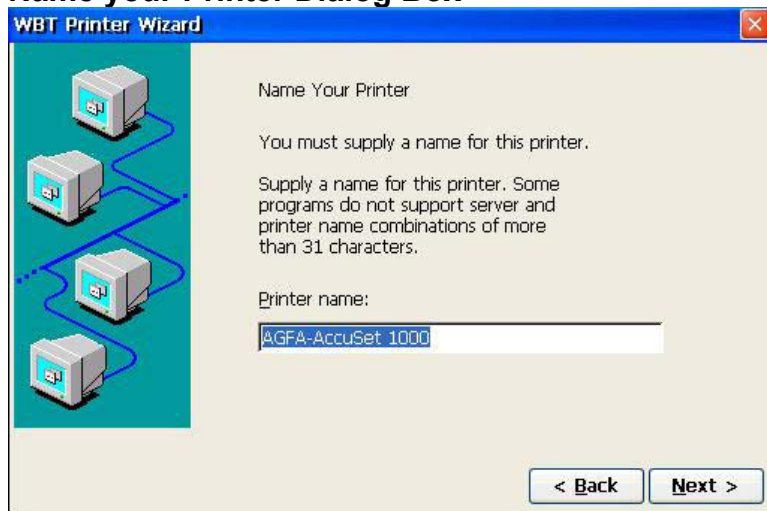

Specify the name of your printer. The printer name can be entered as no more than 31 characters.

### Set Default Printer Dialog Box

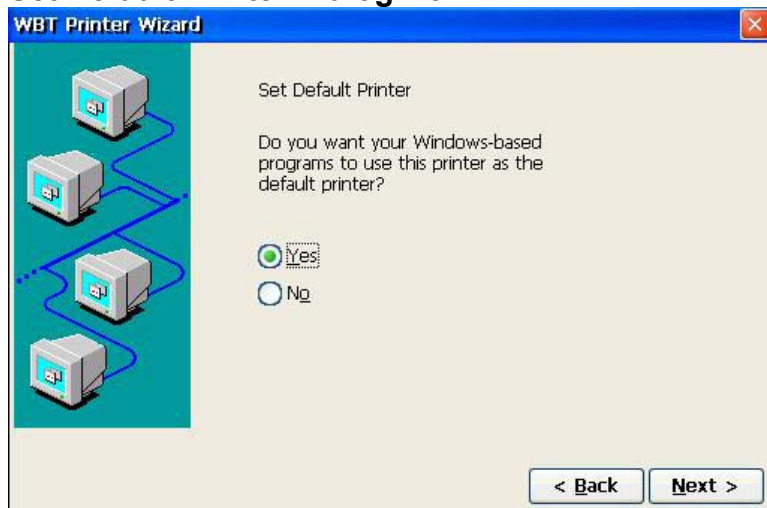

This dialog box allows you to set the local printer as the default printer. The default selection is **YES**.

## Configure Another Printer Dialog Box

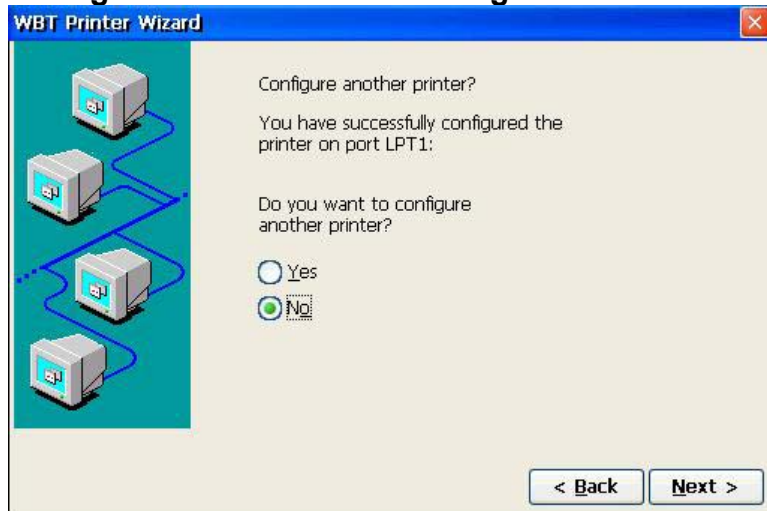

If you need to set up the second printer, select **YES** then click **Next** to repeat the prior screens to setup another printer.

The default selection is **NO**. Click **Next** to finish.

## Finish Dialog Box



Click **Finish** to apply your specified setting and quit the Setup Wizard.

## Terminal Settings Change



The terminal must be restarted for changes to take effect. Click **Restart** to complete the initial terminal setup.

To change the setup, press **F2** from the Terminal Manager screen (see section 2.2). The Terminal Properties screens and procedures are described in Chapter 6.



## 2.2 - Terminal Manager

The Terminal Manager allows you to manage your network connections. All connections are named and are referred to by that name. Multiple connections of various types can be created and active at the same time.

### Terminal Manager Dialog Box (Connections)

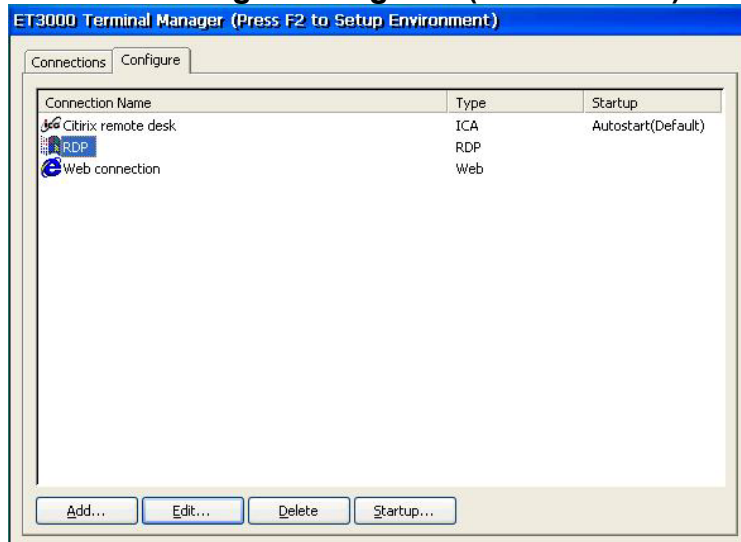

After you finish the initial terminal setup, the Terminal Manager dialog box will display. Unless Security is in effect, this will be the first dialog box after you power on the terminal. If a browser is supported, the name **Web Browser** will be displayed as a Connection Name. Connection names are listed in alphabetic order.

From an active connection display, press **Ctrl+Alt+End** to return to Terminal Manager.

Press F2 to review or change the Terminal Properties. See Chapter 6 for a description of the Terminal Properties screen.



## 2.2.1 - Connections

The Connections property sheet (see above) lists all your configured connections, showing their Type and Status.

Connection Types: **RDP** (Microsoft Terminal Server), **ICA** (Citrix Server), **EMU** (Host Emulation), **Web** (Web Browser), and **DUP** (DialUp Connection).

Connection Status: **Active** if connection is active (connected). Blank if connection is not active.

You can select from this list and click **Connect** to activate that connection; or just double click the connection name to be activated. For a selected active session, you can click **End** to end the connection.

If no connections are Active you can click **Shutdown** to Logoff or Restart the terminal.

### System Shutdown Dialog Box



#### **Logoff:**

This function is available when **Security** feature is enabled.

#### **Restart Terminal:**

This function is the default value.

#### **Shutdown:**

This function will be available in the future version.

## 2.2.2 - Configure

The Configure property sheet allows you to create new connections or edit/delete existing connections. You may also specify which, if any, connections are to be automatically activated (connected) on startup.

Once the desired connections are configured, security can be set to inhibit display of the Configure Dialog Box.

### Terminal Manager Dialog Box (Configure)

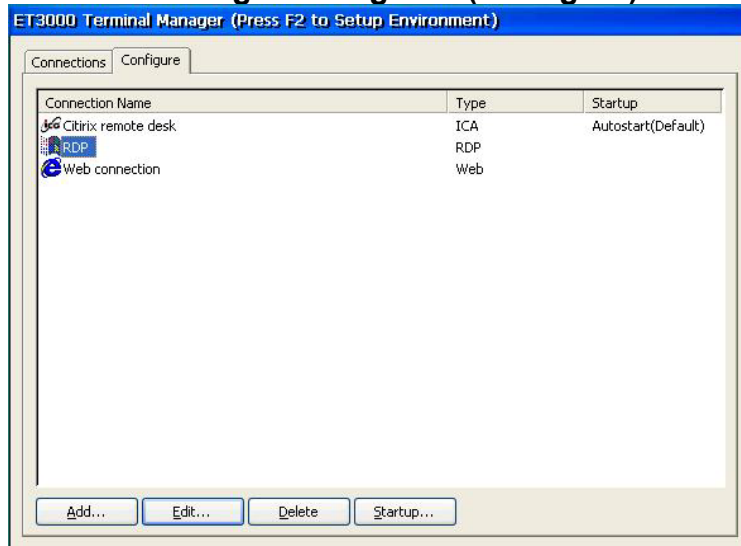

Connection Types: **RDP** (Microsoft Terminal Server), **ICA** (Citrix Server), **EMU** (Host Emulation), **Web** (Web Browser), and **DUP** (DialUp Connection)

Startup Codes: **Default** if default session, **Autostart** if Auto-startup, **Autostart(Default)** if both Default & Autostart, and Blank if no special status.

Click **Add** to configure a new connection.

### New Connection dialog Box

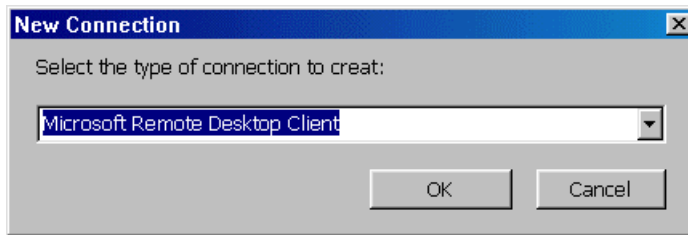

Select the type of connection to create:

**Citrix ICA Client** (Chapter 3)

**Microsoft Remote Desktop Client** (Chapter 4)

**Terminal Emulation** (Chapter 5).

Click **Edit** to edit or review the selected item in the connection list.

Click **Delete** to delete the selected item in the connection list.

### Connection Delete Dialog Box

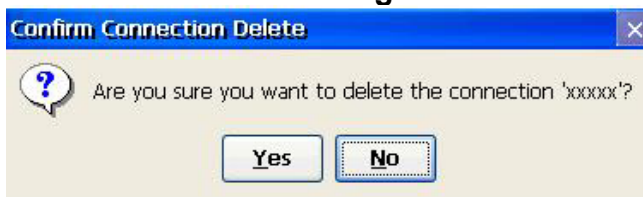

This dialog box asks you if you really want to delete the selected connection in the Terminal Manager dialog box.

Click **Startup** to make the selected Connection the Default and/or set it for Autostart.

### Connection Startup Dialog Box

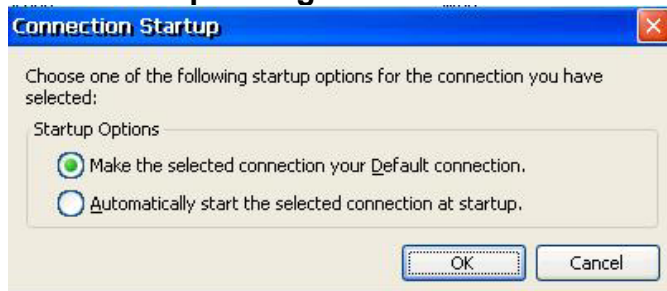

#### **Make the selected connection your default connection:**

A default connection is the one initially displayed or selected. Only one connection can be set as the default; and setting a connection as default is not required. The status in the Startup column will show **Default**.

#### **Automatically start the selected connection at startup:**

The startup screen will automatically display the selected connection. No need to click **Connect** in Terminal Manager. The status in the Startup column will show **Autostart**. Multiple connections can be automatically started.

*To set a connection as both Startup and Default, set it to Default first then set it to Autostart. That connection will be the "home" connection; the one initially displayed after all sessions autostart.*

## 2.3 - Connection Navigation/Startup

### 2.3.1 - Hot Keys

The following key sequences are used to move between active connections, return to Terminal Manager, Edit/Check the Terminal Properties.

#### **Ctrl+Alt+End or SetUp (122key)**

Return to Terminal Manager (or Connect Button or Task Bar) from an active connection.

#### **Ctrl+Alt+UpArrow**

Switch to the previous active connection (if any).

#### **Ctrl+Alt+DownArrow or Alt+Jump (122key)**

Switch to the next active connection (if any).

#### **Ctrl+Alt+Home**

Go to the Default connection (if any or if not already there).

*Note: The right and left Alt keys function differently in emulation sessions. The left Alt key is for Windows function; e.g. Alt(left)+E shows the Edit menu options. The right Alt key is reserved for special emulation functions; e.g. Alt(right)+E generates the Euro symbol.*

*Note: On the 122key keyboard (122Key), certain special key sequences are supported.*

#### **F2**

Press **F2** from Terminal Manager to invoke the Terminal Properties dialog box.

#### **Reset to Factory Defaults:**

#### **Ctrl+Tab+Delete+F12**

Bring up a Reset to Factory Defaults dialog box – Click **Yes** to reset; or **No** to ignore Reset request. This is active only from the Terminal Manager screen or the Connect Button and then only if enabled under Security (Reset HotKey Enable, default).

If the terminal uses CE.NET, power off/on the terminal and hold the **Backspace** key down before the progress bar ends

From the Terminal Properties General tab, check **Reset to factory-defaults**.

Using the SNMPadm management tool, discover the IP address of the terminal of the terminal you wish to reset. Right click and select the Menu option to Reset to Default.

## 2.3.2 - Terminal Startup Modes

Once a terminal is configured, when powered on operation starts with the Terminal Manager, a Connect Button (secure connection) or a Connection Task Bar. These startup modes are selected under the Terminal Properties Security Tab - see 7.8 in this manual.

### 2.3.2.1 - Security Login

If Security is enabled and Auto Login was selected, the following screen displays.

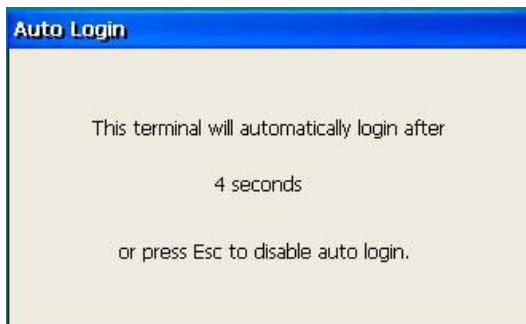

While this box is displayed, press **Esc** to allow login as the Administrator or a different user (different connections).

If Auto Login is not enabled with Security or if **Esc** was pressed at the Auto Login box. The following dialog box is used to login.

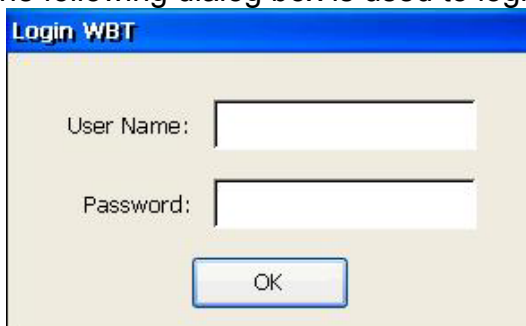

### 2.3.2.2 - Terminal Manager Startup

The Terminal Manager screen is displayed.

If connections are set for AutoStart, they will be started. If not, the user must start the connections desired.

From the Terminal Manager screen, press F2 to examine/change the Terminal Properties. If Security is active and not signed on as Administrator, only the tabs General, Input, Display, Devices, SysInfo, and About will be available for use.

### 2.3.2.3 - Connect Button

A **Connect** button may be displayed in place of the Terminal Manager screen. To start your configured connections, click **Connect** or press Enter. Pressing **Ctrl+Alt+End** from an active connection will return to the Button display.

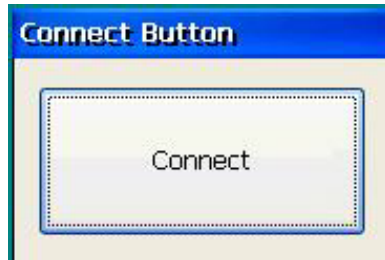

Special Connect Button escape sequence:

Repeatedly click on the Connect button border to show the Terminal Properties screen. If Security is active and not signed on as Administrator, only the tabs General, Input, Display, Devices, SysInfo, and About will be available for use.

### 2.3.2.4 - Connection Task Bar

The Connection Task Bar is a Windows like task bar showing all connection names and optionally the terminal name. A Start button appears on the left of the task bar from which the user may access Terminal Properties, Terminal Manager, and Task Bar settings (options), and Shutdown.

Check the Connection Task Bar checkbox in the Security Properties Tab below the Connect Button checkbox. The Connect Button and the Connection Task Bar checkboxes are mutually exclusive (one or the other, not both).

The Connection Task Bar appears when the mouse cursor is moved past the bottom of the screen. When the Connection Task Bar is active it appears as shown below.



| START | connection name 1 | connection name 2 | ... | connection name n | ... | terminal name |

The connection name background indicate the connection status:

Light gray - Not Active

Dark gray - Active; but not displayed

Dark blue - Active, and currently displayed

White - Invalid connection, Edit the configuration

Click the connection name to connect/display (if not active) or to display that connection (if already active).

## **Start options:**

### **Setting**

Terminal Properties

Display Terminal Properties screen. Exit this screen when done.

Taskbar & Start Menu

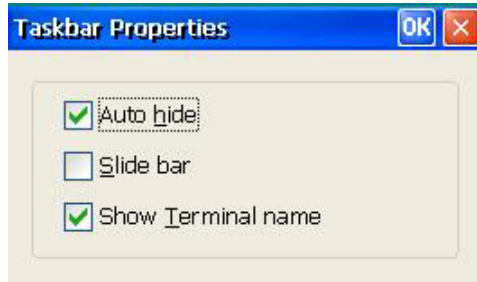

**Auto Hide:** Task bar is only shown when mouse cursor moved over bottom of the display (default). If not checked, the Taskbar is static at the bottom of the screen. To change this setting, first close all Connections.

**Slide Bar:** Task Bar scrolls up when in autohide versus instantly appearing.

**Show Terminal Name:** Display Terminal Name on the right of the Task Bar.

### **Terminal Manager**

Click to bring up the Terminal Manager screen. Exit this screen when done.

### **Shutdown**

Log Off  
Restart Terminal  
Shutdown

Note: If Security is Active and the user is not signed on as Administrator, only Shutdown and Terminal Properties are displayed when Start is clicked.



### 2.3.3 - Startup Errors

#### DHCP Error Message Box

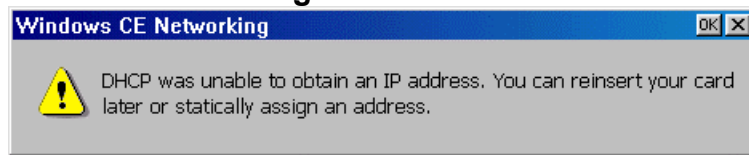

When this dialog box displays, check if the DHCP server is working properly on the network. If DHCP previously served network parameters to the terminal, they were saved and will be reused in case of a DHCP failure.

Assign a static IP address, if no DHCP server is available

## Chapter 3 - ICA Client Settings

ICA is a network protocol used by “terminal servers” running Citrix WinFrame or MetaFrame. This chapter describes how to setup a Network or Dial-In connection to such servers. Select **Citrix ICA Client connection** from the New Connection Dialog Box and select the type of connection.

### Specify Connection Type Dialog Box

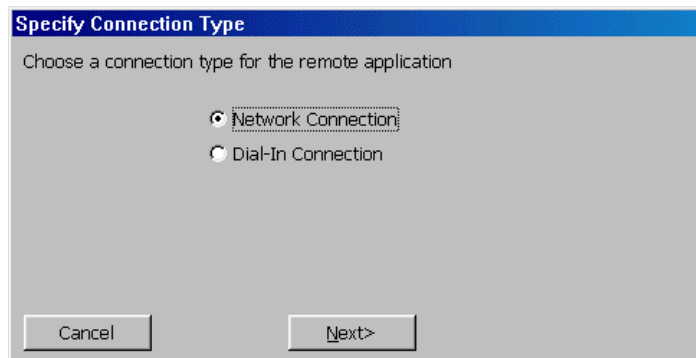

This dialog box provides two choices to connect to a Citrix server. One is Network Connection to create a network ICA connection. This type of connection requires a direct line to the network. The other one is Dial-In Connection to create a serial ICA connection.

This type of connection is made using a modem. Select one and click **Next** to continue.

## 3.1 - Network Connection

The following message will display while a search is made for Citrix servers on the network.

Searching for Citrix servers...

All Citrix servers found on your network will be listed in the next Dialog Box. If no Citrixserver is found, a message will be displayed.

### Select a Citrix Server or Published Application Dialog Box

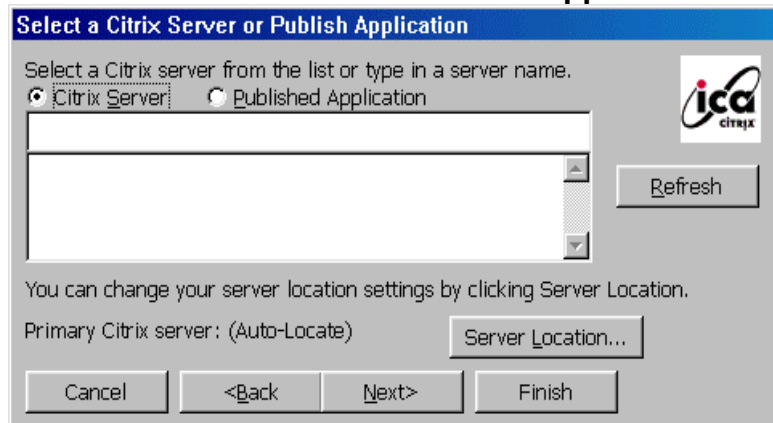

Click **Citrix Server** to connect the Windows desktop of a specific Citrix server; you can run any applications available on the desktop. Click **Published Applications** to list specific applications setup by an administrator for remote users to run. When connected, you are presented with the application itself.

Select a server or an application from the scroll list, or type an entry in the text entry field.

The **Refresh** command button refreshes the scroll list.

To connect to a server not on your local network, click **Server Location** to change your server location settings.

### Server Location Dialog Box

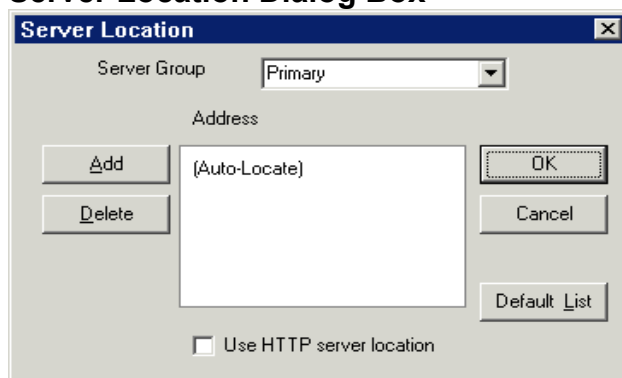

**Server Group:**

Select the group that you want to configure.

**Add:**

Click to add a server to the selected group.

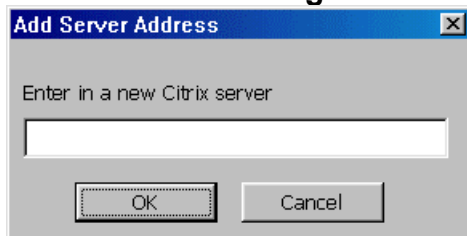
**Add Server Address Dialog Box**

Enter the DNS name of a new Citrix server or its IP address. Click **OK** to return to the Select dialog above.

**Delete:**

Click to delete the selected name in the displayed list.

**Rename Group:**

Rename the Server Group.

**Default List:**

Click to recall the previous server list.

**Use HTTP server location:**

Check this box if a firewall restricts UDP broadcasts. This option allows the client to retrieve a list of Citrix servers on the network and a list of published applications from a Citrix server that is behind the firewall.

Click **OK** to return to the Select dialog above. Then click **Next** to continue.

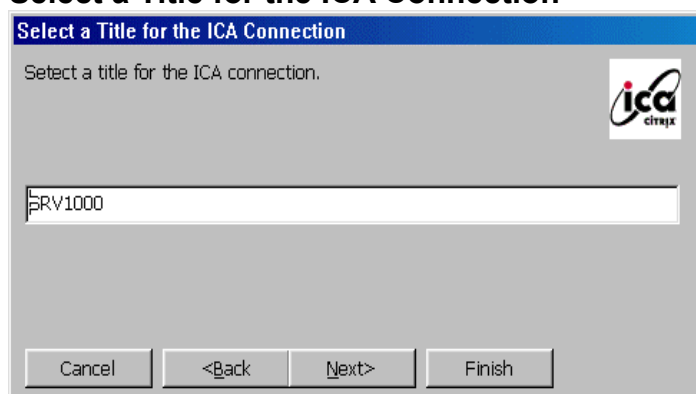
**Select a Title for the ICA Connection**

Accept the name shown or enter a name for user to identify the ICA connection and click **Next**. The new connection name will be added to the Terminal Manager dialog box.

## Specify an Application Dialog Box

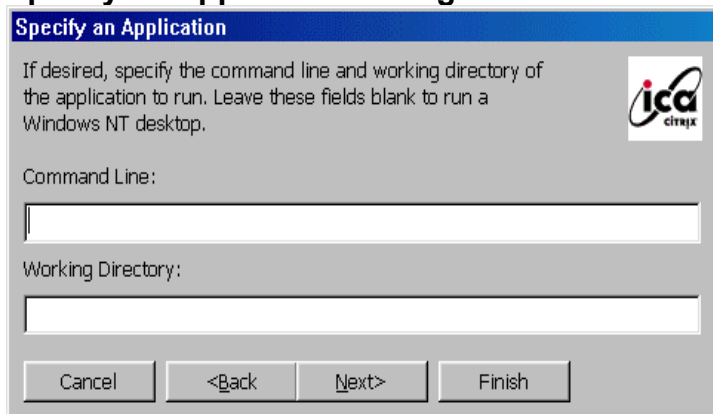

**Specify an Application**

If desired, specify the command line and working directory of the application to run. Leave these fields blank to run a Windows NT desktop.

Command Line:

Working Directory:

Cancel <Back Next> Finish

Enter the command line and directory of the application you intend to use. Click **Next**.

## Specify Logon Information Dialog Box

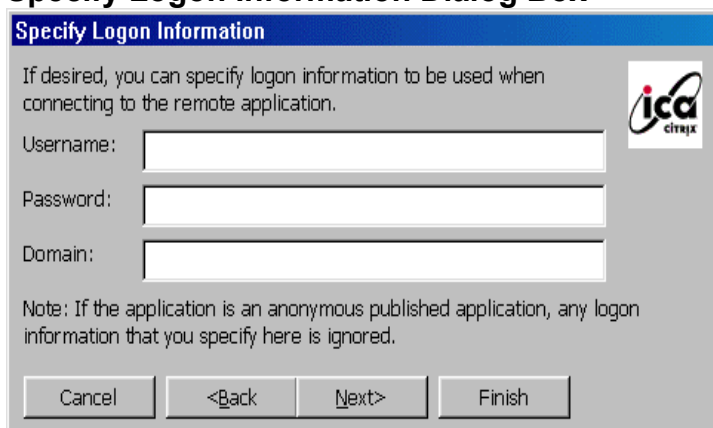

**Specify Logon Information**

If desired, you can specify logon information to be used when connecting to the remote application.

Username:

Password:

Domain:

Note: If the application is an anonymous published application, any logon information that you specify here is ignored.

Cancel <Back Next> Finish

If necessary, enter a user name, a password, and a domain name for connecting to an application. Click **Next**.

## Select Window Options Dialog Box

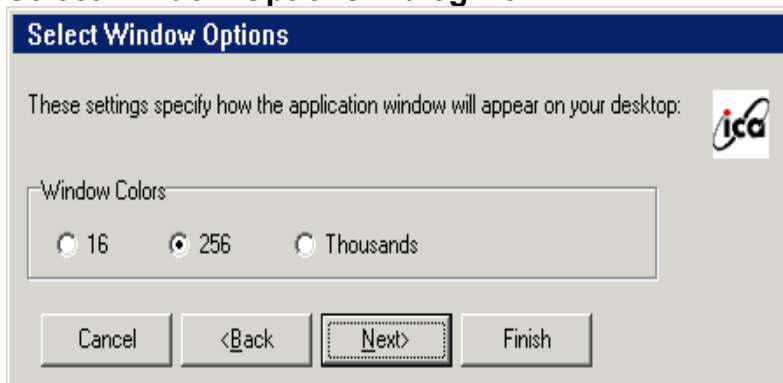

**Select Window Options**

These settings specify how the application window will appear on your desktop:

Window Colors:

16  256  Thousands

Cancel <Back Next> Finish

Click on the desired number of colors to display, either **16**, **256**, or **Thousands**. Click **Next**.

## Printing, Compression, and Sound Dialog Box

The screenshot shows a dialog box titled "Compression, Encryption and Sound". It contains the following elements:

- Use Printer Configuration Utility
- Compress Data Stream
- Enable Sound
- Sound Quality: [Dropdown menu]
- SpeedScreen: [Dropdown menu showing "Off"]
- Encryption Level: [Dropdown menu showing "Basic"]
- Buttons: Cancel, <Back, Next>, Finish

Enable or disable the following functions:

### Use Printer Configuration Utility

Check to allow use of the printer configuration utility available on the Citrix server.

Unchecking this option allows you to map printers manually.

### Compress Data Stream

Check to reduce the amount of data transferred between the OmniTerm and the Citrix server at the cost of additional processing on the server.

### Enable Sound

Check to enable sound support. From the **Sound Quality** list select **High**, **Medium** or **Low**. Low uses the least bandwidth at the expense of sound quality. High provides the best sound quality; but uses the most bandwidth.

### SpeedScreen

Select **On**, **Off**, or **Auto**. SpeedScreen attempts to improve user screen views on slow network connections.

### Encryption

Select the encryption level for the ICA connection. The default is **Basic**. Select **RC5 128-bit Login Only** to use encryption only during login. The Citrix server must be configured to allow the selected level.

Click **Next** to continue

## Firewall Settings Dialog Box

### Use alternate address through firewalls

Check this box if the client is outside a firewall that uses address translation. In this case, the client must use the alternate address returned by the master ICA Browser.

### Connect via SOCKS proxy

If the network is using a SOCKS proxy server, check this box to enable **Address of proxy to use** and Port fields. Enter the SOCKS server's IP address or DNS name. The default SOCKS port number is 1080; but may be changed.

When an existing Connection is edited, the following Dialog is displayed.

### Edit Connection Details Dialog Box

Click the tab for the property that you intend to modify.

## 3.2 - Dial-In Connection

### Dial-In Device Dialog Box

From the Dial-In Device scroll list, select one of the following:

A Modem connection such as Hayes Compatible on Com2.

A Serial connection such as Serial Cable on Com2.

Enter the area code, the phone number, and the country code in the appropriate fields.

Click on **Configure** to use the Device Properties dialog box. The **Device Properties** dialog box contains two options:

Port Settings

Call Options

These options are discussed in Port Settings (3.2.1) and Call Options (3.2.2) sections of this manual.

Click **Next** to continue (see ICA Connection and following dialogs described in section 3.1) or **Finish** to end.

If you clicked **Finish**, and the following message displays, some setup information needs to be entered for ICA Dial-in connection. Click **OK** to continue the setup of ICA dial-in connection.

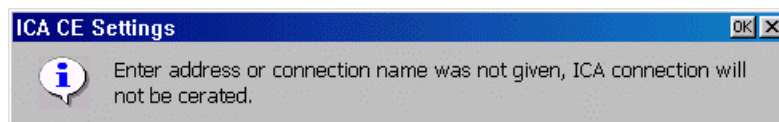

When you finish with the ICA configuration, the Terminal Manager displays the new ICA connection name.



To make a change in the ICA connection, click the Configure tab and select the ICA connection of the Terminal Manager dialog box. Then click **Edit** to change the configuration of an ICA connection.

### **Edit Connection Details Dialog Box**

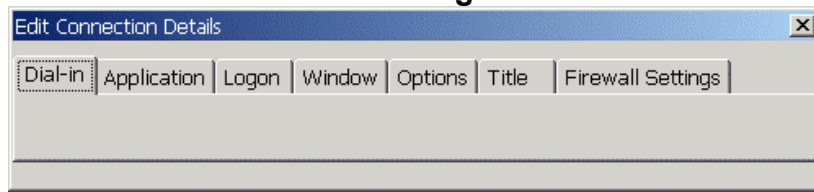

This dialog box displays when the Dial-In Connection type is specified. Choose the property that you intend to modify.

## 3.2.1 - Port Settings

### Device Properties Dialog Box (Port Settings)

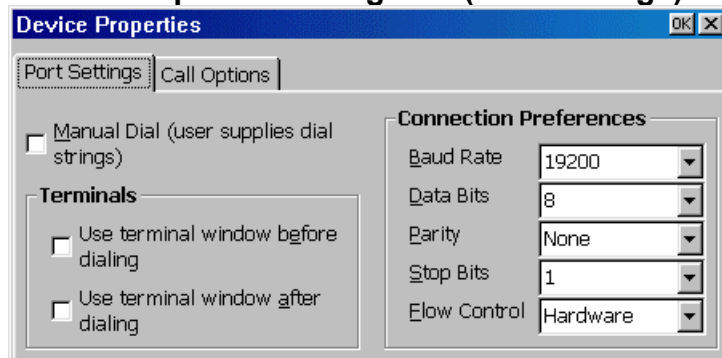

The following is the description of the functions for Port Settings properties.

#### Manual Dial

Click on this check box to set up manual dialing

#### Terminals

Use this group box to record terminal window Information:

Use Terminal Window before dialing

Use terminal Window after dialing

#### Connection Preferences

Use this group to set modem connection parameters.

Click **OK** settings are complete.

## 3.2.2 - Call Option

### Device Property Dialog Box (Call Options)

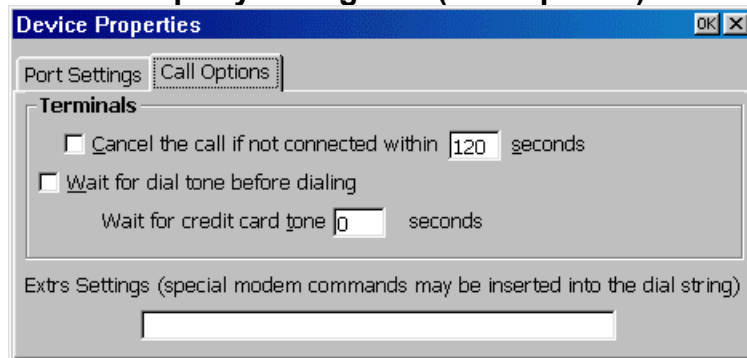

The following table discusses the functions of the Call Option property sheet.

#### Terminals

Use this group box to configure the following call parameters:

#### Cancel the call if Not connected within

Enter in this field the number of seconds to wait before a call is canceled.

The default is **120** with the function enabled.

#### Wait for Dial Tone Before Dialing

The default for this function is enabled.

#### Wait for Credit Card Tone

Enter the period (in seconds) of time to wait.

The default is 0.

#### Extra Settings

Use this field for any special modem commands that may be required by the modem manufacturer

## Chapter 4 - RDP Client Settings

If your server is Microsoft WTS (Windows Terminal Server), select **Microsoft Remote Desktop Client** (RDP) connection in the New Connection dialog box. The following four wizard dialog boxes will display in succession to configure the RDP connection. When you are finished with the wizard, the new connection will be added to the Connection Name list in the Terminal Manager dialog box.

### WTS Connection Wizard Page 1

Type a name in Name field so a user can identify this RDP connection. Enter the name/IP address of the server in Server field. Check **Low Speed Connection** if using a Dialup network connection. Click **Next** to continue.

### WTS Connection Wizard Page 2

This dialog box allows you to logon to the server automatically. Check **Automatic Logon** then enter the information in all required fields. Click **Next** to continue. If this process is skipped, you will be required to enter the logon information each time that you activate the RDP connection.

### WTS Connection Wizard Page 3

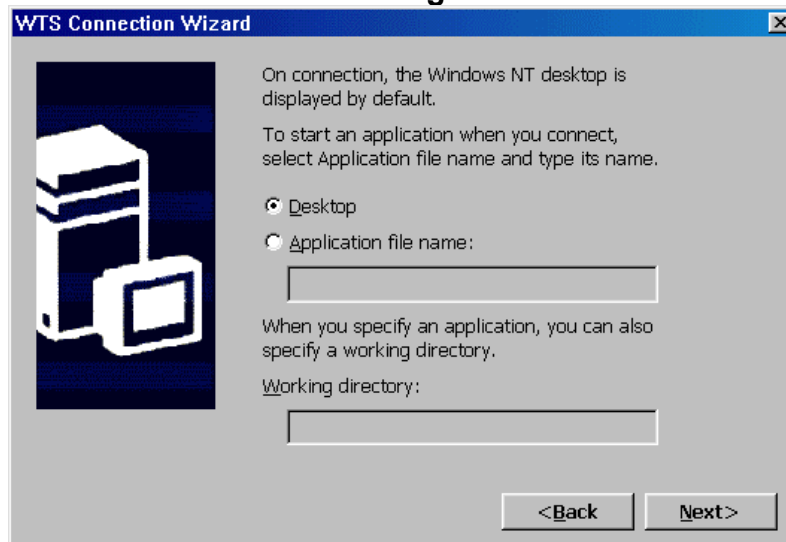

This dialog box allows you to access a desired application directly after connecting to the RDP server. The **Desktop** is the default. Click **Application File Name** to enter the name of the desired application and its working directory. Click **Next** to continue.

### WTS Connection Wizard Page 4

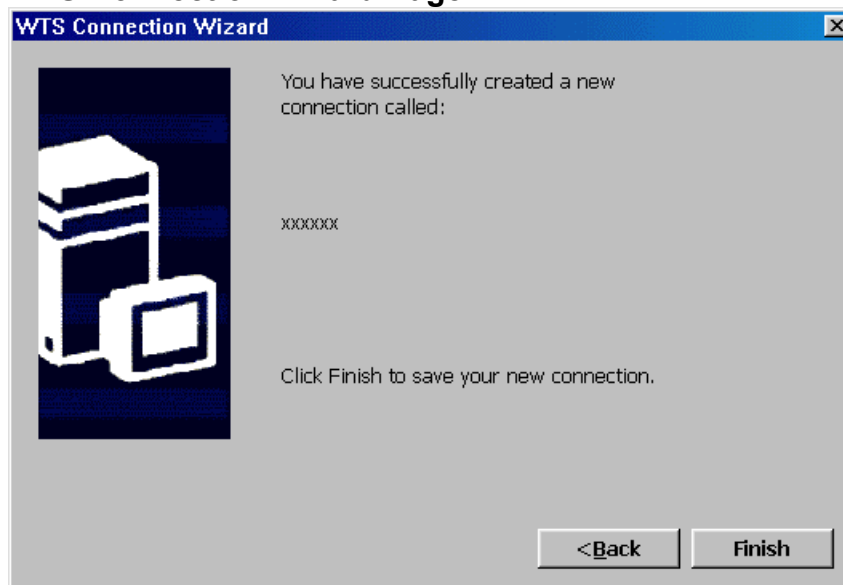

“xxxxxx” is the given RDP connection name you specified. Click **Finish** to save the new connection. The Terminal Manager will list the new RDP connection.

## Chapter 5 - Terminal Emulation Client Settings

If you select Terminal Emulation in the New Connection dialog box, the Terminal Setup Wizard will help you to complete the terminal emulation setup. Following are the dialog boxes of the wizard.

### Connection Information

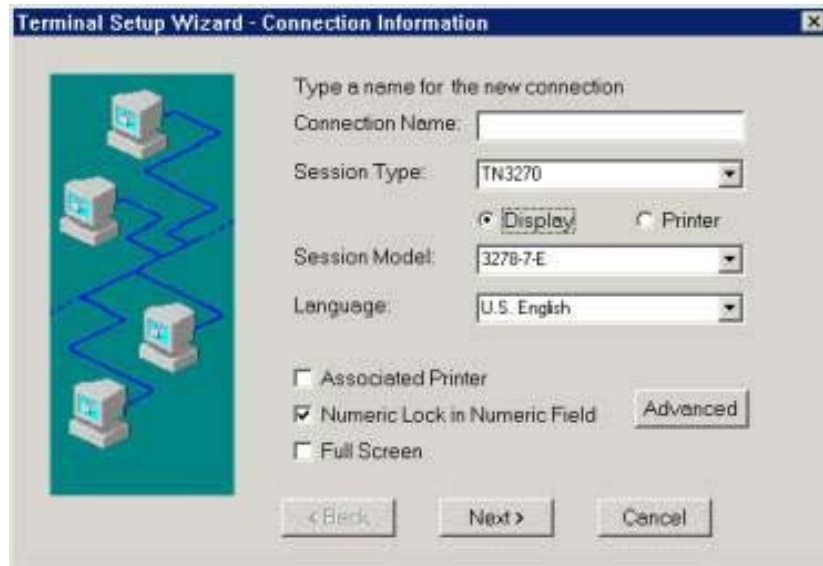

#### Connection Name:

Enter a Connection Name to identify the session. This name must be unique. It displays as the Connection Name in the Terminal Manager Dialog Box.

#### Session Type:

Select one of the Session Types (TN5250, TN3270 or ASCII).

#### Display or Printer:

Click to select either a Display or Printer session. An ASCII session type does not support a Printer session.

**Session Model:**

This item varies with Session Type and Display/Printer selected.  
See the following Table.

<b>Session Type</b>	<b>Display Models</b>	<b>Printer Models</b>
TN5250	3477-FC 3477-FG 3180-2 3197-2 3196-A2 5292-2 5291-1 5251-11	3812-1
TN3270	3278-2-E 3278-3-E 3278-4-E 3278-5-E	3287-1
ASCII	VT100 VT220 VT320 VT420 7-Bit VT420 8-Bit ANSI-BBS SCO-ANSI IBM3135-31	<NONE>

**Language:**

Select the desired language.

**Full Screen (Display only):**

Check this box to cause the emulation screen to be displayed in Full Screen mode. In this mode, the screen appears as a 'green screen' dumb terminal with input only from the keyboard (no mouse cursor). A windows Title Bar and Status Line are not shown.

**Enhanced User Interface (TN5250 Display only):**

The default state is checked which indicates normal support for such user interface features as scroll bars, select fields, field progression, enter field attributes word wrap, etc. On older emulations such as 3196, the enhanced interface is not supported and the application functions differently, which may be what the user desires. In this case uncheck this option.

*The following two check boxes are also displayed for a TN3270 display session.*

**Associated printer:**

Check this box if a TN3270 associated printer is to be defined.

**Number Lock in Numeric Fields:**

Check this box if TN3270 numeric fields can accept alpha data.

**Advanced:**

Click to show the Display or Printer EBCDIC to ASCII Translation Table. The edit procedure is to overwrite new code over old code in the Table.

**EBCDIC to ASCII Translation Table for Display**

		1st Hex Char														
		4x	5x	6x	7x	8x	9x	Ax	Bx	Cx	Dx	Ex	Fx			
2 n d	x0	20	26	2D	F8	D8	B0	B5	A2	7B	7D	5C	30	Symbol		
	x1	20	E9	2F	C9	61	6A	7E	A3	41	4A	20	31		OK	
	x2	E2	EA	C2	CA	62	6B	73	A5	42	4B	53	32			Cancel
	x3	E4	EB	C4	CB	63	6C	74	B7	43	4C	54	33			
H e x	x4	E0	E8	C0	C8	64	6D	75	83	44	4D	55	34			
	x5	E1	ED	C1	CD	65	6E	76	A7	45	4E	56	35			
	x6	E3	EE	C3	CE	66	6F	77	B6	46	4F	57	36			
	x7	E5	EF	C5	CF	67	70	78	BC	47	50	58	37			
C h a r	x8	E7	EC	C7	CC	68	71	79	BD	48	51	59	38			
	x9	F1	DF	D1	60	69	72	7A	BE	49	52	5A	39			
	xA	5B	5D	A6	3A	AB	AA	A1	AC	AD	B9	B2	B3			
	xB	2E	24	2C	23	BB	BA	BF	7C	F4	FB	D4	DB			
	xC	3C	2A	25	40	F0	E6	DD	AF	F6	FC	D6	DC			
	xD	28	29	5F	27	FD	B8	DD	A8	F2	F9	D2	D9			
	xE	2B	3B	3E	3D	FE	C6	DE	B4	F3	FA	D3	DA			
	xF	21	5E	3F	22	B1	A4	AE	3D	F5	FF	D5	20			

This table controls the EBCDIC to ASCII conversion shown on the display session. You normally do not need to modify this table. To modify the table, click on the ASCII value you want to change. You simply overwrite the default value by typing the new value. To exit this screen, click on **OK**.



## Keyboard Type Dialog Box

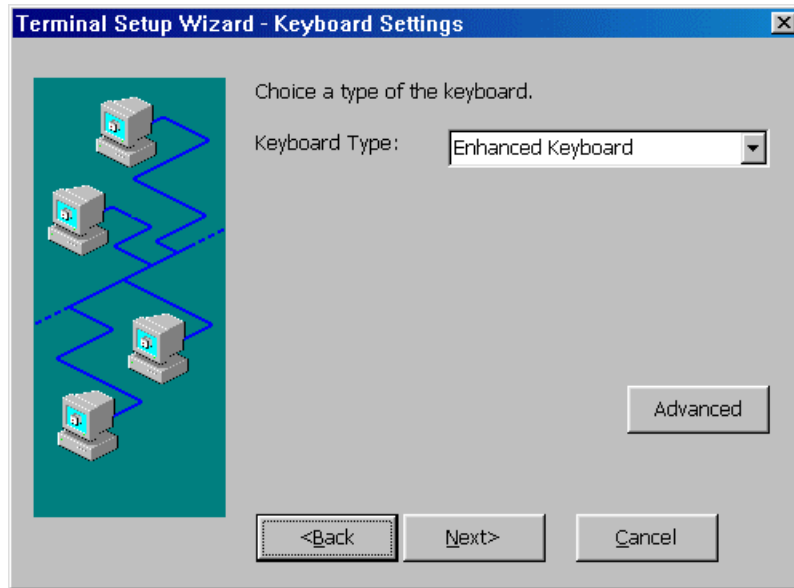

Select the Keyboard Type: Enhanced (PC style keyboard) or 122Key.

Click **Advanced** to map the keyboards as shown below. On these maps, click the key to be mapped and select/enter the desired definition. Note that these maps can also be invoked from an Emulation display screen (see Chapter 7).

### 122-Keys Keyboard Mapping for TN5250

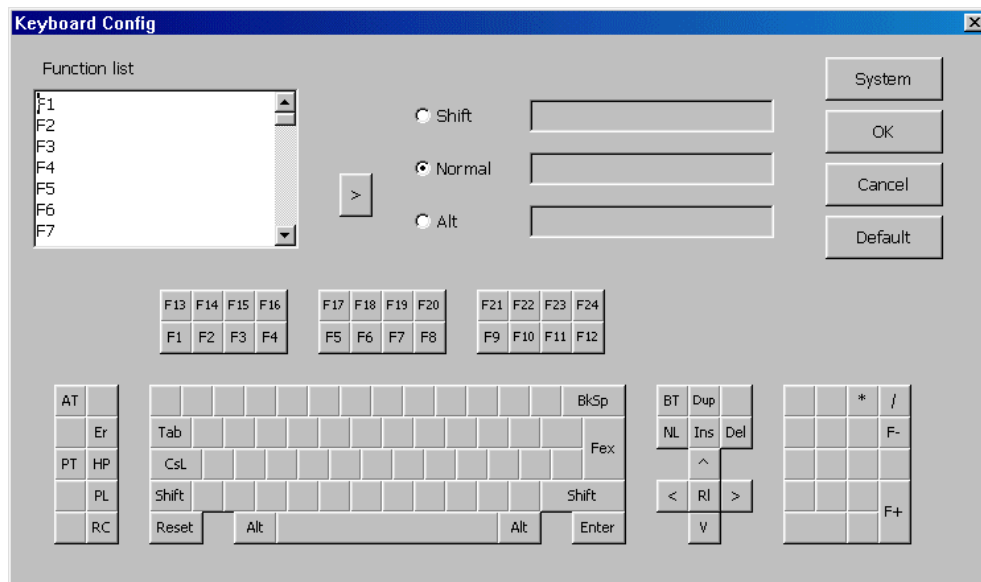

## Enhanced Keyboard Mapping for TN5250

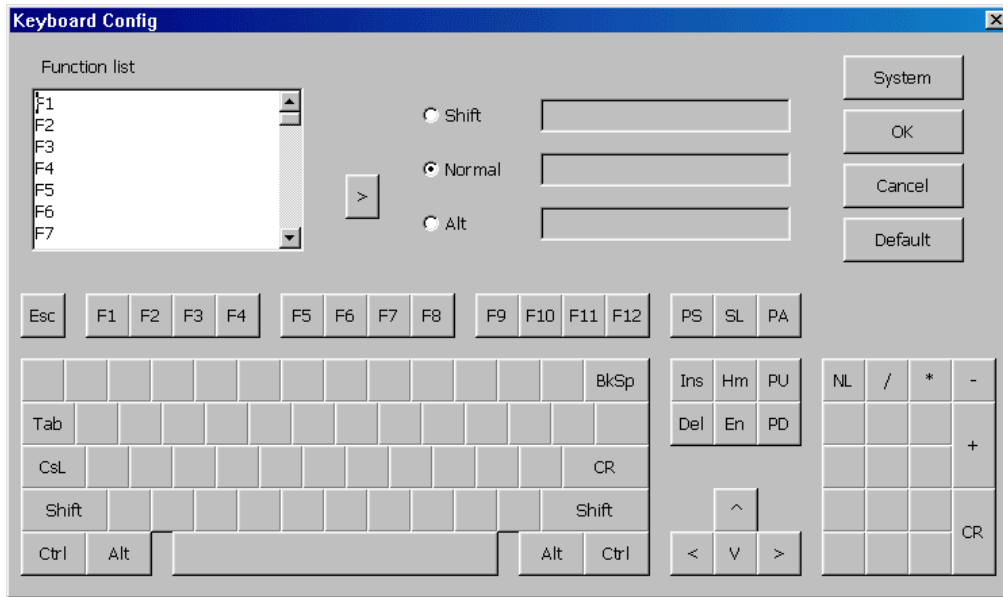

## 122-Keys Keyboard Mapping for TN3270

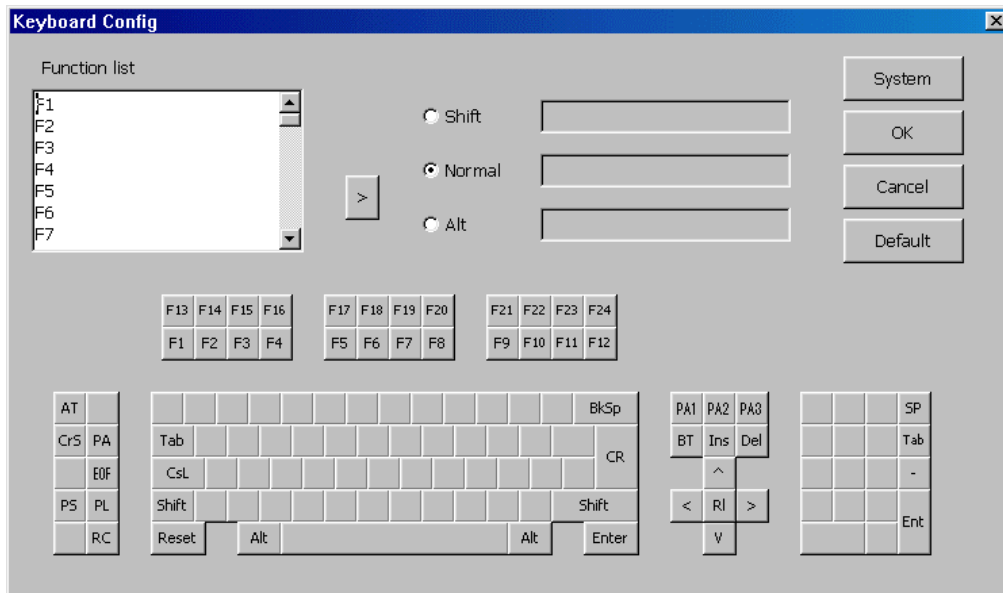

## Enhanced Keyboard Mapping for TN3270

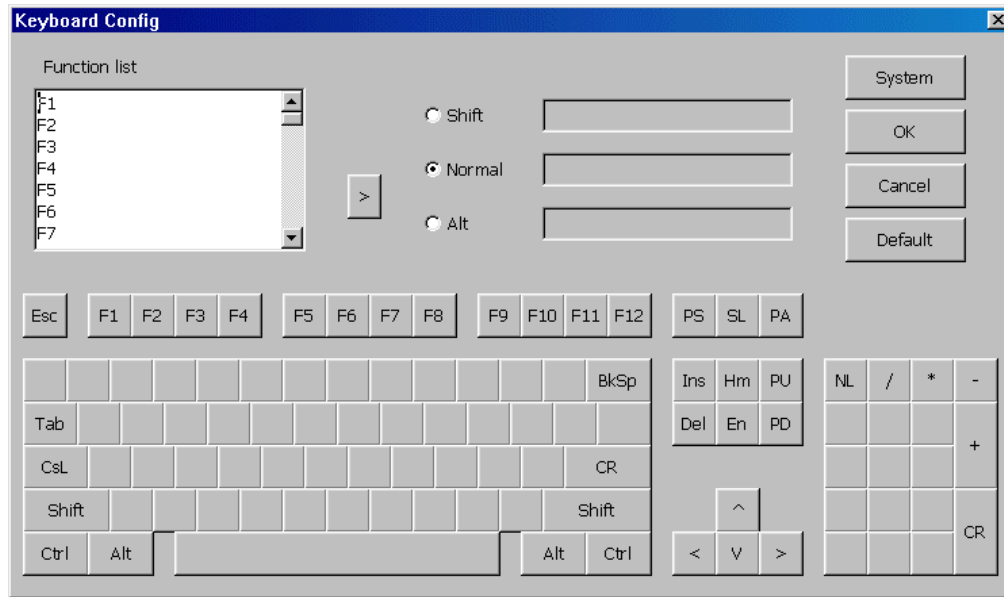

## 122-Keys Keyboard Mapping for ASCII

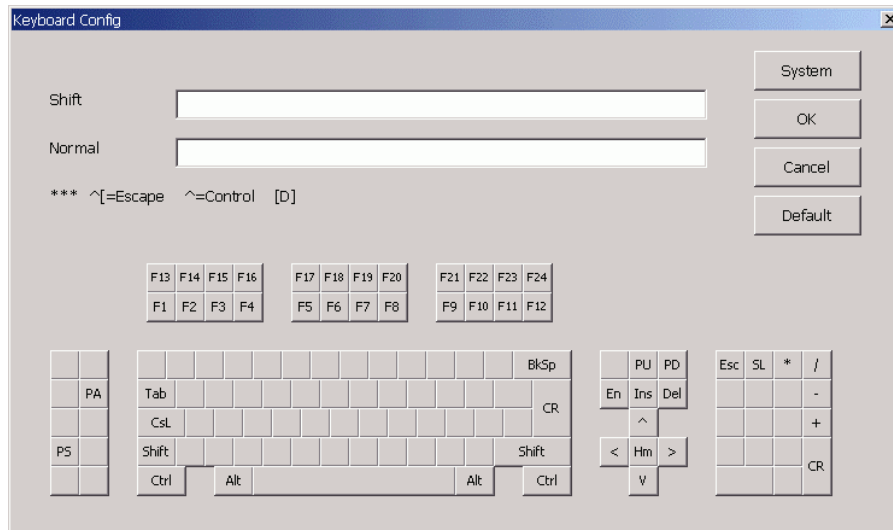

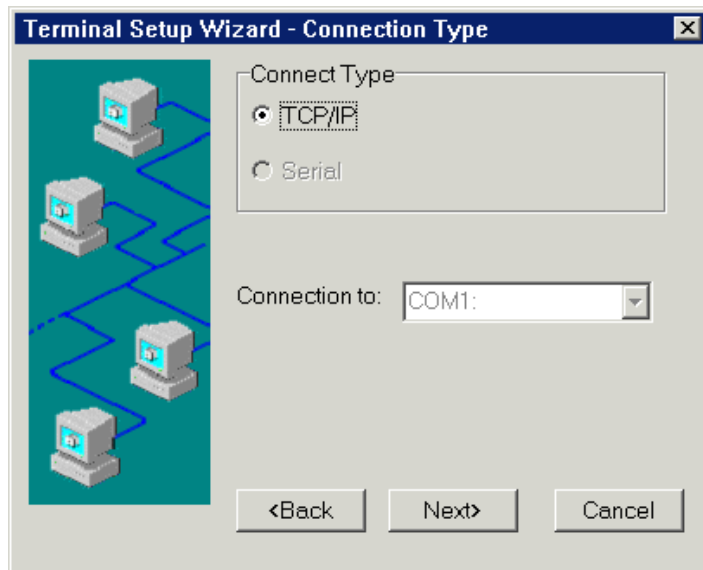

**Connection Type Dialog Box (ASCII session)****TCP/IP:**

Click this button and **Next** to use Host Settings dialog box.

**Serial:**

Click this button to enable **Connection to**. Scroll for communication port selection.

## Host Settings Dialog Box (Display Sessions)



Host Name/Address:

Port Number:

Device Name:

<Back    Next>    Cancel

### Host Name/Address:

Enter the fully qualified Domain name or static IP address.

### Port Number:

Enter TCP/IP port for Telnet on your host. The default value is port **23**.

### Device Name:

The host device name. A blank entry will cause the host to create a virtual device name. This name must be unique.

Multiple names may be entered using comma separators; e.g. NAME1,NAME2,NAME3. During connection, if a name is already in use, the next name in sequence is used. Up to five names may be specified.

### Local Echo (ASCII session only)

Check to enable Local Echo.

**Host Settings Dialog Box (TN5250 Printer Session)**

Terminal Setup Wizard - Host Settings

Host Name/Address:

Port Number:

Device Name:

Message Queue:

Library:

Font:

Form Feed:

Local Echo

Host Print Transform

<Back    Next>    Cancel

**Host Name/Address:**

Enter the fully qualified Domain name or static IP address.

**Port Number:**

Enter TCP/IP port for Telnet on your host. The default value is port **23**.

**Device Name:**

The host device name. A blank entry will cause the host to create a virtual device name. This name must be unique.

**Message Queue:**

The default value is **QSYSOPR**. (Activated only in TN5250 Printer mode)

**Library:**

The default value is **\*LIBL**. (Activated only in TN5250 Printer mode)

**Font:**

The default value is **011**. (Activated only in TN5250 Printer mode)

**Form Feed:**

The default value is **CONT**. (Activated only in TN5250 Printer mode)

**Local Echo:**

This function is activated only when an ASCII session is selected.

**Host Print Transform:**

Click this check box to use the Host Print Transform dialog box (See below). This function is activated only when TN5250 Printer mode is selected.

## Host Print Transform Dialog Box

Terminal Setup Wizard - Host Printer Transform

Printer Model: IBM 2380 Personal Printer Seri

Paper Source 1: MFRTYPMDL

paper Source 2: MFRTYPMDL

Envelope Hopper: MFRTYPMDL

Custom Object:

Custom Library:

ASCII Codepage 899 support

<Back Next> Cancel

### Printer Model:

Select your printer model. For a Customized printer object, select Other Printer and specify Custom Object name and Library below.

### Paper Source 1:

Select paper type in paper source 1. The default setting is **MFRTYPMDL**.

### Paper Source 2:

Select paper type in paper source 2. The default setting is **MFRTYPMDL**.

### Envelope Hopper:

Select Envelope size. The default setting is **MFRTYPMDL**.

### ASCII Codepage 899 support:

Click to enable this function (not recommended).

### Custom Object:

The default setting is blank.

### Custom Library:

The default setting is blank.



## Serial Connection Settings Dialog Box (ASCII)

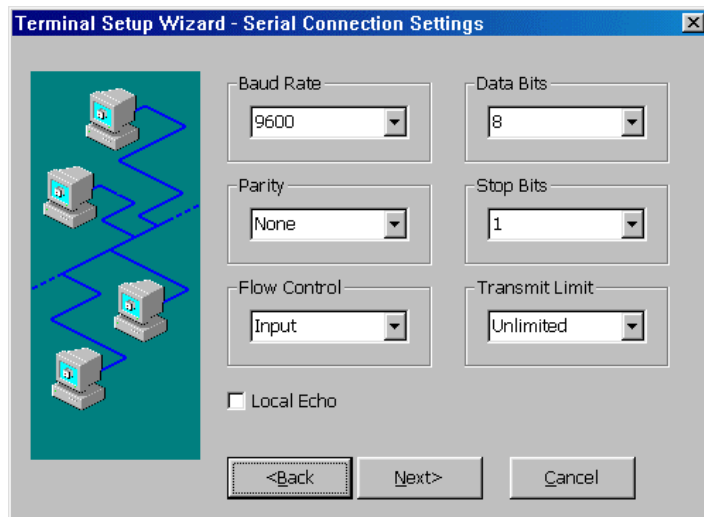

This dialog box only displays when an ASCII session and Serial connection are selected. Enter the specific value or the default will be used.

### Baud Rate:

The default value is **9600**.

### Data bits:

The default value is **8**.

### Parity:

The default value is **None**.

### Stop Bits:

The default value is **1**.

### Flow Control:

The default value is **Input**.

### Transmit Limit:

The default value is **Unlimited**.

### Local Echo:

Click to enable and by default this function is disabled.

## Printer Settings Dialog Box (TN5250)

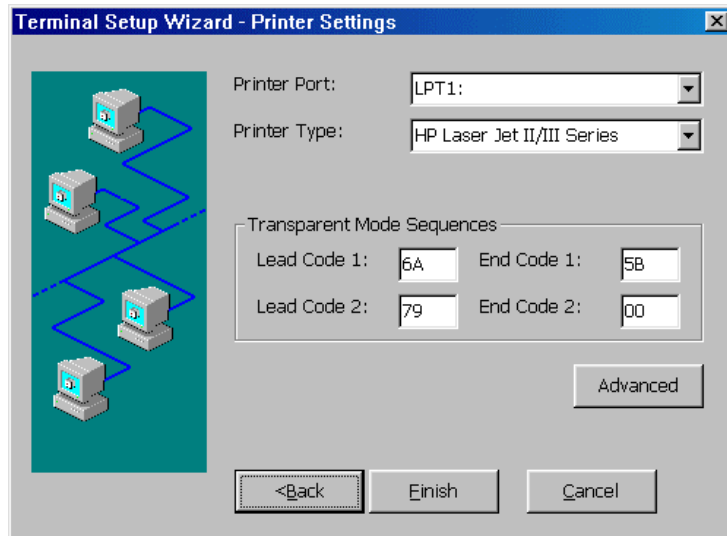

### Printer Port:

The default value is **LPT1**.

### Printer Type:

Select the desired printer from the scroll list and the default is **IBM Graphics Printer**.

### Transparent Mode Sequences:

Enter the specific value or the default will be used as followed.

Lead Code1: **6A** End Code1: **5B**

Lead Code2: **79** End Code2: **00**

If the values of lead and end codes are '00', this feature will be disabled.

Below is an example illustrating the transparent mode feature; '|-' are the lead codes and '\$' is the end code:

Given the character string

| - 1B410C\$ (Hex 6A 5F F1H C2H F4H F1H F0H C3H 5BH)

The printer emulation program will automatically remove the

Lead codes | - and End code \$

And pack every two bytes of the remaining characters into one byte

Remaining characters 1B410C (Hex F1 C2 F4 F1 F0 C3)

Packed Hex 1B 41 0C

And then send those bytes (Hex 1B 41 0C) to the printer.

### Advanced:

Click Advanced to display/Edit the printer EDCDIC-ASCII table.

**EBCDIC to ASCII Translation Table for Printer**

		4x	5x	6x	7x	8x	9x	Ax	Bx	Cx	Dx	Ex	Fx
2 n d  H e x  C h a r	x0	20	26	2D	ED	ED	F8	E6	9B	7B	7D	5C	30
	x1	20	82	2F	90	61	6A	7E	9C	41	4A	20	31
	x2	83	88	83	88	62	6B	73	9D	42	4B	53	32
	x3	84	89	8E	89	63	6C	74	9E	43	4C	54	33
	x4	85	8A	85	8A	64	6D	75	9F	44	4D	55	34
	x5	A0	A1	A0	A1	65	6E	76	20	45	4E	56	35
	x6	A6	8C	A6	8C	66	6F	77	20	46	4F	57	36
	x7	86	8B	8F	8B	67	70	78	AC	47	50	58	37
	x8	87	8D	8D	8D	68	71	79	AB	48	51	59	38
	x9	A4	E1	A5	60	69	72	7A	DB	49	52	5A	39
	xA	5B	5D	7C	3A	AE	A6	AD	AA	2D	F2	FD	DB
	xB	2E	24	2C	23	AF	A7	AB	B3	93	96	93	96
	xC	3C	2A	25	40	EB	91	DB	DB	94	81	99	9A
	xD	28	29	5F	27	F3	20	20	DB	95	97	95	97
	xE	2B	3B	3E	3D	DB	92	DB	27	A2	A3	A2	A3
	xF	21	5E	3F	22	F1	20	DB	CD	A7	98	A7	20

This table controls the EBCDIC to ASCII conversion for your printer session. You

normally do not need to modify this table. If a character is printing on your printer with the wrong ASCII value, use the printer manual to determine the ASCII HEX value of this character and that of the value you want in its place. Find the incorrect value in the table, click on the value and type in the correct value. To exit this screen, click **OK**.

**Printer Settings Dialog Box (TN3270 or ASCII)**

**Note: For TN3270, Next instead of Finish to LPD screen.**

## LPD Settings Dialog Box (TN3270)

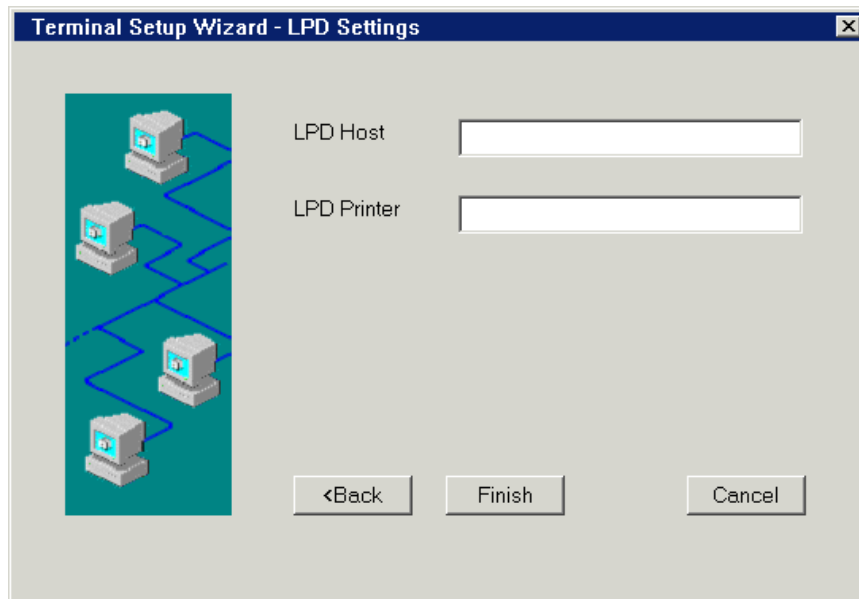

This dialog box is valid for TN3270 screen copy only. To enable this feature, enter LPD (Line Printer Daemon) Host IP address and queue name of the LPD printer in required fields.

### **LPD Host**

This field is for the IP address of an existing printer server.

### **LPD Printer**

This field is for the queue name of the LPD. The name is case sensitive.

**Note:** If either of “LPD Host” and “LPD Printer” field is null, the WBT will cause screen copy to its attached printer.

## Chapter 6 - Terminal Properties

Pressing the F2 key from the Terminal Manager dialog box allows you to examine and/or modify the terminal properties. The dialog screen is composed of a number of Tabs (property sheets). The tabs displayed may vary with the OmniTerm model or with the Security selected. Click the desired Tab to display it.

The property tabs are described in the following sections.

After clicking **OK** in the Terminal Properties dialog box, the following message box will display if any changes made require a restart of the terminal in order to take effect. Click **Restart** to restart the terminal for changes to take effect.



*Note: Press the Left Arrow key to skip the Restart.*

## 6.1 - General Tab

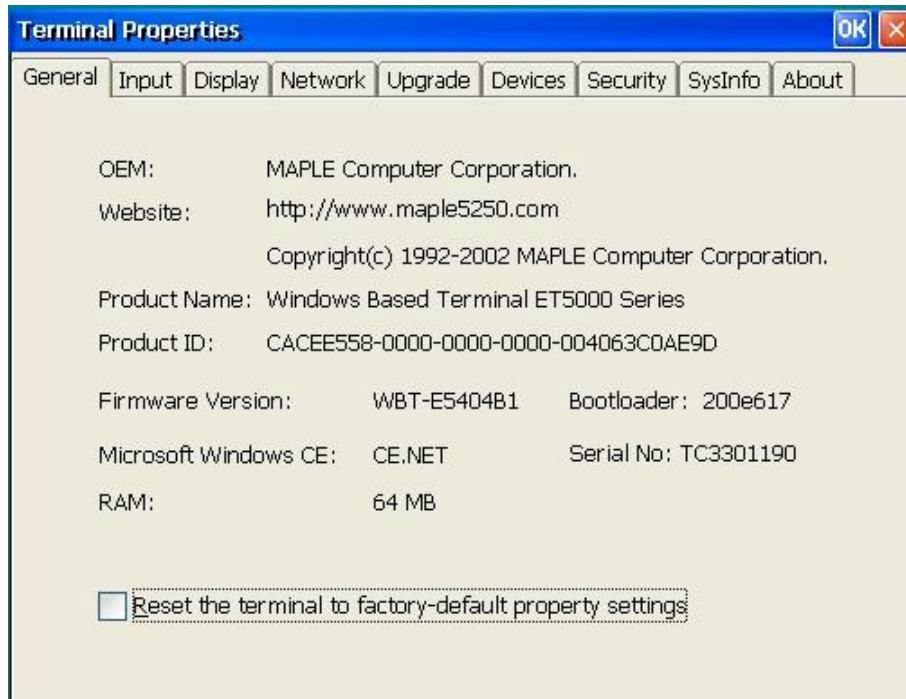

This **General** property sheet displays information that includes the name of the product and information about the current software.

To reset the terminal properties to their factory-default settings, click the check box and press Enter. The second time in sequence this is done, all connection settings (if any) will be cleared and the initial Terminal Setup sequence will be invoked (see Chapter 2).

A Serial Number may be displayed below the Bootloader display. Serial No. is displayed when that value was manually entered or loaded at the factory (units shipped 3<sup>rd</sup> Quarter of 2002 or later). The serial number along with other asset related information is displayed and stored in SNMPADM management software V2.0B1.81 or later.

*Note: The Serial Number can be manually added/edited from this screen:*

- Press **Alt+Ctrl+Shift(left)+Space** keys.
- Dialogue Box requests entry of a Serial Number
- Serial Number will display in General Tab

## 6.2 - Input Tab

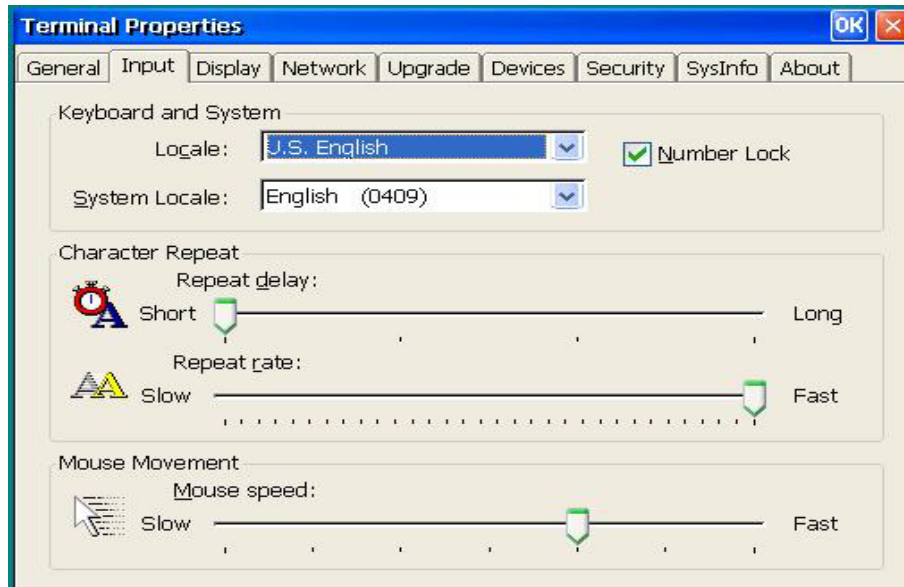

### Locale:

Scroll list and select the keyboard type.

### System Locale:

Scroll through and select the System language.

### Number Lock:

Check to enable keyboard Num Lock on system startup.

### Repeat delay:

Use this slider control to determine how quickly a key will start to repeat when held down.

### Repeat Rate:

Use this slider control to determine how quickly the same character will appear when the associated key is held down.

### Mouse Movement:

Use this slider control to determine how quickly the mouse moves on screen.

## 6.3 - Display Tab

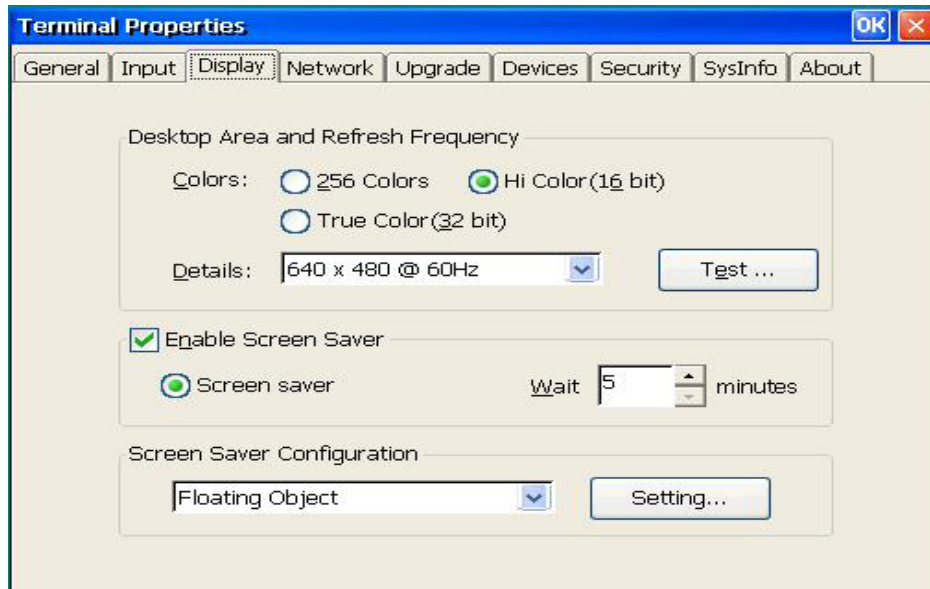

### Desktop Area and Refresh Frequency:

#### Color:

Select desired ICA color depth.

#### Details:

The scroll list displays the current terminal display resolution. Scroll and click on a selection to change resolution. The default is **640 x 480 @ 60Hz**. Always click **TEST** to verify that the resolution selected works with your monitor - a test screen is displayed for 5 seconds using the setting selected.

### Enable Screen Saver:

Click on the Screen Saver check box to make the three functions in the group box activated.

#### Screen Saver:

Click this button to enable the screen saver.

#### Wait:

Adjust the time (in minutes) that passes before the screen saver starts. You can enter your own number or use the scrolling list.

### Screen Saver Configuration:

Select the desired screen saver from the list. Click **Settings** to tailor the desired selection. For example, the 'Floating Object' can be set to be any text string of desired size.



## 6.4 - Network Tab

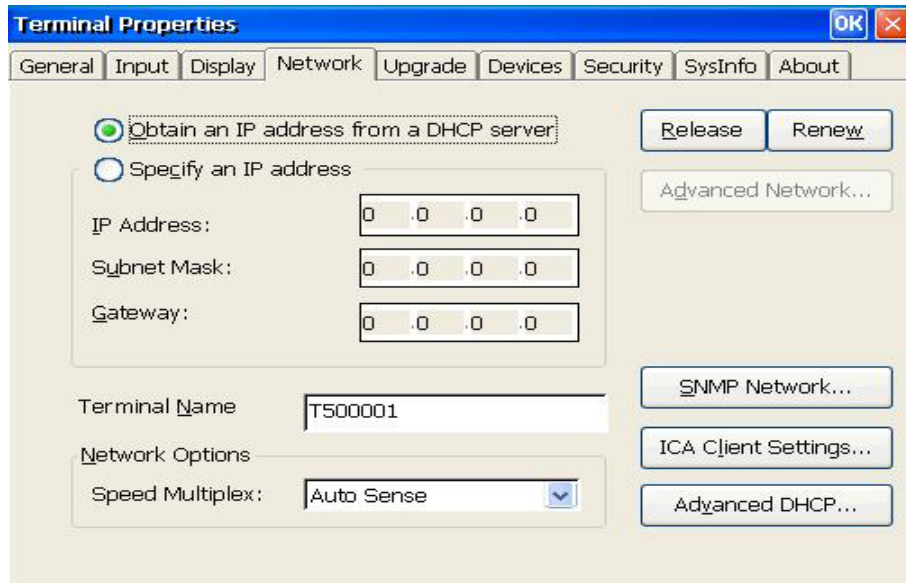

### Obtain an IP address from a DHCP server:

Click this option to enable DHCP addressing. The DHCP server will automatically assign (lease) an IP address to your terminal plus other parameters to configure the terminal. The **Release** and **Renew** buttons can be used to Release this IP address and to Renew (acquire a new) the IP address - use only when physically moving the OmniTerm to another subnet or when the IP scheme for the current subnet has changed.

### Specify an IP address:

Enter a static IP address in IP Address field. Enter the subnet mask and gateway of the IP address in Subnet Mask and Gateway fields.

### Terminal Name:

Name used by RDP connections and/or SNMP administration. Used by DHCP (send Option 12) for Device (Client) identification. The name automatically generated is 'T' plus the last 6 characters from the terminal's MAC address; e.g. For MAC=0050AC104712, Name=T104712.

### Network Option:

Select an appropriate communication speed from Speed Multiplex scrolling list. The default is Auto Sense, which automatically detects Network speed. Other options include 10 MBps Half Duplex, 10 MBps Full Duplex, 100 MBps Half Duplex and 100 MBps Full Duplex.

**Advanced Network:**

This dialog box is active only when **Specify an IP Address** is enabled.

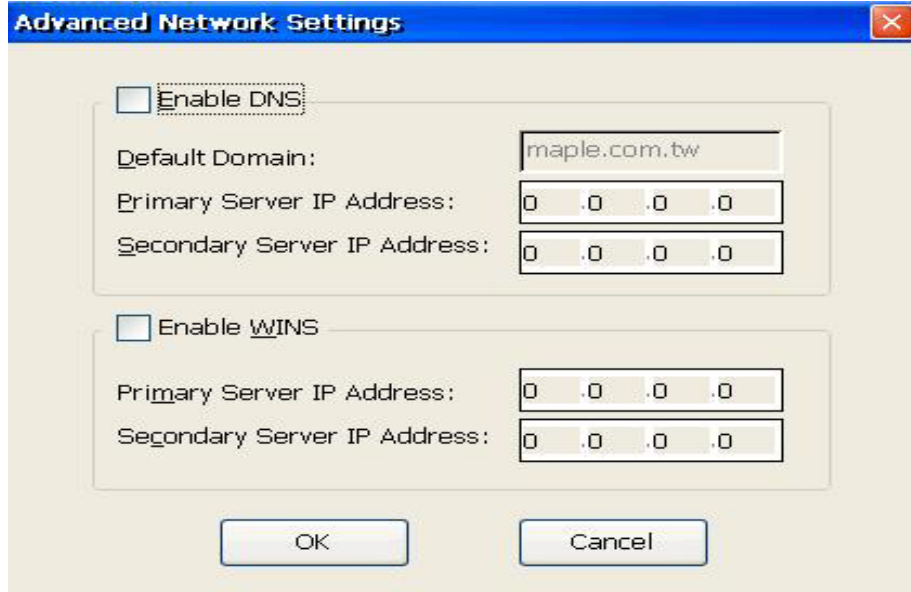

The **Advanced Network Settings** dialog box contains two main sections:

- Enable DNS:** A checkbox that is currently unchecked. Below it are fields for:
  - Default Domain:
  - Primary Server IP Address:
  - Secondary Server IP Address:
- Enable WINS:** A checkbox that is currently unchecked. Below it are fields for:
  - Primary Server IP Address:
  - Secondary Server IP Address:

At the bottom of the dialog are **OK** and **Cancel** buttons.

**Enable DNS:**

Use this group box to set domain, primary, and secondary IP addresses for DNS.

**Enable WINS:**

Use this group box to set the primary and secondary IP addresses of a WINS server.

**Advanced DHCP:**

The **Advanced DHCP** dialog box is titled "DHCP Option IDs" and contains several sections:

- Common Option IDs:** A checkbox that is unchecked. Below it are fields for:
  - Remote Server:
  - User Name:
  - Domain:
  - Password:
  - Command Line:
  - Working Directory:
- FTP Option IDs:** A checkbox that is checked. Below it are fields for:
  - File Server:
  - Root Path:
  - User Name:
  - Password:
- Keyboard Locale:**
- System Locale:**
- Terminal Name:**    
For Auto Device Naming(DHCP Option Value + Last IP)

At the bottom of the dialog are **Default**, **OK**, and **Cancel** buttons.

See Appendix B for Auto Update/Configuration DHCP options. Check both boxes to support AutoUpdate/AutoConfiguration.

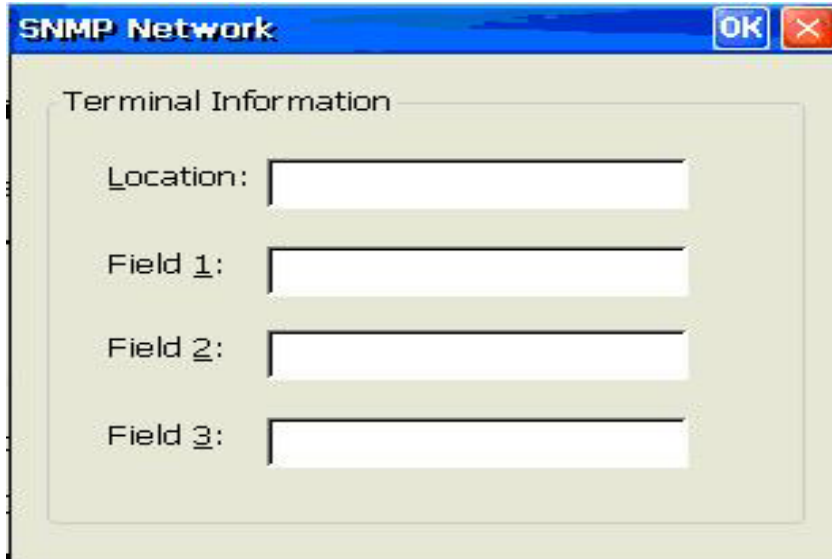
**SNMP Network:**A dialog box titled "SNMP Network" with a blue header bar containing "OK" and "X" buttons. The main area is titled "Terminal Information" and contains four input fields: "Location:", "Field 1:", "Field 2:", and "Field 3:". Each field is represented by a text label followed by a rectangular input box.

SNMP Network

Terminal Information

Location:

Field 1:

Field 2:

Field 3:

Enter custom fields that can be viewed with SNMPadm (v2.0b1.81 or higher). Typically used for ID processes.

**ICA Client Settings**

Set ICA (Citrix) settings.

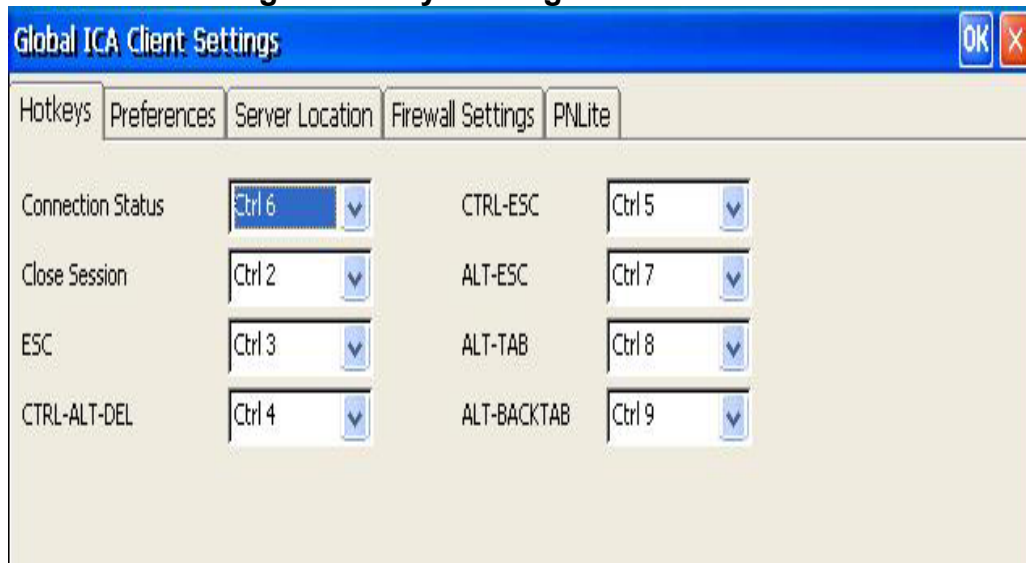
**ICA Client Settings – Hotkeys Dialog Box**

This dialog box is invoked through the **ICA Client Settings** tab found in the **Terminal Properties** dialog box. It is the default hotkeys properties sheet. To customize default hotkey key sequences, use the pull-down scroll boxes on the Hotkey properties. The following describes the function of Hotkeys.

**Status Dialog:**

Displays the ICA connection status.

**Close Session:**

Disconnects an ICA client from the server and closes the client window on the local desktop.

**Toggle Title Bar:**

Alternately hides and displays the client window title bar:

Use the title bar to drag the client window to different positions on the local desktop. Remove the title bar to maximize your workspace.

**CTRL-ALT-DEL:**

Displays the Windows NT Security dialog box.

**CTRL-ESC:**

On WinFrame servers, pressing this key sequence displays the Remote Task List.

On MetaFrame servers, pressing this key sequence displays the Windows NT Start menu.

**ALT-ESC:**

This hotkey cycles the focus through your minimized icons and opens the associated applications.

**ALT-TAB:**

This hotkey cycles through applications that have been opened. A window appears, displaying the programs as you cycle through them.

**ALT-BACKTAB:**

This hotkey sequence cycles through applications that have been opened in a session, but in the opposite direction.

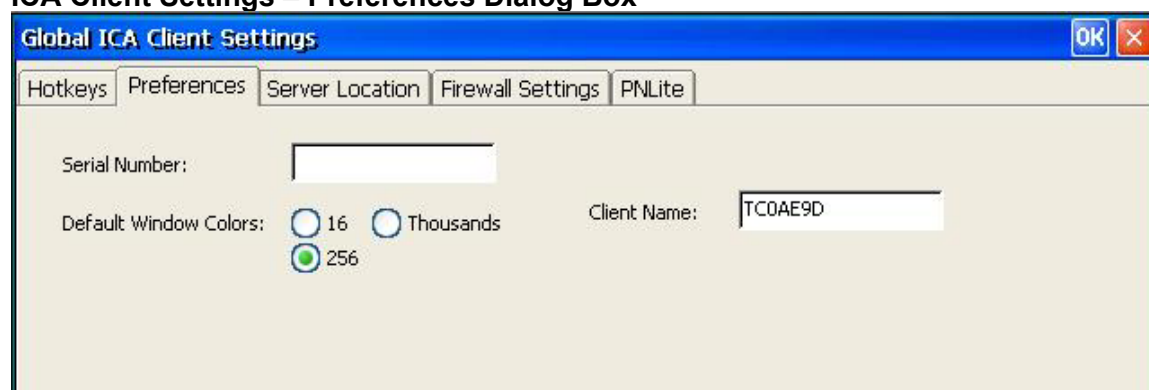
**ICA Client Settings – Preferences Dialog Box****Serial Number:**

This is the serial number of your ICA Client software. This field is only necessary when you are using the ICA Windows CE Client with a product such as WinFrame Host/Terminal, which requires each client to have a Citrix PC Client Pack serial number in order to connect to the server. If a serial number is required, you must enter it exactly as it appears on the serial number card. MetaFrame servers do not use the Serial number field.

**Default Window Colors:**

In the Window Colors field, select 16, 256, or Thousands colors. When using a PPP connection, 16 colors mode may provide better performance. If the window options specified exceed the capabilities of the client hardware, the maximum size and color depth supported by the CE operation system are used.

**Client Name:**

This text box allows you to change the client name of your device. The Citrix server uses the client name to uniquely identify resources (such as mapped printers) associated with a given client device. The client name should be unique for each computer running a copy of a Citrix ICA Client. If you do not use unique client names, device mapping and application publishing may not operate correctly.

Note: The default OmniTerm client name is the letters WBT suffixed with the devices hexadecimal MAC address.

## ICA Client Settings – Server Location Dialog Box

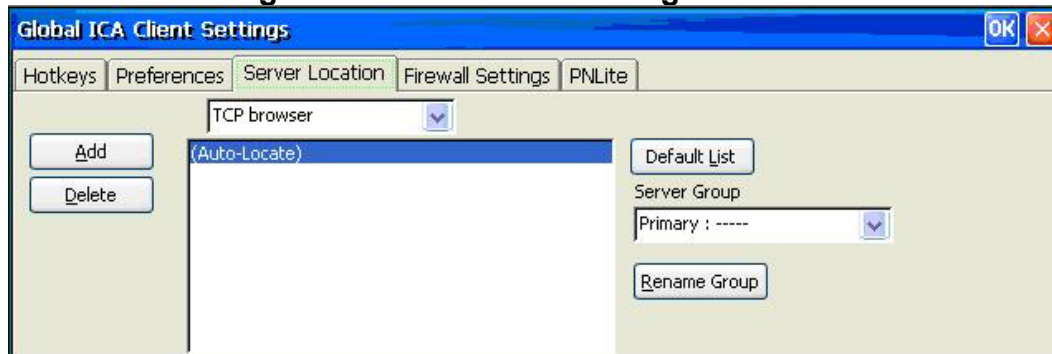

Use this dialog box to locate available Citrix (ICA) servers and published applications.

### Browser selection:

Select the desired browser type: TCP Browser, TCP+HTTP Browser, or SSL/TLS+HTTPS Browser.

### Server Group:

Select the group that you want to configure.

### Add:

Click to add a server to the selected group.

Add Server Address Dialog Box



Enter the name of a new Citrix server or its IP address. Click **OK** to return to the Select dialog above.

### Delete:

Click to delete the selected name in the displayed list.

### Rename Group:

Rename the Server Group.

### Default List:

Click to recall the previous server list.

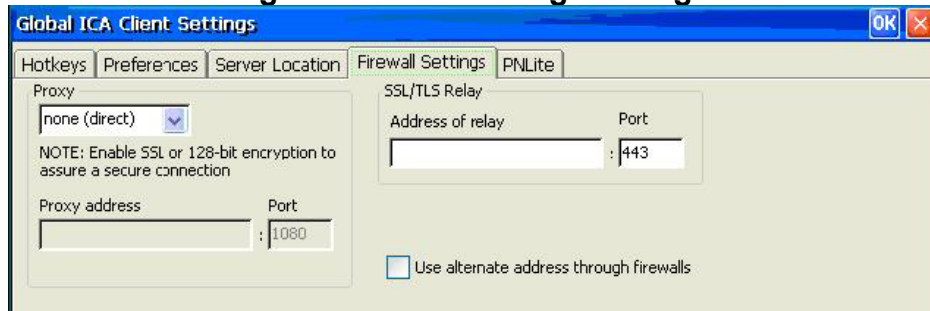
**ICA Client Settings – Firewall Settings Dialog Box****Proxy:**

Select Proxy type from the list.

**Use alternate address through firewall**

If the ICA client is outside a firewall that uses address translation, you must configure the client to use the alternate address returned by the master ICA server.

**Addresses:**

Enter IP addresses as needed.

## ICA Client Settings - PNLite Dialog Box

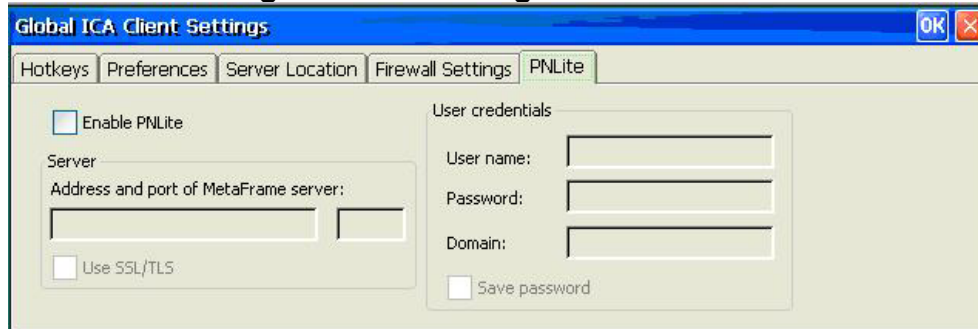

PNLite is an ICA connection mode that lets clients running CE 3 connect to Citrix server applications without having to configure connections for published applications. The names of such applications are added to the Terminal Manager Connection name list.

### Enable PNLite:

Check this box to enable the PNLite mode.

### Server:

Enter the address and port number of the Nfuse server.

### Use SSL/TLS:

Check to use Secure Socket Layer protocol.

### User Credentials:

Enter your user name, password, and domain name. Check **Save password** if you want your password to be remembered.



## 6.5 - Upgrade Tab

The screenshot shows the 'Terminal Properties' dialog box with the 'Upgrade' tab selected. The 'SNMP Manager IP' field is set to '.0 .0 .0'. The 'Manual Upgrade' checkbox is unchecked. The 'ETP Server' field contains '192 .168 .1 .32', 'Pathname' contains '/e0401', 'User name' contains 'pem', and 'Password' contains '\*\*\*\*'. An 'Upgrade Now!' button is located at the bottom of the form.

See Chapter 8 for detailed procedures.

### Manual Upgrade:

Click to setup and start a manual update of the OmniTerm firmware from an FTP server. Enter FTP server IP address and the path to the file containing the new firmware files. If the FTP server requires a User ID and Password, enter it.

Click **Upgrade Now!** to start the update.

### SNMP Manager IP:

If the terminal will be upgraded remotely using the SNMP Administrator, setting this IP address will feedback upgrade status to the administrator. This is not required.

## 6.6 - Devices Tab



Special devices are supported by special modules referenced by this Tab. Double click the desired device setup icon.

**Date/Time:** Adjust the current time and your country time zone.

**Netclock:** Get/synchronize time from SNTP servers.

**LPD:** Setup the attached printer as a network printer.

**Ping:** Ping Host by name or IP address.

**MAGTEK MSR:** Setup Magtek Magnetic Strip Reader with keyboard.

**MicroTouch Panel:** Setup a MicroTouch touch screen panel.

**NetCOM:** Setup attached serial device for access on the network.

**Printers:** Setup a local RDP printer.

**Remote Display:** Allow SNMPadm to shadow/control this terminal.

**Volume:** Set volume on terminal speakers.

**Internet Options (Browser configuration):** Configure Browser options.

**Network:** Configure network connections - Dial-Up, Direct, VPN, or PPP.



**LPD Print Server:**



If you have a printer attached to the parallel printer port, you can make this printer a network printer. In this case, given the IP address of the WBT (see SysInfo) and the Queue Name, devices on the network can print to your attached printer.

To create an LPD printer, check Enable LPD and enter a printer queue name. Port 515 is standard for LPD printing. Check Send Form Feed to cause a Form Feed between print jobs. The WBT now becomes a network print server. It can also serve itself.

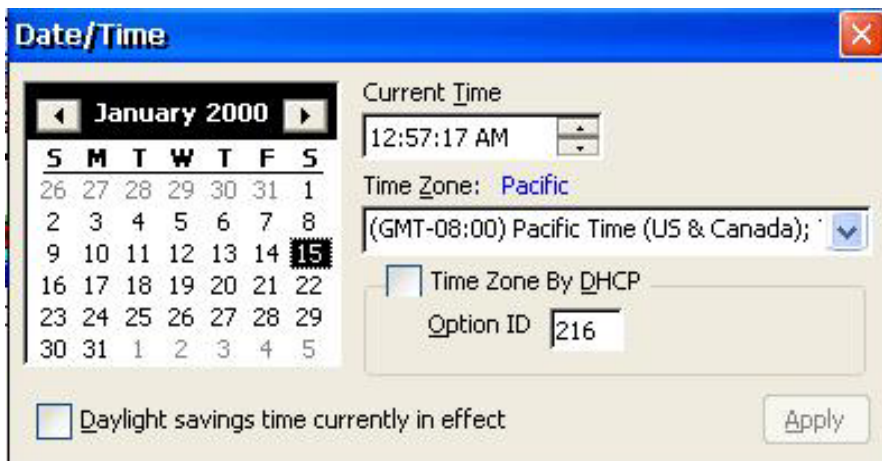
**Date/Time:**

This screen allows you to set the current time and your country time zone.

You can check **Time Zone by DHCP** to have DHCP set the Time Zone using the specified DHCP option number. This option is of type 'string'. The values are listed in the **Time Zone** list; e.g. "(GMT-08:00) Pacific Time (US & Canada)"

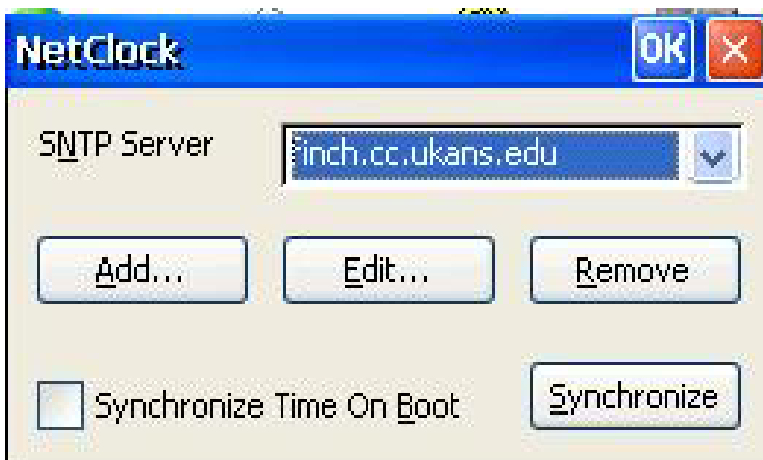
**NetClock:**

Get time from SNTP servers. You can add a new SNTP server or modify/remove any of the original SNTP servers.

Check **Synchronize Time On Boot** to automatically synchronize time when unit booted. To synchronize time NOW, click **Synchronize**.

**MAGTEK MSR:**

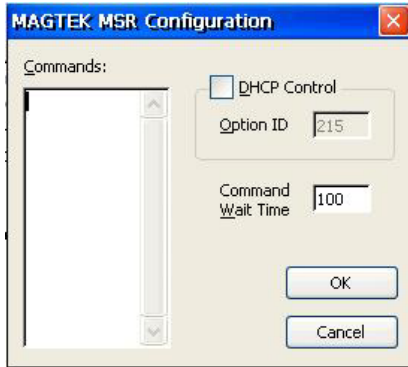

If you use a Magtek Magnetic Strip Reader with keyboard, you may set the configuration of that Reader from this screen. Refer to MAGTEK MSR manual for the complete set of configuration commands.

To setup specific tracks to be read, input the following commands:

- Track 1 data only...01381
- Track 2 data only...01384
- Track 3 data only...01390
- Track 1 and 2 data...01385
- Track 1 and 3 data...01391
- Track 2 and 3 data...01394
- Track 1, 2 and 3 data...01395 (default)

Input the command, then click OK to close the driver screen and execute the command. Open up the driver screen again, place the cursor after the command, and swipe the credit card to make sure the correct track data is coming up on the screen.



### Volume Control

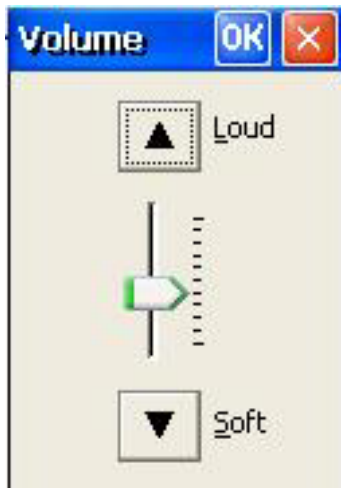

Use this control to set the volume on the terminal speakers. Click the Up or Down arrows to position pointer to desired volume level from Soft to Loud.



### MicroTouch Panel:

This device is used to setup a Touchscreen panel (Micro Touch only).

Note: All connections should be done while power is off on the base and monitor.

The Micro Touch Panel monitor you received should have had three cable connections. One for line voltage, one SVGA video connection and a DB9 female serial connection. The serial cable should be connected to the DB9 male COM port on the back of the OmniTerm terminal.

To configure, from the terminal manager screen press F2, click on the "Devices" Tab then Double click on the Micro Touch icon.

### Hardware:



### Information

Status should be OK. If Status = NOT FOUND, press **Find touchscreen**.

### Connection

Set serial port and Baud Rate. (This is normally not necessary)

Press **Find touchscreen** if Status = NOT FOUND.

If NOT FOUND status persists, the Serial cable may not be connected or there is a problem with the MicroTouch panel.

**Calibrate:**

When the **Calibrate** button is active you can click it to calibrate the touch sensitivity and screen extent. You will get a screen with crosshairs in the lower left that you will touch for calibration, then touch the crosshairs in the upper right. After you are finished touch the "Done" button that appears in the Calibrate Complete screen.

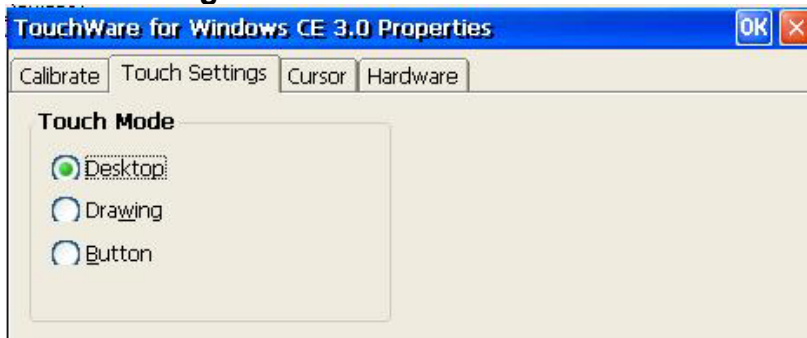
**Touch Settings:****Touch Mode**

**Desktop** - Button press and Drag & Drop enabled (Default)

**Drawing** - Disable Button Press; enable Drag & Drop

**Button** - Enable Button Press; disable Drag & Drop

**Cursor:****Cursor Offset**

You can set the distance between your fingertip and the pointer tip.

Select **Vertical** and/or **Horizontal Edge Adjust** then press **Set**. The following graphic allows you to select Vertical Offset (Top = None, Bottom = Maximum) and Horizontal Adjust (Center = none).

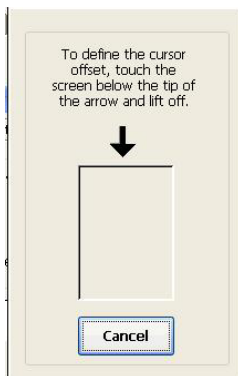
**Stabilize Cursor (Not used)**

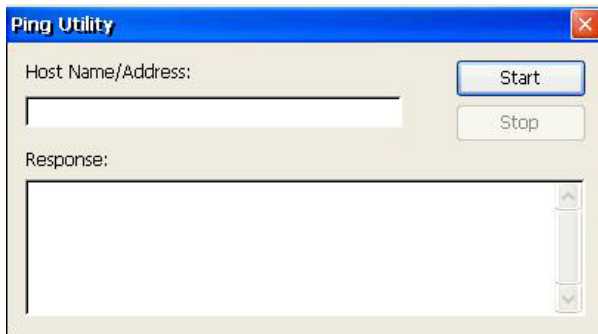

**Ping:**

Enter Host name or IP address to ping. Click **Start** to ping the Host.  
A series of Pings will be sent to the Host.  
Click **Stop** button to end the process.

**Remote Display:**

Check **Enable Remote Display** to allow a SNMPadm administrator to shadow the user of this terminal.

**NetCOM:**

When enabled, another device on the network (using TELNET) can talk to a serial device (e.g. HyperTerminal) attached (null modem cable) to the OmniTerm com port. The SerialID type device is addressed on the network by the OmniTerm's IP address and Port 6515; e.g. OPEN 192.168.2.219 6515. Set mode to send CRLF (Carriage Return & Line Feed) when Enter is pressed (e.g. SET CRLF).

SerialID commands OPEN, WRITE, READ and CLOSE are described below.

**OPEN comport,baudrate,parity,databits,stopbits,handshake**

Comport: COM1, COM2  
 Baudrate: 2400, 4800, 9600, 19200, 38400, 57600  
 Parity: N(none), O(odd), E(even), M(mark), S(space)  
 Data bits: 5,6,7,8  
 Stop bits: 1,1.5,2  
 Handshake: N(none, default), X(Xon/Xoff), H(RTS/CTS)

Example: OPEN COM1,9600,N,8,1,N

**WRITE number of chars<CRLF>n chars**

Example: WRITE 5<Enter>12345

**READ**

Return >=0 if data available

Example: READ / ret 0 (no data)

READ / receive 5 / receive 12345

**CLOSE**

Close open port

All function will receive a return value:  
if value  $\geq 0$ , successful  
If value  $< 0$ , an error occurred

#### Error number list

Open:	Close:
-1 -> open port failed	-4 -> port not open
-2 -> server busy	0 -> OK
-3 -> parameter error	
0 -> OK	
Write:	Read:
-4 -> port not open	-4 -> port not open
-6 -> timeout	n -> n characters read
0 -> OK	



## Printers (RDP printer):

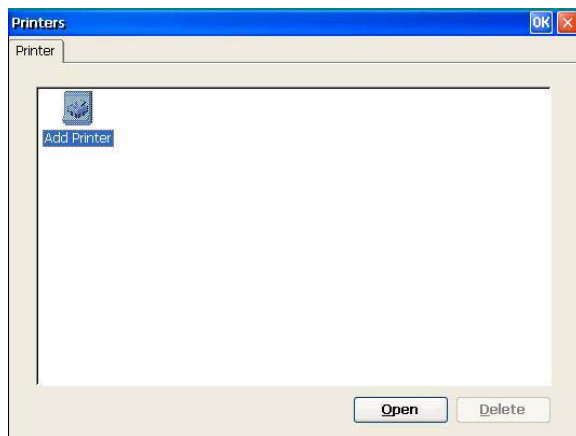

This dialog box allows you to setup and/or delete a Local RDP Printer.

To delete an existing printer definition, click that icon to highlight and click the **Delete** button. To setup a new local printer, double click the **Add Printer** icon or click **Open**.

### Add Printer:

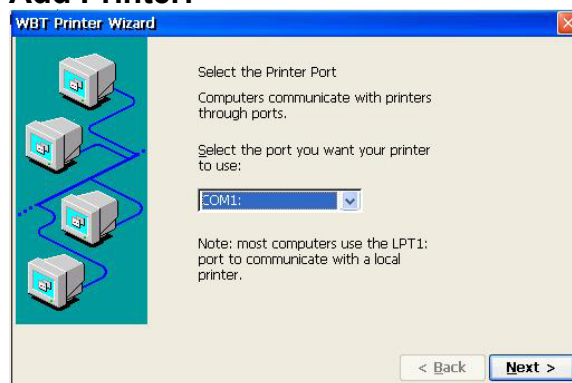

Select printer port: **LPT1**, **COM1**, or **Network**. Click **Next** to continue.

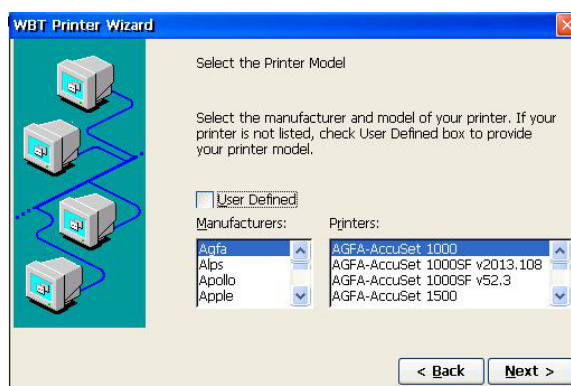

Select the manufacturer of your printer from the **Manufacturers** list. Then, choose the desired printer model from the **Printers** list.

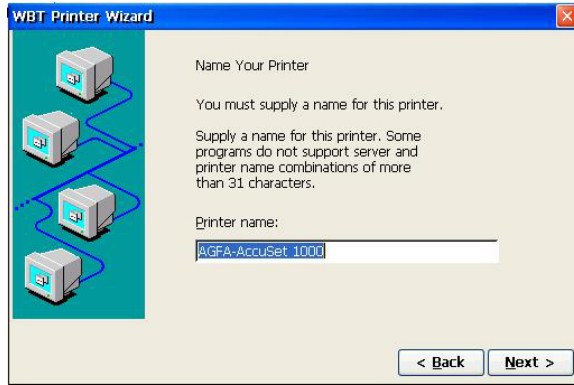

Enter a 'friendly' name for the printer.

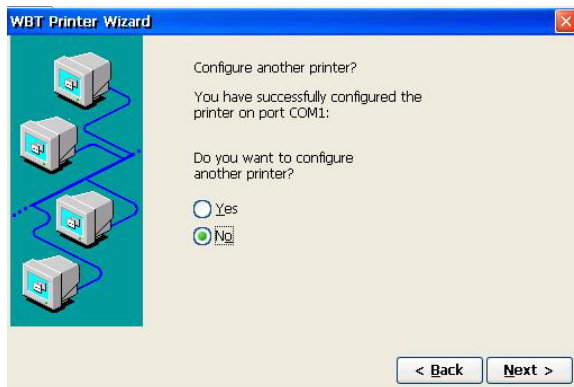



## Internet Options:

### General:



Define **Start** and **Search pages**. If desired, **Clear Cache** memory and or **Clear History** (saved entered addresses). You can also change **Cache Size**.

### Connection:



If your internet connection uses a proxy server, set its address (name or IP) and the port number used.

### Security:

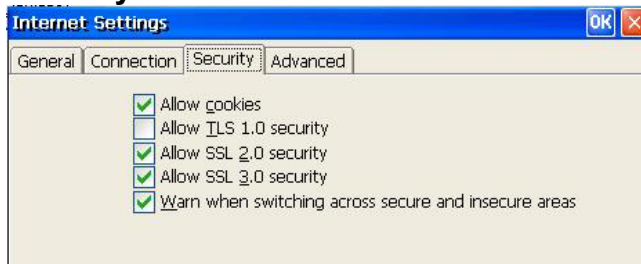

Select security options.

### Advanced:



Set page display options.



## Network:

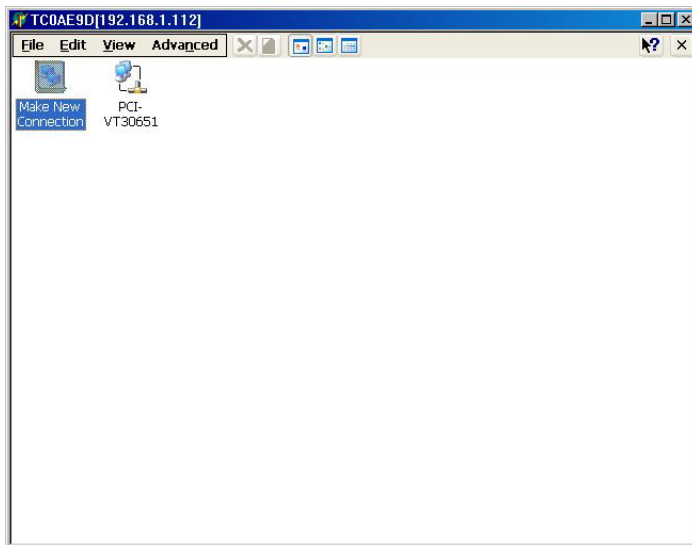

To configure a wireless connection on an OmniTerm, double click CISCO and refer to Chapter 10 for detailed procedures.

To review/change the built in Ethernet network settings, double click the icon labeled PCI-xxxxxxx. To start other connections, double click the appropriate icon.

When multiple connections exist, you can use the Advanced Settings under the Advanced menu to set the order in which the connections are accessed by network services.



To create a new network connection, double click **Make New Connection**.

## Make New Connection Properties Sheet



Name and select connection type.

### Dial-Up Connection:

Establish Dial-Up connection to RAS (Remote Access Server) using PPP (Point to Point protocol).

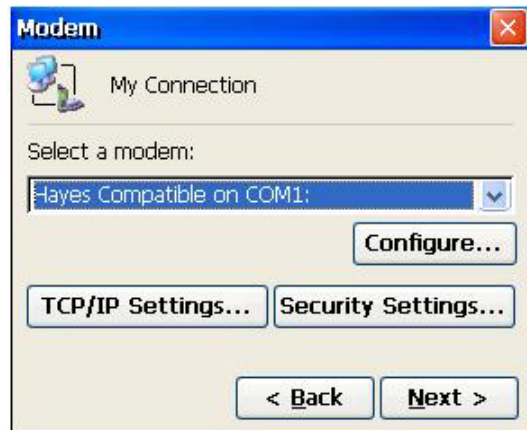

### Configure...

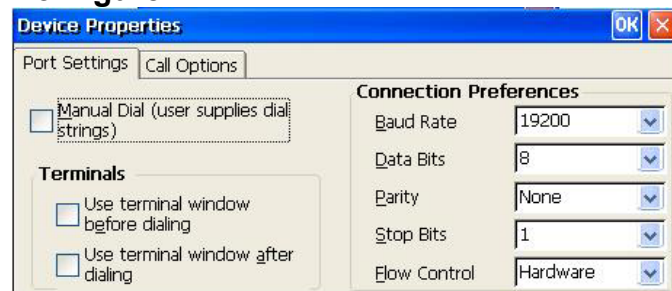



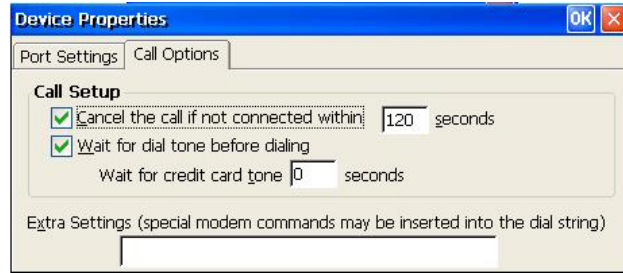

### TCP/IP Settings ...

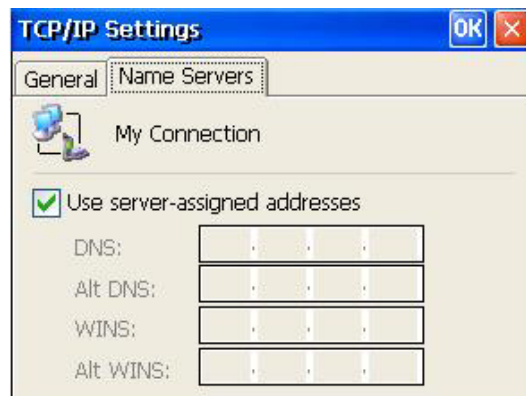

### Security Settings ...



Next >



The 'Phone Number' dialog box is titled 'Phone Number' and contains a sub-header 'My Connection'. It features three input fields: 'Country/region code' with a dropdown menu, 'Area code' with the value '425', and 'Phone number' with an empty text box. Below these fields are two checkboxes: 'Force long distance' and 'Force local', both of which are unchecked. At the bottom of the dialog are two buttons: '< Back' and 'Finish'.

Enter a phone number. Click **Finish** to create the connection.

Double click the created icon to enter sign on data and start the connection.

**Direct Connection:**



The 'Device' dialog box is titled 'Device' and contains a sub-header 'My Connection'. It features a 'Select a device:' label above a dropdown menu showing 'Serial Cable on COM1:'. Below the dropdown is a 'Configure...' button. Further down are two buttons: 'TCP/IP Settings...' and 'Security Settings...'. At the bottom of the dialog are two buttons: '< Back' and 'Finish'.

See **Dial-Up Connection** for Configure, TCP/IP, and Security screens.

**Virtual Private Network:**

Enter name or IP address of the VPN server for the network to which you want to connect.

**TCP/IP Settings ...****Security Settings ...**

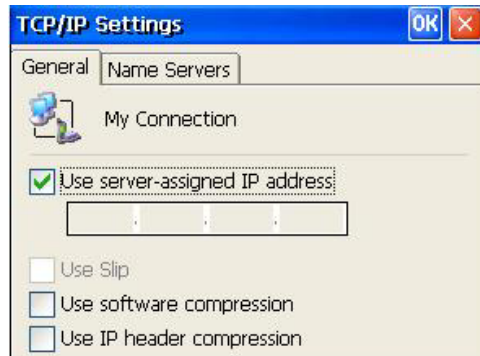
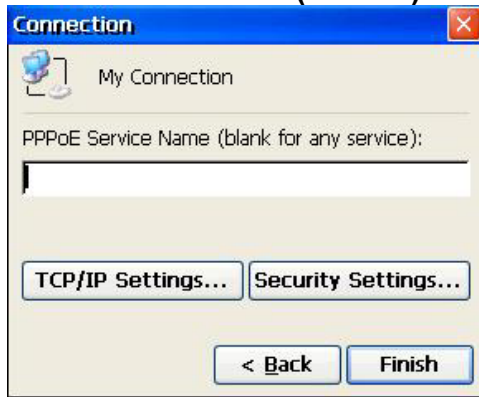
**PPP over Ethernet (PPPoE):****Security Settings ...**

## 6.7 - Security Tab

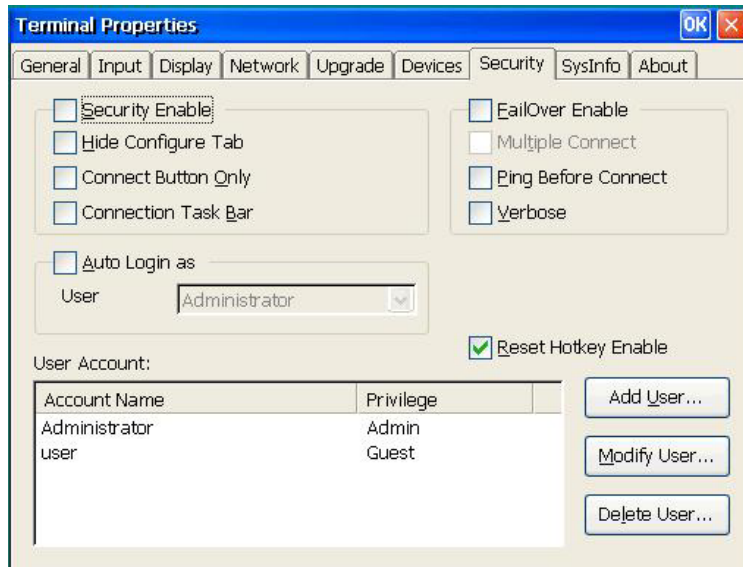

With first time security setup, there is always an Administrator in the User Account field. This Administrator account is of Admin privilege and cannot be removed.

### Security Enable:

Click to enable security function. This makes the WBT a multiple user version based on authorized privileges. A user login will be requested, unless **Auto Login** is also specified (see below). Disabling security makes the WBT accessible without a login.

### Hide Configure Tab:

Hide the Configure Tab in Terminal Manager Dialog Box. If Security is enabled, this check box is disabled - the Configure Tab will be hidden unless signed on as Administrator.

### Connect Button only:

A Connect Button (see chapter 2.3) is displayed after terminal power on instead of the Terminal Manager screen. The user will not have direct access to the Terminal Manager or Properties screens. All connections (not just those set for AutoStart) will be started for the user when the button is clicked. If Security is enabled and user is not the Administrator, only those connections set to start will be started.

### Connection Task Bar:

Use the Connection Task Bar (see chapter 2.3) in place of the Terminal Manager Screen. The checkbox is mutually exclusive with that for the Connect Button.

### Auto Login as:

Click to enable WBT automatic login as the selected user account in the User Name list. **Security Enable** should also be checked or Auto Login will be ignored.

### Add User:

Add a new user account and setup the user's privilege, password and accessible connections.

**Modify User:**

Modify the selected user's properties, including password, privilege, and accessible connections.

**Delete User:**

Delete the selected user account. It will show a delete confirmation message box.

**User Properties – Administrator Dialog Box**

The dialog box is titled "User Properties" and contains the following elements:

- Enable Password Change
- User Name:
- Password:
- Confirm Password:
- Account Privilege:
  - Administrator
  - User
  - Guest
- Available Connections:
 

Available Connections	Type
maple	RDP
Default RDP	RDP
Web1	Web
Default ICA	ICA
xcvbxcvb	ICA
NT2000	ICA
maple	EMU
- Assigned Connections:
  - Assign >
  - < Unassign
  - Toggle AutoStart >
  - Users of Administrator privilege can use all connections.
- Buttons: OK, Cancel

WBT Administrators can add/modify user accounts with this dialog box:

**Enable Password Change:**

This group enables Administrator to add new User Name and Password; or modify current User Name and Password.

**Account Privilege:**

Administrator can set privilege of the user to be Administrator, User, or Guest.

**Available Connections:**

The currently available connections of WBT will automatically display in this Available Connections item for Administrator's assignment.

**Assign:**

Click it to assign selected connections from the list of Available Connections group.

**Unassign:**

Click it to unassign selected connections from the list of Assigned Connections group.

**Assigned Connections:**

The usable connections will display in this item.

**Toggle AutoStart:**

Set selected Assigned Connections to automatically startup after successful login.

There are three privilege levels for users of WBT: Administrator, User and Guest. According to the privilege, WBT setup provides different functions:

<b>Account Privilege</b>	<b>Administrator</b>	<b>User</b>	<b>Guest</b>
Hide/Show Configure in Terminal Manager	Hide/Show	Hide	Hide
<b>Tabs in Terminal Properties</b>			
General	V	V/(Disable Reset)	V/(Disable Reset)
Input	V	V	V
Display	V	V	V
Network	V		
Printers	V	V	
Upgrade	V		
Devices	V	V	V
Security	V		
SysInfo	V	V	V
About	V	V	V

### User Properties – User Dialog Box

The screenshot shows the 'User Properties' dialog box. It features a title bar with the text 'User Properties' and a close button. The main area is divided into several sections:

- Enable Password Change:** A checkbox is checked. Below it are three text input fields labeled 'User Name:', 'Password:', and 'Confirm Password:'.
- Account Privilege:** Three radio buttons are present: 'Administrator', 'User' (which is selected and highlighted with a green circle), and 'Guest'.
- Available Connections:** A table with two columns: 'Available Connections' and 'Type'. The entries are:
 

Available Connections	Type
maple	RDP
Default RDP	RDP
Web1	Web
Default ICA	ICA
xcvbxcvb	ICA
NT2000	ICA
maple	EMU
- Assigned Connections:** A table with three columns: 'Connections', 'Type', and 'AutoStart'. This table is currently empty.

Navigation buttons include 'Assign >', '< Unassign', and 'Toggle AutoStart >'. At the bottom of the dialog are 'OK' and 'Cancel' buttons.

When **User** is selected in Account Privilege group, this dialogue will display. See Table above for the available functions with User privilege.

## User Properties – Guest Dialog Box

Enable Password Change

User Name:

Password:

Confirm Password:

Account Privilege

Administrator

User

Guest

Available Connections:

Available Connections	Type
maple	RDP
Default RDP	RDP
Web1	Web
Default ICA	ICA
xcvbxcvb	ICA
NT2000	ICA
maple	EMU

Assigned Connections:

Connections	Type	AutoStart

Assign >

< Unassign

Toggle AutoStart >

OK Cancel

When **Guest** is selected in Account Privilege group, this dialogue will display. See Table above for the available functions with Guest privilege.

### Reset HotKey Enable:

Click to enable the **Ctrl+Tab+Delete+F12** key sequence at the Terminal Manager or Connect Button screens. This key sequence displays a "Reset to factory default" message box - Click Yes to reset or No to cancel the reset.



**FailOver Enable:**

Failover is an attempt to provide continuous availability of network application by automatically switching to another server when the primary server fails or cannot be started. For example: If enabled and the primary RDP/ICA server fails, the connection will be ended; then on reconnect, connection to another configured RDP/ICA server is automatically attempted to provide continuous availability to the user.

If a connection cannot be started (manual or automatic), an attempt is made to start the next non-active connection. Next is in alphabetic order by connection name.

Already active connections are skipped.

When FailOver is started because of a connection failure, the message ***Please Wait While Failover Works*** will display.

**Multiple Connect: (FailOver)**

Check to enable failover to multiple servers. If primary connection fails, try the next server and so on until a successful connection is made or no other server is available. If not enabled, only one new connection is attempted.

**Ping Before Connect: (Not FailOver)**

Check this box to display a FailOver Log window (see below) if connection start fails.

**Verbose: (FailOver)**

Check this box to cause messages to be displayed about Failover function failure and success in a Failover Log Window.

FailOver Log Window: List FailOver actions and responses.

## 6.8 - SysInfo Tab

This Tab shows the configuration of your OmniTerm.

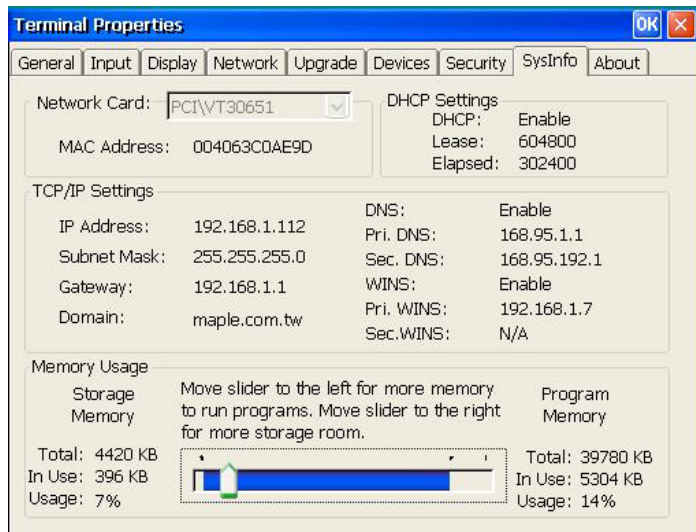

### Network card:

Shows the Ethernet MAC address of the selected Network card.

### TCP/IP Settings:

This will show the network status, about following: IP Address, Subnet Mask, Gateway, Domain, DNS (enable or not), Primary DNS IP Address, Secondary DNS IP Address, WINS (enable or not), Primary WINS IP Address, Secondary WINS IP Address.

### DHCP Settings:

There will show information about DHCP: Enabled or Disabled. If enabled, the IP lease time and elapsed time are shown.

### Memory Usage:

This option is only meaningful for the Browser version of the OmniTerm. Higher rate of Program memory allows you to execute more sessions. Higher rate of Storage memory allows for a larger virtual disk size.

## 6.9 - About Tab



The About properties sheet contains copyright information about the terminal as well as the WBT version ID (e.g. E5404B1). This properties sheet is informational. No user interaction is required.

# Chapter 7 - Terminal Emulation Sessions

## 7.1 - Display Session

### Display Screen (TN5250 example)

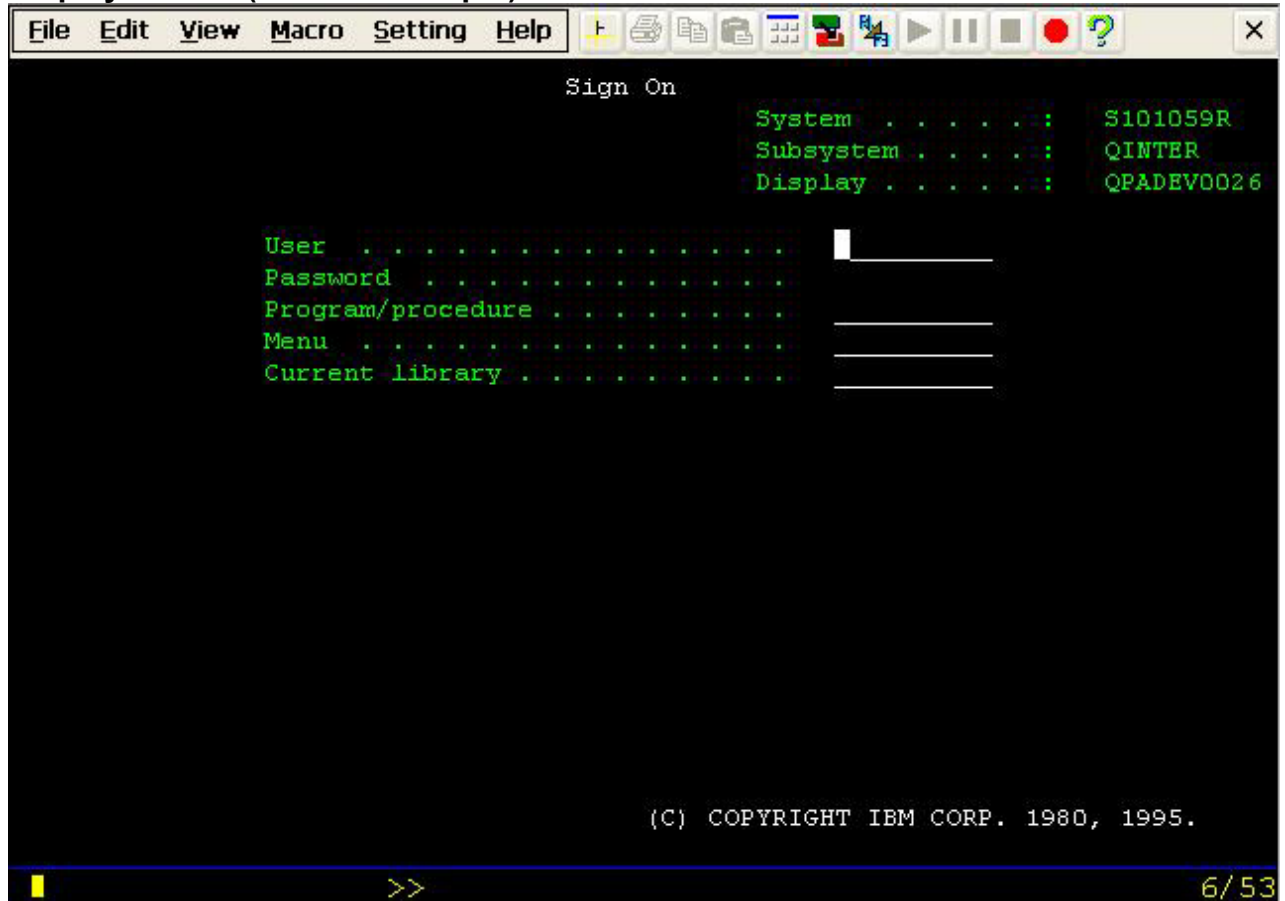

#### Control bar:

The bar at the top of each display session consists of two sections:

**Menu bar** has six options: File, Edit, View, Macro, Setting and Help.













The menu options are described in sections 8.1.1-8.1.5.

**Tool bar** has icons for (left to right): Ruler, Print, Copy, Paste, Keypad, Color Map, Keyboard Map, Macro Play/Pause/Stop/Record, and Help.

A description of the icons follows.

**X box** - Click to Exit (End Connection).

**Toolbar Icon:****Status bar:**





	Ruler	See Setting Menu for more choices of different types of ruler.
	Associated Printer	When Associated Printer is selected with TN3270 session setup, this icon will be active. Pressing it will switch to its associated printer control windows.
	Copy	See Edit Menu for its use.
	Past	See Edit Menu for its use.
	Key Pad	See File Menu for its use.
	Color Remapping	See Setting Menu for its use.
	Keyboard Remapping	See Chapter 5 for different types of keyboard remapping.
	Play	See Macro Menu for its use.
	Pause	See Macro Menu for its use.
	Stop	See Macro Menu for its use.
	Record	See Macro Menu for its use.
	Help	This will display the basic information about terminal.

There are two status bars displaying at the bottom of each display session.



**First status bar:**

The right area identifies the cursor position, row (R) and column (C) in the format R/C. The left area consists of status indicators and special indicators (not always displayed). Each of them shows information about your current session and status of the host system.

**Status Indicators:**

	The host system is available.
	Keyboard input is inhibited.
	The keyboard is in insert mode.
	The SHIFT key is down.
	A message is waiting on the host system for the active session.

**Special Indicators:**

	Diacritic Mode	The terminal is in diacritic mode. Hit the space bar to see the character.
	Type Ahead	You can continue to key even if the keyboard is input inhibited. (TN5250 only)
<b>Num</b>	Numeric	Numeric field (TN3270 only)

**TN3270 Input Inhibit**

Symbol	Meaning
X-system	System lock. The application program locked the keyboard.

X ☉□	Time(Terminal wait). The host needs more time to response to your request.
X NUM	Numeric data only
X-f	Minus function
X-s	Minus symbol
X >	Too much entered
X←→	Go elsewhere
X+?	An invalid diacritical-mark key error
XPROG nnn	Program check. The symbol may appear because the data received is not correct. Please refer to 'IBM 3174 Establishment controller customer problem Determination' for the definition of nnn.

### The second status line:

The left side shows Ready or Macros function status. The right side includes five status areas:

1. The session type – TN5250, TN3270, or ASCII
2. Host Address
3. Device name
4. **A** : Caps Lock key is on
5. **N** : Num Lock key is on

The display of this line can be disabled via a View menu option.

### Cursors and Cursor Functions:

There are generally two cursors - Emulation cursor (Caret) and the Windows mouse cursor. By default, the **right mouse button** can be used to click on various **'Hot Spots'** to select and execute menu number options, execute system function keys listed on the screen, or type a selected word at the Emulation cursor position.

### Local Screen Print:

TN5250: Key **Shift+Print** to print to local attached printer.

TN3270: Key **Print** to print to local attached printer.

ASCII: No local print function is supported.

### Full Screen Mode:

The session can be configured as **Full Screen**. This mode may also be set from the View menu. In this mode, the Title Bar and Second Status line are not displayed and the mouse cursor is not displayed. The screen appears as if it was a 'green screen' dumb terminal with input only from the keyboard.

In this mode you will need to use the Windows key sequences to access the Menu options - Alt+<1st letter of menu name>+<underlined letter of option>. For

example key Alt+F+x to take the Exit option in the File menu.

## 7.1.1 - File Menu

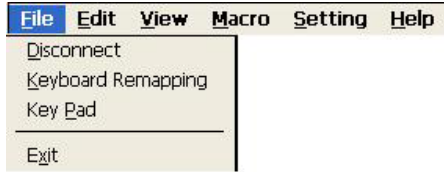

### Disconnect / Connect:

Choose Disconnect to disconnect the session from the host. The connection remains active and Connect replaces **Disconnect**.

*Keyboard procedure: ALT+SHIFT+DELETE or ALT+F+D*

### Disconnect Confirm Dialog Box



*Keyboard procedure: ALT+Y for Yes or ALT+N for No*

### Keyboard Remapping:

See Chapter 5 for the **Keyboard Remapping** screens.

*Keyboard procedure: ALT+F+K.*

### Key Pad:

#### Key Pad Dialog Box



The **Key PAD** allows you to access frequently used keyboard functions or macros from a convenient pop-up KeyPAD. You can position and size the display. Click top left X to remove this display. To edit the KeyPad, see Settings Menu (Key Pad).

*Keyboard procedure: ALT+F+P*

### Exit:

Click **Exit** to end the connection. Screen will show the next active session or the Terminal Manager dialog box.

*Keyboard procedure: ALT+F+P*

## 7.1.2 - Edit Menu



### Copy:

You can use this function to copy data from one session or screen into another. First select the area to be copied.

To select the area to be copied using the mouse, press the left mouse button at a corner of the area to be copied and drag the mouse cursor to highlight the area. To select the area to be copied using the keyboard use: ALT+SHIFT+(Arrow keys)

*Keyboard procedure: ALT+E+C*

### Paste:

This option can place the data that has been copied to the current cursor position.

*Keyboard procedure: ALT+E+P*

### Select All:

This option is used to select all data so you can copy the entire screen. The second status bar will not be selected.

*Keyboard procedure: ALT+E+A*



### 7.1.3 - View Menu

**Status Bar:**

Use this option to toggle (on/off) display of the status of the current session in the bottom line of the screen. In Full Screen mode, a double click (left) from the mouse will toggle back to Normal Screen mode.

*Keyboard procedure: ALT+V+S*

**Full Screen:**

Use this option to toggle between Full Screen and Normal Screen mode.

*Keyboard procedure: ALT+V+F*

### 7.1.4 - Macro Menu



Macros are used to record and play back frequently used keystrokes. A macro can also be specified to automatically run after the connection is started.

#### Record:

To record a macro, place the cursor in the desired position on the screen, then click the **Record** button, start typing the characters, command keys, action keys, etc, when finished, click the **Stop** button.

*Keyboard procedure: ALT+M+R or  
Record (122key keyboard) or  
ALT+F4 (Enhanced keyboard)*

#### Pause:

Pause is used to allow user input during a playback sequence or to insert a second time delay. While recording a macro, select Pause to allow non-recorded user input. The name Pause changes to Continue. Select Continue to resume recording the macro.

*Keyboard procedure: ALT+M+U or press the PAUSE key*

*To Continue, press: ALT+M+C or the PAUSE key*

When Pause is active, you may specify a 1 to 9 second delay by typing [CTRL+ALT+[1-9 on number pad]. Pause is then set inactive. This is useful primarily in TN3270 emulation to allow for screen transition (unbind state). If keystrokes are lost during screen transition, then a delay must be used.

#### Stop:

Stop ends the Record sequence. After selecting Stop, you will be prompted to enter a file name or cancel the record process.

*Keyboard procedure: ALT+M+S or  
Record (122key keyboard) or  
ALT+F4 (Enhanced keyboard)*

### Save Macro Dialog Box



Enter the file name you want the macro saved as. Type the description of the macro for future reference. Assign the macro to a function key - required if keyboard used to Play back the macro.

### Macros:

Click Macros to display a list of all macros and their description. This option allows you to open a pre-recorded macro for use when you hit the **Play** button. Note that the default is to run the macro after you open the file so be sure that you are ready to play the macro you are selecting. If you are not ready, click **“Run after opened”** so the macro is ready to be played, but will not play immediately.

### Open Macro Dialog Box

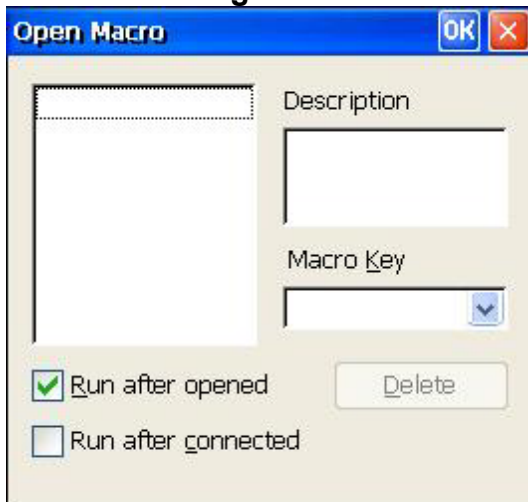

To automatically run a macro after the connection is started, select a macro from the list and check **“Run after connected”**.

**Play:**

Play is only active after you have selected a macro from the Macro list. This option plays back the pre-recorded key sequences in the macro file previously selected.

*Keyboard procedure: ALT+M+P or  
PLAY (122key keyboard), Fn or  
ALT+F5 (Enhanced keyboard), Fn*

**Quit:**

This option is used to terminate a macro, which is playing. This option is only available if a macro is currently being played back.

*Keyboard procedure: ALT+M+Q*

## 7.1.5 - Setting Menu

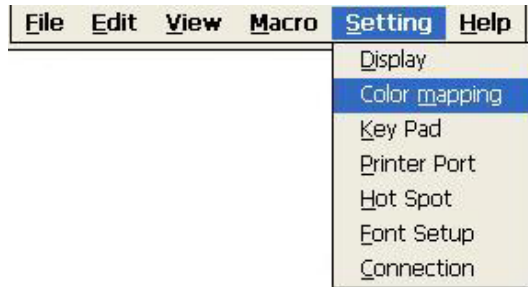

### Display: (ALT+S+D)

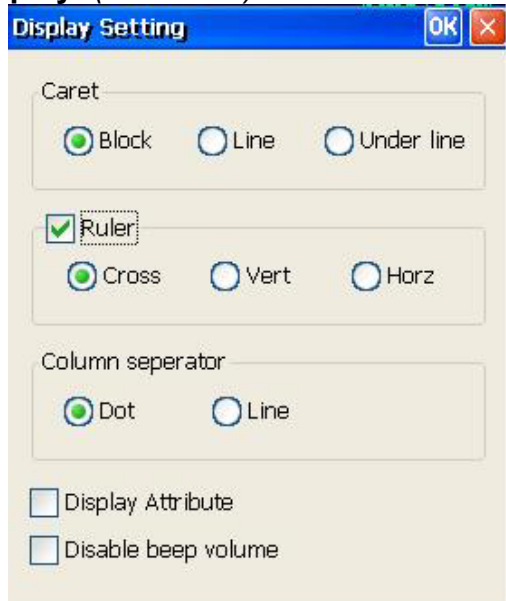

Display controls the cursor type and whether there is a ruler line on the caret.

#### Caret:

Caret (Cursor) type defaults to Block. The other two selections are Line and Under Line.

#### Ruler:

If you select Ruler you can select one of three ruler lines: Cross, Vertical and Horizontal

*Note: To toggle ruler on/off key Rule (122key keyboard) or ALT+PageDown (Enhanced keyboard).*

#### Column separator:

This option defaults to Dot and the other type is Line separator.

#### Display Attribute:

If selected, you can see each attribute code on the current session screen.

**Disable Beep Volume:**  
Select to disable Beep.

**Color Mapping: (ALT+S+M)**

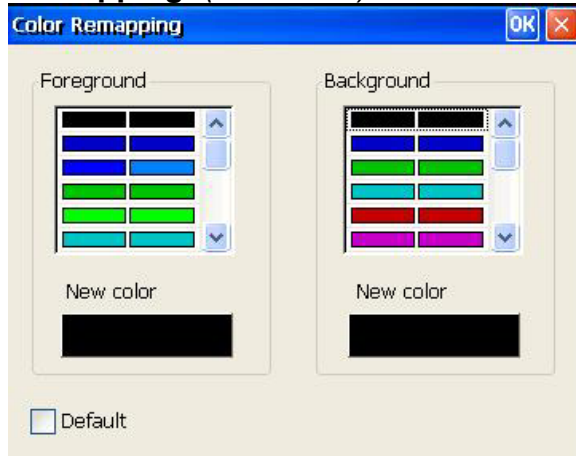

**Foreground:**

This box allows you to modify the foreground color.  
Select the old color in the left color list.

Click **New color** button to select desired color in the Color Panel shown below.

If you need different color from the basic colors, click **Define** to create a new color using the Define Advanced Color Panel.  
Click OK. The new color will display on the screen.

**Background:** Follow the Foreground procedure to modify the Background color.

**Color Panel Dialog Box**



## Define Advanced Color Panel Dialog Box

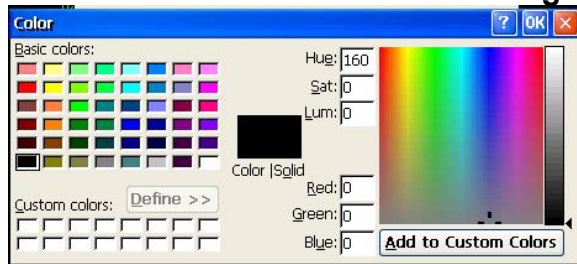

## Key Pad: (ALT+S+P)



This option allows you to access frequently used keyboard functions or macros from a convenient pop-up Key Pad.

Select the **KeyPad Size** in terms of the number of Columns x Rows. Values range from 1x1 to 9x4.

Click on a cell in the matrix displayed. The Name, if any, will display in the **KeyPad** field.

Select the **Key Type**; either **System** key or **Macro** name. The list of system keys or defined macro names will be displayed. Double click the desired entry for the specified cell.

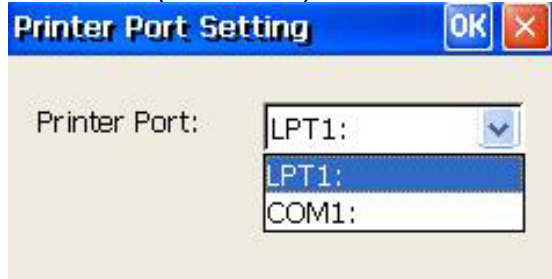
**Printer Port: (ALT+S+P)**

Select printer port: **LPT1:** (default) or **COM1:**

If **COM1** is selected, a **Port Setting** button is displayed in the above dialog. Clicking this button will display the **Com Port Setting** dialog as shown below.

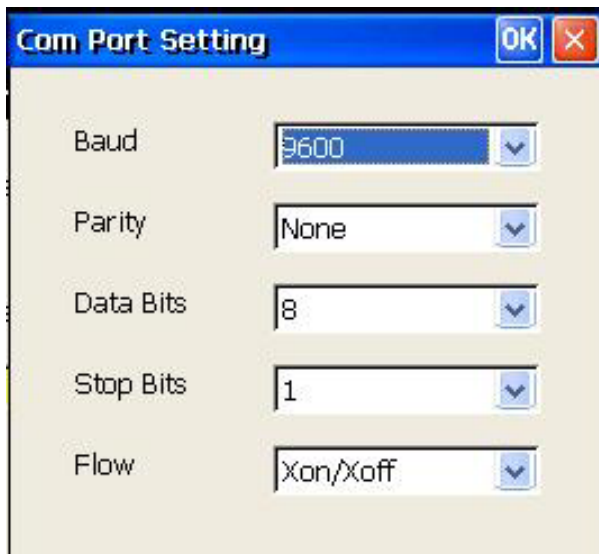
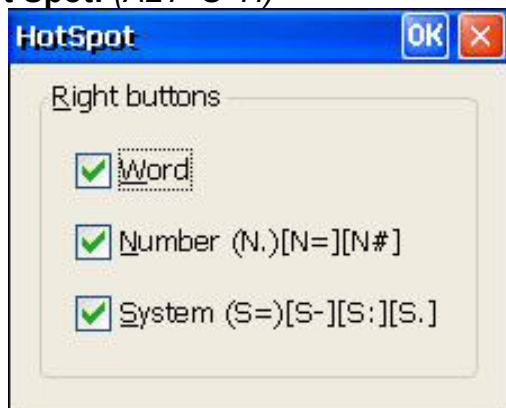
**Hot Spot: (ALT+S+H)**

By default, the **right mouse button** can be used to click on various 'Hot Spots' to select and execute menu number options, execute system function keys listed on the screen, or type a selected word at the Emulation cursor position.



**Font Setup:** (ALT+S+F)

Select desired font. Courier New is the default. Other fonts may be loaded as described in Appendix C.

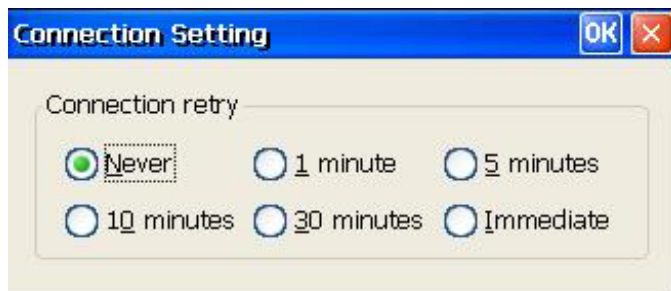
**Connection:** (ALT+S+C)

This option allows you to auto-reconnection when the host disconnected. Select desired time. When choose Never, it won't auto-reconnection when the host disconnected.

## 8.1.6 Help Menu



Click **Help** then **About** to display basic information about the terminal.

*Keyboard Procedure: ALT+H+A*

## 7.2 - Printer Session

### Printer Session Screen (TN3270 Printer example)

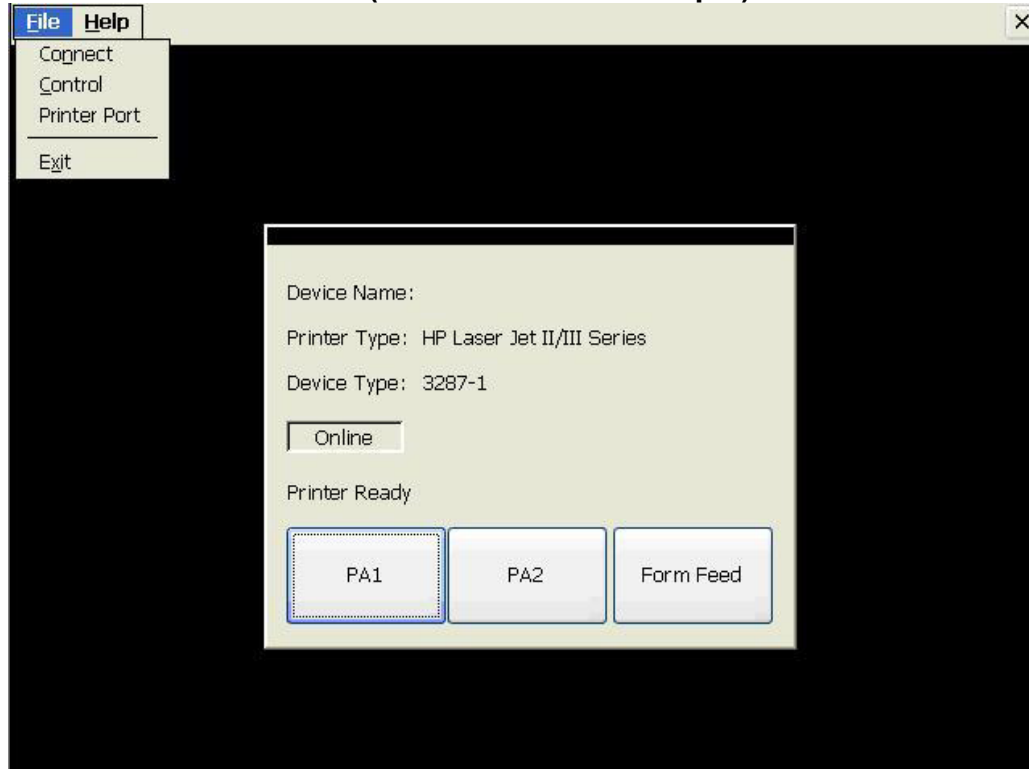

This dialog box means that the printer is in the ready status to connect to the host.

#### **Online:**

When the printer session is active, the 'Online' button will become yellow.

#### **PA1/PA2/Form Feed: (TN3270 only)**

Click the button to send the named code to the server.

Using the keyboard, Tab to desired Button and press Enter.

### TN5250 Printer Session Status Example

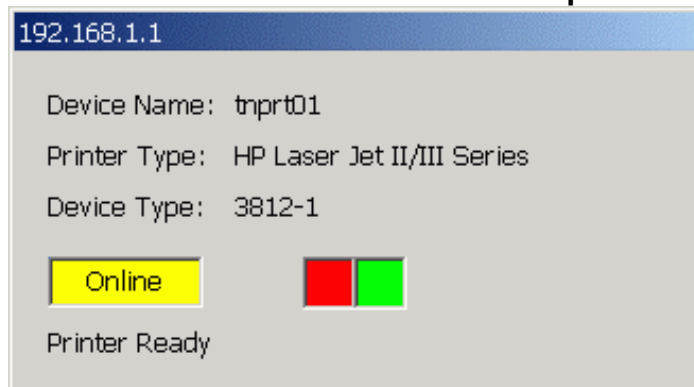

Online and printing (Red/Green boxes alternate).

### 7.2.1 - File Menu



**Disconnect:** (*ALT+SHIFT+DELETE* or *ALT+F+D*)

Select **Disconnect** to disable the printer session from the host. The connection remains active and **Connect** replaces **Disconnect**.



**Control:** (TN3270 only) (*ALT+F+C*)

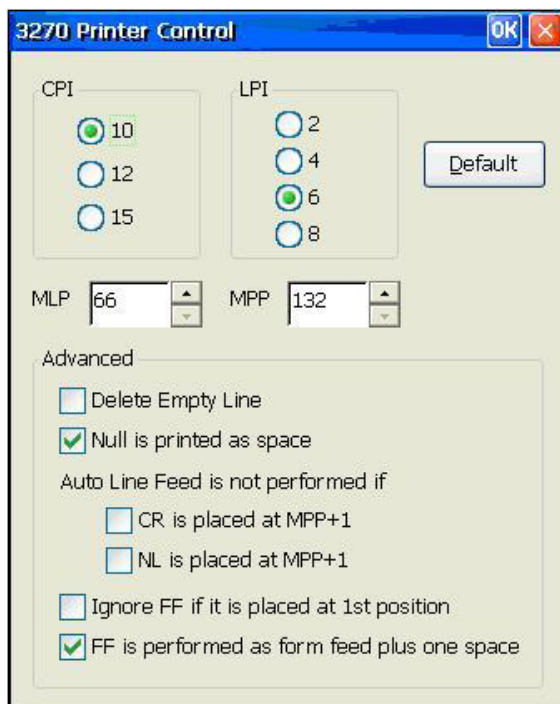

**CPI:**  
Characters Per Inch. The default is 10 CPI.

**LPI:**  
Lines Per Inch. The default is 6 LPI.

**MPL:**

Maximum Print Lines per page. The range is from 1 to 255. The default is 66.

**MPP:**

Maximum Print Position. The range is from 1 to 255. The default is 132.

**Delete Empty Line:**

Selecting this function will delete the whole line if it includes only unprintable characters. Unprintable characters include null, control codes. But space (X'40) is printable character. By default this function is disabled. This function is valid only for DSC (LU3 with 2 and 3 bit of WCC is not '00').

**Null is printed as space:**

This function is valid only for screen print DSC(LU3).

**Auto Line Feed is not performed if****CR is placed at MPP+1:**

If this item is selected and MPP+1 has CR, the Auto Line Feed will not be performed. This function is valid only for DSC (LU3 with WCC's '00' in 2<sup>nd</sup> and 3<sup>rd</sup> bit).

**NL is placed at MPP+1:**

Selecting this item will cause NL on MPP+1, the Auto Line Feed will not be performed. This function is valid only for DSC (LU3 with WCC's '00' in 2<sup>nd</sup> and 3<sup>rd</sup> bit).

**Ignore FF if it is placed at 1<sup>st</sup> position:**

Selecting this item in LU3, the system will ignore FF at 1<sup>st</sup> position in first line.

**FF is performed as form feed plus one space:**

When this item is selected, a FF code will cause form feed be performed. The 1<sup>st</sup> line of the next page will be a space and printing starts at the 2<sup>nd</sup> position of the 1<sup>st</sup> line. Clear this item and printing starts at the 1<sup>st</sup> position of the 1<sup>st</sup> line of the next page. This function is valid only for screen print and LU3. By default this function is enabled.

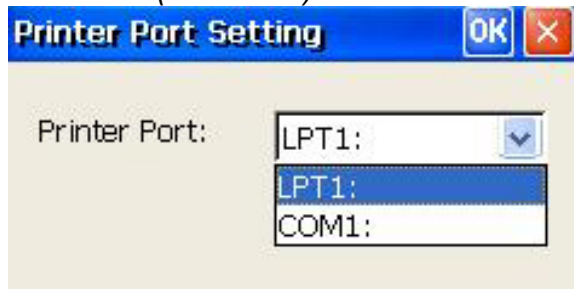
**Printer Port: (ALT+F+P)**

If **COM1** is selected, a **Port Setting** button is displayed in the above dialog. Clicking this button will display the **Com Port Setting** dialog as shown below.

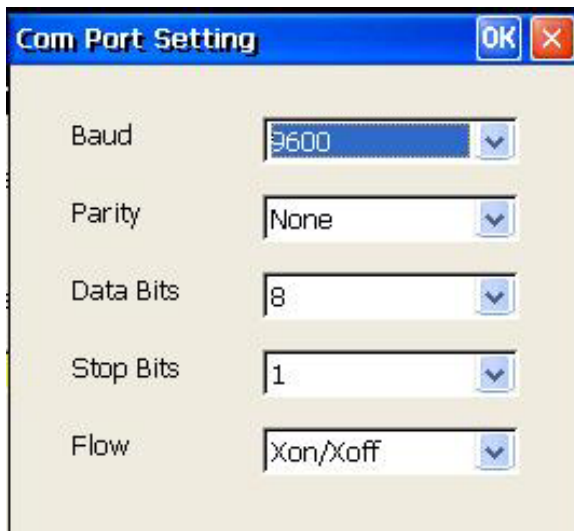

### 7.2.2 - Help Menu



Click **Help** then **About** to display basic information about the terminal.

*Keyboard Procedure: ALT+H+A*

# Chapter 8 - Terminal Firmware Upgrade

The OmniTerm uses the FTP protocol to access and download new firmware on to the flash memory of the terminal. The update can be started manually via the Upgrade panel of the Terminal Properties screen, via the SNMP Administrator software or automatically upon boot if the proper DHCP parameters were set.

## 8.1 - Prepare FTP Server

The files for the flash update must be located on an FTP server on your network. You can obtain new version firmware from our web site at [www.nlynx.co.uk](http://www.nlynx.co.uk) The single file is a compressed file which must be expanded then placed in a known location on your FTP server.

An FTP server is provided with Microsoft Internet Information Server. If you have IIS running on a server, check if the FTP service is started and identify your "FTP Root". Place the files in the FTP root or a folder under the FTP Root.

*Note: To check if your FTP server is configured properly, open a browser and type **ftp://<FTP server IP address>** to see the list of folders under the FTP root.*

The IBM AS/400 FTP server is supported. Please refer to Appendix A for configuration instructions.

Unix, Linux and other (RFC compliant) FTP servers are supported as well. Refer to your system documentation on configuring your specific FTP server.

## 8.2 - Update Procedure

Press **F2** and click the **Upgrade** tab to display the Upgrade Properties Sheet.

### Upgrade Properties Sheet

The screenshot shows the 'Terminal Properties' dialog box with the 'Upgrade' tab selected. The 'SNMP Manager IP' field is set to '0.0.0.0'. The 'Manual Upgrade' checkbox is unchecked. The 'ETP Server' field contains '192.168.1.32', the 'Pathname' field contains '/e0401', the 'User name' field contains 'pem', and the 'Password' field contains '\*\*\*\*'. An 'Upgrade Now!' button is located at the bottom of the dialog.

#### SNMP Manager IP:

If specified, upgrade status information is transmitted to the device at the IP address that is running the CLI WBT SNMP Administrator (see 9.3)

#### Manual Upgrade:

The default is *Manually upgrade*. Enter the update information in the four fields required.

#### FTP Server:

FTP server IP address

#### Pathname:

Enter the directory of the update files under the FTP server root.

For example: /OmniTerm/e0317

#### Username:

Enter the valid username (if FTP security requires); otherwise leave blank

#### Password:

Enter the valid password (if FTP security requires); otherwise leave blank

Click **Upgrade Now!** To start update



### Upgrade Now Dialog Box

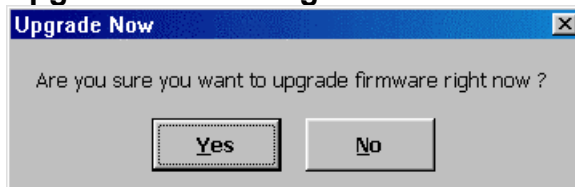

When you Click **“Upgrade Now!”** button, the confirm dialog box will display.

When the upgrade procedure is finished, the system will ask to be restarted, click Yes.

To complete update of the Windows CE Registry, press F2 at the Session Manager screen, select the **General** Tab, check **Reset the terminal to factory-default settings**, then press Enter. The terminal will re-boot. You can begin to use the terminal; or reset to defaults again (required when going from CE2.0 to CE3.0).

### Auto Upgrade/Configuration initiated via custom DHCP tags (See Appendix B):

The OmniTerm may be automatically updated/configured if you configure DHCP to pass custom tags to the client. When powered on, this will occur when a newer version is detected. To use this feature, in **Network Properties** insure that **Obtain an IP address from a DHCP server** is enabled and that all FTP options are enabled under **Advanced DHCP**. The DHCP options must be setup as described in Appendix B.

### Upgrade Firmware Dialog Box

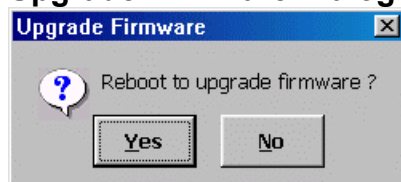

Click **Yes** to reboot WBT for upgrade or wait for timeout.

## 8.3 - SNMP Manager Procedure

The OmniTerm firmware can be updated from a centrally located PC/Server running the NLynx WBT SNMP Manager.

Please see the SNMPadmin manual for complete operating functions/details for updating OmniTerm clients.

## Chapter 9 - Web Browser

An example browser screen is shown below.



Operation is essentially the same as running an IE browser on a Windows PC. Refer to Chapter 6 for configuration details.

The Menus are similar; but some are significantly different. The Menus are shown below with differences highlighted.

## 9.1 - File Menu

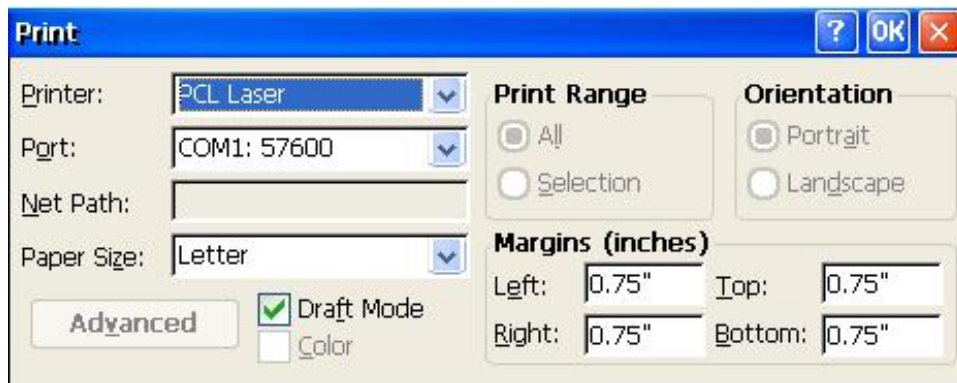
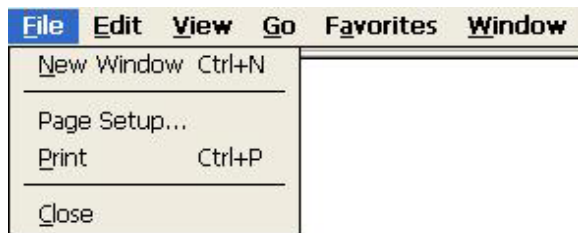

### Port:

LPT1:  
COM1:57600  
COM1:9600  
IRDA  
Network

### Net Path:

If **Port = Network**, specify the network printer path. For example:  
\\YOURSERVER\YOURPRINTER.

## 9.2 - Edit Menu



### 9.3 - View Menu

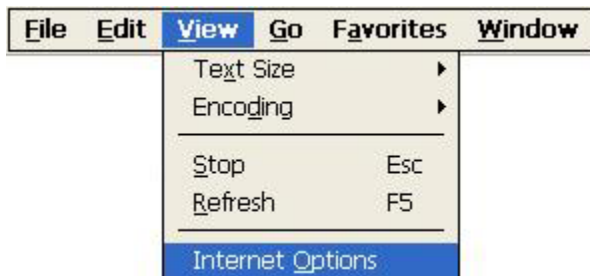
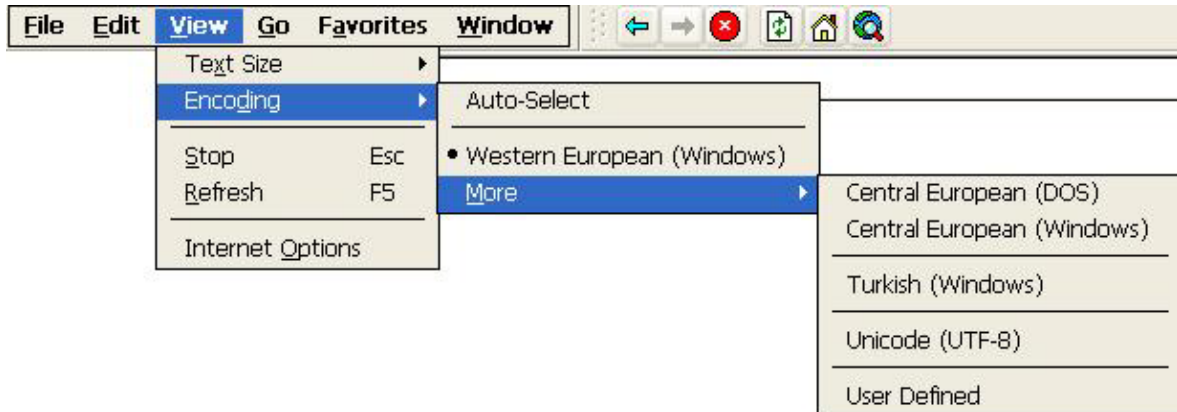
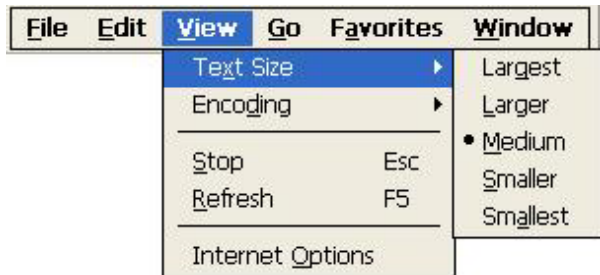

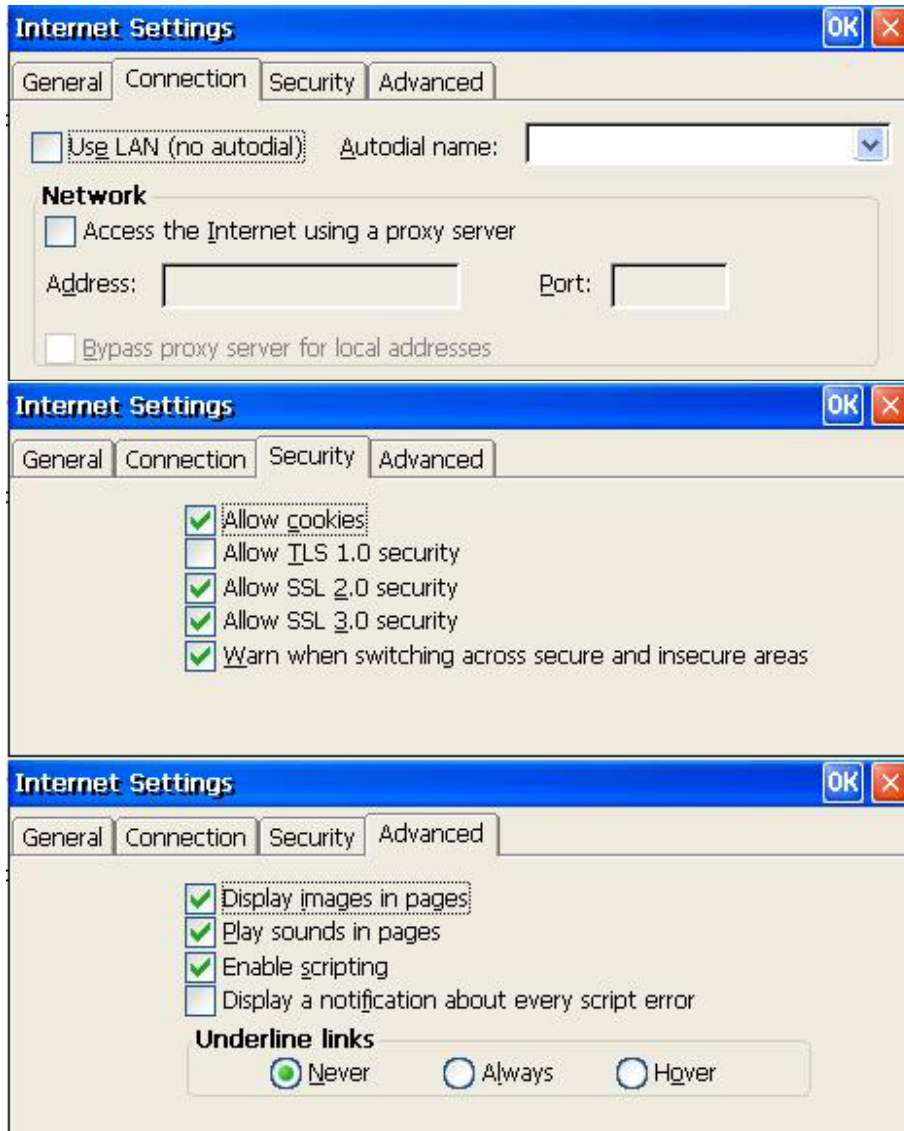

See section 7.9 for configuration details. The Internet Options menu option will not be displayed if Security is enabled and the user is not the Administrator.

## 9.4 - Go Menu



## 9.5 - Favorites Menu



The list of favorites is shown.

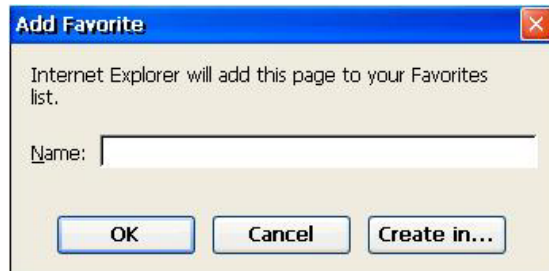

The **Name** shown may be edited.

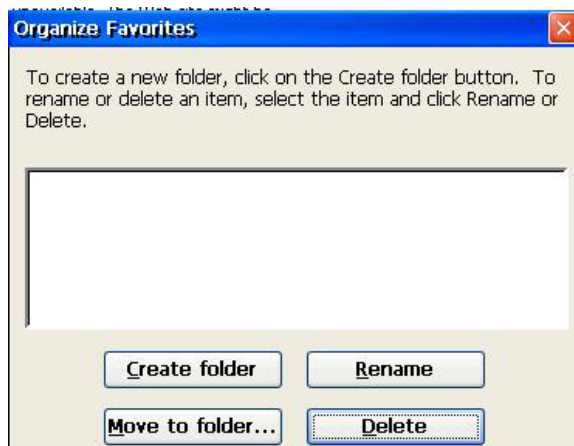

## 9.6 - Window Menu



# Chapter 10 - Wireless Network Configuration

## 10.1 - Wireless Networking Concepts

The OmniTerm supports 802.11b wireless networking using Cisco 350 series PCMCIA adapters. Additional 802.11b vendor support will be added to the terminal as drivers become available.

When using the wireless adapter, the OmniTerm can connect to your wireless infrastructure and participate in you LAN. The wireless standard 802.11b supports up to 11Mbit data rate which provides performance equal to most wired mplementations.

**IMPORTANT NOTE:** *Wired and wireless Ethernet connections should NEVER be connected simultaneously. Do not connect both wired Ethernet and have the 802.11b wireless PCMCIA card inserted at the same time.*

## 10.2 - Install Wireless PCMCIA Card

After turning off the terminal, insert the wireless PCMCIA card into the PCMCIA slot in the back of the OmniTerm. The card must be inserted with the bottom of the PCMCIA card facing the Ethernet port and the top of the PCMCIA card facing the plastic bezel of the terminal.

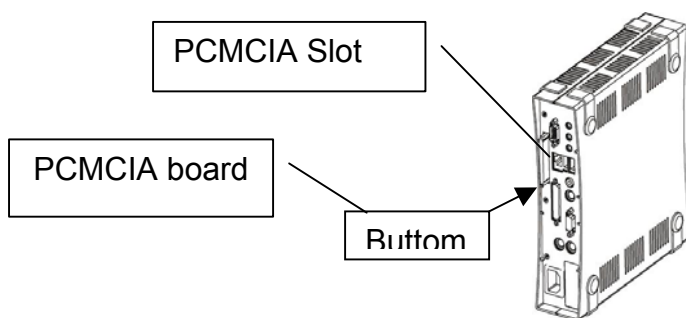



## 10.3 - Configure Wireless Settings

The wireless settings are configured via the **Network** program located in the **Devices** Tab of the **Terminal Properties** panel. SSID, WEP and other wireless security settings are set within the configuration screens which follow.

If your organization broadcasts the SSID and does not have WEP enabled (no security enabled on your network), there is nothing to configure. The terminal will auto-detect the network and does not require configuration.

To configure you wireless settings, start at the **Terminal Manager** screen, then press F2 to go to then **Terminal Properties** panel. Click the **Devices** tab then double click the **Network** icon.

### Terminal Properties "Devices" Panel

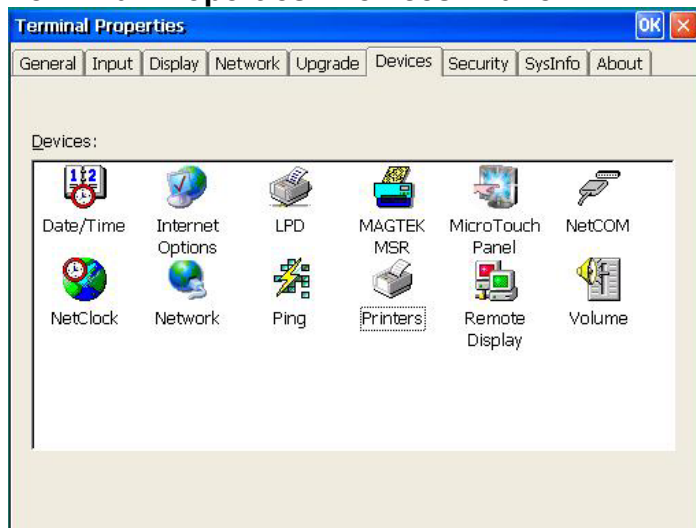

After you double click the Network icon, you will be presented with the Network Connections Panel. If the wireless card has been detected, it will be listed among available network connections. Double click the icon labeled **"Cisco1"**.

### Network Connections Panel

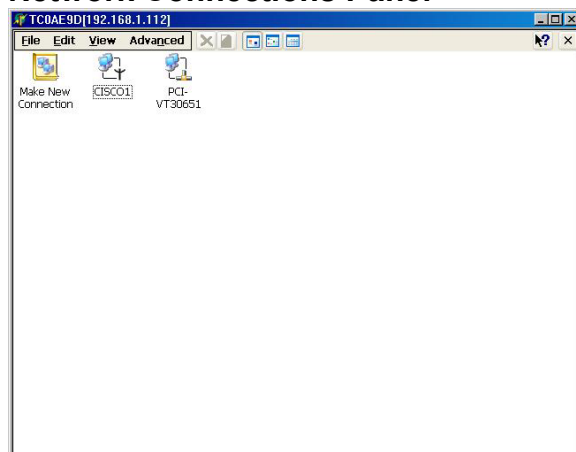

From within the **"Cisco 802.11 miniport Settings" IP Address** tab, you can manually set the IP address the wireless card will use or use DHCP

### IP Address tab

The screenshot shows the 'Cisco 802.11 miniport' Settings dialog box with the 'IP Address' tab selected. The dialog has three tabs: 'IP Address', 'Name Servers', and 'Wireless Networks'. The 'IP Address' tab contains the following text and controls:

An IP address can be automatically assigned to this computer. If your network does not automatically assign IP addresses, ask your network administrator for an address, and then type it in the space provided.

Obtain an IP address via DHCP  
 Specify an IP address

IP Address: [ . ] [ . ] [ . ]  
 Subnet Mask: [ . ] [ . ] [ . ]  
 Default Gateway: [ . ] [ . ] [ . ]

From within the **Name Servers** tab, you can manually specify your DNS and Wins servers if you are not using DHCP.

### Name Servers tab

The screenshot shows the 'Cisco 802.11 miniport' Settings dialog box with the 'Name Servers' tab selected. The dialog has three tabs: 'IP Address', 'Name Servers', and 'Wireless Networks'. The 'Name Servers' tab contains the following text and controls:

Name server addresses may be automatically assigned if DHCP is enabled on this adapter. You can specify additional WINS or DNS resolvers in the space provided.

Primary DNS: [ . ] [ . ] [ . ]  
 Secondary DNS: [ . ] [ . ] [ . ]  
 Primary WINS: [ . ] [ . ] [ . ]  
 Secondary WINS: [ . ] [ . ] [ . ]

From within the **Wireless Network** tab, you can select an access point to associate with, if the SSID broadcast is enabled on your Access Points. If SSID broadcast is not enabled, click the **Add** button under the **Preferred Networks** section.

### Wireless Networks tab

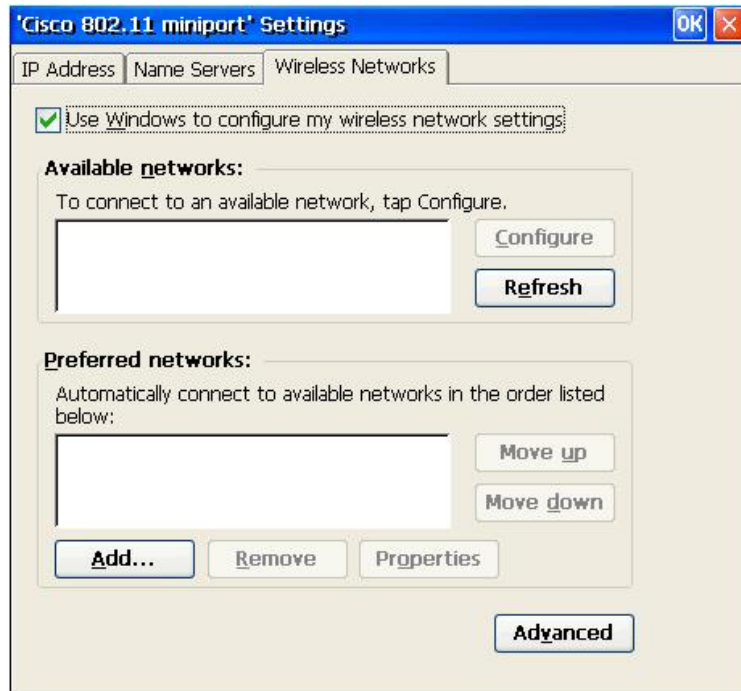

From within the **Wireless Network** tab, you can specify the type of wireless network in your environment. Businesses normally only use Access Point based networks. The default setting “Any available network (access point preferred)” is sufficient for most applications. You can specify “Access point (infrastructure) networks only” to add a layer of additional security if desired. The option “Automatically connect to non-preferred networks” is only used in a roaming application with all Access Point security disabled. When complete, click the **Close** button to save your settings.

### Advanced Network Panel

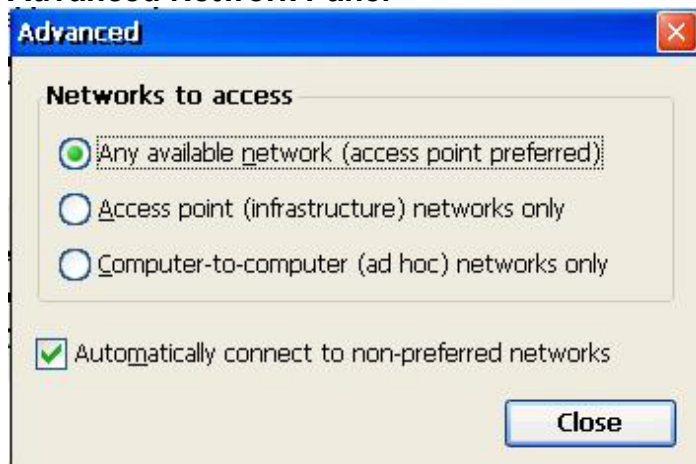

From within the **Wireless Network Properties** screen you can specify your SSID, WEP and 802.1x settings. If you use WEP and specify your WEP settings manually, un-select the check box **“The key is provided automatically”** then lick the **Modify WEP Key button**.

The **WEP Enabled** setting on this panel is set automatically based on the WEP setting detected on your Access Point. If WEP is enabled on your access point, the **WEP Enabled** option is checked, and is not checked if it is disabled.

### Wireless Network Properties

The image shows two side-by-side screenshots of the 'Wireless Network Properties' dialog box. Both windows have a blue title bar with the text 'Wireless Network Properties' and a close button (X) in the top right corner.

**Left Screenshot:**

- Network name (SSID): [Empty text box]
- This is a computer-to-computer (ad hoc) network; wireless access points are not used
- Wireless network key (WEP)**
- This network requires a key for:
  - Data encryption (WEP enabled)
  - Network Authentication (Shared mode)
  - The key is provided automatically
- Modify WEP Key** button
- IEEE 802.1X Authentication**
- Enable 802.1X authentication on this network
- EAP: [TLS dropdown menu]
- Properties** button
- OK** and **Cancel** buttons at the bottom.

**Right Screenshot:**

- Network name (SSID): [Empty text box]
- This is a computer-to-computer (ad hoc) network; wireless access points are not used
- Wireless network key (WEP)**
- This network requires a key for:
  - Data encryption (WEP enabled)
  - Network Authentication (Shared mode)
  - The key is provided automatically
- Modify WEP Key** button
- IEEE 802.1X Authentication**
- Enable 802.1X authentication on this network
- EAP: [TLS dropdown menu]
- Properties** button
- OK** and **Cancel** buttons at the bottom.

At the **Wireless (WEP) Key Settings** panel, enter the WEP key(s) used within your network. The key settings can be entered as hex or ASCII characters and accept values of 40 or 104 bits.

### Wireless (WEP) Key settings

The image shows a screenshot of the 'Wireless (WEP) Key Settings' dialog box. It has a blue title bar with the text 'Wireless (WEP) Key Settings' and a close button (X) in the top right corner.

- Network key: [Empty text box]
- Key format: [ASCII characters dropdown menu]
- Key length: [104 bits (13 characters) dropdown menu]
- Key index (advanced): [0 text box]
- OK** and **Cancel** buttons at the bottom.

After all configuration settings have been entered, click OK in the top right corner of the **"Cisco 802.11 miniport Settings"** panel to save your settings and close the panel.

Restart the terminal to initialize the settings which were just saved.

## 10.4 - Wireless Communication Problems

If you are unable to connect to the network and receive the error message "Access point could not be found , restart terminal to try again", this indicates that the settings entered did not allow the terminal to associate with an access point or there is no access point within radio range.

If the settings are known to be correct and access points are functioning normally, accept the option to restart the terminal and allow the terminal to attempt to associate again.

Confirm the wireless security settings for your network, re-enter the settings in the network tab

Verify the signal strength within the area the terminal is being used

Attempt to place the terminal (PCMCIA antenna) in an area which would not obscure the signal

Select the Refresh button from within the **"Cisco 802.11 miniport Settings"** panel and determine if an antenna icon appears in the "Available Networks" or in the "Preferred Networks" window. If there is a blue ring around the top of the antenna icon, the connection is established

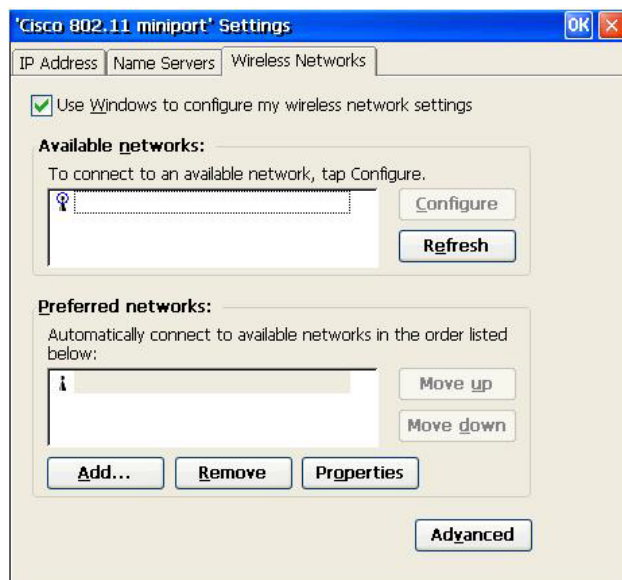

## Appendix A - AS/400 FTP Setup

The following instructions will assist you in setting up the AS/400 FTP server so it can be used for "Flash Update" of the OmniTerm. You must have CA/400 (or equivalent software) running on a PC and Security Officer authority to complete these steps.

### Please Note:

*There are a number of changes which will be made to your current AS/400 FTP server which may have security consequences and are entirely your responsibility. Please be sure you are familiar with any security risks these changes may create.*

You will obtain one file from our web site (www.computerlab.com), CD or email. This file is a "self extracting zip file". When you execute this file, it will expand into multiple files. Put the self extracting zip file in a working directory on a PC with Client access and execute the file. The file will expand into multiple files. The file names are:

**MANIFEST.DUB** Version control file and manifest of BIN files

**FILE\_XXX.BIN xxx** = file sequence number for flash image firmware

**CAUTION:** All files are controlled as a group! When you are updating or changing the files in the directory: **/OmniTerm** in the AS/400 IFS, be certain that all files are replaced as a group.

On a terminal or emulated terminal session, create the directory: **/OmniTerm** in the AS/400 IFS by entering the following

```
====> CRTDIR DIR('OMNITERM')
```

On a PC running CA/400, copy the Flash Update files (which you obtained from NLynx) to the AS/400 directory: **/OMNITERM**

- a) Open two copies of Windows Explorer
- b) Select the directory which contains the new Flash Update files in the first frame
- c) Select the **OMNITERM** directory on the AS/400 in the second frame
- d) Drag each of the Flash Update files to the **OMNITERM** directory on the AS/400

NOTE: When specifying the directory in the Update section on the OmniTerm be sure to use the forward slash (/) character in front of the directory name. DO NOT USE the back slash (\) character. For example, the path should be entered as: **/OMNITERM**

Please refer to Chapter 8 and follow the "Manual Upgrade" procedure to perform the flash update for the OmniTerm.

# Appendix B - AutoUpdate / AutoConfiguration

(Revision 1.02)

## AutoUpdate / AutoConfiguration Setup & Use

The OmniTerm, with access to a DHCP server and an FTP server, can power on and automatically update its firmware version and/or its configuration if newer objects are available on the FTP server. In addition, DHCP can provide various RDP/ICA connection parameters.

*Note: See SNMP User Guide for more information on building and preparing a configuration image.*

### DHCP Extended Options

Options 206 through 209 are defined as FTP AutoUpdate/Config options.

The OmniTerm firmware files are can be retrieved from the WEB or accessed via E-mail. The Configuration files are generated using the *WBT SNMP Administrator* program

---

**Important Note:**

All values are defined as “**string**” type values!

---

*FTP Server:* The IP address or Name of the FTP server to be used for Auto setup.

*FTP Path:* Path name (e.g. /etauto) to the Auto setup directory containing the firmware version update files (manifest.dub & associated '.bin' files; some 6MB) plus the configuration files  
(SnmAutoConfig.sac & associated '.bin' file; some 240KB).

*FTP User Name:* User sign on name (if required)

*FTP Password:* Sign on password (if required)

Options 200 through 205 are Terminal Server connection options (RDP & ICA):

Remote servers: Enter host name or IP address for the terminal servers. The entry format is as follows:

```
<RDP:name1,name2\host;ICA:name1,name2\host address>
-Or-
RDP:* \host;ICA:* \host address>
```

where:

- "host" can be the IP address or host name.
- "name" is the session name in the Terminal Manager of the OmniTerm
- "RDP:" and "ICA:" identify the connection type

**Examples:**

1. 192.168.1.1

- all ICA and RDP session will connect to 192.168.1.1

2. <RDP:\* ;ICA:\*>192.168.1.1

- all ICA/RDP sessions connect to 192.168.1.1

3. <RDP:rdp1,rdp2\192.168.1.1;ICA:ica1,ica2\192.168.1.3>

- RDP session rdp1,rdp2 connect to 192.168.1.1, ICA session ica1, ica2 connect to 192.168.1.3

4. <RDP:\* ;ICA:\* \192.168.1.3>192.168.1.1

- all RDP session connect to 192.168.1.1 and all ICA session connect to 192.168.1.3

5. <ICA:\*>192.168.1.3

- all ICA session connect to 192.168.1.3

**User Name:** Automatic Logon user name.

**Domain:** Automatic Logon domain name.

**Password:** Automatic Logon password.

**Command Line:** Application to run

**Working Directory:** The working directory for the application.

---

**Important Note:**

The extended option numbers described above may be redefined in the *Terminal Properties* screen, *Network* tab, using the *Advanced DHCP* button. This is not recommended for options 206-209 because it will disable autoconfig of default devices.

---



# Appendix C - Advanced Terminal Customization

## C.1 - Emulation Font Upload

The OmniTerm terminal emulation program (*TermPro*) comes with a default font which supports all languages the terminal is designed to support. This font may not be desirable to some users. To address this issue, a feature was added to allow the Administrator to install fonts onto the terminal for use with the local emulation program.

Many fonts are available for free download or purchase on the Internet and other medium.

Additional fonts are available from multiple sources on the Internet. One site which has a number of fonts available is SourceForge.net (<http://prdownloads.sourceforge.net/corefonts>)

Please check the N Lynx technical support web site ([www.nlynx.co.uk](http://www.nlynx.co.uk)) as more fonts become available and tested.

**Important Note:** *THE ONLY FONTS SUPPORTED are fonts with “Monospace” and “TrueType” attributes.*

You are responsible to ensure the font you select has the necessary language support for your locale and that you have the legal right to use the font. Most available fonts support US English.

### Font Install Prerequisites

- ❑ Minimum version requirements: ver. E5404
- ❑ True Type, Mono Space font file with TTF extension
- ❑ N Lynx SNMPadm Management software (version 1.83.7 or above) installed on a PC or server
- ❑ FTP server on your network
- ❑ TTF file installed on your FTP server
- ❑ DHCP options 206 – 209 served (**optional**)
  - 206 FTP Server:** The IP address or Name of the FTP server.
  - 207 FTP Path:** Path name (e.g. /font) containing the TTF file
  - 208 FTP User Name:** User sign on name (if required)
  - 209 FTP Password:** Sign on password (if required)

## Font Install Procedure

If DHCP options 206 – 208 are served, please start at step 2.

1. Set upgrade server and path on the OmniTerm:
  - Press F2 at the **Terminal Manger** panel
  - At the **Terminal Properties** panel, click the **Upgrade** tab
  - Select the check box: **Manual Upgrade**
  - Enter the **FTP Server, IP address** and **Path** where the TTF file is located
  - Enter the **User name** and **Password** only if required
  - Click OK on the **Terminal Properties** panel when finished
  - Accept the option to restart the terminal
  
2. Force terminal to download TTF font file using the SNMPADM management tool:
  - Discover the terminal you wish to upload the font to
  - Right Click on the IP address(s) of the terminal
  - Select the menu item “Messages”
  - Enter the following string into the message box. The font file “andalemo.ttf” will be used for this example:

**\$INSTALL FONT\$ andalemo.ttf**

Important Notes:

- Enter the font name of your TTF file in place of the example file name above (andalemo.ttf)
- The command must be in all capital letters
- The file name is case sensitive and must match the case of the file on your FTP server
  
- Press the **Send** button to send the command to the terminal(s)
- The command instructs the terminal to download the font from the specified FTP server and Path

## Using The Installed Font

The font can now be accessed by the user from within the *TermPro* emulation program. To select the font used by *TermPro*:

- Start the emulation program
- Click the menu item: **Setting**
- Click the menu option: **Font Setup**
- Select the font from the pull down list

**Related Messages:**

**\$UNINSTALL FONTS fontname**

Reboot by user is required.

**\$LIST INSTALL FONTS\$**

The SNMPadm "Message History" lists the installed fonts.

## C.2 - Boot-up Splash Screen Upload

The initial splash screen, that is seen just after power up and shows the progress bar during boot can be changed. For instance, some customers prefer to have the splash screen of their company logo.

### Install Prerequisites

Minimum version requirements: ver. E5404

NLynx SNMPadm Management software installed on a PC or server, version 1.83.10 or above

New Splash Screen file named **Splash.bmp** installed on your FTP server on the network.

DHCP options 206 – 209 served (**optional**)

**206 FTP Server:** The IP address or Name of the FTP server.

**207 FTP Path:** Path name (e.g. /font) containing the TTF file

**208 FTP User Name:** User sign on name (if required)

**209 FTP Password:** Sign on password (if required)

### Install Procedure

If DHCP options 206 – 208 are served, start at step 2.

1. Set upgrade server and path on the OmniTerm:
  - Press F2 at the **Terminal Manger** panel
  - At the **Terminal Properties** panel, Click the **Upgrade** tab
  - Select the check box: **Manual Upgrade**
  - Enter the **FTP Server, IP address** and **Path** where the bitmap file is located
  - Enter the **User name** and **Password** only if required
  - Click OK on the **Terminal Properties** panel when finished
  - Accept the option to restart the terminal
  
2. Force terminal to download the bitmap file using the SNMPadm management tool:
  - Discover the terminal you wish to upload the splash screen to
  - Right Click on the IP address(s) of the terminal
  - Select the menu item “Messages” and enter the following string into the message box. The command must be in all capital letters and the image file name is case sensitive.

**\$FLASH BOOTLOGO\$ Splash.bmp**

- Press the **Send** button to send the command to the terminal(s)
- The command instructs the terminal to download the font from the specified FTP server and Path

## C.3 - Remote Serial Number Update

The serial number is loaded into the flash by the factory for all NLYnx terminals which were shipped with version x0350 or above. If the terminal you are using does not have the serial number loaded, it can be entered manually on the terminal (see section 7.1) or via a special command.

Use SNMPadm 1.83.10 or above, to send a command to update the serial number:

- discover the terminal you wish to update serial number
- right Click on the IP address of the terminal
- select the menu item Messages
- enter the following string into the message box. The number TBB512345 will be used for this example:

**\$SET SERIALNO\$ TBB512345**

## C.4 - Registry Edits

The configuration of a windows based terminal is held in the 'Registry'. This registry can be edited to change certain operating characteristics. Use SNMPadm version 1.83.7 or above to edit the registry.

### C.4.1 - Disable Browser Address Bar

Terminal versions: E5404 or above.

For some applications, it may be desirable to limit the user's access to the address bar. This may be useful in a kiosks or intranet application. To disable the address bar, the registry must be modified. A **dword** value "Disable AddressBar" must be added as follows:

**'HKEY\_CURRENT\_USER\Software\Microsoft\Internet Explorer\Main\Disable AddressBar'**

0 = disabled  
1 = enabled

A simple way to implement this change would be to use the following procedure:

- create a new, empty registry by pressing the "New Setting" icon in the Remote Setting tab
- create the tree:  
HKEY\_CURRENT\_USER\Software\Microsoft\Internet Explorer\Main
- create the **dword**: Disable AddressBar
- enter the value of "0" or "1"
- click the SaveAll icon
- rename the file from "NewSetting" to "disable addressbar"
- click the SaveAll icon
- drag/drop this change on to any terminal

## C.4.2 - Autostart Delay Feature

Terminal versions: E5404 or above.

The Autostart Delay feature was added to allow for circumstances where the network connection was not established by the time the sessions would be autostarted. For example, when using wireless networking, it is possible that the terminal will not authenticate to the Access Point by the time the session has started. This would result in the session failing to connect to the host. A delay can be inserted before Autostart begins which resolves this issue.

The Autostart Delay feature must be enabled via a registry change. The **dword** value is:

**'HKEY\_LOCAL\_MACHINE\Software\Microsoft\WBT\Shell\AutoStartDelay'**

The value is in seconds and can be up to 99. A recommended value is 10 if required at all.

A simple way to implement this change would be to use the following procedure:

- create a new, empty registry by pressing the "New Setting" icon in the Remote Setting tab
- create the tree:  
HKEY\_LOCAL\_MACHINE\Software\Microsoft\WBT\Shell\
- create the **dword**: AutoStartDelay
- enter the value of "10"
- click the SaveAll icon
- rename the file from "NewSetting" to "autostart delay"
- click the SaveAll icon
- drag/drop this change on to any terminal