

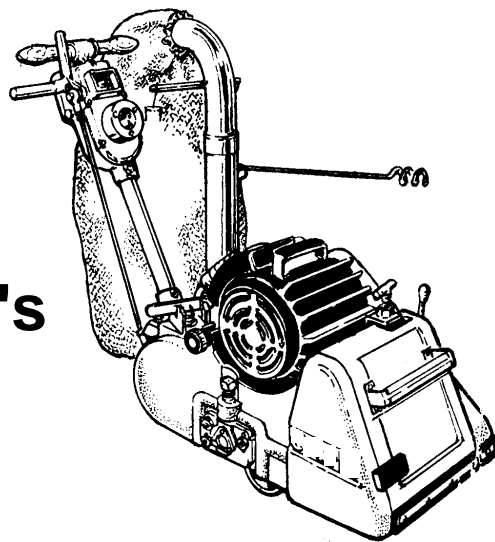

Operator's Manual



Apollo 8 Belt Sander

READ THIS BOOK

This book has important information for the use and safe operation of this machine. Failure to read this book prior to operating or attempting any service or maintenance procedure to your ALTO machine could result in injury to you or to other personnel; damage to the machine or to other property could occur as well. You must have training in the operation of this machine before using it. If you cannot read English, have this manual explained fully before attempting to operate this machine.

Si Ud. o sus operadores no pueden leer el Inglés, se hagan explicar este manual completamente antes de tratar el manejo o servicio de esta máquina.

All directions given in this book are as seen from the operator's position at the rear of the machine.

For new books write to: ALTO U.S. INC., 2100 Highway 265, Springdale, Arkansas 72764.

Table of Contents

Operator Safety Instructions	3
Introduction and Machine Specifications	5
230V Electrical Connection Instructions	6
How to Transport the Machine	7
One Person	7
Two People	8
Machine Set-Up	8
How to Operate the Machine	10
Sanding Cuts and Sandpaper	12
Chatter Wave Prevention	13
Sander Adjustment Procedures	14
Dust Shoe	14
Sanding Pressure	14
Belt Tracking	15
Operating Control	15
Routine Maintenance	16
Sanding Chamber	16
Wheels	16
Dust Bag	16
Drive Belt	16
Bearings	17
Rollers	17
Troubleshooting	18
Assembly Drawing #1	20
Assembly Parts List #1	21
Tension Assembly Drawing	22
Tension Assembly Parts	23
Assembly Drawing #2	24
Assembly Parts List #2	25
Assembly Drawing #3	26
Assembly Parts List #3	27
Wiring Diagram	28

OPERATOR SAFETY INSTRUCTIONS



WARNING



AVERTISSEMENT



ADVERTENCIA

DANGER means:	Severe bodily injury or death can occur to you or other personnel if the DANGER statements found on this machine or in this Owner's Manual are ignored or are not adhered to. Read and observe all DANGER statements found in this Owner's Manual and on your machine.
WARNING means:	Injury can occur to you or to other personnel if the WARNING statements found on your machine or in this Owner's Manual are ignored or are not adhered to. Read and observe all WARNING statements found in this Owner's Manual and on your machine.
CAUTION means:	Damage can occur to the machine or to other property if the CAUTION statements found on your machine or in this Owner's Manual are ignored or are not adhered to. Read and observe all CAUTION statements found in this Owner's Manual and on your machine.



DANGER:

Failure to read the Owner's Manual prior to operating or attempting any service or maintenance procedure to your American Sanders Technology machine could result in injury to you or to other personnel; damage to the machine or to other property could occur as well. You must have training in the operation of this machine before using it. **If you cannot read English, have this manual explained fully before attempting to operate this machine.**



DANGER:



















Sanding/finishing wood floors can create an environment that can be explosive. The following safety procedures must be adhered to:

- Cigarette lighters, pilot lights and any other source of ignition can create an explosion when active during a sanding session. All sources of ignition should be extinguished or removed entirely if possible from the work area.
- Work areas that are poorly ventilated can create an explosive environment when certain combustible materials are in the atmosphere, i.e., solvents, thinners, alcohol, fuels, certain finishes, wood dust and other combustible materials. Floor sanding machines can cause flammable material and vapors to burn. Read the manufacturer's label on all chemicals used to determine combustibility. Keep the work area well ventilated.
- Spontaneous combustion or an explosion can occur when working with sanding dust. The sanding dust can ignite and cause injury or damage. Sanding dust should be disposed of properly. Always empty the sanding dust into a metal container that is located outside of any building(s).
- Remove the contents of the dust bag when the bag is 1/3 full. Remove the contents of the dust bag each time you finish using the machine. Never leave a dust bag unattended with sanding dust in it.
- Do not empty the contents of the dust bag into a fire.
- Hitting a nail while sanding can cause sparks and create an explosion or fire. Always use a hammer and punch to countersink all nails before sanding floors.



DANGER:

Operating a machine that is not completely or fully assembled could result in injury or property damage. Do not operate this machine until it is completely assembled. Keep all fasteners tight. Keep adjustments according to machine specifications.

-  **DANGER:** Electrocutation could occur if maintenance and repairs are performed on a unit that is not disconnected from the power supply. Disconnect the power supply before attempting any maintenance or service.
-  **DANGER:** Electrocutation could occur if machine is used on ungrounded electrical circuit. Never remove or disable the grounding supply conductor on the electrical cord. Consult an electrician if the grounding conductor is missing or if you suspect your circuit is not grounded properly.
-  **DANGER:** Use of this machine with a damaged power cord could result in an electrical shock. Do not use the machine if the power cord is damaged. Do not use the electrical cord to move the machine.
-  **DANGER:** Electrocutation or injury could occur if the power cord is run over or damaged by the sander. Keep the cord free from under the machine to avoid contact with the sandpaper. Always lift the power cord over the machine.
-  **DANGER:** Moving parts of this machine can cause serious injury and/or damage. Keep hands, feet and loose clothing away from all moving parts of the sander.
-  **DANGER:** Operating a sander without all guards, doors or covers in place can cause an injury or damage. Always check to make sure that all of the guards, doors and covers are secure and in place.
-  **DANGER:** Injury to the operator or bystanders could occur if the machine's power is on while performing maintenance, changing or adjusting the belt, or changing the dust bag.
-  **DANGER:** Attempting to adjust the belt tracking while the machine is on can cause injury and/or damage. Do not perform belt tracking adjustments while sanding equipment is running.
-  **WARNING:** Fire could occur if the machine is used on a power circuit that repeatedly trips or is undersized. Have a licensed electrician check the fuse, circuit breaker or power supply.
-  **WARNING:** Failure to read and observe all safety statements found on your machine or in this Owner's Manual can result in serious injury or damage. Read and observe all safety statements. Make sure that all labels, decals, warnings, cautions, and instructions are fastened to the machine. Get new labels from your authorized American Sanders Technology distributor.
-  **WARNING:** In the event of a bag fire, injury can occur to the operator if the operator is tied or strapped to equipment. Use operating belt properly (follow procedure on page 8).
-  **WARNING:** Injury to the operator or bystander can occur if protective gear is not worn while sanding. Always use eye, ear, and respiratory protection while performing any sanding operation.
-  **WARNING:** Bodily injury could occur if power is applied to the machine with the power switch already in the "ON" position. Always check to assure that the power switch is in the "OFF" position before connecting power supply.
-  **CAUTION:** Maintenance and repairs performed by unauthorized personnel could result in damage or injury. Maintenance and repairs performed by unauthorized personnel will void your warranty. Servicing of this unit must always be referred to an authorized American Sanders Technology distributor.
-  **CAUTION:** Use of this machine to move other objects or to climb on could result in injury or damage. Do not use this machine as a step or furniture. Do not ride on this machine.
-  **CAUTION:** Damage could occur to the machine if not properly kept in a dry building for storage. Store the machine in a dry building.
-  **CAUTION:** The machine is heavy. When transporting the machine, remove the motor. Get help to lift the machine and motor.
-  **CAUTION:** Serious damage to the floor can occur if the machine is left running in one spot while the sanding drum is in contact with the floor. To avoid damage to the floor, feather cut in at a normal sanding rate. Do not dwell while lowering or raising the contact wheel. Always sand at a constant rate.

Introduction and Machine Specifications

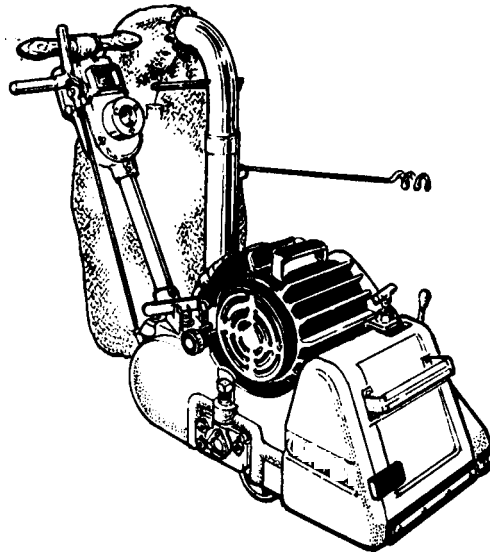

MODEL	07065B	07069C
CONTACT WHEEL SPEED (rpm)*	2700	2250
ABRASIVE SPEED	4700 *sfm	24 meters per second
DUST FAN SPEED (rpm)*	6800	5670
DUST FAN FLOW	234 *(cfm)	92 liters per second
MOTOR	4 hp 208-230V 60Hz 16A	2.2kW 240V 50Hz 12A
WHEELS	Replaceable 3½" O.D.	9 cm
ABRASIVE SIZE	29½" x 7 7/8"	75cm x 20cm
LEVELING CONTROL	Externally adjustable	
OPERATING CONTROL	Adjustable lever/grip	
MOTOR STARTER/PROTECTOR	Magnetic circuit breaker	
SANDING PRESSURE ADJMT.	Heavy, Medium, Light	
BEARINGS	Radial ball, permanently lubricated	
DIMENSIONS	40½" L x 15" W x 36 ¾" H	103cm x 38cm x 93 cm
WEIGHT	214 lbs.	97 kg

NOTE: *rpm (Revolutions per minute)
 *sfm (Surface feet per minute)
 *cfm (cubic feet per minute)

CAUTION: Your equipment may be inappropriate on some installations. Some softer woods used in flooring cannot support the pressure created by hard wheels.

Always consult with the flooring manufacturer on the proper installation, preparation, and finishing of their product. Determine suitability of your equipment in preparing the product.

230V Electrical Connection Instructions

CAUTION: This machine will operate only on AC frequency and on electrical voltage shown on the motor nameplate. Make sure you have the correct frequency and voltage before connecting the power cord to an outlet. The machine has a plug as shown in figure #1.

This machine must be connected to an electrically ground circuit in order to protect the operator from electric shock. This machine has an approved power cord with three conductors as well as a plug with three terminals. Connect the plug into a three holed receptacle. For maximum protection against electric shock, use a circuit that is protected by a ground fault circuit interrupter.

DANGER: Electrocutation could occur if the machine is exposed to water or rain. Keep the machine in a dry building.

DANGER: Electrocutation could occur if machine is improperly connected to the electrical system. To prevent possible electric shock, always use a 3-wire electrical system connected to an electrical ground. For maximum protection against electrical shock, use a circuit that is protected by a ground fault circuit interrupter. Consult your electrical contractor.

DANGER: Electrocutation could occur if the ground pin is tampered with in any way. Do not cut, remove, or break the ground pin. Do not try to fit a three-terminal plug into a receptacle or connector body other than a three plug receptacle or connector body. If the outlet does not fit the plug, consult your electrical contractor.

DANGER: Electrocutation could occur if the machine is used with a damaged plug or power cord. If the cords or plugs are worn or damaged in any way, have them replaced by an authorized service person or electrician.

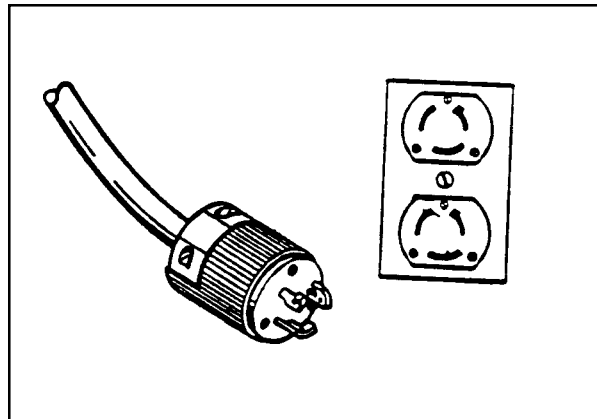

Figure 1

Extension Cords

Use only an approved three-pronged extension cord with two main conductors and one earthing conductor. This machine's power cord has a wire size of 10 gauge. This machine is equipped with a 100' power cord. When greater range is needed follow the table below to determine cable gauge of additional footage. Refer to the following chart for extension cord information.

Feet/Wire Gauge (Stranded Copper)		
Source Voltage	0 - 100'	100 - 250'
208	6	Use Voltage Booster
230	10	8

If motor appears to labor or takes a considerably longer time to come up to speed, reduce sanding pressure.

How to Transport the Machine

WARNING: The machine is heavy. Remove the motor from the machine before transporting. Get help loading the machine and motor. Use proper lifting techniques.

Transporting the Machine - One Person

To transport the machine, follow this procedure:

1. Make sure the power cable is disconnected from the electrical outlet.
2. Disconnect the handle pigtail cord connection. (twist and pull) See figure #2.
3. Loosen the belt tension T-screw completely.
4. Grasp the belt guard immediately above the left hand truck wheel and pull to gain access to the drive belts. Remove the drive belts. See figure #3.
5. Unscrew the motor mounting knob clear of the counterbore on chassis. See figure #4.
6. Straddle the machine. With your legs, lift the motor off of the chassis. Take the motor to worksite.
7. Lift the chassis by grasping the front and rear handle. Bring the belt guard against your chest. Take the chassis to worksite.

To assemble the machine after transporting, follow this procedure:

1. Open the belt guard door.
2. Place the motor assembly on the chassis.
3. Screw the motor mounting knob until it stops. See figure #4.
4. Install the drive belts.
5. Tighten the belt tension T-screw only until the contact drive wheel belt does not squeal upon start up (approximately 1/2" deflection at center of span with 10 lbs. of pressure.) Do not over tighten.

CAUTION: Premature bearing failure can occur if the fan belt is set too tight. The fan belt should deflect 1/2" at the center of the span with 5 lbs. of pressure.

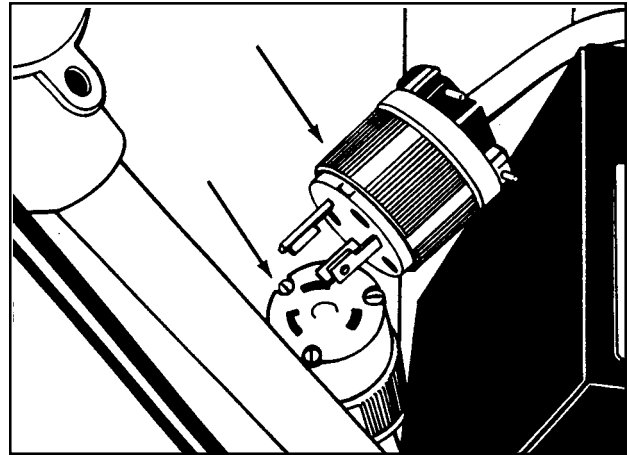

Figure 2

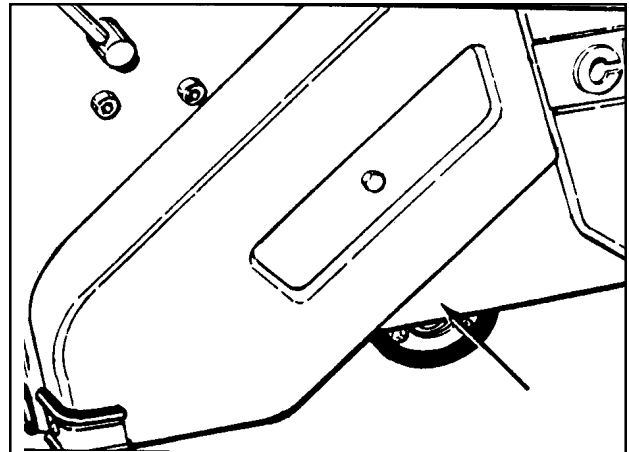

Figure 3

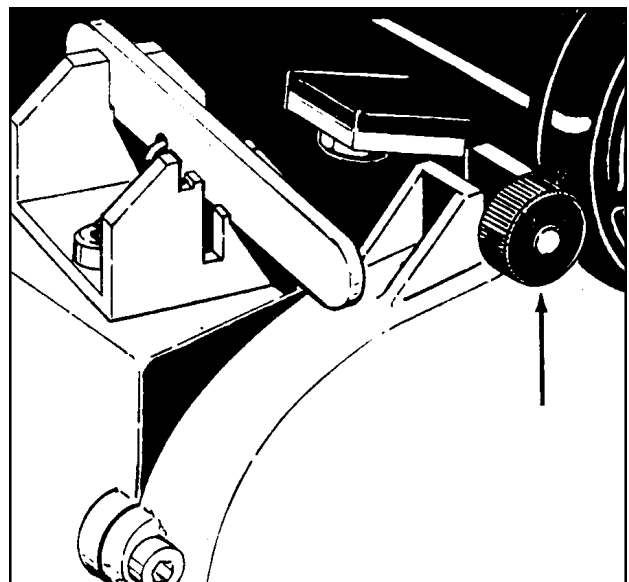

Figure 4

How to Transport the Machine (cont.)

Note: It is not necessary to adjust the fan belt independently during this procedure or during replacement. The idler pulley is factory adjusted.

6. Close the belt guard door.
7. Plug the motor pigtail in, twisting to lock.

Transporting the Machine - Two People

When transporting the machine with two people follow this procedure.

1. One operator places hands under the front of the machines main casting.
2. Person #2 lifts the machine by the handle.

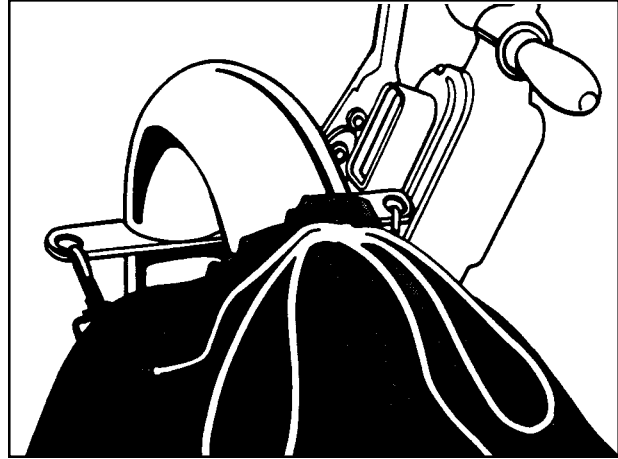

Figure 5

Machine Set-Up

To set-up your machine follow this procedure:

1. Familiarize yourself with the machine and read all danger, warning and caution statements. Make sure all operators of this machine have read this Owner's Manual. If they cannot read English, have the manual explained fully before allowing anyone to operate the sander.
2. Locate the power supply. The receptacle should be compatible with the plug. The receptacle must be grounded and must be fused (30 amp) to avoid an electrical hazard.
3. Clip the dust bag to the elbow. See figure # 5. Cross the strings on the dust bag and draw tight over the flare on the elbow. Wrap the string around the elbow and secure.
4. Wind the power cord through the cable arm. See figure #6. Keep the power cord out of path of equipment.
5. Pull the draw latch forward to release the access door to gain entry to the sanding chamber.
6. Rotate the release lever forward. See Figure #7.

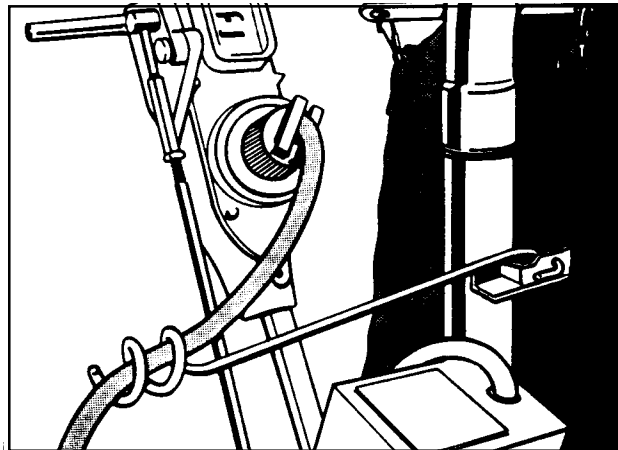

Figure 6

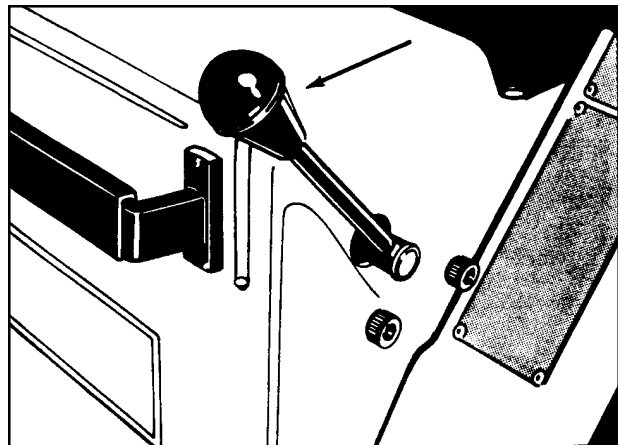

Figure 7

7. Install a new abrasive belt by sliding the abrasive over the tension roller and contact wheel. See figure #8.
8. Rotate the release lever upward and back to tighten the abrasive belt.
9. Make sure the motor circuit breaker is in the "Off" position. Plug the pigtailed power cord into the handle. Twist the cord connection clockwise to lock.
10. Jog (turn on momentarily) the motor circuit breaker while observing the belt tracking. Follow the procedures outlined in the "Sander Adjustment Procedures" on page 13 to correct the belt tracking. There is also a label on the inside of the access door that outlines the belt adjustment.
11. Close the access door. Place the end of the draw latch over the keeper on the access door and push the draw latch flat against the main-frame to secure.

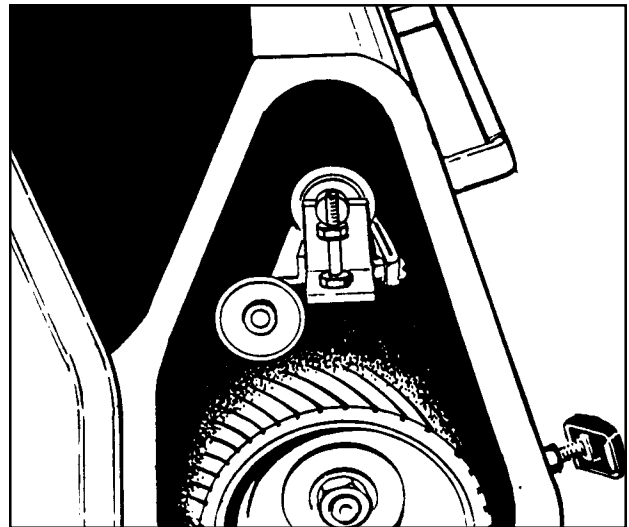





Figure 8

How to Operate the Machine

 **DANGER:** Sanding/finishing wood floors can create an environment that can be explosive. Cigarette lighters, pilot lights and any other source of ignition can create an explosion when active during a sanding session. All sources of ignition should be extinguished or removed entirely if possible from the work area.

 **DANGER:** Work areas that are poorly ventilated can create an explosive environment when certain combustible materials are in the atmosphere, i.e., solvents, thinners, alcohol, fuels, certain finishes, wood dust and other combustible materials. Floor sanding machines can cause flammable material and vapors to ignite. Read the manufacturer's label on all chemicals used to determine combustibility. Keep the work area well ventilated.

 **DANGER:** Sanding dust can spontaneously ignite and cause an injury or damage. Sanding dust should be disposed of properly. Always empty the sanding dust into a metal container. Remove the contents of the dust bag when the bag is 1/3 full.

 **DANGER:** Sanding dust can spontaneously ignite and cause an injury or damage. Remove the contents of the dust bag each time you finish using the machine. Always dispose of the dust in a metal container located outside of the building. Never leave a dust bag unattended with sanding dust in it. Do not empty the contents of the dust bag into a fire.

 **DANGER:** Hitting a nail while sanding can cause sparks and create an explosion or fire. Always use a hammer and punch to countersink all nails before sanding floors.

To operate the machine follow this procedure:

1. Before sanding, decide on best approach for sanding desired area. If the floor is uneven, it may be necessary to sand diagonally to the direction that the floor is laid. This will help "pull" or stretch low and high spots in the floor over a greater area, producing a flatter surface.

When sanding the area, work in a way so that you are moving away from where the cord set enters the room. This will help to avoid entanglement with the cord set and eliminate the need to move the cord set out of the way so frequently.

Work the area in a way that avoids interruption or termination points (an end of pass.) Make long continuous passes.

2. Swing cable arm to side of machine opposite the direction you intend to work. Rotate elbow on dust pipe until dust bag rest on motor. This will maintain balance and sanding pressure as the dust bag fills. The machine should be operated with the dust bag in this position whenever possible.
3. Install the operating belt as follows:
 - a. Position the operating belt around waist.
 - b. Cross the straps at the waist. See figure #9.
 - c. Slide the belt loop end over the handle on the control lever side. Adjust the length as needed.
 - d. Wrap the remaining strap around the opposite side of the handle and hold it in place with your hand.

 **WARNING:** Serious operator injury could occur if the operator has tied or strapped the loose end of the operator's belt strap to the machine. Always wrap the strap so that you can let go and get away quickly in case of bag fire or explosion.

4. Turn the control switch to the "On" position.

 **CAUTION:** To prevent damage to the floor, make sure the machine is in motion when the contact wheel is engaged with the floor.

5. Feather-cut in by easing the contact wheel down onto the surface with the control lever while the sander is in motion.

6. When contact wheel is fully engaged with the surface, gradually adjust your pace for adequate finish removal. Keep sander in motion while the contact wheel is engaged with the surface or dwell marks will occur.
7. Move the machine in the direction of the grain in the wood whenever it is possible. Sand the surface at a constant pace.
8. Gradually feather-cut out at the termination point by easing the contact wheel up with the control lever.
9. Repeat technique described in steps 5, 6, 7, and 8 and sand back down pass just made. When completed, begin a new pass by overlapping previous pass half the width of the abrasive. Stagger termination points to prevent a distinct ridge and a better blend when edging.
10. Empty contents of the dust bag into a metal container located outside the building. Dust bag should be emptied whenever full, as indicated on bag.

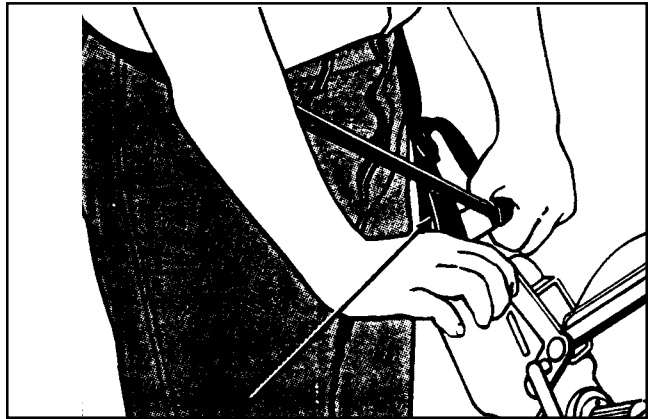

Figure 9

⚠ WARNING: Do not overfill dust bag or serious fire may result. Never leave a dust bag containing dust unattended. Sanding dust can spontaneously ignite and cause a fire or explosion. Use only genuine American Sanders Technology replacement bags.

⚠ CAUTION: An overfilled dust bag may affect machine balance and performance. Do not handle or disturb dust bag and elbow while sanding or damage to the floor may occur.

Sanding Cuts and Sandpaper

Initial Cut

The purpose of the initial cut is to remove old finish and gross imperfections on the floor surface. The sanding equipment should be adjusted to heavy sanding pressure setting and a coarse abrasive belt should be used. If the surface is severely damaged by deep scratches, preexisting dwell marks, uneven planks, etc., it may be necessary to sand across or diagonally to the grain to restore evenness to the surface. If these conditions are not present, the initial cut should be done in the direction of the grain.

If glazing, loading, or burning takes place immediately into an initial cut, select a coarser abrasive. If this should occur during an initial cut, the abrasive has dulled and must be replaced.

Final Cuts

The purpose of a finishing cut is to remove the scratches produced during the initial cut. Use a fine (60 - 80 grit) grain abrasive and a reduced sanding pressure setting.

If the surface remains rough after a finishing cut, it may be necessary to use an even finer grain of abrasive (80 - 100 grit). Care should be taken in selecting the grit size of the abrasive. A very fine grain will close the pores on a wood floor making admission of a stain difficult.

If glazing or burning should occur immediately into a finishing cut, reduce the sanding pressure. If it should occur during a finishing cut, the abrasive has dulled and must be replaced.

Abrasive Belts

Note: All part numbers listed are for a carton of 10 belts

Grain	Use	Aluminum Oxide	Silicon Carbide	Ceramic Alum.Oxide
16 grit	For removing gross imperfections and restore evenness to old flooring. To remove build-up of paints and varnishes.	-	945844	-
36 grit	For first sanding of new flooring (maple, oak). For removing minor imperfections and finishes from old flooring.	-	945842	945901
40 grit	For first sanding of new flooring (oak, walnut). For removing minor imperfections and finishes from old flooring.	-	945841	945902
50 grit	For first sanding of new flooring (cedar, pine, fir) For cleanup of 16 grit.	-	945840	945903
60 grit	For cleanup from initial cut 36 - 40 grit.	945839	-	945904
80 grit	For final sanding of certain hardwoods. For cleanup of initial cuts (50 grit).	945838	-	945905
100 grit	For final sanding of certain hardwoods where a smooth surface is desired.	945837	-	945909
120 grit	For final sanding of certain conifers.	945836	-	945910
150 grit	For final sanding of certain conifers where a smooth surface is desired.	945835	-	945911
180 grit	For surface roughing between coats of finish.	945834	-	-

Chatter Wave Prevention

American Sanders are designed and manufactured to the most rigid tolerances. However, after a finishing cut it is possible to see "chatter" or "waves".

The best guarantee to remove the chatter is to finish the floor with a rotating horizontal sander, such as American Sanders Technology's Sander 16.

To minimize chatter when using a belt or drum sander the following steps should be taken:

1. **DRUM MARKS**...are caused by the operator lowering the drum to the floor without forward traverse. These marks should be removed by cutting at a 45 degree angle to the mark. Cutting at the mark while maintaining the same path will only increase the mark depth and width. See figure #10.
2. **UNEVEN WALKING SPACE**...can leave lengthy "waves". The machine cuts more material during the slower pace. Pay particular attention to a steady, even pace.
3. **EXCESSIVE LIGHT CUTS**...may reveal high spots on the paper/contact wheel and cause chatter. Take a heavier cut and increase the pace.
4. **DEBRIS**...lodged between the paper and the drum will leave chatter. On a belt sander, debris may be adhered to the drum. Insure the drum is clean and free of debris before placing the paper on.
5. **ABRASIVE QUALITY**...may vary. Belt seams can be thicker on low quality paper and cause chatter. Use only American Sanders Technology specified sandpaper. Store abrasive according to manufacturers recommendation.

PROPER CARE OF YOUR MACHINE CAN MINIMIZE CHATTER AND WAVES.

1. **V-BELTS**...can cause vibration and chatter if they are of low quality. Use only belts specified by American Sanders Technology.
2. **TRUCK AND CASTER WHEELS**...with flat spots, out-of-roundness, or debris adhered to their surface can cause "waves" or a "chatter effect". Always clean and inspect all wheels before starting to sand, and before the finish cut. Replace or true the wheels if found to be out-of-round. Never allow the sander to stand on hard surfaces for lengthy periods of time.
3. **DUST PICK-UP SHOES**...may need adjusted differently for different materials that are to be sanded. An improperly adjusted shoe will leave trailing debris that will be run over by the wheels and cause "random waves".
4. **CONTACT WHEELS (DRUMS)**...may be out-of-round and cause "chatter". Contact your American Sanders Technology dealer for assistance to true or replace the drum.

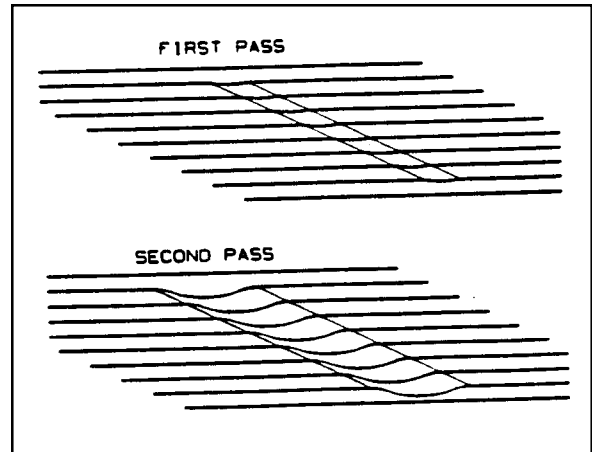

Figure 10

5. **BEARINGS**...in the motor, drum, or fan system may become worn and induce vibration which could cause "chatter".
6. **PULLEYS**...that are damaged or severely worn can induce vibration and cause "chatter". Contact your American Sanders Technology dealer for assistance.
7. **SANDPAPER TENSION**...should always be released when the machine is shut off for 10 minutes or longer to avoid compression of the drum.

NOTE: American Sanders Technology is not responsible for rework of floors that are unacceptable to the customer. It is your responsibility to insure your equipment is in proper operating order, and that you use the right machine for the job.

Sander Adjustment Procedures

⚠ DANGER: Electrocutation could occur if maintenance and repairs are performed on a unit that is not properly disconnected from the power source. Disconnect the power supply before attempting any maintenance or service.

⚠ DANGER: Moving parts of this machine can cause serious injury and/or damage. Keep hands, feet and loose clothing away from all moving parts of the sander.

The following information provides details on how to adjust different features/controls of the sander.

Dust Shoe

To adjust the dust shoe follow this procedure:

1. Disconnect machine from power supply.
2. Loosen the two screws fastening the dust shoe to the chassis.
3. Adjust the dust shoe down to reduce clearance.
4. Adjust the dust shoe up to increase clearance.
5. Align the dust shoe to the chassis and tighten screws. See figure #11.

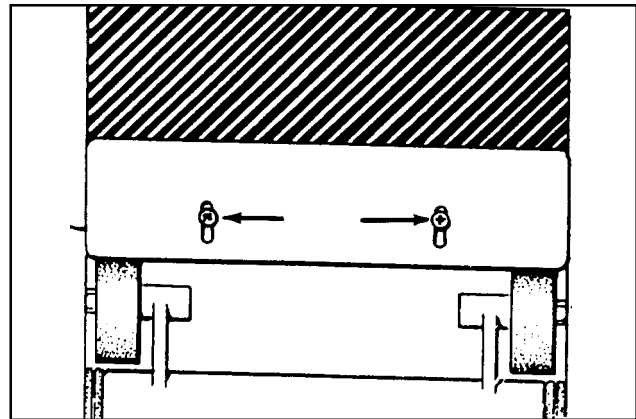

Figure 11

Sanding Pressure

There are three pressure settings to select from: heavy, medium and light. The lower the position the heavier the setting. To change settings, raise the lever and place in desired position. See figure #12.

Leveling

⚠ CAUTION: The belt tracking may be adversely effected if machine is operated unlevelled.

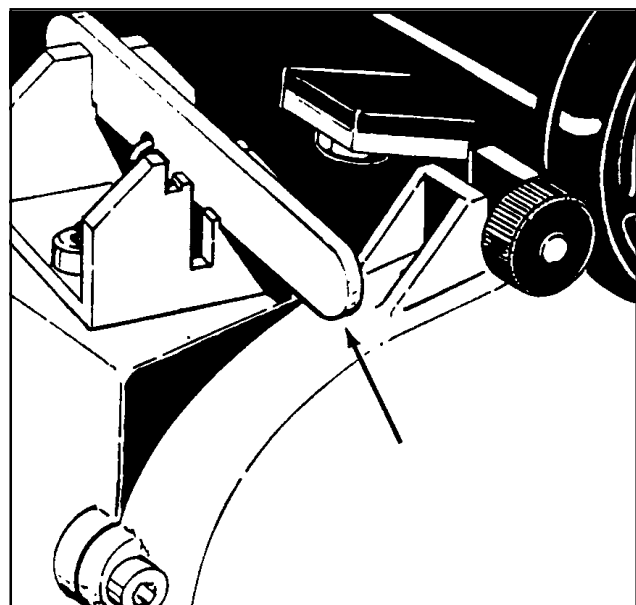

Figure 12

The machine is factory set and no adjustments should be necessary. After any maintenance is performed to the carriage system, pointer must be returned to original mark (See figure 13).

If it is necessary to reset level after replacing wheels follow this procedure:

1. Lower contact wheel and loosen all three clamping nuts.
2. Drive adjusting screw **in**, to sand heavier on the left (the drive belt side). Back adjusting screw **out**, to sand heavier on the right (the side opposite the drive belts). Make sure the bearing carrier follows the adjusting screw.
3. Tighten the clamping nuts and test setting on an even surface. Make further adjustments if necessary.
4. Mark new pointer location on main frame

Belt Tracking

▲ WARNING: Injury to the operator could occur if any machine adjustments are made while the motor is running. Do not attempt to make any adjustments while the machine is plugged in or running.

To adjust the belt tracking follow this procedure:

1. Locate the belt tracking adjuster screw. See figure #14a.
2. Hold the belt tracking adjuster screw and loosen the locknut. See figure #14b.
3. Rotate the tracking adjuster screw counterclockwise to move the belt in.
4. Rotate the tracking adjuster screw clockwise to move the belt out.
5. Test adjustment and tighten the locknut.

Operating Control

To **increase** the travel or extend the reach on the grip control follow this procedure:

1. Hold the control rod and loosen the locknut. See figure 15.
2. Screw the control rod **in** until the desired reach is found.
3. Tighten the locknut.

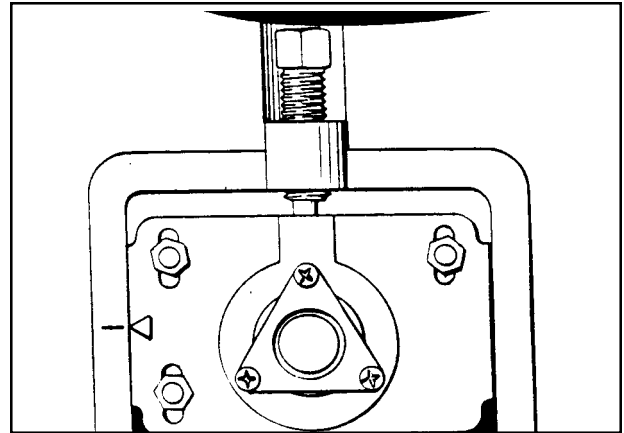

Figure 13

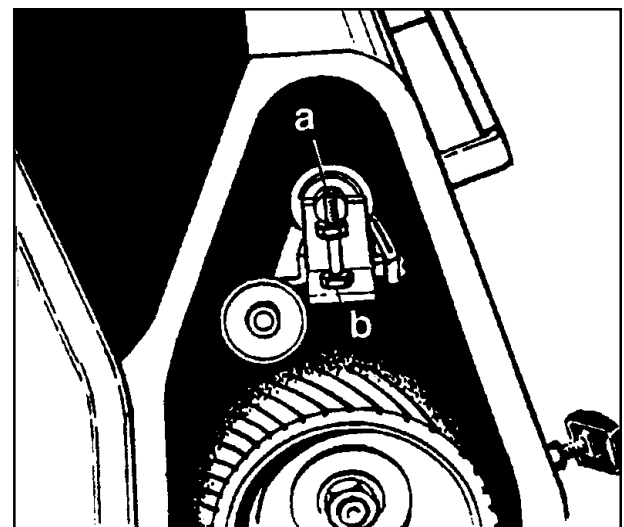

Figure 14

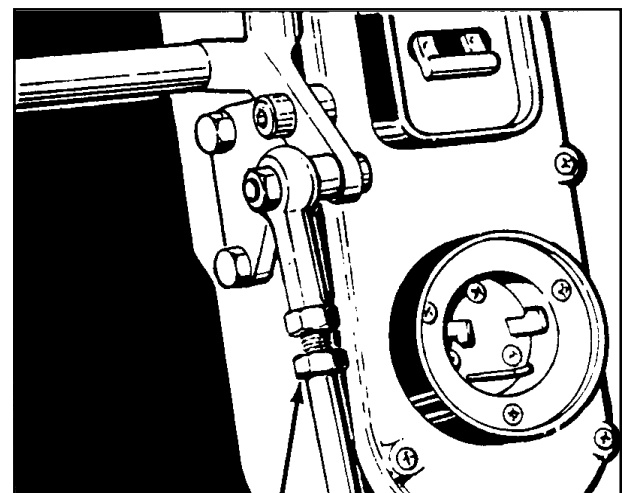

Figure 15

Sanding Adjustment Procedures (CONT)

To **decrease** the travel or reduce the reach on the grip control follow this procedure:

1. Hold the control rod and loosen the locknut. See figure #16.
2. Screw the control rod **out** until desired reach is found.
3. Hold the control rod and tighten the locknut.

Routine Maintenance

The following items need to be periodically inspected and maintained to keep your sander in good working condition.

Sanding Chamber

Periodically blow out the sanding chamber to prevent large accumulations of debris which could interfere with the engine.

Bearings

Periodically check the bearings for wear or damage according to the following schedule:

<i>Guide rollers</i>	after 1 st 650 hrs.
<i>Idler pulley</i>	after 1 st 1500 hrs.
<i>Fan shaft</i>	after 1 st 2500 hrs.
<i>Tension roller</i>	after 1 st 2500 hrs.
<i>Arbor shaft</i>	after 1 st 5000 hrs.
<i>Motor shaft</i>	after 1 st 5000 hrs.

Rollers

Periodically check the guide rollers and the tension roller for wear.

Troubleshooting

Problem	Cause	Action
Drive belts slip. (Squeaking or squealing sound)	Insufficient tension.	Tension drive belt as described in adjustment procedures. (See pg. 7)
	Worn belts.	Replace belts.
Squealing, growling or grinding noise coming from machine.	Damaged and/or worn bearing.	Remove drive belts, rotate arbor motor, fan, shafts and idler pulley to locate dragging or rough bearing. Contact an authorized ALTO dealer.
Dust pickup is poor.	Dust bag is over 1/3 full.	Empty contents of bag.
	Dust bag is dirty.	Shake debris from bag and wash.
	Dust shoe is improperly adjusted.	Readjust dust shoe.
	Dust chute is obstructed.	Remove fan cover and clear throat.
Motor will not start.	Defective motor starter.	Contact an authorized ALTO dealer.
	Defective start capacitor.	Contact an authorized ALTO dealer.
	Defective electronic start switch.	Contact an authorized ALTO dealer.
	Low voltage from poor connection.	Contact an authorized ALTO dealer.
	Defective motor.	Contact an authorized ALTO dealer.
	No power.	Check power supply and connections.
Motor runs sluggishly.	Low voltage from excessive footage, undersized extension cord, or poor connection.	Locate power source nearer to work site. Decrease sanding pressure.
	Defective run capacitor.	Contact an authorized ALTO dealer.
	Defective motor.	Contact an authorized ALTO dealer.
Motor circuit breaker trips/ repeatedly trips.	Excessive load.	Contact an authorized ALTO dealer.
	Defective electronic start switch.	Contact an authorized ALTO dealer.
	Defective motor starter.	Contact an authorized ALTO dealer.
	Low voltage from poor connection.	Contact an authorized ALTO dealer.
	Defective motor.	Contact an authorized ALTO dealer.
	Defective capacitor.	Contact an authorized ALTO dealer.
Uneven cuts.	Leveling out of adjustment.	Readjust leveling. Fig. 13 page 15.
	Abrasive belt tracking.	Adjust belt to track towards the edge of drum with deepest cut.

Troubleshooting

Problem	Cause	Action
Burning or glazing.	Dull abrasive. Excessive sanding pressure. Too fine of an abrasive belt.	Replace abrasive. Decrease sanding pressure setting. (Fig. #12, page 14). Use coarser abrasive.
Slow cutting.	Dull abrasive. Too fine of an abrasive belt. Insufficient sanding pressure.	Replace abrasive. Use a coarser abrasive belt. Increase sanding pressure setting. (Fig. #12, page 14).
Waves on sanded surface.	Debris on wheels. Flat spot on tire(s).	Remove and clean wheels. Replace tires.
Chatter marks on sanded surface. (Close evenly spaced ripples)	See Chatter Wave Prevention, page 13.	See Chatter Wave Prevention, page 13.
Difficult to actuate tension release lever.	Debris interferes with mechanism Worn sleeve bearing. Galled linkages.	Blow out sanding chamber. Remove and disassemble mechanism. Clean out. Replace. Lubricate with WD-40.
Abrasive belt hunts (seeks).	Worn washers. Worn sleeve bearing. High edges on contact wheel.	Replace (items #84 & 88, pg. 20,21). Check for excessive play, replace. Contact an authorized ALTO dealer or replace the contact wheel.
Abrasive belt will not track.	Extreme difference in side-to-side length of belt. High edge on contact wheel.	Replace abrasive belt. Check several different abrasive belts. Contact an authorized ALTO dealer or replace the contact wheel.
Abrasive belt tears along its length.	Debris built-up on (top) tension roller.	Clean tension roller.

AMERICAN SANDERS TECHNOLOGY
Apollo 8 Belt Sander
Assembly Drawing #1 12/00

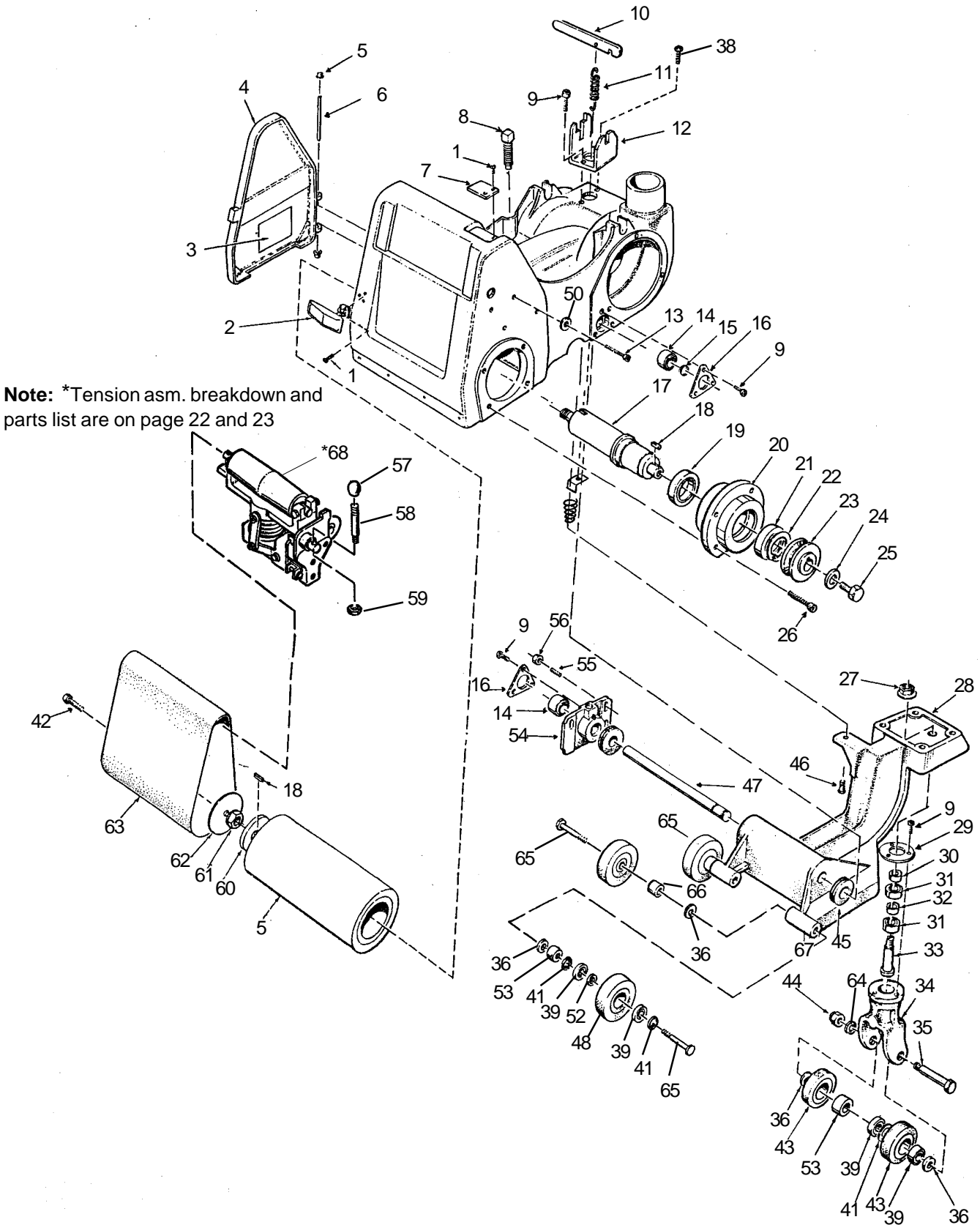

AMERICANSANDERSTECHNOLOGY
Apollo 8 Belt Sander
Assembly Parts List #1 12/00

Ref No.	Part No	Description	Qty
1	85517A	Screw, 10-24 x ½ PN	5
2	55710A	Latch	1
3	77057A	Label, Belt Tracking	1
4	22302A◆	Door Access	1
5	50765A	Wheel, Contact	2
6	66545A	Pin Access Door	1
7	61411A	Pad, T-Screw	1
8	86206A	Screw, Set, ¾-10 x 3	1
9	962823	Screw, ¼-20 x ½ PN	11
10	60015A	Lever, Pressure Adj.	1
11	58691A	Spring, Pressure	1
12	60014A	Bracket, Pressure Adj.	1
13	86112A	Screw ¾ -16 x ¾	3
14	51190A	Bearing	2
15	57714A	Ring, Retaining ¾" Dia.	1
16	66972A	Retainer, Bearing	2
17	67464A	Shaft, Arbor	1
18	65309A	Key, ¼ x 7/8	2
19	51172A	Bearing	1
20	61641A	Carrier, Bearing	1
21	51171A	Bearing	1
22	57844A	Ring, Retaining	1
23	66189A	Pulley, Drum	1
24	87034A	Retainer, Pulley	1
25	962244	Screw, ¾ -16 x ¾"	1
26	86110A	Screw, ¾ -16 x 1	4
27	81209A	Nut, ½-13 Flanged	1
28	23423C◆	Frame, Truck	1
29	66913A	Retainer, Bearing	1
30	67812A	Spacer	1
31	51112A	Bearing	2
32	67821A	Spacer	1
33	60715B	Bolt, Pivot	1
34	29403C◆	Yoke, Wheel	1

Ref No.	Part No	Description	Qty
35	60101A	Axle, Caster	1
36	87003A	Washer	4
37	50933A	Retainer, Spring	1
38	962988	Screw, ¼-20 x 1 ¼	1
39	902606	Bearing	10
40	Ref. only	Hub (included in Ref. #43)	2
41	747304	Ring, Retaining	8
42	87700A	Screw, ¼-20 x ½	1
43	19611A	Wheel Asm, Rear Caster	2*
44	920196	Nut, ½ -13	1
45	833401	Spacer	1
46	82504A	Pin, Clevis, 5/16 x ¾	1
47	60514A	Axle, Truck	1
48	19610A	Asm. Truck Wheel	3*
49	87029A	Washer ¾	1
50	87000A	Washer, Flat	3
51	50837A	Spring, Compression	1
52	67862A	Spacer	3
53	67810A	Spacer	2
54	21401A	Carrier, Bearing	1
55	68010A	Stud, ¾-16 x ¾-24 x 1 ½	3
56	81215A	Nut, ¾-24 Serrated Flange	3
57	815051	Knob	1
58	64467A	Lever, Release	1
59	920110	Nut, 5/16-18 ESNA	1
60	87030A	Retainer, Drum	1
61	81106A	Nut, ¾-10	1
62	68674A	Plate, Drum, End	1
63	Page 11	Abrasive	Ref
64	87101A	Washer, ½ Lock	1
65	85729A	Shaft Wheel	3
66	67890A	Spacer Wheel	2
67	962184	Screw Set ¼-20 x ¾	2
68**		Tension Assembly	1

Note: ◆ indicates a change has taken place since last publication of this manual

Note: *Includes Hub and Tire (Machined)

Note: **Tension Asm. breakdown and parts list on page 22 & 23

AMERICAN SANDERS TECHNOLOGY
Apollo 8 Belt Sander
Tension Assembly Drawing 10/00

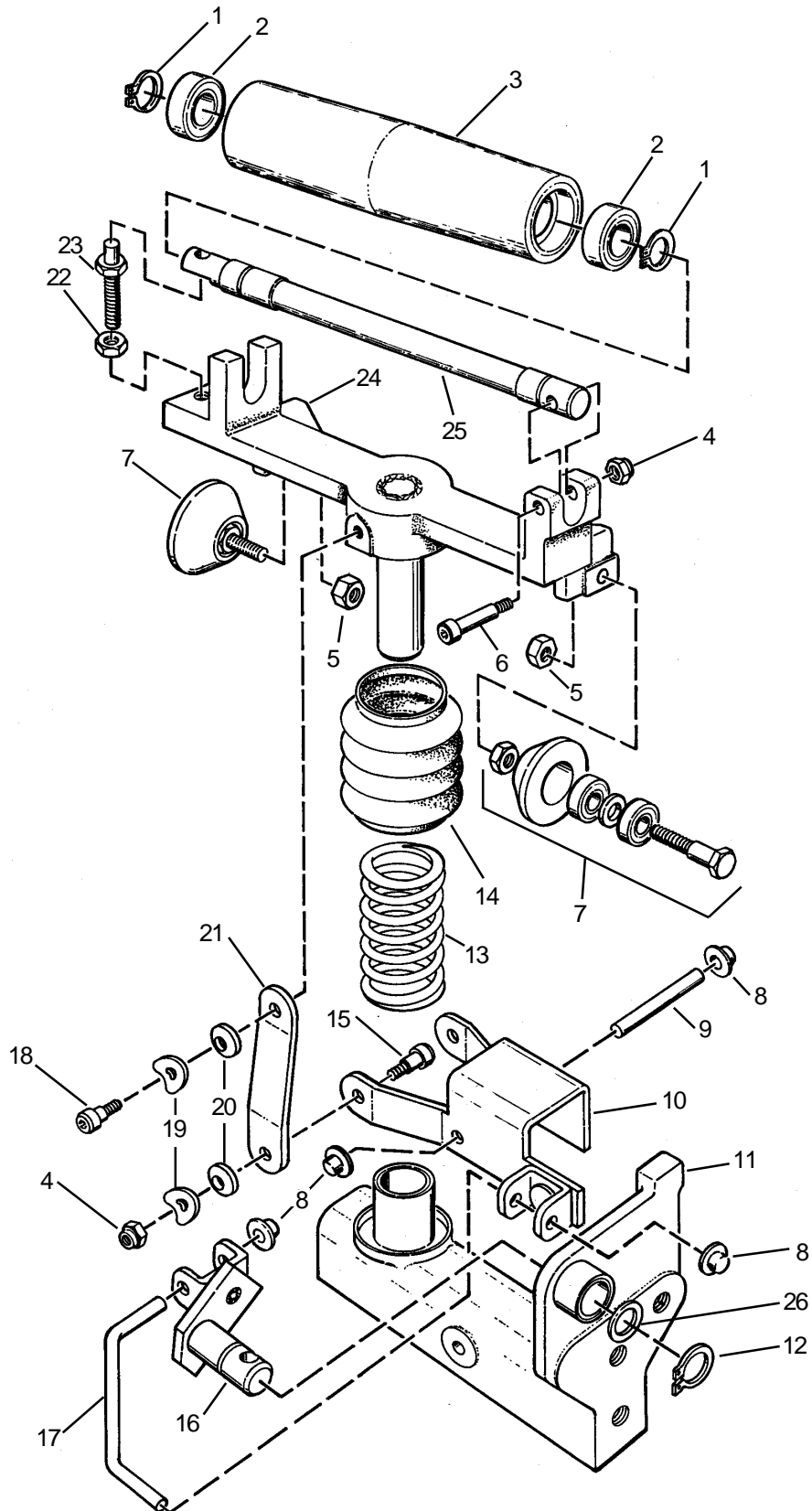

AMERICAN SANDERS TECHNOLOGY
Apollo 8 Belt Sander
Tension Assembly Parts List 10/00

Ref No.	Part No	Description	Qty
1	747380	Retaining Ring ⁹ / ₁₆	2
2	902567	Bearing	2
3	67201B	Roller	1
4	920296	Nut, 10-24	3
5	81102A	Nut, ¹ / ₄ -20	2
6	80020A	Shoulder Bolt, ¹ / ₄ x 1	1
7	14701A	Guide, Roller Asm.	2
8	81501A	Pushnut ¹ / ₄	4
9	66537A	Pin	1
10	50772A	Draw Weldmt.,Lever	1
11	50773A	Support, Tension Arm	1
12	797301	Retaining Ring ⁵ / ₈	1
13	53410A	Spring, Tension	1
14	50719A	Boot, Tension Spring	1
15	961014	Shoulder Bolt, ¹ / ₄ x ³ / ₈	2
16	61804A	Cam Weldment	1
17	65709A	Connecting Link	1
18	80018A	Shoulder Bolt, ¹ / ₄ x ¹ / ₄	2
19	87502A	Washer, ¹ / ₄ Bowed	4
20	87503A	Washer ¹ / ₄ Beveled	4
21	50770A	Draw Link	2
22	81303A	Nut, ¹ / ₄ -28 Jam	1
23	60150A	Aduster, Tracking	1
24	50771A	Carriage, Roller	1
25	67465A	Shaft, Roller	1
26	980018	Washer, Nylon	1

AMERICAN SANDERSTECHNOLOGY
 Apollo 8 Belt Sander
 Assembly Drawing #2 12/00

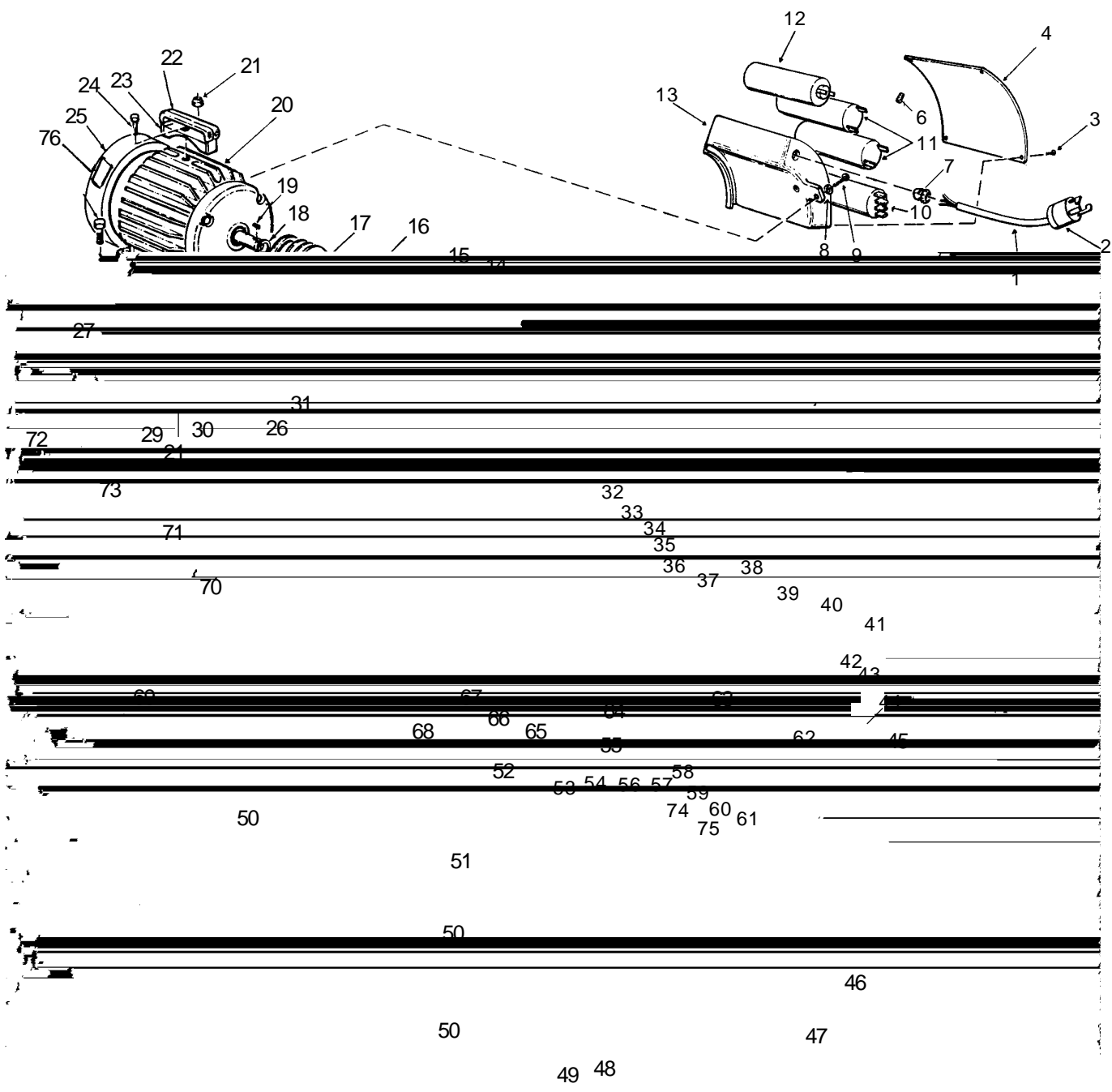

AMERICANSANDERSTECHNOLOGY
Apollo 8 Belt Sander
Assembly Parts List #2 12/00

Ref No	Part No.	Description	Qty
1	41945A	Motor, Cord	1
2	45604A	Plug	1
3	962330	Screw, 6-32 x 3/8	4
4	73715A	Plate, Elec./Fire Warning	1
6	170674	Wire, Nut	2
7	697502	Strain, Relief	1
8	980614	Washer, 1/4	2
9	962823	Screw, 1/4-20 x 1/2 Pn	2
10	47378A	Switch, Start	1
11	41305A	Capacitor, Start	2
12	41304A	Capacitor, Run	1
13	22904A	Enclosure, Motor Start	1
14	962244	Screw, 3/8-16 x 3/4 Hx	1
15	87034A	Retainer, Pulley	1
16	51032A	Belt, Fan	1
17	66189A	Pulley, Motor	1
18	57712A	Ring, Retaining 1 1/8	1
19	915098	Key, 1/4 x 1 1/2	1
20◆	44639A	Motor, 4HP 230V 60Hz	1
◆	44664A	Motor, 2.2kW, 240V 50Hz	1
21	920342	Nut, 3/8-16 ESNA	4
22	32357A	Cover, Handle	4
23	64460A	Handle, Motor	1
24	962870	Screw, 3/8-16 x 1 BT	1
25	52769A	Cover, Fan	1
26	85703A	Screw, 3/8-16 x 1 1/2 Hx	4
27	68394A	Screw-T	1
28	65304A	Knob, Motor Mounting	1
29	65959A	Mount, Motor Front	1
30	51024A	Belt, 3V x 375	1
31	65960A	Mount, Motor Rear	1
32	81202A	Nut, 7/16 LH	1
33	87002A	Washer	1
34	34264A	Gasket, Fan, Cover	1
35	23301A	Fan	1
36	61602A	Collar, spacer	1
37	902567	Bearing	1
38◆	22126C	Cover, Fan	1

Ref No	Part No.	Description	Qty
39	65302A	Key	1
40	67445A	Shaft, Fan	1
41	85813A	Screw, 5/16-18 x 1 Hx	3
42	51111A	Bearing	1
43	877304	Ring, Retaining	1
44	66169A	Pulley, Fan	1
45	80017A	Bolt, Shoulder, 3/8 x 3/4	1
46◆	23808A	Guard, Belt	1
47	85700A	Screw, 1/4-20 x 1 Hx	1
48	31221A	Bumper, Side	1
49	66932A	Retainer, Side, Bumper	1
50	85517A	Screw, 10-24 x 1/2	8
51	81102A	Nut, 1/4-20 ESNA	2
52	68393A	Tube, Latch	1
53	60623A	Bracket, Latch	1
54	85702A	Screw, 1/4-20 x 1 3/4	1
55	171101	Nut, 3/8-16 Serrated Flange	1
56	60414A	Arm, Idler	1
57	67875A	Spacer	1
58	57801A	Ring, Retaining	1
59	902619	Bearing	1
60	66170A	Pulley, Idler	1
61	962216	Screw, 3/8-16 x 1 1/4	1
62	81108A	Nut, 3/8-24	1
63	920110	Nut, 5/16-18 ESNA	1
64	68010A	Stud, 3/8-16 x 3/8-24 x 1 1/2	1
65	86111A	Screw, 1/4-20 x 1/2	1
66	980657	Washer 1/4 Lock	1
67	61600A	Clip	1
68	67614A	Shoe, Dust	1
69	66971A	Retainer, Bumper	1
70	31232A	Bumper, Front	1
71◆	25906A	Mainframe	1
72	87700A	Screw, 1/4-20 x 1/2 B.H.	4
73	64489A	Handle, Front	1
74	930093	Rivet	2
75	74045A	Label, Warning, Moving Parts	1
76	77234A	Label, Warning, Lifting	1

Note: ◆ indicates a change has taken place since last publication of this manual

Motor Parts Not Illustrated

Part #	Description	Qty.
52768A	Front Cover	1
53998A	Fan	1
52769A	Fan Cover	1

Part #	Description	Qty.
51188A	Bearing Front	1
902547	Bearing Rear	1
40316A	Armature Assembly	1

AMERICAN SANDERSTECHNOLOGY
Apollo 8 Belt Sander
Assembly Drawing #3 12/00

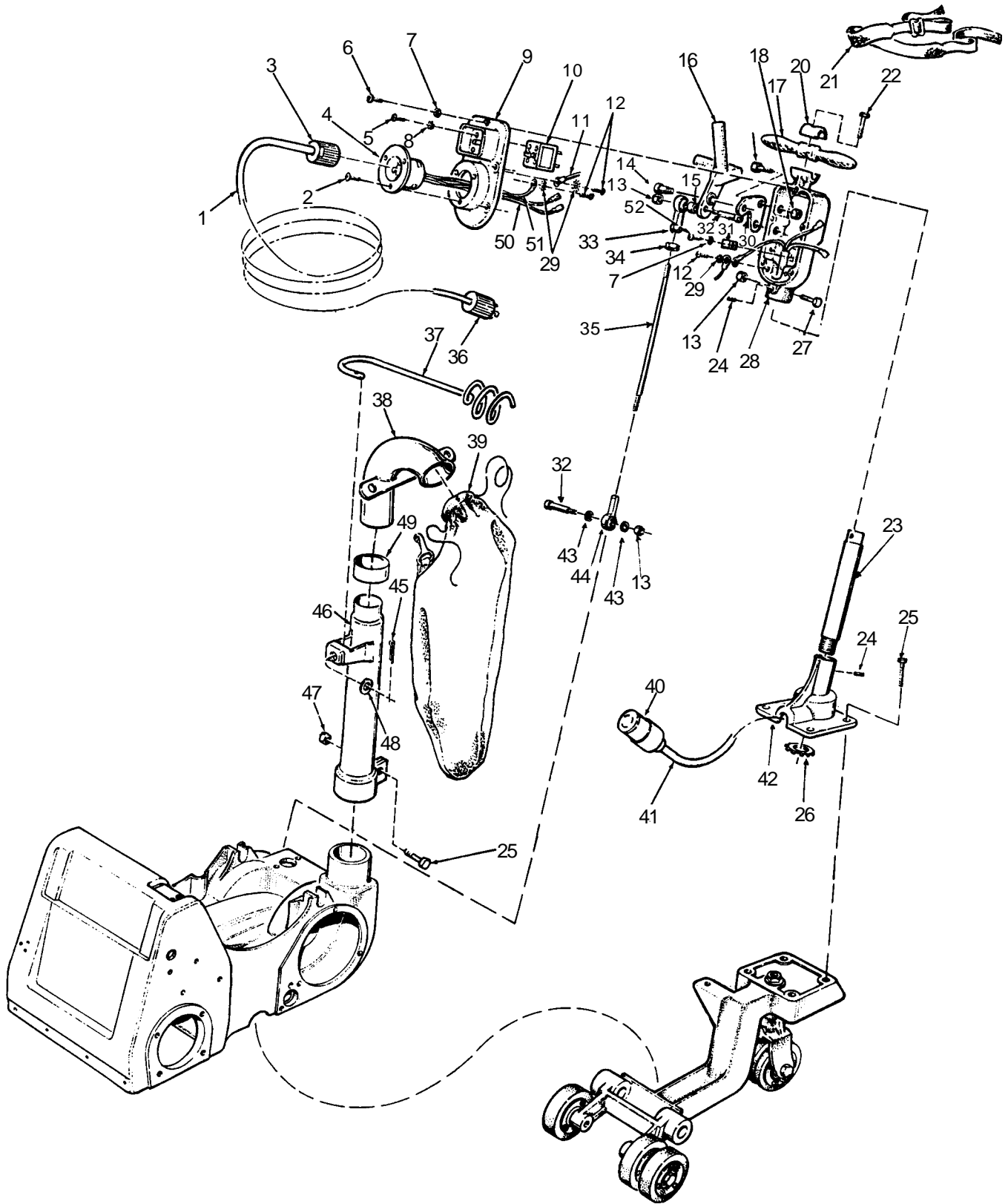

AMERICANSANDERSTECHNOLOGY
Apollo 8 Belt Sander
Assembly Parts List #3 12/00

Ref. No	Part No.	Description	Qty
1◆	42201A	Cord Set 230V 60 Hz	1
	42302A	Cord Set, 240V 50 Hz	1
2	962065	Screw, 8-32 x ¼	3
3◆	41706A	Connector, NEMA	1
4◆	43501A	Inlet, NEMA	1
5	85313C	Screw, 6-32 x ¾	4
6	962794	Screw 10 x 24 x 1	5
7	980650	Washer, ⅜ Lock	7
8	980607	Washer, 1106	4
9◆	22127C	Cover, Switch, Box	1
10◆	41411A	Switch, Circuit Breaker	1
11	48901A	Asm., Wire	1
12	962015	Screw, 10-24 x ⅜	5
13	920110	Nut, ⅝-18 ESNA	4
14	80022A	Bolt, Shoulder ½ x ⅝	1
15	898203	Spacer	1
16	25603A	Lever, Control	1
17	962481	Screw ¼-20 x 1¼	2
18	81102A	Nut ¼-20 ESNA	2
19	64405A	Handle, Steering	1
20◆	21904C	Clamp, Handle	1
21	60724A	Belt, Operating	1
22	85818A	Screw, ⅝-18 x 2½	1
23	60016A	Pipe, Handle	1
24	86200A	Screw, Set ⅜-16 x ⅝	2

Note: ◆ indicates a change has taken place since last publication of this manual

Ref. No	Part No.	Description	Qty
25	962288	Screw, ⅜-16 x 1	5
26	82104A	Nut, ¼ NPS	1
27	85816A	Screw, ⅝-18 x 1¾	1
28◆	20704C	Box, Switch	1
29	980699	Washer, 1110	3
30	69441A	Bracket, Control Lever	1
31**	51074A	Clamp, Cable	2
32	80035A	Bolt, Shoulder, ⅜ x 1¼	2
33	53537A	Rod, End	1
34	920204	Nut, ⅜-24	1
35	67150A	Rod, Control	1
36◆	45608A	Plug, NEMA	1
37	60401A	Arm, Cable	1
38	62800A	Elbow, Dust, Pipe	1
39	60721A	Bag, Dust	1
40	41707A	Connector	1
41	41917A	Cord, Interconnect	1
42◆	23200C	Mount, Control, Handle	1
43	980022	Washer, Wave	2
44	53538A	Rod, End	1
45	925036	Pin, Cotter	1
46	66150A	Pipe, Dust	1
47	920342	Nut, ⅜-16 ESNA	1
48	980651	Washer, ⅜-Plain	1
49	38109A	Seal, Dust Pipe	1
50	49023A	Wire Asm.	2
51	48901A	Wire Asm. Gnd	1
52**	85517A	Screw 10-24 x ½	2
NI	77039B	Label "Made in USA"	1

NOTE: **#31 & #52 only one shown

AMERICAN SANDERS TECHNOLOGY
 Apollo 8 Belt Sander
 Wiring Diagram 4/95

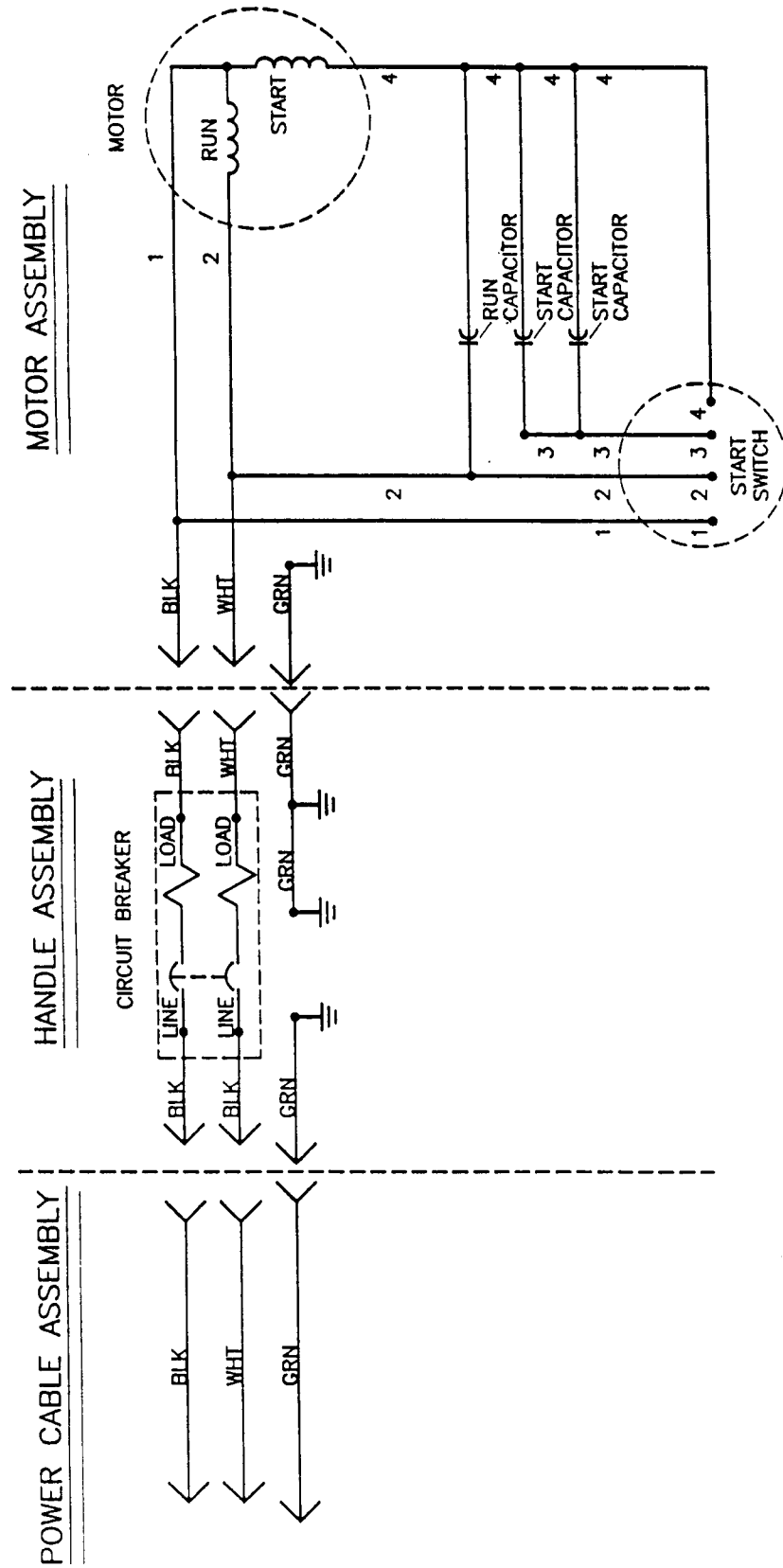

ALTO® PRODUCT SUPPORT BRANCHES

U. S. A. Locations

HEAD OFFICE

ALTO U.S. Inc., St. Louis, Missouri
390 S. Woods Mill Rd., Suite 300
Chesterfield, Missouri 63017-3433

PRODUCTION FACILITIES

ALTO U.S. Inc., Springdale, Arkansas
2100 Highway 265
Springdale, Arkansas 72764
(501) 750-1000
Customer Service - 1-800-253-0367
Technical Service - 1-800-356-7274

ALTO U.S. Inc., Bowling Green, Ohio 43402
1100 Haskins

ALTO U.S. Inc., Clearwater, Florida 33765
1500 N. Belcher Road

SERVICE FACILITIES

ALTO U.S. Inc., Carlstadt, New Jersey 07072
150 Commerce Road
(201) 460-4774

ALTO U.S. Inc., Elk Grove, Illinois 60007
2280 Elmhurst Road
(847) 956-7900

ALTO U.S. Inc., Denver, Colorado 80204
1955 West 13th Ave.
(303) 623-4367

ALTO U.S. Inc., Houston, Texas 77040
7215 North Gessner Road

SALES AND SERVICE FACILITIES

ALTO U.S. Inc., Madison Heights, Michigan 48071-0158
29815 John R.
(810) 544-6300

ALTO U.S. Inc., Marietta, Georgia 30062
1355 West Oak Common Lane
(770) 973-5225

CLARKE TECHNOLOGY
AMERICAN SANDERS TECHNOLOGY
A.L. COOK TECHNOLOGY
Customer Service Headquarters and Factory
2100 Highway 265
Springdale, Arkansas 72764
(501) 750-1000

Technical Service
1-800-356-7274

European Locations

PRODUCTION FACILITIES

ALTO Danmark A/S, Aalborg
Blytaekkervej 2
DK-9000 Aalborg
+45 72 18 21 00

ALTO Danmark A/S, Hadsund
Industrikvarteret
DK-9560 Hadsund
+45 72 18 21 00

SALES SUBSIDIARIES

ALTO Canada Ltd., Rexdale Ontario
24 Constellation Ct.
(416) 675-5830

ALTO Overseas Inc., Sydney (Australia)
1B/8 Resolution Drive
Caringbah NSW 2229
+61 2 9524 6122

ALTO Cleaning Systems Asia Pte Ltd., Singapore
271 Bukit Timah Rd.
#04-11 Balmoral Plaza
Singapore 259708
+65 8366 455

ALTO Deutschland GmbH, Fronenberg (Germany)
Ardeyer Str. 15
D-58730 Fronenberg
+49 2373 754 200

ALTO Cleaning Systems (UK) Ltd., Penrith
Gilwilly Industrial Estate
Penrith
Cumbria CA11 9BN
+44 1768 868 995

ALTO France S.A. Strasbourg
B.P. 44, 4 Place d'Ostwald
F-67036 Strasbourg
Cedex 2
+33 3 8828 8400

ALTO Nederland B.V. Vianen
Stuartweg 4C
NL-4131 NJ Vianen
+31 347 324000

ALTO Sverige AB, Molndal (Sweden)
Aminogatan 18
Box 4029
S-431 04 Molndal
+46 31 706 73 00

ALTO Norge A/S, Oslo (Norway)
Bjornerudveien 24
N-1266
+47 2275 1770

AMERICAN SANDERS TECHNOLOGY U. S. WARRANTY

This ALTO Industrial/Commercial Product is warranted to be free from defects in materials and workmanship under normal use and service for a period of one year from the date of purchase, when operated and maintained in accordance with American Sanders Technology's Maintenance and Operations Instructions.

This warranty is extended only to the original purchaser for use of the product. It does not cover normal wear parts such as electrical cable or V-belts.

If difficulty develops with the product, you should:

- (a). Contact the nearest authorized American Sanders Technology repair location or contact the American Sanders Technology Service Operations Department, 2100 Highway 265, Springdale, Arkansas 72764, for the nearest authorized American Sanders Technology repair location. Only these locations are authorized to make repairs to the product under this warranty.
- (b). Return the product to the nearest American Sanders Technology repair location. Transportation charges to and from the repair location must be prepaid by the purchaser.
- (c). American Sanders Technology will repair the product and or replace any defective parts without charge within a reasonable time after receipt of the product.

American Sanders Technology's liability under this warranty is limited to repair of the product and/or replacement of parts and is given to purchaser in lieu of all other remedies, including INCIDENTAL AND CONSEQUENTIAL DAMAGES.

THERE ARE NO EXPRESS WARRANTIES OTHER THAN THOSE SPECIFIED HEREIN. THERE ARE NO WARRANTIES WHICH EXTEND BEYOND THE DESCRIPTION OF THE FACE HEREOF. NO WARRANTIES, INCLUDING BUT NOT LIMITED TO WARRANTY OF MECHANABILITY, SHALL BE IMPLIED. A warranty registration card is provided with your American Sanders Technology product. Return the card to assist American Sanders Technology in providing the performance you expect from your new floor machine.

ALTO U.S. Inc., 2100 Highway 265, Springdale, Arkansas 72764

AMERICAN SANDERS TECHNOLOGY reserves the right to make changes or improvements to its machine without notice.

Always use genuine American Sanders Technology Parts for repair.



AMERICAN SANDERS TECHNOLOGY
2100 Highway 265
Springdale, Arkansas, 72764