



NEPTUNE E



Nilfisk ALTO

Why Compromise

english	Operating Instructions.....	3-16
deutsch	Betriebsanleitung	17-30
français	Notice d'utilisation	31-44
nederlands	Gebruiksaanwijzing	45-58
italiano	Istruzioni sull'uso.....	59-72
norsk	Driftsinstruks.....	73-86
svensk	Bruksanvisning	87-100
dansk	Driftsvejledning	101-114
suomi	Käyttöohje.....	115-128
slovenscí	Navodilo za uporabo	129-142
hrvatski	Uputstvo za rad	143-156
slovenský	Prevádzkový návod.....	157-170
český	Provozní návod.....	171-184
polski	Instrukcja obsługi.....	185-198
magyar	Kezelési utasítás	199-212
русский	Руководство по эксплуатации	213-226
español	Instrucciones de manejo	227-240
português	Instruções de operação	241-254
ελληνικά	Οδηγίες λειτουργίας.....	255-268
türkçe	İşletme kılavuzu.....	269-282

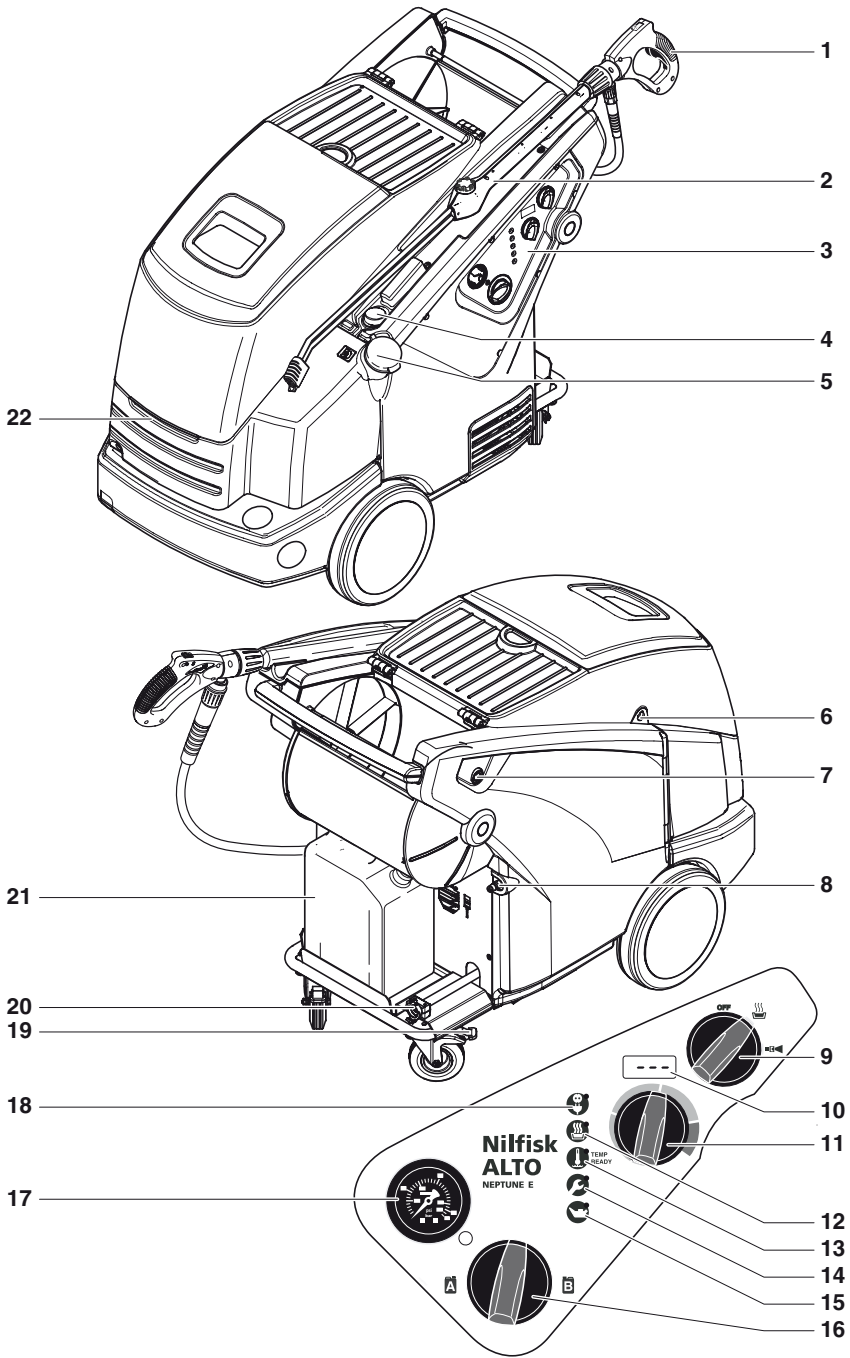

Contents

1 Important safety instructions		4
2 Description	2.1 Purpose	6
	2.2 Operating elements	6
3 Before starting the cleaner	3.1 Transport and assembly	7
	3.2 Set the brake	7
	3.3 Fill up detergent tanks	7
	3.4 Connecting the high pressure hose	7
	3.5 Connecting the water supply	8
	3.6 Electrical connection	8
	3.7 Antifreeze - before first use	8
4 Control / Operation	4.1 Connecting the spray lance to the spray gun	8
	4.2 Switching on the cleaner	9
	4.3 Using cleaning agents	9
5 Applications and methods	5.1 Techniques	10
	5.1.1 Soaking	10
	5.1.2 Detergent and Foam	10
	5.1.3 Temperature	10
	5.1.4 Mechanical Effect	10
	5.1.5 High Water Flow or High Pressure	10
	5.2 Some typical cleaning tasks	11
	5.2.1 Agriculture	11
	5.2.2 Vehicle	11
	5.2.3 Buildings and Equipment	12
6 After using the cleaner	6.1 Switching off the cleaner	12
	6.2 Disconnecting supply lines	12
	6.3 Storing the cleaner (below 0°C (32°F))	12
7 Maintenance	7.1 Maintenance Schedule	13
	7.2 Maintenance work	13
	7.2.1 Water filters	13
	7.2.2 Checking the pump oil quality	13
	7.2.3 Changing the pump oil	14
8 Troubleshooting	8.1 Indications on Display	14
	8.2 Indication lights on control panel	15
	8.3 Other Faults	15
9 Further information	9.1 Recycling the cleaner	15
	9.2 Guarantee	16
	9.3 Technical data	16
	9.4 EU Declaration of Conformity	16

english

Symbols used to mark instructions



Safety instructions in these operating instructions which must be observed to prevent risks to persons are marked with this danger symbol.



This indicates tips and instructions to simplify work and to ensure safe operation.



Before using the high-pressure cleaner, be sure to also read the enclosed operating instructions and keep them within reach at all times.



This symbol is used to mark safety instructions that must be observed to prevent damage to the machine and its performance.



Operations marked with this symbol should only be carried out by Nilfisk-
Alto Service Technicians.

1 Important safety instructions



For your own safety

The high-pressure cleaner should only be used by authorized persons who have been instructed in its use.

Although extremely easy to operate, children should not be allowed to use the cleaner.

General

Use of the high-pressure cleaner is subject to the applicable local regulations.

Besides the operating instructions and the binding accident prevention regulations valid in the country of use, observe recognized regulations for safety and proper use.

Do not use any unsafe work techniques.

Use only detergents approved by Nilfisk-Alto.

Transport

Transport of the high-pressure cleaner is easy on its large wheels.

For safe transport in and on vehicles we recommend preventing the equipment from sliding and tilting. Secure it with tie-downs and apply the parking brake on the castor wheel.

For transport at temperatures around or below freezing 0°C (32°F), anti-freeze should be drawn into the pump beforehand (see chapter 6).

Before starting the cleaner

Before use, check that the high-pressure cleaner is safe and in proper condition. Regularly check whether the power cord is damaged or shows signs of ageing.

Use the high-pressure cleaner only when the power cord is in a safe condition. (risk of electric shock using damaged cord!).

Check the rated voltage of the high-pressure cleaner before connecting it to the mains power supply. Ensure that the voltage shown on the rating plate corresponds to the voltage of the power supply.

We strongly recommend that the power supply to the high pressure cleaner be connected via a residual current circuit breaker. This device stops the supply of electricity if the leakage current to the ground exceeds 30 mA for 30 ms or it has a ground tester circuit.

Please observe the regulations and provisions applicable in your area. Before putting the high-pressure cleaner into service, carry out a visual check of all the major components.

CAUTION!
High-pressure water jets can be dangerous if misused. The

jet must not be directed at persons, animals, live electrical equipment or the cleaner itself.

Wear appropriate protective clothing and eye protection.

Do not direct the jet towards yourself or towards other persons in order to clean clothes or footwear.

During operation of the cleaner, recoil forces are produced at the gunvalve and spray lance and, when the spray lance is held at an angle, a torque is also created. The gunvalve and spray lance must therefore be held firmly in both hands.

Do not use the cleaner when other people without protective clothing are in the working area.

Check that cleaning will not result in dangerous substances (e.g. asbestos, oil) being washed off the object to be cleaned and harming the environment.

Do not clean delicate parts made of rubber, fabric, etc. with the 0° jet. Keep some distance between high pressure nozzle and surface in order to prevent the surface from damage.

Do not use the high-pressure hose for lifting loads.

NOTE!

The maximum permissible working pressure and temperature are printed on the high-pressure hose.

Do not use the cleaner if the power cord or high-pressure hose is damaged.

Ensure adequate air circulation. Do not cover the cleaner or operate it in inadequately ventilated rooms!



Store the cleaner where it will not be exposed to frost!

Never operate the cleaner without water. Even brief shortages of water result in severe damage to the pump seals.

Operation

Keep cabinet and service door closed during operation.

Connect the machine directly to a plug socket. Do not use extension cords.

Do not damage the power cord (e.g. by driving over it, pulling or crushing it).

Disconnect the power cord by grasping the plug only (do not pull or tug the power cord).

Electrical equipment



CAUTION!

Never spray electrical equipment with water: risk of electrical shock and short-circuit.

The cleaner may only be connected to a correctly installed plug socket.

Switching on the cleaner may cause voltage fluctuations. Voltage fluctuations should not occur if the impedance at the transfer point is less than 0.15Ω. If in doubt ask your local electricity supplier.

Maintenance and repair

CAUTION!

Always remove the plug from the power supply before cleaning or carrying out maintenance work on the cleaner.

Carry out only the maintenance operations described in the operating instructions. Use only original Nilfisk-Alto spare parts.

Do not make any technical modifications to the high-pressure cleaner.

Ensure that the machine is regularly serviced by authorized Nilfisk-Alto dealers in accordance with the maintenance plan. Failure to do so will void the warranty.

CAUTION!

High-pressure hoses, fittings and couplings are important for the safety of the cleaner. Use only high-pressure parts approved by the manufacturer!

The power cord must not differ from the version specified by the manufacturer and may only be changed by an electrician. Please contact your local authorized Nilfisk-Alto equipment distributor for all other maintenance or repair needs!

Testing

The cleaner conforms to the German „Guidelines for Liquid Spray Jet Devices“. The high-pressure cleaner must be subjected to a safety examination in accordance with the „Accident Prevention Regulations for Working with Liquid Spray Jet Devices“ as required, but at least every 12 months, by an authorised inspector.

After all repairs or modifications to electrical equipment, the protective conductor resistance, the insulation resistance and the leakage current must be measured. Furthermore, a visual inspection of the mains power lead, a voltage and current measurement and a function test must be carried out. Our after-sales service technicians are at your disposal as authorised inspectors.

The complete „Accident Prevention Regulations for Working with Liquid Spray Jet Devices“ are available from the Carl Heymanns Verlag KG, Luxemburger Strasse 449, 50939 Cologne or

english

from the appropriate association of employers' liability insurances.

The pressure-bearing parts of this high-pressure cleaner have been manufactured in accordance with § 9 of the German Pressure Vessels Ordinance and successfully subjected to a pressure test.

Safety devices

Unloader valve

Pump pressure is reduced by means of an "unloader valve" which returns water to the inlet side of the pump at a minimum pressure.

Safety temperature limiter

When exceeding max. permissible water temperature in the boiler the heating is completely switched off.

Level monitoring in the boiler

If the water level in the boiler sinks under a certain level, the equipment is switched off. The boiler is protected against overheating. The pump is protected against water shortage.

The safety devices are set and sealed at the factory and must not be adjusted.

2 Description

2.1 Purpose

This high-pressure cleaner has been designed for professional use in

- Agriculture
- Industry
- Transport industry
- Automotive
- Municipal Facilities
- Janitorial
- Construction
- Food Industry
- etc.

Chapter 5 describes the use of the high-pressure cleaner for various cleaning jobs.

Always use the cleaner as described in these operating instructions. Any other use may damage the cleaner or the surface to be cleaned or may result in severe injury to persons.

2.2 Operating elements



See fold-out page at front of these operating instructions.

- | | |
|-----------------------------------|---|
| 1 Spray lance | 12 Boiler heating operating |
| 2 Spray lance storage | 13 Working temperature reached |
| 3 Control panel | 14 Service interval due/expired |
| 4 Detergent level gauge | 15 Pump oil low |
| 5 Tank filler for detergent A | 16 Detergent metering knob |
| 6 Top cover release | 17 Pressure gauge |
| 7 Service door release | 18 Power ON |
| 8 High pressure hose connection | 19 Castor with parking brake |
| 9 Main switch ON/OFF | 20 Water supply connection |
| 10 Display (Temperature or Codes) | 21 Canister for detergent B ¹⁾ |
| 11 Temperature control | 22 Grip for top cover |

3 Before starting the cleaner

3.1 Transport and assembly

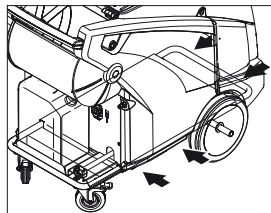

1. The safest way to lift the machine is to use a fork-lift truck. The arrows in the illustration indicate the best places to position the fork.
2. It is also possible to lift the machine by hand from the pallet. Due to the weight this work should be done by at least three persons.

CAUTION!

Do not hold the plastic tank to lift the machine as it could become detached from the frame.

The best places to hold the machine are

- on the handle
- on the frame between the front wheels and the guide rollers.

3.2 Set the brake

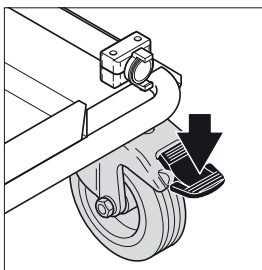

1. Before using the cleaner for the first time, check it carefully for any faults or damage.
2. Run the machine only when it is in perfect working condition.
3. Set the brake.

3.3 Fill up detergent tanks

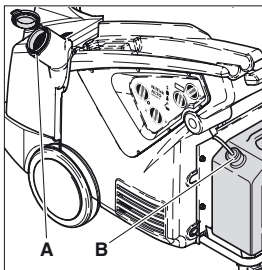

1. Fill up detergent tanks (A) and (B)¹⁾ with prediluted detergent. Capacity see chapter 9.3 Technical Data

3.4 Connecting the high pressure hose

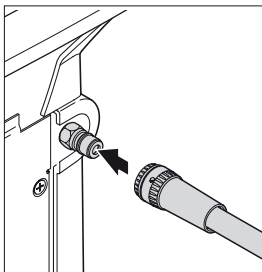

1. Connect the high pressure hose quick connector to the high pressure nipple.

¹⁾ Accessories / model variants

english

3.5 Connecting the water supply



NOTE!

See chapter 9.3 Technical Data for required quantity of water and water pressure.

In the case of poor water quality (sand, etc.), it is recommended that an inlet water filter be installed.

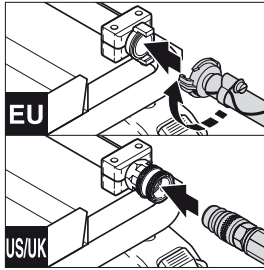

Water supply hose should be a reinforced hose and have a minimum inside diameter of 3/4" (19 mm).

1. Attach quick connect adapter found with Owners Manual to the water supply hose.
2. Rinse the water supply hose briefly in order to prevent sand and other dirt particles entering into the machine.
3. Attach water supply hose with adapter to inlet quick connector.
4. Open water supply faucet.

3.6 Electrical connection

CAUTION!

The cleaner should only be connected to a correctly installed electrical supply.

1. Observe specifications in chapter 9.3.
2. Observe safety instructions in chapter 1.
3. Insert the plug into the electrical socket.

3.7 Antifreeze - before first use

The machine is flushed with antifreeze at the factory to protect it against freezing; this mixture (ap-

prox. 3 l) may be captured in a suitable container for reuse.

4 Control / Operation

4.1 Connecting the spray lance to the spray gun



NOTE!

Always remove any dirt from the nipple before connecting the spray lance to the spray gun.

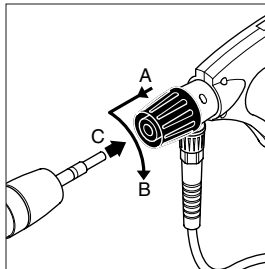



1. Pull the blue quick-release grip (A) of the spray gun forwards and lock it by turning it to the left.
2. Insert the nipple of the spray lance (C) into the quick-release connection and turn the blue quick-release grip to the right (B).
3. Pull the spray lance (or other accessory) forwards to check that it is securely attached to the spray gun.

4.2 Switching on the cleaner



Automatic temperature control

The electronically controlled mixing valve regulates the preselected work temperature, while sufficiently hot water is in the boiler. If the water temperature in the boiler drops under the preselected work temperature, the indicator lamp  goes out.

1. Wait until the boiler has heated the water to preselected temperature (the indicator lamp  blinks during heating-up).

or:

2. Operate the machine with lower than preselected working temperature.

During continuous operation the work temperature oscillates itself on the following values:

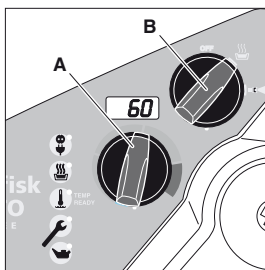

NEPTUNE	Working temperature
E 12	34°C
E 24	46°C

The specified values refer to a water inlet temperature of 12°C. If warmer water is supplied (permissible up to max. 70°C) higher values are reached.

1. Turn the main switch to position .

Control electronics accomplishes a self check.

The Display shows for approx. 1 second „-“.



The motor starts.

 is ON.

Cold water operation:

2. Turn temperature selector switch (A) fully anticlockwise.
3. Turn the main switch (B) to position .

Hot water operation:

2. Turn temperature selector switch (A) to desired water temperature. The indication lamp  blinks during water is heated. If water has reached the preselected temperature, the indication lamp  lights.
3. Turn the main switch (B) to position .
4. Unlock the spray gun and squeeze trigger.
5. Lock the spray gun even during short working pauses.



The cleaner switches off automatically twenty seconds after the spray gun has been closed. To start the cleaner again, squeeze the trigger and the machine will start automatically.

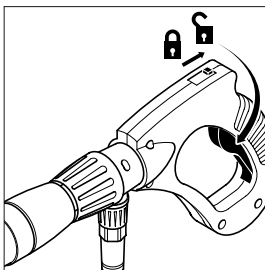

4.3 Using cleaning agents

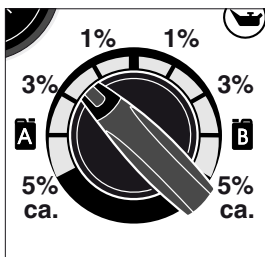
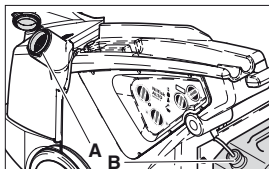

NOTE!

Never allow cleaning agent to dry on the surface to be cleaned. The surface may be damaged.

The percentage shown in the illustration are only approximate data.

For special applications such as disinfection, the exact detergent concentration has to be determined by

1. Select desired detergent (A) or (B) and amount by turning the knob to desired percentage.
2. Spray the object to be cleaned.
3. Allow the cleaning agent to work, depending on the degree of soiling. Then rinse off with high pressure.

using a graduated measuring container. For water outlet volume of the machine see chapter 9.3 technical data.

5 Applications and methods

5.1 Techniques

Efficient high pressure cleaning is achieved by following a few guidelines, combined with your own personal experience of specific cleaning tasks. Accessories and detergents, when correctly chosen, can increase the efficiency of your pressure washer. Here is some basic information about cleaning.

5.1.1 Soaking

Encrusted or thick layers of dirt can be loosened or softened up by a period of soaking. This is for example an ideal method within agriculture – for example, within pig sties. The ideal soaking method can be achieved by using foam or simple alkaline detergent. Let the product lie on the dirty surfaces for about 30 minutes before pressure washing. The result will be a much quicker high pressure cleaning process.

5.1.2 Detergent and Foam

Foam or detergent should be applied onto dry surfaces so that the chemical product is in direct contact with the dirt. Detergents are applied from bottom to top, for example on a automobile bodywork, in order to avoid “super clean” areas, where the detergent may collect in higher concentrations and streams downwards. Let the detergent work for several minutes before rinsing before rinsing and never let it dry on the surface being cleaned.

5.1.3 Temperature

Detergents are more effective at higher temperatures. Greases, oils and fats can be broken down more effectively at higher temperatures also. Proteins can be cleaned at temperatures of around 60°C (140°F). Oils and traffic film around 70°C (158°F), and grease can be cleaned at 80°-90°C (176-194°F).

5.1.4 Mechanical Effect

In order to break down tough layers of dirt, additional mechanical effect may be required. Special lances and rotary or wash brushes offer this supplementary effect that cuts through dirt.

5.1.5 High Water Flow or High Pressure

High pressure is not always the best solution and may also damage surfaces. The cleaning effect also depends upon water flow. Pressure levels of around 100 bar (1450 psi) may be sufficient for vehicle cleaning (in association with hot water) and higher flow levels give the ability to rinse and flush away large amounts of dirt easily.

5.2 Some typical cleaning tasks

5.2.1 Agriculture

Task	Accessories	Method
Stables Pig Pens, Sties Cleaning of walls, floors and equipment Disinfectant	Chemical Foam Injectors Foam lance Powerspeed lance Floor Cleaner Detergents Universal Alkafoam Disinfectant DES 3000	<ol style="list-style-type: none"> 1. Soaking – apply foam to all surfaces (bottom to top) and wait for approx. 30 minutes. 2. Remove the dirt from surfaces with the high pressure lance or chosen accessory. Again, clean from bottom to top on vertical surfaces. 3. To flush away large quantities of dirt, change to low pressure mode and use the higher flow to push away the dirt. 4. Use recommended disinfectant products and methods to ensure hygiene. Apply DES 3000 disinfectant once the surfaces are perfectly clean.
Machinery Tractors ploughs etc.	Detergent injection Powerspeed lances Curved lances and underchassis washers Brushes	<ol style="list-style-type: none"> 1. Apply detergent to vehicle or equipment surfaces in order to soften up dirt and grime. Apply from bottom to top. 2. Proceed with cleaning using the high pressure lance. Clean again from bottom to top. Use accessories to clean in difficult to reach places. 3. Clean fragile areas such as motors, rubber at lower pressure levels to avoid damage.

5.2.2 Vehicle

Task	Accessories	Method
Vehicle bodywork	Standard lance Detergent injection Curved lances and underchassis washers brushes Detergents Aktive Shampoo Aktive Foam Sapphire Super Plus Aktive Wax Allosil RimTop	<ol style="list-style-type: none"> 1. Apply detergent to vehicle or equipment surfaces in order to soften up dirt and grime. Apply from bottom to top. In cases of particularly dirty vehicles, pre-spray with a product such as Allosil in order to remove traces of insects etc, then rinse at low pressure and apply normal car cleaning detergent. Let detergents settle for 5 minutes before cleaning off. Metallic surfaces can be cleaned using RimTop. 2. Proceed with cleaning using the high pressure lance. Clean again from bottom to top. Use accessories to clean in difficult to reach places. Use brushes in order to add a mechanical cleaning effect. Short lances can help for cleaning of motors and wheel arches. Curved lances or undercarriage washers can be valuable for the cleaning of car underchassis and wheel arches. 3. Clean fragile areas such as motors, rubber at lower pressure levels to avoid damage. 4. Apply a liquid wax using the pressure washer in order to protect the bodywork from pollution.

5.2.3 Buildings and Equipment

Task	Accessories	Method
General surfaces Metallic equipment	Foam injectors Standard lance Curved lances Tank cleaning head Detergents Intensive J25 Multi Combi Aktive Alkafoam Disinfectant DES 3000	<ol style="list-style-type: none"> 1. Apply thick foam over the surfaces to be cleaned. Apply on dry surfaces. Apply from top to bottom on vertical surfaces. Let the foam act for up to 30 minutes for the optimal effect. 2. Proceed with cleaning using the high pressure lance. Use applicable accessories. Use high pressure to dislodge large amounts of incrustated dirt or grime. Use lower pressure and high water volume in order to rapidly flush away loose dirt and rinse surfaces. 3. Apply DES 3000 disinfectant once the surfaces are perfectly clean. <p>Areas covered by amounts of loose dirt, such as animal remains in slaughterhouses, can be removed by using high water flow to flush away the dirt to evacuation pits or drains.</p> <p>Tank cleaning heads can be used to clean barrels, vats, mixing tanks etc. Cleaning heads may be hydraulically or electrically powered and give the possibility for automatic cleaning without a constant user.</p>
Rusted or damages surfaces prior to treatment	Wet Sandblasting equipment	<ol style="list-style-type: none"> 1. Connect the sandblasting lance to the pressure washer and place the suction tube in the sand. 2. Always wear protective equipment during sandblasting. 3. Spray the surfaces to be treated with the mix of water and sand. Rust, paint etc will be stripped off.

These are merely several examples of cleaning tasks that can be solved by a pressure washer in association with accessories and detergents. Each cleaning task is different. Please consult your local dealer or Nilfisk-Alto representative in order to discuss the best solution for your own cleaning tasks.

6 After using the cleaner

6.1 Switching off the cleaner

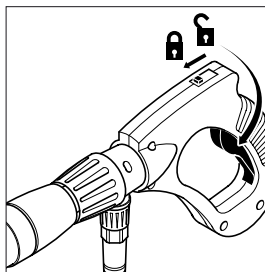

1. Turn the main switch to position „OFF“.
2. Turn off water supply at faucet.
3. Squeeze the spray gun trigger until the pressure has bled off.
4. Slide trigger lock to the locked position.

6.2 Disconnecting supply lines

1. Turn off water supply at faucet.
2. Remove the water supply hose from the cleaner.
6. To prevent accidents, always

carefully roll up the power cord and the high pressure hose.

6.3 Storing the cleaner (below 0°C (32°F))

1. Store the cleaner in a dry heated location to protect against freezing.

7 Maintenance

7.1 Maintenance Schedule

	Weekly	After the first 50 operating hours	Every six months or 500 operating hours	As required
7.2.1 Water filters				●
7.2.2 Checking the pump oil quality	●			
7.2.3 Changing the pump oil		●	●	

7.2 Maintenance work

7.2.1 Water filters

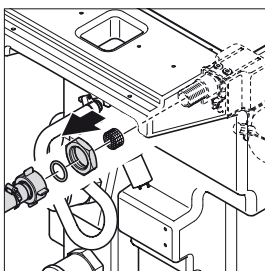

Water filters are fitted at the water and pump inlets to prevent large particles of dirt from entering into the system.

1. Unscrew quick coupling.
2. Remove filter with tool and clean it.

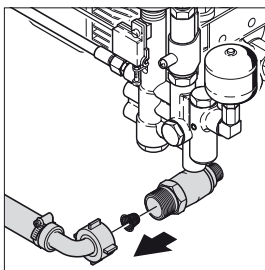

3. Also clean filter at pump inlet.

7.2.2 Checking the pump oil quality

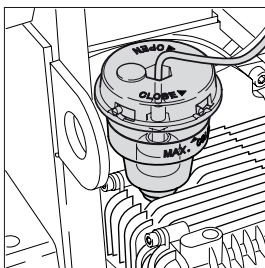

1. Check color of pump oil. If the oil has a grey or white shade, change the oil (see chapter 7.2.3)
2. Top off oil level with fresh oil if necessary. Oil type see chapter 9.3 Technical Data.

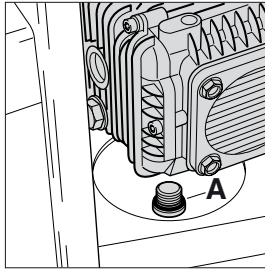

7.2.3 Changing the pump oil











1. Unscrew the oil drain plug (A) and drain oil into a suitable container.
2. Check that the drain plug gasket is in place and reinstall drain plug.
3. Fill pump with proper grade and amount of oil.
Oil grade and capacity see chapter '9.3 Technical Data'.

8 Troubleshooting

8.1 Indications on Display

Anzeige am Display	Ursache	Behebung
HOP	> Motor overheated	<ul style="list-style-type: none"> • Turn main switch in position „OFF“, let machine cool down • Possible phase failure; have electrical connections checked
HOS	> Boiler overheated	<ul style="list-style-type: none"> • Let appliance cool down; if the failure comes up repeatedly, contact Nilfisk-Alto-Service, cold water operation possible
LER	> Leakage > Spray gun leaking > High pressure hose, coupling or line system leaking > Detergent tank empty > Water inlet filter dirty > High-pressure pump drawing in air	<ul style="list-style-type: none"> • Turn main switch to position “OFF“, then start again. • Repair Spray gun • Replace high-pressure hose, retighten screw fittings • Fill detergent tank or set detergent metering to „OFF“ • Clean filter (see chapter 7.2.1) • Repair leaks
LLH	> No water in the boiler	<ul style="list-style-type: none"> • Check water inlet
LLP	> Water supply turned off or inadequate supply to machine	<ul style="list-style-type: none"> • Required volume flow and pressure see chapter 9.3 Technical Data
POL 	> Pump oil low	<ul style="list-style-type: none"> • Fill to proper level (see chapter 7.2.2)
S1C, S2C, S10, S20	> Temperature sensor damaged	 Contact Nilfisk-Alto Service Cold water operation possible
UPC	> Microprocessor failure	 Contact Nilfisk-Alto Service

8.2 Indication lights on control panel

Indication light	Cause	Remedy
 flashing	> see <i>LLP</i>	• see <i>LLP</i>
 flashing	> Boiler operating	• Normal operation
 TEMP READY ON	> Water has reached preselected temperature	• Normal operation
 flashing	> Service interval: Service due in 20 hours	 Contact Nilfisk-Alto Service
 ON	> Service interval expired	 Contact Nilfisk-Alto Service
 ON	> Pump oil low	• Fill to proper level

8.3 Other Faults

Fault	Cause	Remedy
 not ON	> Power cord not properly connected to power supply	<ul style="list-style-type: none"> • Check power cord connection • Check fuse (see chapter 9.3 Technical Data)
Pressure too low	<ul style="list-style-type: none"> > High pressure nozzle worn out > Detergent tank empty 	<ul style="list-style-type: none"> • Replace nozzle • Fill detergent tank or set detergent metering to „OFF“
Machine is running with pulsating pressure and makes knocking noise	> Pump has drawn in air due to detergent tank being empty	• Close detergent valve. Remove lance from gun. Operate spray gun and let machine run until air in pump is gone and the machine is running normally/calm again.
No detergents drawn in	<ul style="list-style-type: none"> > Detergent tank empty > Dirt in detergent tank > Suction valve at cleaning agent inlet soiled 	<ul style="list-style-type: none"> • Fill detergent tank • Clean detergent tank • Remove suction valve and clean or replace

9 Further information

9.1 Recycling the cleaner

Make the old cleaner unusable immediately.

1. Unplug the cleaner and cut the power cord.

Do not discard of electrical appliances with household waste.

As specified in European Directive 2002/96/EC on old electrical and electronic appliances, used electrical goods must be collected separately and recycled ecologically.

Contact your local authorities or your nearest dealer for further information.

9.2 Guarantee



Our general conditions of business are applicable with regard to the guarantee. Subject to change as a result of technical advances.

The guarantee is invalidated if the machine is not operated in accordance with these instructions or otherwise abused. The guarantee is invalidated if the machine is not serviced as described.

9.3 Technical data

		NEPTUNE	
		E 12	E24
Voltage	400 V / 3~/50Hz	EU	EU
Fuse (slow)	A	25	50
Power rating	kW	16	28
Heating	kW	12	24
Working pressure	bar/MPa	150/15	
Permissible pressure	bar/MPa	250/25	
Volume flow (max)	l/h	750	
Volume flow Q_{IEC}	l/h	720	
Permissible temperature	°C	80	
Max. water inlet temperature	°C	70	
Max. water inlet pressure	bar/MPa	10/1	
Dimensions l x w x h	mm	1150 x 702 x 987	
Weight	kg	131,5	134,5
Noise level at a distance of 1 m EN 60704-1	dB(A)	70,4	
Sound power level LW_A	dB(A)	85,4	
Vibration	m/s ²	<2,5	
Recoil forces	N	36	
Boiler	l	74	
Detergent tank A / B	l	35 / 10	
Oil quantity	l	1,0	
Oil type		SAE 15W-40	

9.4 EU Declaration of Conformity

 EU Declaration of Conformity	
Product:	High Pressure Cleaner
Type:	NEPTUNE E
Description:	400 V 3~, 50 Hz, IP X5
The design of the unit corresponds to the following pertinent regulations:	EC Machine Directive 98/37/EC EC Low-voltage Directive 73/23/EC EC EMC Directive 2004/108/EC
Applied harmonised standards:	EN 12100-1, EN 12100-2, EN 60335-2-79 EN 55014-1, EN 55014-2, EN 61000-3-2
Applied national standards and technical specifications:	DIN EN 60335-2-79
	ALTO Deutschland GmbH Guido-Oberdorfer-Straße 2-8 D-89287 Bellenberg
 Dipl. Ing. Wolfgang Nieuwkamp Tests and approvals	Bellenberg, 18.04.2005

Nilfisk ALTO

Why Compromise

www.nilfisk-alto.com

HEADQUARTER

DENMARK

Nilfisk-Advance Group
Sognevej 25
2605 Brøndby
Denmark
Tel.: (+45) 43 23 81 00
Fax: (+45) 43 43 77 00
E-mail: mail@nilfisk-advance.dk

SALES COMPANIES

AUSTRALIA

Nilfisk-ALTO
48 Egerton St.
PO box 6046
Silverwater NSW 2128
Australia
Tel.: (+61) 2 8748 5966
Fax: (+61) 2 8748 5960

AUSTRIA

Nilfisk-Advance GmbH.
Nilfisk-ALTO
Metzgerstrasse 68
A-5101 Bergheim bei Salzburg
Tel.: (+43) 662 456 400-0
Fax: (+43) 662 456 400-34
E-mail: info@nilfisk-alto.at
www.nilfisk-alto.at

BRASIL

Wap do Brasil Ltda.
Rua das Palmeiras, 350
Capela Velha
83.705-500 – Araucária - PR
Brasil
Tel.: (+55) 41 2106 7400
Fax: (+55) 41 2106 7403
E-mail: export@wapdobrasil.com.br

CANADA

ALTO Canada
24 Constellation Road
Rexdale
Ontario M9W 1K1
Canada
Tel.: (+1) 416 675 5830
Fax: (+1) 416 675 6989

CZECH REPUBLIC

ALTO Česká republika s.r.o.
Zateckých 9
14000 Praha 4
Czech Republic
Tel.: (+420) 24 14 08 419
Fax: (+420) 24 14 08 439
E-mail: wap_p@mbox.vol.cz

DENMARK

Nilfisk-ALTO
Division of Nilfisk-Advance A/S
Industrivej 1
9560 Hadsund
Denmark
Tel.: (+45) 72 18 21 00
Fax: (+45) 72 18 21 11
E-mail: salg@nilfisk-alto.dk
E-mail: service@nilfisk-alto.dk
www.nilfisk-alto.dk

Nilfisk-ALTO Food Division
Division of Nilfisk-Advance A/S
Blytækervej 2,
9000 Aalborg
Denmark
Tel.: (+45) 72 18 21 00
Fax: (+45) 72 18 20 99
E-mail: scanio.technology@nilfisk-alto.dk
www.nilfisk-alto.com

FRANCE

Nilfisk-ALTO
ALTO France SA
Aéroparc 1
19 rue Icare
67960 Entzheim
France
Tel.: (+33) 3 88 28 84 00
Fax: (+33) 3 88 30 05 00
E-mail: info@nilfisk-alto-fr
www.nilfisk-alto.com

GERMANY

Nilfisk-Advance AG
Nilfisk-ALTO Business Unit
Guido-Oberdorfer-Str. 10
89287 Bellenberg
Germany
Tel.: (+49) (0) 180 5 37 37 37
Fax: (+49) (0) 180 5 37 37 38
E-mail: info@nilfisk-alto.de
www.nilfisk-alto.de

HOLLAND

Nilfisk-ALTO
Division of Nilfisk-Advance BV
Camerastraat 9
NL-1322 BB Almere
Tel.: (+31) 36 5460 760
Fax: (+31) 36 5460 761
E-mail: info@nilfisk-alto.nl
www.nilfisk-alto.nl

HONG KONG

Nilfisk-Advance Ltd.
2001 HK Worsted Mills Ind'l Bldg.,
31-39 Wo Tong Tsui St.
Kwai Chung, Hong Kong
Tel.: (+852) 2427 5951
Fax: (+852) 2487 5828

HUNGARY

Kvantor-Itb Kft
II. Rákóczi Ferenc út 10
2310 Szigetszentmiklos-Lakihegy
Hungary
Tel.: (+36) 24 47 55 50
Fax: (+36) 24 47 55 51
E-mail: info@kvantor-itb.hu

JAPAN

Nilfisk-Advance, Inc.
1-6-6 Kita-shinyokohama, Kouhoku-ku,
Yokohama, 223-0059
Japan
Tel.: (+81) 45 548 2571
Fax: (+81) 45 548 2541

MALAYSIA

Nilfisk-Advance Sdn Bhd
No. 1011, Block A4
Leisure Commerce Square
No. 9, Jalan PJS 8/9
46150 Petaling Jaya
Selangor, Malaysia
Tel.: (+60) 3 603 7876 4222
Fax: (+60) 3 603 7876 3878

PEOPLE'S REPUBLIC OF CHINA

Nilfisk-Advance (Shenzhen) Ltd
Blok 3, Unit 130, 1001 Honghua Road
Int. Commercial & Trade Center
Fuitian Free Trade Zone
518038 Shenzhen
P.R. China
Tel.: (+86) 755 8359 7937
Fax: (+86) 755 8359 1063

POLAND

Nilfisk-ALTO
Division of Nilfisk-Advance A/S
05-800 Pruszków
ul. 3-go MAJA 8
Poland
Tel.: (+48) 22 738 37 50
Fax: (+48) 22 738 37 51
info@nilfisk-alto.pl
www.nilfisk-alto.pl

NORWAY

ALTO Norge AS
Bjørnerudveien 24

1266 Oslo
Norway
Tel.: (+47) 22 75 17 70
Fax: (+47) 22 75 17 71
E-mail: info@nilfisk-alto.no
www.nilfisk-alto.no

PORTUGAL

Nilfisk-ALTO
Division of Nilfisk-Advance Lda.
Sintra Business Park
Zona Industrial Da Abrunheira
Edifício 1, 1º A
P-2710-089 Sintra
Tel.: (+35) 808 200 537
Fax: (+35) 121 911 2679
E-mail: mkt@nilfisk-advance.es
www.nilfisk-alto.com

SINGAPORE

Nilfisk-Advance Pte. Ltd.
Nilfisk-ALTO Division
40 Loyang Drive
Singapore 508961
sales@nilfisk-advance.com.sg
Tel.: (+65) 6 759 9100
Fax: (+65) 6 759 9133

SPAIN

Nilfisk-ALTO
Division of Nilfisk-Advance S.A.
Torre DAra
Paseo del Rengle, 5 Pl. 10
E-08302 Mataró
Tel.: (+34) 902 200 201
Fax: (+34) 93 757 8020
E-mail: mkt@nilfisk-advance.es
www.nilfisk-alto.com

SWEDEN

ALTO Sverige AB
Member of Nilfisk-Advance Group
Aminogatan 18, Box 4029
S-431 04 Mölndal
Sweden
Tel.: (+46) 31 706 73 00
Fax: (+46) 31 706 73 40
E-mail: info@nilfisk-alto.se
www.nilfisk-alto.se

TAIWAN

Nilfisk-Advance Ltd.
Taiwan Branch (H.K.)
1F, No. 193, Sec.2
Xing Long Rd., Taipei
Taiwan, R.O.C.
Tel.: (+886) 2 2239 8812
Fax: (+886) 2 2239 8832

THAILAND

Nilfisk-Advance Co. Ltd.
89 Soi Chokechai-Ruammitr
Viphavadee-Rangsit Road
Ladyao, Jatuchak, Bangkok 10900
Thailand
Tel.: (+66) 2 275 5630
Fax: (+66) 2 691 4079

UNITED KINGDOM

Nilfisk-ALTO
Division of Nilfisk-Advance Ltd.
Bowerbank Way
Gilwilly Industrial Estate
Penrith Cumbria CA11 9BQ
Great Britain
Tel.: (+44) (0) 1768 868995
Fax: (+44) (0) 1768 864713
E-mail: sales@nilfisk-alto.co.uk
www.nilfisk-alto.co.uk

USA

ALTO Cleaning Systems Inc.
Part of the Nilfisk-Advance Group
12249 Nations Ford Road
Pineville, NC 28134
USA
Tel.: (+1) 704 971 1240
Fax: (+1) 704 971 1241
E-mail: info@nilfisk-advance.us
www.nilfisk-alto.com