

NIGHTHAWK™

By KIDDE Safety

AC Powered with Battery Backup

Carbon Monoxide and Explosive Gas Alarm

User's Guide

See pages
4-1 and 4-2 for
"What to do When the
Alarm Sounds"

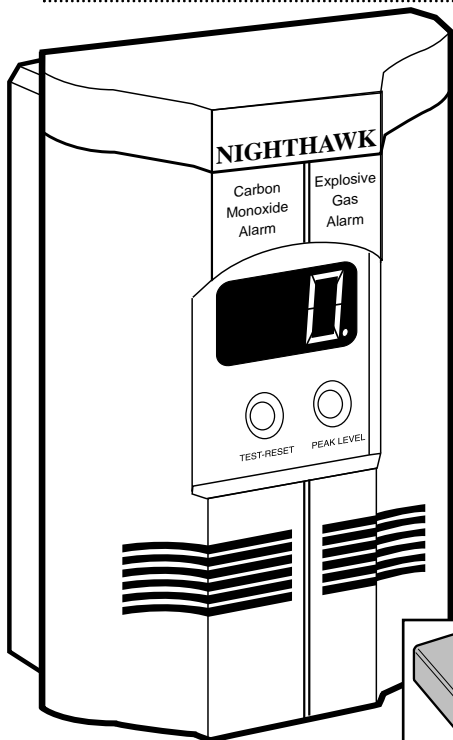

c  US
LISTED
SINGLE STATION
CARBON MONOXIDE ALARM

LISTED
RESIDENTIAL
GAS DETECTOR

Nighthawk CO and Gas Alarm with Digital Display, Peak Level Memory and 9V Battery Backup

Model: KN-COEG-3

For questions concerning your Carbon Monoxide and Explosive Gas Alarm, please call our Consumer Hotline at 1-800-880-6788.

Please have the following information ready when calling:

CO and Gas Alarm Model number (located on back of alarm):

CO and Gas Alarm Assembly number (located on back of alarm):

Date of Manufacture (located on the back of the alarm):

Date of Purchase:

Where Purchased:

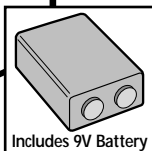

Includes 9V Battery

Table of Contents

About this User's Guide i

Introduction i

Quick Set Up Guide ii

Part One - Your Nighthawk Carbon Monoxide (CO) and Gas Alarm:

- About your CO and Gas alarm 1-1,2
- What CO and Gas alarms can and cannot do 1-2
- Where you should install your CO and Gas alarm . . . 1-3
- Where you should not install your CO and Gas alarm 1-3,4
- How to install your CO and Gas alarm 1-4,5
- Normal operating characteristics 1-5
- How to test your CO and Gas alarm 1-6
- How to know if your CO and Gas alarm is malfunctioning 1-7,8
- How to care for your CO and Gas alarm 1-8
- The peak level memory button 1-8

Part Two - Carbon Monoxide and Gas

- What is CO? 2-1
- What is natural Gas? 2-1
- What is propane? 2-1
- What are the effects of CO exposure? 2-1
- Where does CO come from? 2-1
- Where does Gas come from? 2-1
- Could your family be at risk from CO poisoning? . . . 2-1

- What can you do to protect your family? 2-1
- Home safety tips 2-2

Part Three - What You Should Know Before the Alarm Sounds

- Learn the difference between dangerous levels, high levels, mid levels and low levels of CO 3-1
- Determine if anyone in the household is at high risk for CO poisoning 3-1
- Understand the effects of carbon monoxide exposure . 3-1

Part Four - What to Do When the Unit Alarms

- How to respond to a CO emergency 4-1,2
- How to respond to a Gas emergency
- Who you should call if you suspect you have CO or Gas in your home 4-2
- Sometimes it is difficult to find the source of CO . . . 4-2

Part Five - Technical Information

- Product Specifications 5-1
- How the unit determines when to alarm 5-1

Part Six - Frequently Asked Questions 6-1,2

- Plus, "Display readings and what they mean" 6-3,4

Limited Warranty

- Warranty Registration Back Page
- Warranty Service Back Page

IMPORTANT

THIS CARBON MONOXIDE AND EXPLOSIVE GAS ALARM IS DESIGNED TO DETECT CARBON MONOXIDE, NATURAL GAS OR PROPANE. IT IS NOT DESIGNED TO DETECT SMOKE, FIRE, OR ANY OTHER GAS. THIS DETECTOR WILL ONLY DETECT THE PRESENCE OF CO, NATURAL GAS OR PROPANE PRESENT AT THE SENSOR. CO, NATURAL GAS OR PROPANE MAY BE PRESENT IN OTHER AREAS.

NOT SUITABLE FOR INSTALLATION IN HAZARDOUS LOCATIONS AS DEFINED IN THE NATIONAL ELECTRIC CODE. THIS DETECTOR WILL DETECT CARBON MONOXIDE PRIMARILY AND EXPLOSIVE GAS SECONDARILY. CO EVENTS WILL ALWAYS TAKE PRECEDENCE OVER EXPLOSIVE GAS EVENTS. THROUGHOUT THIS MANUAL, THE WORD GAS WILL BE USED TO SPECIFICALLY REFER TO NATURAL GAS OR PROPANE.

KIDDE Safety

This manual and the products described in it are copyrighted, with all rights reserved. Under these copyright laws, no part of this manual or these products may be copied for any use without prior consent from KIDDE Safety.

©KIDDE Safety, 1998

1394 South Third Street, Mebane, NC 27302

Consumer Hotline: 1-800-880-6788

www.kiddesafety.com

About this User's Guide

Notice we call this booklet a "User's Guide" and not an "Owner's Manual." This is because our intention is you *use* this guide just as you will be using your Nighthawk CO and Gas alarm. Keep the guide in a handy location and refer to it when you have questions about your CO and Gas alarm, its functions and features.

Part One

Your Nighthawk Carbon Monoxide and Explosive Gas Alarm, covers the unique features of your Nighthawk carbon monoxide and explosive Gas alarm, how and where to install it, as well as information on testing and maintaining your unit.

Part Two

Carbon Monoxide and Gas contains valuable information about carbon monoxide (CO) and gas. From discovering the most common sources of CO in your home to recognizing the symptoms of CO poisoning, this section provides tips and information that could help protect your family.

Part Three

What You Should Know Before the Alarm Sounds, provides a common sense approach to understanding the difference between low level CO readings, high levels and emergency situations. This section also describes the effects of exposure to CO levels over time and when your Nighthawk CO and Gas unit will alarm.

Part Four

What to do When the Unit Alarms, gives you step-by-step information on how to respond to the different alarm situations. Also covered is whom to call for help if you think you have CO or Gas in your home.

Part Five

Technical Information, covers the technical specifications of your Nighthawk CO and Gas alarm.

Part Six

Frequently Asked Questions, contains the most commonly asked questions about our alarms. Part six was written by KIDDE Safety customer service representatives who handle thousands of calls per month, year-round. This section provides you with answers and tips that will most likely answer any questions you might have after reading this user's guide.

Introduction

This Nighthawk carbon monoxide (CO) alarm is an important part of your family's home safety plan. As a new owner of a CO and Gas alarm, there are some basic facts you should know for your protection *and* convenience.

Carbon monoxide (CO) is invisible, odorless, tasteless and non-irritating—completely undetectable to your five senses. That's why it's so important to your safety that you have a carbon monoxide and explosive Gas alarm.

Natural Gas is typically supplied through a main utility line connected to your home. If you do not live in a rural area you are likely to be a user of natural Gas. It is the dominant energy used for home heating with about 55 percent of American homes using Gas. Natural Gas is a fossil fuel comprised almost entirely of Methane. Methane is much lighter than air and will rise rapidly in air. If you are a user of natural Gas, we recommend you mount your Nighthawk unit 12 inches away from the ceiling (using retractable cord feature) to ensure the earliest opportunity to detect a leak.

Propane is typically supplied to homes via delivery truck in liquid form and stored near the home in propane tanks. Propane is used by homes in rural areas that do not have natural Gas service. Since propane is the most commonly used *liquefied petroleum Gas (LPG)*, "propane" and LP-Gas are often used synonymously. Unlike natural Gas, propane is much heavier than air and will collect at lower levels. If you are a user of propane, we recommend you mount your Nighthawk near the floor (using the direct plug-in feature) to ensure the earliest opportunity to detect a leak.

Both Propane and Natural Gas are colorless and odorless. For safety reasons, an odorant (Mercaptan) is added so that any leak can be detected by smell. The common detection threshold for smelling the Gases is around 20% of the **lower explosion limit (LEL)**. This can vary greatly depending on the individuals sense of smell and how long they have been exposed to it. The LEL of each of these gases defines the bottom range of flammability for the Gas. Your Nighthawk is calibrated to alarm before 25% of the LEL of either Gas detected. **Therefore, it is possible that you may smell Gas before the alarm is activated.**

If you are not sure which Gas your home uses, contact your utility company.

Please take the time to read this guide from cover to cover, to familiarize yourself with the facts about carbon monoxide, natural Gas and propane. Know how your new unit works, and what to do if it alarms. Then, find a handy place to keep the guide so it will be readily available in the future when you have a question. You might want to write down KIDDE Safety's toll-free customer service number and keep it with your other important phone numbers for the same reason.

Thank you for making Nighthawk a part of your complete home safety program. With proper installation and use, your new Nighthawk CO and Gas alarm should provide you with years of dependable service.

Quick Set-Up Guide

**We urge you to read this entire manual in the sequence it is presented.
But, if you only read one part of this guide initially, read this page!**

Listed below are seven easy steps for setting up your Nighthawk CO and Gas alarm. Please read the entire guide for complete information.

Setting up your CO and Gas alarm for first time operation:

Step 1

Determine the best location for your CO and Gas alarm(s). Refer to page 1-3 for complete information.

Step 2

Your CO and Gas alarm is equipped to be mounted as a corded unit (recommended for natural gas detection), a direct plug unit (recommended for propane gas detection) or a table top unit. In the “as shipped” configuration, the unit can be plugged directly into a wall socket. (If your outlets are mounted horizontally, please refer to page 1-4). If the transformer/adaptor is taken out of the unit, the unit can be mounted high on the wall, while the transformer is plugged into a wall socket. The explosive Gas you use will determine if the unit should be mounted high on the wall (cord option) or low on the wall (direct plug option). Refer to page 1-4 for further information on installing your alarm.

Step 3

A 9V battery is needed for backup in the event of a power outage. When installing the battery, use an Energizer 522, Duracell MX 1604 or, for extended life, use an Ultralife lithium power cell model U9VL. Any of these batteries can be purchased where you bought the alarm or at your local hardware store. To install the battery, open the back door and snap battery connector onto battery. You will hear the alarm sound briefly to indicate the unit is receiving power. Place battery into battery compartment and replace back door (refer to page 1-1).

Step 4

First install the 9V battery then plug the alarm into a standard, unswitched 120 volt AC electric outlet in one of the configurations listed in step 2.

Step 5

At power up, you will see a flashing red dot and three eights **888** in the digital display indicating the alarm is warming up. After approximately 20 seconds the unit will start sampling for CO. After approximately 2 minutes the unit will start sampling for gas. During this period a number will appear on the digital display. The number on the digital display should be zero (0). If not, see page 1-5 for complete information on normal operating characteristics.

Step 6

Wait 2 to 3 minutes after power up and make sure the red dot in the digital display is blinking. Then test the unit's operation by pressing and releasing the Test/Reset button. Within 15 seconds you hear 3 slow beeps with “GAS” appearing in the digital display. Then, you will hear 4 quick beeps followed by 5 seconds of silence then 4 quick beeps repeating while a number (usually around 200) is displayed. In normal operation, the repeating slow beeps with “GAS” showing in the display is the alarm condition notifying you that either natural Gas or propane is being detected. The 4 quick beeps 5 seconds of silence -repeating while a number is shown in the digital display indicates that the alarm is in a condition notifying you that carbon monoxide is being detected. For complete testing information, refer to page 1-5.

Step 7

While testing the alarm, have someone else check that the alarm can be heard easily from the sleeping areas. The unit should be located where it can wake you if it alarms at night. See page 1-3 for complete information on the best locations for your alarm.

Caution: Continuous exposure to the loud 85 decibel alarm at close range over an extended period of time may cause hearing loss. We recommend that you cover the sound holes while testing.

That's it. Your Nighthawk CO and Gas alarm is now monitoring for the presence of carbon monoxide and explosive Gas.

Part One - Your Nighthawk CO and Gas Alarm

About Your CO and Gas Alarm

The number one feature that sets Nighthawk apart from other alarms is its unique digital display that gives you a continuous read-out of CO levels from 30-999 parts per million and an easy method for determining if Gas is being detected. The digital display serves as an early warning of CO or Gas presence.

Nighthawk is the only CO and Gas alarm that gives you the choice of a direct-plug, a 6' power cord or table top unit all in one. Depending on how or where you wish to mount your unit, you can get exactly what you need for a perfect application. These are just a few reasons over 4.5 million families have chosen Nighthawk over every other brand for this kind of life-saving protection.

Nighthawk CO and Gas Alarm (KN-COEG-3) - front view

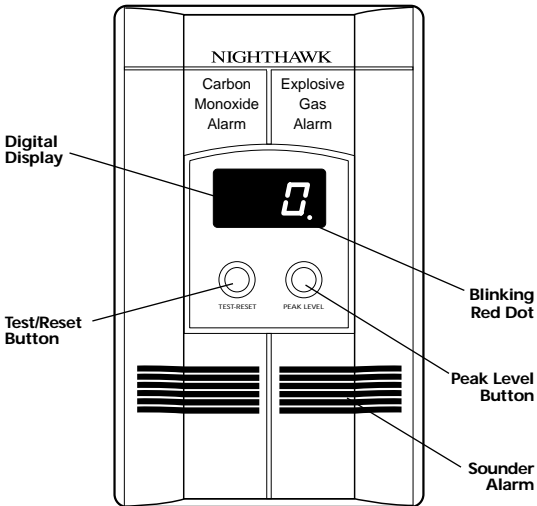

Nighthawk CO and Gas Alarm - rear view

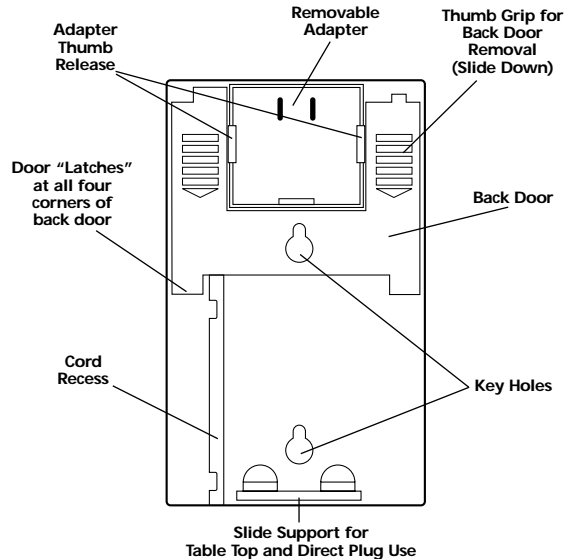

Rear view with back door removed

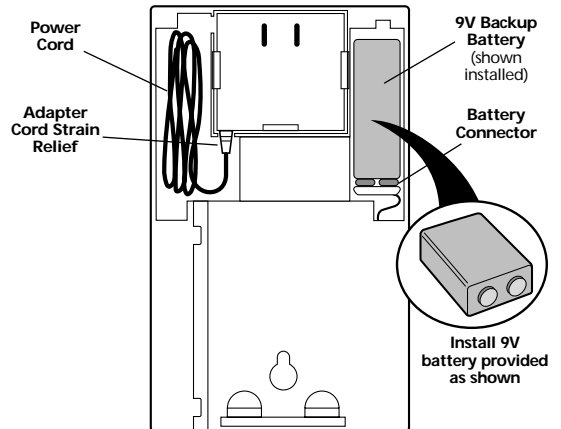

Part One – Your Nighthawk CO and Gas Alarm

Nighthawk's Unique Features

Digital Display

The continuous digital display shows you the level of carbon monoxide (if any) the unit is sensing as well as if Gas is present. The unit updates this reading every 15 seconds so you can watch levels rise or fall.

Note: If the unit does not sense any CO or gas, the reading is zero (0). In most homes, the unit reads "0" all the time. A reading of "0" is expected under normal conditions, and is good. The blinking dot after the number shows you the unit is operating.

Test/Reset Button

This button has three functions. First, this is the button you press when you test the unit monthly (see page 1-5 for further details). Secondly, you press this button if the unit alarms and you want to silence the alarm. This will *reset* the unit and it will then again start monitoring for CO or Gas, if CO concentration is above 70 ppm the alarm will again sound within 6 minutes. It's also used when resetting the peak level memory. (See page 1-7).

Peak Level Button

By pressing this button, you can see the peak CO level recorded by the alarm since it was last cleared or unplugged. This Nighthawk feature allows you (or heating contractor or fireman) to see exactly how big a CO problem you have so you can react accordingly. (More on the peak level memory feature on page 1-7).

Sensors

The CO sensor is a highly sensitive, electrochemical sensor that is CO-specific to help avoid false alarms. Turn to page 1-7 for more information on how to care for and protect the alarm.

The Gas sensor is a metal oxide sensor designed to detect natural gas (methane) or propane.

Sounder Alarm

This is the loud 85 decibel pulsing alarm that will sound to alert you to a potential problem. Alarm condition for CO is 4 quick beeps – followed by 5 seconds of silence – followed by 4 quick beeps. Repeat with a number showing in the display (CO concentration in PPM). The alarm pattern for Gas is a 1/2 second alarm on, 1/2 second of silence - repeating with "GAS" shown in the display.

Caution: Continuous exposure to this sound level at close range over an extended period of time may cause hearing loss. We recommend you cover the sounder with your finger while testing. More on testing on page 1-5,6.

Keyholes

When the alarm is mounted to the wall, these keyholes slide onto the screws in the wall. (See "How to install your alarm on page 1-4).

Pull-Out Transformer/Adapter

This unique Nighthawk feature enables the alarm to be used as a direct plug unit, a wall mounted unit or a table top unit. More on how this unique feature is used for different application, page 1-4.

9V Backup Battery

This CO and Gas alarm is not battery operated. The 9V battery is to supply a short-term backup during a power outage. In the event of a power outage, a fully charged 9V battery will continue operating the CO alarm for at least 20 hours, unless Gas is detected during battery backup conditions. This will significantly shorten the battery life.

What Carbon Monoxide and Explosive Gas Alarms Can and Cannot Do

This unit is designed to sense unacceptable levels of CO or Gas from malfunctioning furnaces, appliances, Gas engines or other sources.

This unit will provide early warning of the presence of carbon monoxide, usually before a healthy adult would experience symptoms. It will provide warning of a Gas condition before 25% of the LEL for methane or propane is detected.

This early warning is possible, however, only if your Nighthawk CO and Gas alarm is located, installed and maintained as described in this user's guide.

When on AC power, this unit is designed to act as a continuous monitor, it is not designed for use as a short-term testing device to perform a quick check for the presence of CO or Gas.

Alarms have limitations. Like any other electronic device, CO and Gas alarms are not fool-proof.

CO and Gas alarms have a limited operational life. You must test your CO and Gas alarm monthly, because it could fail to operate at any time. If your CO and Gas alarm fails to test properly, or if its self-diagnostic test reveals a malfunction, immediately have the unit replaced. See back page for warranty information.

CO and Gas alarms can only sense CO that reaches the unit's sensor. Carbon monoxide may be present in other areas without reaching the alarm. The rate at which CO reaches the unit may be affected by doors or other obstructions. In addition, fresh air from a vent or open window or any other source may prevent CO from reaching the sensor. Please observe cautions on page 1-3 "Where to install your alarm."

CO or Gas could be present on one level of the home and not reach the alarm installed on a different level. For example, CO or Gas in the basement may not reach an alarm on the second level, near the bedrooms. For this reason, we recommend you provide complete coverage by placing a CO and Gas alarm on every level of the home.

This unit is not a smoke alarm. It will not sense smoke or fire. For early warning of fire you must install smoke alarms, even though carbon monoxide can be generated by a fire.

CO and Gas alarms are not a substitute for property, disability, life or other insurance of any kind. Appropriate insurance coverage is your responsibility. Consult your insurance agent.

Your CO/Gas alarm is not designed to continually detect explosive gas while on battery only operation. The CO/Gas alarm is provided with a 9 volt battery backup for short term protection against the presence of carbon monoxide or explosive gas. For the first four minutes after the unit goes into battery backup operation, the explosive gas sensor will operate as if on AC power. However, after four minutes, to extend battery life, the unit will go into battery conserve mode and will only sample for explosive gas once every eight minutes. Explosive gas could be present during this 8-minute period without the unit going into alarm.

Part One – Your Nighthawk CO and Gas Alarm

Where to Install Your CO and Gas Alarm

WHEN CHOOSING YOUR INSTALLATION LOCATIONS, MAKE SURE YOU CAN HEAR THE ALARM FROM ALL SLEEPING AREAS.

Mounting Configuration

Since CO generally mixes well with air, mounting the Nighthawk CO and Gas alarm should depend on the type of explosive Gas you intend to detect. If you are not certain which type of Gas you are using in your home, please read about natural Gas and propane in the introduction on page i.

If you are a user of natural Gas, we recommend you mount your Nighthawk unit high on the wall (no closer than 6 inches from the ceiling) using the extendable cord feature to ensure the earliest opportunity to detect a Natural Gas leak.

If you are a user of propane, we recommend you mount your Nighthawk near the floor (using the direct plug-in feature) to ensure the earliest opportunity to detect a propane leak.

LOCATION

Your Nighthawk CO and Gas alarm should be mounted in or near bedrooms and living areas or wherever you suspect a CO or Gas exposure is likely. It is recommended that you install a Nighthawk CO and Gas alarm on each level of a multi-level home.

In the event of a CO alarm, two self-adhesive labels are included with the CO and Gas alarm. Add the phone number of your emergency service provider in the space provided. Place one label next to the alarm and one label near a fresh air source such as a door or window.

CAUTION: This alarm will only indicate the presence of carbon monoxide or Gas at the sensor. Carbon monoxide or Gas may be present in other areas.

IMPORTANT: Improper location can affect the sensitive electronic components in this alarm. Please see the next section describing where NOT to install this alarm.

Recommended Locations

Upper Levels of Home

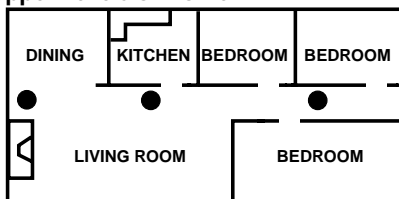

Where Not to Install Your CO and Gas Alarm

To avoid causing damage to the unit, to provide optimum protection, and to prevent unnecessary alarms, follow the directions below where NOT to install this alarm:

It is not recommended that you install this CO and Gas alarm in garages or kitchens. Installation in these areas could lead to nuisance alarms, may expose the sensor to substances that could damage or contaminate it, or the alarm may not be heard by persons in other areas of the home, especially if they are sleeping.

In the garage, vehicle exhaust can contain some carbon monoxide. These levels are higher when the engine is first started. Within hours of starting a vehicle and backing it out of the garage, the levels present over time can activate the alarm and become a nuisance.

In the kitchen, some Gas appliances can emit a short burst of CO or Gas upon start-up. This is normal. If your CO and Gas alarm is mounted too close to these appliances, it may alarm often and become a nuisance.

If you must install a Nighthawk CO and Gas alarm near a cooking or heating appliance, **install AT LEAST 5 feet away from appliance.**

Do not install in excessively dusty, dirty or greasy areas such as kitchens, garages and furnace rooms. Dust grease or household chemicals can contaminate or coat the alarm's sensors, causing the alarm not to operate properly.

Do not obstruct the vents located at the top and bottom of the alarm. Place the alarm where drapes, furniture or other objects do not block the flow of air to the vents.

Do not install in dead air spaces, such as peaks of vaulted ceilings or gabled roofs, where carbon monoxide or Gas may not reach the sensor in time to provide early warning.

Do not install in turbulent air from ceiling fans. Do not install near doors and windows that open to the outside, near fresh air vents, or anywhere that is drafty. Rapid air circulation from fans or fresh air from outside may cause the sensors to display an inaccurate readings.

Do not install this alarm in a switch- or dimmer-controlled outlet.

Do not install in areas where the temperature is colder than 40°F (4.4°C) or hotter than 100°F (37.8°C). These areas include unconditioned crawl spaces, attics, porches and garages. Extreme temperatures will affect the sensitivity of the alarm.

Do not install this unit near deep cell large batteries. Large batteries have emissions that can cause the alarm to perform at less than optimum performance.

Avoid the following:

- Excessive spillage or reverse venting of fuel burning appliances caused by outdoor ambient conditions, such as:
 - 1) Wind direction and/or velocity, including high gusts of wind. Heavy air in the vent pipes (cold/humid air with extended periods between cycles).
 - 2) Negative pressure differential resulting from the use of exhaust fans.
 - 3) Simultaneous operation of several fuel burning appliances competing for limited internal air.
 - 4) Vent pipe connections vibrating loose from clothes dryers, furnaces or water heaters.
 - 5) Obstructions in or unconventional vent pipe designs which can amplify the above situations.
- Extended operation of unvented fuel burning devices (range, oven, fireplace, etc.).
- Temperature inversions which can trap exhaust Gasses near the ground.
- Car idling in an open or closed attached garage, or near a home.

How to Install Your Alarm

Your Nighthawk CO and Gas alarm with its removable adapter allows you to install the alarm as a wall mounted unit (for natural Gas detection and CO), a direct plug unit (for propane and CO), or as a table top unit.

To install the battery, open the back door and snap battery connector onto battery. You will hear the alarm sound briefly to indicate the unit is receiving power. Place battery into battery compartment and replace back door.

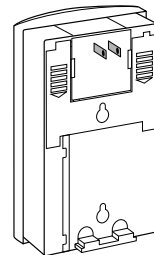

Back of unit when used as direct plug for CO and propane detection.

Direct Plug Alarm

First, refer to "Where to Install Your CO and Gas alarm" on page 1-3 for general guidelines as to where to locate your CO and Gas alarm. In its "as shipped" configuration, your Nighthawk CO and Gas alarm is ready to be plugged directly into a close to the floor wall socket. This is the recommended configuration for detecting CO and propane.

To install:

1. Choose a standard 120V outlet to plug alarm into.
2. Pull slide support out approximately .25" until slide snaps in place (this will help support unit in wall outlet).
3. Simply plug in.

If outlet is mounted horizontally (sideways):

If you are going to use your alarm as a direct plug and you are going to plug in to an outlet that is mounted horizontally (sideways), you will need to rotate the adapter 90°. This simple process is outlined below.

To rotate adapter:

1. With back of unit facing you (with adapter at top), place your thumbs on thumb grips.
2. With your thumbs, push down in the direction of the arrows on the thumb grips and slide back door off.
3. Next, place your thumbs on the adapter thumb releases.
4. Spread adapter thumb releases out and carefully turn alarm over. This will allow adapter to slide out.
5. Rotate the adapter 90° to the right (clockwise), and snap firmly back into place.
6. Carefully replace back door by making sure "latches" on all four corners of door are lined up, then firmly press into place.
7. Now simply plug in to outlet.

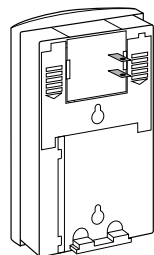

Back of unit when used as direct plug for sideways outlet

Part One - Your Nighthawk CO and Gas Alarm

Wall Mounted Alarm

First, refer to "Where to Install Your CO and Gas alarm" on page 1-3 for general guidelines as to where to locate your CO and Gas alarm.

Installation tips for power cord models:

The power cord option provides more flexibility in mounting locations and allows the alarm to be easily installed at eye level.

Note: If you mount the alarm high on a wall, make sure it is **at least 6" from the ceiling**. Any higher than this, it will be in "dead air space" and carbon monoxide or natural Gas may not reach the sensors.

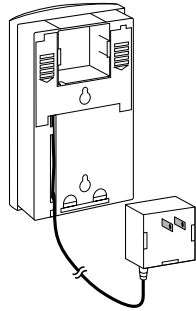

Back of unit when used as a wall mount for natural gas and CO detection

Note: Do not cover the alarm with a curtain.

For a wall-mount, you will need to pull out the removable adapter and power cord. This simple process as outlined below.

To install:

1. Follow steps 1 - 4 in the previous column under "To Rotate Adapter."
2. With adapter out, pull out power cord and unwrap it.
3. With cord extended, press last few inches into cord recess. Gently pull cord at bottom of cord recess until cord becomes taut and lays flat in cord recess.
4. Carefully replace back door by making sure "latches" on all four corners of door are lined up, then firmly press into place.
5. Insert the screws provided until head is approx. 1/8" from wall (If mounting in plaster board or dry-wall, drill 3/16 hole and use plastic anchor provided). Use mounting guide template in back of user's guide to locate holes.
6. Hook the Nighthawk CO and Gas alarm unit over the screw onto keyhole in back of unit.
7. Plug cord into electrical outlet.

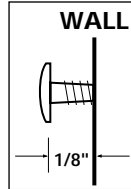

Table Top Alarm

You can also use your Nighthawk CO and Gas alarm as a table top unit. Simply follow the above steps for removing adapter, then instead of mounting to a wall, simply pull out slide support and stand on table, bedside stand, chest of drawers, etc. (refer to diagram on page 1-1).

Normal Operating Characteristics

When you first power up the unit, the alarm will sound briefly to let you know the unit is receiving power and that the alarm circuit is functioning.

You should see three eights **888** on the digital display, indicating the alarm is in the start-up mode. The three eights will remain for approximately 20 seconds. You should see a blinking red dot to the lower right of the digital display. The blinking dot shows that the alarm is operating.



Blinking Dot

Within 20 seconds, your CO alarm will start monitoring for CO. Within 2 minutes your alarm will start monitoring for Gas. **Note:** The number will probably be zero (0). This is a normal condition for most households and shows that no measurable amount of CO or Gas is being detected.

The alarm has begun monitoring the air for carbon monoxide and Gas and will continue to do so as long as it receives power.

When the alarm is unplugged or loses power and you have a good 9V battery installed, the alarm will automatically switch to its battery backup mode and you will notice the following:

- After 4 minutes the digital display will show a blinking dot only - this helps conserve the battery's power.
- The digital display will show a number for CO or show "GAS" only if it senses carbon monoxide or Gas while in backup mode.
- If CO is detected while on battery backup, alarm pattern is 4 quick beeps - followed by 5 seconds of silence - followed by 4 quick beeps. After 4 minutes, this alarm pattern occurs only every 60 seconds.
- If Gas is detected while on battery backup, the unit will display Gas and alarm continuously. The alarm pattern for Gas is a 1/2 second alarm on, 1/2 second of silence -repeating. For the first four minutes after the unit goes into battery backup operation, the explosive gas sensor will operate as if on AC power. However, after four minutes, to extend battery life, the unit will go into battery conserve mode and will only sample for explosive gas once every eight minutes. Explosive gas could be present during this 8-minute period without the unit going into alarm. If the alarm is on battery backup for an extended period of time, replace the battery to ensure maximum protection is provided. The battery will last only a couple hours in a Gas alarm condition.

Note: When AC power is restored, the alarm will automatically switch back to normal operating mode.

When the alarm is unplugged or loses power and you have a low battery installed, you will notice the following:

- A fading alarm will sound alerting you the unit has switched to its backup mode, but the 9V battery is low.

Part One – Your Nighthawk CO and Gas Alarm

- A blinking dot will be displayed and the sounder will chirp every 15 seconds.
- The display will alternate between “Lb.” (low battery) and CO reading while chirping.

When battery is depleted:

- A blinking dot will be displayed and the sounder will chirp approximately every 30 seconds.
- Pressing the test button will result in a chirp approximately every one second. The alarm **will not** detect CO or gas if battery is depleted. Replace battery.

Constant exposures to high or low humidity may reduce battery life.

We recommend you replace your 9V battery at least every six months.

How to Test Your Alarm

There are two aspects of the alarm's operation that can be tested: the electronics and the sensors response. Instructions on testing each are outlined below and on the next page.

Testing the Electronics

You should test the alarm once a month, following the directions listed below. If at any time you test the alarm and it does not perform as described below, have it replaced immediately. Turn to page 1-6 “How to know if your alarm is malfunctioning” for a description of the characteristics of a malfunctioning alarm and what you should do if a malfunction occurs.

Observe the alarm weekly to make sure the red dot is blinking, indicating normal operation.

If the dot is not blinking, unplug the alarm for three minutes, then plug in again. This will clear the alarm for restart. If the dot does not resume blinking, your alarm may be malfunctioning.

To test the alarm, press the Test/Reset button. If the unit is operating properly, you should notice the following:

- The display shows three eights **888**, then shows the word “GAS” in the display while the unit is sounding 3 half second beeps. Then, the display shows a number (usually around 200). You should then hear 4 quick beeps – followed by 5 seconds of silence – followed by 4 quick beeps repeating until reset stops. The unit will then show the three eights for several seconds. It will then return to monitoring for carbon monoxide and Gas.

Familiarize yourself and household members with the alarm pattern described above for a Gas event and a CO event. While on AC power, in the event of a CO or Gas incident, the appropriate pattern will continue to repeat as long as CO or Gas is present.

How to Test Your Alarm (continued)

NOTE: Pressing the Test/Reset button tests the functions of the alarm's internal components, circuitry and micro-computer. **YOU DO NOT NEED TO PRESS THE TEST BUTTON TO TAKE A CO OR GAS READING.** CO readings or the presence of Gas are automatically shown on the alarm's digital display. If the alarm shows zero (0), then no measurable amount of CO or Gas has been sensed by the alarm within the past 15 seconds.

Testing the sensor response

While it is not required, on occasion you may wish to observe and become familiar with your alarm's response in the actual presence of carbon monoxide or Gas. The best and safest way to do this is with either a cigarette or an incense stick. To perform this test you will need: your alarm, a butane lighter, an ashtray, and either a cigarette or an incense stick.

CAUTION: Please refer to the “Frequently Asked Questions” section for warnings on how NOT to test the sensor response.

WARNING: This test should be done by adults only. Children should be warned never to light matches or butane lighters. Please use caution when performing the test described below. Avoid burns from flame or hot materials. Avoid inhaling excessive smoke from the cigarette or incense stick. Extinguish all flames and properly discard all hot materials.

CARBON MONOXIDE TESTING

Step 1. With a match or a lighter, light a single cigarette or incense stick. Extinguish the match or lighter. Make sure an ashtray is available to discard ashes, matches and the burned cigarette or incense stick.

Step 2. Hold the smoldering cigarette or incense stick 2-3 inches directly *below* the bottom air vents of the CO and Gas alarm, making sure the stream of smoke rises into the vents.

Step 3. Continue holding the cigarette or incense stick directly below the alarm for 3 - 5 minutes or until you see a reading on the display. Note: Do not hold the cigarette or incense stick closer than one inch to the alarm as smoke *will* cause a yellow stain to develop on the alarm's outer case.

Step 4. Your unit will probably not alarm during this test. If it does, you can silence it by pressing Test/Reset button and removing the source of CO.

Step 5. Extinguish the cigarette or incense stick by pressing the smoldering tip into the ashtray.



Blinking Dot

Part One – Your Nighthawk CO and Gas Alarm

GAS TESTING

Step 1. With a butane lighter, press the button of the lighter without activating the flint. Ensure no heat source or spark is present near you when performing this test.

Step 2. While holding the button of the lighter down, insert the orifice of the lighter into the vents on the front of the unit. Hold for 30-60 seconds or until alarm activates.

Step 3. After the alarm condition is achieved, remove the lighter and gently blow in the same area to remove the gas.

How to Know If Your Alarm is Malfunctioning
Your alarm performs an internal self-diagnosis every 15 seconds to make sure that it is functioning properly. The alarm is designed to alert you in the unusual event of a malfunction.

If the alarm malfunctions.

In the rare event that your alarm malfunctions, it will alert you with one of these signal groups (depending upon the type of malfunction that occurs):

Malfunction Signal Group 1 - Component Failure

- An intermittent “chirping” alarm will sound every 30 secs., and
- An “Err” message will appear on the digital display

OR,

Malfunction Signal Group 2 - Microprocessor Failure

- The alarm will sound continuously, and
- The digital display will be blank, and
- The alarm cannot be shut off by pushing “Test/Reset” button

Unplug the alarm immediately and return for warranty exchange (see “Warranty” on back page).

Low Battery Warning

If the 9V battery is missing, or if the battery’s power is low, an “Lb” message will display which blink’s alternately with the current CO reading or “GAS” every second. If this happens, you need to replace the battery. Refer to page 1-5 for more on low battery warnings.

What to do if you’re not sure...

PLEASE familiarize yourself with the malfunction alert, and do not confuse these signals with an alarm. After reading the information above, if you are still unsure whether your alarm is operating properly, call the KIDDE Safety toll-free consumer hotline at 800-880-6788 to do a quick diagnostic check of the alarm over the phone. The customer service representative will be able to assist you and answer your questions.

If your alarm sounder is beeping, and you are not sure if it is a CO and Gas alarm or a malfunction alert, reset the alarm, open windows for ventilation, extinguish all open flames, do not activate any electrical switch and evacuate the premises immediately. Then call the KIDDE Safety toll-free consumer hotline at 800-880-6788 for assistance.

Part One – Your Nighthawk CO and Gas Alarm

How to Know If Your Alarm is Malfunctioning (continued)

Never ignore an alarm. A true alarm is an indication of potentially dangerous levels of carbon monoxide or Gas.

How to Care for Your Alarm

To keep your alarm in good working order, you must follow these simple steps:

WHAT YOU SHOULD DO:

- Test the alarm once a month by pressing the Test/Reset button (see page 1-5,6).
- Vacuum the alarm cover once a month to remove accumulated dust. Use the soft brush attachment of your vacuum cleaner, and unplug the alarm from the electrical outlet before vacuuming.
- Instruct children never to touch, unplug or otherwise interfere with the alarm.

WHAT YOU SHOULD NOT DO:

- Never use detergents or solvents to clean the alarm. Chemicals can permanently damage or temporarily contaminate the sensor.
- Avoid spraying air fresheners, hair spray, paint or other aerosols near the alarm.
- Do not paint the alarm. Paint will seal the vents and interfere with proper sensor operation.
- Do not mount the alarm directly above or near a diaper pail, as high amounts of methane Gas can cause a Gas alarm.

Note: If you will be staining or stripping wood floors or furniture, painting, wall-papering, or using aerosols or adhesives for a do-it-yourself project or hobby, **before you begin: Remove the alarm to a remote location to prevent possible damage to or contamination of the sensor.** You may wish to unplug the alarm and store in a plastic bag during the project.

The following is a list of substances that at high levels can affect the sensor and cause an alarm.

Methane, propane, iso-butane, ethylene, ethanol, alcohol, carbon monoxide, iso-propanol, benzene, toluene, ethyl acetate, hydrogen, hydrogen sulfide, sulfur dioxides.

Also most **aerosol sprays, alcohol based products, paints, thinners, solvents, adhesives, hair sprays, aftershaves, perfumes, auto exhaust** (cold start) and some cleaning agents.

The Peak Level Memory Button

Although the peak level feature will display levels below 30 PPM of CO, these levels will not result in an alarm no matter how long the device is exposed to these levels.

The peak level feature is helpful in identifying low level CO occurrences below 30 PPM. Although the unit will not automatically display levels below 30 PPM, it will detect and store these readings in memory. By pressing the peak level button, concentration levels as low as 11 and up to 999 PPM will be displayed. Gas events will not be displayed when pressing the peak level memory button.

Concentrations of CO between 0 and 30 PPM can often occur in normal, everyday conditions. Concentrations of CO below 30 PPM may be an indication of a transient condition that may appear today and never reappear. Just a few examples of conditions and/or sources that may cause low level readings are heavy automobile traffic, a running vehicle in an attached garage, an appliance that emits CO when starting up, a fire in a fireplace or charcoal in a nearby barbecue. A temperature inversion can trap CO generated by traffic and other fuel burning appliances causing low level readings of CO.

Normally, the digital display will read “0” and under certain conditions you may notice levels of 30 or more for short periods of time, by using the Peak level memory feature on the Nighthawk alarm you can view concentrations of CO between 11 and 30 PPM. Use the low-level concentrations shown in memory as a tool in identifying the source of the CO. It may be helpful to purchase additional Nighthawk alarms to place in different locations throughout your house to isolate the CO source. Monitor the CO concentrations shown in the peak level memory to see if readings occur in certain areas at certain times of the day, or near a particular appliance.

Once the source is located, correcting the problem may be as easy as opening a window, venting an appliance, backing a car out of the garage a safe distance from living quarters, closing the garage door, and letting the car warm up outside. It could be possible that a weather condition caused the low-level reading and the condition may or may not happen again.

Some CO conditions may start out as low level leaks but could develop into CO concentrations that could become harmful. If this happens, the CO and Gas alarm will detect the dangerous level and alarm, notifying you and others of the conditions. DO NOT ignore high concentration readings above 30 PPM or a CO and Gas alarming device that is in alarm. Refer to page 4-1 for more details.

CO concentrations displayed below 30 PPM in memory are for reference only and the accuracy of the concentration shown may not be as accurate as noted on page 5-1.

To Reset the Peak Level Memory...

Step 1. Press the peak level button.

Step 2. With the peak level button still pressed, press the test/reset button for two seconds and release.

The number on the display will turn to “0”. The memory has now been cleared and the alarm will begin monitoring for CO and Gas within a few minutes.

Part Two – Carbon Monoxide and Gas

What is Carbon Monoxide?

Carbon monoxide (CO) is an odorless, colorless, poisonous Gas created when any fuel is burned – Gasoline, propane, natural Gas, oil, wood, coal, and even tobacco. When combustion air is limited, more CO is produced. Serious problems can develop when combustion by-products are not properly vented outside the house.

You've probably heard about carbon monoxide poisoning in the news recently. It's a problem receiving more attention because groups like the American Lung Association and the Consumer Product Safety Commission have made it a priority to warn the public about the dangers of this deadly household poison.

What is Natural Gas?

Natural Gas is typically supplied through a main utility line connected to your home. If you do not live in a rural area you are likely to be a user of natural Gas. It is the dominant energy used for home heating with about 55 percent of American homes using Gas. Natural Gas is a fossil fuel comprised almost entirely of Methane. Methane is much lighter than air and will rise rapidly in air. If you are a user of natural Gas, we recommend you mount your Nighthawk unit 12 inches away from the ceiling (using retractable cord feature) to ensure the earliest opportunity to detect a leak.

What is Propane?

Propane is typically supplied to homes via delivery truck in liquid form and stored near the home in propane tanks. Propane is used by homes in rural areas that do not have natural Gas service. Since propane is the most commonly used *liquefied petroleum Gas (LPG)*, "propane" and LP-Gas are often used synonymously. Unlike natural Gas, propane is much heavier than air and will collect at lower levels. If you are a user of propane, we recommend you mount your Nighthawk near the floor (using the direct plug-in feature) to ensure the earliest opportunity to detect a leak.

What are the Effects of CO Exposure?

When you breathe carbon monoxide, it enters your bloodstream through your lungs and attaches to red blood cells. These red blood cells, called hemoglobin, carry oxygen throughout your body. Carbon monoxide molecules attach to the red blood cells 200 times faster than oxygen, preventing the flow of oxygen to your heart, brain and vital organs. As carbon monoxide accumulates in your bloodstream, your body becomes starved for oxygen. The amount of carbon monoxide in a person's body can be measured by a simple blood test, called a "carboxyhemoglobin level" test .

The early symptoms of carbon monoxide poisoning are often mistaken for the flu – headache, dizziness, weakness, nausea, vomiting, sleepiness, and confusion.

Breathing very high concentrations of carbon monoxide can be lethal in minutes. Breathing low concentrations over time is dangerous, too.

Long term exposure to low levels could cause permanent heart and brain damage.

Could Your Family be at Risk for CO Poisoning?

Carbon monoxide is the number one cause of poisoning deaths in the United States. According to the Mayo Clinic, at least 10,000 Americans are affected by CO poisoning each year.

While anyone is susceptible, experts agree that unborn babies, small children, senior citizens and people with heart or respiratory problems are especially vulnerable to CO and are at the greatest risk for death or serious injury.

Where Does CO Come From?

Inside your home, appliances used for heating and cooking are the most likely sources of carbon monoxide. Vehicles running in attached garages can also produce dangerous levels of carbon monoxide.

A by-product of combustion, carbon monoxide can be a potential problem from a number of common sources – automobiles, furnaces, water heaters, fireplaces, wood stoves, charcoal grills, Gas ranges, space heaters and portable generators.

When these appliances are in good working condition with proper ventilation, lethal carbon monoxide Gas is vented outdoors where it quickly disperses. But even the slightest malfunction or misuse of any of these sources can lead to a build-up of carbon monoxide in your home that can become deadly before you'd even know it's there.

And you don't have to have ancient appliances to have a problem. Today's more energy-efficient, airtight home designs can trap CO-polluted air inside where it can quickly build to lethal levels.

What Can You do to Protect Your Family?

To be safe, know the possible sources of CO in your home. Keep fuel-burning appliances and their chimneys and vents in good working condition. Learn the early symptoms of exposure, and if you suspect carbon monoxide poisoning, move outside to fresh air and get emergency help. A blood test can confirm that CO caused the problem.

Your first line of defense is an annual inspection and regular maintenance of your appliances. Contact a licensed contractor or call your local utility company for assistance.

But remember, problems can begin after an inspection is over, like a crack in a furnace heat exchanger, or a leak in a water heater vent or a bird's nest blocking a flue. Other sources are nearly impossible to detect: even a change in the air pressure outside can turn a normally safe situation deadly. That's why you need the 24-hour protection provided by a CO and Gas alarm.

Part Two – Carbon Monoxide and Gas

Home Safety Tips

What You Can Do...

- Buy only appliances approved by a nationally recognized testing laboratory.
- Choose fuel-burning appliances that can be vented to the outdoors, whenever possible.
- Make sure appliances are installed according to manufacturer's instructions and local building codes. Most appliances should be installed by professionals and should be inspected by the proper authority after installation.
- Have the heating system, vents, chimney and flue inspected and cleaned by a qualified technician every year.
- Follow manufacturer's directions for safe operation of all fuel-burning appliances.
- Examine vents and chimneys regularly for improper connections, visible rust or stains.
- Open a window when a fireplace or wood-burning stove is in use, and provide adequate outdoor air for furnace and water heater.
- Notice problems that could indicate improper appliance operation:
 - Decreasing hot water supply
 - Furnace unable to heat house or runs constantly
 - Sooting, especially on appliances
 - Unfamiliar or burning odor
 - Yellow or orange flame
- Be aware of the symptoms of carbon monoxide poisoning:
 - headaches, dizziness, weakness, sleepiness, nausea, vomiting, confusion and disorientation.
- Recognize that CO poisoning may be the cause when family members suffer from flu-like symptoms that don't disappear but improve when they leave home for extended periods of time.

What You Should Not Do...

- Never burn charcoal inside a home, garage, cabin, RV or camper.
- Never install, service, or convert fuel-burning appliances from one type to another without proper knowledge, skills and tools.
- Never use a Gas range, oven, or clothes dryer for heating.
- Never operate unvented Gas-burning appliances, such as kerosene or natural Gas space heaters, in a closed room.
- Never operate Gasoline-powered engines (like vehicles, motorcycles, lawn mowers, yard equipment or power tools) in confined areas such as garages or basements, **even if** an outside door or window is open.
- Never ignore a safety device when it shuts off an appliance.
- Never ignore a CO alarm or Gas alarm.

Be Aware of the Warning Signs of Carbon Monoxide: Clues You Can See...

- Streaks of carbon or soot around the service door of your fuel-burning appliances.
- A yellow or orange flame may indicate a problem with natural Gas appliances.
- Excessive rusting on flue pipes or appliance jackets.
- Loose or missing furnace panel.
- Moisture collecting on the windows and walls of furnace rooms.
- Loose or disconnected vent/chimney, fireplace or appliance.
- Small amounts of water leaking from the base of the chimney, vent or flue pipe.
- Rust on the portion of the vent pipe visible from outside your home.
- The absence of a draft in your chimney (indicating blockage).
- Fallen soot from the fireplace chimney.
- Loose, damaged or discolored bricks on your chimney.

Clues You Cannot See...

- Internal appliance damage or malfunctioning components
- Improper burner adjustment
- Hidden blockage or damage in chimneys

Part Three - What You Should Know Before the Alarm Sounds

Learn the difference between dangerous levels, high levels, mid levels and low levels for an average healthy adult:

Dangerous levels, when someone is experiencing symptoms of CO poisoning and CO readings are generally above 100 ppm. Anytime someone is experiencing the symptoms of carbon monoxide poisoning this should be treated as an EMERGENCY. Follow the instructions on page 4-1.

High levels, generally above 100 ppm, with no one experiencing symptoms. This should be treated as an URGENT situation. Follow the instructions on page 4-1.

Mid levels, generally between 50 ppm to 100 ppm. This should be cause for CONCERN and should not be ignored or dismissed. Follow the instructions on page 4-1.

Low levels, generally below 50 ppm. This indicates a need to watch the situation closely to see if it resolves itself or worsens. Follow the instructions on page 4-2.

Determine if anyone in the household is at high risk for CO poisoning:

Many cases of reported carbon monoxide poisoning indicate that while victims are aware they are not well, they become so disoriented they are unable to save themselves by either exiting the building or calling for assistance.

You should **take extra precautions to protect high risk persons** from CO exposure because they may experience ill effects from carbon monoxide at levels that would not ordinarily affect a healthy adult. Are there any infants or small children in the home? Be sure to check them for signs of possible CO poisoning because they might have trouble explaining their symptoms. Infants and children are more susceptible to CO poisoning than a healthy adult.

Pregnant women should be aware that their unborn fetus could be harmed by exposure to carbon monoxide, even when the mother suffers no ill effect herself. Any pregnant woman who suspects she may have been exposed to carbon monoxide should immediately contact her physician.

Is there anyone in the household who is elderly, or who has anemia, heart disease or respiratory problems, emphysema or chronic bronchitis? These individuals are at higher risk for CO poisoning and for health problems from exposure to low levels of carbon monoxide.

If anyone in the household is at high risk for CO poisoning, we urge you to take extra precaution to prevent possible poisoning. You should consider a more sensitive alarm for your home safety. If the unit alarms or if CO readings are shown on the digital display, remove the at-risk person from the premises, if possible. Ventilate the area. The high-risk person(s) should not re-enter the residence until the source of the CO problem has been identified and corrected.

Understand the Effects of Carbon Monoxide Exposure:

Low Levels:
Generally 50 ppm and below.

Mid Levels:
Generally 50 ppm to 100 ppm.

High Levels:
Generally 100 ppm and above if no one is experiencing symptoms.

Dangerous Levels:
Generally 100 ppm and above if someone is experiencing symptoms.

Concentration of CO in Air (ppm = parts per million)	Approximate Inhalation Time and Symptoms Developed
50 ppm	The maximum allowable concentration for continuous exposure for healthy adults in any 8-hour period, according to OSHA*.
200 ppm	Slight headache, fatigue, dizziness, nausea after 2-3 hours.
400 ppm	Frontal headaches within 1-2 hours, life threatening after 3 hours.
800 ppm	Dizziness, nausea and convulsions within 45 minutes. Unconsciousness within 2 hours. Death within 2-3 hours.
1,600 ppm	Headache, dizziness and nausea within 20 minutes. Death within 1 hour.
3,200 ppm	Headache, dizziness and nausea within 5-10 minutes. Death within 25-30 minutes.
6,400 ppm	Headache, dizziness and nausea within 1-2 minutes. Death within 10-15 minutes.
12,800 ppm	Death within 1-3 minutes.

* Occupational Safety and Health Administration

Reminder: This chart relates to the exposure of healthy adults. Read the info above for descriptions of those who are at higher risk.

Part Four – What to Do When the Alarm Sounds for Carbon Monoxide

Determine if anyone in the household is experiencing symptoms of CO poisoning. Many cases of reported CO poisoning indicate that while victims are aware they are not well, they become so disoriented they are unable to save themselves by either exiting the building or calling for assistance. Also young children and household pets may be the first affected. The following symptoms are related to CARBON MONOXIDE POISONING and should be discussed with ALL members of the household:

Become familiar with these common symptoms from CO poisoning.

Common Mild Exposure Symptoms:
Slight headache, nausea, vomiting, fatigue (“flu-like” symptoms).

Common Medium Exposure Symptoms:
Throbbing headache, drowsiness, confusion, fast heart rate.

Common Extreme Exposure Symptoms:
Convulsions, unconsciousness, heart and lung failure. It can cause brain damage and death.

If you experience even mild symptoms of CO poisoning, consult your doctor immediately!



WARNING:

Actuation of your CO and Gas alarm indicates the presence of Carbon Monoxide (CO) or explosive Gas which can KILL YOU.

When the CO and Gas alarm senses a dangerous level of CO, the unit will emit a loud alarm pattern and display the concentration of CO in parts per million (PPM). The alarm pattern is 4 short beeps – followed by 5 seconds of silence – followed by 4 short beeps repeating. (Note: When the unit is disconnected from the 120V power supply and is on battery backup, the alarm pattern will continue for the first 4 minutes after detecting CO and then the cycle will repeat every one minute). Know how to respond to a CO or Gas emergency. Periodically review this user’s guide and discuss with all members of your family.

If the alarm sounds for carbon monoxide:

1) Operate test/reset button;

2) Call your emergency services

PHONE NUMBER

(fire dept. or 911);

3) Immediately move to fresh air - outdoors or by an open door/window. Do a head count to check that all persons are accounted for. Do not reenter the premises nor move away from the open door/window until the emergency services responders have arrived, the premises have been aired out, and your CO and Gas alarm remains in its normal condition.

4) After following steps 1-3, if your alarm reactivates within a 24 hour period, repeat steps 1-3 and call a qualified technician to investigate for sources of CO from fuel burning equipment and appliances, and inspect for proper operation of this equipment. If problems are identified during this inspection have the equipment serviced immediately.

PHONE NUMBER

Note any combustion equipment not inspected by the technician and consult the manufacturer’s instructions, or contact the manufacturer’s directly, for more information about CO safety and this equipment. Make sure that motor vehicles are not, and have not been, operating in an attached garage or adjacent to the residence.

Part Four – What to Do if the Alarm Sounds for Gas

Treatment for CO Poisoning

Any person who is suspected to have carbon monoxide poisoning should leave the potentially dangerous environment, get fresh air immediately and seek care from a physician. CO poisoning can be determined by a simple blood test, called a “carboxyhemoglobin” test. This test measures the amount of carbon monoxide in the bloodstream. For this test to be accurate, it must be done immediately after CO exposure. Acute CO poisoning is usually treated by breathing in oxygen. When CO poisoning is severe, (for example, when there is an altered state of consciousness), high pressure oxygen therapy in a special “hyperbaric chamber” may be used. A physician will make this determination and administer treatment if necessary.

What to DO if the Alarm Sounds for Gas

Activation of the Gas alarm indicates the presence of an explosive Gas, which can cause an explosion and/or fire. When the unit senses either natural Gas or propane, the display will show “GAS” and emit a loud alarm pattern. The alarm pattern for Gas is a 1/2 second beep followed by a 1/2 second of silence then repeating. Know how to respond to a CO or Gas emergency. If the unit alarms for Gas:

- 1) Evacuate the premises.
- 2) Do not activate any electrical switch or telephone.
- 3) Contact your fire department

Calling a Qualified Technician to Find and Repair the Problem

If you call a qualified service technician (such as a licensed heating contractor, utility service technician or fuel provider) to inspect your home for possible sources of CO or Gas leak. Do not restart these appliances until the problem is corrected. Request service for as soon as possible, like **TODAY**.

Please be aware that some service technicians may charge a fee to inspect your home, even if the source of CO or Gas is not found. You may wish to find out if you will be charged for the service and the amount of the fee before you request service. Some public utilities do not charge for inspection. Some service technicians do not charge if you purchased your appliance from them. To know for sure, you need to ask before the technician comes to your home. Repair work or replacement of appliances may be necessary to fix the problem that is creating the CO or Gas in your home. Remember, a CO and Gas alarm can only warn you of the presence of CO or Gas, it does not prevent CO or Gas from occurring, nor can it solve an existing CO or Gas problem.

Because you've provided ventilation by leaving your windows and doors open, the CO or Gas buildup may have dissipated by the time help responds. Although your problem may appear to be temporarily solved, it's crucial that the source of the problem is determined and appropriate repairs are made.

Sometimes it's Difficult to Find the Source of CO in a Home

It can be difficult for responders to locate the source(s) of CO if:

- The house was ventilated before they arrived and the fresh air caused the CO to dissipate. The peak level function on your Nighthawk CO and Gas alarm helps the responders know how severe the problem was before they arrived.
- The CO problem was caused by a source that fluctuates on and off, sometimes creating CO and sometimes not. Such a situation makes it nearly impossible to pinpoint the source of CO in a short period of time.
- The cause of CO problem was backdrafting – when air in a chimney or flue is sucked into the home instead of venting outside. The exact situation that created a negative air pressure inside the home (the cause of backdrafting) is difficult to recreate during an investigation for CO. Sometimes the CO problem disappears when a door or window is opened. Backdrafting may or may not happen again.

Part Five – Technical Information

Product Specifications

Power:	120V AC units: 60 Hz, Current 120 mA max.
Sensor:	CO sensor calibrated at 150 ppm (± 25 ppm). Gas sensor calibrated to alarm before 25% of the LEL.
Temperature:	Operating range: 40°F (4.4°C) to 100°F (37.8°C).
Mounting:	Accessories supplied for wall mount or direct plug applications.
Alarm:	85+ dB at 10' @ 3.4 \pm 0.5 KHz pulsing alarm.
LED Operation:	Blinking dot on display denotes normal operation. Digital readout 30-999. In alarm condition for CO you will hear 4 quick beeps, 5 seconds off, repeating for CO. In alarm condition for GAS you will hear a 1/2 second beep, 1/2 second silence, repeating for GAS.
Battery Backup:	A 9V battery is needed. If battery is low or missing while the unit is plugged into a 120V outlet, an "Lb" message will display which will blink alternately with a the CO reading every second and the sounder will chirp every 15 seconds.
Unit Malfunction:	"Err" error message will display. Intermittent alarm will sound every 30 seconds. Refer to pages 1-6, 6-3 and 6-4 for other error conditions.
Test/Reset Button:	Test button verifies proper unit operation and resets the unit in the event of a CO and Gas alarm.
Peak Level Memory Button:	When pressed, LED will display the highest CO ppm level detected since unit was powered up or since unit was reset with test button. Reading will be stored in memory as long as unit is not reset or unplugged. Any CO concentration detected from 11-999 will be displayed
Size:	6"L x 3.75"W x 1.8"H. Wt. 1 lb.
Warranty:	Five-year warranty from date of purchase against defects in material and workmanship.

How the Unit Determines When to Alarm

Your Nighthawk alarm uses advanced technology to monitor the environment in your home and warn you of unacceptable levels of carbon monoxide or Gas. An internal microcomputer works together with the sensors inside the alarm to determine the levels of carbon monoxide or Gas in the air. The microcomputer is calibrated to trigger the unit's alarm before most people would experience any symptoms of carbon monoxide poisoning or in the case of natural Gas or propane, the alarm will trigger before 25% of the lower explosion limit (LEL). Because carbon monoxide is a cumulative poison, long-term exposures to low levels can cause symptoms, as well as short-term exposures to high levels. Your Nighthawk unit has a **time weighted alarm**, so the higher the level of carbon monoxide present, the sooner the alarm will be triggered.

This Nighthawk alarm meets the alarm response time requirements of UL Standard 2034 which are as follows for CO:

At 70 ppm, the unit must alarm within 60-240 minutes.
At 150 ppm, the unit must alarm within 10-50 minutes.
At 400 ppm, the unit must alarm within 4-15 minutes.

This Nighthawk alarm meets the alarm response time requirements of UL Standard 1484 which are as follows for Gas:

This unit shall alarm before 25% of the LEL of either natural Gas or propane is detected. In all cases, the unit will detect carbon monoxide as a priority over Gas. If the device is detecting Gas, then detects an amount of CO to cause an alarm, the device will stop alarming for Gas and alarm for CO.

WARNING: This product is intended for use in ordinary indoor locations of family living units. It is not designed to measure compliance with Occupational Safety and Health Administration (OSHA) commercial or industrial standards. Individuals with medical problems may consider using warning devices which provide audible and visual signals for carbon monoxide concentrations under 30 ppm.

Accuracy of the Digital Display

Each Nighthawk CO and Gas alarm is calibrated at a CO concentration of 150 ppm in air, at 80° F (± 10 ° F) and 40% (± 3 %) relative humidity. Depending on the ambient condition (temperature, humidity) and the condition of the sensor, the alarm readings may vary. Under the same ambient conditions the device will alarm for Gas before 25% of the LEL is reached.

The digital reading tolerances are:

Ambient: 80° F (± 10 ° F), atmospheric pressure $\pm 10\%$, 40% $\pm 3\%$ relative humidity.

Reading	Tolerance (of displayed reading)
0-999 ppm	$\pm 20\%$ +15 ppm

Part Six – Frequently Asked Questions

Q. How many alarms do I need in my house? How much square footage will one alarm cover?

A. We recommend you place alarms near the sleeping area(s). If you have a multi-level home, you should place an alarm on each level of the home. A good rule of thumb for the number and placement of CO and Gas alarms for your particular home is to place CO and Gas alarms near smoke alarms that have been installed to meet current building code requirements.

Generally, one alarm can be adequate for 1,200 to 1,500 square feet of living space. The most important determination for the number of units needed is whether an alarm can be heard in all sleeping areas.

Q. Can you explain what “time-weighted alarm” means?

A. Because carbon monoxide is a cumulative poison, two factors determine how the body is affected by CO: the level of exposure and the length of exposure. For example, being continuously exposed to low levels of carbon monoxide for many hours can be as dangerous as being exposed to higher levels of CO for a short period of time.

The microchip inside your Nighthawk CO and Gas alarm monitors the air for the presence of carbon monoxide and computes the levels and length of exposure, alarming when you should be concerned about CO exposure.

For more information about the alarm, see page 5-1.

Q. Do I have to press the test button to get a CO or Gas reading?

A. No. Your Nighthawk CO and Gas alarm continuously monitors the air for carbon monoxide and gas. An updated reading is shown on the digital display every 15 seconds. If there is no CO or Gas present, the digital display will show a zero. The alarm will alert you to the presence of CO or Gas automatically.

To test the internal components and circuitry of your alarm, press the Test/Reset button. For complete instructions on testing your alarm, see page 1-5.6.

Q. What happens if the power goes out?

A. If a good battery is in the unit, the alarm will display a blinking dot for at least 20 hours while still providing protection against CO or Gas exposure. Please note however, that the alarm will sample for the presence of gas once every eight minutes while on battery backup. Gas could be present during this eight minute period without alarming. Please see page 1-5.

Q. How do I get the alarm to show something besides “0.” OR, How can I determine if the sensors are operating correctly?

A. Please refer to “Testing Sensor Response” on page 1-6 for complete instructions on how to test your alarm’s electronics and sensor functions.

Q. You warranty the alarm for five years. How will I know when it doesn’t work anymore and I need to buy a new one?

A. In any event of malfunction, your alarm will alert you with malfunction signals. These signals are described in detail on page 1-6.

Q. What do the numbers mean on the digital display when I press the “Test/Reset” button?

A. The numbers you see when you press the Test/Reset button are NOT a CO reading or a Gas alarm. This is a *simulated* reading the alarm displays as it tests its electronics. The numbers displayed when the Test/Reset button is pushed should be between 100 to 400 (usually around 200). These numbers are shown after the “Gas” test is complete.

Q. I called in someone to inspect my home for CO after my unit alarmed, and he couldn’t find anything wrong. Why? Does that mean this unit “false alarmed”?

A. No. Please read the information explaining why a CO problem can be difficult to diagnose on page 4-2. Also, please read the information on page 1-6 to make sure you experienced an alarm and not a malfunction alert.

Q. I tried to test the alarm (see below) and it still reads “0.” Why?

- **by running the car in the garage**
- **by holding it to the tailpipe of the car**
- **by putting it next to the furnace vent**

A. DO NOT try to test your alarm by doing any of the above! Testing the alarm using any of the methods listed above usually does not yield satisfactory results and *could in fact be dangerous*. To accurately test the alarm, please follow the guidelines given on page 1-5.6.

Never operate a vehicle in a closed garage, as high levels of CO can be built up in a short time. With an attached garage, dangerous CO levels develop inside the home as well as within the garage.

Part Six – Frequently Asked Questions

Attempting to test the sensor function by holding the alarm next to a tailpipe or furnace vent may not cause a reading on the display because today's vehicles emit very little CO once the engine reaches operating temperature. Likewise, many of today's high efficiency furnaces emit very low levels of CO.

Q. When I tried to test the unit I got a high number on the digital display, but the alarm didn't sound immediately. Why?

A. Please refer to "How the unit determines when to alarm" on page 5-1 for an explanation of the "time weighted alarm."

Q. Will the alarm last longer if I unplug it during the summer months and only use it during the winter?

A. No. Some components of the alarm can deteriorate over time if not used regularly. We recommend the alarm be plugged in continuously for maximum alarm life.

Q. I use the alarm in a vacation home that isn't always occupied and can have temperature extremes when no one is there (no heat or no air conditioning). Will that hurt the alarm? Should I leave it plugged in all the time?

A. We recommend that your alarm not be installed in areas where temperatures fall below 40°F (4.4°C) or rise above 100°F (37.8°C). Your alarm was designed to be constantly plugged in for maximum performance.

Q. I plugged in the alarm at my house (my parents', my neighbors', etc.) and it read "0." Does that mean everything is OK? (I'm thinking I can return the alarm since everything checks out OK.)

A. This alarm is designed to act as a continuous monitor, it is not designed for use as a short-term testing device to perform a quick check for the presence of CO or Gas.

Remember, a problem can occur at any time, even after a professional inspection has determined that everything is in proper working order. Examples of problems that can develop are a crack in a furnace heat exchanger, a leak in a water heater vent, a bird's nest blocking a flue, or a Gas line fitting becomes loose.

Part Six – Display Reading and What They Mean

Page 6-3 and 6-4 contain vital information about the various readings you may see on your display. We suggest you keep this User's Guide handy for reference.

Your new Nighthawk carbon monoxide and explosive Gas alarm is a sophisticated electronic device – yet very simple to understand. Basically, the unit will display a “0” if it does not sense carbon monoxide or Gas and if you have a good 9V backup battery installed.







If it senses carbon monoxide, it will display a reading in parts per million of carbon monoxide or “GAS” if either natural Gas

or propane has been detected.

However, if the backup battery is low or missing, or if the unit malfunctions it will display other readings (and alarm differently) to alert you that something is wrong with the alarm.

Please familiarize yourself and other family members to the difference between a CO reading, a Gas reading and a reading signifying a problem with the alarm itself.

Start-up and Normal Operation Readings

Display Shows	Alarm Sound	Unit Status	Recommended Action
 Brief “888”	One short “chirp”	Self checking when AC powered (Test button was pressed or unit was first powered).	None – Unit should return to zero within a minute..
 ↑↓ (flashes alternately) 	One short “chirp” every 15 seconds.	Start-up or reset phase when AC powered and low battery or missing battery.	Install or Replace 9V battery Refer to page 1-4.
 Steady “0” and flashing dot	None	Normal AC operation (sensing no CO or Gas) and with good battery	None
 Steady display of high number (in the hundreds of ppm) and flashing dot	4 quick beeps, 5 seconds off, repeating.	High level of CO detected	Refer to page 4-1
 GAS	1/2 second beep, 1/2 second silence repeating	Unit has detected Gas.	Refer to page 4-2.





If at any time the alarm does not perform as described, have it replaced immediately.

Part Six – Display Reading and What They Mean

Readings You May See When Unit is AC Powered

Display Shows	Alarm Sound	Unit Status	Recommended Action
 Steady “Err” and flashing dot	“Chirp” every 30 seconds	Unit malfunctioning when AC powered	Call KIDDE Safety customer service at 1-800-880-6788

Readings You May See When Unit is on Temporary Battery Backup

Display Shows	Alarm Sound	Unit Status	Recommended Action
 Flashing dot	None	Normal battery-only operation – unit will show reading only if it senses CO or gas	Plug in to AC as soon as possible to conserve battery
 Steady “Err” and flashing dot	“Chirp” every 30 seconds	Unit malfunctioning when battery powered	Call KIDDE Safety customer service at 1-800-880-6788
 Flashing dot	“Chirp” every 30 seconds	Very low battery – unit will not respond to CO or gas	Replace battery Refer to Step 3 on page ii.
 No display	Constant Alarm	Near dead battery or unit malfunction	Replace battery – If this does not fix condition, Call KIDDE Safety customer service at 1-800-880-6788

If at any time you test the alarm and it does not perform as described, have it replaced immediately.

Wall Mount Diagram

If you are going to mount your Nighthawk CO and Gas alarm to the wall, you may use this guide for exact placement of the two wall mount screws provided. For more information about mounting to the wall, please refer to page 1-4.

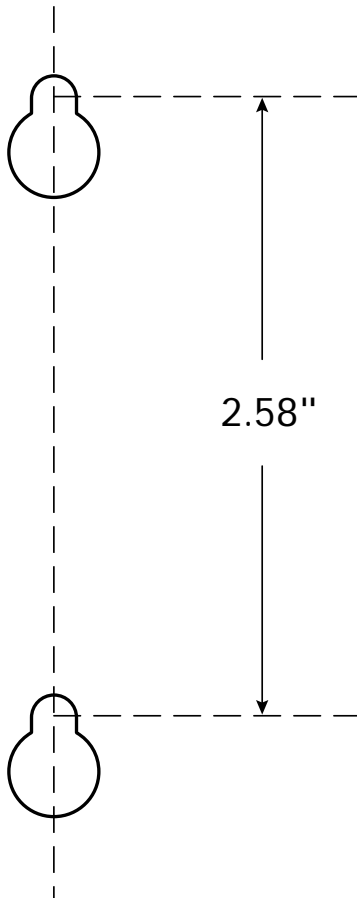

Limited Warranty

WARRANTY COVERAGE: THE MANUFACTURER WARRANTS TO THE ORIGINAL CONSUMER PURCHASER, THAT THIS PRODUCT WILL BE FREE OF DEFECTS IN MATERIAL AND WORKMANSHIP FOR A PERIOD OF FIVE (5) YEARS FROM DATE OF PURCHASE. THE MANUFACTURER'S LIABILITY HEREUNDER IS LIMITED TO REPLACEMENT OF THE PRODUCT, REPAIR OF THE PRODUCT OR REPLACEMENT OF THE PRODUCT WITH REPAIRED PRODUCT AT THE DISCRETION OF THE MANUFACTURER. THIS WARRANTY IS VOID IF THE PRODUCT HAS BEEN DAMAGED BY ACCIDENT, UNREASONABLE USE, NEGLIGENCE, TAMPERING OR OTHER CAUSES NOT ARISING FROM DEFECTS IN MATERIAL OR WORKMANSHIP. THIS WARRANTY EXTENDS TO THE ORIGINAL CONSUMER PURCHASER OF THE PRODUCT ONLY.

Warranty Disclaimers: Any implied warranties arising out of this sale, including but not limited to the implied warranties of description, merchantability and fitness for a particular purpose, are limited in duration to the above warranty period. In no event shall the Manufacturer be liable for loss of use of this product or for any indirect, special, incidental or consequential damages, or costs, or expenses incurred by the consumer or any other user of this product, whether due to a breach of contract, negligence, strict liability in tort or otherwise. The Manufacturer shall have no liability for any personal injury, property damage or any special, incidental, contingent or consequential damage of any kind resulting from gas leakage, fire or explosion.

Warranty Registration

To register for your five year factory warranty, please fill out the enclosed warranty card completely, apply necessary postage and place in the mail. You may place the warranty card in a separate envelope if you wish.

Please use the following address for warranty registration ONLY:

KIDDE Safety
Product Registration Department
PO Box 8748
Denver, CO 80201-8748

Please send products and all other correspondence to:

KIDDE Safety
Attn.: Customer Service Department
1394 South Third Street
Mebane, NC 27302

Warranty information is located on the label on the back of the alarm. For your convenience, please complete the warranty information before installing the alarm.

The model number and assembly number can be found on the label on the back of the alarm.

For Warranty Service:

In many cases the quickest way to exchange your alarm is to return it to the original place of purchase. If you have questions, call the KIDDE Safety customer service department at 1-800-880-6788 for assistance.

Some states do not allow limitations on how long an implied warranty lasts, so the above limitation may not apply to you.

Some states do not allow the exclusion or limitation of consequential or incidental damages, so the above limitations or exclusions may not apply to you.

Legal Remedies: This warranty gives you specific legal rights and you may also have other rights that vary from state to state.

Warranty Performance: During the above warranty period, your product will be replaced with a comparable product if the defective product is returned, postage prepaid, to KIDDE Safety, Customer Service Department, 1-800-880-6788, together with proof of purchase date. Please include a note describing the problem when you return the unit. The replacement product will be in warranty for the remainder of the original warranty period or for six months, whichever is longer. Other than the cost of postage, no charge will be made for replacement of the defective product.

Important: Do not remove back cover. Back cover removal will void warranty.

Your *Nighthawk Carbon Monoxide and Explosive Gas Alarm* is not a substitute for property, disability, life or other insurance of any kind. Appropriate insurance coverage is your responsibility. Consult your insurance agent.



1394 South Third Street, Mebane, NC 27302
Consumer Hotline: 1-800-880-6788
www.kiddesafety.com



Custom Assembled in China with U.S. and Foreign Components.