

**NCR 5992 Signature  
Capture Plus**  
Release 1.0  
**User's Guide**



B005-0000-1108  
Issue C

---

The product described in this book is a licensed product of NCR Corporation.

IBM is a registered trademark of International Business Machines, Inc.

It is the policy of NCR Corporation (NCR) to improve products as new technology, components, software, and firmware become available. NCR, therefore, reserves the right to change specifications without prior notice.

All features, functions, and operations described herein may not be marketed by NCR in all parts of the world. In some instances, photographs are of equipment prototypes. Therefore, before using this document, consult with your NCR representative or NCR office for information that is applicable and current.

To maintain the quality of our publications, we need your comments on the accuracy, clarity, organization, and value of this book.

Address correspondence to:

Retail Solutions Group—Atlanta  
NCR Corporation  
2651 Satellite Blvd.  
Duluth, GA 30096

Copyright © 2000  
By NCR Corporation  
Dayton, Ohio U.S.A.  
All Rights Reserved

---

# Table of Contents

## **Chapter 1 Overview**

Introduction .....	1-1
Physical Description .....	1-2
5992 Model Configurations.....	1-2
Security.....	1-2
5992 Signature Capture Unit .....	1-3
Stylus .....	1-3
Interface Cable .....	1-3
Power Module .....	1-4
Functional Description .....	1-4
Communication Interface.....	1-5
EIA-232.....	1-5
IBM-EIA-485 .....	1-6

## **Chapter 2 Available Software**

Software Products.....	2-1
------------------------	-----

## **Chapter 3 Installation**

Hardware Considerations.....	3-1
5992 Unit Location.....	3-1
Power Considerations .....	3-2
Power Modules.....	3-2
Auxiliary Power Cable.....	3-2
Environmental Considerations.....	3-3
Unpacking.....	3-3
Inspection.....	3-3
Inventory.....	3-4
Installation .....	3-4

Connecting and Disconnecting the NCR 5992  
Stylus and Host Cable ..... 3-5

Connecting the NCR 5992 to the NCR 7452/3  
Workstation..... 3-8

Cable Configurations ..... 3-8

Connecting the NCR 5992 to a PC..... 3-12

**Chapter 4 Operational Modes**

Introduction ..... 4-1

Normal Mode..... 4-1

Supervisor Mode ..... 4-3

Startup Sequence ..... 4-3

Operation ..... 4-5

Menu Flow ..... 4-6

Supervisor Menu Items..... 4-6

Maintenance Mode ..... 4-18

Performing a Setup..... 4-18

Performing Diagnostics ..... 4-20

Loading the Operating System..... 4-21

**Chapter 5 Troubleshooting**

Introduction ..... 5-1

Simple Troubleshooting Guide ..... 5-1

Detailed Problem Troubleshooting ..... 5-2

**Chapter 6: Diagnostics Specification**

Introduction ..... 6-1

Startup Sequence ..... 6-1

Operation ..... 6-4

Menu Flow ..... 6-5

Keypad Test ..... 6-6

Display Test ..... 6-7

MSR Test ..... 6-7  
IBM 46xx Test..... 6-9  
Host RS232 Test ..... 6-10  
AUX1A RS232 Test..... 6-13  
AUX1B RS232 Test ..... 6-16  
SRAM Test ..... 6-19  
Encryption Test..... 6-20  
Security Menu..... 6-20  
OS Version ..... 6-31  
Library Version..... 6-31  
Security Version..... 6-32  
Digitizer Version ..... 6-32  
Calibrate ..... 6-33  
Stylus Test..... 6-36  
LCD Contrast..... 6-36  
Show Touches..... 6-37  
Base Line/Gain..... 6-38  
Show Keypad Touches..... 6-38

**Chapter 5 Index**



## Revision Record

Issue	Date	Remarks
A	Apr 99	First issue
B	Oct 99	Revision
C	July 00	Added K150 security and IVI Checkmate Keyfac support in Chapter 6.

# Radio Frequency Interference Statements

## Federal Communications Commission (FCC)

### ***Information to User***

This equipment has been tested and found to comply with the limits for a Class A digital device, pursuant to Part 15 of FCC Rules. These limits are designed to provide reasonable protection against harmful interference when the equipment is operated in a commercial environment. This equipment generates, uses, and can radiate radio frequency energy and, if not installed and used in accordance with the instruction manual, may cause harmful interference to radio communications. Operation of this equipment in a residential area is likely to cause interference in which case the user will be required to correct the interference at his own expense.

NCR is not responsible for any radio or television interference caused by unauthorized modification of this equipment or the substitution or attachment of connecting cables and equipment other than those specified by NCR. The correction of interference caused by such unauthorized modification, substitution or attachment will be the responsibility of the user. The user is cautioned that changes or modifications not expressly approved by NCR may void the user's authority to operate the equipment.

## Canadian Department of Communications

This digital apparatus does not exceed the Class A limits for radio noise emissions from digital apparatus set out in the Radio Interference Regulations of the Canadian Department of Communications.

Le présent appareil numérique n'émet pas de bruits radioélectriques dépassant les limites applicables aux appareils numériques de la classe A prescrites dans le Règlement sur le brouillage radioélectriques édicté par le ministère des Communications du Canada.

## Voluntary Control Council For Interference (VCCI)

この装置は、情報処理装置等電波障害自主規制協議会（VCCI）の基準に基づくクラスA情報技術装置です。この装置を家庭環境で使用すると電波妨害を引き起こすことがあります。この場合には使用者が適切な対策を講ずるよう要求されることがあります。



# Chapter 1 Overview

---

## Introduction

The NCR 5992 Signature Capture Plus unit is designed to speed up credit card and other payment methods in the point of service (POS) environment. Your customers use a stylus to authorize transactions without paperwork. The transaction data and signatures are stored electronically.

Controlled by an application running on your PC-based host workstation, the 5992's high resolution graphics screen can also display any of the following and more:

- Credit receipts
- Void and return slips
- Car rental forms
- Extended warranty agreements
- Customer surveys
- Animated advertising and promotional messages

An MSR option allows easy entry of magnetic stripe card data, and a PIN entry option lets your customers enter their personal identification numbers under secure conditions.

## Physical Description

The basic 5992 includes the signature capture unit, a stylus assembly, an interface cable, and a power module, as shown below.

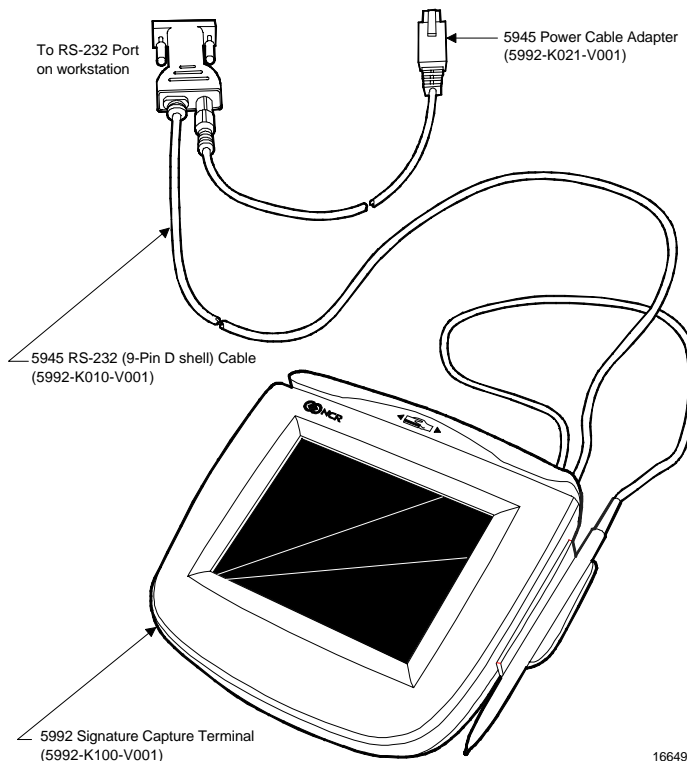

**Warning:** The 5992 terminal cannot be opened for any reason.

## 5992 Model Configurations

### Security

The NCR 5992 is a secure model that provides encryption functions for secure PIN entry and processing of debit transactions, PIN numbers, and similar input.

Encryption key codes and other security factors are set at the factory. Special encryption keys are set by your system administrator or local clearing financial institution. A cabinet security interlock prevents unauthorized access to random access memory (RAM) containing the encryption key codes.

Opening the cabinet erases the 5992 system RAM contents, requiring the software and encryption keys to be reloaded.

## 5992 Signature Capture Unit

The 5992 signature capture unit is housed in an injection-molded thermoplastic cabinet. The physical specifications are:

- Weight - Installed: 28 oz (0.81 kg)
- Width: 8.5 in. (21.6 cm)
- Depth: 7.5 in. (19.1 cm)
- Height: 2.75 in. (6.98 cm)
- 320 by 240 pixel supertwist LCD display
- Active display area: 4.5 in. (11.4 cm) by 3.4 in. (8.6 cm)

## Stylus

The stylus is attached to a lightweight, flexible, 27.5-inch (69.8 cm) cable that connects it to the 5992.

## Interface Cable

The communications interface cable connects the 5992 signature capture unit to the host workstation via EIA\_232. It includes a connector for the power module DC cable.

## Power Module

The power module is a Class 2 power supply. It includes an ac plug that connects to the wall outlet, plus a cable that supplies +12 volts DC to the 5992.

## Functional Description

The 5992 combines a graphic liquid crystal display (LCD) with a transparent digitizer. This combination permits your customer to sign a displayed image of a credit card form or other multi-line form. This signature image is then digitized and supplied to the host workstation for processing.

The electronic signature capture capability and the ability to display high-resolution graphics are innovative features of the 5992. These features bring new dimensions to the operation of your business and service to your customers. Also, the customer display reduces system costs by replacing the customer display of the host workstation.

As a customer display, the 5992 displays up to 30 lines of 40 characters each. It also displays forms, surveys, or high-resolution graphic images such as promotional messages targeted to in-store customers. In addition, the 5992 has a magnetic stripe reader (MSR) for credit/debit card data entry.

The 5992 operates with any host workstation or processor that has EIA-232 interface. The host is loaded with an application program that implements the features and functions of the 5992.

The operation of the 5992 is controlled by commands and data sent to it from the application software running in the host workstation. The application software:

- sends transaction data
- downloads credit slip graphics data for display
- downloads forms or surveys for display
- downloads graphic data files or text for promotional displays

- collects the customer's signature.
- prints the signature on the customer's receipt
- handles storage of the electronic transaction record and signature

Typically, promotional display data files are developed on the system processor or a personal computer (PC), using a commercially available graphics software package. These graphic data files are formatted using the WinForm utility, and then downloaded from the host workstation and stored in the 5992.

The 5992 is loaded with its operating system at the factory, and is delivered in a fully functional condition. A lithium battery provides memory retention voltages for all RAM locations.

## Communication Interface

The NCR 5992 communicates with a host workstation using one of two interfaces: EIA-232 or IBM-EIA-485. The interface cable used dictates the communication type.

An interface cable provides the required electrical conductors for signals between the host workstation and the 5992. Although two different cables are available; the one supplied is for the communications type specified in your order.

### EIA-232

EIA-232 protocol transmission is a synchronous, half duplex. The data format is 7, 8 or 9 data bits, parity or no parity, and one stop bit. Baud rates up to 38.4 Kbps are supported by the device. However, the NCR diagnostics and utilities only supports up to 19.2Kbps. The 5992 can either manually select or automatically detect the host data rate.

## **IBM-EIA-485**

The 5992 supports the future release of the IBM EIA-485 protocol for direct connection to an IBM 468x terminal. The EIA-485 interface supports a 187,500 bps data rate using half-duplex, asynchronous mode. The data format is eight data bits, one start bit, one poll/select bit and two stop bits.

# Chapter 2 Available Software

---

## Software Products

The software available for the NCR 5992 is provided on 3.5" DOS diskettes. This software includes the following products:

- 5991/2 Utilities (not available in Canada)  
(Order number G370-1123-0100):
  - 5991 unit test utility
  - WINFORM.EXE (A Windows-based utility that combines the advertisement screen generator and forms screen generator)
  - Security key loader utility<sup>1</sup>
  - 5992 platform operating system load file
  - 5992 platform host command processor (HCP) application load file
- 5991/2 host sample source code (G370-1124-0100):
  - Sample application in IBM 4683 BASIC
  - Sample application in C for 5991 with dedicated host
  - Developer Program Interface (DPI) support module, which provides an interface to each function code supported by the 5991

---

<sup>1</sup>The security key loader is not usable with 5991-05xx models or any of the 5992 models.

- Communication module, which provides the RS-232 communications interface to the 5992
- Utility module, which provides sample program interface routines to the 5992

Further information about this software is provided in the *Developer's Guide, B005-0000-1107*.



# Chapter 3 Installation

---

The NCR 5992 can be installed by a person who has maintenance technician skills and is familiar with the host system.

The installer must know where to install the 5992, which host workstation to use, and which of the workstation's communication ports to use.

Connecting a 5992 to a host (PC, terminal, or workstation) is normally a simple process. However, some hosts require a trained technician to remove cabinetry and install the cable(s). Refer to your host documentation.

The installation process consists of:

- connecting the required cables to the 5992
- verifying the operation of the 5992.

## Hardware Considerations

### 5992 Unit Location

Install the 5992 on a stable, level surface such as the top of a table, checkout counter, or shelf. Position it for convenient access by the customer and to be in full view of the workstation operator.

Provide cabinet access holes and cable channels for the interface cable and power module (or power adapter kit), as discussed in this chapter.

## Power Considerations

Your 5992 should be ordered with either an AC power module or a host power adapter kit.

5945-K020-V001	Power Supply: (120V, 60Hz US/Canada)
5945-K021-V001	Cable: 7452 / 7453 Power Adapter
5945-K025-V001	Power Supply: (220V, 50Hz limited international)

### Power Modules

The power modules consume 15 watts of ac power. They produce the +12 volts DC at 700 mA (8.4 watts) required by the 5992. The +12 volt DC power connector is the same on all modules.

### Auxiliary Power Cable

An Auxiliary Power Cable uses any host power source (such as the 7452 Workstation) that has a compatible mating connector and can supply the +12 volts DC at 700 mA (8.4 watts) required by the 5992.

## Environmental Considerations

The following table lists the environmental limits and restrictions of the 5992.

	Operating	Storage	Transit
Temperature (dry bulb)	32°F to 104°F (10°C to 40°C)	-4°F to 140°F (-10°C to 50°C)	-40°F to 140°F (-40°C to 60°C)
Relative Humidity	0% to 80%	0% to 95%	5% to 95%
Dew Point Temperature	79° F (26° C) maximum	N/A	N/A
Barometric Pressure	31 in./Hg to 23.5 in./Hg (105 kPa to 70.0 kPa)	N/A	31 in./Hg to 23.5 in./Hg (105 kPa to 70.0 kPa)
Equivalent Altitude	3000 m (9850 ft)	N/A	3000 m (9850 ft)

### Unpacking

When you unpack the 5992, you remove several pieces of packaging material. Save this packaging material for use in case a return shipment for service is required.

### Inspection

Inspect the 5992 for any evidence of physical damage. Report any damage to the common carrier. If a shipment damage claim is filed, save all packaging materials with the damaged 5992 until the claim is settled.

## Inventory

Before beginning installation, make sure you have received all of the required modules to install the 5992.

- NCR 5592 unit and stylus
- Communication Cable (specific to you connectivity requirements)
- Power Supply (optional)
- Remote Connector Block (RCB) (optional)
- Installation and Operating Guide

## Installation

The following sections describe the steps needed to successfully install your NCR 5992. A specific installation sheet may be included in the documentation if your connectivity requirement is not one of the installations included in this manual.

A power supply may have been ordered with the NCR 5992. This only needs to be connected if the host device (PC or cash register) does not supply power.

You may also need to connect a power supply if there is not sufficient power for additional devices you may install (such as a check reader, scan gun, etc.).

## Connecting and Disconnecting the NCR 5992 Stylus and Host Cable

This section provides step-by-step instructions on how to connect the stylus and host cable to the NCR 5992 unit.

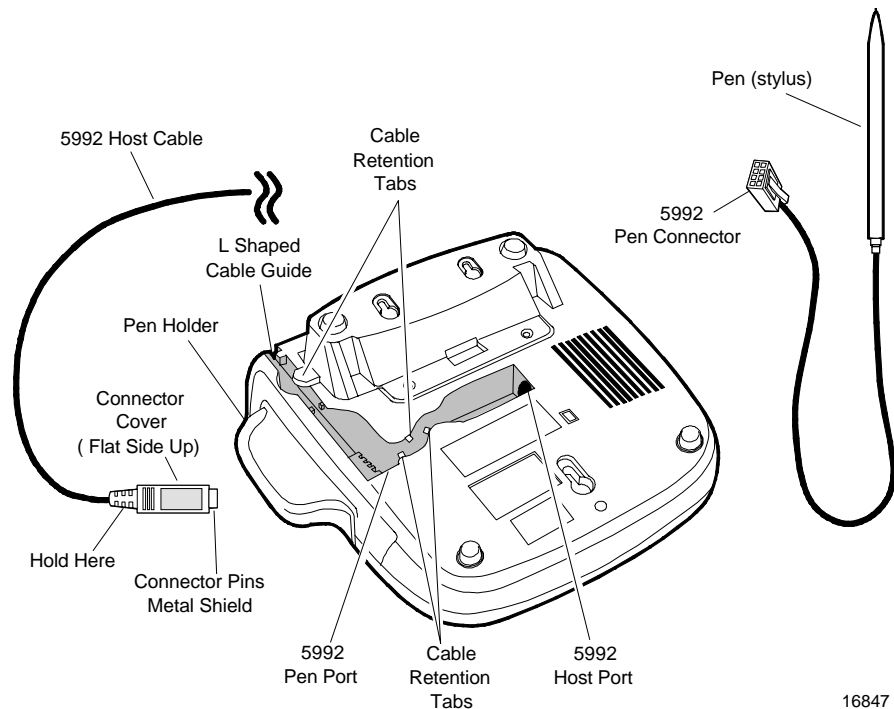

16847

### Connecting the NCR 5992 Stylus

1. Place the NCR 5992 in front of you with the bottom of the unit facing up.

**Note:** Be careful not to place the unit on a surface where the graphical display screen can be scratched or damaged.

2. Insert the NCR 5992 Stylus Connector into the NCR 5992 Stylus Port.

3. Route the cable through the "L" Shaped Cable Guide, and push the cable down through the Cable Retention Tabs to hold in place.
4. Slide the stylus into the Holder on the side of the NCR 5992 unit.  
**Note:** The NCR 5992 host cable should be connected after the stylus. The host cable is thicker and will keep the stylus cable in place.

### Disconnecting the NCR 5992 Stylus

1. Place the NCR 5992 in front of you with the bottom of the unit facing up.  
**Note:** Be careful not to place the unit on a surface where the graphical display screen can be scratched or damaged.
2. Gently pull the cable up from the "L" Shaped Cable Guide Retention Tabs.
3. Press down on the top tab of the NCR 5992 Stylus Connector and gently pull the connector out of the NCR 5992 Stylus Port.

### Connecting the NCR 5992 Host Cable

1. Place the NCR 5992 in front of you with the bottom of the unit facing up.  
**Note:** Be careful not to place the unit on a surface where the graphical display screen can be scratched or damaged.
2. Hold the NCR 5992 host cable connector behind the cover, with the flat side of the connector facing up.
3. Insert the connector into the *NCR 5992 Host Port*.
4. With your thumb, push the connector into the NCR 5992 port as far as it will go, locking the cable in the port. All of the *Connector Pins Metal Shield* should be inside the port when it has been inserted far enough.  
**Note:** You should be able to pull gently on the cable without disconnecting it from the NCR 5992.

5. Route the cable through the *"L" Shaped Cable Guide*, and push the cable down through the *Cable Retention Tabs* to hold in place.

**Note:** The NCR 5992 host cable should be connected after the stylus. The host cable is thicker and will keep the stylus cable in place.

### Disconnecting the NCR 5992 Host Cable

1. Place the NCR 5992 in front of you with the bottom of the unit facing up.

**Note:** Be careful not to place the unit on a surface where the graphical display screen can be scratched or damaged.

2. Gently pull the cable up from the "L" Shaped Cable Guide Retention Tabs.
3. Hold the connector behind the cover, and gently pull the connector out of the NCR 5992 Host Port.

## Connecting the NCR 5992 to the NCR 7452/3 Workstation

Migrating to the new 5992 Electronic Payment Terminal requires minimal effort. The following illustrations show the steps needed to connect the 5992 to an NCR 7452/3 workstation. Connector locations of the workstation terminals may vary slightly from model to model.

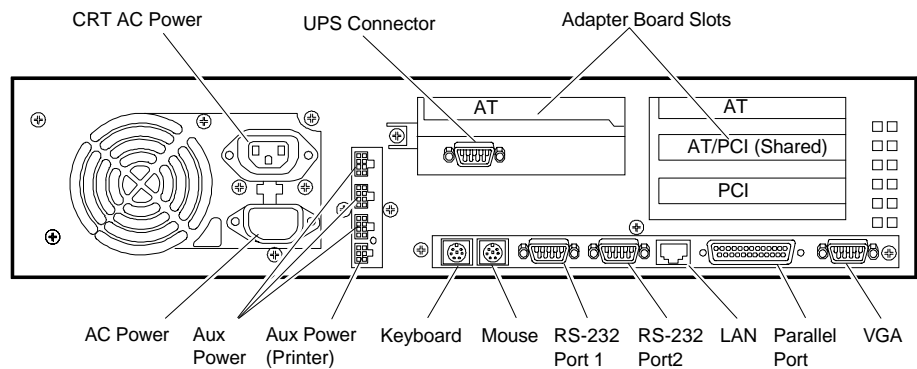

13258

## Cable Configurations

The NCR 5992 Electronic Payment Terminal may be installed with the following cable configurations or minor variations of the following. See your NCR representative for help with your particular configuration:



### Configuration 1

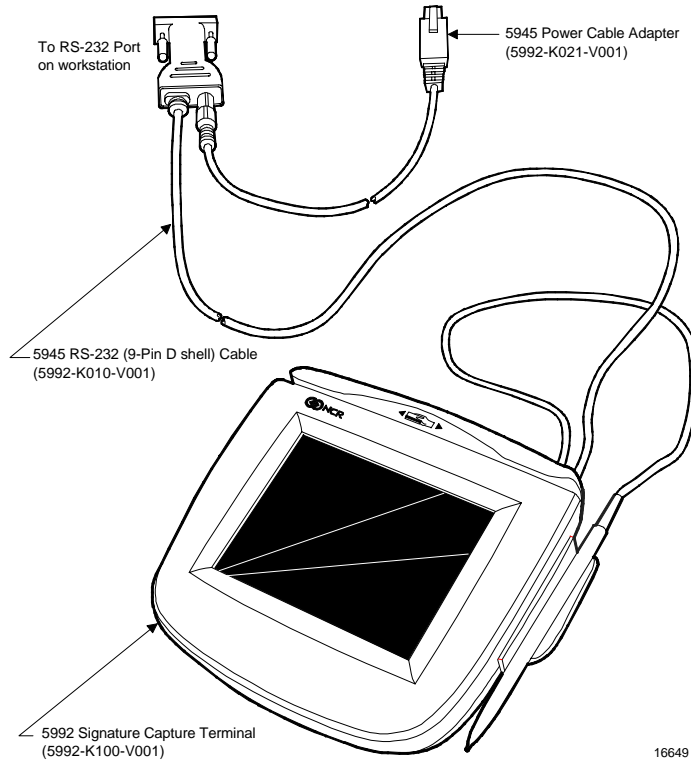

Configuration 1: 5992 connected to 7452/3 using 7452 Aux. Power.	
5992-K100-V001	5992 Signature Capture Secure w/ Track 1, 2 MSR
5945-K010-V001	Cable: RS-232 (9-Pin D Shell)
5945-K021-V001	Cable: 7452/3 Power Adapter

## Configuration 2

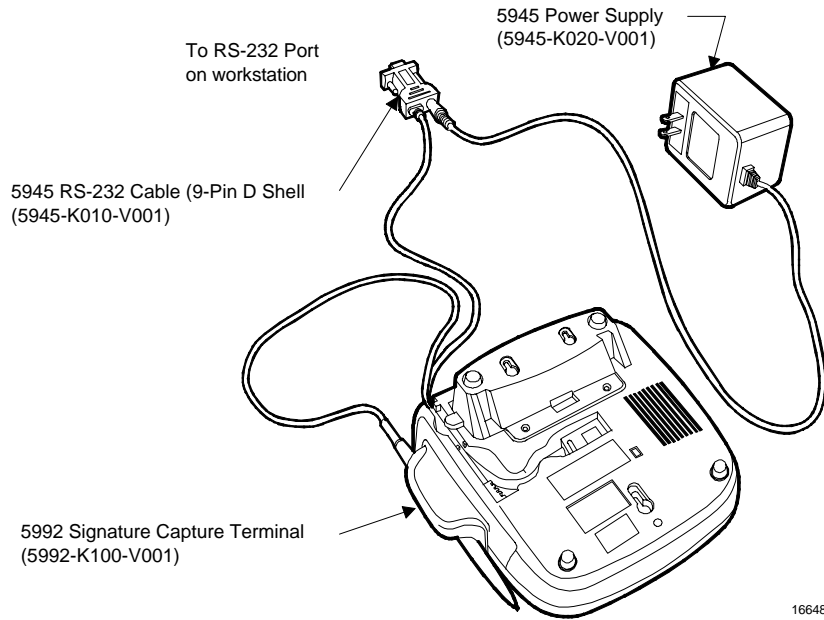

Configuration 2: 5992 connected to 7452/3 using 120 VAC power.	
5992-K100-V001	5992 Signature Capture Secure w/ Track 1, 2 MSR
5945-K010-V001	Cable: RS-232 (9-Pin D Shell)
5945-K020-V001	Power Supply: (120V, 60Hz US/Canada/Other)

### Configuration 3

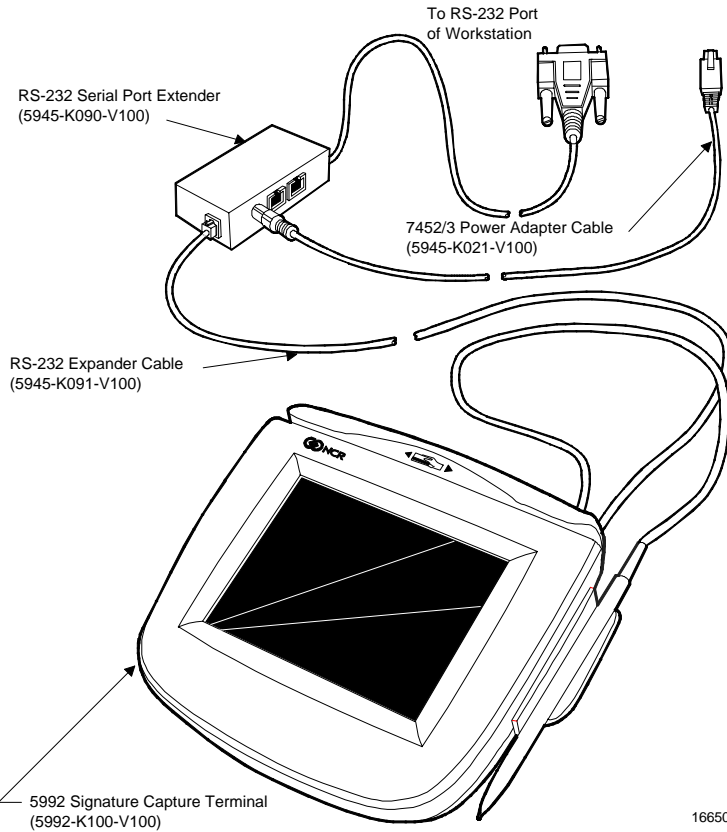

Configuration 3: 5992 connected to 7452/3 using port expander and Aux Power cable.	
5992-K100-V001	5992 Signature Capture Secure w/ Track 1, 2 MSR
5945-K021-V001	Cable: 7452/3 Power Adapter
5945-K090-V001	RS-232 Serial Port Expander (2 port)
5945-K091-V001	RS-232 Expander Cable

## Connecting the NCR 5992 to a PC

The following illustration shows the steps needed to connect the NCR 5992 to a PC.

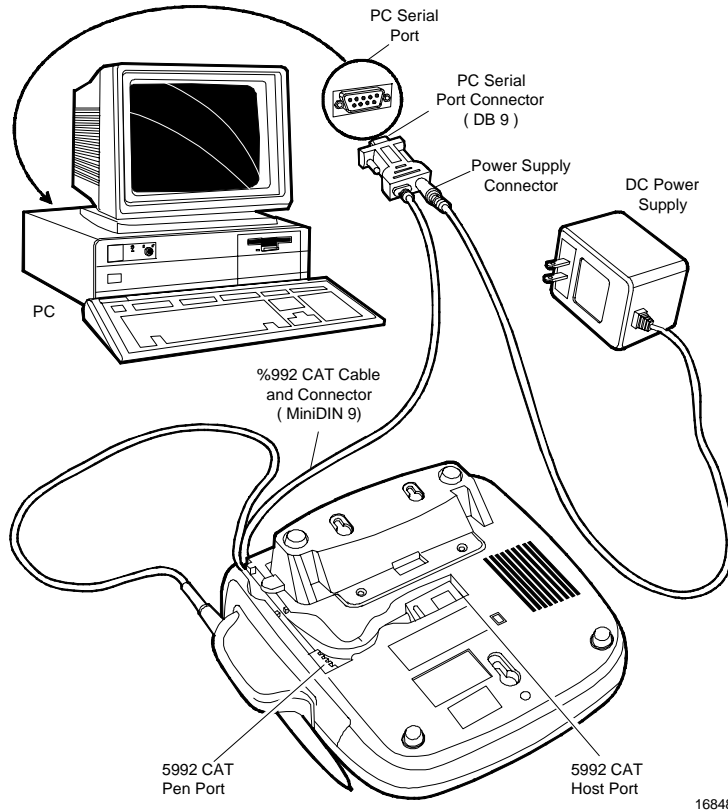

16848

1. Turn Off Power to your PC.
2. Connect the NCR 5992 Cable and Stylus as previously described in the *Connecting and Disconnecting the NCR 5992 Cable and Stylus* section.

3. Plug the *NCR 5992 PC Serial Port Connector* (DB9) into a serial port on the back of your PC.
4. Plug the *DC Power Supply* into a standard wall outlet.

**Warning: Use only the DC Power Supply shipped with your unit. Using any other power supply may damage the NCR 5992 and will void the warranty.**

5. Plug the Power Supply Connector into the Power Supply Jack on the cable.
6. Once the NCR 5992 has power and the PC is signed on, it is ready for use as determined by your application software.



# Chapter 4 Operational Modes

---

## Introduction

The NCR 5992 has two primary operational modes: Normal and Supervisor/Diagnostic. The 5992 also has a Maintenance mode that permits you to modify its operations. In Normal mode, the 5992 performs signature capture and other functions for which it is designed.

Supervisor mode allows authorized personnel to execute downloads in field installed 5992's. The supervisor mode functions are menu driven with features that allow a logical progression through the individual processes.

The supervisor mode functions are:

- Modifying parameters.
- Downloading a program and parameters from a PC.
- Obtaining version information on the 5992.
- Re-initializing the 5992.

The diagnostic mode allows authorized personal to isolate failures in field installed 5992's. The diagnostics are part of the operating system and are not changed by applications. The diagnostics are menu driven with features that allow a logical progression through the individual tests.

## Normal Mode

In normal mode, the 5992 is controlled by the application program running in the host. Depending upon the application, any of the following screens may be available:

- Survey
- Promotional message
- Customer display
- Receipt of charge display
- Form display
- Signature capture

The following illustrations show a typical relationship of 5992 functions to various phases of a typical application program. In this example, the only operator actions required are the normal keystrokes on the host workstation keyboard to initiate and terminate transaction activities. The application has assigned the keyboard keys used to accept or abort a signature. The only customer action required is to use the stylus to sign the charge receipt display, form entry, or to respond to surveys.



# Supervisor Mode

## Startup Sequence

To access the 5992 supervisor mode:

1. The unit must be powered down.
2. Power up the unit and immediately place the stylus in the center of the 5992 display screen. Hold the stylus in this position during the power up as shown in the illustration below.
3. The *Supervisor Menu* / *Diagnostics Menu* selection screen will display.

**Note:** If Supervisor Menu or Diagnostics Menu is not selected within 10 seconds, the unit exits this screen and starts the 5992 application.

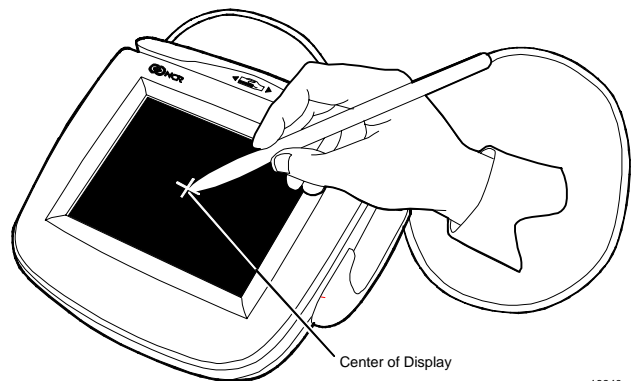

4. Select *Supervisor Menu* with the stylus or your finger.

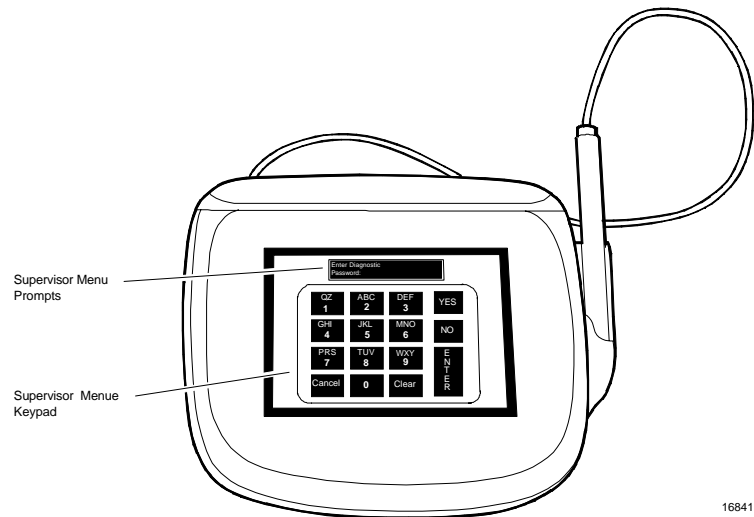

16841

5. An "Enter Password" prompt displays. Type in the password "**263**" ("CME"), and press **Enter**. The first Supervisor Menu item (CMDL) displays.

If an incorrect password is entered, a "Password Invalid" message displays. Press any key to end the session and start the 5992 application. Then access the Supervisor Menu again.

**Note:** For diagnostics mode information, refer to Chapter 5, "5992 Diagnostics Specification" in this User Manual.

# Operation

## Navigating through the Menu Items

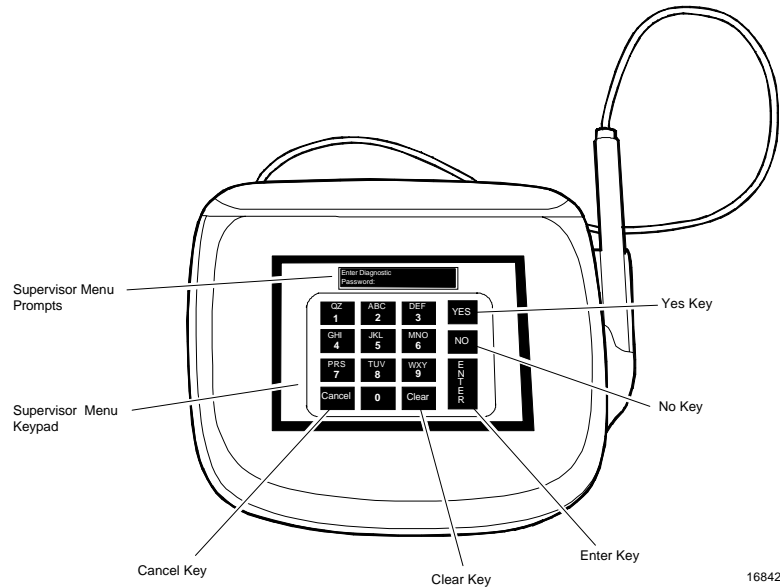

16842

### *NCR 5992 Supervisor Menu Key Features*

KEY	DESCRIPTION
Yes	Used to scroll to the previous item in the menu list.
No	Used to scroll to the next item in the menu list.
Enter	Used to initiate the currently displayed menu item.
Cancel	Ends an executing task and returns the Supervisor Menu, or if pressed from a menu, ends the task and returns the <i>Supervisor Menu Start Application</i> menu item.
Clear	Used to end an executing task and return to the Supervisor Menu.

## Menu Flow

The 5992 Supervisor Menu allows 9 individual functions to be performed. These options display in the following sequence:

1. **CMDL.** Used to download a program or parameters from a PC.
2. **FILE SYSTEM.** Used to view and modify file system read, write, delete, compress, space reporting, and initialize space parameters.
3. **APP CONFIG.** Used to change the size of the application configuration space.
4. **ID BANNER.** Displays the current version level of the 5992 firmware.
5. **CHANGE PASSWORD.** Changes the supervisor mode password.
6. **SERIAL NUMBER.** Displays the serial number of the 5992 unit.
7. **HARDWARE CONFIG.** Used to change the size of the hardware configuration space. This function is currently not available.
8. **POWER DOWN.** Powers down the 5992 unit.
9. **START APP.** Starts the 5992 application.

## Supervisor Menu Items

### CMDL

CMDL is the first menu item that appears when the Supervisor Menu displays.

CMDL is used for downloading a program or parameters from a PC, using the cable provided with the IBM EFT Application Developer's Kit.

For detailed information on downloading a program or parameters, refer to Chapter 2, "*Download Program Software*", in the *5992 Developer's Guide*.

**Note:** Press the **Cancel** key to abort the download and return to the Supervisor Menu.

## File System

The File System options allow for modifying parameters and file system maintenance functions. The File Sys Menu contains the following menu items: *Read*, *Write*, *Delete*, *Compress*, *Space Report*, and *Init Space*. Select the *File Sys* menu item from the Supervisor Menu.

```
File Sys Menu
Read
```

**Note:** A listing of the standard parameter set is located in your *5992 Developer's Guide*. Each parameter contains the corresponding application number, file number, record number, and class.

### *Read*

The read item allows for viewing a parameter.

1. Select the *Read* item on the File Sys Menu. Enter the following information (as prompted) to read a parameter item.

```
Enter App #
—
```

2. The first prompt requests the application number. All parameters for the 5992 application use application number “1”. Type in “1”, and press **Enter**. The next prompt displays:

```
Enter File#
—
```

3. This prompt requests the file number. The file number refers to the individual parameter. Type the file number, and press **Enter**. The next prompt displays:

**Note:** Refer to your *5992 Developer's Guide* for the corresponding file number.

Enter Record #

—

4. This prompt requests the record number. The record number is used to refer to an individual parameter in a group of parameters. Type the record number, and press **Enter**. The next prompt displays:

**Note:** Refer to your *5992 Developer's Guide* for the corresponding record number.

Enter Class #

—

5. This prompt requests the class number. The parameter class is either “public” or “private”. Type one of the following class numbers, and press **Enter**.
  - “0” for private class. Private parameters are only used by the specified application.
  - “1” for public class. Public parameters can be used by all of the applications loaded on the 5992 unit. Parameters such as the terminal serial number, and the program and parameter version levels are considered public parameters.

**Note:** Refer to your *5992 Developer's Guide* for the appropriate class.

6. If a valid record is entered, the information displays. If the record was not found, an error message displays. Press any key to return to the File Sys Menu. Then press the **Cancel** key to return to the Supervisor Menu.

### **Write**

The write item allows for modifications or entries to a parameter.

1. Select the Write item on the File Sys Menu. Enter the following information (as prompted) to modify or write a parameter item.

Enter App #

—

2. The first prompt requests the application number. All parameters for the 5992 application use application number “1”. Type in “1”, and press **Enter**. The next prompt displays:

Enter File#

—

3. This prompt requests the file number. The file number refers to the individual parameter. Type the file number, and press **Enter**. The next prompt displays:

**Note:** Refer to your *5992 Developer's Guide* for the corresponding file number.

Enter Record #

—

4. This prompt requests the record number. The record number is used to refer to an individual parameter in a group of parameters. Type the record number, and press **Enter**. The next prompt displays:

**Note:** Refer to your *5992 Developer's Guide* for the corresponding record number.

Enter Class #

—

5. This prompt requests the class number. The parameter class is either “public” or “private”. Type one of the following class numbers, and press **Enter**.
  - “0” for private class. Private parameters are only used by the specified application.
  - “1” for public class. Public parameters can be used by all of the applications loaded on the 5992 unit. Parameters such as the terminal serial number, and the program and parameter version levels are considered public parameters.

**Note:** Refer to your *5992 Developer's Guide* for the corresponding class.

Enter Data:

—

6. This prompt requests the data that should be contained at the selected location. For example, if this location was intended to contain the baud rate, enter the baud (e.g., 9600), and press **Enter**. Then, when setting the baud variable in the application, this location would need to be referenced.

**Note:** The **Clear** key is used to back up one space in case of error.

File Written.

Press a Key...

7. The parameter file is written. Press any key to return to the File Sys Menu. Then press the **Cancel** key to return to the Supervisor Menu.

### *Delete*

The delete item allows for deleting a parameter. Using the 5992 keypad, you can delete a parameter.

**Warning:** **Deleting a parameter that the application requires will cause the application to stop working.**

1. Select the *Delete* item on the File Sys Menu. Enter the following information (as prompted) to delete a parameter item.

Enter App #

—

2. The first prompt requests the application number. All parameters for the 5992 application use application number “1”. Type in “1”, and press **Enter**. The next prompt displays:

Enter File#

—

3. This prompt requests the file number. The file number refers to the individual parameter. Type the file number, and press **Enter**. The next prompt displays:

**Note:** Refer to your *5992 Developer’s Guide* for the corresponding file number.



Enter Record #

—

4. This prompt requests the record number. The record number is used to refer to an individual parameter in a group of parameters. Type the record number, and press **Enter**. The next prompt displays:

**Note:** Refer to your *5992 Developer's Guide* for the corresponding record number.

Enter Class #

—

5. This prompt requests the class number. The parameter class is either “public” or “private”. Type one of the following class numbers, and press **Enter**.
  - “0” for private class. Private parameters are only used by the specified application.
  - “1” for public class. Public parameters can be used by all of the applications loaded on the 5992 unit. Parameters such as the terminal serial number, and the program and parameter version levels are considered public parameters.

**Note:** Refer to your *5992 Developer's Guide* for the corresponding class.

6. If a valid record is entered, the “Parameter Deleted, Press a key” prompt displays. Press any key to return to the File Sys Menu. Then press the **Cancel** key to return to the Supervisor Menu.

### *Compress*

The compress item purges deleted records giving you additional configuration space.

1. Select the *Compress* item on the File Sys Menu. Enter the following information (as prompted) to compress.

Enter Class #

—

2. This prompt requests the class number. The parameter class is either “public” or “private”. Type one of the following class numbers, and press **Enter**.
  - “0” for private class. Private parameters are only used by the specified application.
  - “1” for public class. Public parameters can be used by all of the applications loaded on the 5992 unit. Parameters such as the terminal serial number, and the program and parameter version levels are considered public parameters.
3. The compress is executed. When completed, the “Compress OK, Press a key” prompt displays. Press any key to return to the File Sys Menu. Then press the **Cancel** key to return to the Supervisor Menu.

### *Space Report*

The space report item displays information on configuration space.

1. Select the *Space Report* item on the File Sys Menu. The following is an example of the information that displays.

Enter Class #

—

2. This prompt requests the class number. The parameter class is either “public” or “private”. Type one of the following class numbers, and press **Enter**.
  - “0” for private class. Private parameters are only used by the specified application.
  - “1” for public class. Public parameters can be used by all of the applications loaded on the 5992 unit. Parameters such as the terminal serial number, and the program and parameter version levels are considered public parameters.

L: 4E200 F:9764  
 Press a Key. . .

3. Two separate items display:
  - L: Displays the length of the storage space.
  - F: Displays the number of free bytes available.
4. Press any key to return to the File Sys Menu. Then press the **Cancel** key to return to the Supervisor Menu.

### *Init Space*

The initialize space item is used to clear the configuration space or change the size of the configuration space.

**Warning:** Using this command will remove any program or parameters currently loaded on the 5992.

**Note:** Refer to Chapter 2, “*Programming Considerations*,” in your *NCR 5992 Developer’s Guide* for detailed information on the systems file space.

To change the size of the configuration space, press **Enter**.

1. Select the *Init Space* item from the File Sys Menu. The Init Space Menu displays.

```
Init Space Menu
Config Space
```

2. Press **Enter** to select the *Config Space* item.

```
Enter Cfg Size
—
```

3. This parameter is used to specify the size of the configuration space. This parameter is set to zero when the unit is new. For the IBM EFT application, this value should be set to approximately 260KBytes. Type the configuration size, and press **Enter**.

```
Enter Cfg Size  
Complete
```

4. This message displays when the space configuration is completed. Press any key to return to the File Sys Menu. Then press the **Cancel** key to return to the Supervisor Menu.

### ***Application Configuration***

The application configuration options allow for reconfiguring space for a specific application. The App Config Menu contains the *space report* and *init space* functions. Select the *App Config* menu item from the Supervisor Menu.

```
App Config Menu  
Space Report
```

### ***Space Report***

The space report item displays information on the application configuration space.

1. Select the *Space Report* item on the App Config Menu. The following is an example of the information that displays.

```
L: EA60   S: D7F8  
Press a Key. . .
```

2. Two items display:
  - L: Displays the length of the storage space.
  - S: Displays the address where storage space is located in physical memory.
3. Press any key to return to the App Config Menu. Then press the **Cancel** key to return to the Supervisor Menu.

### ***Init Space***

The initialize space item is used to clear the configuration space or change the size of the configuration space of the specified application.

**Warning:** Using this command will remove any program or parameters currently loaded on the 5992.

**Note:** Refer to Chapter 2, “*Programming Considerations*” in your *NCR 5992 Developer’s Guide* for detailed information on the systems file space.

App Config Menu  
Init Space

1. Select the Init Space item from the App Config Menu.

Enter Apps Size  
—

2. This parameter is used to specify the size of the configuration space. This parameter is set to 128KBytes when the unit is new. For the IBM EFT application, this value should not have to change. Type the application configuration size, and press **Enter**.

Enter Apps Size  
Complete

3. This message displays when the space configuration is completed. Press any key to return to the App Config Menu. Then press the **Cancel** key to return to the Supervisor Menu.

## ID Banner

The ID banner option displays the current version level of the 5992 firmware. Select the *ID Banner* item on the Supervisor Menu and press **Enter**. The version information displays. Press any key to return to the Supervisor Menu.

## Change Password

The change password option allows the password to access Supervisor Mode to be changed. Select the *Change Password* item on the Supervisor Menu and press **Enter**.

**Note:** Changing the Supervisor Mode password does not affect the Diagnostics Mode password.

Supervisor Menu  
Change Password

1. Select *Change Password* from the Supervisor Menu, by pressing **Enter**.

Enter New Password  
—

2. Type in the new password, and press **Enter**.

**Note:** The default password is “263” (CME). The new password may not be larger than 32K.

Verify New Password  
—

3. Type in the new password again (to confirm), and press **Enter**. If the same password is entered, the new password will be written to memory and the following message displays.

**Note:** If the verify password entered is not the same, a “Denied PW Chg” message displays. Press **Enter** to return to the Supervisor Menu.

Changed PW  
Press Enter

4. This message displays when the new password has been written into memory. Press the **Enter** key to return to the Supervisor Menu.

### Serial Number

The serial number option displays the serial number of the 5992 unit. Select the *Serial Number* item on the Supervisor Menu and press **Enter**. The serial number of the unit displays. Press any key to return to the Supervisor Menu.

### Hardware Configuration

The hardware configuration option is used to change the size of the hardware configuration space. This option is currently not available.

### **Power Down**

The power down option is used to power down the 5992 unit. Select the *Power Down* item on the Supervisor Menu and press **Enter**. The 5992 will power down and be in an offline state.

### **Start Application**

The start application option is used to start the 5992 application. Select the *Start App* item on the Supervisor Menu and press **Enter**. The application program will initialize and start. If an application program is not loaded for the unit, an “Invalid App 1” message displays.

## Maintenance Mode

When power is applied to the 5992, it begins Power-up diagnostics. If the status of all tests is “Passed,” a tone sounds. To enter Maintenance Mode, immediately touch the stylus to the NCR logo at the upper right corner of the screen.

**Note:** If you wait too long, the 5992 will enter normal mode and you will have to power off and start over.

The Maintenance Mode displays permit you to select options that modify the operation of the 5992. Instructions are displayed, and options are selected with the touch of the stylus.

The main menu displays the firmware and software identification numbers plus the following choices:

- SETUP procedures to establish operating parameters
- DIAGNOSTICS to verify operation
- RUN to terminate Maintenance Mode and initiate Normal Mode of operation
- LOAD APPLICATION to make the 5992 ready to receive a download of the operating system

The RUN option of the main menu terminates Maintenance Mode and initiates Normal Mode operation.

## Performing a Setup

Enter SETUP from the Maintenance Mode menu by touching the stylus to the SETUP selection. SETUP lets you do any of the following:

- Calibrate the digitizer
- Adjust the screen contrast
- Set the EIA-485 link address
- Set the EIA-232 mode (manual or automatic)
- Doodle (tests the stylus and digitizer)



## Digitizer Calibration

Calibration of the digitizer is done at the factory and should never require readjustment. If you experience a digitizer tracking problem, contact an NCR service representative prior to attempting any adjustments.

## Screen Contrast Adjustment

When you enter this mode, the screen displays a light and dark checkerboard pattern. To lighten the screen, drag the stylus from the left to the right. To darken the screen, drag the stylus from the right to the left.

**Note:** It is possible to adjust the screen contrast so that the menu options are not visible. It is then very difficult to select the option to adjust it properly. If this occurs, momentarily unplug the power module from the electrical power outlet and then reconnect it to initiate the self-test diagnostics. Then, hold the stylus tip on the screen for four seconds to establish a default contrast value.

## EIA-485 Link Address

If your 5992 utilizes an EIA-485 interface with an IBM-468x host, you must set the link address at installation. If your 5992 utilizes an EIA-485 2-wire multidrop link interface, you must set the link at installation.

## EIA-232

If not manually set, the RS-232 communication baud rate will automatically be set via the first communications message following the unit power cycle. The highest rate that can be detected in autobaud mode is 19.2Kbps. If 38.4Kbps is required, it must be set by selecting the 38.4Kbps option from the menu.

## Performing Diagnostics

The 5992 runs ROM-based Power-up diagnostics automatically, and user-selectable diagnostics (also ROM-based) on demand.

Extended diagnostics and diagnostics logs and tallies may be run from the host.

User-selectable diagnostics permit the user to:

- Display video screens
- Test the Backlight
- Test ping-pong communications
- Read or clear the 5992 tallies
- Test MSR

To perform user-selectable diagnostics:

1. Touch the NCR logo with the stylus immediately after Power-up diagnostics complete.
2. Touch the stylus to DIAGNOSTICS on the Maintenance Mode menu, and follow the prompts.

### What are tallies?

Tallies record the number of sends, receives, power cycles, reads, failures, etc., related to the 5992's internal operations, communications, MSR, and operating system.

### What is the ping-pong test?

The ping-pong test must be initiated from the host. It verifies the operation of the communications interface, the interface cable, and the 5992, by returning all messages received from the host.

## Loading the Operating System

The load option is entered from the Maintenance Mode menu by touching the stylus to the LOAD OPERATING SYSTEM selection. The load option establishes conditions that permit the 5992 to receive an operating system download from the host. An operating system load should only be required to install a new operating system version supplied by NCR.

It is not necessary to enter Maintenance Mode to download the operating system. This can be done at any time in Normal Mode from the host. The download also can be initiated at the end of Power-up diagnostics, if a test fails.

After reloading the operating system, an application load is required. This also must be initiated from the host. If the application is not loaded, the 5992 displays “APPLICATION NOT PRESENT, LOAD APPLICATION.”

The 5992 Utility Diskette contains the Operating System. To load the Operating System, you need a 386 or higher processor with a 3.5” disk drive. You also can use the host terminal if it has a 3.5” disk drive. Perform the following steps.

1. With the PC on, go to the DOS prompt (C : \).
2. Type `cd a :` and press Enter to change to the 3.5” disk drive.
3. Type `dir` and press Enter to display the disk directory.
4. Identify the most current Operating System and Application files – OS\*.out and APP\*.out.
5. Run the Utility program by typing `5992_ut.exe` and pressing Enter.

**Note:** The 5992\_ut.exe utility is the same utility used for the 5991 as only the filename was changed. All menu text still refers to the 5991 only, but applies to the 5992 as well.

6. Select the communication type and port as prompted.

7. Select the Baud Rate from the menu (The 5992 can be manually set to 38.4Kbps, however the diagnostics and utilities supports up to 19.2Kbps).
8. The Utilities Menu is now displayed.

- Select 09 – Reset unit

Response: 00 05 00 ef ea

Press Enter to send the reset command again (The response code of ef means this is the first command since power up)

**OR**

Response: 00 05 09 00 0c

This is the correct response, ef changes to 00

- Select D2 – Load Operating System

Type filename (OS\*.out)

Type 0 to stream data (fastest)

**Note:** The download will take several minutes. The date being transferred will be displayed on the PC (or host terminal) and a counter on the 5992 will indicate how many blocks of data have been downloaded. Typically, this is at least 700 blocks. Once the OS download is complete, the 5992 will reset. At this point the 5992 will not be operational until an application is downloaded. After reset, the 5992 will display `NCR EFT, Wait for Online`. This indicates the 5992 is waiting for an application download.

9. Press Q to return to main menu.
10. Select D2 – Load Applications.
11. Enter filename. (APP\*.out)
12. Enter 0 to stream data (fastest).
13. Press Q to return to main menu.
14. Press 00 to exit the 5992 Utility.
15. If the Operating System Program Memory passes initial diagnostics, the unit goes into the normal run mode.

End of Procedure.

---

# Chapter 5 Troubleshooting

---

## Introduction

In the event your NCR 5992 is not working properly, you should first consult the following troubleshooting tables. Find the problem you are experiencing in the *Problem* column, perform (in sequence) each of the actions in the *Solution* column.

**Note:** If all solutions have been tried and you are still experiencing problems, contact *NCR Help Desk* to make arrangements for the unit to be shipped back for repair.

## Simple Troubleshooting Guide

PROBLEM	SOLUTION
The Card Reader does not seem to work properly.	<p>Make sure that the magnetic stripe on the card is facing the NCR 5992 graphical display screen when sliding the card through the reader.</p> <p>Swipe the card at a faster or slower <i>steady</i> speed.</p> <p>Swipe the card in the reverse direction (i.e., if swiping the card from right to left, try swiping from left to right).</p> <p>Inspect the magnetic stripe on the card, making sure it is not scratched or badly worn.</p> <p>If you have another working NCR 5992 unit, try reading the card on that unit to determine if the problem is with the unit or with the card.</p>
The NCR 5992 is not working.	<p>Make sure the NCR 5992 Connector (MiniDIN 9) is fully inserted into the back of the unit.</p> <p>Unplug the unit and plug it back in.</p> <p>If you have another working NCR 5992 unit, swap the units to determine if the problem is with the unit, cable, register, or power supply.</p>

---

## Detailed Problem Troubleshooting

For diagnostics instructions, refer to Chapter 6 of this guide.

Indication	Possible Cause	Action
Display is dark (backlight is off).	Automatic display blanking activated	Send Host Command.
	No power	Check power connections.
	Power supply/ adapter failure	Try a new power supply.
	5992 awaiting host commands	Send host command.
	Improper cable connections	Check all cable connections.
	Interface cable failure	Replace or repair the damaged cables.
	5992 failure	Replace the 5992. Contact the NCR Support Center.
Display is dark but readable.	Power supply/ adapter failure	Try a new power supply.
	5992 failure	Try another 5992. Contact the NCR Support Center.
Display is faint.	Screen contrast is set improperly	Set screen contrast.
	5992 failure	Try another 5992. Contact the NCR Support Center.
Display is blank	Improper cable connections	Check all internal cable connections.

Indication		Action
	Screen contrast set improperly	Set screen contrast.
	5992 failure	Try another 5992. Contact the NCR Global Support Center.
5992 failed OS program memory test on power-up.	Improper loading by host.	<ol style="list-style-type: none"> <li>1) Reload the 5992 operating system and application.</li> <li>2) Power cycle the 5992 and make sure it resets automatically after loading.</li> <li>3) Make sure the OS program memory test passes.</li> <li>4) Load video screens</li> </ol>
	5992 failure	Try another 5992. Contact the NCR Center.
Stylus does not work.	Loose cable connections.	Check stylus cable connections.
	Bad stylus connection.	Check stylus connection.
	Improper calibration.	Calibrate the digitizer.
	Stylus not enabled.	Run diagnostics.
	Stylus failure.	Replace stylus.
	Defective 5992 unit.	Check stylus on another 5992 unit.
	Interface cable failure.	Replace or repair the cable.
	5992 failure.	Try another 5992. Contact the NCR Support Center.

Indication		Action
Display doesn't track the stylus.	Improper calibration.	Perform stylus/digitizer test.
	Stylus failure.	Replace stylus.
	5992 failure.	Try another 5992. Contact the NCR Support Center.
MSR did not read card.	Card not run through properly.	Run card through with the magnetic stripe down and facing the front of the 5992.
	Bad card.	Try another card.
	Wrong MSR configuration.	Perform MSR test in 5992 diagnostics mode.
	MSR not enabled.	Send "Activate MSR" command from host
	5992 failure.	Try another 5992. Contact the NCR Support Center.
5992 does not respond to host commands.	Improper cable connections.	Check all cable connections.
	Wrong communication speed setting.	Initiate power-up diagnostics and send two messages from the host.
	Interface cable failure.	Replace or repair the cable.
	5992 failure.	Try another 5992. Contact the NCR Support Center.



---

# Chapter 6: Diagnostics Specification

---

## Introduction

This chapter describes the diagnostic test procedures for the NCR 5992, K100 and K150 Signature Capture Terminals. The purpose of the diagnostics is to isolate failures in field installed 5992's. The diagnostics are part of the operating system and are uniform across all applications. The diagnostics are menu driven with features that allow a logical progression through the individual tests.

## Startup Sequence

The diagnostics can be accessed either at power-up or from any screen.

- 1a. To start diagnostics at power-up, the unit must be powered down. Power up the unit and allow 20 to 30 seconds for the unit to 'self test'. Place the stylus in the center of the 5992 display screen. Hold the stylus in this position during the power up as shown in the illustration below. The *Supervisor Menu / Diagnostics Menu* selection screen will display.

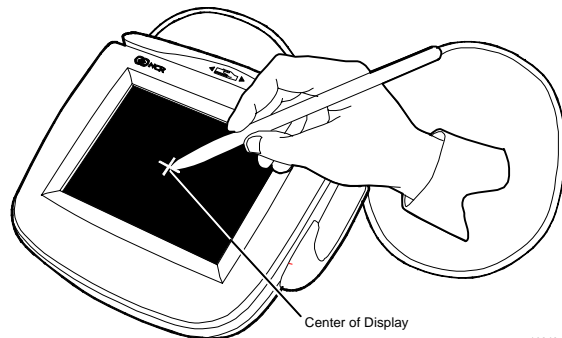

**Note:** If Supervisor Menu or Diagnostics Menu is not selected within 10 seconds after 'self test', the unit exits this screen and goes into the digitizer calibration screen.

- 1b. To start diagnostics from any screen, touch each corner of the screen in a counter clockwise motion starting with the upper left hand corner using the stylus or your finger. You must finish by pressing the same upper left hand corner of the screen where you started. There are a total of 5 screen touches. The *Supervisor Menu* | *Diagnostics Menu* selection screen will display.

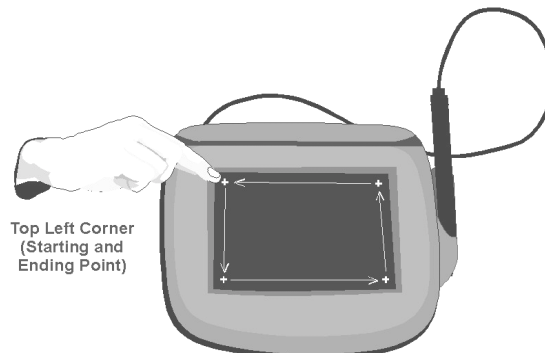

Touch the screen five times in a counter clock wise direction, in each corner starting and finishing with a touch in the upper left hand corner of the screen. The *Supervisor Menu* | *Diagnostics Menu* selection screen will display.

2. Select *Diagnostics Menu* with the 5992 stylus or your finger.

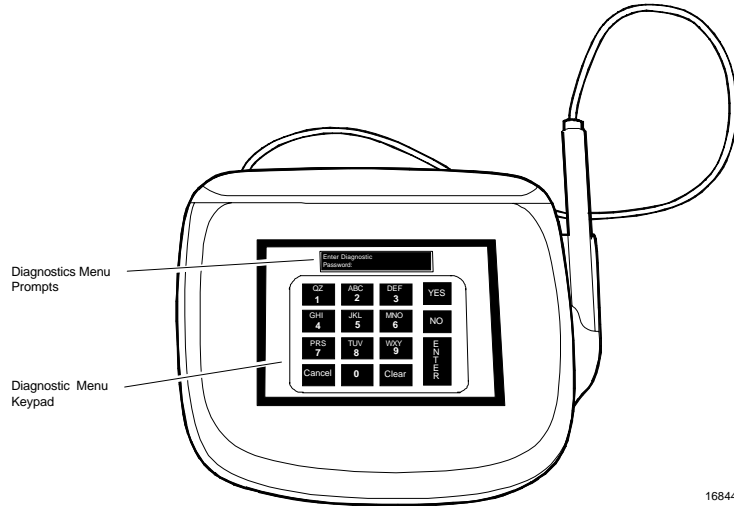

16844

- An “Enter Diagnostics Password” prompt displays. Type in the password “3424” (“DIAG”), and press **Enter**. The first diagnostics test menu item (KEYPAD) displays. If an incorrect password is entered, a “Password Invalid” message displays. Press any key to end the session and start the 5992 application. Then access diagnostics mode again.

**Note:** If the application program is not executing (e.g., the screen will either display “Waiting for Online” or will be downloading a program and/or parameters), the diagnostic screen is not accessible.

For supervisor mode information, refer to Chapter 4, “*Using the Supervisor Mode*” in this User Manual.

## Operation

### Navigating through the Menu Items

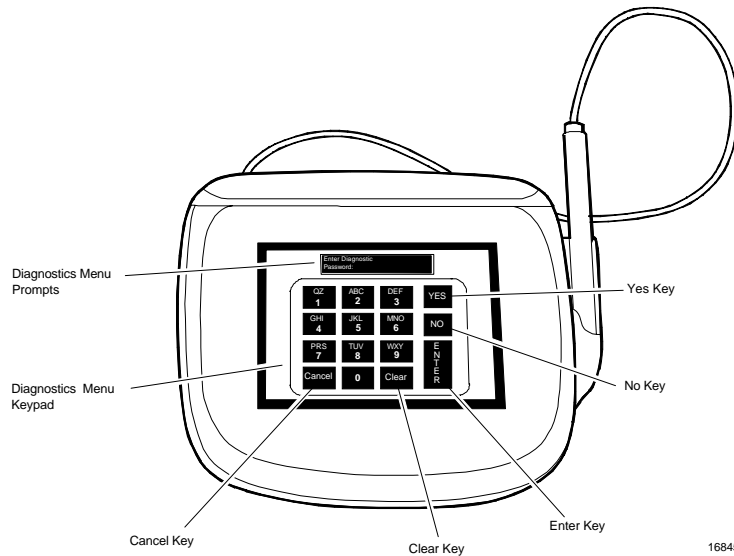

16845

### *NCR 5992 Diagnostics Menu Key Features*

KEY	DESCRIPTION
Yes	Used to scroll to the previous item in the menu list.
No	Used to scroll to the next item in the menu list.
Enter	Used to initiate the currently displayed menu item.
Cancel	Ends an executing diagnostics test and returns the diagnostics menu, or ends the diagnostics if pressed from a menu and restarts the NCR 5992 application.
Clear	Used to end an executing diagnostics test and return to the diagnostics menu.

## Menu Flow

The 5992 Diagnostics Menu allows for 16 individual tests to be performed. These tests display in the following sequence:

1. **KEYPAD TEST:** Verifies that each key on the keypad is functioning properly.
2. **DISPLAY TEST:** Tests the 5992 display screen checking that all displayable characters can display and that each pixel is functioning properly.
3. **MSR TEST:** The MSR diagnostics test the 5992 Magnetic Stripe Reader, checking that track 1, track 2, and track 3 (if installed), is reading properly.
4. **IBM 46xx TEST:** Tests the 5992 communication parameters using the RS485 IBM 4680 Feature C protocol.
5. **HOST RS232 TEST:** Sets the 5992 Baud Rate, Parity, Data Bits, and tests the host communication port.
6. **AUX1A RS232 TEST:** Sets the 5992 Baud Rate, Parity, Data Bits, and tests the AUX1A communication port.
7. **AUX1B RS232 TEST:** Sets the 5992 Baud Rate, Parity, Data Bits, and tests the AUX1B communication port.
8. **SRAM TEST:** Runs a read and write test on the RAM chip.
9. **ENCRYPTION TEST:** Tests the Security Module encryption (Master Session or DUKPT) with an internally defined account number and PIN.
10. **OS VERSION:** Displays the current software OS version number.
11. **LIBRARY VERSION:** Displays the current software library version number.
12. **SECURITY VERSION:** Displays the current software security version number.
13. **CALIBRATE:** Recalibrates the digitizer by making the digitizer's coordinates match the LCD's.

14. **STYLUS TEST:** Tests the stylus by signing on a blank screen and checking both the digitizer and the stylus.
15. **LCD CONTRAST:** Adjusts the LCD contrast (lighter or darker) on the 5992 display screen.
16. **SHOW TOUCHES:** Displays a blank screen and turns on the pixel where touched by the stylus or finger. This test is used to test the digitizer calibration.

## Keypad Test

The keypad diagnostics test that each key on the 5992 keypad is functioning properly. Select the **KEYPAD TEST** from the Diagnostics Menu:

```
DIAGNOSTICS
Keypad Test
```

Each key on the keypad must be pressed in the defined sequence and within 30 seconds. Begin test by pressing the keys starting at the top left corner of the keypad (1). Move left to right and downward until all keys have been pressed. The **Enter** key should be pressed last (after the **Clear** key).

If all key presses are detected properly, the following message displays:

```
Test Passed
Press any key . . .
```

If the exact key sequence is not pressed, or not pressed within the allotted 30 seconds, the following message displays:

```
Test Failed
Press any key . . .
```

Pressing any key on the keypad returns the Keypad Test Menu. The keypad **Yes** and **No** keys are used to navigate through the available diagnostic test menus, or press **Cancel** to exit the session and start the 5992 application.

## Display Test

The display diagnostics test the 5992 display screen checking that each pixel is functioning properly. Select the **DISPLAY TEST** from the Diagnostics Menu:

```
DISPLAY TEST
Press any key . . .
```

Press any key to continue. The pixels are tested to determine if any are not working, or are stuck on. The following sequence is used:

1. All pixels on (white screen displays)
2. Every other pixel off (lined screen displays)
3. All pixels off (blank purple screen displays)
4. Every other pixel on (lined screen displays)

If the test passed, the Diagnostics Display Test screen displays again. If the test failed, the following message displays:

```
Test Failed
Press any key . . .
```

Press any key to return to the Display Test screen. The keypad **Yes** and **No** keys are used to navigate through the available diagnostic test menus, or press **Cancel** to exit the session and start the 5992 application.

## MSR Test

The MSR diagnostics test the 5992 Magnetic Stripe Reader. A valid magnetic stripe card, preferably one with both track 1 and 2, must be available to perform this test. Most any Visa or AMEX card should work. Select the **MSR TEST** from the Diagnostics Menu.

```
MSR TEST
Swipe card...
```

Swipe a valid MSR card with the magnetic stripe facing the display screen. You can swipe in either direction. After the first card is slid, the display changes to:

```
T1= 001      T2= 001
T3= NTrk    TOT=001
```

T1 through T3 (track 1, 2 and 3) accumulates and displays the number of times a card was successfully swiped and read correctly for that track. TOT keeps a running tally of how many card swipes have been performed. If an error is detected for a track, the error code displays. The following table shows the error codes and their associated description.

ERROR CODE	DESCRIPTION
LRCE	Longitudinal Redundancy Check Error
NoES	No End Sentinel character
NoFS	No Field Separator
NoSS	No Start Sentinel character
NTrk	No Card Track Installed
ParE	Parity Error
PrsE	Parse Error
????	Unknown card type for track

The following screen shows an example of 5 good reads for track 1, a parse error on track 2 data, track 3 not installed, and a total of 5 card swipes.

```
T1= 005      T2= PrsE
T3= NTrk    TOT=005
```

The test ends when the **Cancel** key is pressed and the MSR Test screen is displayed. The keypad **Yes** and **No** keys are used to navigate through the available diagnostic test menus, or press **Cancel** to exit the session and start the 5992 application.



## IBM 46xx Test

The IBM 468x, 469x diagnostics test the 5992 communication using the RS485 IBM 4680 Feature C protocol. Select the **IBM 46xx TEST** from the Diagnostics Menu:

```
IBM 46xx TEST
2A23 <0x68>
```

The second line displays the first slot and port number option that can be tested.

The keypad **Yes** and **No** keys are used to scroll up and down through the 4 available slot and port number options. These 4 options are:

1. **2A23 <0x68>**. Selects slot 2A, port 23. This compares to the Feature C address 0x68 (104).
2. **2A25<0x64>**. Selects slot 2A, port 25. This compares to the Feature C address 0x64 (100).
3. **2B23<0x69>**. Selects slot 2B, port 23. This compares to the Feature C address 0x69 (105).
4. **2B25<0x65>**. Selects slot 2B, port 25. This compares to the Feature C address 0x65 (101).

To test the Feature C port, select the port by pressing the **Enter** key when the appropriate slot and port option displays. The following information displays:

```
Testing 2A23
Poll Count 0000
```

The first line displays the slot and port option selected.

The Poll Count on line two displays the number of Polls (divided by 40) that have been received at this port. Polling always starts from zero.

If the selected Feature C port is active on the IBM 46xx, the number of polls increment about once every second. This indicates that communications with the IBM 46xx register are being conducted.

Pressing the **Cancel** key during this test returns the IBM 46xx Test screen. The keypad **Yes** and **No** keys are used to navigate through the available diagnostic test menus, or press **Cancel** to exit the session and restart the 5992 application.

## Host RS232 Test

The host RS232 diagnostics sets the 5992 baud rate, parity, data bits, and tests the communication port. Select **HOST RS232 TEST** from the Diagnostics Menu. The following communications selection screen displays:

```
Host      19200,N,8
Test
```

The default parameters display on the first line. The keypad **Yes** and **No** keys are used to scroll up and down through the selections. The available selections are:

```
Test      Allows a port test to be performed for the parameters
selected.
Baud Rate Allows a different Baud Rate to be selected.
Parity    Allows a different Parity to be selected.
Data Bits Allows a different Data Bit to be selected.
```

The **Enter** key is used to choose the displayed selection screen for parameter entry.

### Test Selection

Select **Test** from the HOST screen.

```
Test      19200, N 8
123
```

The host port should be connected to the PC using the port-to-PC test cable that came with your 5992. Any terminal program (such as Procomm Plus® or the terminal program from Windows) can be used for this test. The RS232 parameters of this program must be set to the same RS232 parameters specified for the host port test. The port the 5992 is connected to should be selected on the PC.

**Note:** To change the communication parameters, press **Cancel** to return to the HOST screen. The keypad **Yes** and **No** keys are used to scroll through the available options. Refer to the following Baud Rate, Parity, and Data Bit selections for detailed information on changing the communication parameters. Once the parameters have been set, select **TEST** from the HOST screen and retest.

Press any key on the 5992 keypad (except the **Cancel** key). That character is transmitted over the RS232 host port and received and displayed on the PC. The character will not be displayed on the 5992.

If a key is pressed on the PC keyboard, that character is received on the 5992 and displays on the second line of the unit. If the second line becomes full, the next key pressed clears the line and displays starting at the beginning of the line.

Pressing the **Cancel** key during this test returns the HOST screen. Pressing **Cancel** again returns the Diagnostics Host RS232 Test screen.

### Baud Rate Selection

Select **Baud Rate** from the HOST screen. The display changes to:

```
Baud Rate  
19200
```

The default baud rate of “19200” displays. The keypad **Yes** and **No** keys are used to scroll through the available options. The available baud rate options are:

- 19200
- 9600
- 4800
- 2400
- 1200

When the desired rate displays, press the **Enter** key to accept that parameter.

**Note:** The device can support speeds up to 38.4Kbps. However, the software provided by NCR supports up to 19.2Kbps.

Pressing the **Cancel** key during this test returns the Host screen. Pressing **Cancel** again returns the Host RS232 Test screen.

### Parity Selection

Select **Parity** from the HOST screen.

```
Parity
None
```

The default parity of “None” displays. The keypad **Yes** and **No** keys are used to scroll through the available options. The available parity options are:

- None
- Even
- Odd

When the desired option displays, press the **Enter** key to accept that parameter.

Pressing the **Cancel** key during this test returns the HOST screen. Pressing **Cancel** again returns the Host RS232 Test screen.

### Data Bit Selection

Select **Data Bits** from the HOST screen.

```
Data Bits
8
```

The default baud rate of “8” displays. The keypad **Yes** and **No** keys are used to scroll through the available options. The available data bit options are:

- 7
- 8
- 9

When the desired option displays, press the **Enter** key to accept that parameter.

Pressing the **Cancel** key during this test returns the HOST screen. Pressing **Cancel** again returns the Host RS232 Test screen.

## AUX1A RS232 Test

The AUX1A RS232 diagnostics sets the 5992 baud rate, parity, data bits, and tests the communication port. Select **AUX1A RS232 TEST** from the DIAGNOSTICS menu. The following communications selection screen displays:

```
AUX1A      19200,N,8
Test
```

The default parameters display on the first line. The keypad **Yes** and **No** keys are used to scroll up and down through the selections. The available selections are:

```
Test       Allows a port test to be performed for the parameters
           selected.
Baud Rate  Allows a different Baud Rate to be selected.
Parity     Allows a different Parity to be selected.
Data Bits  Allows a different Data Bit to be selected.
```

The **Enter** key is used to choose the displayed selection screen for parameter entry.

### Test Selection

Select **Test** from the AUX1A screen.

```
Test      19200, N 8
```

The AUX1A port should be connected to the PC using the port-to-PC test cable that came with your 5992. Any terminal program (such as Procomm Plus® or the terminal program from Windows) can be used for this test. The RS232 communication parameters of this program must be set to the same parameters specified for the AUX1A port test. The port the 5992 is connected to should be selected on the PC.

**Note:** For AUX1A port testing, a check reader configured for the 5992 can be used. To test RS485 AUX1A, a check reader configured for an RS485 IBM 4683 register must be used. To change the communication parameters, press **Cancel** to return to the AUX1A screen. The keypad **Yes** and **No** keys are used to scroll through the available options. Refer to the following Baud Rate, Parity, and Data Bit selections for detailed information on changing the communication parameters. Once the parameters have been set, select TEST from the AUX1A screen and retest.

Press any key on the 5992 keypad (except the **Cancel** key). That character is transmitted over the AUX1A port and received and displayed on the PC. The character will not be displayed on the 5992.

If a key is pressed on the PC keyboard, that character is received on the 5992 and displays on the second line of the unit. If the second line becomes full, the next key pressed clears the line and displays starting at the beginning of the line.

Pressing the **Cancel** key during this test returns the HOST screen. Pressing **Cancel** again returns the DIAGNOSTICS HOST RS232 TEST menu.

### Baud Rate Selection

Select **Baud Rate** from the AUX1A screen. The display changes to:

Baud Rate  
19200

The default baud rate of “19200” displays. The keypad **Yes** and **No** keys are used to scroll through the available options. The available baud rate options are:

- 19200
- 9600
- 4800
- 2400
- 1200

When the desired rate displays, press the **Enter** key to accept that parameter.

Pressing the **Cancel** key during this test returns the AUX1A screen. Pressing **Cancel** again returns the DIAGNOSTICS AUX1A RS232 TEST menu.

### Parity Selection

Select **Parity** from the AUX1A screen.

```
Parity
None
```

The default parity of “None” displays. The keypad **Yes** and **No** keys are used to scroll through the available options. The available parity options are:

- None
- Even
- Odd

When the desired option displays, press the **Enter** key to accept that parameter.

Pressing the **Cancel** key during this test returns the AUX1A screen. Pressing **Cancel** again returns the DIAGNOSTICS AUX1A RS232 TEST menu.

### Data Bit Selection

Select **Data Bits** from the AUX1A screen.

```
Data Bits
8
```

The default baud rate of “8” displays. The keypad **Yes** and **No** keys are used to scroll through the available options. The available data bit options are:

- 7
- 8
- 9

When the desired option displays, press the **Enter** key to accept that parameter.

Pressing the **Cancel** key during this test returns the AUX1A screen. Pressing **Cancel** again returns the DIAGNOSTICS AUX1A RS232 TEST menu.

## AUX1B RS232 Test

The AUX1B RS232 diagnostics sets the 5992 baud rate, parity, data bits, and tests the communication port. Select **AUX1B RS232 TEST** from the DIAGNOSTICS menu. The following communications selection screen displays:

```
AUX1B    19200,N,8
Test
```

The default parameters display on the first line. The keypad **Yes** and **No** keys are used to scroll up and down through the selections. The available selections are:

```
Test      Allows a port test to be performed for the parameters
          selected.
Baud Rate Allows a different Baud Rate to be selected.
Parity    Allows a different Parity to be selected.
Data Bits Allows a different Data Bit to be selected.
```

The **Enter** key is used to choose the displayed selection screen for parameter entry.



## Test Selection

Select **Test** from the AUX1B screen.

```
Test      19200, N 8
```

The AUX1B port should be connected to the PC using the port-to-PC test cable that came with your 5992. Any terminal program (such as Procomm Plus® or the terminal program from Windows) can be used for this test. The RS232 communication parameters of this program must be set to the same parameters specified for the AUX1B port test. The port the 5992 is connected to should be selected on the PC.

**Note:** For AUX1B port testing, a check reader configured for the 5992 can be used. To test RS485 AUX1B, a check reader configured for an RS485 IBM 4683 register must be used.

**Note:** To change the communication parameters, press **Cancel** to return to the AUX1B screen. The keypad **Yes** and **No** keys are used to scroll through the available options. Refer to the following Baud Rate, Parity, and Data Bit selections for detailed information on changing the communication parameters. Once the parameters have been set, select **TEST** from the AUX1B screen and retest.

Press any key on the 5992 keypad (except the **Cancel** key). That character is transmitted over the AUX1B port and received and displayed on the PC. The character will not be displayed on the 5992.

If a key is pressed on the PC keyboard, that character is received on the 5992 and displays on the second line of the unit. If the second line becomes full, the next key pressed clears the line and displays starting at the beginning of the line.

Pressing the **Cancel** key during this test returns the HOST screen. Pressing **Cancel** again returns the DIAGNOSTICS HOST RS232 TEST menu.

## Baud Rate Selection

Select **Baud Rate** from the AUX1B screen. The display changes to:

```
Baud Rate  
19200
```

The default baud rate of “19200” displays. The keypad **Yes** and **No** keys are used to scroll through the available options. The available baud rate options are:

- 19200
- 9600
- 4800
- 2400
- 1200

When the desired rate displays, press the **Enter** key to accept that parameter.

Pressing the **Cancel** key during this test returns the AUX1B screen. Pressing **Cancel** again returns the DIAGNOSTICS AUX1B RS232 TEST menu.

## Parity Selection

Select **Parity** from the AUX1B screen.

```
Parity  
None
```

The default parity of “None” displays. The keypad **Yes** and **No** keys are used to scroll through the available options. The available parity options are:

- None
- Even
- Odd

When the desired option displays, press the **Enter** key to accept that parameter.

Pressing the **Cancel** key during this test returns the AUX1B screen. Pressing **Cancel** again returns the DIAGNOSTICS AUX1B RS232 TEST menu.

### Data Bit Selection

Select **Data Bits** from the AUX1B screen.

```
Data Bits  
8
```

The default baud rate of “8” displays. The keypad **Yes** and **No** keys are used to scroll through the available options. The available data bit options are:

- 7
- 8
- 9

When the desired option displays, press the **Enter** key to accept that parameter.

Pressing the **Cancel** key during this test returns the AUX1B screen. Pressing **Cancel** again returns the DIAGNOSTICS AUX1B RS232 TEST menu.

### SRAM Test

The SRAM diagnostics test the read and write capabilities on the RAM chip. Select **SRAM TEST** from the DIAGNOSTICS menu. The test is conducted and results are displayed. For example:

```
032k Passed  
Press any key . . .
```

Pressing any key exits this screen and returns the DIAGNOSTICS menu. Pressing the **Cancel** key exits the session and starts the 5992 application.

## Encryption Test

The encryption diagnostics test the security module with an internally defined account number and PIN. The test may be done in either Master Session or DUKPT mode. Select **ENCRYPTION TEST** from the **DIAGNOSTICS** menu.

```
ENCRYPTION TEST
Master / Session
```

The **Master / Session** mode displays. Press the **Yes** and **No** keys to toggle between the **Master / Session** and **DUKPT** modes. Press **Enter** to select and test the displayed mode.

If **Master / Session** is selected, the 5992 performs the encryption and displays the 16 characters generated. The numbers generated will be the same for each 5992 with the same **Master Session** keys. Press any key to return to the **DIAGNOSTICS ENCRYPTION TEST** menu.

If **DUKPT** is selected, the 5992 performs the encryption and displays the 20 characters generated. Press any key to return to the **DIAGNOSTICS ENCRYPTION TEST** menu.

**Note:** The 5992 must have had a key injected in order for this test to perform correctly.

## Security Menu

This section describes the security diagnostics menu of the NCR 5992 K150 model. This menu has three main functions:



- Confirming and verifying injected PIN Encryption Keys (Test Encrypt & Key Check Value)
- Place the unit into the key injection mode

The general hierarchy for the security menu appears in the following order:

Menu Item Name
Security
<input type="checkbox"/> US

◆ Test Encrypt
▪ DUKPT
▪ Master/Session
▪ Session Key
▪ Index Select
▪ Key Check Value
☐ Canadian
☐ Key Injection

## Security

Menu Option	Description
<div data-bbox="401 354 829 444" style="border: 1px solid black; padding: 5px;">           Diagnostics Security         </div> <p data-bbox="394 464 772 529">Pressing <b>Enter</b> will select the displayed menu option.</p> <p data-bbox="436 558 822 659"> <b>Note:</b> Press <b>Yes</b> or <b>No</b> to move forward or backward through the menu options.</p>	<p data-bbox="859 354 1272 561">The <b>Security Menu</b> allows the user to either place the unit into Key Injection Mode or confirm that the correct PIN encryption keys have been injected into the unit</p>
<div data-bbox="401 711 829 802" style="border: 1px solid black; padding: 5px;">           Security US         </div>	<p data-bbox="859 711 1293 847">Select this option to access the US hierarchy for <b>Test Encrypt</b>, <b>Key check Value</b> and <b>Index Select</b> menus</p>
<div data-bbox="401 886 829 977" style="border: 1px solid black; padding: 5px;">           Security Canadian         </div>	<p data-bbox="859 896 1222 961"> <b>Note:</b> This option is not currently implemented</p>
<div data-bbox="401 1049 829 1140" style="border: 1px solid black; padding: 5px;">           Security Key Injection         </div>	<p data-bbox="859 1049 1265 1114">Used to place the unit into <b>Key Injection</b> mode.</p>

## US

Menu Option	Description
<div data-bbox="401 326 829 415" style="border: 1px solid black; padding: 5px; margin-bottom: 10px;"> Security US </div> <p data-bbox="394 431 772 496">Pressing <b>Enter</b> will select the displayed menu option.</p> <p data-bbox="436 529 822 626"><b>Note:</b> Press <b>Yes</b> or <b>No</b> to move forward or backward through the menu options.</p>	<p data-bbox="861 326 1279 464">This option allows access to <b>Test Encrypt</b> and <b>Key Check Values</b> for confirmation of injected PIN encryption keys.</p> <p data-bbox="861 496 1293 634">The US hierarchy allows for up to ten (10) sets of Master/Session keys stored concurrently with up to four (4) DUKPT keys.</p>
<div data-bbox="401 680 829 769" style="border: 1px solid black; padding: 5px; margin-bottom: 10px;"> US Test Encrypt </div>	<p data-bbox="861 680 1279 818"><b>The Test Encrypt</b> diagnostic returns an encrypted PIN block generated with a known account number and PIN.</p>
<div data-bbox="401 859 829 948" style="border: 1px solid black; padding: 5px; margin-bottom: 10px;"> US Key Check Value </div>	<p data-bbox="861 842 1265 907">Allows confirmation of injected PIN encryption keys.</p>

## Test Encrypt

Menu Option	Description
<div data-bbox="401 1162 829 1252" style="border: 1px solid black; padding: 5px; margin-bottom: 10px;"> US Test Encrypt </div> <p data-bbox="394 1268 765 1333">Pressing <b>Enter</b> will select the displayed menu option.</p> <p data-bbox="394 1349 801 1455"><b>Note:</b> ↵ : Press Yes or No to move forward or backward through the menu options.</p>	<p data-bbox="861 1146 1279 1382">Allows cryptographic confirmation of injected PIN encryption keys; generates and displays an encrypted PIN block from a known PIN and account number as defined by VISA documentation.</p> <p data-bbox="861 1414 1272 1520"><b>Note:</b> ↵ : <b>Test Encrypt</b> will work with Master/Session keys as well.</p>



<p>Test Encrypt DUKPT</p>	<p>If <b>DUKPT</b> is selected, the NCR 5992 performs the encryption and displays 2 lines. The first line of 16 Characters represents the encrypted PIN block. The second line of 20 characters represents the KSN (Key Serial Number)</p> <p>Press any key to return to the <b>Test Encrypt</b> menu.</p>
<p>Test Encrypt Master/Session</p>	<p>If <b>Master / Session</b> is selected, the NCR 5992 performs the encryption and displays the 16 characters generated. This indicates the encrypted PIN block. The numbers generated will be the same for each NCR 5992 with the same Master/Session keys.</p> <p>Press any key to return to the <b>Test Encrypt</b> menu.</p>
<p>Test Encrypt Session Key</p>	<p>Injects a known session key into the given index (Refer to <b>Index Select</b>).</p> <p><b>Note:</b> ⌨ : This is a legacy command and should not be used with units in the field as it will over-write the injected session key.</p>
<p>Test Encrypt Index Select</p>	<p>Use to select one of the 10 (0-9) Master/Session key sets or one of the 4 (0-3) DUKPT keys.</p>

**Note:** Test encrypt works by building an ANSI PIN block with a known account number and PIN as defined in the VISA document “*Point-of-Sale Equipment Requirements*”, PIN Processing and Data Authentication, International Version 1.0, August, 1988.



For Master/Session keys report encrypted PIN block as a result of the encryption with the designated key selected by the index. For DUKPT keys, the result returned by the designated PIN block is the encrypted PIN block and the associated KSN (Key Serial Number) that goes along with the designated encryption key. This information can be used to verify that the correct key has been injected into the unit.

### Key Check Value

Menu Option	Description
<div data-bbox="396 581 829 672" style="border: 1px solid black; padding: 5px; margin-bottom: 10px;">           US            Key Check Value         </div> <p data-bbox="396 691 772 756">Pressing <b>Enter</b> will select the displayed menu option.</p> <p data-bbox="436 786 825 883"> <b>Note:</b> Press <b>Yes</b> or <b>No</b> to move forward or backward through the menu options.</p>	<p data-bbox="858 581 1293 862">Used to verify that the correct keys are injected into the appropriate index. The key check value is defined as the first six characters of the encrypted result obtained by encrypting known data (all zeros) with the designated key.</p> <p data-bbox="858 881 1293 1162"><b>Note:</b> Note: The displayed result does not reveal any information about the key that has been injected but allows the user enough information to verify with a high degree of probability that the correct key has been injected.</p> <p data-bbox="865 1206 1272 1308"> <b>Note:</b> The NCR 5992 stores all master keys as double length keys</p>
<div data-bbox="396 1328 829 1419" style="border: 1px solid black; padding: 5px;">           Key Check Value            Master 1st Part         </div>	<p data-bbox="858 1328 1279 1430">Displays the key check value for the first part of double length master key.</p>

<p>Key Check Value Master 2nd Part</p>	<p>Displays key check value for the second part of double length master key.</p>
<p>Key Check Value Master Double</p>	<p>Displays the key check value for the entire double length master key.</p>

<p>Key Check Value Session</p>	<p>Displays the key check value for the session key of a Master/Session key pair.</p>
<p>Key Check Value DUKPT</p>	<p>The key check value is defined by performing an encryption of all zeros with the original DUKPT key injected into the unit. The key check value result is then stored within the unit for future reference</p>

### Session Key

Menu Option	Description
<p>Test Encrypt Session Key</p> <p>Pressing <b>Enter</b> will select the displayed menu option.</p>	<p>⚠ Note: This is a legacy command that should not be used with units in the field; this option over-writes the session key of a Master/Session key pair for the given index.</p>
<p>Key Index. Menu Enter Index</p>	

## Index Select

Menu Option	Description
<pre>Test Encrypt Index Select</pre> <p>Pressing <b>Enter</b> will select the displayed menu option.</p>	<p>Used to indicate the appropriate key for the Test Encrypt or Key Check Value verification.</p>
<pre>Key Index. Menu Enter Index</pre>	<p>Enter 0-9 for Master Session or 0-3 for DUKPT.</p>

## Canadian

Menu Option	Description
<pre>Security Canadian</pre> <p>Pressing <b>Enter</b> will select the displayed menu option.</p>	<p>⚠ <b>Note:</b> Canadian hierarchy is not currently implemented.</p>
<pre>Not Implemented Press any key...</pre>	

### Key Injection

Menu Option	Description
<div style="border: 1px solid black; padding: 5px; margin-bottom: 10px;"> <p style="color: red;">Security</p> <p style="color: red;">Key Injection</p> </div> <p style="color: red;">Pressing <b>Enter</b> will select the displayed menu option.</p>	<p>The NCR 5992 is designed to be used with the IVICM KeyFac injection utility, Version 5.44 or higher, to facilitate Financial Debit Key injection into the terminal.</p> <p>Communication parameters are:</p> <ul style="list-style-type: none"> <li><input type="checkbox"/> 4800 baud</li> <li><input type="checkbox"/> 7 data bits</li> <li><input type="checkbox"/> Even parity</li> <li><input type="checkbox"/> One stop bit</li> </ul> <p>Refer to Figure 5-5 for connecting the NCR 5992 to the KeyFac system.</p>
<div style="border: 1px solid black; padding: 5px; margin-bottom: 10px;"> <p style="color: red;">Key Index. Menu</p> <p style="color: red;">Enter Index:</p> </div>	<p><span style="color: red;">✎</span> <b>Note:</b> The index entered here does not over-ride the index defined by the KeyFac software (KIS protocol). This index entry is a legacy command used for systems that previously would not allow key injection into multiple indexes.</p>

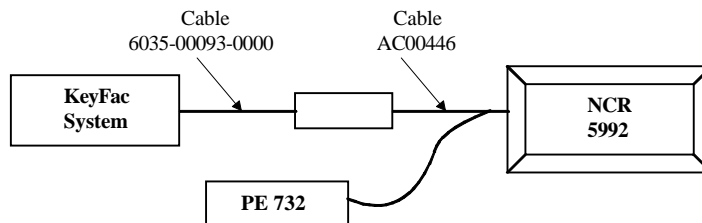

Connecting the NCR 5992 to the KeyFac System

After the index is entered, the unit is ready to accept key injection commands from the KeyFac system. When each key is injected, as referenced by the KeyFac screen for messages, the NCR 5992 will display an appropriate response:

Master:	“Master Injection OK”	“Master Injection Error”
Session:	“Session Injection OK”	“Session Injection Error”
DUKPT:	“DUKPT Injection OK”	“DUKPT Injection Error”

KeyFac will issue the “lock” command at the end of each key set injection, triggering the NCR 5992 to exit the key injection mode. Until the unit exits from the key injection mode, the touch screen will be disabled.

The Key Injection Mode also directly supports the VISA DUKPT “90” / “91” Key Load and “76” Test Commands as defined in the VISA document “Point-of-Sale Equipment Requirements”, Pin Processing and Data Authentication, International Version 1.0, August, 1988. The NCR 5992 will display the following responses:

DUKPT Initial OK
DUKPT Test error
DUKPT Test OK

## OS Version

The OS version diagnostics display the current operating system version number. Select OS VERSION from the DIAGNOSTICS menu:

```
Ver: <version#>  
Press any key . . .
```

The <Version#> displayed is the value of the operating system loaded on the FLASH of the NCR 5992 unit.

Pressing any key exits this screen and returns the DIAGNOSTICS menu. Pressing the **Cancel** key exits the session and starts the NCR 5992 application.

## Library Version

The library version diagnostics display the current library version number. Select **LIBRARY VERSION** from the DIAGNOSTICS menu:

```
Ver: <version#>  
Press any key . . .
```

The <Version#> displayed is the value of the library version linked with the current application on the FLASH of the NCR 5992 unit.

Pressing any key exits this screen and returns the DIAGNOSTICS menu. Pressing the **Cancel** key exits the session and starts the NCR 5992 application.

## Security Version

The security version diagnostics displays the current system security version number. Select **SECURITY VERSION** from the DIAGNOSTICS menu:

```
Ver:  
  <version#>/<ver#2>/  
<ver#3>  
Press any key . . .
```

The <version#> is the value of the security module loaded on the security module of the NCR 5992 unit. The <ver#2> is the value of the security module loader. The <ver#3> displayed is the value of the digitizer version.

Pressing any key exits this screen and returns the DIAGNOSTICS menu. Pressing the **Cancel** key exits the session and starts the NCR 5992 application.

## Digitizer Version

The digitizer version diagnostics displays the current system digitizer version number. Select **DIGITIZER VERSION** from the DIAGNOSTICS menu:

```
Ver:  
  <version#>/<ver#2>  
Press any key . . .
```

The <version#> is the value of the digitizer module loaded on the digitizer module of the NCR 5992 unit. The <ver#2> is the value of the digitizer module loader

Pressing any key exits this screen and returns the DIAGNOSTICS menu. Pressing the **Cancel** key exits the session and starts the NCR 5992 application.



## Calibrate

The calibration diagnostics allow you to re-calibrate the digitizer, making the digitizer's coordinates match the LCD's. Select **CALIBRATE** from the **DIAGNOSTICS** menu:

An "Enter Calibration Password" prompt displays. Type in the password "8467" ("THOR"), and press **Enter**. If an incorrect password is entered, a "Password Invalid" message displays. Press any key to end the session and start the NCR 5992 application. Then access diagnostics mode again.

Entering the correct password will prompt the following display:

```
Calibrate Mode
0=Stylus, 1=Touch,
2=Both
```

Depending on the option selected the following screen(s) will display:

Stylus

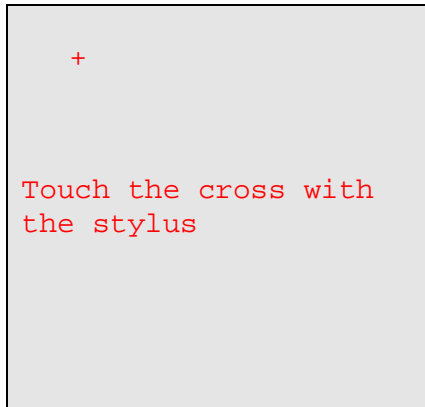

Touch

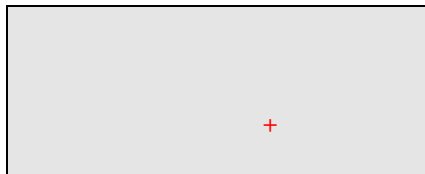

Touch the cross with  
your finger to start  
finger calibration

Using the NCR 5992 stylus, touch the displayed cross and hold it with the stylus until you hear a beep. The cross will then move to the next position, (the bottom left corner of the screen). Continue until all four corners of the screen have been touched with the stylus.

✎ **Note:** Avoid touching the glass with your finger or hand while performing the stylus calibration.

If the 'Both' option is selected, the screen will then start over with the message to "Touch the cross with the finger". Use your finger and touch each corner of the screen on the cross as you did with the stylus.

✎ **Note:** Do not hold the stylus while performing the finger calibration.

When completed, the screen clears automatically and returns the DIAGNOSTICS menu. Pressing the **Cancel** key exits the session and starts the NCR 5992 application.

---

## Stylus Test

The stylus diagnostics allow you to sign on the display screen, checking that the digitizer and stylus are functioning properly. Select **STYLUS TEST** from the DIAGNOSTICS menu:

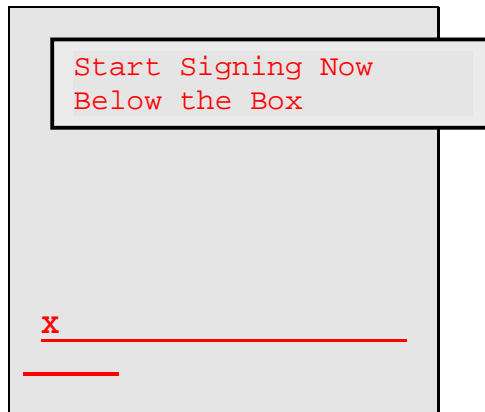

Immediately begin signing or writing on the display screen with the stylus. When the stylus is lifted from the screen for approximately 8 seconds, test is ended and the DIAGNOSTICS menu displays.

Pressing the **Cancel** key exits the session and starts the NCR 5992 application.

## LCD Contrast

The LCD contrast diagnostics allow you to adjust the contrast on the screen. Select **LCD CONTRAST** from the DIAGNOSTICS menu:

```
YES=Lighter  NO=Darker  
Raw Value=190, Table  
Index=45
```

```
Comp. Value=146,  
Offset=0  
Output Value=146
```

Press and hold the **Yes** key to lighten the contrast on the display screen. Press and hold the **No** key to darken the contrast on the display screen.



#### **WARNING**

If the contrast is set too dark, images may burn into the LCD screen. It is recommended that the screen be set where images can be seen clearly without making them too dark.

Press the **Enter** or **Cancel** key to return to the LCD CONTRAST menu. Pressing the **Cancel** key exits the session and starts the NCR 5992 application.

## Show Touches

The show touches diagnostics allow you to check the pixels on the display screen. Select **SHOW TOUCHES** from the **DIAGNOSTICS** menu:

A blank (all pixels off) screen displays. Using the stylus or your finger, touch the display screen. Where the screen is touched, a pixel will turn on. If the pixel turned on is not approximately where you touched the screen, run the **CALIBRATION** diagnostics to recalibrate the digitizer.

This test runs approximately 30 seconds. After 30 seconds the test is automatically ended and the **DIAGNOSTICS** menu displays. Pressing the **Cancel** key exits the session and starts the NCR 5992 application.

## Base Line/Gain

Provides a numeric readout to indicate compensation levels for the display screen. Select **BASE LINE/GAIN** from the DIAGNOSTICS menu:

```
00 00 00 00 00 00 00
00
82A1 A003 9B7F 7370
Press any Key...
```

```
0001 0001 0001 0001
A
Press any Key...
```

Press the **Enter** or **Cancel** key to return to the BASE LINE/GAIN menu. Pressing the **Cancel** key exits the session and starts the NCR 5992 application.

## Show Keypad Touches

The show keypad touches diagnostics allow you to check the pixels on the display screen. Select **SHOW KEYPAD TOUCHES** from the DIAGNOSTICS menu:

```
Show Keypad Touches
Turn Host On:1 Off:0
```

A blank keypad outline screen displays.

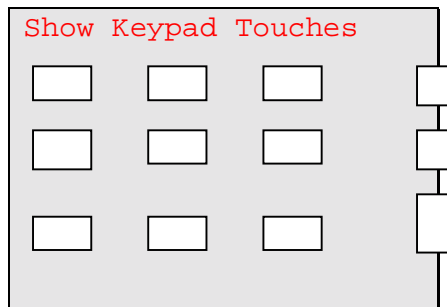

Using the stylus or your finger, touch the display screen. Where the screen is touched, a pixel will turn on. If the pixel turned on is not approximately where you touched the screen, run the CALIBRATION diagnostics to recalibrate the digitizer.

This test runs approximately 30 seconds. After 30 seconds the test is automatically ended and the DIAGNOSTICS menu displays. Pressing the **Cancel** key exits the session and starts the NCR 5992 application.

---

# Chapter 5 Index

---

## —A—

Application Software, 1-4  
AUX1A RS232 Test, 6-12  
AUX1B RS232 Test, 6-15  
Auxiliary Power Cable, 3-2

## —C—

Cable Configurations, 3-8  
Calibrate, 6-20  
Communication Interface, 1-5  
Connecting and Disconnecting the  
NCR 5992 Stylus and Host Cable,  
3-5  
Connecting the NCR 5992 Host  
Cable, 3-6  
Connecting the NCR 5992 Stylus, 3-  
5  
Connecting the NCR 5992 to a PC,  
3-12  
Connecting the NCR 5992 to the  
NCR 7452/3 Workstation, 3-8

## —D—

Detailed Problem Troubleshooting,  
5-2  
Diagnostic Tallies, 4-20  
Diagnostic test procedures, 6-1  
Digitizer Calibration, 4-19  
Disconnecting the NCR 5992 Host  
Cable, 3-7

Disconnecting the NCR 5992 Stylus,  
3-6

Display Test, 6-6

## —E—

EIA-232, 1-5  
EIA-485 Link Address, 4-19  
Encryption Test, 6-19  
Environmental Considerations, 3-3

## —F—

Functional Description, 1-4

## —H—

Hardware Considerations, 3-1  
Host RS232 Test, 6-9

## —I—

IBM 46xx Test, 6-8  
IBM-EIA-485, 1-6  
Inspection, 3-3  
Installation, 3-1, 3-4  
Interface Cable, 1-3  
Inventory, 3-4

## —K—

Keypad Test, 6-5

## —L—

LCD Contrast, 6-21



Library Version, 6-20

—M—

Maintenance Mode, 4-18

Diagnostics, 4-20

Load Operating System, 4-21

Setup, 4-18

MSR Test, 6-6

—N—

NCR 5992 Diagnostics Menu Key

Features, 6-3

NCR 5992 Model Configurations, 1-2

NCR 5992 Signature Capture unit,  
1-1, 1-3

NCR 5992 Software, 2-1

—O—

Operational Mode

Supervisor Mode, 4-3

Operational Modes, 4-1

Diagnostic Mode, 4-1

Normal Mode, 4-1

Supervisor Mode, 4-1

OS Version, 6-19

—P—

Stylus Test, 6-21

Physical Description, 1-2

Physical Specifications, 1-3

Ping-pong Test, 4-20

Power Considerations, 3-2

Power Module, 1-4

Power Modules, 3-2

—R—

RS-232 Communication, 4-19

—S—

Screen Contrast Adjustment, 4-19

Security, 1-2

Security Version, 6-20

Show Touches, 6-22

SRAM Test, 6-18

Stylus, 1-3

Supervisor Menu Items, 4-6

Application Configuration, 4-14

Change Password, 4-15

CMDL, 4-6

Compress, 4-11

Delete, 4-10

File System, 4-7

Hardware Configuration, 4-16

ID Banner, 4-15

Init Space, 4-13, 4-14

Power Down, 4-17

Read, 4-7

Serial Number, 4-16

Space Report, 4-12, 4-14

Start Application, 4-17

Write, 4-8

—T—

Troubleshooting Guide, 5-1

—U—

Unit Location, 3-1

Unpacking, 3-3

—W—

WinFORM.exe, 2-1



