



# MviX Multimedia Player

MV5000U & MV4000U  
MviX Multimedia Player



Model NO. MV-5000U



Model NO. MV-4000U

**USERS  
MANUAL**



# Table of Contents

MV5000U & MV4000U  
MviX Multimedia Player

<b>Introduction</b>	.....	3page
<b>Package Contents</b>	.....	4page
<b>Front and Rear Panel</b>	.....	5page
<b>Feature</b>	.....	6page
<b>Specification</b>	.....	7page
<b>Warning</b>	.....	8page
<b>Remote Control</b>	.....	9page
<b>How to assemble &amp; insert HDD</b>	.....	10page
<b>Installation and connection</b>		
Connection with composite TV output	.....	13page
Connection to S-Video output	.....	13page
Connection to component output	.....	14page
Connection to 2ch of normal TV	.....	14page
Connection to coaxial output	.....	15page
Connection to optical output	.....	15page
Connection to computer	.....	16page
<b>MviX Setup Menu</b>		
Audio/Video Setup	.....	17page
Misc Setup	.....	18page
Firmware Setup	.....	19page
Play all kinds of Media File	.....	20page
Play Video File	.....	21page
Play Audio File	.....	22page
Play Photo File	.....	23page
Firmware Upgrade	.....	24page
<b>USB Connection with PC</b>	.....	25page
<b>Partitioning &amp; Formatting</b>		
Windows98/ME User	.....	26page
Windows2000/XP User	.....	31page
<b>Warranty Information</b>	.....	36page
<b>Contact information</b>	.....	37page



# MviX Multimedia Player

MV5000U & MV4000U  
MviX Multimedia Player

Congratulations ! On your purchase of Mvix Multimedia Player.

You can now enjoy your favorite movies, home videos, digital music and digital photos on TV or Home-theater System. Mvix Player brings all digital media to your living room so that you can now enjoy with your near and dear ones.

## Here are some things to note before you start using your player:

- 1. Remove the thin film** on the side panels of your Mvix Multimedia Player. This film is provided to protect the Mvix surfaces from scratches and dust and to ensure that it reaches you in an A-Ok condition.
- 2. Install the HDD** as recommended in the Users Manual. The Mvix Multimedia Player does NOT come with an installed Hard Disk Drive (HDD). Kindly ensure that you use "*Master or Single*" jumper settings.
- 3. Format and Partition your HDD** after installation, before you can use transfer files onto your Mvix Multimedia Player. Please refer to your users manual for details on "How to Format and Partition a HDD?"

You've selected one of the best-built, best-backed products available today in this product category. We'll do everything in our power to keep you happy with your purchase for years to come. You can count on our uncompromising commitment to your total satisfaction.

Please feel free to contact us at [unicorn@eunicorn.co.kr](mailto:unicorn@eunicorn.co.kr) or [support@mvixusa.com](mailto:support@mvixusa.com) if you have any questions. We'd be delighted to hear from you !



# Package Contents

MV5000U & MV4000U  
MviX Multimedia Player



MV-5000U



MV-4000U



Stand



12V Adapter



Adapter Cable



Remote control



USB Data Cable



A/V Cable



Driver CD



User Manual



Bag (Only for MV-5000U)



# Front and Rear Panels

MV5000U & MV4000U  
MviX Multimedia Player

## → FRONT

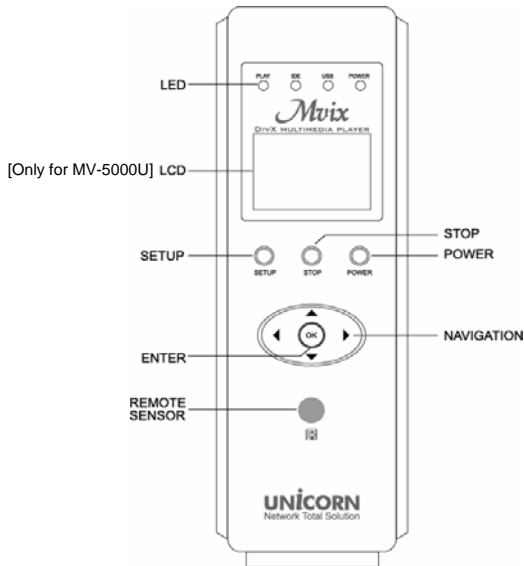

## → BACK VIEW

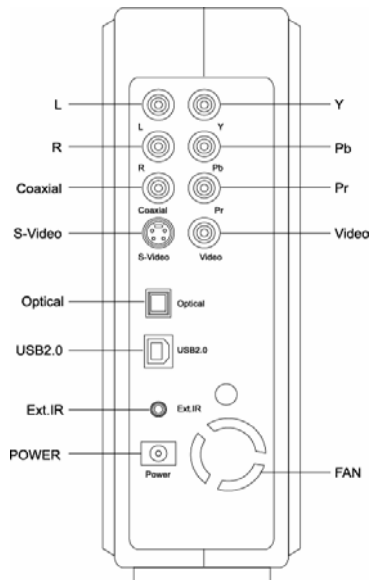



# Features

MV5000U & MV4000U  
MviX Multimedia Player



## Enjoy your movies on TV

You can enjoy your favorite movies and home videos on TV or Projector. MviX Multimedia Player supports most of the popular video formats including MPEG1, MPEG2, MPEG4, AVI, DivX3.11, 4x, 5x, XviD, DVD(IFO, VOB), VCD(DAT) etc.



## Digital Music Box

MviX Multimedia Player can play various audio/music files such as AC3, MP2, MP3, DTS pass through, WMA, OGG through the TV speaker or your existing audio system.



## Portable Digital Photo Album

MviX can play digital photo files and display them to TV or projector. Store JPEG photos directly from a PC through the USB2.0 interface and enjoy a slide show without using a computer



## Portable HDD Storage

MviX uses 3.5" HDD and it works just like an external USB2.0 hard drive when connect it to a PC. The USB2.0 interface supports data transfer rates of 480Mbps.



## Easy Firmware Upgrading

MviX is based on highly scaleable technology. You can download latest firmware from our website and upgrade the your multimedia player by connecting it to a PC. Firmware Upgrades provide support for all the latest DivX file formats.



## FM Transmitter [Only for MV-5000U]

MviX has an internal FM Transmitter module to broadcast audio via FM frequency (four channels). Oh! and you don't need audio cables anymore!



## Car Pack [Optional]

MviX also can be used in car with car pack. It contains Auto-power adapter, External IR cable, cassette deck and audio cable.



# Specifications

MV5000U & MV4000U  
MviX Multimedia Player

Supported File Formats	Video	MPEG1/2, Div3.11, Div4.0, Div5.0, Divx, Xvid, DVD(IFO, VOB), VCD(DAT), M2V
	Audio	AC3, MP2, MP3, DTS pass through, Ogg, WMA, MPGA, MPA
	Photo	JPEG
Input & Output	USB 2.0 (Cypress chipset)	
	Component Video : RCA Y, Pr, Pb	
	Composite Video : RCA and S-Video	
	Audio : RCA L/R, Coaxial, Optical	
	IR-Ext	
User Interface	Full Featured IR-Remote control Buttons : Power, Play, Stop, Cancel, Up, Down, Left, Right LCD panel (128X64) – Only for MV-5000U	
FM Transmitter [Only for MV-5000U]	Even Band : 88.0MHz, 88.4MHz, 88.8MHz, 89.2MHz Odd Band : 87.7MHz, 88.1MHz, 88.5MHz, 88.9MHz	
Operating System	Windows 98se, ME, 2000, XP or later	
Partition Type	FAT32, NTFS	
Power	External 12V/2.5A DC adapter	
Supported Languages	Various languages 'smi, sub, srt' file	
Dimensions	5.71 x 6.3 x 2.05 (inches) or 145 x 160 x 52 (mm)	
Retail Kit Includes	MViX Media Player (MV-5000U/MV-4000U), AC Power Adapter RCA 2-CH, AV Cables, USB Cable (for PC), Carry-on Bag [Only for MV-5000U], Manual, Driver CD	



# WARNING !

MV5000U & MV4000U  
MviX Multimedia Player

## ➔ Safety Instructions

01	The MviX Media player cannot detect unformatted hard-disc drives (HDDs). Make sure that the HDD is formatted. Please read instructions on "Partitioning and Formatting" in this manual.
02	Do NOT expose your MviX Media Player to heat, dust, humidity or magnetic field. We strongly recommend you to backup your data. We are do not assume responsibility for corruption, damage or loss of files on your HDD.
03	Do NOT unplug your Media Player's while a file is playing. It may result in loss or corruption of data or files.
04	Be careful while handling and moving your MviX Media Player. The player may be damaged by dropping, hard impact, or shock.
05	Do NOT install your media player near any heat sources such as radiators, heat registers, stoves, or other apparatus (including sound amplifiers) that produce heat.
06	Unplug your Media player during lightning storms or when unused for long periods of time.
07	Do NOT touch your MviX Media Player with wet hands. It may cause electric shock. Clean only with dry cloth. Do not place any sources of danger on your Media Player (e.g. liquid filled objects, vases, lighted candles etc.).
08	Do NOT disassemble the Media Player. It may cause damage to you your MviX Media Player.
09	While using this media player in a car, we recommend you to use the supplied cigarette lighter jack (optional). We are not responsible for damage or loss of data by using some other after-market cigarette lighter jack.
10	Do not block any ventilation openings of your MviX Media Player. HDD operation requires adequate air-circulation for proper functioning. Do not operate the media player in an enclosed cabinet. Allow about 10 cm (4 inches) of free space around the player for adequate ventilation.

**WARNING: To reduce the risk of fire or electric shock, do not expose this appliance to rain or moisture.**





# Remote Control

MV5000U & MV4000U  
MviX Multimedia Player

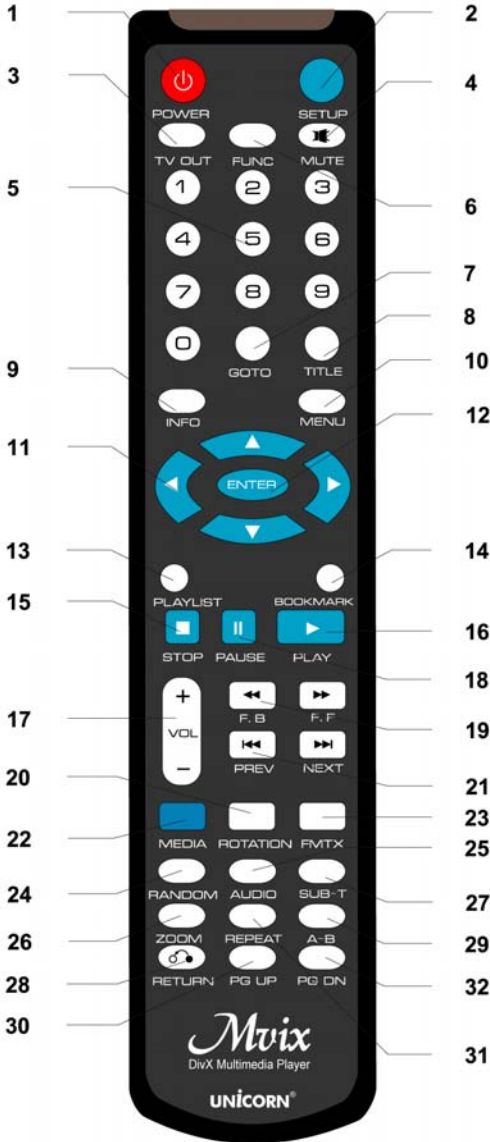

1. Power ON or OFF
2. Setup
3. Change the VIDEO OUT mode
4. Mute
5. Number Keys
6. Function Key
7. Goto
8. Title for DVD
9. Show the info for file playing
10. Menu for DVD
11. Navigation – Arrow Keys
12. ENTER to confirm the selection
13. Play Lists
14. Bookmark
15. Stop
16. Play
17. Volume +/-
18. Pause
19. Fast Forward / Reverse
20. Rotation to rotate the picture
21. Skip backward and forward
22. MEDIA switch from  
MIXED -> VIDEO -> AUDIO -> PHOTO -> MIXED
23. FM Transmitter
24. Random
25. AUDIO select the audio track
26. Zoom
27. SUB-T select the subtitles
28. RETURN to the last folder
29. A-B setup repeat segment
30. Page Up
31. Repeat
32. Page Down



## How to Assemble & Insert HDD

MV5000U & MV4000U  
MviX Multimedia Player

**Warning:** It is of utmost importance that the installation process be conducted in a non-static environment. Always ground yourself by touching any metal object before opening your MviX Multimedia player.



1. Slide the lock toward the "UNLOCK" direction



2. Once unlocked, slide the top-cover as shown above.



3. Open the top-cover.



4. Connect the 4-pin power cable using the white plug. Take note of the shape of the power cable plug. The plug can only be inserted in one direction.



## How to Assemble & Insert HDD

MV5000U & MV4000U  
MviX Multimedia Player



5. Connect flat IDE cable. Again examine the socket of the IDE cable. The IDE cables socket can only be inserted in one direction.



6. Carefully insert the HDD inside the MviX case as shown above.



7. Once inserted, the HDD should snugly fit between the brackets as shown.



8. Prepare and fasten the HDD to the bracket with two screws (supplied).



## How to Assemble & Insert HDD

MV5000U & MV4000U  
MviX Multimedia Player



9. Once secured, slide the top-cover as shown above



10. Slide and close the lock toward the "LOCK" direction



# Installation and Connection

MV5000U & MV4000U  
MviX Multimedia Player

**Video Connections:** Your MviX multimedia player supports Composite, S-Video or Component connections. Depending on the capabilities of your TV, you only need to make one video connection from these options. To hear sound through your TV, use audio connectors (RCA 2-CH) to connect the MviX multimedia player to the corresponding AUDIO-IN jacks on your TV or Hi-Fi Device.

## ➔ Connection with ordinary (Composite) TV output

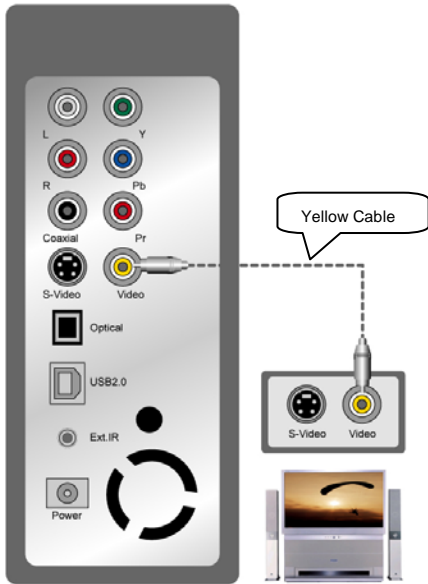

Connect MviX and your TV using the yellow video cable (cable supplied). Connect your MviX Multimedia player and your TV to a power. Select appropriate video input mode on your TV until you get the initial MviX screen.

## ➔ Connection to S-Video output

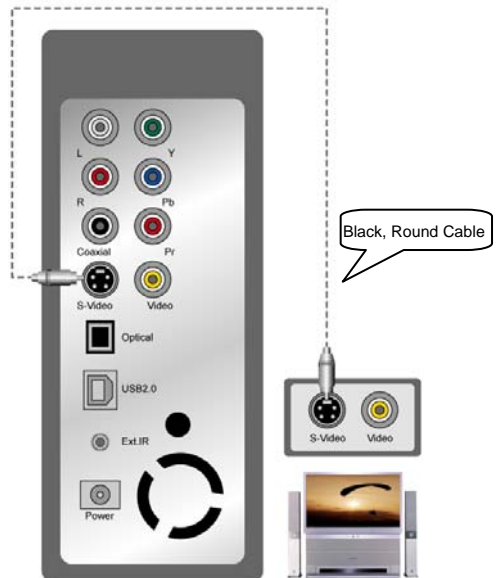

Connect MviX and your TV using the S-Video cable (cable not supplied). Turn on the MviX and TV. Select appropriate video input mode on your TV until you can get the initial MviX screen.

S-Video provides much better quality as compared to a composite connection



# Installation and Connection

MV5000U & MV4000U  
MviX Multimedia Player

## ➔ Connection to Component Output

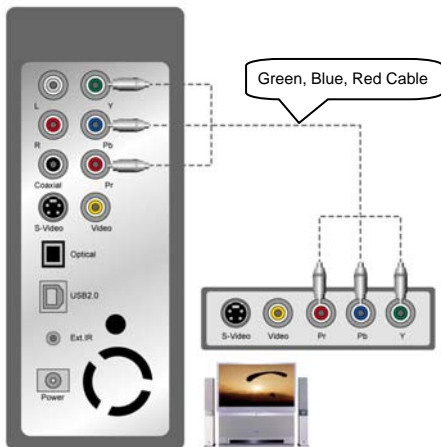

Connect the MviX media player to your TV using a component cable as shown in the image above. Turn on the MviX and TV. Select appropriate video input mode on your TV (in this case, Component input mode) (cable not supplied).

Component connection is commonly used on most HDTV's, DLP-TV's, Plasma TVs etc.

## ➔ Connection to 2-CH (RCA) of normal TV

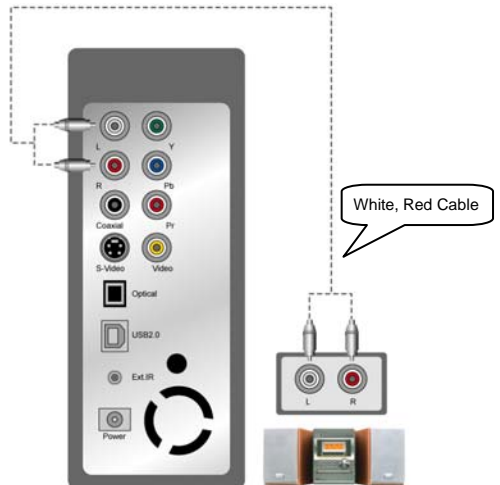

Connect left (white), right (red) sound output to the appropriate terminal of your TV or Hi-Fi Device using the 2-CH RCA cable (cable supplied).



# Installation and Connection

MV5000U & MV4000U  
MviX Multimedia Player

## ➔ Connection to Coaxial output

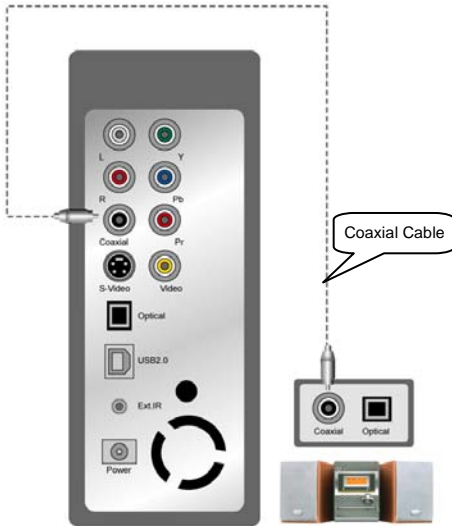

When you have a multi channel decoder/amplifier with coaxial input, you can enjoy 5.1CH high quality sound through coaxial cable. The above illustration shows how to connect with coaxial cable (cable not supplied).

## ➔ Connection to Optical output

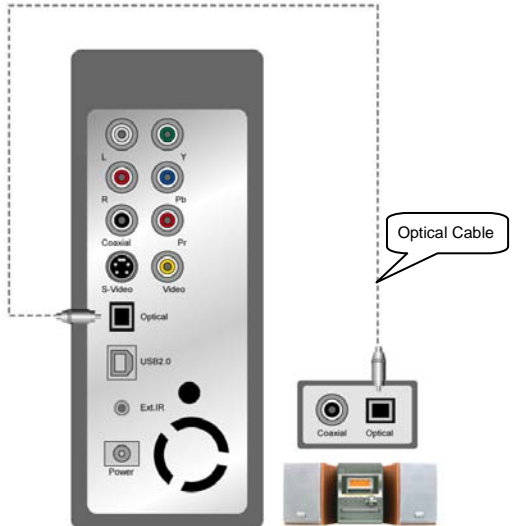

When you have a multi channel decoder/amplifier with optical input, you can enjoy 5.1CH high quality sound via optical cable. The above illustration shows how to connect with optical cable. (cable not supplied).



## ➔ Connection to Computer

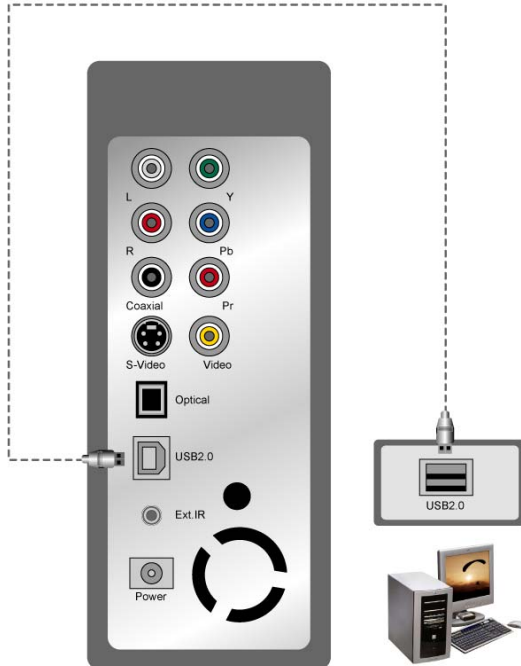

To transfer data or files from pc to your MviX Multimedia Player. Connect MviX Multimedia Player to your computer using the USB cable (cable supplied). Ensure that your MviX player is powered-on. Upon connection your PC (Win-ME/2000/XP) should recognize the new USB connected drive without installing driver. (Windows 98SE requires Driver installation. Look for the Driver software CD in your package.)





# MviX Setup Menu

MV5000U & MV4000U  
MviX Multimedia Player

## ➔ Audio/Video Setup



- 1) Video Out : Supports NTSC/S-Video, YPbPr/480i, YPbPr/480p, YPbPr/720p, YPbPr/1080i, PAL/S-Video, YPbPr/PAL
- 2) TV Type : Supports 4 X 3 Letter Box (Ordinary TV), 16:9 (HDTVs)
- 3) Audio Out : Supports Analog, or Digital Audio
- 4) FM Transmit : Supports Off, Even Band : 88.0MHz, 88.4MHz, 88.8MHz, 89.2MHz channels  
Odd Band : 87.7MHz, 88.1MHz, 88.5MHz, 88.9MHz channels
- 5) Volume : You can control the volume in the range 0~100
- 6) Volume Bal : You can control the volume balance in the range 0~100
- 7) Brightness : You can control the brightness in the range 0~100
- 8) Contrast : You can control the contrast in the range 0~100
- 9) Saturation : You can control the saturation in the range 0~100



# MviX Setup Menu

MV5000U & MV4000U  
MviX Multimedia Player

## → Misc Setup

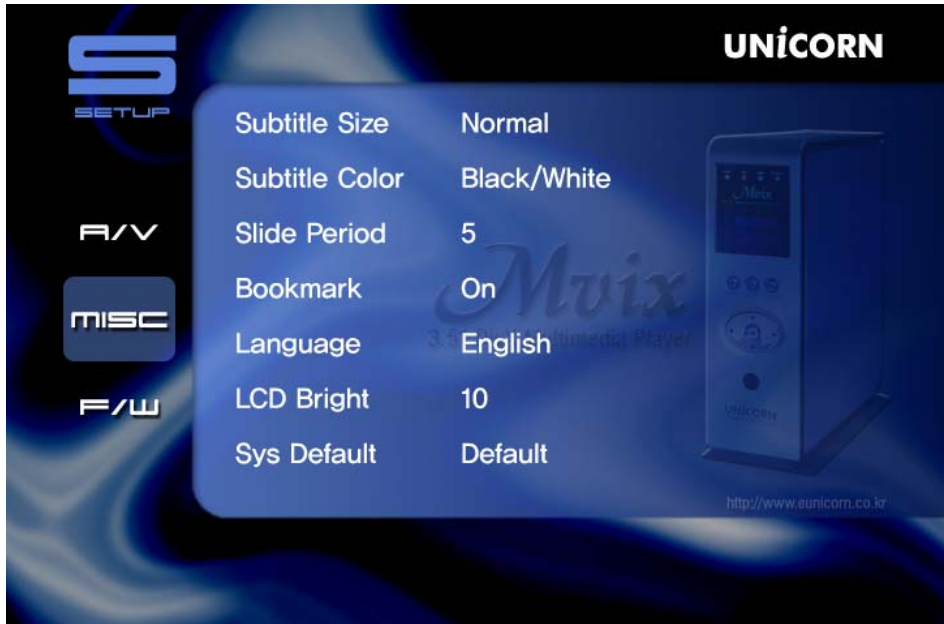

- 1) Subtitle Size : You can select the subtitle font size (Normal/Large)
- 2) Subtitle Color : You can change the color of the subtitle and its outline (Black/White, Black/Yellow, White/Yellow)
- 3) Slide Period : You can set the slide show time interval (3 ~100sec)
- 4) Bookmark : You can turn On/Off bookmark while you playback or load a file
- 5) Language: Select the language you prefer to use with your MviX Multimedia player. Currently it supports English and Korean
- 6) LCD Bright : You can control the LCD bright in the range 0~100
- 7) Sys Default : You can change the setting of the sys default



# MviX Setup Menu

MV5000U & MV4000U  
MviX Multimedia Player

## ➔ Firmware Setup

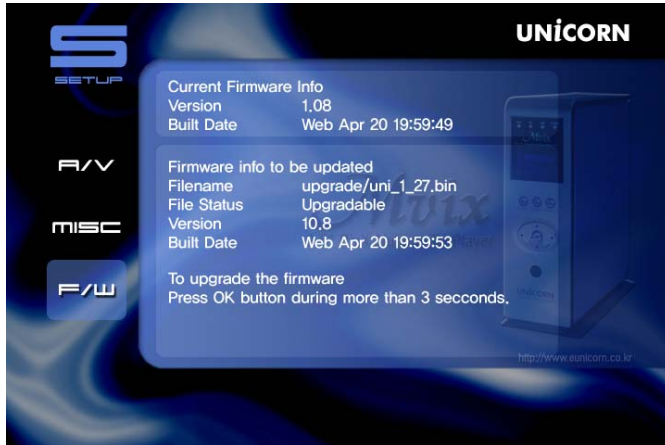

### Firmware Upgrade :

- STEP 1: Create an "UPGRADE" folder at root directory
- STEP 2: Download and Save the upgrade file in the "UPGRADE" folder.
- STEP 3: Browse to this file at setup F/W menu (more info, at page 19).



# MviX Setup Menu

MV5000U & MV4000U  
MviX Multimedia Player

## ⇒ Playing All kinds of Media Files [Default]

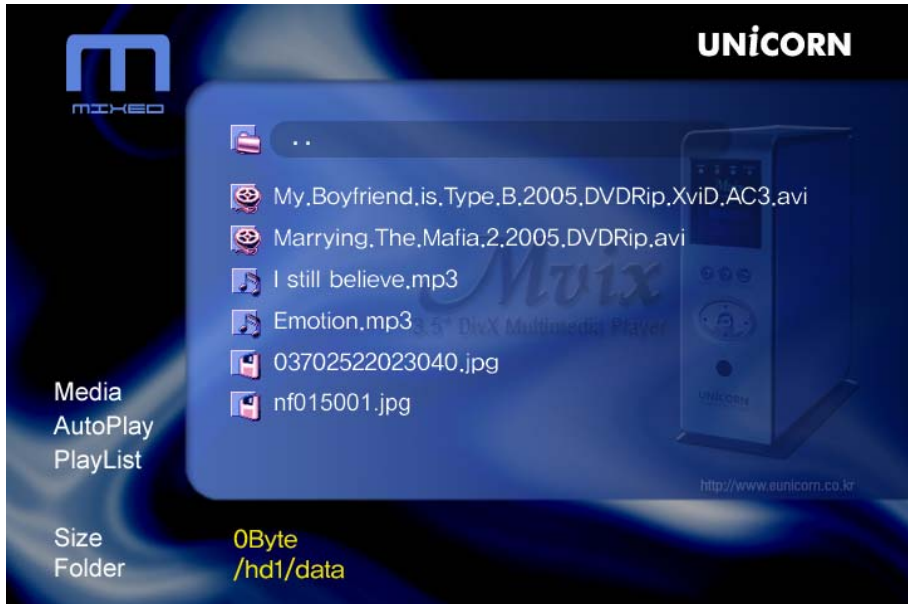

1. You will see a full list of all kinds media files saved on your MviX
2. Use UP / DOWN key on your remote to select the files you would like play and press "OK"



# MviX Setup Menu

MV5000U & MV4000U  
MviX Multimedia Player

## ➔ Playing Video Files

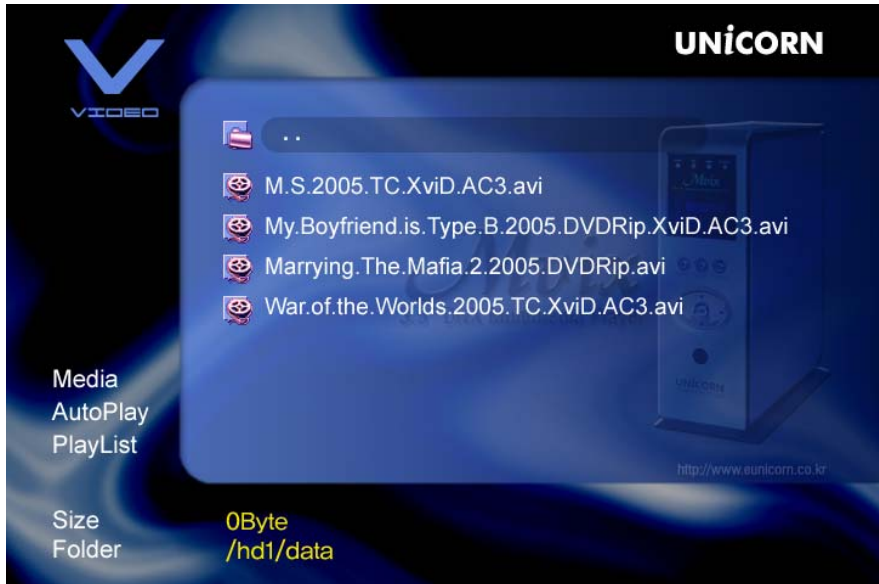

1. Press the 'MEDIA' key on Remote Control.
2. You will see a list of only VIDEO file saved on your MviX
3. Use UP / DOWN key on your remote to select the video you would like watch and press "OK"



# MviX Setup Menu

MV5000U & MV4000U  
MviX Multimedia Player

## ➔ Playing Audio / Music Files



1. Press the "MEDIA" key again on Remote Control
2. You will see a list of only AUDIO / MUSIC files saved on your MviX
3. Use UP / DOWN key on your remote to select the video you would like watch and press "OK"



# MviX Setup Menu

MV5000U & MV4000U  
MviX Multimedia Player

## ➔ Playing Photo Files



1. Press the "MEDIA" key again on Remote Control
2. You will see a list of only PHOTO / PICTURE files saved on your MviX
3. Use UP / DOWN key on your remote to select the video you would like watch and press "OK"



# Firmware Upgrade

MV5000U & MV4000U  
MviX Multimedia Player

## ➔ Firmware Upgrade

### Firmware version check

1. Connect your MviX Multimedia Player to your TV and power-on the player.
2. Navigate using remote buttons to move to 'F/W' menu and check your current firmware version.
3. Check the latest firmware version of MviX

\*\*\* You'll be posted for any firmware updates or news if you fill out the customer registration format  
<http://www.eunicorn.co.kr> and <http://www.mvixusa.com>

### How to download firmware

1. Download the latest firmware from <http://www.mvixusa.com> and <http://www.eunicorn.co.kr> to your PC.
2. Connect MviX to your PC through USB connection and power-on.
3. Your system will recognize MviX as an external hard drive.
4. Make "upgrade" folder at root directory.
5. Copy firmware files into "upgrade" folder at the MviX hard drive.
6. Turn off MviX and bring it back to your TV for firmware upgrade.

### How to upgrade firmware

1. Connect the MviX Multimedia Player to your TV and turn on MviX.
2. Navigate to the setup firmware upgrade menu
2. Keep the OK button pressed during more than 3 seconds.





# USB Connection with PC

MV5000U & MV4000U  
MviX Multimedia Player

## ➔ Windows 98SE Driver Installation

1. Please run setup.exe file contained inside the "Install CD" before connecting your MviX Media Player.
2. Reboot your PC after setup files are installed..
3. After the system restarts, connect your MviX multimedia player via the USB interface. Add New Hardware
4. You will be able to see the new HDD disk drive inside the MviX on the "Device Manager tab"

## ➔ Windows ME/XP/2000 Driver Installation

1. Windows ME/2000/XP operating systems contain pre-installed driver software. No driver installation is required.
2. The PC will automatically recognize your MviX media player as soon as it is connected via the USB interface. (please ensure that your MviX player is powered-on during connection).
3. You will be able to see the new HDD disk drive inside the MviX on the "Device Manager tab"



### ➔ Partitioning and Formatting the HDDs under Windows 98SE/ME

Click "Start" and select "Run" and the "Run" window will appear as shown below. Type "fdisk" in the text box of the "Run" window then click the "OK" button

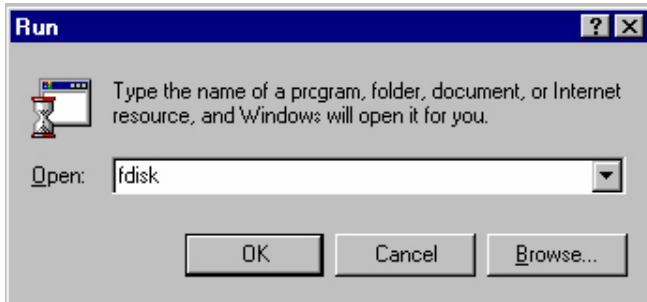

1) Select "5. Chang current fixed disk drive" and press [Enter].

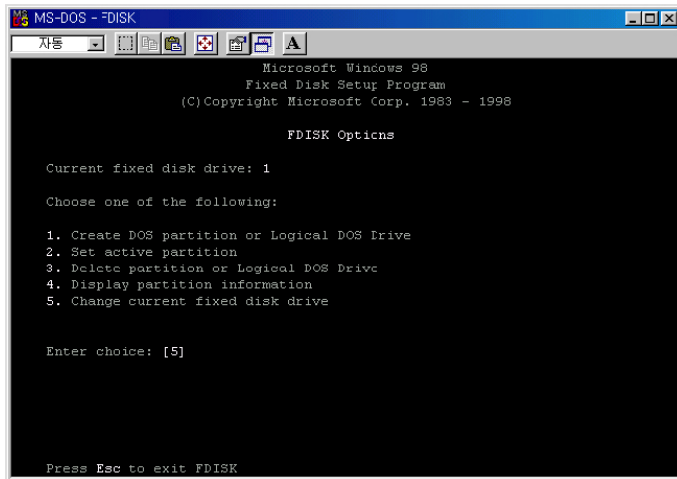



## Partition and Formatting the HDDs

MV5000U & MV4000U  
MviX Multimedia Player

2) Type the last Disk number in 0% usage.

```
MS-DOS - FDISK
Change Current Fixed Disk Drive

Disk  Drv  Mbytes  Free  Usage
  1      C:  20000    0    100%
      D:  10000
  2      11500  11500    0

(1 MByte = 1048576 bytes)
Enter Fixed Disk Drive Number (1-2).....[2]

Press Esc to return to FDISK Options
```

3) Select "1. Create DOS partition or Logical DOS Drive" and press [Enter].

```
MS-DOS - FDISK
FDISK Options

Current fixed disk drive: 2

Choose one of the following:

  1. Create DOS partition or Logical DOS Drive
  2. Set active partition
  3. Delete partition or Logical DOS Drive
  4. Display partition information
  5. Change current fixed disk drive

Enter choice: [1]

Press Esc to exit FDISK
```



- 4) Select " 1. Create Primary DOS Partition " and press [Enter]

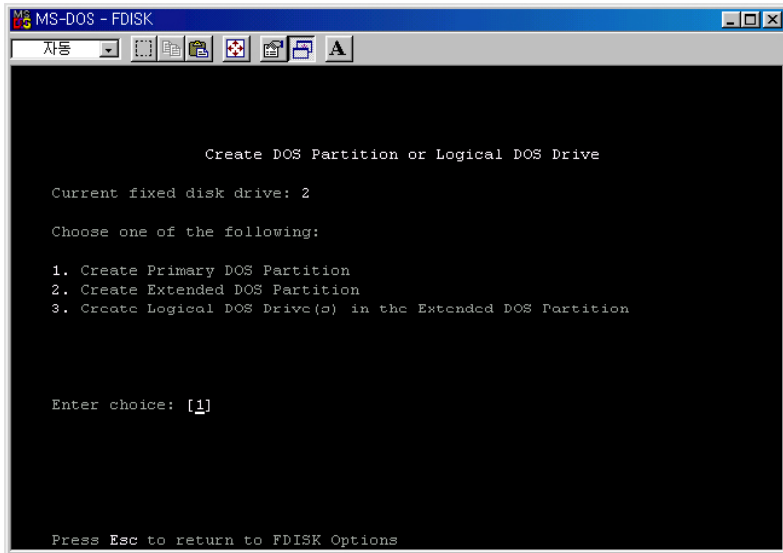

- 5) Wait until finishing verifying the drive integrity.

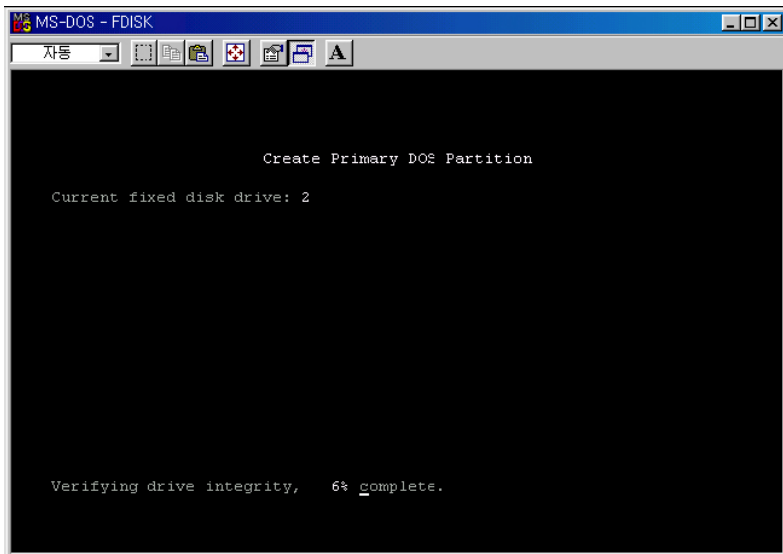



## Partition and Formatting the HDDs

MV5000U & MV4000U  
MviX Multimedia Player

- 6) After finishing drive integrity verification, type "Y" at "Do you wish to use the maximum available size for a Primary DOS Partition (Y/N)"

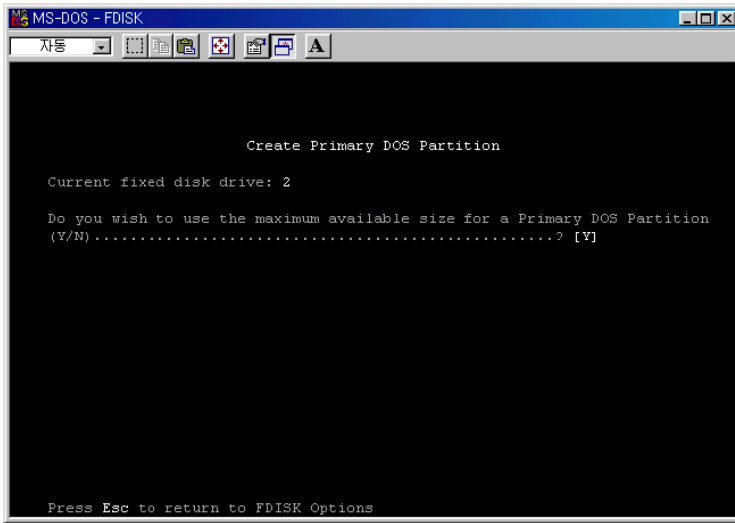

- 7) Type the capacity or % which you want to use and press [Enter].
- 8) Drive integrity verification will start again. After finishing that, press [ESC] key when the "Primary DOS Partition created, drive letters changed or added" message displays.

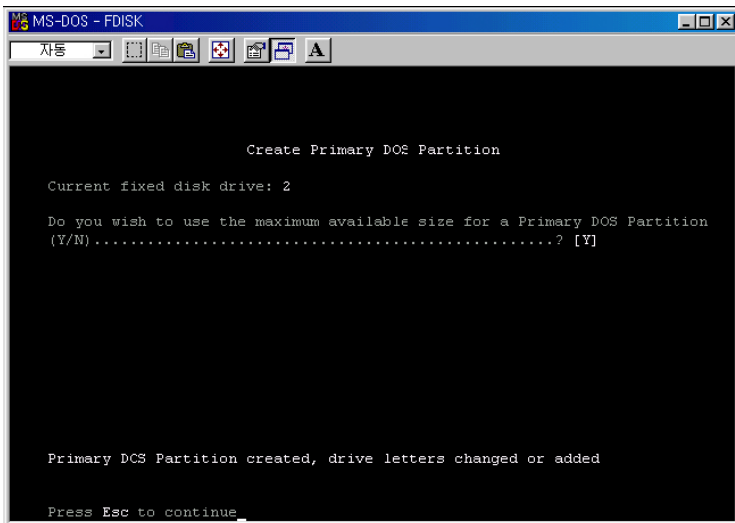



- 9) Press [ESC] key again. "Shut down Windows before restarting" message will be displayed. Press [ESC] key finally for exiting FDISK.

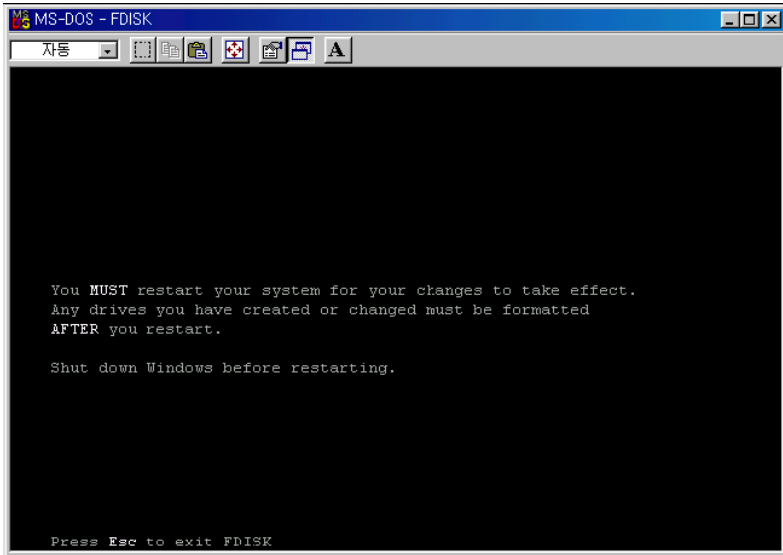

- 10) Type "exit" command at "C:\WINDOWS>" and press [Enter] for returning to windows screen.
- 11) Unplug the MviX and plug again. New volume will be appeared at [My Computer]. Click mouse right button at the new volume and select [Format]

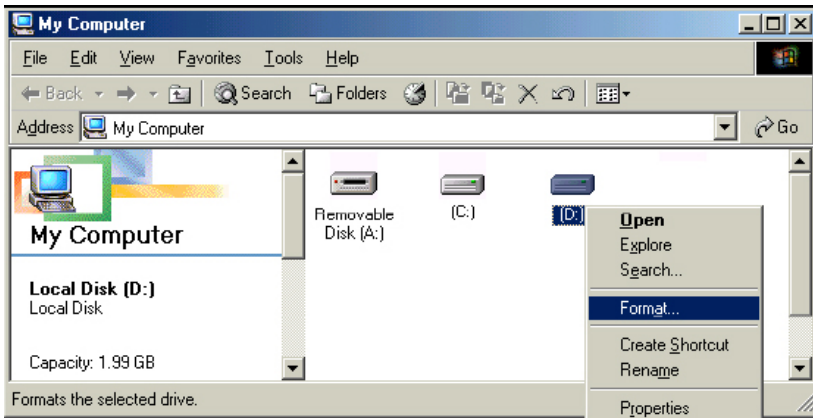



## ➔ Making partition and formatting the HDDs under Windows 2000/XP

- 1) Under Windows 2000, you can make partition and format the HDD using Disk Manager utility.
- 2) Right click "My Computer" \_ Choose "manage" from the pop up menu and "Computer Management" widow will appear choose "Disk Management" folder.
- 3) The disk list will appear on the right side of the "Computer Management" windows. Right click the MviX HDD from the list and from the pop up menu choose "make partition" to make partitions on the chosen disk.

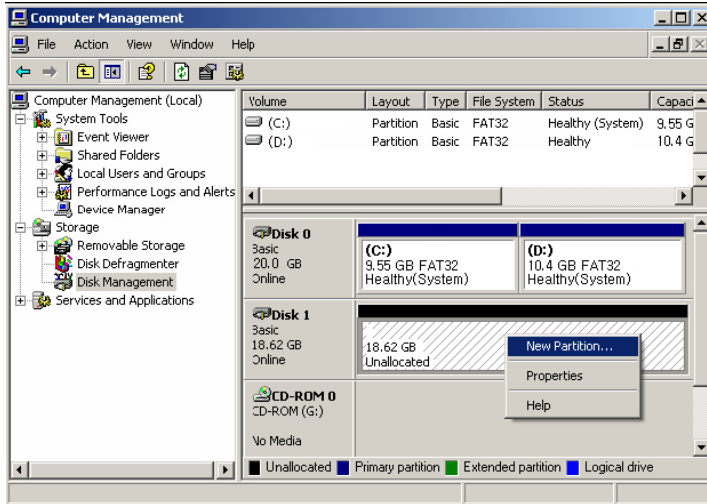

- 4) When New Partition Wizard appears , Press the "Next".

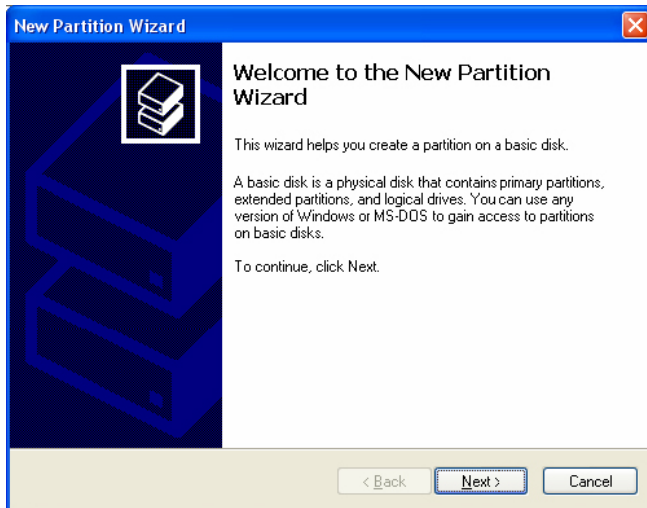



## Partition and Formatting the HDDs

MV5000U & MV4000U  
MviX Multimedia Player

- 5) Choose the partition type and format the HDD. If you want the several partition, Select the Extended Partition.

**New Partition Wizard**

**Select Partition Type**  
There are three types of partitions: primary, extended, and logical.

Select the partition you want to create:

Primary partition  
 Extended partition  
 Logical drive

**Description**  
A primary partition is a volume you create using free space on a basic disk. Windows and other operating systems can start from a primary partition. You can create up to four primary partitions or three primary partitions and an extended partition.

< Back   Next >   Cancel

- 6) Select the partition Size. If you want one partition, Press the "Next". For the FAT32, it is limited under 32000MB

**New Partition Wizard**

**Specify Partition Size**  
Choose a partition size that is between the maximum and minimum sizes.

Maximum disk space in megabytes (MB): 19069  
Minimum disk space in MB: 8  
Partition size in MB: 19069

< Back   Next >   Cancel





7) Select the Drive letter. We recommend to press the "Next".

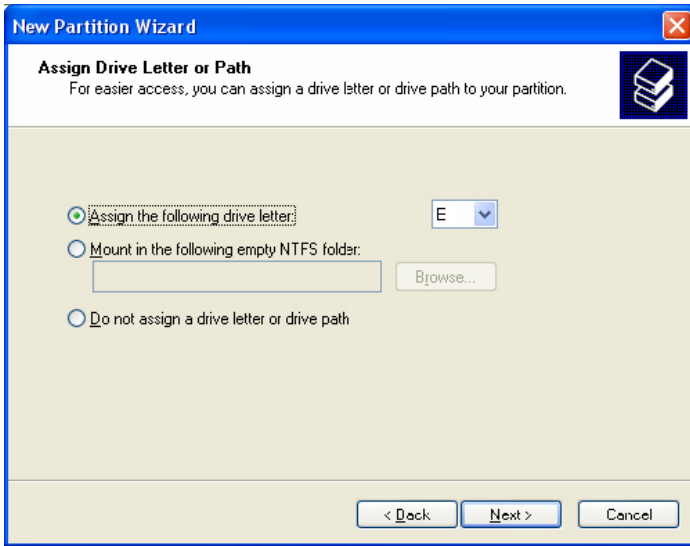

8) Select the partition Format. If you want the FAT32, it is limited under 32GB.

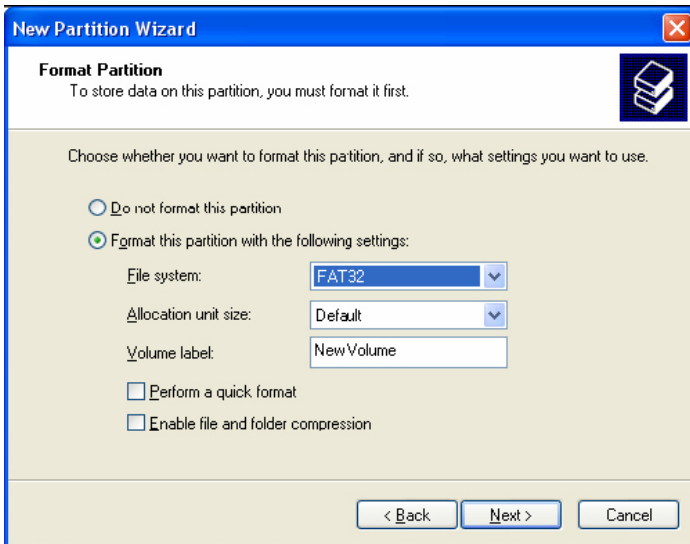



9) When it is completed, detailed information will appear as shown below. Click the "OK" button to complete the work.

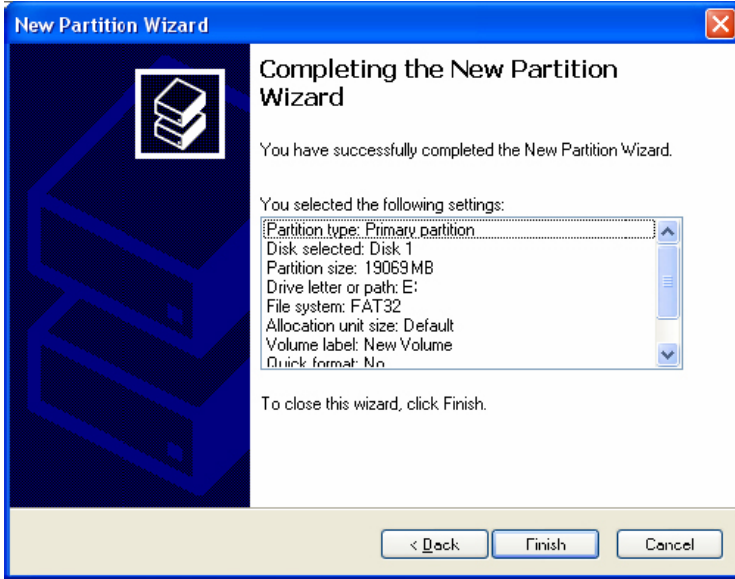



# Troubleshooting

MV5000U & MV4000U  
MviX Multimedia Player

Problem	Solution
The Multimedia Player does not respond to the remote control	<ul style="list-style-type: none"><li>– Aim the Remote Control directly at the sensor on the front of the player.</li><li>– Reduce the distance to the media player.</li><li>– Replace the batteries in the Remote Control.</li><li>– Re-insert the batteries with their polarities (+/-signs) as indicated.</li></ul>
Buttons do not work	<ul style="list-style-type: none"><li>– To completely reset the player, unplug the AC cord from the AC outlet for 5-10 seconds.</li></ul>
No Power	<ul style="list-style-type: none"><li>- Check if the AC power cord is properly connected.</li><li>– Press the Power button on the front of the Multimedia Player to turn on the power.</li></ul>
No Picture	<ul style="list-style-type: none"><li>– Refer to your TV's manual for correct Video-In channel selection. Change the TV channel until you see the media player screen.</li><li>– Check if the TV is switched on.</li></ul>
No sound or distorted sound	<ul style="list-style-type: none"><li>– Adjust the volume.</li><li>– Check the audio cables and make sure both are connected secured to the TV or Stereo Audio In jacks.</li></ul>

## **WARNING**

Under no circumstances should you try to repair the system yourself, as this will invalidate the warranty.  
Do not open the system as there is a risk of electric shock.



# Warranty Information

MV5000U & MV4000U  
MviX Multimedia Player

To receive warranty service, please be sure to have your proof of purchase and a barcode from the product's packaging. Warranty requests cannot be processed without proof of purchase.

In no event shall Unicorn's liability exceed the price paid for the product from direct, indirect, special, incidental, or consequential damages resulting from the use of the product, its software, or its documentation.

Unicorn does not offer refunds for any product. As a part of our warranty service, we offer to repair or replace the product. We offer cross shipments, a faster process for processing and receiving your replacement. Unicorn and its distributor pay for ground shipping only. Please contact Unicorn's Distributor in your country for more details.

## **Your warranty does not cover the following:**

- Shipping charges to return defective product.
- Labor charges for installation or setup of the product, adjustment of customer controls on the product, and installation or repair of systems outside of the product.
- Product repair and/or part replacement because of improper installation, connections to improper voltage supply, abuse, neglect, misuse, accident, unauthorized repair or other cause not within our control.
- Damage occurring to product during shipping when improperly packaged or cost associated with packaging.



# Contact Information

MV5000U & MV4000U  
MviX Multimedia Player

## **Manufacturer:**

Unicorn Information Systems Co. Ltd  
Unbo b/d 226-16,  
Sukchon-dong, Songpa-gu,  
Seoul, Korea  
[www.eunicorn.co.kr](http://www.eunicorn.co.kr)

## **Branch (USA):**

MVIX (USA) Inc.  
14102 Sullyfield Circle, Suite 100 Chantilly,  
Virginia 20151  
  
sales@mvixusa.com  
support@mvixusa.com  
[www.mvixusa.com](http://www.mvixusa.com)