



Home Controls®

Automation Products & Support

**SMART
HOME
MEETS
SMART
PHONE**



HOME SYSTEMS CATALOG



**LIGHTING &
AUTOMATION**



**SECURITY &
SURVEILLANCE**



**HOME WIRING
& NETWORKING**



**AUDIO & VIDEO
DISTRIBUTION**



**TELEPHONES
& INTERCOMS**

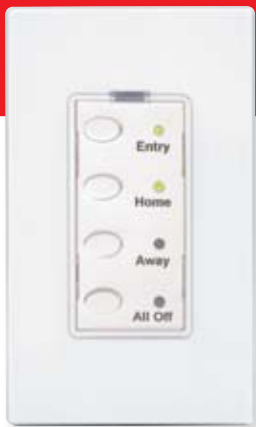

UPB

See Pages 10-14



SimpleWorx

See Page 15



Z-Wave

See Pages 16-18



EnOcean

See Page 19



Skylink

See Page 23

BEAM ME UP

*HALF MILE:
Add A Beam
Sensor To Your
Dakota Alert
2500 Wireless
System » 43*



*M&S Systems Video
Door Intercom » 83*



*Kwikset SmartCode
Access Controls » 35*



*Household Alert D.I.Y.
Wireless Sensors » 45*

HOME CONTROLS – WHERE IT'S SO EASY TO AUTOMATE YOUR HOME

Would you even consider giving up your TV remote in favor of getting up to change the channel or volume? Not us! You'd have to pry it away from us kicking and screaming. And that's what home automation is all about ... the comfort, convenience and security of little devices like a TV remote and garage door opener. Once you have them, you can't imagine life without them.

Now, imagine extending the simple conveniences you already have, a little at a time, to include control of lighting, appliances, entertainment components, temperature control, pool/spa controls, communication, security, drapery and blind control, and more ... from anywhere and everywhere, automatically and remotely. That's an intelligent home – and that's what Home Controls is all about!

-  UPB Compatible System
-  Z-Wave Compatible System
-  X10 Compatible System
-  ZigBee Compatible System
-  Smartphone Control & Interface



SKYLINK & AIR ALARM

Do-It-Yourself Wireless Security Systems » 34

800-266-8765

CUSTOMER SERVICE AND FREE TECH SUPPORT

SLIMLINE

*DoorBell Fon
New Doorbell
Fits On A
Regular Door
Frame » 80*



*Top-Quality Preference
Speakers » 69*



SMART HOME MEETS SMART PHONE



HAI OMNI: ULTIMATE IN AUTOMATION

Control Your Home's Lighting, Security, Audio, Thermostat & More From Any Smart Device, including iPad, iPhone, Android & Kindle » 26-30



View IP Cameras With Channel Vision iPhone App » 46



EXCLUSIVE: Control Your Smart Home With NavNet » 25



Interface With NuVo Grand Concerto Music System » 62



Sync IyriQ Audio With On-Q airQast Controller » 66



Never Loose Your Phone With Wireless Leash Plus » 78



iCREATION
Smart Home Phone » 78



In-Wall iPad Dock & Charger » 67



Access On-Q Wireless Lighting Controls » 19



POWER UP
Power Any Smart Device With Leviton's USB Charger & Receptacle » 78

WWW.HOMECONTROLS.COM

SHOP ONLINE 24 HOURS A DAY • THOUSANDS MORE PRODUCTS AVAILABLE!

FREE PRODUCT ADVICE & SUPPORT » **800-266-8765**

Inside An Intelligent Home

Automating and networking your home is fun and exciting, and the possibilities are limited only by your imagination! This diagram gives you suggestions on some of the options available to you to customize your own intelligent, connected home. When you find something you like, simply go to the corresponding section category in this catalog to learn about some of the related products. Start out slowly, build onto your current system, or incorporate all these systems into a new construction project. The choice is yours! Want help? Just call us at 1-800-266-8765.

HOME AUTOMATION » Page 10

LIGHTING & APPLIANCE CONTROL

- 1 Turn lights On/Off, and Dim or Brighten them from anywhere, inside or outside your home, without running any new wires! It happens through powerline or RF control.
- 2 Program indoor and outdoor lights to turn On and Off according to a schedule or event.
- 3 Program entire lighting scenes with one button push. For example, your keychain remote initiates your At Home security mode and lighting scene, so you never again have to drive up to a dark home. Your Home Theater scene might Dim the lights, close the drapes, turn On all desired entertainment components and start the popcorn maker!
- 4 Control your lights and appliances with light sensors. If it gets dark, lights turn On and then Off again a few hours later. When it gets light, automatically turn On your coffee pot and even your hair curlers.
- 5 Sensors turn outdoor lights On when someone approaches. Turn On house lights when you're driving up the driveway with your keychain remote.

POOL & SPA

- 6 Gain complete control of your pool and spa functions from in your spa, on your patio, in your home, in your car or anywhere else! Plus, completely automate the cleaning, heating and filter pump!

IRRIGATION SYSTEMS

- 7 Program your irrigation system to work on a set schedule by time, event or even a set time before dawn.

AUTOMATION CONTROLLERS

- 8 Your entire home operates automatically by programming an intelligent controller to become the brains. Control lighting, HVAC, entertainment components, irrigation and all of the other systems you see on this page. After you program your system, it operates on its own to decide what your home should do under various circumstances. Also, manually control your system through user-friendly keypads and touchscreens, and even when you are away by phone or through the Internet!

SECURITY » Page 32

SECURITY

- 9 You'll get peace of mind knowing that your family is protected with a security system. Security systems include control panels, keypads, sensors, sirens, locks, lights, monitoring, access control and more.
- 10 Control your locks by remote control, even from your cell phone.
- 11 Sirens scare away intruders, and notify neighbors and authorities of burglary or fire.
- 12 Protect your family and home from fire with advanced smoke detectors that talk to your automation system.

SENSORS

Sensors read motion, temperature, light and more. Their uses in automation are almost endless ...

- 13 Perimeter sensors alert you when a person crosses your property line.
- 14 Motion sensors could be installed on walls, on ceilings, in light switches, outdoors and more. Install a motion sensor in a room or hallway and have the lights turn On when someone enters. Outdoor sensors turn On flood lights.
- 15 Incorporate door and window sensors into your security system, and use them as automation sensors when you are at home.
- 16 Glass break sensors alert your security system.
- 17 Be alerted when people arrive.
- 18 Light sensors know when it's light or dark. If it gets dark, lights turn On and then Off again a few hours later. When it gets light, the sensor turns On your coffee pot and hair curlers.
- 19 Flood sensors detect if the washer or ice maker hoses break, and turn Off the water.
- 20 Be alerted when cars drive up.

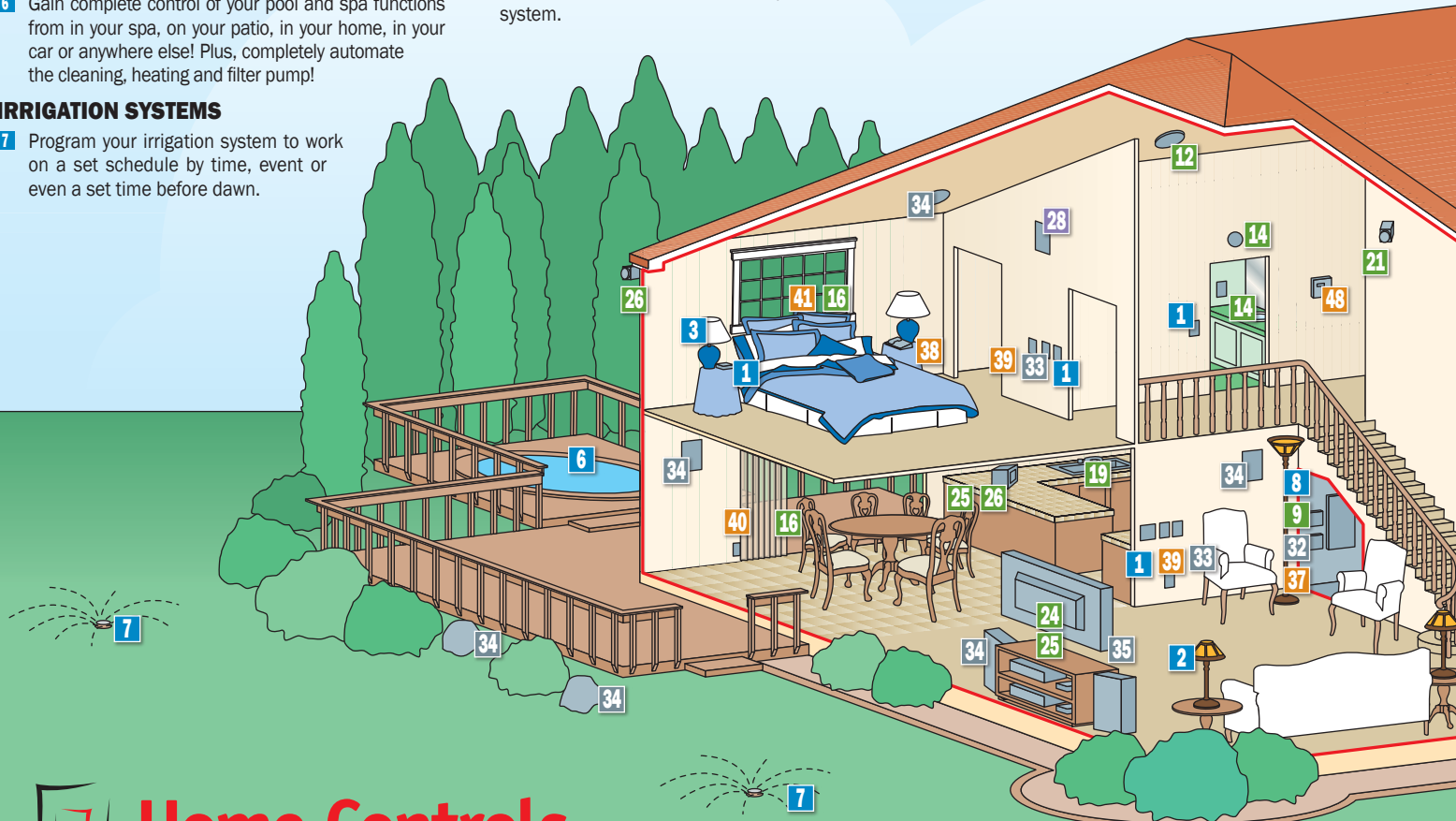

Home Controls

Automation Products & Support

VIDEO & CAMERAS

- 21 Monitor your home with surveillance cameras. Many to choose from – cameras that see in the dark, large and small cameras, bullet, dome and hooded cameras, passive IR cameras – too many to list! Some cameras are even wireless!
- 22 View your home from any computer or smart phone over the Internet.
- 23 Install a camera at the door to see who's knocking.
- 24 Time lapse and DVR recording products.
- 25 Send wireless TV, VCR and video surveillance.
- 26 Monitors let you watch different parts of the house, like the pool area or nursery, or modulate the video signals into your TV.

STRUCTURED WIRING » Page 50

WIRE MANAGEMENT

- 27 Wire management systems connect your entire security, entertainment, information, communications and home automation systems to one central location. Also known as “connected home,” wire management systems include a control panel, high-quality wire and multi-use outlets.

DATA NETWORKS

- 28 In-wall or in-ceiling power-over-ethernet wireless access points provide the greatest Wi-Fi coverage with pleasing aesthetics.

POWERLINE CONDITIONING & SURGE PROTECTION

- 29 Protect your computer, phone, fax and cable line connections with suppression plug strips.
- 30 Protect your entire house with whole-house surge suppressors.
- 31 Fine-tune your X10 system with signal amplifiers, signal bridges and noise blocks.

ENTERTAINMENT » Page 62

AUDIO/MUSIC DISTRIBUTION

Entertainment will never be the same once you upgrade to a smart audio system.

- 32 Distribute music from one location thru your entire home with a whole-home distribution system.
- 33 Control speaker volume in each room individually with in-wall controls, or all at the same time with in-wall controls.
- 34 In-wall speakers, ceiling speakers, surround sound, subwoofers, bass shakers and more! Make outdoor entertainment fun with outdoor speakers – some even look like rocks!
- 35 Expand your home theater system with HDMI and IR distribution components.

COMMUNICATIONS » Page 78

PHONES & INTERCOMS

- 36 Transform your regular phone into a high-tech telecommunications system for your home.
- 37 Add personal extensions to your phone with advanced phones or distribution panels.
- 38 Answer the door from any of your telephones, including cell phones.
- 39 Install an intercom system, or use your phone.

COMFORT » Page 84

WINDOW & DRAPE CONTROL

- 40 Set your drapes to automatically close when the sun shines directly in, then open again shortly afterwards.
- 41 Open or close your windows. Automatically close your window when it starts to rain. Control windows by wall switch, remote control or an automation system. Perfect for skylights that are hard to reach!

CENTRAL VACUUM SYSTEM

- 42 Central vacuum systems are the most efficient way to clean. The system includes a vacuum motor installed in a convenient location (like the garage), and tubing through the walls connecting to wall inlets in each room. When it's time to vacuum, simply insert a lightweight hose into a nearby inlet and your central vacuum system silently turns On.

ENVIRONMENTAL CONTROL

- 43 Thermostats control everything from comfort to cost. Set your thermostats by occupancy or on a time schedule, enjoy multi-zone control, control from a distance and more.

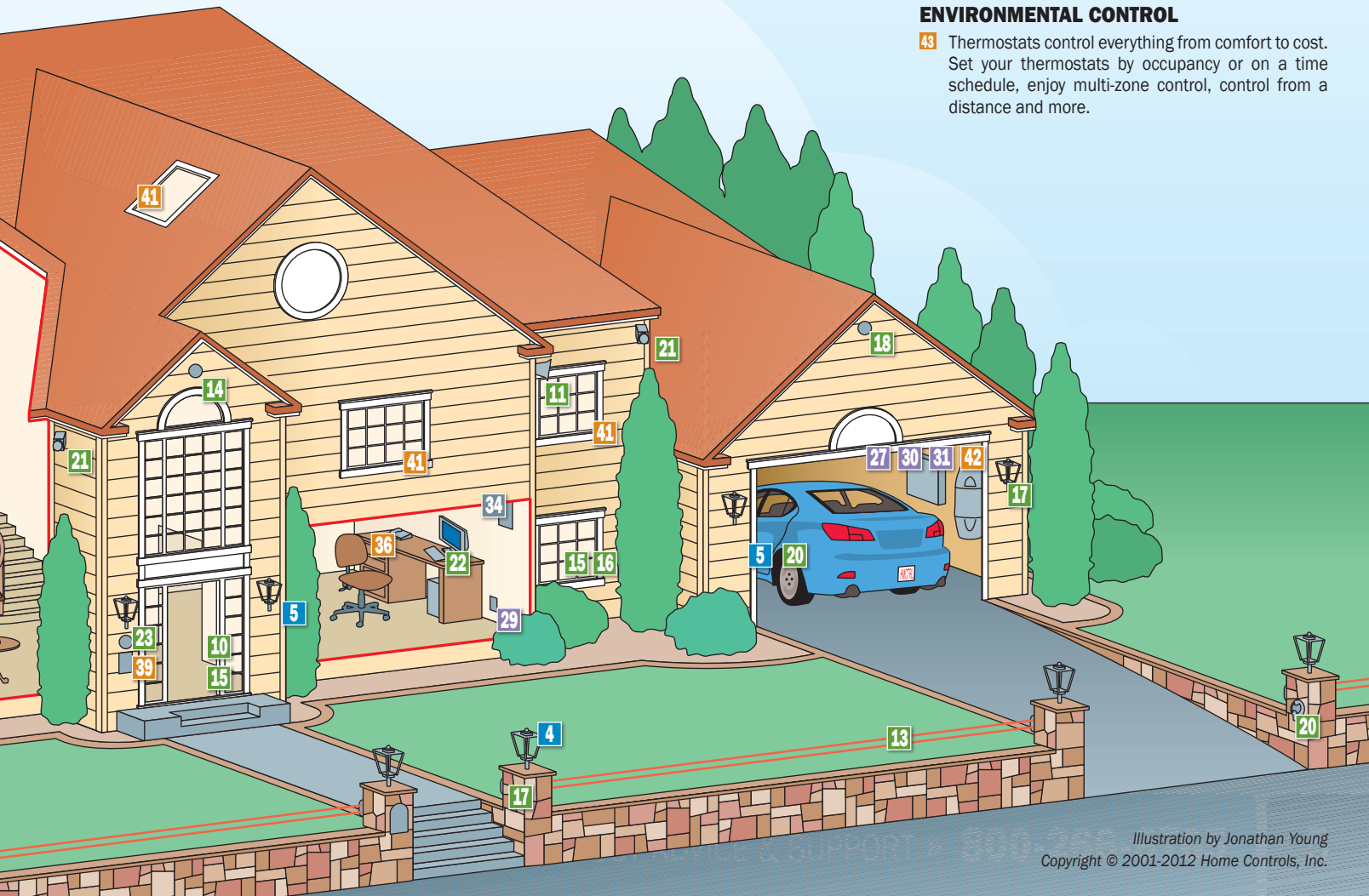

Save Energy With Home Automation

LIGHTING & APPLIANCE CONTROL

According to the Energy Conservation Enhancement Project, 20% of all electricity is used for lighting – yet 50% of that power is wasted.

- Coordinate lighting and set by your schedule, time of day or event.
- Simply replacing switches with dimmers offers energy payback to homeowners. Dimming the lights by 25% – which is almost unnoticeable – reduces electrical energy consumption by 20%, while extending bulb life by four times.
- Timer switches save energy in rooms by adding a new degree of automation, giving you control of how long the lights stay on.
- Turn lights on and off based on whether a room is occupied, so you won't waste energy leaving the lights On in an empty room.
- Most of today's appliances incorporate advanced technologies that use 10–50% less energy and water than older models. Look for the ENERGY STAR logo to guarantee savings.



Dimming Lights By 10%

Reduces Energy By **10%** & Extends Bulb Life **2x** Longer



Dimming Lights By 25%

Reduces Energy By **20%** & Extends Bulb Life **4x** Longer



Dimming Lights By 50%

Reduces Energy By **40%** & Extends Bulb Life **20x** Longer

CLIMATE CONTROL

Approximately 56% of an average home's energy cost is spent on heating, ventilation and air conditioning (HVAC) systems, according to the U.S. Department of Energy. The best way to control your energy cost is by managing your heating and cooling system.

- Programmable thermostats allow you to adjust temperature based on day and time, security settings, or occupancy – even by phone.
- The Alliance To Save Energy says you can save up to 10% a year if you add a programmable thermostat to your home! See page 86 for an array of programmable thermostat choices.

NATURAL CLIMATE CONTROL

- Automated and controlled drapery and shade systems allow you to control the temperature inside your home naturally. See page 87 for several window covering options.

ENTERTAINMENT

- Without reducing audio quality, today's amplifiers use drastically less energy – up to half – to deliver better sound. See pages 62-66 for energy-saving products.
- Eliminate vampire or phantom power (energy that devices use even when turned off) with automated switches. See page 75 for details.
- You can find energy savings on everything from standard TVs, to HD-ready TVs, to the largest flat-screen TVs – some using as much as 30% less energy. Look for the ENERGY STAR logo to guarantee savings.

IRRIGATION

- Program your irrigation system to work on a set schedule – and save water! See page 7 for a simple-to-use automated irrigation systems.

Home Energy Monitoring

ZIGBEE WIRELESS CONTROL

ZIGBEE BY HAI

Home Controls is very excited to announce the release of our first ZigBee collection from HAI. ZigBee Pro technology establishes a standard approach for wireless products worldwide, eliminating the need for proprietary technology. Home automation solutions can take advantage of a consistent wireless communication technology which offers unprecedented benefits in operational reliability, control, convenience, and security.

These products communicate through a mesh network between the ZigBee Interface Module (ZIM) and controlling ZigBee devices. The ZIM is also designed to communicate with ZigBee Pro Home Automation Profile products from other manufacturers thereby expanding compatibility.

Each point-to-point communication is referred to as a "hop." Adding more devices to the network increases the efficiency of the network due to increased numbers of hops available. A maximum of 64 devices can be utilized on a single network and each device can operate a



maximum of five hops.

HAI's ZigBee Pro products are equipped with high-powered ZigBee radios to ensure enhanced signal strength and range. These devices possess a 200' (61m) maximum single line of sight transmission under optimal conditions. Device-to-device hops expand that range significantly.

While communication for each device is wireless, power sources are conventional. The ZIM is powered by its direct connection to the Omni or Lumina home automation controller via the included serial cable. The 5A and 30A Load Control Modules (LCMs) are powered by the same circuit powering the appliance at a given LCM controls. Omnistat2 Programmable Communicating Thermostats (PCTs) receive power via traditional HVAC wiring.

A HA81A003WHZB HAI ZigBee Interface Module (ZIM) **\$209.95**

A HA81A002WHZB HAI ZigBee MicoController **\$219.95**

B HARC2000xZB HAI Omnistat2 with ZigBee (Multistage & Heat Pump, Humidity) **\$374.95**

B HARC1000xZB HAI Omnistat2 with ZigBee (Single Stage Conventional/Heat Pump) **\$374.95**

HA73A00xZB HAI Load Control Module With ZigBee **\$209.95**

C HA89A001ZB HAI Plug-In Load Control Module with ZigBee, 15A **\$139.95**



FIDO WATCHDOG

FIDO HOME ENERGY MONITOR SYSTEM

EcoDog, Inc. gives homeowners ultimate control over their energy use. Consumers often feel that there is nothing they can do in the face of rising energy prices. Now, EcoDog's FIDO Home Energy Watchdog provides a circuit-by-circuit visibility to electricity consumption that gives homeowners unprecedented power over their energy use with an added measure of privacy as a bonus.

FIDO makes it easy to make sense of electric bills, letting users know the cost of running major appliances or how much the kids add to the monthly bill when they don't turn off their video games! With simple tips and graphic charts, FIDO turns kilowatt hours into monthly savings of 15 to 25% or more on typical electric bills.

ED900006 EcoDog FIDO Home Energy Monitor System **\$1289.95**

Includes Computer Adaptor with enclosure, Communication cable RJ11-DB9, USB to RS232 Adaptor, UMC211, EcoDog Software Kit (thumb drive), EcoDog Computer Adaptor Quick Start Guide, Breaker Monitor (PLC16) Board Assembly, Kit CT Assemblies, FIDO Breaker Monitor Quick Start Guide and Ribbon Cable Assembly



Complete Details & Specifications »
www.HomeControls.com/EcoDog

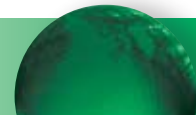

POWER SAVING SURGE PROTECTOR

SMART POWERTAP

The Smart PowerTap provides high quality, advanced surge protection for a PC and TV and the peripherals. The Smart PowerTap also reduces the amount of vampire/standby energy consumed by PC and TV peripherals.



The Smart PowerTap has built-in current sensing circuitry with 2 different switching thresholds to sense when a Control Device (typically a TV or PC) is On or Off/Standby, and to then switch On/Off selected Outlets.

The Smart PowerTap is easy to install and provides simple automation to reduce wasteful standby energy consumption. The Smart PowerTap is suitable for residential and workplace applications.

TS175SSUS4CD Smart PowerTap **\$34.95**

[See More Surge Protectors » Page 75](#)



LANDSCAPE AUTOMATION

RAINS PRO NETWORK SPRINKLER CONTROLLER

The Rain8net is a modular 8-zone sprinkler controller module that can be controlled over the Internet by any computer or other control device. It's capable of driving standard 24VAC irrigation valves directly.

- On/Off control of each valve at the Rain8 module itself, no need to run back to a PC to turn a zone on (or off).
- Each zone has a LED to indicate if it is running or idle.
- All valve wires and connections are protected against lightning surges.
- All RS232 and network connections protected against ESD and lightning.
- Each of the 8 outputs to the valves is protected against overloading by a self-resetting electronic fuse.

WG41012 Rain8 Pro RS232 Sprinkler Controller **\$217.53**

WG41017 Rain8 Pro RS232 Sprinkler Expansion **\$192.23**

ENERGY & COST SAVINGS WITH LED LIGHTS!

Home Controls is very proud to offer Pageant LED, a family of unique high power, high performance LED replacement bulbs that fit the needs of ecologically minded but economically rooted enterprises. Everyone is concerned about the environment and we want to do our share of reducing the carbon footprint. Pageant bulbs are high performance LED products that offer lumen outputs that rival high wattage incandescent bulbs but only use a fraction of the incandescent's wattage. This saves energy and reduces carbon footprint.



CANDELABRA MOUNT SERIES

Fully encapsulated, 120 Volt, 3.4 Watt, candelabra base mounting that integrates energy saving SMD LED technology into a standard candle/candelabra format. Available in Soft White (SW) in a 160° beam spread.

- E12 candelabra base
- 3.4 Watt, 120 Volt operation
- Remote transformer not required
- Operates off of standard house current
- Soft White SW (2700K) in a 160° beam spread
- Compare to 25W incandescent
- 36 on-board SMD LED diodes
- Up to 50,000 hour lamp life
- Low heat output
- 5 year warranty
- Dimmable

LD3010 LED Candelabra Mount Series **\$19.95**

R30/65BR30/PAR30 DIMMABLE SERIES

Fully encapsulated, 120 Volt, 11 Watt, screw-in medium base mounting that integrates energy saving LED technology into a standard R30 / 65BR30 / PAR30 format.

- 11 Watt, 120 Volt operation; Remote transformer not required; Operates off of standard house current
- Soft White (3000K); Daylight (5500K)
- Compare to 65W R30 / 65BR30 / PAR30
- 88 on-board Hi Power LED diodes
- Up to 50,000 hour lamp life
- Very low heat output
- 5 year warranty
- Dimmable

LD1694 11W Pageant R30/65BR30/PAR30 Wide 105° Flood (Soft White) **\$64.95**

LD1695 11W Pageant R30/65BR30/PAR30 Wide 105° Flood (Daylight) **\$64.95**



7W PAGEANT MEDIUM BASE A19

Fully encapsulated, 120V, 7W, screw-in medium base mounting that integrates energy saving LED technology into a standard A19 format.

- Compare to 40W
- Soft White (2700K); Daylight (5500K)
- Up to 50,000 hour lamp life
- 5 year warranty

LD1010 7W Pageant Medium Base A19 (Soft White) **\$34.95**

LD1011 7W Pageant Medium Base A19 (Daylight) **\$34.95**

8W PAGEANT R20 WIDE 105° FLOOD

Fully encapsulated, 120V, 8W, screw-in R20 medium base mounting that integrates energy saving LED technology into a standard R20 format.

- Compare to 40W
- Soft White (2700K); Daylight (5500K)
- Up to 50,000 hour lamp life
- 5 year warranty

LD1714 8W Pageant R20 Wide 105° Flood (Soft White) **\$49.95**

LD1715 8W Pageant R20 Wide 105° Flood (Daylight) **\$49.95**

14W PAGEANT R40 WIDE 105° FLOOD

Fully encapsulated, 120V, 14W, screw-in R40 medium base mounting that integrates energy saving LED technology into a standard R40 format.

- Compare to 75W
- Soft White (2700K); Daylight (5500K)
- Up to 50,000 hour lamp life
- 5 year warranty

LD1716 14W Pageant R40 Wide 105° Flood (Soft White) **\$79.95**

LD1717 14W Pageant R40 Wide 105° Flood (Daylight) **\$79.95**

[See more LED lighting options online » www.HomeControls.com/EnergySavingLightBulbs](#)

Timer Controls

LEVITON

PLUG-IN TIMERS

PLUG-IN DIGITAL INDOOR TIMERS

New plug-in digital indoor timers are great for On/Off control of your home's lamps, portable fans, holiday lights and more. The user-friendly design is easy to program and shows the timer settings at a glance. Compatible with incandescent and energy smart CFL bulbs, these timers give you the flexibility to automate everyday tasks or to vary lighting for a lived-in look while you're away.

ADVANCED DIGITAL TIMER - 50 EVENTS PER DAY

A LVL11210W Leviton Advanced Digital Timer **\$21.95**

B LVL11310W Leviton Advanced Digital Timer with Tethered Remote **\$26.95**

STANDARD DIGITAL TIMER - 3 EVENTS PER DAY

C LVL11110W Leviton Standard Digital Timer **\$17.95**

D LVL11410W Leviton Standard Digital Table Top Timer **\$24.95**

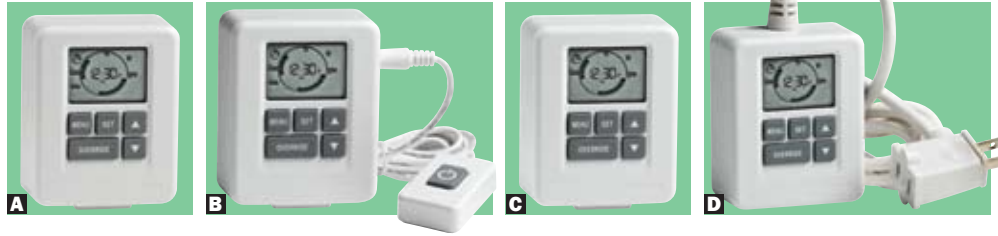

PLUG-IN WEEKLY TIMER

The Weekly Timer provides controls to reduce energy consumption of appliances, that do not include timing controls by ensuring that appliances are only run at required times. It is suitable for a wide range of appliances including: heaters, stand-alone air conditioning units, fans, water pumps, hot water urns, water coolers, photocopiers, pool pumps, signage and more!



TS505TTUSW TrickleStar Weekly Timer **\$24.95**

PLUG-IN DAILY TIMER

The TrickleStar Daily Timer ensures that appliances are only run at required times to significantly reduce energy consumption and vampire power wasted by appliances. It is suitable for water pumps, coffee machines, hot water urns, water coolers, lighting, pool pumps, stand-alone air conditioning units, fans, signage, photocopiers, water heaters, vending machines and heaters.



TS500TTUSW TrickleStar Daily Timer **\$12.95**

TIMER SWITCHES

PRESET TIMER SWITCHES

The robust selection of Leviton Decora Timer Switches provides convenient timed control of lighting and motor loads in homes, offices, schools, hotel rooms and other small commercial applications. An easy upgrade, automatic timers help reduce energy costs, improve security and add convenience.

- 20A inductive, 1800W incandescent, 1 HP
- Single pole or 3-way with a Vizia + remote switch
- Neutral wire required
- Single pole and 3-way available in each box
- Wallplate not included (see page 59)
- Color: White assembled on device; Ivory and Light Almond faceplates included.

LVLTB*1LZ Leviton Preset Timer Switch **\$34.95**

Choose From 15 Minutes, 30 Minutes, 1 Hour, 2 Hours And 12 Hours

CUSTOMER FAVORITE!



PROGRAMMABLE TIMER SWITCHES

Vizia+ 24 hour Timer 120VAC, 60HZ, 1800W Incandescent, 15A Resistive/Inductive, 1HP, for single pole, 3-way or more locations, with astronomic clock, backlit LCD display, timer settings at a glance, green LED locator.

- For indoor/outdoor lighting, fans and pool filters
- Neutral wire required
- Flexibility to program all days, weekdays, weekends or any combination of days
- Wallplate not included (see page 59)
- Color: White assembled on device; Ivory and Light Almond faceplates included.

LVP1241PZ Leviton Vizia+ Programmable Timer Switch **\$64.95**



Complete Product Details Online »
www.HomeControls.com/OccupancyTimerSwitches



ELECTRIC VEHICLE RECHARGING PRODUCTS

EVR-GREEN

Leviton has a long history of providing solutions for a greener environment. The Evr-Green electric vehicle recharging products continue that tradition. These innovative solutions help rapid expansion of the smart grid infrastructure and wide adoption of electric vehicles: a win-win for you and the planet. Whether you are an EV driver, a commercial business, utility company or municipality, there's an Evr-Green solution for you.

- Charging stations attach to the wall on the pre-installed bracket, and include an EV cable to connect to your vehicle
- Chargers are compatible with plug-in electric vehicles that comply with the SAE J1772 plug-in electric vehicle charging standard
- All Evr-Green chargers are indoor/outdoor rated

EVR-GREEN 160 HOME CHARGING STATION

Leviton's Evr-Green 160 Home Charging Station enables fast-charging of any SAE J1772 compatible electric vehicle. The patent pending mounting system allows for a do-it-yourself "plug-in" installation (When used in conjunction with one of Leviton's EVK Series Installation Kit)

- Compatible with all EVSE Standards and Recommended Practices, including SAE J1772, NEC 625, UL2231 and UL 2594
- Tool-less, non-permanent installation also makes it easier to remove and replace or take with you in the event that you move (when used in conjunction with Leviton's EVK Series Installation Kit)
- Built-in communication verifies proper connection before charging can commence
- Simple 1-button user interface, ADA compliant
- Auto-Reset feature enables charging to restart following a minor fault, thereby reducing the chance of being stranded with an undercharged battery
- Weatherproof NEMA Type 4 enclosure; safe for use in wet or dry locations
- Cord management bracket provides easy stowage of the charge connector when not in use
- Ground monitor circuit for safety

LVEVB223PM Leviton Evr-Green 160 Home Charging Station **\$1284.95**

LVEVK02M Leviton Evr-Green 160 Home Charging Station Pre-Wire Kit **\$89.95**

Motion-Activated Lighting Controls

OUTDOOR LIGHTS



SOLAR-POWERED FLOODLIGHTS

Lights automatically turn on when motion is detected at night. Easy DIY installation with no wiring. Includes 6V 4Ah sealed lead acid rechargeable battery. Adjustable motion sensor detects motion up to 35' away within a 180° detection area. 15' cable allows ideal location for solar panel and lets you mount the light inside, if desired.

- Perfect for entry ways, walkways, sheds, patios, balconies, decks, steps, garages, driveways, carports, backyards and farm sheds.
- When charged, light can activate up to 360 times

MX40225 80 LED Solar-Powered Motion-Activated Floodlight (White) **\$79.95** (Black also available)

MX40224 50 LED Solar-Powered Motion-Activated Floodlight (White) **\$69.95**

MX40110 30W Halogen Solar-Powered Motion-Activated Floodlight (White) **\$84.95**

MX40220 10W Halogen Solar-Powered Motion-Activated Floodlight (White) **\$74.95**

SOLAR-POWERED WEDGE LIGHT

Because of its unique shape and design, it can be placed on the ground or attached to a post or wall. Provide light when you are trying to unlock the door or in a place when it would normally be hard to mount a light! Detects motion up to 25' away with a 100° detection area.



- When charged, light can activate up to 300 times

MX40235 Solar-Powered Motion-Activated Wedge Light (White) **\$39.95**

DUEL HEAD SOLAR-POWERED FLOODLIGHT

Has dual heads to allow the light to cover a wide area. The light also has a swivel head sensor and dials to adjust motion sensitivity, light sensitivity, and light duration. The solar panel has a 9' cable so it can be mounted away from the light and motion sensor.



MX40218 Duel Head Solar-Powered Motion-Activated Floodlight (White) **\$54.95**

AVAILABLE COLORS
For Products On This Page



OCCUPANCY SENSORS

LEVITON OCCUPANCY SENSOR

Leviton's Occupancy Sensor can be used for automatic switching of incandescent lamps and fluorescent and low-voltage lighting with electronic or magnetic ballasts. The switch also features a manual override switch that can be used to keep lights Off while an area is occupied.

- Installs in place of a single-pole switch
- Requires ground connection
- 180° field of view; 2,100 square feet of coverage
- Colors: Choose White, Ivory or Almond
- Wallplate not included (see page 59)



A LVODS10ID Leviton Occupancy Sensor Switch **\$69.95**

A LVODS15ID Leviton Occupancy Sensor Switch, With Self-Adaptive Technology **\$74.95**

WITH NIGHT LIGHT • CEC TITLE 24 COMPLIANT!

A LVOSNLIID Leviton Occupancy Sensor Switch **\$64.95**

LEVITON MANUAL-ON OCCUPANCY SENSOR

You turn it On manually, and it switches itself Off once it detects that the room is vacant.

- Single pole; 3-Way with the Sensor Slave Switch
- Provides a 180° field of view with a maximum coverage area of 900 square feet
- Colors: Choose White, Ivory or Almond
- Wallplate not included (see page 59)

A LVIPV151LZ Leviton Occupancy Sensor Switch **\$39.95**

LVIPPOR1L Leviton Occupancy Sensor Slave **\$29.95**

HEATH ZENITH OCCUPANCY SENSOR

- Slide switch options: Auto, On, Offmodes
- Lights-on timer: 5 to 30 minutes (30 seconds in test mode)
- 150° motion detection angle
- Works with incandescent, halogen, compact fluorescent (CFL), fluorescent, and LED lighting
- Colors: Choose White or Ivory
- Wallplate included

E HZSL6115x Heath Zenith Occupancy Sensor Switch **\$24.95**



LEVITON OCCUPANCY SENSOR

- Ambient light override prevents switches from turning lights On when there is ample natural sunlight
- Manual override for use as a standard On/Off switch
- Adjustable shut-off delay of 15 seconds to 15 minutes
- Colors: Choose White or Ivory
- Wallplate not included (see page 59)

C LVPR1801L Leviton Occupancy Sensor Switch **\$29.95**
180° Field Of View, 400 Square Feet Of Coverage

C LVPR1501L Leviton Occupancy Sensor Switch **\$29.95**
150° Field Of View, 350 Square Feet Of Coverage

Save money by using lights only when they are needed. Motion-activated occupancy sensors increase convenience and improve everyday living.

MOTION-ACTIVATED PLUG

SENSORPLUG

SensorPlug is a motion activated plug-in electrical outlet. Its plug-in design eliminates wiring and associated expenses common to other motion activated products. The passive infrared (PIR) motion sensor offers the convenience of controlling many of the household electrical products – not just lighting – by motion.



AISP01 SensorPlug **\$15.99**

CUSTOMER FAVORITE!

MOTION-ACTIVATED ANYWHERE LIGHT

The Maxsa Anywhere Light turns on automatically at night to prevent stumbling and fumbling with keys. The Anywhere Light features 5 bright LED lights and is battery-powered. This Anywhere Light requires no electricity or wiring and is weatherproof. Use anywhere portable light is needed. The Maxsa Anywhere Light is adjustable 360° and includes a mounting bracket. It has a 10' detection radius.



- Uses 4 C-cell batteries (not included) that will last about a year

MX40230 Anywhere Light, Black **\$29.95**

MX40231 Anywhere Light, White **\$24.95**

UPB Lighting Controls



STANDARD SWITCHES

SAI STANDARD DIMMING TRANSCEIVER SWITCHES & IN-WALL CONTROLLERS

The SimplyBrilliant UPB Dimming Transceiver Switch with timer feature provides ultra-reliable control and timed off control of new and existing lighting fixtures, lamps, fans and other electrical devices. Each unit has one switch that controls a load of up to 900W. It can also transmit and receive lighting scene commands and status with other UPB switches, plug-in modules, fixture modules as well as any PC, security, home, automation controller to control virtually anything that connects to AC power anywhere in the home.

- Wallplate not included (see page 59)
- Faceplate Colors: Choose White, Ivory, Almond, Light Almond, Black or Brown

SAUS140 Standard Dimming Controller Base **\$69.95**

Requires SAZS11 Single Rocker Faceplate

SAZS11 Single Rocker **\$4.95**



UNIVERSAL SWITCHES

SAI UNIVERSAL DIMMING TRANSCEIVER SWITCHES & IN-WALL CONTROLLERS

Simply Automated's SimplyBrilliant Universal Dimming Transceiver Switches provide the same ultra-reliable control as the Standard Dimming Transceiver Switches, with greater design flexibility.

Units can be field-configured to accept any 1 of 13 different rocker/multi-button faceplates. Custom labels can be created for the multi-button faceplates by ordering the SAZLK01 inkjet/laser label kit in your desired color. And, all faceplates are interchangeable in the field without ever having to untwist a wire nut!

- On/Off control, 200 Dimming steps and Resume Dim
- Adjustable response time – turns on faster
- SimplySmart technology: multi-tap buttons or rockers for simple-n-easy lighting scene modification
- Interchangeable rocker assemblies – change color and functionality in the field
- Dedicated Remote Switch provides inexpensive 3 or more-way control

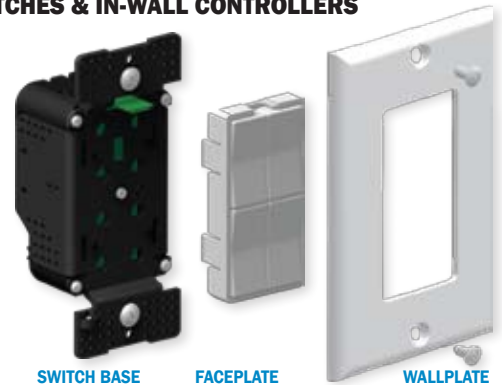

SWITCH BASE

FACEPLATE

WALLPLATE

- Wallplate not included (see page 59)
- Faceplate Colors: Choose White, Ivory, Almond, Light Almond, Black or Brown

TYPICAL APPLICATION

- **Upper Left Switch/Button Position** (1) controls a single load and is a UPB transceiver able to send/receive commands to/from other UPB devices
- **All Other Switch/Button Positions** are UPB transmitters able to activate individual UPB devices (switches or plug-in/fixture modules) or lighting scenes



STANDARD DIMMING CONTROLLER:
Standard Dimmer Switch Controller Base
With Single Rocker Faceplate (White)
SAUS1140W \$74.95

DEDICATED REMOTE CONTROLLER:
Dedicated Remote Switch Controller Base
With Single Rocker Faceplate (White)
SAUSR140AW \$29.95

SCENE SWITCH CONTROLLER:
Scene Switch Controller Base
With 4-Button Oval Faceplate (White)
SAUCQT40W \$99.95

SCENE SWITCHES

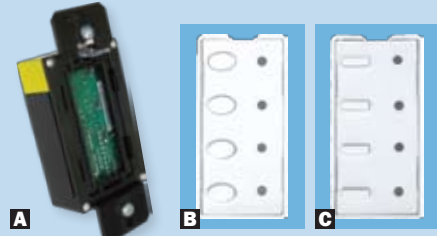

SAI SCENE SWITCHES

The SimplyBrilliant 4-button scene controller turns On/Off/Dims UPB devices by transmitting UPB scene links. Four green LEDs are configurable and indicate when a lighting scene is active or has been deactivated. Great for applications where the controlled light/loads are not visible

- Wallplate not included (see page 59)
- Faceplate Colors: Choose White, Ivory, Almond, Light Almond, Brown or Black.

SCENE SWITCH BASE (REQUIRES FACEPLATE)

A SAUCQT40 Scene Switch Controller Base **\$74.95**

SCENE SWITCH FACEPLATES

- B SAZS240S** Scene Faceplate, Oval **\$24.95**
- C SAZS24BS** Scene Faceplate, Bar **\$24.95**

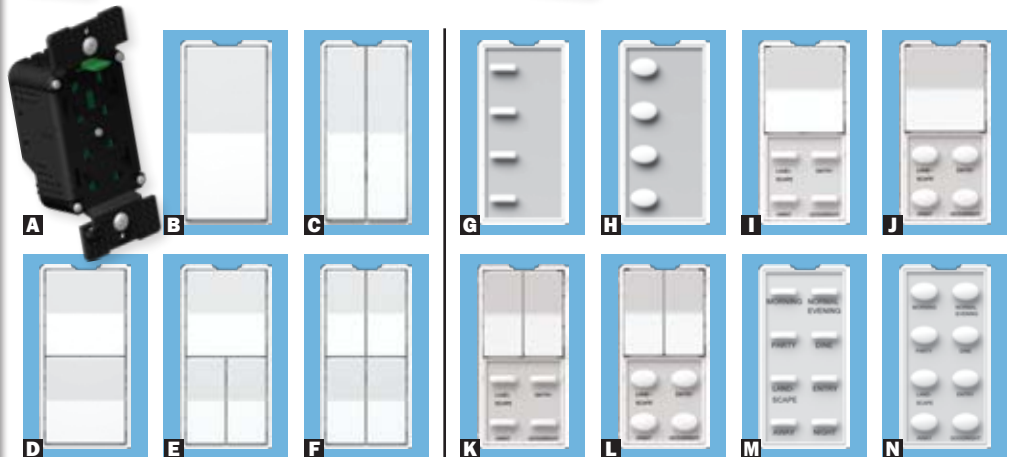

SWITCH BASES (REQUIRES FACEPLATE)

- A SAUS240** Universal Switch Base **\$79.95**
- A SAUS2240** Dual Circuit Universal Switch Base **\$179.95**
Controls 2 Separate Circuits, 2x550W & Countdown Timers
- SAUSR40A** Dedicated Remote Controller Base **\$24.95**
Compatible With SAZS11 or SAZS12 Faceplates only

ROCKER FACEPLATES

- B SAZS11** Single Rocker **\$4.95**
- C SAZS12** Dual Tall Rocker **\$14.95**
- D SAZS22** Dual Short Rocker **\$14.95**
- E SAZS23** Triple Rocker **\$19.95**
- F SAZS24** Quad Rocker **\$24.95**

BUTTON FACEPLATES

- G SAZS24B** 4 Buttons, thin bar **\$14.95**
- H SAZS240** 4 Buttons, oval **\$14.95**
- I SAZS25B** 4 Buttons, with 1 rocker, thin bar **\$19.95**
- J SAZS250** 4 Buttons, with 1 rocker, oval **\$19.95**
- K SAZS26B** 4 Buttons, with 2 rockers, thin bar **\$24.95**
- L SAZS260** 4 Buttons, with 2 rockers, oval **\$24.95**
- M SAZS28B** 8 Buttons, thin bar **\$24.95**
- N SAZS280** 8 Buttons, oval **\$24.95**

SAZLK01 Inkjet/laser label sheets, Pack of 10 **\$19.95**
Colors: Choose White, Ivory or Almond

AVAILABLE COLORS
For Products On This Page





Control Your UPB System With iHome iPhone App »
www.HomeControls.com/iPhone-Lighting-Control-Apps

UPB INSTALLATION SOFTWARE

While some basic UPB functions can be set via simple push buttons on the wall switches and modules, the power of UPB is best realized by using the Windows-based UPB configuration tool called UPStart. UPStart requires a UPB Interface Module to connect the PC to the powerline, which can be removed after configuring. Once installed, a UPB system can operate without a computer or central controller.

UPStart Is Available Free For Download on All UPB Product Listings » www.HomeControls.com/UPB-Lighting-Appliance-Controls



HLC SWITCHES FROM HAI



HAI LIGHTING CONTROL (HLC)

With HAI Lighting Control (HLC), you can experience all of the benefits of a sophisticated lighting control system that is affordable and retrofittable. HLC is a modular system, so you can easily add rooms or lights anytime, updating as your needs change. For retrofits or expansion, simply replace the existing light switch with an HAI switch.

- HLC uses Generation III UPB
- Switches feature true rocker action. Press and hold to brighten or dim. Press up to turn on. Press down to turn off
- Homeowners may easily change scene settings at any time without a service call
- LED indicator lights at the top of the switches can be programmed to glow Blue, Red, Magenta, or turned off entirely
- Expansion is easy!
- HLC can be integrated into any Omni or Lumina automation control system (see pages 26-28)
- Wallplate not included (see page 29)



HLC DIMMER SWITCHES

- Color: White (Color change kits available)

- A HA35A001** HLC Dimmer, 600W **\$69.95**
- A HA35A003** HLC Non-Dimmer, 600W **\$69.95**
- HA40A001** HLC Relay Switch, 15A **\$89.95**
- HA55A001** HLC Dimmer, 1,000W **\$149.95**
1,000W Also Available In Almond, Black Or Brown
- HA55A002** HLC Dimmer, 1,500W **\$289.95**
- HA55A003** HLC Dimmer, 2,400W **\$349.95**

HLC SCENE SWITCH

Control all lights in a room or area – On or Off, Dimmed, Brightened, and set to 4 different scenes. Setting a scene is as simple as pressing the scene button on the Scene Switch 5 times.

- Color: White (Color change kits available)

- E HA38A001** HLC Scene Switch **\$124.95**
- HA38A16** HLC Scene Tabletop Switch **\$169.95**

HLC STATUS SWITCHES

This master control shows the status for up to 8 rooms. If any light is On, the button for that room is illuminated.

- Color: White (Color change kits available)

- G HA38A002** HLC House Status Switch **\$149.95**

HLC SWITCHES & REMOTES

- HA40A001** HLC Relay Switch, 15A (White) **\$89.95**
UPB Relay Switch Used For Controlling Heavier Loads Or Motors, Such As Ceiling Fans, That May Hum When Used With Dimming Or Non-Dimming Switches
- HA37A001** HLC Auxiliary Switch (White) **\$27.95**
For Remote Operation Of HA35A00, HA40A00 & HA55A00

PULSEWORX UPB LIGHTING CONTROLS



PULSEWORX DIMMER SWITCHES

Fully programmable, the PulseWorx Dimmer Switch can be configured for On/Off only operation to behave like a switch, with multiple ramp rates and LED colors, or even as a transmitter so that it may control other UPB devices.

- Colors: Choose White, Ivory, Almond, Black, Brown or Grey
- Wallplate not included (see page 59)

WS1D: The WS1D is perfect for controlling incandescent, fluorescent, inductive and magnetic low voltage loads.

- PCWS1D6** Dimmer Switch, 600W/5A **\$138.29**
- PCWS1D10** Dimmer Switch, 1000W/8A **\$162.10**
- PCWS1D15** Dimmer Switch, 1500W/12.5A **\$333.76**
Special Wallplate Included

- PCWS1D24** Dimmer Switch, 2400W/20A **\$429.11**
Special Wallplate Included

WS1E: The WS1E is perfect for controlling electronic low voltage AC lighting ballasts and transformers.

- PCWS1E3** Dimmer Switch, 300W **\$277.50**
- PCWS1E5** Dimmer Switch, 500W **\$333.00**

FOR THREE-WAY OR MULTI-WAY LIGHTING CONTROL

- PCRWs** Auxiliary Remote Dimmer Switch (For WS1 Switches) **\$55.50**



5 Year Warranty!

PULSEWORX KEYPAD CONTROLLERS & DIMMERS

The Keypad Load Dimmer is an all-in-one Keypad Controller and Light Dimmer. It incorporates the functionality of our KPC Keypad Controllers and a 400W Dimmer Switch.

- Colors: Available in White, Ivory, Almond, Light Almond, Brown or Grey
- Wallplate not included (see page 59)

- A PCKPLD6** PulseWorx Keypad Load Dimmer, 6 Button **\$342.25**
- B PCKPLD8** PulseWorx Keypad Load Dimmer, 8 Button **\$342.56**



PULSEWORX KEYPAD CONTROLLERS

The 6- and 8-Button Keypads can control single lights, trigger dramatic scenes, or send messages to a central controller. Select from 16 commands to be transmitted when each push button is tapped, double-tapped, held or released. Both types are IR compatible.

- Colors: Choose White, Ivory, Almond, Black, Brown or Grey
- Wallplate not included (see page 59)

- A PCKPCW6** PulseWorx KPC Wall Controller, 6-Button **\$257.15**
- B PCKPCW8** PulseWorx KPC Wall Controller, 8-Button **\$257.15**

AVAILABLE COLORS

For Products On This Page



UPB Plug-In Modules

LAMP MODULES

UPB LAMP MODULES

This plug-in module controls the operation of 120VAC incandescent lamps based on digital commands received over the powerline.

- On/Off and Dimming control
- Plugs into a standard outlet
- Controlled lamp plugs into the bottom; non-controlled outlet provided on the face of the module
- Color: White

- A SAUML20W** SAI Lamp Module (Timer), 400W **\$74.95**
- A SAUMLEW** SAI UPB Lamp Module, 300W **\$64.95**
- A PCLM14** PulseWorx Lamp Module, 400W **\$120.25**
- D HA59A001** HAI UPB Lamp Module **\$69.95**

2 Channel: Provides 800W at any one time split between 2 channels. Plug the module into any standard wall outlet and plug lamps into the 2 bottom outlets.

- B PCLM28** UPB Lamp Module, 2-Channel **\$222.00**



APPLIANCE MODULES

UPB APPLIANCE MODULE

This plug-in module controls the operation of 120VAC appliances, motors and fluorescent lamps based on digital commands received over the powerline.

- On/Off control for appliances
- Plugs into a standard outlet
- Controlled device plugs into the bottom; non-controlled outlet provided on the face of the module
- Color: White

- C SAUMA20W** SAI UPB Appliance Module (with Timer), 15A **\$74.95**
- C SAUMAEW** SAI UPB Appliance Module, 12A **\$64.95**
- C PCAM112** PulseWorx UPB Appliance Module, 12A **\$120.25**
- D HA60A001** HAI UPB Appliance Module **\$89.95**



FOLLOW THE MOST UP-TO-DATE AUTOMATION NEWS
Read About New Releases & More at www.HomeControlsBlog.com

INTERFACE MODULES

UPB POWERLINE INTERFACE MODULE (PIM)

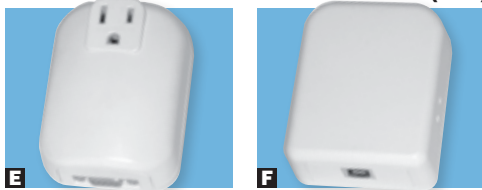

These plug-in modules enable computer-based control of household lighting, appliances and other devices over the powerline.

- Plugs into standard outlet

- E SAUMCDB9W** SAI UPB PIM, RS232 **\$84.95**
Has A Non-Controlled Power Outlet On The Module Face
- F SAUMCUSBW** SAI UPB PIM, USB **\$84.95**



- G PCPIMR** PulseWorx UPB PIM, RS232 **\$166.50**
- H PCPIMU** PulseWorx UPB PIM, USB **\$185.00**
- ELKUSB232** RS232-to-USB Cable **\$34.95**

Addressable PIM designed to provide an assigned Unit ID for any RS232 controller in an UPStart network file.

- G PCPIMA** PulseWorx UPB Addressable PIM **\$166.50**

UPB INPUT/OUTPUT MODULE

Identifies and transmits the status of low voltage inputs and contact closures, and controls the operation of low-power actuators based on digital commands.

- Detects events such as a ringing phone or doorbell, monitors alarm outputs, switches on doors and windows, or senses signals from a sound system
- Outputs deliver On/Off control for low-power electrical devices.



- SAUMI32W** SAI UPB 3 Input/2 Output Module **\$84.95**
- PCICM** PulseWorx UPB Input Module **\$185.00**
- PCOCM** PulseWorx UPB Output Module **\$185.00**

UPB Wire-In Modules

SAI UPB RECEPTACLE

A wire-in duplex receptacle designed to control the operation of 120VAC appliances and lighting.

- Provides On/Off and timed control for lighting and appliances up to 12A
- Power to the top outlet is controlled by UPB; bottom outlet is always powered
- Wallplate included
- Colors: Choose White, Ivory, Light Almond or Almond



- SAURD30** UPB Receptacle **\$84.95**

AVAILABLE COLORS
For Products On This Page

- WHITE
- IVORY
- ALMOND

SAI UPB FIXTURE DIMMER & FIXTURE RELAY

UPB Fixture Dimmers and Fixture Relays are wire-in modules designed to control remote lighting and ceiling fixtures.

- Dimmers deliver On/Off and Dimming for lamps up to 300W
 - Relays deliver On/Off control for appliances up to 12A
- These modules fit easily inside a standard outlet box. Fixture modules connect directly to the existing household power wiring. A traveler wire allows operation with a remote switch.

- SAUFR30** UPB Fixture Relay Module (with Timer) **\$84.95**
- SAUFD30** UPB Fixture Dimmer Module (with Timer) **\$84.95**

PULSEWORX UPB FIXTURE DIMMER & FIXTURE RELAY

- PCFMD24** UPB Fixture Dimmer Module, 2 Output, 400W **\$166.50**
- PCFMR120** UPB Fixture Relay Module, 20A **\$166.50**



UPB TIMED CONTROLS

SAI UPB SCHEDULER-TIMER

This UPB Scheduler-Timer is easy to program. Once the unit is set for time, date and location (zip code or latitude and longitude) there are only 2 displays needed to add devices, link scenes and set up events. The UPB Scheduler-Timer automatically adjusts time referenced to the nationally synchronized power grid; it knows when daylight savings and leap years occur and even when the sun rises and sets for your location.

- No computer interface required
- Easy push button and display to set time and control devices (events)
- 250 devices and 99 events
- Schedule modes: On, Off, Vacation, All On and All Off
- Each device event can function as On/Off, Dim, scenes and random
- Real-time clock maintains time in the event of a power outage for up to one week
- Includes power cord for tabletop and right angle power plug for outlet mount



- Doubles as a Computer Interface Module (CIM) allowing connection of a PC with UPStart to a UPB network
- UPB reliability and compatible with a variety of devices and controllers

SAUCS01 UPB Controller, Scheduler-Timer **\$159.95**

PULSEWORX TIMED EVENT CONTROLLER

The Timed Event Controller (TEC) is an automation timer device that transmits and receives digital commands and status over the existing powerlines at preset times. Designed in a small plug-in enclosure. The TEC can be programmed to control single lights, trigger dramatic scenes, or send messages to a central controller.



The TEC stores up to 20 individual timed events. Each event can be configured to occur daily, during the work week, on weekends, on specific days of the week, or on a specific day of the year. Event times can be specified as absolute times or relative to sunrise or sunset times.

PCTEC Timed Event Controller **\$277.50**

UPB TABLETOP KITS



TABLETOP PEDESTAL KITS

- Includes power cord
- Colors: Choose White or Black

A SAUS2TP Tabletop Pedestal with SAI Universal Transceiver Switch Base **\$84.95**

Requires Faceplate, SAZSxx Series, See Page 10

B SAUS20TP Tabletop Pedestal with SAI 8-button Universal Transceiver Switch **\$119.95**

SAUSQT Tabletop Pedestal with SAI 4-button Scene Switch, Oval **\$119.95**

PCKPCD6 Tabletop Pedestal with PulseWorx 6-Button Keypad Controller Switch **\$286.75**

PCKPCD8 Tabletop Pedestal with PulseWorx 8-Button Keypad Controller Switch **\$286.75**

HA38A16 Tabletop Pedestal with HAI Scene Switch **\$169.95**

TABLETOP PEDESTAL CONVERSION KITS

- Includes power cord and assembly hardware.
- Colors: Choose White or Black

SAZTP2 SAI Tabletop Pedestal Kit **\$24.95**

Converts any SimplyBrilliant Switch into a plug-in tabletop controller

HA38A15 HLC Tabletop Pedestal Kit **\$30.95**

Converts any HAI Scene Switch or House Status Switch into a plug-in tabletop controller

REMOTE CONTROL OF UPB SYSTEMS



REMOTE UPB CONTROLLER

The new Remote Universal Controller is the most advanced remote UPB setup, management and trouble-shooting appliance on the market today, and now it also supports Z-Wave, X10 and ESI drapery controllers! Run UPStart from your desktop so you can manage, setup, change and trouble-shoot the UPB network at your office or your customer's home.

Any other remote access device has to replicate all of UPStart's setup, management, trouble-shooting and diagnostic capabilities. Not so with the Remote Universal Controller - just run the latest version of UPStart on your local PC and you will be able to apply new UPStart features immediately.

There are smartphone apps already available for the RUC, but its ability to generate or accept HTTP Post requests makes it a natural building block in a diverse TCP/IP control network. It maintains the current date, automatically adjusts for daylight savings time and leap year, can control events based on local sunset and sunrise, and utilizes flash memory to ensure the correct operation of all functions after power outages.



WMRUC01K Web Mountain Remote UPB Controller Kit **\$269.95**

Includes Remote UPB Controller & Interface Module

CUSTOMER FAVORITE!

SIMPLY SMART PRE-CONFIGURED KITS

SAI UPB PRE-CONFIGURED KITS

Utilizing SimplySmart technology, the UPB Dimmer and Lamp Module Pre-Configured Starter Kits come programmed at more than a 10% savings! Custom scenes, connecting up to 250 switches in the living, family or great room, kitchen, study, master bedroom/bathroom and office. Turn off all lights in your home at the touch of a button.

- Homes should be no more than 2,500 sq. ft. and have only one breaker panel, or install phase coupler (model SAZPCI) for larger homes
- Wallplates not included (see page 59)



A SADKIT01 UPB Dimmer Pre-Configured Starter Kit **\$224.95**

Includes 2 Standard Single Rocker Dimmers & 1 Deluxe Dimmer Controller Base With Single Rocker & 4 Button Faceplate

SADKIT02 UPB Lamp Module Pre-Configured Starter Kit **\$179.95**

Includes 2 Lamp Modules & Tabletop Pedestal With 4-Button Faceplate

Find Even More UPB Pre-Configured Kits Online » www.HomeControls.com/UPB-Kits



UPB PHASE COUPLERS & REPEATERS

SAI UNIVERSAL INVERTING PHASE COUPLERS

To ensure the most reliable installation, an inverting phase coupler is recommended for every breaker panel in a 2-phase home. Inverting phase couplers provide higher signal levels between phases and also pass X10 and broadband.

A SAZPCIW Inverting Phase Coupler, wire-in **\$69.95**

SAZPCIB Inverting Phase Coupler, breaker panel **\$69.95**

Fits Cuttler-Hammer, Square-D, Murray, GE

B SAZPCIP30A Inverting Phase Coupler, plug-in, 30A **\$79.95**

B SAZPCIP50A Inverting Phase Coupler, plug-in, 50A **\$79.95**

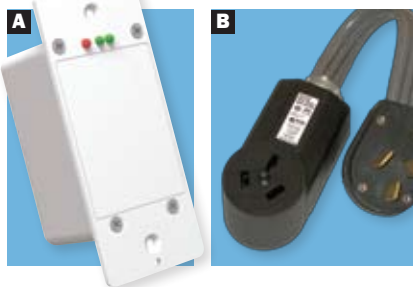

PULSEWORX PHASE COUPLERS

PCPPC1 PulseWorx Passive Phase Coupler, wire-in **\$92.50**

PCPPC3 PulseWorx Passive Phase Coupler, plug-in, 3 prong **\$129.50**

HAI PHASE COUPLER

HA39A001 HAI HLC Phase Coupler, wire-in **\$59.95**

3-PHASE REPEATERS

The 3-Phase Repeater is specifically designed to repeat a UPB message onto phases of an AC powerline (3-Phase AC Powerline). It is capable of receiving a UPB message on 1 of the phases and repeating it onto all 3 phases.

SAUTR SAI 3-Phase Repeater **\$359.95**

PCTPR120 PulseWorx 3-Phase Repeater **\$601.25**

HA39A003 HAI 3-Phase Repeater **\$424.95**

SPLIT PHASE REPEATERS

Increase powerline communication reliability by taking UPB messages transmitted on one phase (leg) and strongly repeating them onto the other phase (leg).

PCSPR1 PulseWorx Split Phase Repeater, wire-in **\$416.25**

HA39A002 HAI Split Phase Repeater, wire-in **\$309.95**

PCSPR3 Split Phase Repeater, plug-in, 3 prong **\$416.25**

PCSPR4 Split Phase Repeater, plug-in, 4 prong **\$416.25**

UPB TO X10 BRIDGES & CONTROLLERS

X10/UPB COMPACT BRIDGE

- Add UPB devices to your X10 system
- Add X10 devices to your UPB system
- Operates alone or attached to legacy X10 controller
- Supports UPB and X10 extended and scene commands

FS100011003 X10/UPB Compact Bridge **\$114.95**



X10/UPB/FGI BRIDGE

All Compact Bridge capabilities, plus:

- Bridges X10 and UPB systems to FGI hard-wired devices
- Run-time monitoring, control and data logging from PC

FS100022003 X10/UPB/FGI Bridge **\$164.95**

FSFG024300 FGI Temp Sensor,

Transition Input **\$44.95**

FSFG02400010 FGI Temp & Humidity Sensor,

Transition Input **\$69.95**

FSFG03202000 FGI Quad Input/Quad Relay

& Solenoid Driver Output **\$49.95**

FSFG032060 FGI Octal Input/Quad Relay Output,

Non-latching **\$89.95**

FSFG056008 FGI 16 Security Input Sensor,

8 Transition Inputs **\$84.95**

X10 & UPB COMPACT CONTROLLERS

- Single protocol automation controller
- Supports UPB and X10 extended and scene commands
- Run-time monitoring, control and data logging from PC
- Open interface protocol supports programs you write
- Intuitive configuration of device interactions
- Extensive timer, macro and operating mode capabilities
- Native monitoring, control and configuration access via LAN, wireless LAN and the Internet

FS100011083 UPB Compact Controller **\$149.95**

FS100011081 X10 Compact Controller **\$149.95**

FS100033083 X10/UPB/FGI Bridge Plus **\$184.95**

Has Features Of Bridge & Compact Controller Combined, Plus Double The Memory

PULSEWORX X10-TO-UPB BRIDGE

The X10-to-UPB Bridge is a small plug-in device that converts standard X10 formatted messages into corresponding UPB signals, and then transmits over the existing powerlines to control UPB devices.

Ideal for integrating UPB devices with an X10 security system.

PCPW513 X10 to UPB Bridge **\$166.50**



PULSEWORX X10-TO-UPB CONVERTER

The X10-to-UPB Converter is a small plug-in device that converts standard X10 formatted messages sent on the AC powerline into corresponding UPB signals to control your UPB devices. Ideal for indoor home use.

PCXPW713 X10-to-UPB Converter **\$185.00**



BARGAIN HUNTING FOR HOME AUTOMATION PRODUCTS
Online Specials Exclusively At www.HomeControls.com/Specials

CONTROL UPB WITH IR

IR UPB MODULE

Gain additional control over a UPB system by simply using your IR remote control. The IR UPB Module transmits any UPB command triggered by a single incoming IR code from almost any hand-held remote controller. Both IR and UPB codes are learned by the IR UPB Module from external transmitting devices.

- Includes UPB Powerline Interface

MIIRUPBM IR-to-UPB Interface Module **\$174.95**



CONTROL UPB WITH ENOCEAN

RF UPB MODULE

Receive RF code from any EnOcean device and translate into a UPB signal. This allows control from any location with any EnOcean RF switch, remote or sensor.

EnOcean is an RF communication and hardware standard that uses kinetic energy to charge a built-in capacitor which in turn broadcasts the RF code. See page 19 for EnOcean products.

PCRPIE EnOcean-to-UPB Interface Module **\$187.50**



Complete Lines Of UPB Lighting & Appliance Control Systems Online » www.HomeControls.com/UPB-Lighting-Appliance-Controls

SimpleWorx Lighting

SimpleWorx is a revolutionary digital point to points control product that cost-effectively gives you basic On/Off lighting control. SimpleWorx is powered by SPC (Simple Powerline Communication). SPC provides super reliable 1-Way control of lights and appliances using your home's existing electrical wires and offers significant benefits above older powerline technologies or traditional wired and RF solutions.

SimpleWorx offers a variety of transmitter and receiver devices, which are all super easy-to-install and set-up. Pushing a button on each device is all that is needed to set-up your system.

KEYPAD TRANSMITTER

The Keypad Transmitter is a wall mounted controller that allows you to control up to four groups of SimpleWorx receivers anywhere in your home or office. Each group can have one or multiple receivers. The keypad instantly communicates to the desired group of devices associated with the button. All devices listen for commands and react by turning their connected lights/loads on/off accordingly.

- Controls up to four groups of receivers
- Each group can have one or multiple receivers
- Mounts in any standard single-gang electrical box
- Color: Black

PCSWXKPT4 SimpleWorx Keypad Transmitter **\$111.00**

DESKTOP KEYPAD TRANSMITTER

Desktop Keypad Transmitter (DKT4) is a tabletop controller which provides control of four groups of SimpleWorx receivers anywhere in your home or office. Each group can have one or multiple receivers. The DKT4 plugs into a standard electrical outlet.

PCSWXDKT4x SimpleWorx Desktop Keypad Transmitter **\$166.50**



WALL & DESKTOP SWITCHES

SimpleWorx wall switches provide fingertip control of present lighting, while also giving you the power to control other SimpleWorx receivers or be remotely controlled by SimpleWorx transmitters. Wall-mounted switches fit into a standard electrical box and the desktop model makes access more convenient.

- Three-Way ready
- Colors: Choose from White, Light Almond, Almond, Ivory, Black, Brown and Gray.

PCSWXWSTAC10x SimpleWorx Wall Switch Transmitter, 10A **\$101.75**

PCSWXWSTAC20x SimpleWorx Wall Switch Transmitter, 20A **\$138.75**

PCSWXWSRAC10x SimpleWorx Wall Switch Receiver, 10A **\$103.60**

PCSWXWSRAC20x SimpleWorx Wall Switch Receiver, 20A **\$111.00**

DESKTOP SWITCHES

PCSWXDSTAC10x SimpleWorx Desktop Switch Transmitter, 10A **\$138.75**

PCSWXDSRAC10x SimpleWorx Desktop Switch Receiver, 10A **\$148.00**



ADD-ON RF SWITCHES

WIRELESS SWITCHED OUTLET

- Adds a switched outlet, without additional wiring
- Receiver plugs into a standard 15 or 20A outlet
- Uses wireless RF to turn lamps or appliances On and Off from anywhere in the home
- Leviton switch operates up to 50'; Heath Zenith switch operates up to 100'.
- Wallplate included
- Colors: Leviton available in White; Heath Zenith available in White or Ivory.



LV6697W Leviton Wireless Outlet, Decora-Style **\$34.95**
HZBL6136W Heath Zenith Wireless Outlet, Toggle-Style **\$23.95**

WIRELESS SWITCH

- The receiver replaces an ordinary switch, and wires up like a single-pole switch
- Uses RF to turn lights On and Off, from two locations
- Leviton switch operates up to 50'; Heath Zenith switch operates up to 100'.
- Wallplates included
- Colors: Leviton available in White; Heath Zenith available in White or Ivory.



CUSTOMER FAVORITE!

LV6696W Leviton Wireless Switch, Decora-Style **\$34.95**
HZBL6133W Heath Zenith Wireless Switch, Toggle-Style **\$24.95**

FIXTURE MODULES

Fixture Modules are small wire-in self contained devices which are an ideal solution to trigger or remotely control complete circuit loads or fixtures that may not have a direct connection to an existing switch with a neutral wire.

- Easy 3 wire installation

PCSWXFMTxC SimpleWorx Fixture Module Transmitter **\$111.00**
 Choose 120V AC Input or Closed Contact Input

PCSWXFMRC SimpleWorx Fixture Module Receiver **\$111.00**

FLATPAC MODULES

FlatPac Modules are excellent for any application which requires high voltage switching through high or low voltage input wires. They provide a way to interface with any maintained dry contact closure or to sense 120VAC, to control other SimpleWorx receivers.

PCSWXFPTxC SimpleWorx FlatPac Transmitter **\$138.75**
 Choose 120V AC Input or Closed Contact Input

PCSWXFPRC SimpleWorx FlatPac Receiver **\$138.75**

PLUG-IN MODULES

The Plug-in Modules are perfect for controlling plug-in loads, such as pumps, valves, gates and just about anything up to a 15A load or needs a contact closure. All without the need for control wires.

- Simple installation, just plug it in to any grounded 120V outlet

PCSWXPMTCC SimpleWorx Plug-In Transmitter **\$157.25**

PCSWXPMRAC SimpleWorx Plug-In Relay **\$92.50**

PCSWXPMRCC SimpleWorx Plug-In Receiver **\$138.75**

MAGIC TAP

MAGIC TAP

Tired of fumbling in the dark for your lamp's turn-switch under the lampshade? With this kit, you can add two more ways to turn on/off that light. The Magic Tap button can be placed on a nearby table or countertop for tap-of-your-finger control. The button even has a built-in adjustable night light to help guide you through the dark.

The optional Remote Transmitter allows you to wirelessly control your connected light up to 50' away. Simply press the button on the remote to activate the plug-in receiver, and presto, the light turns on/off.

SKMT90 Skylink Magic Tap Touch Dimmer **\$17.95**
SKMT200 Skylink Magic Tap Touch Dimmer with Remote **\$24.95**



AVAILABLE COLORS

For Products On This Page



Z-Wave Lighting Controls

LEVITON VIZIA RF +

LEVITON

The Vizia RF + product family captures the essence of smart lighting control with its embedded Z-Wave radio frequency technology and stylish form factor. Vizia RF + features wireless communication, 2-way control, scene and zone control and remote control operation. Vizia RF + products give homeowners the ability to control lighting and select household devices with the touch of a button. And it does it all by simply replacing standard switches with intelligent Vizia RF + components.

- Convenient: Press a button to turn on groups of lights in or around your home
- Ready to Install: No need for complex and expensive rewiring. Simply replace existing switches with dynamic 1, 2, or 4-button control.
- Adaptable: Customize the system for your lifestyle
- Compatible: Works with Z-Wave devices like shades, thermostats and more to create a complete home control system

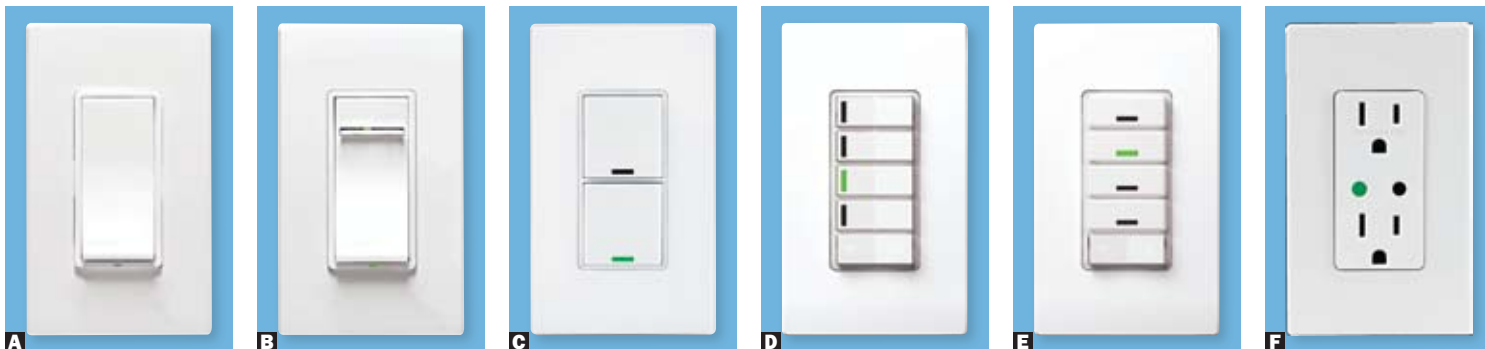

VIZIA RF + SWITCHES

Vizia RF + Scene Capable Switches provide local and remote On/Off switching for Incandescent, Fluorescent, Electronic Low Voltage and Magnetic Low Voltage lighting loads (5A switch is for Incandescent loads only).

A LVVRS151LZ Vizia RF + Switch, 15A **\$104.95**

15A Scene Capable Switch for single pole, 3-way or more applications

A LVVRS051LZ Vizia RF + Switch, 5A **\$94.95**

5A Incandescent Scene Capable Switch for single pole, 3-way or more applications

VIZIA RF+ DIMMERS

Vizia RF + Scene Capable Dimmers provide local and remote On/Off/Dim/Bright control for Incandescent, Electronic Low Voltage and Magnetic Low Voltage lighting loads. Vizia RF + Dimmers also provide scene control capability.

B LVVRI061LZ Vizia RF + Dimmer, 600W **\$94.95**

600W Incandescent Scene Capable Dimmer for single pole, 3-way or more applications, with LED locator and brightness display.

B LVVRI101LZ Vizia RF + Dimmer, 1000W **\$114.95**

1000W Incandescent Scene Capable Dimmer for single pole, 3-way or more applications, with LED locator and brightness display.

B LVVRE061LZ Vizia RF + Electronic Dimmer **\$239.95**

600W Electronic Low Voltage Scene Capable Dimmer for single pole, 3-way or more applications, with LED locator and brightness display.

B LVVRM11LZ Vizia RF + Magnetic Dimmer **\$179.95**

1000VA Magnetic Low Voltage, 1000W Incandescent and Mark 10 Scene Capable Dimmer for single pole, 3-way or more applications, with LED locator and brightness display.

DIMMER REMOTES

B LVVP00R1LZ Vizia Matching Remote **\$24.95**

120VAC Matching Dimmer Remote to 120VAC Dimmers/Fan Speed Control for 3-way or up to 5 location applications with LED locator and brightness/fan speed display.

LVVP00R10Z Vizia Coordinating Remote **\$20.95**

120VAC Coordinating Dimmer Remote to 120VAC Dimmers/Fan Speed Control for 3-way or up to 10 location applications (No LEDs).

VIZIA RF + FAN SPEED CONTROL

Vizia RF + Quiet Fan Speed Control ensures quiet fan control with 3 operation levels: low, medium and high.

B LVVRF011LZ Vizia RF + Fan Speed Control **\$159.95**

1.5A Scene Capable Quiet Fan Speed Control for single pole, 3-way or more applications, with LED locator and fan speed display.

VIZIA RF + CONTROLLERS

Vizia RF + Wall Controllers are ideal for remote control of one or multiple Vizia RF + scene-capable devices.

- 1-button controllers are ideal for control of a single zone or lighting scene
- 2-button controller provides remote control of two lighting scenes as well as On/Off switching for two lighting loads in one wallbox
- 4-button controllers provide remote control of four zones or lighting scenes as well as On/Off switching for one lighting load

A LVVRC11LZ Vizia RF + 1-Button Scene Controller **\$84.95**

1-Button Scene Controller/Virtual Switch Remote 3-way RF Controller for multi-location control, with LED locator.

B LVVRC21LZ Vizia RF + 1-Button Zone Controller **\$84.95**

1-Button Zone Dimming Controller/Virtual Dimming Remote 3-way RF Controller for multi-location control, with LED locator and brightness display

C LVVRC2MRZ Vizia RF + 2-Button Scene Controller **\$164.95**

2-Button Scene Controller with Switches for Multi-Location Scene Control.

D LVVRC24MRZ Vizia RF + 4-Button Zone Controller with Switch, 1800W **\$219.95**

4-Button Zone Controller with Switch for Multi-Location Control with IR Remote.

LVVPZLBZ4 Vizia RF + 4-Button Scene Controller Label Kit **\$59.95**

E LVVRC4MRZ Vizia RF + 4-Button Scene Controller with Switch, 1800W **\$219.95**

4-Button Scene Controller with Switch for Multi-Location Scene Control with IR Remote.

LVVPSLBS4 Vizia RF + 4-Button Scene Controller Label Kit **\$49.95**

VIZIA RF + SCENE CAPABLE RECEPTACLE

F LVVRR151LZ Vizia RF + Scene Capable Receptacle **\$124.95**



Coordinate your home's lighting with non-RF Vizia switches and dimmers.



White face assembled on all Vizia devices; Ivory and Almond faces also included. Color Change kits available for all Vizia switches and controllers in White, Light Almond, Ivory, Brown, Black, Grey and Red.



Compatible with Leviton's Decora Wallplates (not included). See page 59.

AVAILABLE COLORS
For Products On This Page



Color Change
Kits Available



Control Your Z-Wave System With Z-Wave Commander iPhone App »
www.HomeControls.com/iPhone-Lighting-Control-Apps



Z-WAVE MODULES

VIZIA RF + PLUG-IN MODULES

- A LVVRP031LW** Vizia RF + Lamp Module **\$84.95**
- LVVRP151LW** Vizia RF + Appliance Module **\$84.95**
- B LVVRCOP1LW** Vizia RF + Interface Module (ASCII to Z-Wave) **\$129.95**



Z-WAVE SMART ENERGY SWITCH

The Aeon Labs Smart Energy Switch is a low-cost Z-Wave appliance switch which can report immediate wattage energy usage or kWh energy usage over a period of time.

AEDSC06106ZWUS Aeon Labs Z-Wave Smart Energy Switch **\$59.95**

Z-WAVE PROGRAMMING SYSTEMS

LEVITON THINKESSENTIALS

ThinkEssentials Professional Edition by Control Think is the premier programming tool available for the Z-Wave Professional Installer. Packed with exclusive (patent-pending) features, ThinkEssentials is a full suite of powerful tools to install, optimize, integrate and maintain a high-performance Vizia RF + Home Control System.

LVCTEP20W Leviton ThinkEssentials Professional **\$134.95**
 Includes Software & USB Stick



AEON LABS Z-STICK SERIES 2

The Aeon Labs Z-Stick Series 2 is a self-powered Z-Wave USB dongle with push button for remote network creation (independent from external power and host microprocessor). When attached to a host processor, it becomes a Z-Wave communication device, which exposes the Zensys API (SerialAPI) through integrated USB.

This device is meant primarily to allow a host processor to control up to 232 Z-Wave devices using the Z-Wave technology protocol all while simplifying Z-Wave network installation.

Aeon Labs Z-Stick Lite: The Aeon Labs Z-Stick is a Z-Wave USB dongle. When attached to a host processor, it becomes a Z-Wave communication device, which exposes the Zensys API (SerialAPI) through integrated USB. This device is meant primarily to allow a host processor to control up to 232 Z-Wave devices using the Z-Wave technology protocol all while simplifying Z-Wave network installation.

AEDSA02203ZWUS Aeon Labs Z-Stick Series 2 **\$59.95**
AEDSA07203ZWUS Aeon Labs Z-Stick Lite **\$44.95**



TRICKLESTAR Z-WAVE USB STICK

With this product and application software you will be able to control a range of Z-Wave devices. The TrickleStar Z-Wave USB Stick allows control and monitoring of Z-Wave enabled products from a USB port device such as a Gateway, Set Top Box or a PC. The Z-Wave USB Stick can be used with a wide range of PC and Apple Mac Home Control software available on the market. Third party support for HomeSeer, Control Think and more.

TS300ZW TrickleStar Z-Wave USB Stick **\$34.95**



Program & Control Your Z-Wave Network With HomeSeer »
www.HomeControls.com/HomeSeer



Heavy Duty Relay for Z-Wave systems.
 See Page 24.



Operate Z-Wave with HAI Omni Controllers.
 See Page 26.



Integrate Z-Wave into an Elk M1 System.
 See Page 31.

Z-WAVE REMOTES

VIZIA RF + REMOTES

A Vizia RF + Programming Device or Vizia RF + Installer Tool is required as an installation tool for the setup of a Leviton Vizia RF + network.

A LVVRCPG0SG Vizia RF + RF Remote **\$219.95**
 Handheld Remote Controller Programmer/Timer.

A LVVRCPGBSG Vizia RF + RF Remote **\$184.95**
 Handheld Remote Controller Programmer (Basic)

B LVVRRM1SG Vizia RF + IR Remote Controller **\$34.95**



Z-WAVE REMOTE CONTROL

The Z-Wave Remote has 2 buttons available with On/Off or Arrow Up/Down icons. The 2 state buttons control a single load or a group and provide confidence of the state that they are switching controlled loads to - as opposed to a simple one button toggle type remote control. The buttons can be configured to provide On/Dim Up, Off/Dim Down or All On/Off switching.

The Remote supports a range of Z-Wave network functionality. It can function as a Z-Wave Inclusion Controller and is great as an inexpensive tool to build a Z-wave network.

TS200ZW Z-Wave Remote Control **\$39.95**



Z-WAVE MINI REMOTE

The Aeon Labs Minimote is a low-cost remote controller focused on end-user ease of use. Network installation is vastly improved via the interface. The Minimote is upgradeable by the end-user such that the latest Z-Wave protocols are always available.

An internal lithium battery allows for months of usage and is recharged via USB.

A sliding cover reveals Z-Wave network installation buttons used occasionally. 4 scene buttons are exposed for easy access to user.

AEDSA03202x Z-Wave Mini Remote **\$59.95**
 Colors: Choose Black or White



Complete Details and Specifications on all Z-Wave Products » www.HomeControls.com/Z-Wave-Lighting-Appliance-Controls

Z-WAVE SECURITY SENSORS

AEON LABS Z-WAVE DOOR/WINDOW SENSOR

The Aeon Labs Door/Window Sensor is a battery-powered Z-Wave magnetic door/window sensor with an extremely small form factor. The D/W sensor will send radio signals up to 6 associated Z-Wave devices within its own Z-Wave network when the main unit separates from the smaller unit. Bidirectional mounting plate and push button allows for easy end-user installation. The Aeon Labs Door/Window Sensor also has tamper prevention capabilities and low-battery alerts.

CUSTOMER FAVORITE!



AEDSB04100ZWUS Aeon Labs Z-Wave Door/Window Sensor **\$49.95**

EVERSPRING Z-WAVE DOOR/WINDOW SENSOR

Monitor activity at any entrance in your home with the Everspring Z-Wave Door/Window Sensor. When the door or window is open, contact is broken between the sensor and the magnet, and the sensor signals your Z-Wave enabled system or alarm (sold separately) to alert you.

NEW



- Can signal up to four alert devices
- Sensor may be wired to doorbell (or other contact switch) to trigger events

HSMM1031 Everspring Z-Wave Door/Window Sensor **\$46.95**



Z-WAVE THERMOSTAT

RCS Z-WAVE THERMOSTAT

The TZ45 is a Z-Wave wireless digital thermostat that contains a robust interface and is designed for use with communicating systems where remote monitoring and/or remote control are desired.

- Standard or Heat Pump HVAC Systems
- Programmable, 4 x 7 day schedule
- 128x64 Backlit Graphical Display
- 6 Buttons with On Screen Labels
- Remote Control of All Thermostat Functions

RCTZ45 RCS Z-Wave Thermostat **\$189.95**



EVERSPRING Z-WAVE INDOOR SIREN

Easily connect the Everspring Z-Wave Indoor Siren to any Z-Wave enabled device for reliable notification when the connected device is triggered. The siren's ultra-loud, adjustable alarm and bright red flashing light help ensure you never miss important alerts. Use the siren for a variety of sensors, including door/window sensors, humidity/temperature sensors, flood sensors, motion sensors and more!

- Operating range up to 100'

HSSE8122 Everspring Z-Wave Indoor Siren **\$82.95**

EVERSPRING Z-WAVE TEMPERATURE & HUMIDITY SENSOR

The Z-Wave Temperature & Humidity Sensor warns you when a room's temperature or humidity reaches preset trigger values. When significant change is detected, the sensor signals your Z-Wave enabled system to alert you. Install the sensor either indoors or outdoors for personalized protection where you need it.



HSST8142 Everspring Z-Wave Temperature & Humidity Sensor **\$83.95**

EVERSPRING Z-WAVE WATER/FLOOD SENSOR

The Everspring Z-Wave Water/Flood Sensor helps prevent damage to your property by alerting you to water leaks. When water is detected, the sensor signals your Z-Wave enabled system or alarm (sold separately) to alert you. Install the sensor either indoors or outdoors for personalized protection where you need it.



HSST8122 Everspring Z-Wave Water/Flood Sensor **\$66.95**

HOMESEER Z-WAVE MULTI-SENSOR

The HomeSeer Z-Wave Multi-Sensor is primarily intended and supported as a motion sensor by all Z-Wave certified systems though it can also function as a temperature and light sensor when used with any HomeSeer system! Use it to control Z-Wave devices directly or to trigger HomeSeer automation events for whole house control of Z-Wave and non Z-Wave automation products.

HSMS100S2 HomeSeer Z-Wave Multi-Sensor **\$84.95**

AEON LABS Z-WAVE MULTI-SENSOR

The Aeon Labs Multi-Sensor is a battery-powered Z-Wave motion sensor, temperature sensor and lighting sensor all in one. The sensor will send radio signals up to 6 associated Z-Wave devices within its own Z-Wave network when the sensor detects IR changes in front of its viewing window and can report current temperature and lighting levels in the immediate vicinity.

AEDSB05ZWUS Aeon Labs Z-Wave Multi-Sensor **\$64.95**

EVERSPRING Z-WAVE MOTION SENSOR

The Everspring Z-Wave Motion Sensor helps you stay safe by monitoring movement in and around your home. When motion is detected, the sensor signals your Z-Wave enabled system.

Install the motion sensor either indoors or outdoors for personalized protection where you need it. Head pivots vertically for easy installation on walls or ceilings.

HSPP1031 Everspring Z-Wave Motion Sensor **\$59.95**



AEDSC31101ZWUS Z-Wave Alarm **\$49.95**



NEW



AEAL001x Z-Wave Touch Panel, 1-Button **\$16.95**
AEAL002x Z-Wave Touch Panel, 2-Button **\$16.95**
AEAL003x Z-Wave Touch Panel, 3-Button **\$16.95**

Colors: Choose Black or White



AEDSA22ZWUS Z-Wave Key Fob **\$49.95**



AEDSC247ZWUS Plug-In Appliance Switch **\$59.95**

RF Wireless Lighting Solutions

ON-Q RF LIGHTING CONTROL SYSTEM

ON-Q RF LIGHTING CONTROLS SYSTEM

The RF Lighting Control System allows homeowners to control lights, ceiling fans and small appliances from anywhere in the home, without the need for special wiring or expensive master controllers. The system can handle up to 127 rooms and 1,023 devices – making it the perfect lighting control system for any size home.

- Whole house and room scene controls allow you to change your environment at the push of a button
- Frequency-agile RF wireless technology
- Plug-in modules allow control of small appliances and table or floor lamps
- Wallplates not included (see page 59)
- Switch Colors: Choose White, Almond, Ivory or Black

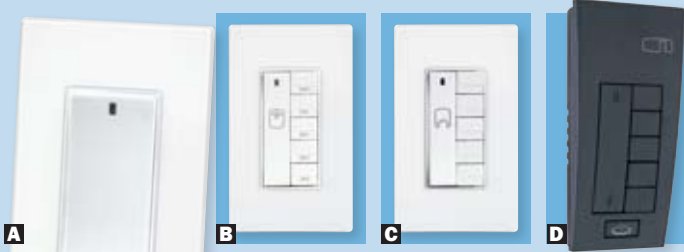

RF SWITCHES

- A QQDRD4** In-Wall Universal Dimmer, 600W **\$109.95**
Works With A Wide Variety Of Dimmable Lighting Sources Including Neon Cold Cathode, Magnetic & Electric Low Voltage & Compact Fluorescent
- A QQDRD2** In-Wall Dimmer, 600W **\$109.95**
For Incandescent Lights
- A QQDRD8** In-Wall 3-Way Switch **\$74.95**
- A QQDRD3** In-Wall Switch, 800W **\$119.95**
- QQMR2000** In-Wall Box Dimmer, 2,000W **\$289.95**

RF CONTROLLERS

- B QQDRD9** In-Wall Fan Speed Controller Switch **\$119.95**
- C QQDRD5** In-Wall Room Scene Controller **\$134.95**
- C QQDRD6** In-Wall Room Scene Controller **\$134.95**
- D QQMRH5G** Hand-Held House Scene Controller **\$239.95**
- D QQMRH6G** Hand-Held Room Scene Controller **\$239.95**
- QQMKFOB** Wireless Key Fob **\$74.95**

RF PLUG-IN RECEIVERS

- QQMRP6W** Plug-In Lamp Module **\$129.95**
- QQMRP7W** Plug-In Small Appliance Module **\$129.95**

RF INTERFACES

- Increase RF range with a Repeater
- Interface with external systems and devices via RS232 Network Controller, Scene Interface or IR Interface

- QQMRR2G** Repeater & Away Emulator **\$144.95**
- QQMRR3G** Room Scene Interface **\$239.95**
- QQMRHC3G** House Scene Interface **\$239.95**
- QQMR232G** RS232 to RF Interface **\$289.95**
- QQMRIR1** IR to RF Interface **\$344.95**

ACCESS LIGHTING CONTROLS FROM YOUR SMARTPHONE

ON-Q RFLC EVENT CONTROLLER

The On-Q RFLC Event Controller provides full time-of-day automation for RF Lighting Control devices. Integrate the controller into your wireless network and set up timed events such as activation of lights at sunrise, and deactivation at sunset. The easy-to-use PC interface creates convenient computer-based control for the everyday homeowner. You can even control your lights with your smart phone, or any web-enabled device!

- Allows for mobile control via iPhone, iPad, Android and Blackberry 6 devices
- Supports up to 100 controlled lighting loads

QQLC6001 On-Q RFLC Event Controller **\$269.95**



ENOCEAN SELF-POWERED LIGHTING: NO WIRES! NO BATTERIES! NO LIMITS!

LEVNET

Using EnOcean technology, LevNet RF transmitters can operate indefinitely without the use of batteries – and without the use of wires! The motion of a switch actuation, light on a solar cell, or temperature differentials in the environment provide power to Leviton transmitters, allowing zero-maintenance wireless devices. Plus, wireless technology means no new wiring is required.

The LevNet RF line includes multiple products that operate in the non-crowded 315 MHz band offering greater transmission range than other wireless technologies and minimal competitive traffic.

- Wallplates not included (see page 59)
- Switch Colors: Choose from White, Ivory, Almond, Light Almond, Black or Grey

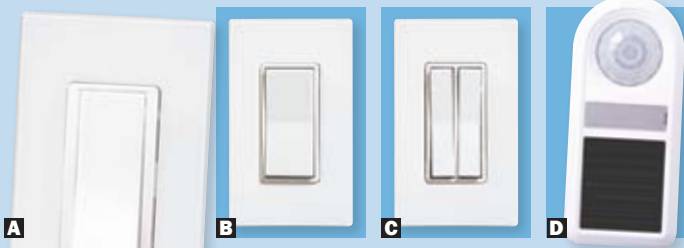

WIRELESS SWITCHES

- A LVWSS10AUZ** Decora Wall Switch Receiver **\$154.95**
- A LVWSS10GUZ** Decora Wall Switch Receiver, Non-Neutral for Retrofit Applications **\$149.95**

WIRELESS REMOTE SWITCHES

- B LVWSS0SPO** 1-Push On/Off Remote Switch **\$104.95**
- B LVWSS0SDO** 1-Gang 1-Rocker Switch **\$99.95**
- C LVWSS0SD2** 1-Gang 2-Rocker Switch **\$114.95**
- LVWSS0SROW** Handheld 4-Button Remote **\$114.95**

WIRELESS SENSORS

- Use with Wireless Switches or 1-Push Remote Switch

- D LVWSC15IOW** PIR Occupancy Sensor **\$139.95**

WIRELESS LINE VOLTAGE RECEIVERS

- LVWSP05010** 3-Wire Relay Receiver, 120VAC **\$139.95**
- LVWSP05080** 3-Wire Relay Receiver, 240VAC **\$139.95**
- LVWSP1210** 5-Wire Relay Receiver, 120VAC **\$139.95**
- LVWSP1280** 5-Wire Relay Receiver, 240VAC **\$139.95**

WIRELESS PLUG-IN RECEIVERS

- LVWSG0SD1T** Plug-In Dimmer Receiver **\$119.95**
- LVWSG0SS1T** Plug-In On/Off Relay Receiver **\$144.95**

WIRELESS LOW VOLTAGE RECEIVERS

- LVWSORC300** 3-Channel Room Controller **\$169.95**
- LVWSORC200** 2-Channel Shade Controller **\$169.95**

INTERFACES

- PCRFBIE** EnOcean-To-UPB Interface **\$187.50**
Translates EnOcean RF To UPB Powerline Communications

Find More Wireless Products Utilizing The New EnOcean Technology
» www.HomeControls.com/EnOcean-Lighting-Appliance-Controls

AVAILABLE COLORS

For Products On This Page



X10 Lighting Controls

LIGHTING SWITCHES

LEVITON DIMMER SWITCH

- Works with or without neutral wire
- Scene Capable with true rocker-style operation
- Intellisense Circuitry
- Colors: Includes White and Ivory; Slave Colors: Choose White or Ivory
- Wallplate not included (see page 59)

A LVHCM101SW Dimmer Switch, 1000W **\$69.95**

A LVMS00R10 Dimmer Slave Switch **\$29.95**

B LVHCM101DW Dimmer Switch with LEDs, 1000W **\$74.95**

B LVHXM061TW Dimmer Switch with LEDs, 2-Way, 600W **\$84.95**

B LVHXM101TW Dimmer Switch with LEDs, 2-Way, 1000W **\$99.95**

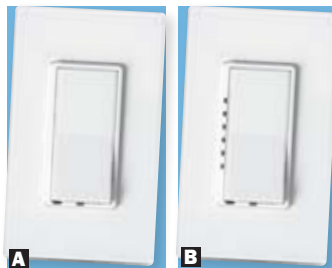

X10 DIMMER SWITCH, INCANDESCENT

- Neutral wire not required

This receiver switch is a mainstay for the bulk of indoor lighting needs. Operates with a simple push on the paddle for On/Off. A continuous press cycles the switch through the Dimming levels. Release when the desired Dim level is reached.

- Turns On to full Bright
- Local or remote Dimming control
- Colors: Includes both White and Ivory
- Wallplate not included (see page 59)

A XTWS12A X10 Dimmer Switch, Single Pole & 3-Way **\$29.95**



X10 WALL SWITCH MODULE

- Neutral not required

An inexpensive 2-wire receiver switch. Responds to All Lights On/All Units Off and Dim/Bright commands. No local Dimming. Can be used with loads up to 500W.

- Colors: Choose White or Ivory
- Wallplate not included (see page 59)

XTWS467 X10 Wall Switch Module \$14.95

LEVITON IN-WALL TRANSMITTERS

Control up to 4 individual addresses, or up to 7 lighting scenes with Dimming, with only 1 single-gang wall transmitter! The 7-scene controller controls up to 7 scenes of up to 12 sequential addresses per scene button. To program, simply hold down the desired scene button until the LED flashes signifying program mode, set all scene capable dimmers and switch receivers to the lighting level you want for a particular scene, and press the desired controller scene button again – and you are done! It's that easy.

- Color: White
- Wallplate not included (see page 59)

A LVHXC101TW 1-Address Controller **\$84.95**

B LVHXC1A1TW 1-Address All Lights On/Off Controller **\$84.95**

C LVHXC1D1TW 1-Address Dimming Controller **\$84.95**

D LVHXC2D1TW 2-Address Dimming Controller **\$84.95**

E LVHXC3D1TW 3-Address Dimming Controller **\$84.95**

F LVHXC4A1TW 3-Address Dimming with All Lights On/Off **\$84.95**

G LVHXC4D1TW 4-Address Dimming Controller **\$84.95**

H LVHXC7S1TW 7-Scene Dimming Controller **\$99.95**



Call Us at 1-800-266-8765
for Custom Button Labels!



AVAILABLE COLORS
For Products On This Page



LEVITON 4-BUTTON KEYPAD & TRANSMITTER KIT

Features an LED for each keypad to indicate an X10 device's On/Off status. Built-in receiver circuitry listens to the power line and updates its LEDs when another X10 controller transmits.

- Includes 4-address control keypad (with pre-printed labels) and transmitter.
- Wallplate not included (see page 59)



HC64004WX Leviton 4-Button Keypad & Transmitter Kit, White **\$34.95**

APPLIANCE SWITCHES

LEVITON APPLIANCE SWITCH

For appliances, fluorescent and incandescent lights.

- Scene Capable with true rocker-style operation
- Neutral connection required
- Intellisense Circuitry
- Single Pole & 3-Way
- Colors: Includes both White and Ivory
- Wallplate not included (see page 59)



LVHCS101SW Leviton Appliance Switch, 10A **\$64.95**

LVHXS081TW Leviton Switch Receiver **\$89.95**

For 3-Way Operation; Requires Appliance Switch

X10 APPLIANCE SWITCH

- Control appliances, fluorescent lights and low voltage
- 1 pole and 3-Way control
- This switch controls indoor lighting, ceiling fans (On/Off only), appliances, and more.
- Requires neutral wire
- Responds to On/Off and All Lights On/All Off
- Colors: Includes both White and Ivory
- Wallplate not included (see page 59)



XTWS13A X10 Appliance Wall Switch, 20A **\$39.95**

CHIME ALERT

X10 CHIME MODULE

Any X10-Controlled event activates this pleasant chime. Signal someone in another room with any X10 controller.

XTSC546A X10 Chime **\$24.95**





X10 PLUG-IN MODULES

LEVITON X10 LAMP MODULE

Scene-capable X10 plug-in receiver (when used with any scene-capable controller). Manual and remote On/Off switching and remote full-range Dimming for incandescent lamps.

- 300W capacity
- Intellisense Circuitry

LVHCP0310W Leviton X10 Lamp Module **\$49.95**

LEVITON X10 APPLIANCE MODULES

- Scene-capable X10 plug-in receiver
- 3 prong with Advanced Intellisense Circuitry

LVHXP151TW Leviton X10 Appliance Module, 3 Prong **\$54.95**

X10 LAMP MODULE

The X10 Lamp Module is the simplest and most effective way to control lights.

- On/Off and Dim/ Bright control
- Override the module at the switch
- Soft Start/Fade Off feature

The X10 Lamp Module plugs into any standard 110V household outlet and gives the ability to remotely control any incandescent light you plug into the module (up to 300W). The Lamp Module is a receiver that reacts to X10 signals generated by X10 transmitters (pages 18-20) elsewhere on the powerline.

XTLM465 X10 Lamp Module **\$19.95**

X10 APPLIANCE MODULE

The X10 Appliance Module works the same way as the X10 Lamp Module, but handles larger 110V loads, up to 15A or 1/3 horsepower and incandescent loads up to 1800W.

Use it with timers, manual and intelligent controllers, telephone responders and a variety of other X10 devices for virtually limitless control of lights and appliances throughout your home.

- On/Off control, All Off (Does not respond to All Lights On or Dim/Bright commands)
- Override this module at the switch

XTAM466 X10 Powerhouse Appliance Module, 3 Prong **\$21.95**

X10 SCREW-IN MODULE

For lights without a plug-in cord. Electronic programming ... no code wheels! Responds to On/Off, All On/Off (non-Dimming).

- 150W incandescent
- Tiny size: Only 2½" x 1¼" (plus ⅜" bump on one side)

XTLM15A X10 Screw-In Lamp Module **\$18.95**



X10 WIRE-IN MODULES

SPLIT RECEPTACLE

• X10 control on top
• Bottom is always live
The X10 control elements are built-in, so Lamp Modules aren't necessary. Rated at 15A. Responds to On/Off, All Units Off commands, but not All Lights On or Dim/Bright. Controlled devices may still be controlled with local switches.

- Color: White
- Wallplate included

XTSR227 X10 Pro Split Receptacle **\$23.95**



X10 ACCESSORIES

WHOLE-HOME NOISE BLOCK

The Whole-Home Noise Block is ideal for apartment buildings, condominiums, attached-unit dwellings and single family homes sharing the same electrical transformer as another dwelling. This active filter slips over the neutral wire feed entering your house and has a signal bridge/coupler built-in. Each phase is rated 200A.

HC6284X Leviton Whole-Home Noise Block **\$39.95**



SIGNAL BRIDGE

The Signal Bridge solves intermittent or poor X10 reception in one part of a house.

The typical 2 phase 240V power supply found in most homes is split into 2 120V legs. X10 signals sometimes have a difficult time getting from one leg to the other without a signal bridge.

XPXPCP X10 Signal Bridge **\$34.95**



POWERLINE SIGNAL ANALYZER

If you are serious about X10 system installation and troubleshooting, the Power Line Signal Analyzer is a must have. This great tool has operational information conveniently printed on the back and saves you hours of installation and troubleshooting time. A "must have" for your toolbox!

- X10 Code Identifier
- X10 Signal Strength Voltmeter
- Powerline Noise Meter
- Dissect the Entire X10 Signal
- X10 History Recorder

MIPLSA Powerline Signal Analyzer **\$324.95**



CONTROL YOUR X10 SYSTEM WITH YOUR PHONE

TELEMASTER

TeleMaster provides control of a home's lights, appliances and electronics from any phone - anywhere - including wireless and cell phones!

Homeowners can turn On lights, heat their hot tub and set indoor temperature to 72° on their drive home from work. TeleMaster talks directly to all X10 controlled devices and all 256 X10 codes. Provides password protected control of a home's X10 devices, from any phone in the world!

Use a phone's memory dialer to send scene-capable TeleMaster commands. This means you can execute a series of X10 commands with the touch of a button.

Simple to Operate: Dial normally to make phone calls. For X10 control, dial * (for On) or dial # (for Off) followed by a number. It's that simple! For example, dialing *26 turns On X10 unit B6.



Simple to Install: Just plug into any phone jack and instantly use all phones in your home as X10 controllers. Fully compatible with voice mail, call waiting and answering machines.

MITMS TeleMaster **\$139.95**

X10 Wireless Controls

X10 WIRELESS REMOTES

X10 HANDHELD WIRELESS REMOTE

Issue X10 commands anywhere within 100' of a plug-in base transceiver with this 8-button RF Wireless Remote. Remote controls unit numbers 1-8 or 9-16 (switch selectable).

- Use in conjunction with any X10-compatible Transceiver.
- Uses 4 AAA batteries
- Color: White

XTHR12A X10 Handheld Wireless Remote **\$17.95**



LEVITON X10 KEYCHAIN WIRELESS REMOTE

This compact remote control transmitter fits on a key chain, for indoor or outdoor use. It controls 2 X10 controlled receivers with an effective transmission range of 70'. Does not support Bright/Dim.

- Use in conjunction with any X10-compatible Transceiver

LVHCKRE Leviton Keychain X10 Remote **\$26.95**



X10 WIRELESS TRANSCEIVERS

X10 TRANSCEIVERS

Transceiver modules are an integral part of an X10 wireless system. These modules accept commands from X10 remote controls and wireless sensors and converts them to X10 signals. The module also incorporates a built-in outlet (XT751 outlet controlled by RF only; XTRR501 outlet controlled by any X10 controller).

XT751 X10 Deluxe Transceiver (house code 1) **\$13.95**



LEVITON X10 TRANSCEIVER

Leviton's X10 Transceiver functions as a receiver that accepts On/Off, Dim/Bright and All On/All Off RF commands from the Universal Remote Control and On/Off signals from a wireless remote. The Transceiver works with all Receivers by retransmitting those signals throughout a home's existing electrical wiring. The module also incorporates a built-in outlet.

LVHCPRF Leviton X10 Transceiver **\$54.95**

WGL X10 TRANSCEIVERS

These X10 Transceivers provide a professional alternative that receives all house codes and offers greater reception range.

- Receives all 256 house/unit code addresses
- External antenna package for extreme range
- Custom house and unit code filtering (optional)
- Filtering settings are not lost during power loss

WG30020 WGL X10 Transceiver **\$74.75**

WG28005 WGL X10 Transceiver, 32-bit (for security system commands) **\$94.75**



CONTROL ENTERTAINMENT SYSTEMS PLUS X10!

ICONREMOTE RF

The IconRemote has the ability to combine many types of remotes into a single remote. It has many unique features that are available through the high quality color screen and the configurable menus. The screen displays icons that are easily set up to represent your favorite channels. You can select any channel by simply pressing the key next to the icon that represents the channel.

The IconRemote may provide additional functions that are not available on your device, and there may be functions (e.g., menu functions) that initially may not be controlled by the remote; but in such cases, the IconRemote can easily learn the commands from your original remote.

- No need to change device modes!
- Easy set-up - no computer needed
- Control up to 9 devices plus your X10 gear
- X10 Home Security compatible
- Extended battery life

XTIR34A iconRemote RF **\$69.95**



NOTE: Availability of X10 devices may change without notice.



X10 WIRELESS SECURITY

X10 SECURILINK SECURITY CONSOLE

The X10 Supervised Security System Console with automatic dialer calls neighbors or friends in the event of a break in.

- Control via telephone
- 32 Zones of protection
- Built-in lighting timer to deter crime
- No contracts to sign
- Easy do-it-yourself installation - set it up yourself in under half an hour

When the console is triggered, it flashes your home's lights and blares a piercing 95 decibel siren (about as loud as a home stereo on max volume). Plus, it activates the voice dialer system. It calls you first. If you don't answer, it calls five additional programmable numbers (friends, relatives or neighbors) until somebody picks up. When you answer, it plays a recorded message (in your words), letting you know that there is a possible burglary at your home.

Built-in Lighting Timer: Security is about more than a white box that makes noise. It's about crime prevention. One of the most effective ways to deter crime from your property is proper lighting. With a built-in lighting timer, you can set your lights, indoors and out, to come on at random times or scheduled times throughout the day. This gives your home the lived-in look that strikes fear in the heart of burglars.

32 Zones of Protection! SecuriLINK is set up to handle up to 30 zones of X10 Door/Window Sensors and Motion Detectors - any combination of the two. That's enough for even the largest of homes and buildings! In addition, it also allows for two zones of hard-wired sensors. That means you can use third party sensors. Have a wired water level sensor or glass break sensor? You can wire it into the SecuriLINK Console and have it trigger your alarm. Have a hard-wired motion detector from another security system? Wire it into the SecuriLINK and use it for your current security system!

XTSC1200 X10 SecuriLINK Security Console **\$99.95**



X10 SECURITY COMPONENTS

A XTDS12A X10 SMART Door/Window Sensor **\$17.95**

B XTMS18A X10 SMART Motion Detector **\$29.95**

C XTKR32A X10 SMART Keychain Remote **\$29.95**

SkylinkHome Lighting Controls



SkylinkHome is a wireless control system that allows you to control almost anything electronic in the home, including lamps, garage doors, security systems and coffee makers. Control is easy and flexible with its SkylinkPad, a credit card size remote, and several receiver options. The entire system covers up to 500'! SkylinkHome is not only for your home, but also ideal for your office, vacation home, shop, warehouse, school, farm and outdoor landscape lights.

SKYLINK REMOTES

CUSTOMER FAVORITE!



SKYLINK PAD

At the center of the Skylink system is the Skylink Pad, a wireless control system that allows the user to control almost anything electronic in the home, including lamps, garage doors, security systems, and coffee makers. The credit card size of pad comes in six options with up to 14 buttons to control various household items. Carry this credit card size pad to control your home!

- Up to 500' operating range in an open area
- Can dim if controlling a dimmable receiver and dimmable load
- Mounting bracket allows you to wall mount by screws or to fridge (metal surface) by magnetic tape

- A SKTC3181** Skylink Pad 1-Button Remote **\$14.95**
- B SKTC3182** Skylink Pad 2-Button Remote **\$15.95**
- C SKTC3183** Skylink Pad 3-Button Remote **\$16.95**

7, 10 AND 14 BUTTON REMOTES OFFERS ZONE CONTROL AND ALL ON/ALL OFF OPERATIONS

- D SKTC3187** Skylink Pad 7-Button Remote **\$18.95**
- E SKTC31810** Skylink Pad 10-Button Remote **\$20.95**
- F SKTC31814** Skylink Pad 14-Button Remote **\$21.95**

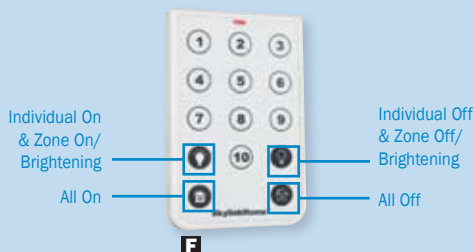

SKYLINK PLUG-IN MODULES

- G SKLS318** Skylink Screw-In Dimmer Module **\$39.95**
- SKLX318** Skylink Mini Screw-In Dimmer Module **\$26.95**

The SkylinkHome Plug-In Dimmer allows you to wirelessly turn on and off, dim and brighten connected lights with the SkylinkHome transmitters. Can communicate with up to 8 transmitters.

- H SKPL318** Skylink Plug-In Dimmer Module **\$26.95**
- HKPR318** Skylink Plug-In Dimmer Module with Repeater **\$29.95**
- SKPA318** Skylink Plug-In On/Off Control Module, In/Outdoor **\$29.95**

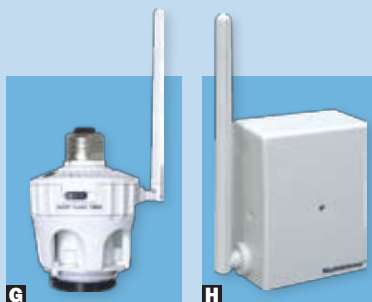

SKYLINK WIRE-IN MODULES

Operates incandescent light or dimmable compact fluorescent light with a maximum load of 300W at 120VAC.

- SKMD318** Skylink Wire-In On/Off plus Dim Module **\$26.95**

Operates lights with a maximum load of 600W at 120VAC.

- SKMR318** Skylink Wire-In On/Off Module **\$26.95**



MOTION SENSOR

- Turn lights on when motion is detected
- Turn lights off after 5, 30 or 60 minutes
- Can be set to only turn lights on when it is dark

- SKMR318** Skylink Motion Sensor **\$26.95**



SKYLINK SWITCHES



WALL SWITCH TRANSMITTER

The SkylinkHome wall switch transmitter is completely wireless. It easily mounts anywhere!

- Regular rocker style wall switch
- Wireless wall switch or 3 way switch
- Control lights On / Off and Dim

- A SKTB318** Skylink Wall Switch Transmitter **\$21.95**

ON/OFF WALL SWITCH

- Replace existing wall switch
- No neutral wire is needed
- Operates up to 1,000W load, including fan or CFL
- Two modes for different applications: On/Off; and countdown timer

- B SKWE001** Skylink On/Off Wall Switch **\$29.95**

DIMMER WALL SWITCH

- Replace existing wall switch
- No neutral wire is needed
- On/Off/Dim operation
- Operation modes (up to 300W load)
- Three modes for different applications: On/Off; countdown timer; and flashing alert

- B SKWR001** Skylink Dimmer Wall Switch **\$29.95**



SKYLINK SNAP-ON REMOTE

Remote control for On/Off/Dim that docks onto Skylink Wall Dimmer or Wall Switch.

- SKTM318** Skylink Snap-On Remote **\$16.95**
- SKWE318** Skylink On/Off Wall Switch with Snap-On Remote Kit **\$44.95**
- SKWR318** Skylink Dimmer Wall Switch with Snap-On Remote Kit **\$39.95**

GLOBAL CACHÉ NETWORK ADAPTERS



GLOBAL CACHÉ HOME NETWORK ADAPTER

The GC-100 Network Adapter connects IR, serial (RS232), and relay (contact closure) devices and equipment to a TCP/IP network. The GC-100 includes sensor input, can be polled by other network devices, and can be used in a wired and wireless environment. A small, embedded web server allows for easy configuration from any browser. Global Caché Network Adapters integrate simply and easily into most automation and control

environments without modification. Global Caché offers additional products including sensors, an IR Learner, an IR Extender and conversion cables.

- Connects IR, Sony Control-S, RS232 serial, sensors and relay contact closures to a network
- 10 Base-T network port
- Only one power supply required for each enclosure
- Embedded web server for easy configuration

- A GC10006** Home Network Adapter, 6" (1 network I/F, 3 IR outputs, 1 serial) **\$169.95**
B GC10012 Home Network Adapter, 12" (1 network I/F, 6 IR outputs, 2 serial, 3 relays) **\$319.95**
C GC10018 Home Network Adapter, 18" (1 network I/F, 6 IR outputs, 2 serial, 3 relays) **\$369.95**
GC10018R Home Network Adapter, 18" (rack mount) **\$399.95**

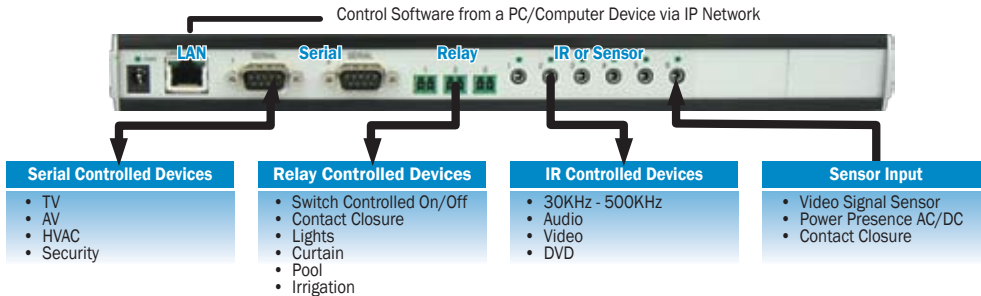

AUTOMATION CONTROLLER!

ADICON OCELOT

- Programmable If/Then/Else control
- Control Wizard write your programs for you
- 2-Way X10
- IR Send and Receive
- RS485 expansion to Adicon I/O Modules
- Use with computer front-end, HAI Omni, or as a stand alone controller

Tons of Ways To Use!

- Fire and security monitoring
- CCTV control
- Telephone interface
- Lawn and indoor irrigation
- HVAC control
- Audio equipment control



- Home theatre control
- Indoor/outdoor lighting control
- Aquarium control
- Swimming pool
- Drapery control

ATOCELOT Adicon Ocelot Controller **\$229.95**

ATSECU16 Supervised I/O Module **\$114.95**

Provides 8 Low Current Relays As Well As 8 Supervised Digital Or Analog Inputs

HEAVY DUTY RELAY



HEAVY DUTY RELAY

The ELK9200 is a Heavy Duty Relay/Contactor inside a lockable metal enclosure (not an outdoor-rated box) to remotely control high current devices, such as electric water heaters, pumps, motors and gates. The energizing coil of the ELK9200 is 110 VAC, but its 2-pole relay contacts are capable of switching 220 VAC at up to 60A of current. The relay coil is prewired with a 3 prong plug-in cord. This plug is compatible with virtually any appliance style automation module (purchased separately) including: UPB, Z-Wave, X10, and others.

ELK9200 Heavy Duty Relay **\$78.95**

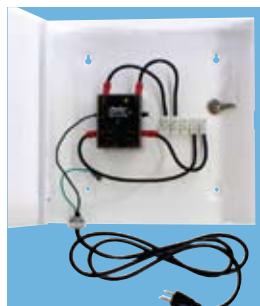

RELAY BOARDS

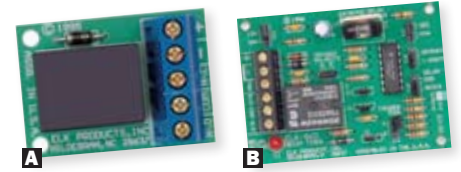

COMPACT RELAY

Ideal for general purpose switching of devices or high current loads.

- Contacts rated: 7A @ 30VDC, 10A @ 125VAC
- SPDT (Form-C) dry contacts
- Operating voltage: 12VDC nominal
- Current draw: 30mA
- Built-in diode transient protection across relay coil

A ELK912 Compact Relay **\$8.95**

ELK91212 Compact Relays, 12 pack **\$77.95**

DELAY OR DURATION TIMER

For many general purpose time delay applications.

- Selectable 12V or 24V operation
- Adjustable delay time
- Positive or negative low current trigger
- SPDT (Form-C) relay
- Selectable initial relay state: On/Off
- Output modes: 1-shot or repeat
- LED indication of relay status
- Time settings: 1 sec to 60 min
- Relay contact rating: 7A @ 30VDC
- Trigger voltage: 4-27 VDC
- Input trigger < 1mA
- Current draw with relay on: 40 Ma
- Size: 3" x 2 1/2" x 1"

E ELK960 Delay Timer **\$29.95**

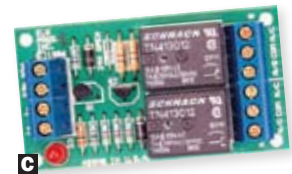

SENSITIVE RELAY

- Contacts rated: 7A @ 30VDC 10A @ 125 VAC
- DPDT (Form-C) dry contacts
- LED to indicate function of the relay
- Operating voltage: 12 or 24 V DC
- Trigger current: 1 mA positive or negative
- Built-in diode transient protection across relay

G ELK924 Sensitive Relay **\$13.95**

ELK9244 Sensitive Relay, 4-pack **\$50.00**

SERIAL NETWORK RELAY MODULE

The Relay8 supports devices capable of sending a Status Request command. You can poll individual relays to determine their On/Off status, or your computer can send verified commands to the module.

- Each of the 8 independent relays is equipped with a Form-C contact that is brought out to 2 plug in, detachable terminal strips
- 1A @24VDC resistive; 1A @120VAC resistive
- Contacts designed for low current applications as well as power switching

WG30062 Relay8 Module, RS232/USB **\$164.95**



Unity Home System



COMBINE ON-Q'S CAMERA, AUDIO & INTERCOM INTO ONE INTEGRATED SYSTEM

UNITY INTEGRATION MODULE

The Integration Module is a dedicated home systems controller designed to tie camera, intercom and audio systems together to work as a unified system.

A graphical user interface allows homeowners to see into and control their Unity Home System. It is logically laid out for homeowners to be able to call room-to-room with their intercom, adjust the volume of the music playing in the living room and view the front door camera with the navigational arrows and soft buttons on the LCD Console.

- Up to 6 cameras per system
- Up to 8 LCDs or 64 TV Displays per system
- Up to 32 intercom units per system
- System can be expanded for up to 16 audio zones

Unity 2.3: Unity 2.3 enables remote viewing of any video feed connected to Unity via a smartphone or tablet device. Homeowners can now check on the kids while out to dinner, keep an eye on the baby's room from the basement, or periodically monitor their home during a long vacation, all with a few flicks of a finger.

OQHA6001 On-Q Unity Integration Module **\$1689.95**

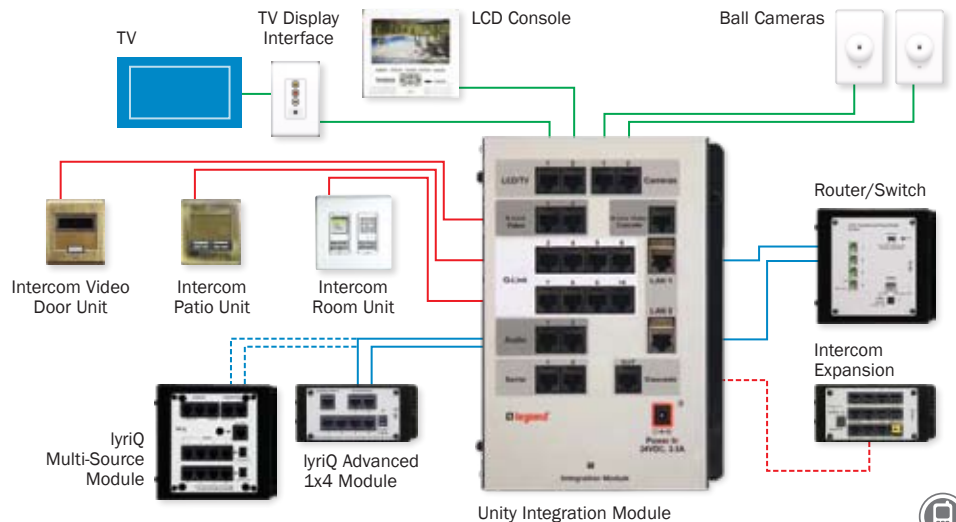

ON-Q/LEGRAND
UNITY HOME SYSTEM
COMBINES:



**QORF Lighting
& Appliance Controls.**
Page 19



**Cat5 Camera
Monitoring System.**
Page 48



**lyriQ Audio
Distribution.**
Page 66



**Selective Call
Intercom System.**
Page 81

NAVNET HOME AUTOMATION

NavNet Home Automation

NavNet
FOR CONTROL FREAKS

NO-PROGRAMMING HOME AUTOMATION: GET IN, GET OUT, GET PAID!

NAVNET HOME AUTOMATION

NavNet's home automation solution offers "out of the box" functionality, allowing homeowners full control over music, movies, lighting, security, HVAC and more – from anywhere in the world. NavNet sets itself apart through ease of installation, graphically-rich interfaces and an overall experience that makes NavNet solutions fun and easy to use. NavNet has worked hard to create solutions that fit seamlessly into any home environment.

- Avoid programming bottleneck. No more writing code. Any staff members can configure NavNet.
- Pre-built integration with some of the industry's largest automation and audio manufacturers – including HAI, GE Security, NuVo, SpeakerCraft, Vantage, Elk, Simply Automated, PulseWorx, Aprilaire, and Global Cache, just to name a few!
- Massive database of pre-built A/V devices – and dealers can build their own.

NNDC500 NavNet DC-500 Contoller **\$Call**

Includes 2 Audio Streams, 1 RS232 Ports, 3-Zone IR Modules, and mNavNet.

NNDC10004 NavNet DC-1000-4 Controller **\$Call**

Includes 4 Audio Streams, 3 RS232 Ports, 2 3-Zone IR Modules, and mNavNet.

NNDC10008 NavNet DC-1000-8 Controller **\$Call**

Includes 8 Audio Streams, 3 RS232 Ports, 2 3-Zone IR Modules, and mNavNet.

NAVNET AUDIO AND VIDEO

- Play up to four SiriusXM channels simultaneously
- Enjoy Netflix movies right from your NavNet system
- Comes pre-loaded with 1,300 internet radio stations
- Play your own music collection with direct integration with iTunes
- System access from anywhere over Wi-Fi or 3G
- Built-in Blu-Ray, DVD and 3D movie server

NNACA1000 NavNet Audio Controller Amplifier **\$Call**

NNHDS1000 NavNet HD Video Streamer **\$Call**



NAVNET TOUCH PANELS

NavNet touch panels eliminate the stacks of remote controls, hard-to-use audio key-pads and the clutter of wall switches, thermostats and security keypads. This both simplifies and expands your ability to control a broad range of automated systems and devices.

- Economical touch panels in 8", 12" 15" and 17" sizes
- Free apps for iTouch, iPhone, iPad and Android
- Browser-based configuration and remote accessibility – with no fees!

NNIWPx NavNet In-Wall Touch Panel **\$Call**

NNIWMFKIPx NavNet iPad Kit **\$Call**

NNIWMFKITx NavNet iTouch Kit **\$Call**

NAVNET ACCESSORIES

NNTH30WF NavNet WiFi Radio Thermostat **\$Call**

NNE500xG NavNet Energy Management **\$Call**

Choose from 1 or 2 Panels

NNCI1 NavNet Caller ID Module **\$Call**

View the Complete Product Line » www.HomeControls.com/NavNet

Omni Automation

HAI control systems are the heart of an automated home because they can coordinate all of the systems in a home to talk to each other. An HAI home control system adjusts the security, cooling, heating and lighting automatically for comfort, convenience and safety. Homeowners recognize that an HAI home control system can pay for itself through energy savings while increasing the value and enjoyment of their home.

OMNI CONTROLLERS

HAI Omni control systems are the brain of your automated home/business because they can coordinate all of the systems in your home/business to talk to each other. It adjusts the security, access control, cooling, heating, lighting, and surveillance automatically for comfort, convenience, and safety.

Omni home control systems feature built-in UL Listed security and fire systems, lights, temperature, security, access control, surveillance, and audio can be scheduled by time, sunrise, sunset, date, day of week, as well as by system event, such as motion detected, door opened, or mode changed.

HAI OMNI LT

GOOD: An economical choice for homes, townhouses, condos, apartments and small businesses, Omni LT is the entry level system.

HA21A001 Omni LT Controller **\$324.95**

Includes Controller With Enclosure, RJ31X Jack & Cable, Manuals & Accessories

HA21A0011 Omni LT Controller **\$354.95**

Includes Controller On A Structured Wiring Backplate

HA21A002 Omni LT Controller **\$294.95**

Board Only

HAI OMNI IIE

BETTER: An ideal choice for mid-range homes and small businesses, Omni IIE is the middle member of HAI's best-selling Omni product line.

HA20A0050 Omni IIE Controller **\$834.95**

Includes Controller With Enclosure, Lock With 2 Keys, HLC Powerline Interface, RJ31X Cord & Jack, Manuals

HA20A0052 Omni IIE Controller **\$834.95**

Includes Controller On A Structured Wiring Backplate

HA20A0053 Omni IIE Controller **\$774.95**

Board Only

HAI OMNI PRO II

BEST: The OmniPro II is designed for large residences and commercial installations.

HA20A002 OmniPro II Controller **\$1204.95**

Includes Controller With Enclosure, Lock With 2 Keys, HLC Powerline Interface, RJ31X Cord & Jack, Manuals

HA20A008 OmniPro II Controller **\$1204.95**

Includes Controller On A Structured Wiring Backplate

HA20A0021 OmniPro II Controller **\$1139.95**

Board Only

[Full Omni System Specs »](#)

www.HomeControls.com/HAI/OmniControllers



	OMNI LT	OMNI IIE	OMNI PRO II
Household Square Footage	Up to 2,000	1,000-3,000	3,000 Plus
HAI Lighting/Rooms	2	8	31
Lighting Scenes	16	64	128
Lighting Addresses	16	64	250
Zones	8	16	16
Zone Expansion Total	24	48	176
2 Wire Smoke Loops	1	4	4
4 Wire Smoke Loops	24	48	176
Thermostats	2	4	64
Consoles (Keypads)	4	8	16
OmniTouch 5.7 Touchscreens	3	7	15
OmniTouch IP Touchscreens (10pe/5.7e)	0	16	16
12 Volt Triggers (with expansions)	2 (10)	8 (8)	8 (136)
Audio Control	Hi-Fi	Hi-Fi	Hi-Fi/Conn.Prtnrs
Access Control Card Readers/Users	0/0	4/16	16/99
Serial Ports	1	5	5
Ethernet Port	No	Yes	Yes
Flash Memory	No	Yes	Yes
User Codes	8	16	99
Programming Lines	100	500	1500
Vocabulary	195	550	550
Custom Vocabulary	No	No	Yes
Transformer Required	16.5V (40VA)	24V (40VA)	24V (40VA)
Battery (Typical)	12V (7 Ah)	12V (7 Ah)	12V (7 Ah)
Aux Current Max	500mA	1A	1A

- HAI's products increase the energy efficiency of your home with lighting control, temperature control, and control of large energy-using devices.
- Thermostats automatically set back and lights turn off when leaving the home. Settings restore automatically when you return.
 - Enhance your home with elegant lighting control.
 - Coordinate lighting and set by schedule, time of day, or event.



Control Your Omni System With HAI SnapLink Mobile for iPhone or iPad
» www.HomeControls.com/iPhone-Home-Controller-Apps



OMNI KITS

HAI has pre-packaged bundles to get you started with your home automation system. Home Controls offers Promo Bundles for each of HAI's core home automation solutions and all of these packages can communicate with any controller.

Step One: Choose an Omni Controller (page 26) or Lumina Controller (page 28).

Step Two: Choose an add-on bundle.



HA12PROMOHTLB Home Theater Lighting Promo Bundle **\$539.95**

Includes 3 600W UPB Dimmer Switches, 600W UPB Non-Dimming Switch, 6-Button Scene Switch, Scene Switch Remote and Table Top Scene Switch Cradle (White).

HA12PROMOLB Lighting Promo Bundle **\$1934.95**

Includes 12 600W UPB Dimmer Switches, 4 Auxiliary Switches, 2 UPB Lamp Modules, 4 15A Relay Switches, UPB Split Phase Repeater, UPB Powerline Interface Module & Accessories.

HA12PROMODAB Distributed Audio Promo Bundle **\$3794.95**

Includes Hi-Fi 2 8-Zone/8-Source Kit in Enclosure (with 8 Volume Source Controls & 4 Remote Input Modules), OmniTouch 5.7e Touchscreen, 2 HAI iPod Docks (Wireless) & One-Port PoE Injector.

HA12PROMONAVCB Network Audio/Video Control Promo Bundle **\$1469.95**

Includes Home Theater Extender 2 (HTX2), OmniTouch 5.7e Touchscreen & One-Port PoE Injector.

HI-FI 2 BY HAI

The Hi-Fi 2 is HAI's all new distributed audio system. See page 65 for details.

HA95A001 Hi-Fi 2 8-Zone, 8-Source Kit in Enclosure **\$2169.95**

Includes Hi-Fi 2 In Enclosure, 8 Volume Source Controls & 4 Remote Input Modules

HA95A002 Hi-Fi 2 8-Zone 8-Source Kit for Structured Wiring Enclosures **\$2169.95**

Includes Hi-Fi 2 On Universal Mounting Plate, 8 Volume Source Controls & 4 Remote Input Modules

HA95A121 Hi-Fi 2 8-Zone, 8-Source Expansion Kit in Enclosure **\$2014.95**

HA95A122 Hi-Fi 2 8-Zone 8-Source Expansion Kit for Structured Wiring Enclosures **\$2014.95**

OMNI TOUCHSCREENS & CONSOLES

HAI OMNITOUCH 5.7e

The OmniTouch 5.7e Touchscreen is a colorful Touchscreen interface for either Omni family or Lumina family home control systems. It facilitates graphical control of security (Omni family only), HVAC, lighting and other home control functions via easy-to-recognize icons. It can also be set up as a stand-alone remote for your home theater.

OmniTouch 5.7e can control home theater and other A/V equipment through HAI's Home Theater Extender (HTX), see page 29.

• Color: White (Color change kits available)

HA53A002 OmniTouch 5.7e **\$929.95**

Requires a power sourcing equipment device, such as a PoE network switch, hub, or power injector.

HA90A001 1-Port PoE Injector **\$54.95**

HA91A001 8-Port PoE Switch **\$274.95**



AUTOMATION STUDIO

HAI Automation Studio is a comprehensive software tool primarily used to design custom OmniTouch 5.7e Touchscreen interfaces. With HAI Automation Studio there is no need to learn a difficult computer programming language. It is a drag and drop, WYSIWYG program that opens up HAI to your unlimited creativity.

Effortless adjustments include the removal of unnecessary buttons or the modification of font styles, font sizes, colors, and much more. To ensure that users without graphic design knowledge can create custom Touchscreens, HAI includes an expansive Image Gallery of buttons with various colors and sizes.

HA1126 Automation Studio **\$384.95**



HAI OMNITOUCH 5.7

This plug-n-play touchscreen features a 5.7" color, touch-sensitive LCD screen with backlighting that adjusts automatically to ambient lighting conditions and turns Off when not in use.

• Color: White (Color change kits available)

HA53A001 OmniTouch 5.7 **\$849.95**

HA53A171 OmniTouch 5.7 Table Top Stand, Black **\$69.95**

OMNITOUCH COLOR CHANGE KITS

HA53A05* OmniTouch 5.7e and 5.7 Color Change Kits **\$23.95**

Colors (*): Choose Almond, Black, Ivory, Light Almond, Silver Or White

HA53A05*A OmniTouch 5.7e and 5.7 Color Change Kits, Metallic **\$214.95**

Colors (*): Choose Gold, Silver, Bronze Or Black



Add the Touchscreen Hub and you can see digital video on up to 8 cameras. The screen will show the video image in a window with the 6 camera selection buttons. Tapping the image brings it to full screen.

HA32A312 Touchscreen Hub (Board Only) **\$529.95**

HA32A303 Touchscreen Hub (With Enclosure) **\$664.95**

HA32A304 Touchscreen Hub (for Structured Wiring Enclosure) **\$664.95**

OMNI CONSOLES

The Omni Console is a surface or flush mount console that features a 48 character LCD display with menu operation, backlit keys, selectable key click, beeper functions and viewing angle.

A HA33A001 Omni Console **\$129.95**

B HA33A004 Omni Console with Speaker/Mic **\$169.95**

C HA33A003 Omni Console Flush Mount Kit **\$23.95**



AVAILABLE COLORS
For Products On This Page



HAI Lighting Controls

HAI LIGHTING CONTROL (HLC)

These HAI lighting controls can work in a stand-alone UPB system, or integrate into any HAI Omni family (page 26) or Lumina family system (below). When HLC is used in conjunction with an HAI control system, lights can be scheduled by sunrise/sunset, motion, or event. Lights can be controlled by remote control, phone, Internet, touchscreen or TV.

- Can be used in new or existing homes that have standard electrical wiring
- HLC uses Generation III UPB
- LED indicator lights can be programmed to glow Blue, Red, Magenta, or turned off entirely
- Wallplate not included (see page 59)
- Color: White (Color change kits available)

A HA35A001 HLC Dimmer, 600W, White **\$69.95**
A HA35A003 HLC Non-Dimmer, 600W, White **\$69.95**

- Colors: Choose from White or Ivory (1,000W also available in Almond, Black, Brown or Grey)

A HA55A001 HLC Dimmer, 1,000W **\$149.95**

A HA55A002 HLC Dimmer, 1,500W **\$289.95**

A HA55A003 HLC Dimmer, 2,400W **\$349.95**

A HA40A001 HLC Relay Switch, 15A **\$89.95**

HA40A001 HLC Relay Switch, 15A (White) **\$89.95**

UPB Relay Switch Used For Controlling Heavier Loads Or Motors, Such As Ceiling Fans, That May Hum When Used With Dimming Or Non-Dimming Switches

HA37A001 HLC Auxiliary Switch (White) **\$27.95**

For Remote Operation Of HA35A00, HA40A00 & HA55A00 Dimmers & Switches

For Details & Specs On HAI Lighting Control (HLC) » www.HomeControls.com/HAIUPBLightingControl

HAI LUMINA LIGHTING CONTROL SERIES

A Lumina home control system provides sophisticated lighting control that is affordable, easy to install, easy to operate and offers unrivaled expandability. The Lumina family consists of the Lumina Pro and the Lumina. The number of rooms and lights that you wish to control will usually determine which Lumina home control system you need to buy.

- Supports all Omni IIe and OmniPro II accessories, including Web Link II for Internet control and Home Control for Windows Media Center

LUMINA CONTROLLERS

HA44A002 Lumina Pro (31 rooms, 217 lights) **\$1114.95**

Includes Controller In Enclosure With Lock & Keys, Ethernet Port, LCD Keypad, UPB Powerline Interface, Phase Coupler, Serial Cable, Transformer & Battery, Manuals & Accessories

HA44A001 Lumina (8 rooms, 56 lights) **\$819.95**

Includes Controller In Enclosure With Lock & Keys, Ethernet Port, LCD Keypad, UPB Powerline Interface, Phase Coupler, Serial Cable, Transformer & Battery, Manuals & Accessories

LUMINA INTERFACE OPTIONS

All Consoles are surface mount; use HA33A003 to convert to a flush mount.

HA33A0019 Lumina Console **\$139.95**

HA33A0020 Lumina Console

with Speaker/Microphone **\$169.95**

HA33A003 Lumina Console Flush Mount Kit **\$23.95**

HA1111 Lumina Programming Software **\$39.95**

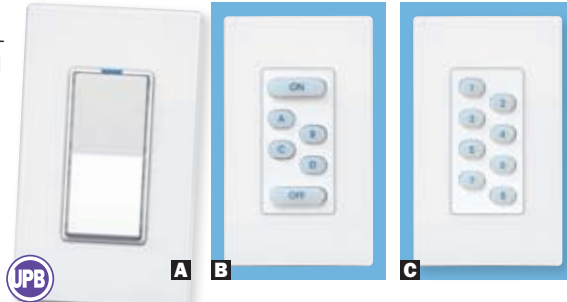

HLC SCENE & STATUS SWITCHES

Control all lights in a room or area. Lights may be turned On or Off, Dimmed, Brightened, and set to 4 different scenes.

- Color: White (Color change kits available)

B HA38A001 HLC Scene Switch **\$124.95**

HA38A141 HLC Scene Switch Remote **\$39.95**

This master lighting control shows the status for up to 8 rooms. If any light is On, the button for that room is illuminated.

- Color: White (Color change kits available)

C HA38A002 HLC House Status Switch **\$149.95**

HA38A15 HLC Tabletop Pedestal Kit **\$30.95**

Scene Switch Cradle Is Used To Table Mount The Scene Switch & House Status Switch (Choose White or Black)

HLC ACCESSORIES

HA59A001 UPB Lamp Module **\$69.95**

HA60A001 UPB Appliance Module **\$89.95**

HA36A001 UPB Powerline Interface **\$74.95**

HA39A001 UPB Phase Coupler **\$59.95**



LUMINA MODE SWITCH

This 6-button keypad allows you to press 1 button, Sleep, Home, Vacation, Away, Party, or Special, to initiate a program for preset lights, temperature, and audio for the entire home.

HA38A003 Lumina Mode Switch **\$144.95**



HAI CLIMATE CONTROL

HAI OMNISTAT2

Using advanced digital technology, the Omnistat2 learns your home's heating and cooling patterns and adjusts control to maximize both your HVAC's efficiency and your family's comfort.

- The backlight comes to life as you approach, making it easy to adjust in the dark – with more than 100 customizable backlight colors
- To adjust the temperature, simply turn the scroll wheel to the right or left
- 3 buttons facilitate easy to navigate menus to display information
- Selectable simplified and advanced displays
- Supports 1 indoor/outdoor temperature sensor
- Color: White (also available in Silver or Black)

Comfort

- Digital precise temperature control
- Automatic heat/cool changeover
- Fan mode periodically circulates air for comfort
- Indoor sensor averaging with remote sensor
- Humidity Control (with HARC2000)
- No batteries needed to retain settings and time

Energy Management

- Learns how your home heats and cools to control the equipment for efficiency and comfort
- Graphical display of HVAC usage, by week
- 7 day schedule with copy function
- Filter reminder for peak efficiency
- Built-in vacation mode feature – restores temperatures before arriving home

Communication

- Communicates with HAI home control systems and other automation systems
- Remote Internet and phone access (optional)
- Expansion port for wireless communication

HARC1000WH Omnistat2 **\$264.95**

1-Stage Conventional & Heat Pump

HARC2000WH Omnistat2 **\$309.95**

Multi-Stage & Heat Pump With Humidity Control

OMNISTAT ACCESSORIES

A HA23A001 Remote Indoor Temperature Sensor, Surface Mount **\$39.95**

B HA23A002 Remote Indoor Temperature Sensor, Flush Mount **\$44.95**

HA14A008 Water Temperature Sensor **\$84.95**

HA31A007 Extended Range Indoor/Outdoor Temperature Sensor **\$49.95**

HA31A008 Extended Range Indoor/Outdoor Temperature/Humidity Sensor **\$99.95**

HA29A001 Omnistat Relay Isolation Module **\$64.95**





Hi-Fi 2 By HAI
Audio System.
See Page 65.



WIRELESS CONTROL OF YOUR HOME AUTOMATION & AV SYSTEMS!

HAI HOME THEATER EXTENDER 2 (HTX2)

The HAI Home Theater Extender 2 (HTX2) lets you extend your home control to the existing audio/video equipment in your home theater. Users can control their home theater equipment from an iPhone, iPad, or iPod Touch using the HAI Snap-Link Mobile for iPhone app, or via an HAI OmniTouch 5.7e Touchscreen.

The HTX 2 sends IR commands to your A/V equipment. Interfaces are customizable using HAI Automation Studio (for HAI Touchscreens) and Mobile Designer (for iPhone/iPad), which allows you to set up pages to control each A/V device in your household. Mobile Designer is included with the purchase of an HTX2.

How Does It Work? An HAI HTX 2 can be controlled from multiple interfaces and is configured using HAI Automation Studio software. Users can control their AV equipment using an in-wall Touchscreen or Snap-Link Mobile for iPhone/iPad.

The Touchscreen/ iPhone sends commands to the HTX 2, which controls A/V equipment using its serial and IR ports, as well as its SPDT relays and TCP/IP.



Automate any Room without an HAI controller! With the HAI HTX 2, a customizable OmniTouch Touchscreen, and Automation Studio you may automate any room, whether it is a home theater, corporate boardroom, or a school's classrooms.

You can set up a single button to close the curtains/shades, lower a screen, and turn on the appropriate A/V equipment.

When you add an HAI home control system to this set up, you can add control of the room's lighting, temperatures, and more to the same button on the Touchscreen.



CUSTOMER FAVORITE!

HA86A002 HAI Home Theater Extender 2 (HTX2) **\$619.95**
HA1126 HAI Automation Studio **\$384.95**

HAI SOFTWARE OPTIONS

HOME CONTROL

HAI's Home Control allows you to control all of your HAI Home Control Systems features using a single media center remote. It provides an affordable and complete home control system with a familiar and user-friendly interface.



HA1109 Home Control **\$99.95**
HA1110 Web Link II & Home Control **\$329.95**

PC ACCESS

PC Access allows you to set up, program, and monitor a home control system over a modem or by a serial or network connection. PC Access is the only software product HAI offers that has the ability to program an HAI home control system.



HA1105W PC Access Software, for Installers **\$154.95**
HA1106W PC Access Software, for End Users **\$49.95**
HA1111 PC Access Software, for Lumina **\$39.95**

WEB-LINK II

All of HAI's Omni systems can be accessed via Internet. Remotely adjust your household settings for lighting, heating and air, security and appliances using the familiar point-n-click friendliness of software for Windows.



HA1108 Web-Link II Software **\$269.95**
HA1110 Web Link II & Home Control **\$329.95**

WL3

WL3 is an Add-in for a Home Control software that allows you to monitor and control your HAI system from any device with a web browser, such as an iPhone, iPod Touch, BlackBerry, smart phone, computer, PDA, etc.



HA1112 WL3 for a Windows Home Server **\$309.95**

HAI SNAP-LINK

HAI's Snap-Link is an encrypted USB key that plugs into any computer to monitor and control lights, security, temperatures and webcams over the Internet. It communicates through a secure ethernet port on an HAI home control system – no onsite computer is needed. It's easy to use and set-up because it is self-contained on the USB drive. Just plug it into any computer. Snap-Link is sold without any subscription fees.

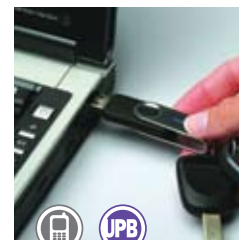

HA1120 HAI Snap-Link **\$99.95**
HA1120M HAI Snap-Link Mobile (for PDAs) **\$94.95**
IPHONEAPP33 HAI Snap-Link Mobile (for iPhone & iPad) **\$49.95**

	HOME CONTROL	SNAP-LINK	SNAP-LINK MOBILE	PC ACCESS	WEB-LINK II	WL3
Access via Internet	Remote Desktop	Yes	Yes	Yes	Yes	Yes
Dedicated Computer On-site	Yes	No	No	No	Yes	Yes
Client Software	Application	No (Runs On Client)	No (Runs On Client)	Yes (Installed On Client)	No (Uses Web)	No (Uses Web)
Installation Components	No	None	Application	Application	Web server	Application
Video Surveillance	Yes	Link to IP Camera	Link to IP Camera	No	Yes	Yes
Video Recording	Yes	No	No	No	Yes	Yes
User Interface	Television with remote	Application	Mobile Device	Application	Web	Web
Configure System	No	No	No	Yes	No	No
Program System	No	No	No	Yes	No	No
Create Rules/Alerts	Yes	Yes	No	No	Yes	Yes
Selectable Skins or Themes	No	Yes	No	No	Yes	Yes
Web Updates	Yes	Yes	Yes	Yes	Yes	Yes
RSS (Real Simple Syndication)	No	No	No	No	Yes	Yes

OPERATING SYSTEMS

- **Home Control:** Windows XP Media Center Edition software, Windows Vista Home Premium, Windows 7
- **Snap-Link:** Windows ME and higher
- **Snap-Link Mobile:** Windows Mobile 5.0 and higher and .NET Compact Framework 2.0
- **PC Access:** Windows 98E & higher, Windows Vista Ultimate, Windows Vista Home Premium, Windows 7
- **Web-Link II:** Windows XP Professional, Windows 2000, Windows Server 2003, Windows Vista, Windows 7 Pro/Ultimate
- **WL3:** Windows Home Server

HAI Safety & Security

HAI BY LEVITON

HAI Security
Camera Systems.
See Pages 46-47.



HAI ACCESS CONTROL

ACCESS CONTROL CARD READER

125 KHz high security, digitally encrypted, 26-Bit proximity card reader that connects to a serial port on an HAI Home Control System. The reader has durable and scratch resistant polycarbonate housing. Full epoxy potting ensures successful operation even in harsh environments. It can be mounted to a metal door frame (mullion) or to any flat wall surface. The two color LEDs (green and red) and Piezo sounder guarantee accurate and reliable door access operations.



HA75A002 Access Control Card Reader **\$209.95**

CHOOSE FROM TWO ACCESS CONTROL DEVICES

Access Control Card: 125 KHz credit card size 1.7mm thick high security proximity card with fully encrypted format stored on the card. It is preprogrammed at the factory with a unique encryption code. It provides a read range up to 4".



Access Control Key Tag: A very small (only 4 grams) 125 KHz high security digitally encrypted proximity key tag. It has a hole for a key ring or chain. It is pre-programmed at the factory with a unique encryption code. It provides a read range up to 2".



HA78A001 Access Control Card (10 Pack) **\$44.95**
HA78A002 Access Control Key Tag (10 Pack) **\$59.95**

ELECTRIC DOOR STRIKE

When used with Access Control Reader, the Electric Door Strike securely locks and unlocks a door without the need of a key. 12 VDC, Fail Secure.

HA79A001 Electric Door Strike **\$54.95**

ACCESS CONTROL KEYPAD

This access control keypad is designed to interface with any HAI Omni family or Lumina family home control system. The piezo-electric buttons work simply by tapping the surface.



HA54A001 Access Control Keypad **\$309.95**

POWER HUB

This general purpose 12VDC power supply is designed to provide power to several HAI products, including the HAI Access Control Readers with electric or magnetic locks, Omni Consoles, OmniTouch 5.7 Touchscreens, and many other devices.

HA83A001 Power Hub in Enclosure **\$254.95**

HA83A002 Power Hub for Structured Wiring Enclosures **\$254.95**

CELLULAR COMMUNICATION CENTER (C3)

Connects with any HAI Omni or Lumina system, as well as any security panel. Checks the status of the home phone line. If the phone line is unavailable, it will emulate the phone line signal, and the panel will dial out using your GSM cellular network to communicate with a central monitoring station and/or your cell phone. Requires GSM SIM card and cell service.

• Now supports Caller ID

HA70A002 Cellular Communication System **\$234.95**



CUSTOMER FAVORITE!

HAI WIRELESS

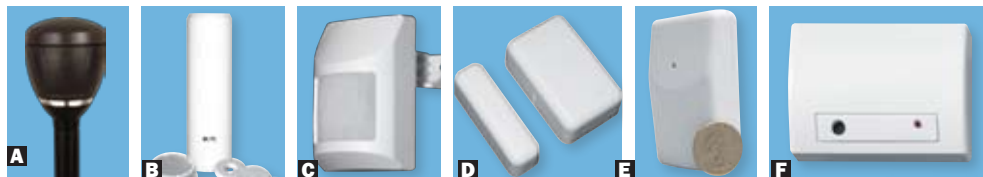

WIRELESS RECEIVER

Allows up to 64 unique wireless security transmitters to report information to an HAI controller. The wireless transmitters replace wired door and window sensors, as well as wired, motion and glassbreak detectors.

Includes Receiver Signal Strength Indicator (RSSI). That information is stored in the system and can be accessed from any HAI interface. This is important to ensure optimum placement of the transmitters and receivers.



HA45A001 Wireless Receiver for HAI Sensors **\$139.95**
HA42A002 Wireless Receiver for GE sensors **\$294.95**

See *GE Security Wireless Sensors & Compatible Sensors* On Page 40

WIRELESS TRANSMITTERS

A HA63A001 Driveway Sensor **\$209.95**
B HA56A001 Recessed Door/Window Transmitter **\$49.95**
C HA47A002 PIR Motion Detector **\$99.95**
D HA58A001 Door/Window Transmitter **\$49.95**
E HA46A001 Mini Door/Window Transmitter **\$39.95**
F HA61A001 Glassbreak Detector **\$99.95**
HA57A001 Vanishing Contact **\$64.95**



WIRELESS CONTROLLERS

G HA48A001 4-Button KeyFob Mini **\$39.95**
H HA50A001 Personal Panic Pendant **\$39.95**
I HA69A001 4-Button Keypad **\$59.95**

HAI OMNI SYSTEM ACCESSORIES

EXPANSION MODULES

HA10A06 16-Zone Hardwire Expander **\$94.95**
For Omni Pro II & Omni IIe
HA22A001 16-Zone Hardwire Expander **\$124.95**
For Omni LT
16-Zone Expander for OmniPro II and Lumina Pro only.
HA17A001 16-Zone Expansion (with Enclosure) **\$289.95**
HA17A009 16-Zone Expansion (for Structured Wiring Enclosures) **\$289.95**
HA17A008 16-Zone Expansion (Board Only) **\$239.95**

SPEAKER/MIC MODULES

HA28A001 Speaker/Mic Module, Surface **\$21.95**
HA28A002 Speaker/Mic Module, Flush **\$18.95**
HA10A111 2-Way Voice Module (required) **\$99.95**

RELAY MODULES

HA10A071 4 Relay Module **\$49.95**
HA19A001 8 Relay Module **\$64.95**

INSTALLATION ACCESSORIES

HA20A072 Mounting Plate **\$23.95**
For Omni IIe, OmniPro II, Lumina & Hi-Fi 2
HA21A072 Mounting Plate **\$18.95**
For Omni LT
HA21A061 Enclosure Lock & 2 Keys **\$4.95**
HANUVOKIT NuVo Serial Connectivity Kit **\$16.95**
Includes HA36A054 To Connect Omni To NuVo Audio System, Plus Required HA36A052 PIM To Serial Cable
HA1101A Programmable EnergySaver Module **\$59.95**

POWER ACCESSORIES (Required)

ELKTRG2440 Power Transformer **\$13.95**
Required For Omni Pro II & Omni IIe
ELKTRG1640 Power Transformer **\$13.95**
Required For Omni LT
IBSEC1075 Backup Battery, 7Ah **\$18.95**
TPAV550SC Tripp Lite Backup Power Block **\$229.95**
Recommended - See Page 75 For Details

M1 Home Automation Controllers ELK

The M1 controller offers unequalled automation control value. Unlike panels that may be strong in automation, but weak in security – or vice versa – the M1 boasts a rock solid security foundation with the most imaginative and powerful automation functionality available.

- 16-Zones expandable to 208
- Wireless capability: Up to 144-Zones
- RS232 Serial Port for computers and peripherals
- Menu driven, full text keypad programming
- 2-Way listen-in interface
- Voice Announcements (500+ word vocabulary)
- 13 On-board Outputs: 1 voice/siren, 1 siren driver, 1 Form-C relay and 10 low current (50mA) outputs
- Supports 4-wire (any zone) and 2-wire (zone 16) smoke detectors
- Fire alarm verification routine
- User Codes: 199 with assignable levels
- PC Programming Software includes conflict resolution to find differences between control and PC



ELK M1 GOLD

ELKM1G M1 Gold Controller **\$509.95**

ELKM1GSYS4S M1 Gold Controller Kit **\$679.95**

Includes M1 Gold Controller, Transformer, M1 KP2 LCD Keypad, 8Ah Battery, Speaker & RJ Set

ELKM1GSYS4 M1 Gold Controller Kit **\$708.95**

Includes M1 Gold Controller, Transformer, M1 KP LCD Keypad, 8Ah Battery, Speaker & RJ Set

ELKM1GSYS3 M1 Gold Controller Kit **\$548.95**

Includes M1 Gold Controller, Transformer, 8Ah Battery, Speaker & RJ Set (no keypad)

ELK M1 EZ8

The M1 Ez8 controller is identical to the Gold, minus Voice Messaging, Phone Interface and Voice Dialer.

ELKM1EZ8KB M1 Ez8 Controller Kit **\$517.95**

Includes M1 Ez8 Controller, Transformer, M1 KP LCD Keypad, 5Ah Battery, Speaker & RJ Set

ELKM1EZ8KBS M1 Ez8 Controller Kit **\$488.95**

Includes M1 Ez8 Controller, Transformer, M1 KP2 LCD Keypad, 5Ah Battery, Speaker & RJ Set

ELKM1EZ8MSI Serial Port for EZ8 (for PC programming or interfacing with peripherals) **\$42.95**

INTERFACE OPTIONS

NAVIGATOR

A Touchscreen Keypad for the M1 Control System, Navigator features a touch sensitive 3.5" LCD Color display with easy-to-use graphic icons and softkeys. Not only is Navigator stylish, but it also makes the M1 Control System extremely easy to operate.

- Hi-Contrast LCD Touchscreen Display
- Six Programmable Function Keys
- Operates on 4-wire RS485 Data Bus
- Built-in Piezo Sounder with Adjustable Pitch

ELKM1KPNV M1 Navigator Touchscreen **\$264.95**



ARMING STATION

D ELKM1KPAS M1 Arming Station **\$88.95**

M1 LCD KEYPADS

A ELKM1KP M1 KP LCD Keypad **\$165.95**

B ELKM1KP2 M1 KP2 LCD Keypad **\$137.95**

C ELKM1KP3 M1 KP3 LCD Keypad **\$149.95**



EXPANSION SYSTEMS

SOFTWARE SYSTEMS

ELKRP PC Programming Software **Free**

ELKRM Remote Management Software **\$149.95**

Control M1 from your PC, Pocket PC or PDA with the Remote Management Software

ELKM1XEP Ethernet Interface **\$234.95**

Control and view M1 from a computer – anywhere – with the Ethernet Interface



A



B



C

NEW

2-WAY WIRELESS TRANSMITTERS

ELKM1XRFTW Wireless Transceiver **\$142.95**

A ELK6022 Wireless Universal Sensor **\$79.95**

B ELK6020 Wireless Slim Door Sensor **\$59.95**

C ELK6021 Wireless Mini Window Sensor **\$55.95**

ELK6010 Wireless 4-Button Keyfob **\$61.95**

ELKM1XRFE GE Wireless Receiver **\$142.95**

See page 40 for GE Sensors.

Z-WAVE INTERFACE MODULE

Connect your M1 Control to your Z-Wave enabled devices with the M1 to Leviton Z-Wave Interface, a specialized M1 serial expander.

Now you can combine the innovation of Elk products with the wireless convenience of Z-Wave technology.

ELKM1XSLZW M1 to Z-Wave Interface **\$149.95**

LVRRCOP1LW Z-Wave Interface Module **\$129.95**

SUPERVISED REMOTE POWER SUPPLY

This Supervised Remote Power Supply can provide 12VDC output, supervise the AC Power Input, and report abnormal conditions back to the Control.

ELKP212S Supervised Remote Power Supply **\$154.95**

2-WAY VOICE INTERFACE

ELKM1TWI 2-Way Listen-in Interface **\$53.95**

ELKM1TWS Speaker/Mic **\$28.95**

SYSTEM EXPANDERS

ELKM1XIN 16 Zone Input Expander **\$102.95**

ELKM1XOVR 16 Zone Output Expander **\$145.95**

ELKM1RB Relay Board (8 Form-C Relays) **\$80.95**

ELKM1XSP Serial Port Expander & Thermostat/Lighting Interface **\$109.95**

ELKM1DBH Data Bus Wiring Hub **\$42.95**

ELKM1DBHR Data Bus Wiring Hub (retrofit) **\$78.95**

ELKM1KAM Single Door Access Module **\$127.95**

ZONE TEMPERATURE SENSORS

ELKM1ZTS Temperature Sensor **\$77.95**

ELKM1ZTSR Zone Temperature Sensor **\$108.95**

[More Elk M1 Info & Specifications »](#)
www.HomeControls.com/ElkProducts

GE Security NetworX



NetworX by GE Security is a control panel family that features a variety of interchangeable keypads and modules to meet the needs of practically any hardwire and/or wireless installation from 4 to 48 zones. Everything from the most basic to the most complex installation – multiple outputs, X10 home automation, 2-Way voice, telephone interface, with cellemetry or long-range radio backup. Better yet, the NetworX system uses only one method of programming for all of these installations.

The NetworX system standardizes a security control panel line for all your installations. It uses a combination of door and window sensors, glass break sensors and interior motion sensors to detect unauthorized entry. The keypad control is the interface for the various sensors connected to the NetworX System.

Sensors on doors that are used for entry and exit have a delay time allowing you to leave and enter while the system is Armed. For perimeter protection during occupancy, these delays can be omitted with the press of a button, and interior motion sensors can be bypassed to allow freedom of movement inside.

- All zones programmable as fire or burglary
- Up/downloadable with competitor lockout
- Modular design with slide in PC boards
- X-Pand-A-Can metal enclosure with tool tray
- Fuseless design
- Force arming by zone
- Automatic arming with auto retry
- Assign zones to 1 or multiple partitions



- Built-in siren driver/voltage out
- Voltage and current telephone line monitor

GE SECURITY NETWORX KITS

GENX4KIT NetworX NX-4, 4 Zones **\$104.95**

Includes Controller, GENX1308E Keypad & Transformer

GENX4KITLX NetworX NX-4, 4 Zones **\$94.95**

Includes Controller, GENX108E Keypad & Transformer

GENX6KIT8 NetworX NX-6, 6 Zones **\$139.95**

Includes Controller, GENX1448 Keypad & Transformer

GENX848KIT NetworX NX-8, 8 Zones **\$214.95**

Includes Controller, GENX148E Keypad & Transformer

GENX848EKIT NetworX NX-8E, 8 Zones **\$274.95**

Includes Controller, GENX148E Keypad & Transformer

GENX8EKIT7RF NetworX NX-8E, 8 Zones **\$284.95**

Includes Controller, GENX148ERF Keypad & Transformer

	NX-4	NX-6	NX-8	NX-8E
Programmable Zones	4	6	8	8
Expandable Zone	8	16	48	192
User Codes 4 Digit (6 digit)	8	40 (40)	99 (66)	240 (166)
Built-in Siren Driver	Yes	Yes	Yes	Yes
Event Log (Events)	Yes (185)	Yes (185)	Yes (185)	Yes (512)
Optional Duress Code (1)	Yes	Yes	Yes	Yes
Phone Line Monitoring/Voltage and Current	Yes	Yes	Yes	Yes
Fire Alarm Verification/Keypad Smoke Reset	Yes	Yes	Yes	Yes
Maximum Number of Keypads	8	16	32	32
Wireless Interface (Number of Points)	8	16	48	192
Zone Doubling (requires GENX200)	4	6	8	8
Number of Expansion Modules per Enclosure	2	3	3	3
On Board Auxiliary Outputs (# of Prog. Events)	2 (50)	4 (50)	4 (50)	4 (56)
Programmable Loop Response	No	No	Yes	Yes
2/4-Wire Smoke Detectors	2 or 4	2 or 4	2 or 4	2 or 4
Cam Lock/2 Keys Included	Yes	Yes	Yes	Yes
Power Supply with 40 or 50Va Transformer	1A	1A	1A	2A
Serial Port	No	No	No	Yes

More GE Security NetworX – Including Complete Kits, Control Panels, Expansions Systems, Keypads, Sensors & Accessories » www.HomeControls.com/GESecuritySystemsandAccessories



More Security Sensors From GE Security. See Page 40.

NETWORX INTERFACE

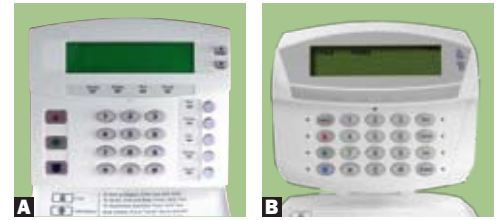

NETWORX KEYPADS

A GENX148E NetworX LCD Keypad **\$139.95**

A GENX148ERF NetworX LCD Keypad with 48-Zone RF Receiver **\$139.95**

B GENX1448E NetworX LCD Keypad **\$69.95**



C GENX124E NetworX LED Keypad, 24-Zone **\$67.95**

GENX116E NetworX LED Keypad, 16-Zone **\$64.95**

GENX108E NetworX LED Keypad, 8-Zone **\$54.95**

D GENX1516E NetworX LED Slimline Keypad **\$64.95**

ACCESSORIES

NETWORX HARDWIRED MODULES

GENX216 16-Zone Expansion Module **\$54.95**

GENX534E 2-Way Voice Audio Module **\$69.95**

GENX540E Telephone Interface Module **\$104.95**

GENX507E Relay Expander Module **\$84.95**



NETWORX WIRELESS MODULES

GENX548E 48-Zone Wireless Expansion **\$69.95**

E GENX450 Wireless Door/Window Sensor **\$49.95**

F GENX480 Wireless PIR Motion Detector **\$124.95**

GENX488 Wireless Glass Break Detector **\$109.95**

G GENX470 4-Button KeyFob Transmitter **\$44.95**

GETX6010011 Wireless Smoke Detector **\$89.95**

GENX497 Wireless CO Detector **\$139.95**

More GE Wireless Sensors. See Page 40.

NETWORX ACCESSORIES

GENX586E Quicklink Direct Connect **\$69.95**

GENX590E Network Module **\$289.95**

GENX216E NetworX 16-Zone Expander **\$89.95**

GENX003 NetworX X-Pand-A-Can Enclosure **\$24.95**

GEP0003 Serial Cable for NetworX NX-8E **\$24.95**



AWARD WINNING LEADERS
Your Satisfaction Is Guaranteed (See Page 94)

Linear Security

Linear

WIRELESS

DVS WIRELESS SECURITY SYSTEM

With the DVS series, Linear has put together a complete range of home security solutions, so you can build just about any type of system you need. This tremendous flexibility is made possible by two supervised control panels with differing capacities, but with identical operating features and the same exceptional performance.

The DVS-1200 is a Wireless console intended for apartments, condos, townhouses, smaller homes, and any other sites that require 12 zones of protection or less. The DVS-2400 is for larger residences, offering double the DVS-1200's capacity - 24 wireless zones.

The DVS series controls have six operating modes and can be configured for one-button operation, for eight user codes (including duress), and to the SIA false alarm standard. Installation and programming are made easy by quick-learn transmitters and default settings that eliminate many steps. Two optional plug-in boards add



valuable communications capabilities, including voice prompts, touch-tone telephone access, and a two-way voice link for central station monitoring.

Compatibility with the industry's widest line of transmitters and sensors (Linear's supervised DXS series and non-supervised DX series) means systems can be tailored by site and by need.

LNDVSKIT51 Linear Supervised Wireless Security Console Kit, 24-Channel **\$357.99**

Includes Console, 2-Way Voice Board, 2 Door/Window Sensors, Motion Detector, Remote Controller, Power Supply & Accessories.

LNDVSKIT22 Linear Supervised Wireless Security Console Kit, 12-Channel **\$282.99**

Includes Console, Door/Window Sensor, 2 Motion Detectors, Power Supply & Accessories.

LNDVS2400 Linear Supervised Wireless Security Console, 24-Channel **\$242.99**

LNDVS1200 Linear Supervised Wireless Security Console, 12-Channel **\$220.99**

HARD-WIRED/WIRELESS

DVS HYBRID SECURITY SYSTEM

The Wireless/Hardwire Security Panel is a hybrid alarm control that includes its own built-in superheterodyne receiver with a measured range of 1,500'. It has 6 operating modes and can be configured for 1-button operation, for 8 user codes (including duress), and to the SIA false alarm standard.

Homeowner controls for the DUAL 824 are centralized on an easy-to-read, backlit, full-function keypad with numeric indicators for each of 24 supervised wireless sensor zones and up to 8 hardwire loops. The DUAL 824 supports the addition of a second hardwire keypad. A built-in piezo generates alert and alarm tones.

The DUAL 824's control panel is housed in a high-impact plastic box, along with the receiver and a rechargeable back-up battery that features 40 hours of standby power. Inside, there is plenty of room for wire and the battery.

The DUAL 824 has 6 operating modes and can be configured for 1-button operation, for 8 user codes (including duress), and to the SIA false alarm standard.

Compatibility with industry's widest line of transmitters and sensors (Linear's supervised DXS series and non-supervised DX series) means that systems can be easily tailored by site and by need.

LNDVSKIT63 Linear Supervised Hybrid Wireless/Hardwire Security Kit **\$379.99**

Includes Controller, Keypad, 2-Way Voice Board, 2 Door/Window Transmitters, Motion Detector, Remote Controller, Power Supply and Accessories.

LNDUAL824 Linear Supervised Hybrid Wireless/Hardwire Security Panel **\$176.99**

Includes Controller & Keypad.

ACCESSORIES

Compatible with both the DVS Wireless and DVS Hard-wired/Wireless DUAL 824 Security System.

LINEAR ACCESSORIES

LNLAP External Antenna Kit **\$23.99**

LNRSM1 Remote Speaker/Microphone **\$43.99**

LNVB2 2-Way Audio & Remote Command Module with Voice Prompts **\$66.99**

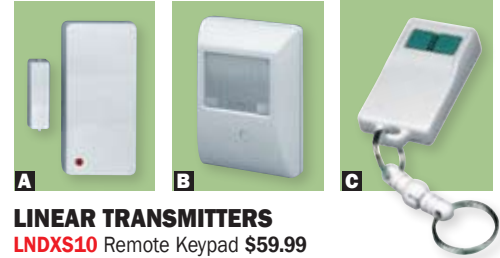

LINEAR REMITTERS

LNDXS10 Remote Keypad **\$59.99**

A LNDXS31 Door/Window Transmitter **\$41.99**

LNDXS32 Miniature Door/Window Transmitter **\$39.99**

B LNDXS54 PIR Motion Transmitter **\$92.99**

LNDXT41 1-Button, 1-Channel Transmitter **\$44.99**

C LNDXT42 2-Button, 3-Channel Transmitter **\$45.99**

LNDXS91 Glass Break Detector Transmitter **\$132.99**

LNDXS73 Smoke Detector Transmitter **\$119.99**



MORE SECURITY SYSTEMS!

HAI OMNI

An Omni home control system takes the place of a standard security system. It provides the ultimate in safety for your family with features not found in a standard security system. Plus, it's a complete home automation system! The Omni family of home control systems consists of the OmniPro II, the Omni IIe, and the Omni LT to meet virtually all size, sophistication, and pricing requirements.



» homecontrols.com/HomeAutomationInc

ELK M1

Elk's M1 Controls incorporate security, fire, door entry control, and energy and task management to provide total control of the home. By working with products from over 50 partner manufacturers, the M1 offers a truly integrated solution. These IP accessible systems offer simple, yet powerful on-site and remote user interfaces, giving the consumer full control anytime, from anywhere.



» homecontrols.com/ElkProducts

NAPCO GEMINI

Napco is a diversified manufacturer of security products, encompassing intrusion and fire alarms, building access control systems, video surveillance and electronic locking devices. Gemini Home Security Systems are simply smarter, more family-friendly and more affordable than ever before. Gemini offers a hybrid of hardwired and wireless system components to suit your household today and tomorrow.



» homecontrols.com/NapcoSecuritySystems

FREE PRODUCT ADVICE & SUPPORT » **800-266-8765**

33

DIY Wireless Security

SKYLINK SecurityMan

SKYLINK WIRELESS SECURITY SYSTEMS

SKYLINK AAA+ HOME SMART CENTER

The Skylink Wireless AAA+ Home Smart Center is a complete wireless system that functions as both a security system and a home automation center. As a security system, the Center monitors your premises and alerts you when sensors are triggered. As a home automation system, the Center provides remote operation of household appliances and lights, even when you are away from home. This full-featured system is expandable and can be easily customized to suit your needs.

- User can call in to check system status
- Employs Skylink's rolling code technology
- Works with up to 10 sensors, 5 control modules and 5 keychain remotes

SKML100 Skylink Wireless AAA+ ML-100 Home Smart Center **\$159.95**

Includes ML-100 Console, Keychain Remote, 2 Door/Window Sensors, Motion Sensor, Power Supply & Accessories.

SKYLINK WIRELESS AAA+ COMPONENTS

- A SKAS101** Skylink AAA+ Audio/Alarm Sensor **\$39.95**
- SKRP434** Skylink AAA+ Repeater **\$34.95**
- SKPS101** Skylink AAA+ Motion Sensor **\$29.95**
- B SKGS101** Skylink AAA+ Garage Door Sensor **\$20.95**
- C SKFS101** Skylink AAA+ Flood Sensor **\$20.95**
- SKWD101** Skylink AAA+ Door/Window Sensor **\$20.95**
- SK4B101** Skylink AAA+ Keychain Transmitter **\$20.95**

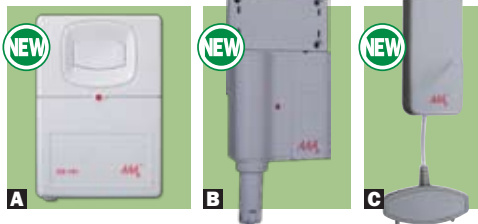

Visit the [Home Controls website](http://www.homecontrols.com) for more accessories and expansion options – including the Skylink Wireless AAA+ AC-100 Home Smart Control Center » www.homecontrols.com/SecurityPropertyProtection

SKYLINK WIRELESS SECURITY SYSTEM

The Skylink Wireless Security Alarm System provides everything you need to set up a highly-effective, cost-effective, and impermanent security system. The wireless system requires only basic installation and operates without a monitoring service.

- No monitoring fees
- Easy to install
- Rolling code technology
- Automatically calls for help in an emergency
- Supports up to 30 sensors

Control Panel: If any of the wireless sensors are triggered when the system is armed, the siren will sound and the Control Panel will send a wireless signal to the dialer that will call for help at the same time.

Emergency Dialer: Program the emergency dialer to call up to 9 different phone numbers, including your own cell phone, your doctor, relatives, friends, neighbors and more.

SKSC100x Skylink Wireless Complete Wireless Security System **\$199.95**

Includes Control Panel, 1-Way Dialer, Motion Sensor, 2 Door/Window Sensors, Keychain Remote, Power Supply & Accessories.

SKSC100 Skylink Wireless Deluxe Wireless Security System (no dialer) **\$134.95**

Includes Control Panel, Motion Sensor, 2 Door/Window Sensors, Keychain Remote, Power Supply & Accessories.

SKYLINK WIRELESS COMPONENTS

- SKTS101A** Skylink Temperature Sensor **\$44.95**
- A SKAA433** Skylink Remote Audio Alarm **\$39.95**
- SKAS433** Skylink Alarm Sensor **\$39.95**
- SKKP434** Skylink Keypad Transmitter **\$34.95**
- B SKSW433** Skylink Silent Alarm **\$34.95**
- SKPS434** Skylink Motion Sensor **\$29.95**
- SKVS433** Skylink Vibration Sensor **\$26.95**
- SKWT433** Skylink Door/Window Sensor **\$24.95**
- SK4B434** Skylink Keychain Transmitter **\$22.95**
- SKPT434** Skylink Panic Transmitter **\$21.95**



SKHW434 Skylink Wrist Watch Remote **\$21.95**

C SKMS001 Skylink Magnetic Switch **\$10.95**

CUSTOMER FAVORITE!



AIR-ALARM

AIR-ALARM

SecurityMan Air-AlarmII is a wireless LED touchpad security alarm system kit with doorbell for home and business. It is user-friendly easy to use protecting home/business at a minimum cost of investment.

Do-It-Yourself installation and monitoring alarm system without monthly fees is a key benefit for users. The system will alert by phone calls to owner through a series of enlisted phone numbers. The owner can then dial into the host to arm or disarm using the phone's numeric keypad.

Air-AlarmII system can be upgraded by adding up to 60 wireless sensors, sirens, and up to 10 remote controllers.

- Supports up to 5 phone numbers for auto alarm call and 1 management center protocol
- Armed/disarmed by remote controller, phone call, or host's keypad.
- Easy "one-key" armed/disarmed operation.

TLAIRALARMII Air-AlarmII Kit **\$139.99**

Includes Console, PIR Motion Sensor, Door/Window Sensor, Indoor Siren, 2 Remote Controls, Wireless Doorbell, Warning Sign, Power Supply & Accessories

TLAIRALARMIIDL Air-AlarmII Kit, Deluxe **\$169.99**

Includes Console, 2 PIR Motion Sensors, 3 Door/Window Sensors, Smoke Sensor, 2 Remote Controllers, Warning Sign, Power Supply & Accessories.

TLAIRALARMIII Air-AlarmII Kit, Economy **\$94.99**

Includes Console, PIR Motion Sensors, Door/Window Sensors, 2 Remote Controllers, Warning Sign, Power Supply & Accessories.



AIR-ALARM WIRELESS COMPONENTS

- A TISM82** Air-Alarm Wireless Doorbell Button **\$21.95**
- B TISM93** Air-Alarm Smoke Detector **\$24.95**
- C TISM89** Air-Alarm Wireless Panic Button **\$15.95**
- TISM80** Air-Alarm PIR Motion Sensor **\$18.95**
- TISM103W** Air-Alarm Indoor Siren **\$29.95**
- TISM103** AirAlarm Outdoor Siren **\$64.95**
- TISM88X** Air-Alarm Keychain Remote Control **\$15.95**
- TISM89** AirAlarm Panic Button **\$15.95**



INSTALLATION ASSISTANCE
Call 1-800-266-8765 for Free Tech Support!

Access Controls

Kwikset *Linear* SECO-LARM

KEYPADS

KWIKSET SMARTCODE LOCKS

The SmartCode Locks with Home Connect Technology allows you to unlock your door and to then communicate with other devices in home. Using a web-enabled device, you can even remotely check the door lock status, lock or unlock the door and receive text or email messages.



- Featuring SmartKey Re-key Technology. It's a lock you can re-key yourself in seconds.
- SmartKey cylinders feature a stainless steel side-locking bar, racks and pins for increased security.
- Patented side locking bar technology offers improved security by protecting against lock bumping, an attack technique used to defeat conventional pin and tumbler locks.
- Color: Choose from Satin Nickel, Polished Chrome, Satin Chrome and Venetian Bronze

KWIKSET SMARTCODE LOCKS WITH Z-WAVE

- A KW99120TRLx** Kwikset SmartCode Z-Wave Traditional Leverset **\$269.95**
- B KW99100TRLx** Kwikset SmartCode Z-Wave Traditional Deadbolt **\$269.95**
- C KW99100CNTx** Kwikset SmartCode Z-Wave Contemporary Deadbolt **\$269.95**



KWIKSET SMARTCODE LOCKS WITH ZIGBEE

- A KW99120ZWTRLx** Kwikset SmartCode ZigBee Traditional Leverset **\$264.95**
- B KW99100ZWTRLx** Kwikset SmartCode ZigBee Traditional Deadbolt **\$264.95**
- C KW99100ZGCNTx** Kwikset SmartCode ZigBee Contemporary Deadbolt **\$264.95**

SECO-LARM DIGITAL KEYPADS

- Form-C relay outputs (5A@28VDC)
- 100 unique 4-8 digit codes, 10,000 possible user code combinations
- Stainless-steel face, durable and attractive
- Programmable lockout output after 5-10 unsuccessful attempts to key in code

SESK1011SQ Digital Keypad (100 users, 1 output) **\$44.95**

SESK1131SQ Digital Keypad (120 users, 3 outputs), with Backlight **\$54.95**

SESK1123SQ Rugged Outdoor Access Keypad (110 users, 2 outputs) **\$99.95**

The Keypad Can Be Programmed To Operate A Fail-Safe Or Fail-Secure Locking Device

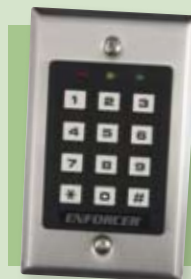

LINEAR ACCESS KEYPADS

- 480 programmable input codes
- Metal keys with system status indicator
- 2 Form-C Output relays; 2 open collector outputs
- Door Sense input; Inhibit input; Request-to-Enter input; Alarm Sound output; Timed Anti-Passback, Keypad Lockout
- Tactile and Audio feedback

A LNAK21W Outdoor Access Keypad **\$177.99**

B LNAK31 Indoor Access Keypad **\$100.99**



More Access Control Keypads Online » www.homecontrols.com/Access-Control

CARD READERS

SECO-LARM ACCESS CARD READER

No more need for regular keys with this stand-alone proximity reader. Program up to 100 user cards to gain access to your home, gates, apartments or other locations. Mounts easily to interior and exterior walls.

- Weatherproof
- Buzzer is programmable for audible confirmation or silent mode
- Includes 10 proximity cards

SEPR112SA Enforcer Proximity Card Reader **\$144.95**

SEPRK1S1A Extra Proximity Cards, 125-pack **\$18.95**



DOOR STRIKES

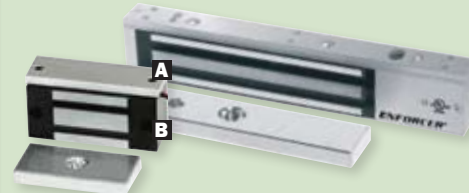

ELECTROMAGNETIC LOCKS

- Anodized aluminum housing
- Dual voltage: 12 or 24VDC
- Mini Door Lock suitable for small, low-security doors including cabinets and drawers

ELECTROMAGNETIC LOCKS

A SEE941SA600 Electromagnetic Lock **\$94.95**

Hold Force: 60 lbs.

A SEE941SA1200 Electromagnetic Lock **\$114.95**

Hold Force: 1,200 lbs.

SEE941S600ZQ Mounting Bracket **\$54.95**

MINI ELECTROMAGNETIC LOCKS

B SEE941SA80 Mini Electromagnetic Lock **\$44.95**

Hold Force: 80 lbs.

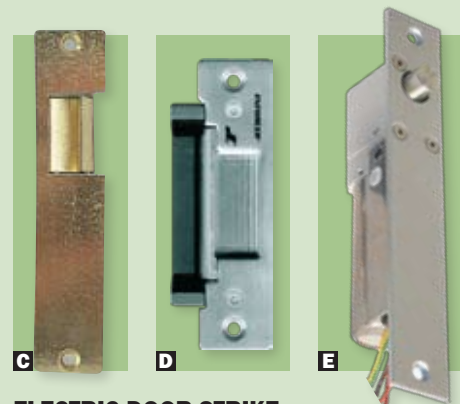

ELECTRIC DOOR STRIKE

Add electric door strikes to remotely or automatically control your door locks.

LEE ELECTRIC DOOR STRIKE FOR WOOD DOORS

C LE22016VAC Electric Door Strike, 3-6VDC **\$24.95**

C LE22012VDC Electric Door Strike, 12VDC **\$24.95**

SECO-LARM ELECTRIC DOOR STRIKE FOR METAL DOORS

The Electric Door Strike converts a cylindrical lock set to an electronic access controlled locking system. The strike is field-programmable in just seconds for fail-secure or fail-safe applications.

D SESD995C Electric Door Strike, 12 VDC **\$79.95**

D SESD995C24 Electric Door Strike, 24 VDC **\$79.95**

LEE ELECTRIC DOOR STRIKE FOR METAL GATES DOORS

LE516VAC Mortise Door Strike, 3-6VDC **\$34.95**

LE512VDC Mortise Door Strike, 12VDC **\$34.95**

SECO-LARM MORTISE TYPE ELECTRIC DEAD BOLT

Locked when energized. Bolt is projected when the solenoid is energized, retracted when power is Off.

E SESD997BQ Electric Dead Bolt **\$144.95**

Remotes For Any Security System

LINEAR WIRELESS TRANSMITTERS & RECEIVERS

For almost 50 years, Linear has been a leader in the development of radio frequency transmitters and receivers for the professional security market. Linear offers a wide range of wireless add-ons, as well as a variety of complete systems based on these RF links. Linear manufactures whatever you need for creating wireless security – panics, remotes, door/windows, smokes, PIRs, bill traps, glass breaks, plus all the receivers and controllers that support them.

DX Format: DX transmitters utilize optimized pulse position-based RF transmission technology. DX receivers support up to 32 quick-learn transmitters, and support over one million unique transmitter codes.

DXS Format: Designates fully supervised models of these same transmitters and receivers, with up to 1,500 feet of range.

LINEAR DX & DXS RECEIVERS

In a typical installation, a wireless receiver is connected to an alarm control panel, door strike, camera, high current relay or other device. Transmitters are used to activate or control those devices. The digital DX/DXS code format features over a million possible codes. The transmitters are precoded at the factory to unique codes, so no field coding is required. For versatility, any transmitter can be programmed into any receiver channel.



- Compatible with DX and DXS transmitters
- 32 transmitter capacity
- Measured line-of-sight range of 1,500 Feet
- Quick-learn programming
- Selectable supervision
- Outputs per RF channel for alarm, low battery, and status trouble reports
- LED Indication for alarm, low battery and status
- 100 mA maximum output rating
- Selectable outputs per channel: momentary, latch, toggle
- DX Receiver Size: 5.5" W x 4.0" H x 1.25" D
- DXS Receiver Size: 7.25" W x 5.0" H x 1.0" D

- LNDXR701** Linear DX Receiver, 1-Channel, Unsupervised **\$58.99**
LNDXR702 Linear DX Receiver, 2-Channel, Unsupervised **\$69.99**
LNDXSR1504 Linear DXS Receiver, 4-Channel, Supervised **\$73.99**
LNDXSR1508 Linear DXS Receiver, 8-Channel, Supervised **\$84.99**
SESTUV12S05Q 12DC Power Supply, 500mA **\$8.95**

Power Supply Required On All Receivers

DX TRANSMITTERS

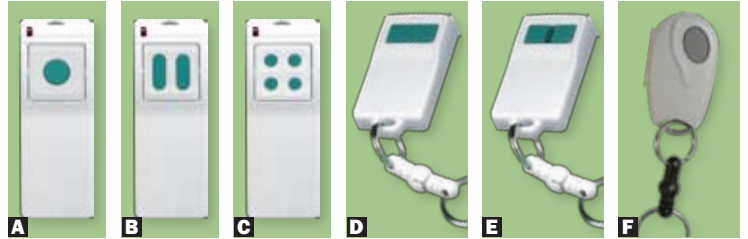

- A LNDXT21** Linear DX 2-Button, 1-Channel Handheld Transmitter **\$37.99**
B LNDXT23 Linear DX 3-Button, 4-Channel Handheld Transmitter **\$42.99**
C LNDXT25 Linear DX 5-Button, 8-Channel Handheld Transmitter **\$58.99**
D LNDXT41 Linear DX 1-Button, 1-Channel Key Ring Transmitter **\$44.99**
E LNDXT42 Linear DX 2-Button, 3-Channel Key Ring Transmitter **\$45.99**
F LNDXT601 Linear DX 1-Button, 1-Channel Key Ring Transmitter **\$44.99**
LNDXT31 Linear DX Door/Window Transmitter **\$40.99**
LNDXT54 Linear DX Passive Infrared Motion Detector Transmitter **\$84.99**

DXS TRANSMITTERS

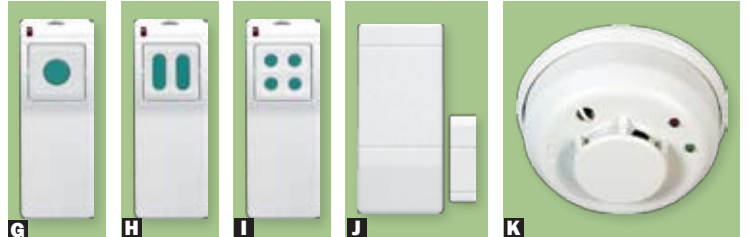

- G LNDXS21** Linear DXS 2-Button, 1-Channel Handheld Transmitter **\$43.99**
H LNDXS23 Linear DXS 3-Button, 4-Channel Handheld Transmitter **\$48.99**
I LNDXS25 Linear DXS 5-Button, 8-Channel Handheld Transmitter **\$64.99**
J LNDXS31 Linear DXS Door/Window Transmitter **\$41.99**
LNDXS32 Linear DXS Miniature Door/Window Transmitter **\$39.99**
LNDXS54 Linear DXS Passive Infrared Motion Detector Transmitter **\$92.99**
K LNDXS73 Linear DXS Photoelectric Smoke Detector Transmitter **\$119.99**
LNDXS80 Linear DXS Carbon Monoxide Detector Transmitter **\$118.99**
LNDXS91 Linear DXS Glass Break Detector Transmitter **\$132.99**

SECO-LARM WIRELESS TRANSMITTERS & RECEIVERS

	4-CHANNEL RECEIVER	2-CHANNEL RECEIVER	1-CHANNEL RECEIVER
Operating Distance	Up to 500' open air	Up to 500' open air	Up to 500' open air
Current Drain	8mA at 12VDC (standby), 45mA at 12VDC (flashing)	8mA at 12VDC (standby), 45mA at 12VDC (flashing)	8mA at 12VDC (standby), 45mA at 12VDC (flashing)
Sensitivity	-87dBm (typical)	-87dBm (typical)	-87dBm (typical)
Data Format	PWM	PWM	PWM
RF Codes	68 billion	68 billion	68 billion
Stored Codes	15 per channel	15 per channel	Up to 15 transmitter codes
	SESK910R4Q \$54.95	SESK910RB2Q \$39.95	SESK910RQ \$34.95

COMPATIBLE TRANSMITTERS



SESK919TP4JNU
\$22.95

SESK919TP4HNU
\$39.95

SESK919TD2AUP
\$17.95

SESK919TP2HNU
\$34.95

SESK919TD1SUP
\$16.95

SESK919TP1HBU
\$29.95



LINEAR EXTENDED MID-RANGE TRANSMITTERS & RECEIVERS

The transmission/ reception range is more than 10 miles with a long range antenna. This extended range system is fully supervised and actually checks itself out. The transmitters have NO/NC loop inputs, with an output of 10W. The receivers have NO/NC dry contact outputs. Both require 12 to 13½VDC power. The handheld, 2W transmitter includes an antenna and 2 9V batteries.

- LNXT1** 1-Channel Transmitter. **\$221.99**
- LNXT1H** 1-Channel Handheld Transmitter **\$251.99**
- LNXT4** 4-Channel Transmitter **\$230.99**
- LNXT4H** 4-Channel Handheld Transmitter **\$268.99**
- LNXR1** 1-Channel Receiver **\$232.99**
- LNXR4** 4-Channel Receiver **\$266.99**
- LNXR16** 16-Channel Receiver **\$295.99**
- LNANT1A** 8" Rubber Antenna **\$25.99**
- LNANT2** 3' Antenna with 18' Coax **\$49.99**
- LNT1224DC** Power Supply for XT/XR **\$35.99**

STREET SMART

CODE ENCRYPTOR 3

Honeywell's Street Smart Series Code Encryptor 3 (CE3) is the best universal remote kit in the industry. It is ideal for systems that just need remotes.



The CE3 provides Away, Stay and Off with the touch of a button. It also offers Panic with a two-button press, all through the data bus. For added convenience, a tricolor LED status light and plate is included to visually alert the user to the status of the keypad.

- SSCE3** Code Encryptor 3 **\$64.95**
For Caddx NX, DSC, Honeywell-Ademco-Vista
- SSCEREMLXB** Extra Keychain Remote **\$22.95**

WIRELESS AUTOMATOR KIT

Universal receiver/transmitter kit can be used for lighting, key switch, garage doors, magnetic locks, gates or any item that can be controlled by a relay.



- Up to 500' range
- (6) Form-C relays (10A at 12VDC)
- Each relay programmable (8 modes)
- 12VDC power supply included
- 4 Billion Encrypted Codes
- Learn in Up to 7 remotes

- SSWA6R** Wireless Automator with Remote **\$99.95**
- SSCEREMWA** Extra Keychain Remote **\$29.95**

INOVONICS WIRELESS TRANSMITTERS & RECEIVERS

Inovonics EchoStream provides unique flexibility among wireless security systems - it can be used with any control panel, so you can select your panel of preference and still expand with a complete line of wireless security transmitters and receivers. The platform features a full range of security end-points for burglary, intrusion monitoring and duress. EchoStream is the third generation radio platform from Inovonics and the result of decades of experience developing wireless security applications for commercial customers. It delivers outstanding reliability, range and battery life that meet the security industry's needs today and well into the future.



INOVONICS RECEIVERS

Receivers are the robust communication link between the EchoStream wireless network and virtually any integrator developed or PC based application. These receivers offer the ultimate flexibility for managing and monitoring the EchoStream network while providing advanced functionality as the wireless gateway to integrated applications. All receivers feature Inovonics EchoStream technology with diversity reception and advanced signal processing to minimize nulls, or dead spots, and provide superior performance in noisy RF environments.

- A INEN4000** Universal Serial Receiver **\$254.95**
- B INEN4200** Security Only Serial Receiver **\$169.95**
- C INEN4204R** 4-Zone Add-On Receiver with Relay Outputs **\$139.95**
- INEN4216MR** 16-Zone Multi-Condition Receiver with Relay Outputs **\$269.95**
- INEN4232MR** 32-Zone Multi-Condition Receiver with Relay Outputs **\$354.95**
- INEN7286NX** Serial Receiver/Interface for GE NetworX Panel **\$319.95**

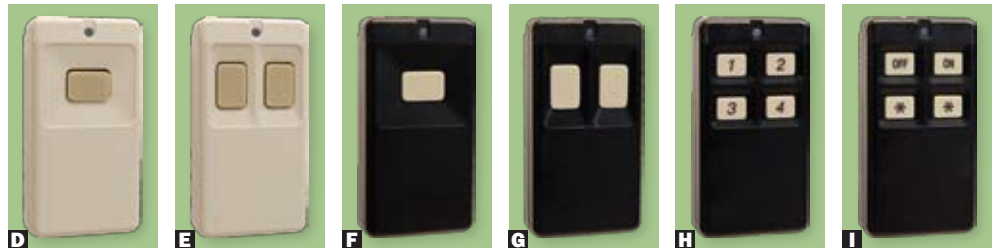

INOVONICS PENDANT TRANSMITTERS

- D INEN1233S** 1-Button Necklace Pendant Transmitter **\$69.95**
- E INEN1233D** 2-Button Necklace Pendant Transmitter **\$69.95**
- F INEN1235S** 1-Button Belt Clip Pendant Transmitter **\$74.95**
- G INEN1235D** 2-Button Belt Clip Pendant Transmitter **\$74.95**
- G INEN1238D** 2-Button 2-Condition Pendant Transmitter **\$74.95**
- G INEN1236D** 2-Button 3-Condition Pendant Transmitter **\$74.95**
- H INEN1224** 4-Button Multiple Condition Pendant Transmitter **\$79.95**
- I INEN1224ON** 4-Button Multiple Condition On/Off Pendant Transmitter **\$79.95**
- J INEN1223D** 2-Button Water-Resistant Pendant Transmitter **\$74.95**



OPTEX iSERIES: Optex's outdoor wireless detectors now come with the Inovonics EchoStream EN1941 transmitter already installed. [More Online » www.HomeControls.com/Inovonics-Wireless-Transmitters](http://www.HomeControls.com/Inovonics-Wireless-Transmitters)



INOVONICS SPECIALTY TRANSMITTERS

- K INEN1210** 1-Input Universal Transmitter **\$54.95**
- K INEN1212** 2-Input Universal Transmitter **\$59.95**
- INEN1210W** Door/Window Transmitter with Reed Switch **\$59.95**
- L INEN1261HT** High Traffic Four Element Motion Detector **\$134.95**
- INEN1262** Motion Detector with Pet Immunity **\$139.95**
- INEN1265** 360° Ceiling Mount Motion Detector **\$144.95**
- INEN1242** Smoke Detector Transmitter **\$129.95**
- INEN1247** Glassbreak Detector Transmitter **\$129.95**
- INEN1249** Billtrap Transmitter **\$109.95**



Remote Monitoring Systems

SENSAPHONE

The Sensaphone offers an easy, inexpensive way to monitor any house, cabin or vacation home. Installed in a clean indoor environment, it has built-in monitoring for power failures, temperature, and sound monitoring of audible alarms.

Four external inputs can be connected to various external sensors to monitor temperature, water, humidity, intrusion and more. When an alarm is detected, the Sensaphone can notify 4 or 8 people by phone.

- Programmable recognition times
- Low voltage NO/NC output relay included
- Manual or automatic alarm response switching
- Makes voice phone calls with customized messages for easy identification
- Built-in alarm test function to simulate and test the notification process
- Internal microphone for custom voice message recording and remote listen-in



- PHFGD0400** Sensaphone Monitoring System, 4 Channel **\$355.50**
PHFGD0800 Sensaphone Monitoring System, 8 Channel **\$535.50**
PHFGDW600 Sensaphone Web600 Web-Based Monitoring System **\$355.50**

SENSAPHONE ACCESSORIES

- PHFGD0049B** Smoke Detector (with battery backup) **\$65.00**
PHFGD0100 Remote Temperature Sensor **\$18.00**
PHFGD0103 Wall Mount Temperature Sensor **\$36.00**
Compatible only with the PHFGDW600
PHFGD0013 Water Sensor **\$81.00**
PHFGD0056 Zone Water Sensor **\$121.50**
PHFGD0007 PIR Motion Sensor **\$71.10**
PHFGD0027 Humidistat Sensor **\$40.00**

For a Live
Sensaphone Demo,
call 610-558-4591.

ENVIROALERT

EnviroAlert provides the flexibility to simultaneously monitor temperature, humidity or water in one or more independent zones. Potential applications include monitoring coolers, freezers, basements, document storage areas, computer rooms, laundry rooms and more!

- Expanded temp range: -58 to 299° F
- Interchangeable probes
- Ability to calibrate zones
- User friendly programmability
- Ability to run probe 1,000' from base unit
- Ability to connect humidity sensors
- Offers 8 event alarm history
- Power supply sold separately



- WLEA20012** EnviroAlert Multi-Function Monitoring Console, 2 Zones **\$104.95**
WLEA40012 EnviroAlert Multi-Function Monitoring Console, 4 Zones **\$249.95**
ST900050 Adjustable DC Power Supply, 500mA **\$6.55**

ENVIROALERT ACCESSORIES

- WLTEMPHS** High Temp Thermistor Probe (32 to 299° F) **\$64.95**
WLTEMPLS Low Temp Thermistor Probe (-58 to 158° F) **\$49.95**
WLTEMPLW Waterproof Low Temp Thermistor Probe (-58 to 158° F) **\$49.95**
WLTEMPHW Waterproof High Temp Thermistor Probe (32 to 221° F) **\$69.95**
WLWSS Supervised Surface Water Sensor **\$26.95**
WLWUCS Supervised Under Carpet Water Sensor **\$34.95**
WLHAIIPLUS Electronic Humid Alert **\$149.95**

EnviroAlert EA800 provides the flexibility to monitor up to 8 sensors simultaneously (4 wired, 4 wireless).
www.HomeControls.com/Winland-EnviroAlert-Systems



SECURITY SIRENS & SPEAKERS

SECURITY SIRENS



These weatherproof sirens offer dual tone warbling, steady sirens and rugged construction.

- A SPSA15RP** Dual Tone Siren, 30W **\$29.95**
 30W Dual Tone Self Contained Alarm Siren, 120dB, 6-12V C, 5"D x 8"L
B SPSA5P Electronic Siren, 20W **\$11.95**
 20W Dual Tone Self Contained Alarm Siren, 115dB, 12VDC, 5"D x 6"L

COMPACT ECHO SIREN

- 2-Tone (Yelp/Steady) Siren
- Includes mounting hardware
- Paintable
- 100dB

- C ELK74** Compact Echo Siren **\$12.95**



- D ELKSS30** Self Contained Exterior Alarm Siren **\$15.95**
 Two Tones - Yelp & Steady; Output 120 dB @ 1 meter, 13.8 VDC; Operating Voltage 6-14 VDC ; Current Draw 1.1A @ 13.8 VDC (UL Listed)

- E ELKSS36** Self Contained Interior Alarm Siren **\$8.95**
 Two Tones - Yelp & Steady; Output 105 dB @ 1 meter, 13.8 VDC; Operating Voltage 6-14 VDC ; Current Draw 470 mA @ 13.8 VDC (UL Listed)

COMPACT ECHO SPEAKER

The ELK73 is a 20W, 8 Ohm Speaker mounted in an attractive surface mount plastic enclosure. This versatile Echo Series speaker is designed to be heard but not seen. Sound echoes off mounting surface from back plate edge. Paintable.

- C ELK73** Compact Echo Speaker **\$10.95**

SIREN & STAINLESS STEEL ENCLOSURE

Two distinct sounds from a single input trigger.

- Current Draw: 1.2A
- Sealed Reed Tamper Switches
- Voltage: 6 to 14VDC
- 118dB @ 1 meter, 14VDC
- Size: 5"H x 5"W x 4"D

- F ELK150RT** Siren & Stainless Steel Enclosure **\$62.95**



STROBE LIGHT ACCESSORIES

A weatherproof strobe light designed for easy attachment to ELK's speaker and siren units.

- Flash Rate: Approximately 1 Flash per second
- Size: 4 7/8" x 3 7/8" x 1 1/2"

- G ELKSL1C** Strobe Light, Clear lens **\$27.95**
G ELKSL1A Strobe Light, Amber Lens **\$27.95**
G ELKSL1B Strobe Light, Blue lens **\$27.95**
G ELKSL1R Strobe Light, Red lens **\$27.95**
ELKWK1 Strobe Wall Mount Kit **\$8.95**

SECURITY SPEAKER

A flush mount, interior speaker for alarm or voice applications.

- Mounts in basic J-box
- 32 Ohms

- ELKSP12F** Security Speaker **\$7.95**



AUTOMATIC VOICE DIALER SYSTEMS

AUTOMATIC VOICE & PAGER DIALER

- Calls up to 8 phones, cell phones or pagers
- 2 outgoing messages
- 1-Way listen-in and 2-Way voice
- Non-volatile memory retains programming even during power failures
- Auto redial for unanswered or busy numbers
- Built-in line seizure relay
- Stand-alone security applications

When tripped by any sensor, it calls any combination of 4 to 8 regular phones, cell phones or pagers and delivers a custom recorded message to phones and a numeric code to pagers. Accepts up to 2 to 4 input zones and plays a different message for each zone.

Also program an ID message to proceed the Outgoing Message when tripped. The ID message contains the name, phone number and address of the location of the sensor alarm. Great to work with alarm systems, or if you want to know when your kids get home from school.

- Requires 12V power supply



USAD2001 Automatic Voice & Pager Dialer

(2 Inputs & 4 Phone Numbers) **\$199.95**

USAD2000 Automatic Voice & Pager Dialer

(4 Inputs & 8 Phone Numbers) **\$244.95**

USPB12P 12VDC Power Supply **\$84.95**

AUTOMATIC DIAL-UP SENSORS

USF20 40°F Temperature Sensor **\$17.95**

USPLS Power Loss Sensor for 110V **\$29.95**

USPRS Power Restore Sensor for 110V **\$44.95**

SECO-LARM VOICE DIALER

Automatically dials up to 4 phone numbers and delivers up to 2 different messages when triggered by an alarm system.

- Easily connects to an alarm panel and automatically dials out when activated.
- 2 independent voice messages. Stores up to 4 phone numbers, cellular numbers, or pager numbers.
- Delivers a message of up to 16 seconds to each number stored.
- Instant trigger or exit and entry delay settings.
- Repeats the voice message for one minute per call.
- Waits 8 to 10 rings before dialing the next programmed number
- Retains memory for up to one year if power is lost.



SEE920B Seco-Larm Voice Dialer **\$114.95**

Flood Prevention Solutions

WATER SENSOR & SHUT-OFF SYSTEM

WATERCOP

Think water damage only happens to the other guy? Why leave your entire investment unprotected and risk an expensive insurance claim? The WaterCop Automatic Water Shut-Off system detects common leaks and immediately shuts off the main water supply.

Wireless flood sensors are placed near water-using appliances known to eventually fail – and at the first sign of water, sensors transmit a closure signal to the WaterCop valve, stopping the leak from flooding your home or office.

WATERCOP KITS

WaterCop Kits include one Shut-Off Valve, a WaterCop Motor and 2 single Probe Moisture Sensors.

DQWCKIT1 WaterCop Food Prevention Kit, 1/2" **\$404.95**

DQWCKIT2 WaterCop Food Prevention Kit, 3/4" **\$409.95**

DQWCKIT3 WaterCop Food Prevention Kit, 1" **\$404.95**

DQWCKIT4 WaterCop Food Prevention Kit, 1 3/4" **\$454.95**

WATERCOP VALVES

A DQWCVLFx WaterCop Shut-Off Valve **\$52.00 - \$117.00**

LEAD FREE: Available in 1/2", 3/4", 1" or 1 1/4" Pipe Fitting Sizes

WATERCOP ELECTRIC ACTUATOR MOTOR

Available for 1/2", 3/4", 1" Valve or 1 1/4" Valves

B DQWCACTx WaterCop Electric Actuator Motor **\$306.00**

DQZWACT1 WaterCop Electric Actuator Motor, Z-Wave **\$450.00**

WATERCOP FLOOD SENSORS

C DQWH100 WaterCop Moisture Sensor, Single Probe **\$63.00**

DQWH200 WaterCop Moisture Sensor, Dual Probe **\$72.00**

DQZWCFS1 WaterCop Moisture Sensor, Z-Wave **\$63.00**

DQFH100 WaterCop Low Temperature Sensor **\$82.00**

SINGLE-POINT LEAK DETECTION

WATERCOP LEAKSTOP

DynaQuip's new WaterCop LeakStop System detects water leaks at a single location and automatically shuts off the water supply. It is an ideal solution for water heaters. Extensive water damage will be stopped in its tracks!

The LeakStop includes everything you need: a Valve, Actuator Motor and two hard-wired Moisture Sensors.

DQWCLSLF WaterCop LeakStop **\$261.00 - 293.00**

1/2", 3/4", 1" and 1 1/4" Pipe Fitting Sizes



CUSTOMER FAVORITE!

WATER SENSOR

WATERBUG WATER SENSOR

Place WaterBug sensors in a laundry room, kitchen, living room and basement. The WaterBug Console mounts on a wall to control up to 6 sensor probes that may be up to 100' away! Each sensor probe has 2 contacts. A film of water forming a bridge between these contacts activates the WaterBug alarm. Will not be fooled by condensation or high humidity.



WLWB200 WaterBug 200 Kit **\$69.95**

Includes 200 Console & 1 Surface Sensor; Requires Power Supply; Supports up to 6 sensors

WLWB350 WaterBug 350 Wireless Kit **\$84.95**

Includes 350 Console & 1 Surface Sensor; Runs on 9V Battery (not included); Supports up to 6 sensors

WLWSU Surface Sensor **\$22.95**

WLWUCU Under-Carpet Sensor **\$54.95**

ST900050 Adjustable DC Power Supply, 500mA **\$6.55**

WATER LEVEL SENSOR

SUMP BOBBER FLOAT SWITCH

- Sealed reed switch provides high isolation when pump wiring breaks down
- Reversible float allows for NO or NC switch circuit
- Operates submerged
- Fits virtually all sizes and types of return pipes
- Comes complete with stainless steel hose clamp and 20" lead wire



LGSB2 Sump Bobber **\$29.95**

Security Sensors



WINLAND ELECTRONICS, INC.

GE WIRELESS SECURITY SENSORS

DOOR/WINDOW SENSOR

- Size: 1½"W x 3¼"H x 7⁄8"D
- Colors: Choose White or Brown

A GENX65x Door/Window Sensor \$54.95

SLIMLINE DOOR/WINDOW SENSOR

- Size: 1½"W x 4¼"H x 7⁄8"D

B GENX450 Slimline Door/Window Sensor \$49.95

MICRO DOOR/WINDOW SENSOR

- Size: 1¾"L x 7⁄8"W x 1⁄2"H
- Colors: Choose White or Brown

C GENX45 Micro Door/Window Sensor \$54.95

MICRO RECESSED DOOR/WINDOW SENSOR

- Sensor Size: 5⁄8"D x 3¾" Deep Hole; Magnet Size: 5⁄8"D x 5⁄8" Deep Hole

GENX458 Recessed Door/Window Sensor, White \$54.95



SHATTERPRO GLASS BREAK DETECTOR

- 360° coverage with 20' radius

D GENX488 ShatterPro Glass Break Sensor \$109.95

SMOKE DETECTOR

- Self Diagnostics
- Replaceable Optical Chamber
- 1½ year battery life (Lithium battery included)

GETX6010011 Wireless Smoke Detector \$89.95



PIR MOTION SENSOR

- Size: 2½"W x 3"H x 2"D, wall mount

E GENX480 PIR Motion Sensor \$124.95

E GENX481 PIR Motion Sensor, Pet Immune \$114.95

WIRELESS KEYCHAIN CONTROLLER

- Size: 1½"W, 2¼"H, 3⁄8"D

F GENX470 Wireless Keychain Controller \$44.95

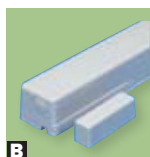

DESIGNLINE RECESSED DOOR SENSOR

- Compact design ensures effortless installation
- Requires only one hole to be drilled
- Size: 1½"L x 7⁄8"R

GETX1510011 Recessed Door Sensor \$59.95



DESIGNLINE SLIM DOOR/WINDOW SENSOR

- Low-profile design
- 500' Range
- Size: 2.44"L x 1"W x 0.35"D

GETX1010011 DesignLine Slim Door/Window Sensor, White \$54.95



More GE Wireless Security Sensors » www.HomeControls.com/GEsecurity

GE WIRELESS SECURITY RECEIVERS

2-CHANNEL RECEIVER

Allows any hard-wired panel to use wireless devices on 2 hardwire zones.

- 1-button receiver programming
- Compatible with learn mode sensors
- Works with Crystal and SAW sensors
- 319.5MHz
- Size: 2½"W x 2½"H x 5⁄8"D
- Wall Mount

GENX702 QuikBridge 2-Channel Receiver \$44.95



8-CHANNEL LOOP RECEIVER

- Up to 16 supervised sensors and 45 unsupervised panic buttons or keychain touchpads
- Compatible with learn mode sensors
- Works with Crystal and SAW sensors
- 319.5MHz
- Size: 4½"W x 5¼"H x 1"D
- Wall mount

GE8016 QuikBridge Loop Receiver \$104.95



BEST SELLER: THE WORLD'S SMALLEST WIRELESS SENSORS!

WIRELESS SECURITY SENSOR

- Available for GE Security, DSC Security, HAI Omni, or 2GIG.

A IONPLUNGERx Plunger Wireless Door Sensor (1" Deep x 3⁄4"Dia) \$34.95

B IONMICRAX Micra Wireless Window Sensor (1⁄3" Deep x 3⁄4"Dia) \$34.95

IONFDB75 Window Sensor Drill Bit (required for installation) \$7.95



CUSTOMER FAVORITE!

CONTACT SENSORS

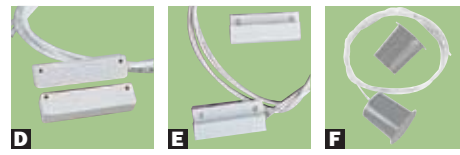
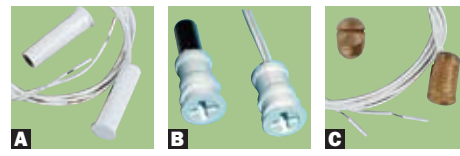

A SESM207W Concealed Contact \$2.55

White, 1" Gap, NC, 3⁄8" Press Fit

A US140SP Concealed Contact \$5.05

White or Brown, 3⁄4" Gap, NC, 3⁄8" Press Fit

A USBP40W Concealed Contact \$3.25

White, 3⁄4" Gap, NO, 3⁄8" Press Fit

E USA1 1" Rare Earth Contact, Self Threaded \$4.35

1" Gap, NC, 3⁄8" Press Fit

C US260 Twist Loc 260 \$8.35

5⁄8" Gap, NC, Size: 3⁄8" x 5⁄8"

D US90SPWH Micro Mini Stick-On Contact \$4.35

3⁄5" Gap, NC, Size: 1" x 1⁄4" x 1⁄8"

E US130SP Mini Stick-On Contact \$4.85

White or Brown, 1" Gap, NC, Self Adhesive or Screw

E SESM204W Mini Stick-On Contact \$2.55

1" Gap, NC, Self Adhesive or Screw

F USBP50W Stubby Press Fit \$2.95

3⁄4" Gap, NC, 3⁄8" Stubby Press Fit

G GE3008 Shorty Rollerball Plunger Contact \$5.95

White or Brown, Size: 3⁄4" x 3⁄4"

H GE1038TN Door/Window Sensor with Cover \$3.95

1" Gap, 2½"W x 3⁄8"H x 0.40"D

I USSP3000A Mini Overhead Door Contact \$18.95

2½" Gap, NC, Size: 3½" x 1½", Adjustable L-Bracket

USSP3000 Mini Overhead Door Contact \$16.95

2½" Gap, NC, Size: 3½" x 1½"

J GE1138T Door/Window Terminal Contact \$2.95

White or Brown, 1" Gap, NC, Size: 2" x 0.4" x 0.34"

K USWLS Water Level Sensor \$17.95

USRE1 Small Rare Earth Magnet \$2.05

USRE2 Large Rare Earth Magnet \$2.75

POWER SENSOR

POWER-OUT ALERT SENSOR

Plug into any 120 VAC outlet and attach into an existing alarm system, telephone dialer or other emergency equipment.

WLPS110 Power-Out Alert \$59.95



MOTION-ACTIVATED SENSORS

ZODIAC SERIES

The ZoDIAC provides superior catch performance with immunity to false alarms in even the harshest environments. It ensures improved coverage while significantly reducing false alarms from warm air, moving curtains, spot temperature changes and small dogs and cats.

- PIR Coverage: 40' x 40'



RK410RQ ZoDIAC Quad PIR Motion Sensor **\$24.95**

COMET SERIES

The CoMET Series provides a reliable solution based on PIR technology. The CoMET detector is compact and attractively designed to meet the needs of residential installations.

- PIR Coverage: 40' x 40'
- Pet Coverage: 26', 90° (immune for 42 lbs. dog, 2 cats or multiple rodents)



RK210PR CoMET PIR Sensor **\$10.95**
RK210PT CoMET Pet Sensor **\$12.95**

iWISE SERIES

The iWISE Series is a range of dual-technology (DT) and passive infrared (PIR) detectors that deliver superior catch performance with excellent false alarm immunity. iWISE detectors incorporating Anti-Cloak Technology (ACT) ensure that no intruder passes undetected. ACT makes the iWISE detector series the premier choice for any commercial, industrial or residential installation.

iWISE DT Sensors: iWISE DT detectors are a true revolution in detector technology due to Risco Group's ACT. iWISE DT combines PIR and microwave capabilities to eliminate false alarms.

RK810DT iWISE DT Motion Sensor, 33' **\$49.95**
RK825DT iWISE DT Motion Sensor, 82' **\$69.95**

iWISE Quad PIR Sensors: iWISE QUAD uses two separate dual-element sensors to reduce false alarms and improve catch performance in hostile environments; Two dual element pyroelectric sensors and Two independent processing channels. Also features false alarm rejection of white light and hot air turbulence, patented true temperature compensation, creep zone, and 3 LED walk test indicator.

RK800QA iWISE Quad PIR Motion Sensor **\$34.95**

iWISE Pet Motion Sensors: Provide full pet immunity with no loss of catch performance. iWISE PET and DT PET models easily distinguish between intruders and pets, allowing complete pet freedom of movement without false alarms.

RK811DPT00A iWISE DT Pet Motion Sensor, 100 lbs. **\$49.95**

More Motion Detectors » www.HomeControls.com/MotionSensors

IQ PROFILER PET PIR SENSOR

The Napco IQ Profiler profiles false alarm sources and installs in a snap with patented features. The IQ Profiler actually contains a library of 1,200 false alarm and true alarm profiles. All detected signals are automatically compared against them for the ultimate false alarm protection. Installation in less than a minute with a simple twist of a screwdriver.

- 50 lbs. pet immunity
- Dual focus lens provides superior false alarm discrimination
- Covers a 50' x 50' area
- Size: 4 1/2" H x 2 1/2" W x 1 7/8" D

NIQPROFILER IQ Profiler Pet Sensor **\$29.95**



NAPCO ADAPTIVE DUAL DETECTORS

Napco's Adaptive Dual Microwave/PIR Detectors automatically adjust to their environment, minute by minute, for reliable false alarm immunity.

The Adaptive detector automatically selects the most appropriate detection mode, optimizing both intruder catch and stability. Each time the sensors detect a stimulus strong enough to generate a signal, yet insufficient in strength to indicate an alarm, the detector automatically changes sensitivity modes, effectively widening the gap between the detected signal and its alarm threshold. Therefore, environmental disturbances are better tolerated and the threat of false alarms is dramatically reduced.

NPC100STE Adaptive Dual Detector **\$24.95**

NPC200AP Adaptive Dual Detector, with Pet Immunity (100lbs.) **\$34.95**



LUNAR SERIES

LuNAR PR Motion Sensor: The Rokonet LuNAR PR is a dual element PIR with adjustable sensitivity, signal logic and variable pulse count. 12VDC, NC.

RK2000DPC LuNAR PR Motion Sensor **\$54.95**

LuNAR DT Motion Sensor: LuNAR DT combines IR and microwave capabilities to eliminate false alarms - both technologies must verify an intrusion for the alarm to be activated.

RK150T LuNAR DT Motion Sensor **\$89.95**



GE PRECISIONLINE DT MOTION SENSOR

PrecisionLine dual technology sensors offer new, easy solutions for your most challenging residential or pet applications. Using a sophisticated combination of precision controlled microwave and PIR technologies, these sensors give total coverage-on-demand.

GERCR50 PrecisionLine PIR Sensor, 50' **\$59.95**

GERCRPET PrecisionLine PIR Pet Sensor, 35' **\$44.95**



GLASS BREAK SENSORS

VITRON PLUS GLASS BREAK SENSOR

- The area's acoustics are sampled up to 40,000 times per second.
- Protects all glass types
- Dead microphone supervision
- Up to 30' with automatic adjustment
- Memory (Latch) indication
- Size: 4 1/2" H x 2 1/2" W x 5 1/2" x 1/8", 3/16" or 1/4" Thickness

RKR671FM Vitron Plus Glass Break Detector **\$34.95**



CUSTOMER FAVORITE!

SHATTERPRO II

By processing over 30 frequency points across the glass break frequency spectrum, the recessed ShatterPro II can eliminate most common false alarm sounds, while providing excellent glassbreak detection.

GE5822AW ShatterPro II Glass Break Detector **\$59.95**

GE5709CW ShatterPro II Glass Break Tester **\$114.95**

More Glass Break Detectors » www.HomeControls.com/Glass_BreakSensors



SMOKE DETECTORS

GE PHOTOELECTRIC SMOKE DETECTORS, 120VAC

GE Security ESL 350 Series alarms are single/multiple station photoelectric smoke alarms. Up to 12 units may be interconnected for tandem operation. When any unit in tandem senses smoke, all the units sound an alarm. PhotoElectric alarms detect smoldering fire faster than the more common ionization alarms

- Provides a battery backup – up to 46 hours protection during a power outage
- 120VAC powered

CX models include Form-A and C relays that operate from the tandem circuit and when smoke is detected.

A GE350CX PhotoElectric Smoke Detector **\$69.95**



GE SELF-DIAGNOSTIC PHOTOELECTRIC SMOKE DETECTORS, LOW VOLTAGE

4-Wire: GE Security ESL 449 Series self-diagnostic, 4-wire smoke detectors continually monitor their own sensitivity and operational status, and provide a visual trouble indication if they drift out of sensitivity range or fail internal diagnostics.

- Intelligent, self-diagnostics
- Advanced false alarm immunity

B GE449C Smoke Detector **\$54.95**

GE449CT Smoke Detector with Heat Sensor **\$54.95**

GE449CTE Smoke Detector with Heat Sensor & Relay **\$64.95**

GE449CST Smoke Detector with Heat Sensor & Sounder **\$64.95**



2-Wire: GE Security ESL 521 Series self-diagnostic, 2-wire smoke detectors are the industry's first conventional direct-wire smoke detectors with analog features such as remote maintenance/trouble reporting (CleanMe), drift compensation, and multi-criteria detection.

C GE521BXT Self-Diagnostic PhotoElectric Smoke & Heat Detector **\$59.95**

GE521NCSXT Self-Diagnostic PhotoElectric Smoke & Heat Detector with Sounder **\$49.95**

GE SMOKE DETECTOR ACCESSORIES

GESM200 Smoke!-In-A-Can (Canned Smoke For Smoke Detector Testing) **\$7.95**

GE40505 Polarity Reversal Relay Module for 4-Wire Smoke Detectors, 12/24V **\$34.95**

GE2041224V End Of Line Power Supervision Relay for 4-Wire Smoke Detectors, 12/24V **\$19.95**

FIREWOLF PHOTOELECTRIC SMOKE DETECTORS

Accurately detects all types of fire, including paper, wood, gasoline, polystyrene, smoldering fires, etc. Performance superior to previous photo-electric detectors.

- Attractive, low profile
- Dual LEDs
- 360° visibility
- 100% burn-in tested

NPFW4 PhotoElectric Smoke Detector, 4-Wire **\$49.95**

NPFW2 PhotoElectric Smoke Detector, 2-Wire **\$39.95**

FIREWOLF WITH BUILT-IN HEAT SENSOR

NPFW4H Smoke Detector with Heat Sensor, 4-Wire **\$54.95**

NPFW2H Smoke Detector with Heat Sensor, 2-Wire **\$44.95**

USR64 End-of-line Relay (Required for 4-Wire Smoke Detectors) **\$24.95**



CARBON MONOXIDE PROTECTION

GE SAFEAIR CARBON MONOXIDE ALARM

The GE SafeAir carbon monoxide detector is an accurate and reliable means of alerting building occupants of potentially dangerous levels of CO in the protected area.

- Self-diagnostics keep the device operating optimally throughout its service life
- Sensor is unaffected by fluctuations in indoor temperature
- Built-in trouble/power supervision relay
- 12 or 24VDC operation and 150mA relay contact configurable for normally open or normally closed operation

GE250CO GE SafeAir Carbon Monoxide Alarm **\$79.95**

GE250COPLT GE SafeAir Adapter Plate (from the 240-COe to the 250-CO) **\$2.95**



LINEAR CARBON MONOXIDE ALARM

The Linear Supervised Carbon Monoxide Detector Transmitter is a single station, carbon monoxide alarm with a built-in supervised transmitter. It is compatible with Linear's wireless DXS Format Security Systems, Personal Emergency Reporting Systems (PERS), and other stand-alone receivers.

The DXS-80 provides a warning to alert against both the acute and chronic effects of CO poisoning.

- Alarm, status and low battery transmissions
- Requires a DXS receiver to operate (see page 36)

LNDXS80 Linear Carbon Monoxide Alarm **\$118.99**



TEMPERATURE ALERTS

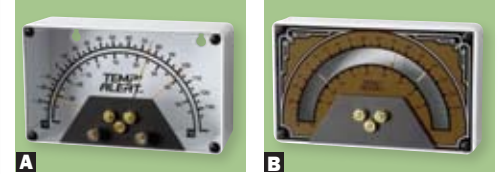

POWERLESS OPERATION!

TEMP ° ALERT

Reliable and economical temperature protection for residential or commercial security systems. Wire units in parallel for simple, wide-area coverage. Ideal for computer rooms, residential/vacation homes, greenhouses, animal buildings or unattended buildings. Monitor high and low temperature limits by setting an acceptable temperature range with high and low limit arms.

- High and low-set points will activate virtually any alarm panel, dialer or wireless alarm
- Gold plated normally open (NO) dry contacts
- No power required to operate
- Not for use in cooler/freezer monitoring; instead choose an EnviroAlert with probe (See Page 38).

A WLTA1 Temp ° Alert (High And Low) **\$54.95**

Sends high and low temp alarm signals

B WLTA2HL Temp ° Alert (High Or Low) **\$64.95**

Sends high or low temp alarm signals separately

EMAIL NOTIFICATION!

TEMPERATURE@LERT

Temperature@lert connects to your computer via a USB port. It monitors the temperature and alerts you via email when it rises or falls outside your acceptable range. The temperature sensor is accurate to within ±0.5°C and can report temperatures from -40°F to +200°F. The alert message can be sent continuously or just once when an alert is triggered. Real time graphing and XML support provide you with the tools you need to integrate temperature readings into third-party applications.

CUSTOMER FAVORITE!



SHTMSTD30 Temperature@lert **\$129.00**

Driveway Alert Systems

WIRELESS DRIVEWAY ALERT SYSTEMS



UP TO HALF MILE RANGE!

DAKOTA ALERT 2500 WIRELESS VEHICLE ALERT

The Dakota Alert 2500 series is a feature filled wireless motion detector/receiver system with a half mile radio range. The motion detecting sensor detects a person or vehicle passing by out to about 50 feet. The sensor will then send a signal back to the receiver up to half mile away. The receiver also offers a 5 minute exit delay so you can leave the house without disturbing any occupants as well as a reminder beep and counter function. (Actual range may vary depending on the local terrain.)

PIR Motion: Uses a PIR beam to detect people or vehicles up to 50' away.

Rubber Hose: Has 25' of 3/8" diameter exterior hose that will lie across the drive.

Probe: For detecting vehicles only, the probe has 50' of direct burial wire connecting the probe to the exterior case. The probe is buried parallel to the driveway, and detects vehicles passing by within approximately 10-12'.

Break Beam: Infrared sensing terminals can be mounted up to 300' apart.

DAKOTA ALERT 2500 KITS

All kits include wireless sensor/transmitter and wireless receiver.

A DADCM2500 Wireless PIR Motion Alert Kit **\$114.95**

B DADCRH2500 Wireless Rubber Hose Alert Kit **\$124.95**

C DADCPA2500 Wireless Probe Driveway Alert Kit **\$219.95**

D DABBA2500 Wireless Beam Sensor Alert Kit **\$284.95**

DAKOTA ALERT 2500 ACCESSORIES

DADCMT2500 Extra Wireless PIR Sensor/Transmitter **\$74.95**

DADCHT2500 Extra Wireless Rubber Hose Sensor/Transmitter **\$89.95**

DADCP2500 Extra Wireless Probe Sensor/Transmitter **\$169.95**

DABBT2500 Extra Wireless Beam Sensor/Transmitter (Pair) **\$234.95**

DADCR2500 Extra Wireless Receiver **\$59.95**



See the Dakota Alert 3000
Wireless Alert System online »
www.HomeControls.com/DakotaAlert

DAKOTA ALERT™ WINLAND
ELECTRONICS, INC.



UP TO 5 MILE RANGE!

DAKOTA ALERT MURS SENSORS

Communicate over distances of several miles with the Dakota Alert MURS (Multi-Use Radio Service). The transmitter utilizes PIR sensor technology that sends a signal to the transceivers. The transceiver not only receives alert signals from the transmitter, but can also be used for 2-Way voice communications between other transceivers.

DAKOTA ALERT MURS KITS

F G DAM538BSKIT MURS Base Station Kit **\$199.95**

Includes Sensor/Transmitter & Base Station Transceiver

F H DAM538HTKIT MURS Handheld Kit **\$204.95**

Includes Sensor/Transmitter & Handheld Transceiver

DAMAPBSKIT MURS Vehicle Base Station Kit **\$329.95**

Includes Driveway Burial Probe Sensor/Transmitter & Base Station Transceiver

DAMAPSHKIT MURS Vehicle Handheld Kit **\$334.95**

Includes Driveway Probe Sensor/Transmitter & Handheld Transceiver

DAKOTA ALERT MURS ACCESSORIES

G DAM538BS MURS Base Station Transceiver **\$84.95**

H DAM538HT MURS Handheld Transceiver **\$94.95**

 **WE'RE HERE TO HELP!**
Call 1-800-266-8765 for great Customer Service

HARD-WIRED DRIVEWAY ALERT SYSTEMS

WINLAND VEHICLE ALERT

When an auto drives onto your property, you will know it. The magnetic sensing method used by the Vehicle Alert is immune to false alarms by animals, swaying trees and people. The sensor probe is simply buried 6-8" underground beside your driveway and a wire (up to 2,500') runs back to the console in your house. The console's buzzer sounds for an adjustable duration when a car passes by, and also can activate 2 auxiliary Form A relays for switching On lights, alarms, cameras, bells, X10, etc.

- Adjustable sensitivity with built-in audible alarm
- Use up to 2 underground sensor probes
- Additional audible alarm module available
- Built-in audible alarm
- Six minute exit delay allows a vehicle to leave without activating the alarm
- System may be purchased complete or custom designed by purchasing components individually



WLVAL1 Vehicle Alert Kit **\$304.95**

Includes Console, Probe with 100' Cable & Power Supply

WINLAND VEHICLE ALERT ACCESSORIES

WLVALC Vehicle Alert Console **\$149.95**

WLVPx Vehicle Probe with Cable **\$99.95-\$499.95**

Available In 10', 100', 200', 350', 500' Or 1,000' Lengths

WLBZ1 Remote Annunciator **\$34.95**

DAKOTA ALERT VEHICLE ALERT

The hard-wired vehicle sensor lets you know when a vehicle enters or leaves the driveway. The probe of the vehicle sensor detects metal objects in a 10' to 12' radius of the sensor. The probe will detect vehicles moving by and send a signal through the line to the control box, which will sound a whistle. The control box plugs into a 110V outlet, and has an On/Off switch on the top of the box.



- Splicing the wire is not recommended

DAVS50 Dakota Vehicle Alert, 50' Cable **\$174.95**

Includes Probe, Console, Cable & Power Supply

DAVS125 Dakota Vehicle Alert, 125' Cable **\$184.95**

Includes Probe, Console, Cable & Power Supply

We've Got You Covered - Inside & Outside Your Home » www.HomeControls.com/DrivewayVehicleAlerts

FREE PRODUCT ADVICE & SUPPORT » **800-266-8765**

43

Plug-n-Play Wireless Alerts

EASY-TO-INSTALL ENTRY ALERT SYSTEMS

STI MOTION-ACTIVATED CHIME KIT

The Wireless Motion-Activated Chime Kit alerts you when someone enters the motion sensor's detection zone. The detection signal passes through doors, walls and floors to detect anyone within 140 degrees, up to 40' away. When motion is detected, the transmitter sends a signal to the receiver, which alerts you with music. The system can also be used as an alarm by selecting the alarm sound with a switch on the transmitter.



- Transmission range up to 100'
- Adjustable volume: low, medium, high
- Activation switch allows chime or alarm sounds
- Weatherproof sensor for long-term outdoor use

STI MOTION-ACTIVATED CHIME KIT

A B STI46100 STI Wireless Chime Kit **\$44.95**

STI MOTION-ACTIVATED CHIME COMPONENTS

A STI32530 STI Wireless Chime Receiver **\$24.95**

B STI46010 STI Wireless Motion Sensor **\$20.95**

USP PORTABLE DETECTORS

Motion Alert: Detects body heat and motion. When an intrusion is detected the detector emits a low siren for 5-10 seconds in alert mode or piercing siren sounds in alarm mode for up to 2 minutes.



Beam Alert:

The USP Beam Alert is a compact and portable announcer. It mounts near any door, entry, or window. The Beam Alert features a protective beam that extends up to 15 feet for barrier or spot coverage. When the beam area is entered, the unit emits a short burst of beeps, to signal arrival.

A USSMAH USP Portable Motion Detector **\$59.95**

B USBA1 USP Portable Beam Alert Detector **\$49.95**

DAKOTA ALERT PORTABLE ENTRY ALERT

The Portable Entry Alert uses a photo sensor to detect people walking by up to 10' away. When a person is detected, you're alerted.



The alert can be used to monitor doorways in homes or businesses.

It can also be used in elderly care to help you keep people from wandering away.

The alert has a hi/low volume control as well as an on/off switch. It operates on two "C" cell batteries (not included).

DAEA10 Dakota Alert Portable Entry Alert **\$14.95**

VOICE ALERT SYSTEM

Monitor up to 6 separate zones identified by your custom message! When movement is detected in a zone, the powerful RF Sensor/Transmitter sends a signal to the in-home Receiver/Speaker, triggering your customized voice message that identifies the zone.

For example: "Someone is coming up the driveway"; or "Someone is on the back deck."

- Up to 1,000' range
- 6-Zone Monitoring Capability
- Customized Voice-Recordable Alerts
- All Weather, Wireless PIR Sensor Transmitters
- Multiple Beam Patterns for Optimal Detection
- Adjustable Mounting, Beam Sensitivity, and Delay Timer
- 4 "C" Relays to Trigger Additional Devices



VOICE ALERT KIT

A B CIVA6000S Voice Alert Kit **\$149.95**

VOICE ALERT COMPONENTS

A CIVA6000T Extra Voice Alert Transmitter **\$69.95**

B CIVA6000R Extra Voice Alert Receiver **\$89.95**

OPTEX WIRELESS 2000 ANNUNCIATOR SYSTEM

Install motion sensors at the driveway entrance, front door, back door, side gate ... wherever you want to be alerted that you have visitors. Receiver emits 1 of 3 different types of tones to announce the arrival and location of a visitor. Features volume control and low battery signal.

- Up to 2,000' range
- Single Form-C relay on receiver
- Each Receiver accepts up to 9 transmitters



OPTEX WIRELESS 2000 KIT

A B OPRCTD20U Wireless 2000 Annunciator System **\$179.95**

OPTEX WIRELESS 2000 COMPONENTS

A OPRC20U Wireless 2000 Receiver **\$99.95**

B OPTD20U Wireless 2000 Sensor/Transmitter **\$89.95**

OPTS10U Wireless Handheld Transmitter **\$44.95**

OPTC10U Wireless Door Contact **\$54.95**

PERFECT FOR RESIDENTIAL & COMMERCIAL LOCATIONS!

SECO-LARM ENTRY ALERT SYSTEM

- Photoelectric beam sensor system for monitoring an entrance, or use as an entrance indicator
- Range: Up to 22'
- Makes "ding-dong" or siren sound (In siren mode, sounding time adjustable from 3 to 30 seconds)
- All components plug into each other. No wiring required.
- Includes 110V plug-in power supply.



SEE931CS22RRCQ Seco-Larm Entry Alert System **\$74.95**

Includes Retro-Reflective Photoelectric Sensor, Reflector, Speaker/Electronic Chime, Power Supply & Brackets

SECO-LARM ENTRY ALERT ACCESSORIES

SEE931ACCSQ Seco-Larm Extra Speaker/Chime for Door Entry Alert System **\$21.95**

SEE931ACCCQ Seco-Larm Digital Counter for Door Entry Alert System **\$34.95**

DAKOTA ALERT WIRELESS PIR ALERT SYSTEM

With a wireless range of up to 600' and full compatibility with any of our Dakota Alert 3000 Series transmitters or receivers (see page 43), the system allows you to monitor many locations that were difficult before. For indoor use only.

DAKOTA ALERT 3000 KIT

A B DAIRWR3000 Wireless PIR Alert System **\$99.95**

DAKOTA ALERT 3000 COMPONENTS

A DAIR3000 Wireless PIR Sensor/Transmitter **\$69.95**

B DAWR3000 Wireless Receiver **\$59.95**



HOUSEHOLD ALERT SYSTEMS

These low-cost systems alert you to things happening around the house. When set to Alert, these products provide audio and visual indications. When set to Alarm, an alarm sounds when the sensors are triggered. A special supervised feature monitors the sensors and their battery condition.



SKYLINK HOUSEHOLD ALERT

- Ideal for small to medium-sized homes.
- Works with up to 4 sensors
- Operating range: 300'
- Easy to set up

SKYLINK HOUSEHOLD ALERT KITS

- A B SKWD318** Skylink Household Alert Door/Window Alert Set **\$26.95**
- A C SKHA318** Skylink Household Alert Motion Alert Set **\$29.95**
- A D SKGM318** Skylink Household Alert Garage Door Monitor Set **\$26.95**
- A E SKWA318** Skylink Household Alert Water Alert Set **\$26.95**

SKYLINK HOUSEHOLD ALERT COMPONENTS

- A SKGM318R** Skylink Household Alert Receiver **\$17.95**
- B SKWD318T** Skylink Household Alert Door/Window Alert Sensor **\$17.95**
- C SKHA318T** Skylink Household Alert Motion Alert Sensor **\$20.95**
- D SKGM318T** Skylink Household Alert Garage Door Sensor **\$17.95**
- E SKWA318T** Skylink Household Alert Water Alert Sensor **\$17.95**
- SKRP318** Skylink Household Alert Repeater **\$24.95**

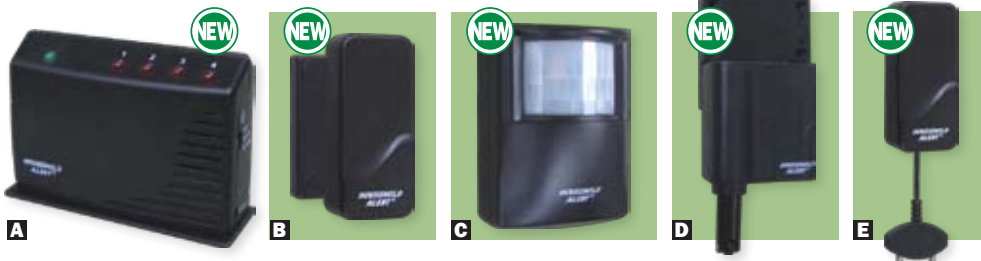

SKYLINK LONG RANGE HOUSEHOLD ALERT

- Ideal for medium to large homes.
- Works with up to 16 sensors
- Operating range: 800'
- Easy to set up

SKYLINK LONG RANGE HOUSEHOLD ALERT KITS

- A B SKWD434RTL** Skylink Long Range Household Alert Door/Window Alert Set **\$29.95**
- A C SKHA434RTL** Skylink Long Range Household Alert Motion Alert Set **\$39.95**
- A D SKGM434RTL** Skylink Long Range Household Alert Garage Door Monitor Set **\$29.95**
- A E SKWA434RTL** Skylink Long Range Household Alert Water Alert Set **\$29.95**

SKYLINK LONG RANGE HOUSEHOLD ALERT COMPONENTS

- B SKWD434TL** Skylink Long Range Household Alert Door/Window Alert Sensor **\$20.95**
- C SKHA434TL** Skylink Long Range Household Alert Motion Alert Sensor **\$25.95**
- D SKGM434TL** Skylink Long Range Household Alert Garage Door Sensor **\$20.95**
- E SKWA434TL** Skylink Long Range Household Alert Water Alert Sensor **\$20.95**



REX PLUS ELECTRONIC WATCHDOG

Protect your home with a specialized motion detector designed to simultaneously alert you and deter intruders. The Rex Plus Electronic Watchdog is always on duty, guarding and protecting. Watchdog can sense motion through thick doors, walls or glass. When motion is detected, Watchdog sounds one of four selectable alerts: an angry, barking watchdog, soothing sounds to alert you of a guest's arrival, alert sounds of both an angry watchdog and a warning siren, or continual tranquil sounds of the rainforest.

STIED50 Rex Plus Electronic Watchdog **\$84.95**

OUTDOOR SENSORS

WATCHOUT OUTDOOR SERIES

WatchOUT Outdoor Detectors provide reliable outdoor protection by providing the best Selective Event Recognition. WatchOUT can distinguish between real intrusion events and the false alarms caused by the unstable outdoor environment.

- Digital Correlation Technology for eliminating false alarms from pets, reflections and rapid temperature changes



RK315DT WatchOUT DT Sensor **\$194.95**

RKRA300B Barrier Swivel for WatchOUT **\$10.95**

RKRA300P Pole Adaptor for WatchOUT **\$24.95**

RKRA300C Conduit Adaptor for WatchOUT **\$6.95**

PHOTOBEAMS

TWIN PHOTOBREAM SENSORS

- Indoor or outdoor use
- Twin beams provide reliable perimeter security, minimizing false alarms
- NC/NO alarm output; NC tamper circuit included
- Includes 2 PhotoElectric Sensors (transmitter and receiver), 2 Wall Mounting Plates, 2 Pole Mounting Plates and hardware
- Power supply sold separately



SEE960D Seco-Larm Enforcer Twin Photobeam Sensor **\$94.95** ~~\$144.95~~

Choose from 90', 190' or 290'

ST900050 Adjustable DC Power, 500mA **\$6.55**

QUAD PHOTOBREAM SENSORS

Because all four beams must be simultaneously broken for activation, false alarms created by animals and leaves are minimized.

- Four selectable beam frequencies eliminate interference
- Beam strength LED indicators
- Audible beam alignment (buzzer)
- Built-in heater for indoor or outdoor use
- NO/NC alarm output
- Power supply sold separately



SEE964QxxxQ Seco-Larm Enforcer Quad Photobeam Sensor **\$94.95** ~~\$144.95~~

Choose from 165', 330', 495' or 660'

ST900050 Adjustable DC Power, 500mA **\$6.55**

Security Cameras

BULLET CAMERAS



Camera Description	HAI Bullet Camera		Enforcer Bullet Cameras		Enforcer Turret Camera	Channel Vision IP Bullet Camera	Enforcer 3X Cameras	
Camera Type	Color IR Day/Night		Color IR Day/Night	Color IR Day/Night	Armored Ball Turret Camera	2 Megapixel H.264 IP Bullet Camera	56 IR LED NVD Bullet Cameras	56 IR LED NVD Bullet Cameras
Resolution	560 TV lines		540 TV lines	540 TV lines	550 TV lines	1600x1200	600 TV lines	600 TV lines
Minimum Illumination	0 Lux (IR on)		0 Lux (IR on)	0 Lux (IR on)	0.000006 Lux (IR on)	0 Lux (IR on)	0.00006 Lux (LEDs on)	0.00006 Lux (LEDs on)
Standard Lens mm	3.8-9.5mm, DC Auto Iris		3.6mm	6.0mm	2.8~12mm	Varifocal 3.6 to 16mm	2.8~12m DC Auto Iris	6~50m DC Auto Iris
Camera Size	9" x 3.8" x 3.2"		94mm x 59mm x 50mm	94mm x 59mm x 50mm	140mm x 111mm		305mm x 100mm x 100mm	305mm x 100mm x 100mm
Power	12VDC		12VDC	12VDC	12VDC/24VAC	12VDC	12VDC/24VAC	12VDC/24VAC
Features	36 IR LEDs for night vision (up to 95')		24 IR LEDs; split glass technology	24 IR LEDs; split glass technology	Digital Noise Reduction; Digital Slow Shutter	36 IR LEDs for night vision (up to 60')	4-Axis Mounting Arm; Weatherproof	4-Axis Mounting Arm; Weatherproof
Model#	HA68A022		SEEV1606N3SQ	SEEV1606N6SQ	SEEV2646NKGQ	CV6522	SEEV1726NKG	SEEV1726NWG
Price	\$364.95		\$99.95	\$99.95	\$309.95	\$444.95	\$409.95	\$464.95

IN-WALL BOX CAMERAS



SINGLE GANG COLOR BOX CAMERA

Channel Vision's 6200 single gang color camera is the perfect solution for any upscale surveillance application requiring a discreet appearance. Fitted with a decorative cover and a smoked acrylic face, this box camera is designed to blend into any installation background.

- 1/3" CCD Image Sensor
- 5.5 mm lens

- 1 Lux Low-Light Sensitivity
- 550 lines of resolution
- View ground 3 1/2" from wall at 6' high
- Power Supply Included
- Includes Mounting Bracket and Decora Plate

CV6200xx Single Gang Color Box Camera **\$144.95**
CV6403 Color Mini Cone Camera (no box) **\$94.95**



White **CV6200212** Black **CV6200282** Polished Brass **CV6200222** Satin Nickel **CV6200302** Oil Rubbed Bronze **CV6200252** Antique Brass **CV6200232** Chrome **CV6200242**



Coordinate with the Channel Vision Door Entry Intercom System. See Page 80.

DUMMY CAMERAS

- A SEVD30BS** Dummy Bullet Camera **\$19.95**
- A SEVD10PL** Dummy Bullet Camera with LED **\$29.95**
Requires Power Adapter To Operate LEDs
- B SEVD10BN** Dummy Security Box Camera **\$59.95**
- C TLSM320S** Dummy Dome Camera with LED **\$13.99**
- D SEVD40BN** Dummy PTZ Speed Dome **\$79.95**
- SEVBHC1** Dummy PTZ Speed Dome Bracket **\$20.95**



Don't see what you are looking for?
Log on to www.HomeControls.com
or call 1-800-266-8765!

DOME CAMERAS



HAI Dome Camera



Enforcer Dome Camera



Enforcer IR Dome Cameras



Enforcer Vandal-Resistant Ball-Mount IR Cameras



Channel Vision IP Dome Camera



TINY! ONLY 3" DIAMETER!

NEW

Enforcer UFO Camera

Color IR Day/Night	Mid-Sized Color 21 IR LEDs	Indoor IR Dome Camera	Indoor IR Dome Camera	Color 36 IR LEDs	Color 24 IR LEDs	2 Megapixel H.264 IP Dome Camera	Color IR Mini
550 TV lines	540 TV lines	420 TV lines	540 TV lines	480 TV lines	480 TV lines	1600x1200	600 TV lines
0.1 Lux (IR off) 0.002 Lux (IR on)	0 Lux (IR on)	0 Lux (IR on)	0 Lux (IR on)	0.3 Lux (IR off) 0 Lux (IR on)	0.5 Lux (IR off) 0 Lux (IR on)	0 Lux (IR on)	0.05 Lux
3.8~9.5mm DC Auto Iris	3.66mm	3.6mm	2.8~11mm DC Auto Iris	4~9mm Varifocal, F1.6	3.6mm F2.0	Varifocal 2.7~9mm	3.7mm Pinhole
68mm Dia x 145mm H	108mm Dia x 89mm H	133mm Dia x 95mm H	133mm Dia x 95mm H	118mm Dia x 100mm H	TINY! 94mm Dia x 80mm H		TINY! 77mm Dia x 49mm H
12VDC/24VAC	12VDC+/-10%	12VDC+/-10%	12VDC+/-10%	12VDC+/-10%	12VDC+/-10%	12VDC	12VDC+/-10%
3-Axis Gimbal; Separate Control Board	3-Axis Gimbal; Heavy Duty & Vandal-resistant	16 IR LEDs; 3-Aix Gimbal; Lightweight	16 IR LEDs; 3-Aix Gimbal; Lightweight	360° rotation, 10°~120° tilt; Weatherproof	360° rotation, 10°~120° tilt; Weatherproof	36 IR LEDs for night vision (up to 45')	Lens rotates for ceiling or wall mounting
HA68A011	SEEV2766N3WQ	SEEV2221N3BQ	SEEV2801NKBQ	SEEV122CDVAVQ	SEEV122CDVB3Q	CV6521	SEEV6640N3WQ
\$234.95	\$124.95	\$84.95	\$144.95	\$124.95	\$79.95	\$444.95	\$99.95

INDOOR/OUTDOOR CAMERAS

LEVITON INDOOR/OUTDOOR COLOR MONITORING CAMERA SYSTEM

Professional quality Indoor and Outdoor Cameras offer quick mounting and easy installation with a single Cat5e cable for both video and power. The Leviton Indoor/Outdoor Color Monitoring Camera System provides high-quality color video output that will run through a Leviton Structured Media Center (SMC) and connect to a video monitor anywhere in the home. With the IP/Quad module from Leviton, homeowners can monitor their house from any remote location using a PC and Internet browser.

System installation is simplified with innovative indoor and outdoor analog composite video cameras that rely on 1 unshielded twisted pair (UTP) cable (Cat5, 5e or 6) for both video and power connections. Cables connect to a compact Camera Hub that occupies a single bracket in the Leviton Structured Media Center (SMC).

Camera mounting is also simplified, requiring just 2

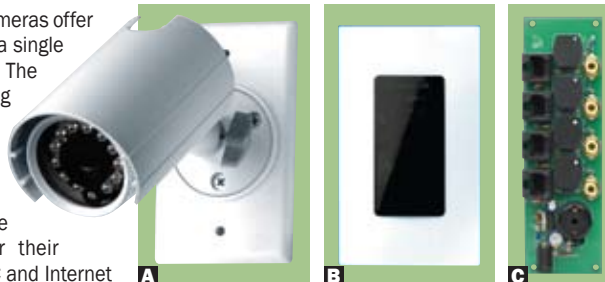

screws on a low voltage ring (Indoor Camera) or outdoor electrical box (Outdoor Camera). Standard 110 IDC terminations and 8P8C jacks make the job of connecting UTP cabling simple, quick and reliable.

- A LVVSOUTW** Outdoor Hi-Res Color Camera **\$269.95**
- B LVVSINDSC** Indoor Hi-Res Color Camera **\$194.95**
- C LVVSHUB** Leviton Camera Hub **\$164.95**

LEVITON

CAMERA + SENSOR + DVR!

IRMOTIONDETECTOR&VIDEORECORDER

The Dakota Alert IR Motion Detector and Video Recorder uses a PIR detector and a digital video recorder to record 30 seconds of video and audio clips every time a person passes in front of the sensor. The camera can be connected to a computer via the USB cable (included) to download the video clips with no software required. The DVR stores the video clips on a Micro SD card (4 GB card included).



CUSTOMER FAVORITE!

This Video Recorder is simple to use and battery operated. It can be set up instantly in nearly any location. It features infrared operation to allow the camera to operate in low light conditions. The built in lithium battery will power the camera for up to 10 days (varies depending on number of activations).

DADV01 Dakota Alert IR Motion Detector & Video Recorder **\$89.95**



MARKETING & SALES SUPPORT FOR INTEGRATORS
For Qualified Dealers. Call Brian at 1-800-266-8765 x133 and Ask About ConnectHome.

ON-Q STUDIO CAMERA SYSTEM

CAT5 CAMERA MONITORING SYSTEM

The On-Q Studio Camera system enables homeowners to view their camera images via a convenient LCD console (or on any TV using the TV Display Interface). Each system can handle up to four weather-resistant cameras, and allows Internet monitoring when combined with an IP Video Server.

The wall-mounted flat panel LCD Console lets you monitor your home from a central location such as the kitchen. It features a 7" full color high resolution LCD screen, as well as integrated speakers. The sleek console displays clear images from up to four cameras.

CAMERA KITS

OQCM7646 Ball Camera Kit **\$834.95**

Includes 2 Ball Cameras, Camera Module, Modulator, Patch Cable & 2 Power Supplies (White)

OQCM5451 Ball Camera & LCD Kit **\$1264.95**

Includes Ball Camera, LCD Console, Camera Module, LCD Module, Patch Cable & 2 Power Supplies (White)

OQCM7644 Bullet Camera Kit **\$669.95**

Includes 2 Color Bullet Cameras, Camera Module, Modulator, Patch Cable & 2 Power Supplies (White)



LCD DISPLAY

• LCD Colors: White, Light Almond, Black or Titanium

A OQHA5000 Studio LCD Console **\$494.95**

B OQCM1010 LCD Module **\$174.95**

C OQHA5201 TV Display Interface **\$234.95**

Enables Camera Viewing Over The TV When Connected To The LCD Module (White, Light Almond or Black)

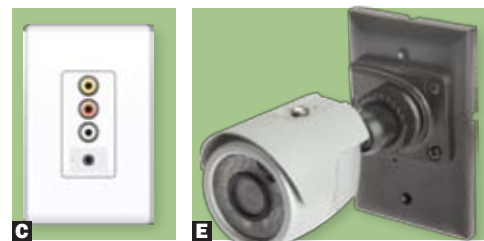

CAMERAS

• Ball Camera Colors: White, Light Almond or Brown

D OQCM5002 Day/Night Ball Camera **\$294.95**

Includes Both Wall & Ceiling Mounts

E OQCM1029 Color IR Bullet Camera **\$164.95**

OQF2299 Color Bullet Camera **\$239.95**

OQF2284 B&W Bullet Camera **\$134.95**

CAMERA ACCESSORIES

F OQCM1011 Camera Module **\$109.95**

G OQF2217 RCA to RCA Patch Cable **\$8.65**

WIRELESS CAMERAS

WIRELESS BULLET COLOR CAMERA KIT

The SecurityMan Wireless Outdoor/Indoor Bullet Color Camera Kit is perfect for monitoring your home or business. The camera features a weatherproof design so it can be used either indoors or outdoors.

- Perfect for monitoring around your home
- Wireless video direct to your TV or recorder
- High quality picture and sound transmitting and receiving
- No interference from crowded 2.4GHz devices
- Built-in IR LEDs for night vision (up to 23', B/W)
- Stronger wall penetration than 2.4GHz/5.8GHz wireless transmission
- Video transmission goes up to 330' clear line of sight or 100' indoor

TLCUCAM1 SecurityMan CUcam1 Kit **\$94.99**

Includes Wireless Outdoor/Indoor Color Camera, Wireless Receiver, Power Supplies, Cable, Manual & Installation Brackets.



WIRELESS HIDDEN CLOCK CAMERA

The Security Man Wireless Wall Clock Hidden Camera Kit is designed for users who want to discreetly monitor their visitors, strangers, baby sitters and business activities. It includes a wireless receiver and a wireless camera hidden in a functional wall clock. Simply mount the clock at a desired location, connect the power of the clock-camera, to receiver, and then connect the receiver to a monitor for live view, or connect to a recorder for recording. It is a perfect security product for homes and small businesses.

TLCLOCKCAM SecurityMan ClockCam Kit **\$119.99**

Includes Wall Clock Camera, Receiver, Power Supplies, Cables & User Manual



CAMERA ACCESSORIES

UNIVERSAL CAMERA MOUNT

This mount functions as a wall mount, table mount or ceiling mount. It's designed for lightweight compact cameras and is weatherproof for indoor and outdoor use.



SPCST125 Camera Mount **\$6.55**

VIDEO BALUN

Enforcer Modular Snap-in Passive Video Baluns are the easy way to quickly install any style of CCTV camera without coax cable. Just put one plate with a snap-in video balun in each room which might be protected by a CCTV camera, and run low-cost Cat5 or Cat5e cable from the balun to a centralized DVR or passive video hub.



SEEVTPB1Q Video Balun **\$16.95**



NEED INSTALLATION HELP?
Call 1-800-266-7654 For Free Tech Support!

CCTV POWER SUPPLIES

Seco-Larm's line of DC CCTV power supplies is the cost-effective way to power multiple cameras and is perfect for many security system and access control applications including integration with alarms.

- Each out individually fused
- Output fuses rated 1.1 Amps at 250VAC
- Spare fuse and 6' power cord included



12VDC CCTV POWER SUPPLIES

4 Outputs @ 12VDC (2.5A) **SEEV1SD2P4UL** **\$64.95**

9 Outputs @ 12VDC (4A) **SEEV1SD4P9UL** **\$89.95**

16 Outputs @ 12VDC (6A) **SEEV1SD6P16UL** **\$144.95**

24VAC CCTV POWER SUPPLIES

@ 24VAC (4A) **SEEV1SA4P4UL** **\$59.95**

@ 24VAC (4A) **SEEV1SA4P9UL** **\$74.95**

@ 24VAC (8A) **SEEV1SA8P16UL** **\$109.95**

POWER DISTRIBUTION MODULE

Converts a single AC or DC input into 9 individual outputs to power Video Cameras, PIRs, Photobeams, etc. Each output is protected with 250ma and 400ma auto-resetting PTCs to protect any shorted output from disabling the other outputs.



- Requires power supply

ELKPD9 Power Distribution Module, 250ma **\$42.95**

ELKPD9HC Power Distribution Module, 400ma **\$44.95**

ELKP1216 Power Supply, 1.5A, 12VDC **\$28.95**

Digital Video Recorders



CHANNEL VISION H.264 DVR

Channel Vision's DVR contains the latest H.264 digital compression technology to improve video streaming capabilities and reduce the storage space needed to archive recorded surveillance video. With a surveillance camera and a large storage space, you will be able to record hours of surveillance video.

- Two USB ports (for mouse usage and backup)
- Dual streaming enhances the speed of transmission
- Built-in VGA output up to 1024x768 resolution
- Individual setup of resolution, frame rate and video quality for each channel
- Still image snapshot
- AVI converter with time stamp

CVDVR163G1000 Channel Vision H.264 DVR, 16-Channel, 3G with 1TB Drive **\$879.95**

CVDVR83G500 Channel Vision H.264 DVR, 8-Channel, 3G with 500G Drive **\$709.95**

CVDVR43G500 Channel Vision H.264 DVR, 4-Channel, 3G with 500G Drive **\$394.95**

- Live display, record, backup, playback and network access simultaneously
- Picture-in-picture monitoring and 2X to 8X digital zoom display
- Control Methods: front panel, USB mouse, IR remote controller, client viewer
- Intuitive GUI for easy configuration and operation
- Pan / Tilt / Zoom camera control
- Data backup: USB devices, network
- Event triggered with email notification: motion detection, alarm, video loss
- Supports Internet Explorer with same GUI as DVR site
- Multi-language OSD

CUSTOMER FAVORITE!

SPECO MULTI-CHANNEL ANALOG & 16-CHANNEL IP HYBRID EMBEDDED DVR

Perfect for integration into your camera surveillance system, this color digital video recorder (DVR) provides recording capabilities for eight or 16 camera inputs, including megapixel IP cameras. The DVR is designed to bridge technological division by delivering hybrid IP and analog recording capabilities along with full HD display.

Feature-rich performance, extensive storage, display options and powerful search capabilities make these DVRs a simple migration strategy to IP with no added licensing fee. Anyone who has encountered expansion challenges of megapixel IP recording can now implement a cost-effective solution with these hybrid DVRs.

- Connect up to 5 monitors
- Various PTZ protocol support

SPD32PSx Speco 16-Channel Analog & 16-Channel IP Hybrid Embedded DVR **\$2429.95-\$4319.95**

Choose from 1TB HDD, 2TB HDD, 4TB HDD, 6TB HDD

SPD24PSx Speco 8-Channel Analog & 16-Channel IP Hybrid Embedded DVR **\$2234.95-\$4139.95**

Choose from 1TB HDD, 2TB HDD, 4TB HDD, 6TB HDD



- Both live and playback modes
- Recording modes: continuous, motion, alarm, pre/post-event, text-in, panic
- Free Apps with support for iPhone, iTouch, iPad, Blackberry, or Android

DVR LOCKBOXES

DVR STORAGE LOCKBOX WITH FAN

This DVR lockbox is constructed of formed steel and features an interlocking lift off lid and a keyed lock front door. The lockbox includes a fan with a power cord and vents for proper ventilation of the DVR.



VMDVRLB1 DVR Storage Lockbox With Fan **\$188.95**

VMDVRLB2 DVR Storage Lockbox With Fan & IR Window **\$233.95**

Includes a smoked Plexiglas window for IR signals

LOW PROFILE DVR STORAGE LOCKBOX

- Interior dimensions: 17.2" W x 21" D x 5" H

VMDVRLB3 Low Profile DVR Storage Lockbox **\$236.95**



HIDDEN DVR KIT

CVDVR43GKIT1 Hidden DVR Kit **\$564.95**

Includes 4-Channel H.264 Multiplex DVR (250 GB), Amplified IR Hub, IR Receiver, IR Emitter, Mounting Bracket, 19" Metal enclosure and hinged cover



USB INTERNET CAMERA & DVR CONVERTER BOX

ICAMDVR

Easily view security camera footage over the internet with the SecurityMan USB Internet Camera and DVR Converter Box. The system allows you to wirelessly connect wired/wireless security cameras to a PC, so you can view your surveillance feeds right from your computer monitor or any web-enabled device (smart phone, tablet, etc.). You can even record footage with the system's DVR function.

- Web-based remote monitoring and remote playback from web browser
- Auto-email, buzzer sound, pre-alarm record, and alert notification
- Supports up to four cameras, including PTZ control for PTZ cameras
- Includes software for recording, playback, remote monitoring and more
- Supports static IP or dynamic domain name

TLICAMDVR iCamDVR **\$84.99**

TLICAMDVR1W iCamDVR & Camera Kit **\$229.99**

Includes iCamDVR, 1 Wireless Indoor Color Camera, 1 Wireless Receiver, Cables, Accessories & Manual

CAMERA SERVER

HAI CAMERA SERVER

The HAI Camera Server is designed for a variety of convenient security applications including viewing cameras on HAI's OmniTouch 5.7e, on a handheld mobile device, or via the Internet for remote monitoring wherever you may find yourself.

- View video via mobile device or Internet
- MJPEG encoding up to 640x480 resolution
- Watch video on HAI's IP-based Touchscreens
- Can be applied stand-alone or with an HAI home control system
- Features PTZ and audio support

With the HAI Camera Server, you can now transmit video and audio data over a network in real-time. Analog video signals and audio signals convert to digital data and are compressed for online transmission. Camera video can then be viewed not just from home through OmniTouch 5.7e Touchscreens, but also over the Internet on a PC or handheld mobile device such as an iPhone, PDA or Smartphone.

- See HAI OmniTouch 5.7e Touchscreens, Page 27

HAI87A001 HAI Camera Server **\$679.95**

Leviton Structured Media Center

LEVITON

The wired home, once a novelty, has become essential – providing crucial access to advances such as high-speed Internet, digital television and data networking – advances that are becoming vital to functioning in the digital age. The challenge lies in creating an infrastructure that works with the systems already in a home, one that anticipates technological advances, lays the groundwork for the whole-house media system of the future, and incorporates high-tech solutions such as category-rated cabling and components, and opens doors to possibilities. The answer lies in the Structured Media System from Leviton. Structured Media Systems use an advanced, standards-compliant star topology to create one central convergence point in your home for all media and home electronics distribution. Simply run cables from individual rooms to one of a variety of Structured Media Centers, and use Leviton's innovative selection of modules and panels to manage and distribute audio, video, voice and data in the configuration best suited to a home's needs.

ENCLOSURES

SERIES 140

This 14" professional-grade whole-house media enclosure creates one distribution point in the home for all low voltage cables. The 140 is ideal for condos and apartments or more modest homes requiring limited audio/video/voice and data configurations. It will accommodate 2 Pre-Configured Structured Cabling Panels. The sturdy design and functionality facilitate installation, reduce job-site labor costs, and make it ideal for essential home networking.

LV47605140 Series 140 Kit **\$39.95**

Includes Enclosure & Flush-Mount Cover

LV4760514E Series 140 Enclosure (no cover) **\$29.95**

LV4760514P Series 140 Hinged Cover **\$44.95**

LV5L000LOK Hinged Cover Lock & Key **\$18.95**

SERIES 280

The 28" unit accommodates home networking, fax, internet, multi-line telephones, security camera, coaxial cable and satellite video distribution, speaker and audio distribution. The 280 enclosure can comfortably accommodate up to 12 different Distribution Modules, depending on selection and density. It is designed to incorporate a hospital-grade power quality module for maximum protection from line surges.

LV4760528W Series 280 Kit **\$84.95**

Includes Enclosure & Flush-Mount Cover

LV4760528N Series 280 Enclosure (no cover) **\$59.95**

LV4760528P Series 280 Hinged Cover **\$64.95**

LV4761228B Series 280 Extender Bracket **\$49.95**

LV5L000LOK Hinged Cover Lock & Key **\$18.95**

SERIES 420

The 42" unit can handle fax, Internet, multi-line telephones, security camera, coaxial cable and satellite video distribution, and audio distribution. The 420 enclosure, with its generous size and capacity for up to 18 modules, can simultaneously manage many diverse functions and is designed to accommodate our high-quality hospital-grade power module with surge suppression.

LV4760542W Series 420 Kit **\$124.95**

Includes Enclosure & Flush-Mount Cover

LV4760542N Series 420 Enclosure (no cover) **\$84.95**

LV4760542P Series 420 Hinged Cover **\$79.95**

LV4761242B Series 420 Extender Bracket **\$54.95**

LV5L000LOK Hinged Cover Lock & Key **\$18.95**



Shown With Optional Modules & Accessories (Sold Separately)

MEDIA VERSATILE PANEL

Ideal for custom retrofit and remodel applications, the Media Versatile Panel with 3/8" plywood backing allows for consolidating low voltage electronics and distribution components for phone, fax/modem, data, home networking, audio, video and home control. The sturdy construction is built to industrial-grade standards, and the panel can be surface-mounted or recessed in the wall.

LV4760224E Media Versatile Panel **\$84.95**

PHONE PANELS

TWIST & MOUNT PANELS

- Offers essential phone and data distribution
- Includes Retention Force Technology
- Universal T568A and T568B wiring cards for 100 style terminations
- Fits into any Structured Media Center enclosure
- Includes port ID labels and punch-down tool



LV476TM654 Twist & Mount Panel

with 12 Cat5e Ports and 12 Cat6 ports **\$184.95**

LV476TM524 Twist & Mount Panel

with 24 Cat5e Ports **\$159.95**

LV476TM624 Twist & Mount Panel

with 24 Cat6 Ports **\$219.95**

TELEPHONE DISTRIBUTION PANEL

- 4-pair 110 input
- 12 modular RJ45 jack outputs
- 4 RJ11 jack inputs
- Includes 12 8" satin patch cords to link the TIDP panel to media modules
- Ports are labeled
- Fits into any Structured Media Center enclosure



LV476TLT12 Telephone Input Distribution Panel (TIDP) **\$79.95**

BRACKETS

PLASTIC MOUNTING BRACKETS

LV47612SBK Single Plastic Bracket **\$29.95**

LV47612EBK Expansion Plastic Bracket **\$34.95**

LV47612DBK Data Plastic Bracket **\$29.95**

SECURITY & SHELF BRACKETS

LV47612UBK Security Shelf Bracket **\$34.95**

LV476121SB Security Bracket, 12" **\$44.95**

LV47612MMA Universal Shelf Bracket **\$10.95**

LV47612HSB Half-Width Security Plate **\$23.95**

LV47612FSB Full-Width Security Plate **\$29.95**

MOUNTING ACCESSORIES

LV47615NYL Push-Lock Pins (20 pack) **\$6.25**

LV476094X4 4x4 Breakout Module **\$19.95**



NEED HELP DESIGNING YOUR OWN SYSTEM?

Home Controls offers **FREE** design services. Just call 1-800-266-8765 to talk to our Tech Specialists!

VOICE, DATA, TV PANELS

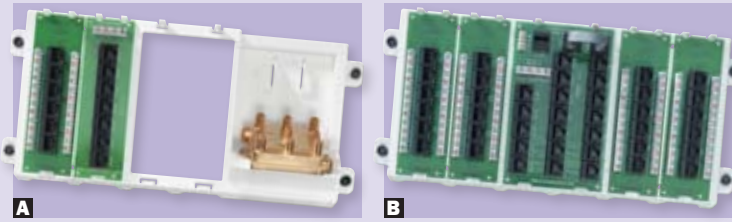

PRECONFIGURED PANELS

Leviton's Preconfigured Panels combine some of the most popular voice, data and video modules to create an economical home distribution point.

• Size: 6.25"H x 13.06"W x 2.5"D

LV47606BTV Basic Home Telephone & Video Panel **\$69.95**

1x9 Bridged Telephone Board, 6-Way 2GHz Video Splitter

A LV47606BNP Basic Home Networking Panel **\$99.95**

1x9 Bridged Telephone Board, Cat5e Voice & Data Board, 2GHz Video Splitter

LV47606AHT Advanced Home Telephone & Video Panel **\$129.95**

Telephone Line Distribution Module, Cat5e Voice & Data Board, 6-Way 2GHz Video Splitter

LV4760312P 12-Port Structured Media Panel **\$159.95**

Telephone Line Distribution Module, 2 Cat5e Voice & Data Boards, 19 Multi-Line Telephone Connections

LV4760318P 18-Port Structured Media Panel **\$189.95**

Telephone Line Distribution Module, 3 Cat5e Voice & Data Boards, 19 Multi-Line Telephone Connections

B LV4760324P 24-Port Structured Media Panel **\$219.95**

Telephone Line Distribution Module, 4 Cat5e Voice & Data Boards, 19 Multi-Line Telephone Connections

COMPACT PRECONFIGURED PANELS

Fit easily into the SMC Enclosures or can be used as stand alone panels.

• Size: 6.5"H x 6.5"W

LV476031G4 Telephone & 4-Way Video Panel **\$44.95**

LV476031G6 Telephone & 6-Way Video Panel **\$54.95**

1x9 Bridged Telephone Board & A 4-Way Or 6-Way 1ghz Video Splitter

LV47603TSV Telephone Security & 6-Way Video Panel **\$69.95**

1x7 Bridged Telephone Board & A 6-Way 1ghz Video Splitter

LV476031G8 Telephone & 8-Way Video Panel **\$59.95**

1x9 Bridged Telephone Board & A 86-Way 1ghz Video Splitter

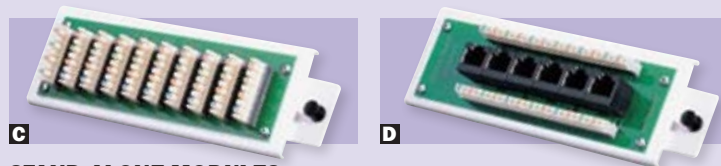

STAND-ALONE MODULES

C LV47689B 1x9 Bridged Phone Module **\$44.95**

D LV47605C5B Cat5 Voice & Data Module **\$44.95**

LV47609TSV Telephone Security Module **\$49.95**

LV47616DSB DSL Filter Module **\$44.95**

EXPANSION BOARDS

LV47603110 1x9 4-Line Bridged Phone Expansion Board **\$29.95**

LV47609F6 1x6 4-Line Bridged Telephone Expansion Board **\$24.95**

LV47609S10 1x10 6-Line Bridged Telephone Security Expansion Board **\$39.95**

LV47603C5 Cat5e Voice & Data Expansion Board **\$29.95**

LV47609EMP Telephone Patching Expansion Board **\$34.95**

LV47616DSF DSL Filter Expansion Board **\$29.95**

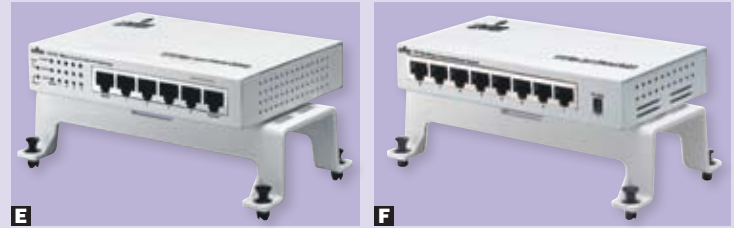

DATA NETWORKING

INTERNET GATEWAY

Leviton has routers to share Internet access, Ethernet switches to provide additional ports for the in-home Local Area Network (LAN), and a complete collection of connectivity products for Cat5e and Cat6 high-speed networking to help homeowners get their work done. You'll find everything you need to meet today's increasingly complex home office requirements.

E LV47611GT4 Internet Gateway, 4-Port **\$94.95**

LV476115PT Ethernet Switch, 5-port **\$74.95**

F LV476118PT Ethernet Switch, 8-Port **\$89.95**

LV48210MCH Decora Media System Media Hub with Power Supply **\$264.95**

TV DISTRIBUTION

PASSIVE TV SPLITTERS AND BRACKETS

Use the Leviton 8-Way Coaxial Cable Distribution Module to split digital cable, quality cable TV and off-air antenna signals to 8 televisions throughout the home or office.



G LV476908C2 Coax Cable Distribution Module, 2 GHz **\$39.95**

LV47693xP Premium CATV Module, 1 GHz **\$149.95-\$289.95**

Choose from 1x1, 1x8 or 1x16 Modules.

LV476913MS 3x4 Satellite Multi-Switch **\$69.95**

LV47690XC Passive Video Splitter Module, 1GHz **\$24.95-\$34.95**

Choose from 1x4, 1x6 or 1x8 Modules.



Complete your Leviton Structured Wiring System with QuickPort Inserts, Connectors & Wallplates. See Page 56.

POWER MODULES

J-BOX KITS

LV47605ACS J-Box Kit, Duplex Receptacle (Surge) **\$29.95**

LV47605ACN J-Box Kit, Duplex Receptacle (Non-Surge) **\$14.95**

AC POWER BLOCK

LV47605DP AC Power Module, 2 Duplex (Surge) **\$79.95**

LV47605NDP AC Power Module, 2 Duplex (Non-Surge) **\$44.95**



DC POWER SUPPLY MODULE

Provide DC Power to up to 6 modules.

LV48212DCS DC Power Module **\$104.95**

UNIVERSAL POWER SUPPLIES

LV47605PSB Universal Mini DC Power Supply (3 12VDC connectors) **\$89.95**

LV47605PSA Universal DC Power Supply (9 12VDC connectors) **\$184.95**

LV47605PSC Versatile AC/DC Power Supply

(6 12VDC connectors with 2 upward facing AC receptacles) **\$179.95**



On-Q Networking System

legrand

The On-Q Network System offers an organized approach to low voltage communications wiring distribution in the residential housing market. Several service center enclosure sizes cover the complete range of home and apartment sizes and desired functionality. An array of snap-in modules support telephone, data, local area network (LAN), audio and video services of all types. In addition, home management system controllers are an option to control security, lighting, energy and other conveniences. The modular design permits customization to homes of all sizes and application needs, such as for home office (fax, modem, Internet), entertainment (music, sound video), control of heating and cooling, sophisticated security with cameras (CCTV), programmed lighting and more.

ON-Q ENCLOSURES

ENCLOSURES WITH HINGED DOOR

The redesigned line of enclosures from On-Q sets a new standard for structured wiring efficiency. Combining the best features from the entire On-Q line, the comprehensive offering delivers an easier installation, a universally compatible mounting grid and a simplified ordering method. They are available in 4 sizes to meet the needs of any project.

- Left/right mounting covers
- Flush and surface installation
- Flanged covers hide drywall openings
- Drywall depth indicators
- Hangable screw-on cover for ease of installation
- Enhancement accessories include extenders, extender wire management, brushed aluminum frame
- Installation accessories include pouch for homeowner documentation, wiring diagram and cable guard
- Side tabs for more flexible mounting
- 2 J-box knock-outs for up to 4 outlets

- OQEN1450** 14" Enclosure With Hinged Door **\$74.95**
OQEN2050 20" Enclosure With Hinged Door **\$89.95**
OQEN2850 28" Enclosure With Hinged Door **\$114.95**
OQEN2800 28" Enclosure With Screw-On Door **\$89.95**
OQ36445003 28" Enclosure Extender **\$49.95**
OQEN4250 42" Enclosure With Hinged Door **\$184.95**
OQ36445004 42" Enclosure Extender **\$59.95**



ENCLOSURE OPTIONS

- OQEN1480** 14" Enclosure (No Cover) **\$39.95**
OQEN1460 14" Hinged Door **\$44.95**
OQEN2080 20" Enclosure (No Cover) **\$49.95**
OQEN2060 20" Hinged Door **\$54.95**
OQEN2880 28" Enclosure (No Cover) **\$64.95**
OQEN2860 28" Hinged Door **\$74.95**
OQ36459311 28" Door Frame, Clear Insert **\$114.95**
OQ36459314 28" Door Frame, Smoke Insert **\$114.95**
OQEN4280 42" Enclosure (No Cover) **\$104.95**
OQEN4260 42" Hinged Door **\$104.95**
OQ36459411 42" Door Frame, Clear Insert **\$139.95**
OQ36459414 42" Door Frame, Smoke Insert **\$139.95**

NETWORK CENTERS

Distributes incoming video signals to up to 4 television outlets and supports up to 6 telephone outlets with up to 4 phone lines. It's an economical solution for small, fixed installations.

- A OQ36439701** Basic Network Center, Surface Mount **\$64.95**
OQ36439301 Cover for Basic Network Center, Surface Mount **\$20.95**

Distributes incoming video signals for up to 6 television outlets and supports up to 11 telephone outlets with up to 4 phone lines. Network center features 2 expansion bays for additional modules.

- B OQ36439802** Advanced Network Center, Surface Mount **\$74.95**
OQ36439401 Cover for Advanced Network Center, Surface Mount **\$24.95**



ENCLOSURE ACCESSORIES

- OQ36489001** 1 Bay Bracket **\$14.95**
OQ36481901 2 Bay Bracket **\$14.95**
OQF7510 3 Bay Bracket **\$21.95**

- OQAC1007** 1 Bay Video Bracket **\$14.95**
OQ36449001 Key Kit (Hinged Enclosure) **\$11.95**
OQ36447801 Lock Assembly (Hinged Door) **\$11.95**

HOME ENTERTAINMENT CONNECTION CENTER 7.1

The Home Entertainment Connection Center 7.1 (HECC) provides a single connection point for satellite/cable, video, phone, data and speakers. It conceals messy wires behind the wall and features universal keystone insert support for easy installation and use. The HECC ships with a bracket for new construction, lyriQ Source Input Mounting Plate, and a cover for seamless installation.

- Features connections for CATV, digital satellite, and auxiliary video input; and telecom connections for data and telephone
- Rugged metal pre-wire bracket mounts on standard 16" on-center studs

- OQHT1000** Home Entertainment Connection Center 7.1 (HECC) **\$104.95**



ON-Q VIDEO MODULES



PASSIVE VIDEO MODULES

Distributes a CATV or antenna signal to 4, 6 or 8 TV outlets. DBS. 1GHz.

- A OQ36422201** 1x4 Passive Video Module **\$54.95**
OQ36464801 1x6 Passive Video Module **\$59.95**
B OQ36422401 1x8 Passive Video Module **\$84.95**

ENHANCED VIDEO MODULE

Distributes CATV signal for up to 16 TV outlets. Distributes video from cameras or VCR/DVD players.

- OQ36452201** 2x16 Video Module **\$339.95**



VIDEO AMPLIFIERS

Amplifies signals to up to 16 television locations and provides up to eight internal connections when installed with a video module.

- C OQVM7632** 2x2 Enhanced Bi-Directional Video Amplifier (requires power supply) **\$164.95**
OQPW7760 Power supply **\$19.95**

A simple solution that creates a flexible and scalable amplified video system. This affordable module makes it cost-effective to add amplification to every structured wiring installation.

- D OQVM7640** 1x1 Bi-Directional Video Amplifier (requires power supply) **\$49.95**
OQPW7760 Power supply **\$19.95**

PASSIVE VIDEO SPLITTER/COMBINERS

- OQVM1000** 1x4 Video Splitter/Combiner **\$21.95**
OQVM1002 1x8 Video Splitter/Combiner **\$39.95**

SATELLITE

The 1x4 Satellite Distribution Module combines an antenna, CATV and/or an internal video feed.

- OQVM7634** Satellite Distribution Module **\$69.95**

» www.HomeControls.com/On-QLegrandVideoModulesAccessories



**Studio Series Cat5
Camera System From On-Q.**
See Page 48.



**HOT SELLER: On-Q
Selective Call Intercom!**
See Page 81.

802.11N WIRELESS ACCESS POINT

On-Q/Legrand's 802.11n Wireless Access Point combines stylish design with blazing speeds and flexible install options to create the best, most reliable network solution for today's homeowners. With connection speeds up to 300Mbps, the N-WAP flawlessly supports even the most bandwidth-intensive wireless applications, such as streaming video services and online gaming, without loss of performance.



**CUSTOMER
FAVORITE!**

The N-WAP ships with both in-ceiling and in-wall mounting brackets and covers included for maximum install versatility, as well as a 48-volt power supply and Power over Ethernet (PoE) injector.

OQDA1101 Wireless Access Point **\$279.95**
Includes In-Ceiling or In-Wall Covers

ON-Q DATA MODULES

ROUTERS & SWITCHERS

Cost-effective switch supports up to 5 connections in a 10/100 Mbps Ethernet local area network.

- Auto-sensing and auto-configuring
- Provides connectivity for computers for a LAN
- Cat5e termination point for digital data services

OQDA1002 5-Port 10/100 Switch **\$74.95**

Allows a single high-speed internet connection (DSL/cable modem) to be shared among several computers.

OQDA1004 4-Port 10/100 Router/Switch **\$104.95**

The 8-Port Gigabit Switch provides the perfect way to share applications that require lots of information sent across a network.

- Requires power supply OQF7760 or similar.

A OQDA1008 8-Port Gigabit Ethernet Switch **\$234.95**

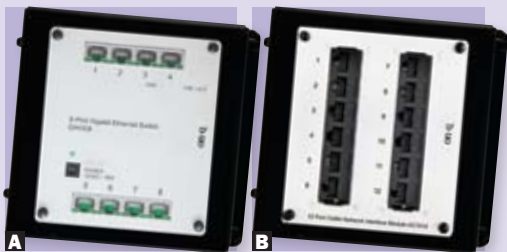

NETWORK INTERFACE MODULES

Share Internet connections, printers, files and modems. High-performance connection points for computers for an in-home local area network.



B OQAC1014 12-Port Network Interface, Cat5e **\$74.95**

B OQAC1015 12-Port Network Interface, Cat6 **\$99.95**

C OQ36348601 8-Port Network Interface, Cat5e **\$79.95**

ON-Q TELECOM MODULES

TELECOM MODULES

Supports up to 6, 8 or 12 telephone outlets, with up to 4 incoming lines. Directly interfaces to security systems.

- 1x12 Module also supports a high-speed Cat5e connection to 1 data outlet
- 1x8 Enhanced Module includes RJ45 telecom distribution jacks
- Power supply not included

A OQ126706201 1x6 Basic Telecom Module **\$54.95**

OQ36348402 1x12 Basic Telecom Module **\$94.95**

OQ36455101 1x8 Enhanced Telecom Module **\$74.95**

OQ126705801 6-Port Telecom Expansion Module **\$49.95**

OQ36455901 8-Port Enhanced Telecom Expansion Module **\$64.95**



A

Supports up to 4 incoming telephone lines and 10 flexible telephone outlets

OQTM7554 4X10 Punchdown Telecom Module (with line seizure port for security system) **\$34.95**

Accepts 4 incoming telephone lines and distributes them to up to 8 locations. It includes data ports for high-speed digital data and a security system line seizure port.

OQTM7556 4x8 Telecom Module **\$39.95**



B

Supports up to 4 incoming lines and 12 flexible telephone outlets with the ability to easily assign or reassign any line to any outlet. It includes data pass-throughs for high-speed digital data access.

B OQTM1478 4x12 Telecom Module **\$54.95**

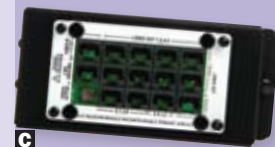

C

Accepts 4 incoming telephone lines and distributes them to up to 12 locations. It features RJ45 jacks for easy termination and more flexibility for future configurations as well as a line seizure port for easy integration with security systems.

C OQTM1475 4x12 Configurable Telecom Module **\$59.95**

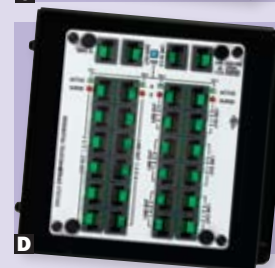

D

Module accepts 4 incoming telephone lines and enables flexible distribution to 24 telephone locations. It features advanced surge protection with an automatic resetting fuse and pushbutton activated LED monitoring for active line and surge conditions.

D OQTM7560 4x24 Configurable Telecom Module **\$114.95**

ANYLINE ADAPTER

Connect phones, faxes, and modems to any line at a 4-line telephone jack. Supports 2-line phones with 1 jack. Allows the homeowner to run multiple devices through a single jack. Offers a flexible plug on a cord that hangs discreetly below the jack.

E OQ36426001 AnyLine Adapter **\$18.95**



E

ON-Q COMBO MODULES

F OQ36440010 Basic 11x8 Telecom/Video Module **\$84.95**

11 Telecom Outlets & 8 Video Outlets

OQ36440011 Basic 6x6 Telecom/Video Module **\$54.95**

6 Telecom Outlets & 6 Video Outlets

OQ36440012 Advanced 6x8 Telecom/Video Module **\$79.95**

6 Telecom Outlets, 8 Video Outlets, RJ-31X Security Functionality & Surge Protection

OQ36440004 Basic 6x4 Telecom/Video Module **\$39.95**

6 Telecom Outlets & 4 Video Outlets

OQ36440013 Enhanced 8x8 Telecom/Video Module **\$79.95**

8 Telecom RJ45 Outlets, 8 Video Outlets & RJ-31X Security Functionality

OQ36440019 Basic 9x8 Telecom/Video Module **\$74.95**

9 Telecom RJ45 Outlets, 8 Video Outlets & RJ-31X Security Functionality



F

On-Q/Legrand's Complete Product Line » www.HomeControls.com/On-QLegrand

Bulk Wire & Cables

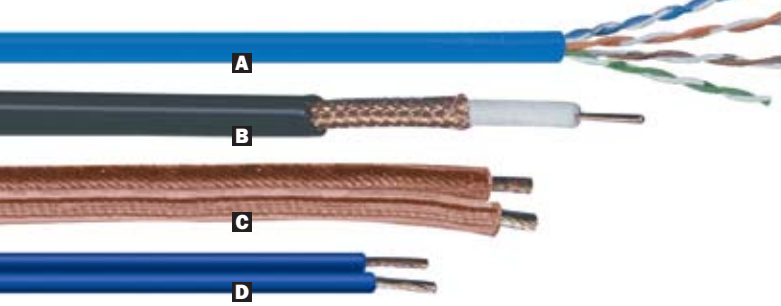

A CAT5E & CAT6 TWISTED PAIR WIRE

- Colors: Choose from White, Blue or Grey

WRCAT5E10 Cat5e, 4 Pair, 1,000' **\$134.95**

WRCAT610W Cat6, 4 Pair, 1,000', White **\$199.95**

B COAXIAL CABLE

WRRG6QD05 RG6, Quad Shield, 500', Black **\$59.95**

WRRG6QD10 RG6, Quad Shield, 1,000', Black **\$114.95**

WRRG6DL05 Siamese (Dual), Quad Shield RG6 Coax, 500' **\$189.95**

WRC5ERG605 RG6 Quad with Cat5e Siamese Cable, 1,000' **\$169.95**

WR1R2C5E05 Trimese Cable, 1 RG6 Quad & 2 Cat5e, 500' **\$374.95**

WRC5ERG605 Siamese Cable, 1 RG6 Quad & 1 Cat5e, 500' **\$169.95**

C MONSTER SIZE SPEAKER CABLE

WR12GMSP01 Speaker Cable, 12 Gauge, 100' **\$54.95**

WR10GMSP01 Speaker Cable, 10 Gauge, 100' **\$74.95**

WR10GMSP05 Speaker Cable, 10 Gauge, 500' **\$479.95**

D STANDARD SPEAKER CABLE

WR162SP05 Speaker Cable, 16 Gauge, 2 Conductor, 500' **\$119.95**

WR162SP10 Speaker Cable, 16 Gauge, 2 Conductor, 1,000' **\$234.95**

WR164SP10 Speaker Cable, 16 Gauge, 4 Conductor, 1,000' **\$419.95**

WR142SP10 Speaker Cable, 14 Gauge, 2 Conductor, 1,000' **\$344.95**

WR144SP05 Speaker Cable, 14 Gauge, 4 Conductor, 500' **\$314.95**

WR144SP10 Speaker Cable, 14 Gauge, 4 Conductor, 1,000' **\$624.95**

SECURITY, CCTV & FIRE CABLE

WR222CSJ10W Communication Security Wire, 22/2, Jacketed, 1,000' **\$69.95**

WR224CSJ10W Communication Security Wire, 22/4, Jacketed, 1,000' **\$94.95**

WR184NSDJ05 Fire Alarm Wire, 18/4, Jacketed, 500' **\$104.95**

WR182RG5905 RG59 Copper Braid, 2 Conductor, 18 Gauge, 500' **\$109.95**

ELK9022 Gel Filled B Connectors **\$28.95**

AUDIO CABLE

WR182SH05 18 Gage, Shielded Audio Cable, 500' **\$119.95**

WR182SH10 18 Gage, Shielded Audio Cable, 1,000' **\$234.95**

WRC5E164SP05 Bundled Cable (Siamese)

With 16G/4C Speaker & 1 Cat5e, 500' **\$439.95**

WR182RG5905 RG59 With 14G, 2C, CL3 Speaker Wire, 500' **\$109.95**

[Additional Cable Choices Online »](#)

www.HomeControls.com/BulkWireCable

HOW TO CHOOSE THE RIGHT WIRES

Whole House: In most installs, professionals use UL Listed Class 2 speaker cable, 14 gauge/4 conductor. 16 gauge/4 conductor is next most commonly used. For those demanding the highest quality cable, use Class 3 cable.

Media Room: Monster size cable is a favorite for media rooms, from Hi-Fi equipment directly to speakers in the same room. We recommend 12 gauge. A larger size 10 gauge is available for long wire runs.

Gauge: The lower the gauge size, the thicker the wire. For example, 12 gauge wire is thicker than 16 gauge wire.



YOUR GROUND SHIPPING COULD BE FREE
Wire Orders \$3,500 Or More Receive Free Ground Shipping

BUNDLED CABLES

Includes 2 Cat5e or Cat6 voice/data cables, 2 RG6 quad shield coaxial cables with or without 2 multi-mode fiber optic cables. Offers standard fire protection.

- Available in 500' rolls

WR2R2C2FJ Bundled Cat5e Cable with Fiber Optic, Jacketed **\$659.95**

WR2R2CJ Bundled Cat5e Cable without Fiber Optic, Jacketed **\$374.95**

WR2R2CB Bundled Cat5e Cable without Fiber Optic, Banana Peel **\$584.95**

WR2R2C62FS Bundled Cat6 Cable with Fiber Optic, Speed Wrap **\$684.95**

WR2R2C6J Bundled Cat6 Cable without Fiber Optic, Jacketed **\$459.95**

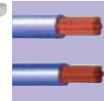

Cat5e twisted pair for telephone, computer networks, IR, receive/transmit, ISDN or ADSL

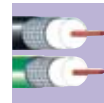

Coaxial cable for cable and satellite TV, security cameras, cable modems, and video conference.

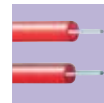

Fiber optic connections provide higher bandwidth and speed for current or future applications.

PATCH CORDS

ULTRA HIGH FLEX PATCH CORDS

Low profile cables allow for tighter radius connections.

- Length: Choose from 6', 1', 2', 3' or 4'.
- Colors: Choose from White, Yellow, Red or Blue.

LV5HHOM Cat5e Ultra High Flex Patch Cord **\$3.15-\$3.75**

LV6HHOM Cat6 Ultra High Flex Patch Cord **\$4.15-\$4.75**



HDMI CABLES

SCP HDMI CABLES

The Structured Cable High Speed HDMI Cable with Ethernet transfers Digital Audio and Video signals at fast speeds up to 10.2 Gigabytes per second!

- Available in 3', 6', 10', 15', 25' & 30'

SR944E HDMI Cable, 3' **\$5.65-\$59.95**

STEREN HDMI CABLES

- HDCP compliant
- HDMI approved
- Available in 3', 6', 10', 15' 30' & 50'
- 1080p-1080i-720-surround sound
- 24k gold plated contacts

ST5262xxBK HDMI Cable, 3' **\$4.75-\$39.95**

SWIVEL HEAD HDMI CABLE

Swivel Head HDMI Cable automatically compensates the stress on cable or movement of the component thereby allowing the connection to remain firmly in place.

- Available in 3', 6', 10' and 15'

SR947E* Swivel Head HDMI Cable **\$12.95-\$21.95**



MORE WIRING SYSTEMS!

OPENHOUSE

A revolutionary system that integrates entertainment, communications, safety and automation products, OpenHouse was designed to support the home of the future and the increasingly sophisticated needs of homeowners in a state-of-the art, technologically advanced living environment.



» www.HomeControls.com/OpenHouse

CHANNEL VISION

Structured Wiring systems by Channel Vision feature modular connected home wiring systems and components that are easy to install and upgrade. The Home Controls packaged solutions simplify your system design and offer installers flexible options to fit any specifications.

» www.HomeControls.com/ChannelVision

CABLE INSTALLATION

RECESSED MEDIA BOX

Use the DataComm Electronics Recessed Media Box to install power and low voltage cables from behind your flat panel TV, your amplifier or other audio and video devices to your equipment room. Use in your equipment room to organize your incoming audio and video cables.

The Recessed Media Box is designed for new construction or retrofit installations. The flexible cover plate gives the Recessed Media Box the clean finish look you expect.

• Colors: Choose from White or Black

DT450010x DataComm Recessed Media Box **\$29.95**

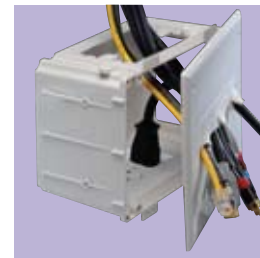

WIRE BUSHINGS

For installing low voltage wires through drywall.

- Use common drill and/or hole saw
- For single or double drywall thicknesses
- Provides smooth exit/entry of cables and protects drywall from chipping
- Made of high-impact plastic
- Color: White (paintable)

AAWB* Arlington Wire Bushing **\$0.25-\$0.65**

Choose 0.5", 0.875", 1.125" and 2.125" Hole Sizes



CONNECTORS & ADAPTERS

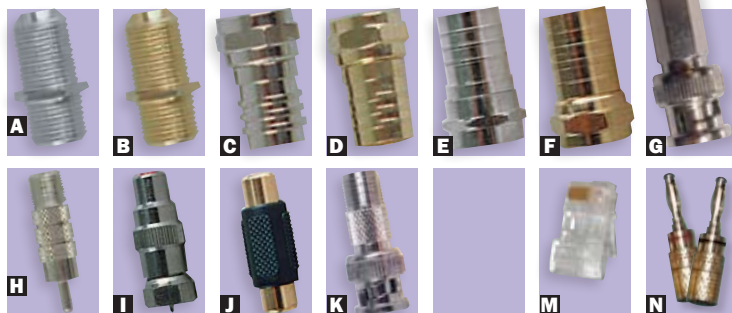

REGULAR & GOLD SERIES CONNECTORS & ADAPTERS

- A** **ST200050** Double Female Inline Splice **\$0.15**
- B** **ST200051** Double Female Inline Splice Gold Series **\$0.55**
- C** **ST200030** Crimp-on Male F-Connector (for RG59) **\$0.25**
- D** **ST200031** Crimp-on Male F-Connector (for RG59) Gold Series **\$0.45**
- E** **ST200035** Crimp-on Male F-Connector (for RG6) **\$0.25**
- F** **ST200036** Crimp-on Male F-Connector (for RG6) Gold Series **\$0.45**
- G** **ST200142** RG59/BNC Connector, Twist-on **\$0.55**
- H** **ST200110** F Female to RCA Male Adapter **\$0.55**
- I** **ST200045** F Male to RCA Female Adapter **\$0.75**
- J** **ST251116** RCA Double Female Inline Splice Gold Series **\$0.35**
- K** **ST200130** F-Jack to BNC Plug **\$0.85**
- M** **ST301178** RJ45 Connectors, Male **\$0.25**
- N** **OEW4PLUG** Quick Solderless Banana Plug, 4 Pack (2 red, 2 black) **\$9.95**
- OEW16PLUG** Quick Crimp-on Banana Plugs, 16 Pack (8 red, 8 black) **\$18.95**

EZ-RJ45 CONNECTORS

The new patented EZ-RJ45 connector simplifies twisted pair terminations by allowing the wires to be inserted through the connector and out the front. This allows the installer to easily verify the proper wiring order.

- PL100003** EZ-RJ45 Connectors, Cat5/5e, 50-pieces **\$34.95**
- PL202003J** EZ-RJ45 Connectors, Cat5/5e, 100-pieces **\$64.95**
- PL100010C** EZ-RJ45 Connectors, Cat6, 50-pieces **\$34.95**
- PL202010J** EZ-RJ45 Connectors, Cat6, 100-pieces **\$69.95**
- PL100054B** EZ-RJ Pro Crimp Tool **\$89.95**

• No more snags, hang ups or tangled messes

- PL100035** EZ-RJ45 Strain Relief, Cat5/5e, 50-pieces **\$12.95**
- PL100036** EZ-RJ45 Strain Relief, Cat6, 50-pieces **\$12.95**



WATERPROOF COMPRESSION CONNECTORS

SealSmart Compression Connectors provide fast and reliable terminations. The perfect solution for CATV, DSS, Security and Residential Structured wiring installations.

- Molded in gaskets provide a waterproof seal
- Screw machined housing
- Single crimp termination with captive center contact design
- Works with Universal Crimp Tool (PL16201, page 60)

- O** **PL18001** Compression F Connector, RG6 Quad **\$0.69**
- O** **PL18011** Compression F Connector, RG59 **\$0.69**
- O** **PL18006** Compression F Connector, RG6 **\$0.69**
- PL28006J** Compression F Connectors, RJ6, 75 piece **\$0.69**
- P** **PL18038** Compression BNC Connector, RC6 **\$2.19**
- P** **PL18035** Compression BNC Connector, RC6 Quad **\$2.19**
- P** **PL18041** Compression BNC Connector, RC59 **\$2.19**
- PL28041J** Compression BNC Connectors, RG59, 40 piece jar **\$2.19**
- Q** **PL18065** Compression RCA Connector, Nickel, RG6 Quad **\$1.89**
- PL18055** Compression RCA Connector, Gold, RG59 **\$2.29**
- Q** **PL18060** Compression RCA Connector, Nickel, RG59 **\$1.89**
- ELK9022** Gel Filled B Connectors, 500 pack (non-compression) **\$28.95**

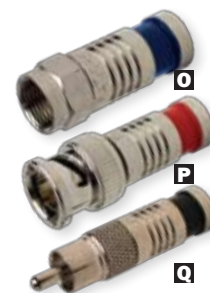

SELF-TERMINATING CONNECTORS

EZ-SNAPJACK

You may never again need a punch-down tool. At least not for your wall jacks! The patented EZ-SnapJack is self-terminating and quickly installs for professional results in a snap.

- Repair damaged jacks on the spot
- Wire guide ensures pairs stay in order for fast, easy termination
- No Punchdown Tool required (does require a Flush Cutter)
- Colors: Choose from White, Light Almond, Blue, Green, Brown, Almond, Ivory, Black, Yellow, Red or Orange.

- PL705*1** EZ-SnapJack, Cat5e **\$4.29**
- PL705*4C** EZ-SnapJack, Cat5e, pack of 4 pieces **\$17.95**
- PL706*1** EZ-SnapJack, Cat6 **\$4.59**
- PL706*4C** EZ-SnapJack, Cat6, pack of 4 pieces **\$18.95**
- PL10531** Flush Cutter **\$10.95**



CUSTOMER FAVORITE!

MULTI-MEDIA INSERTS & WALLPLATES

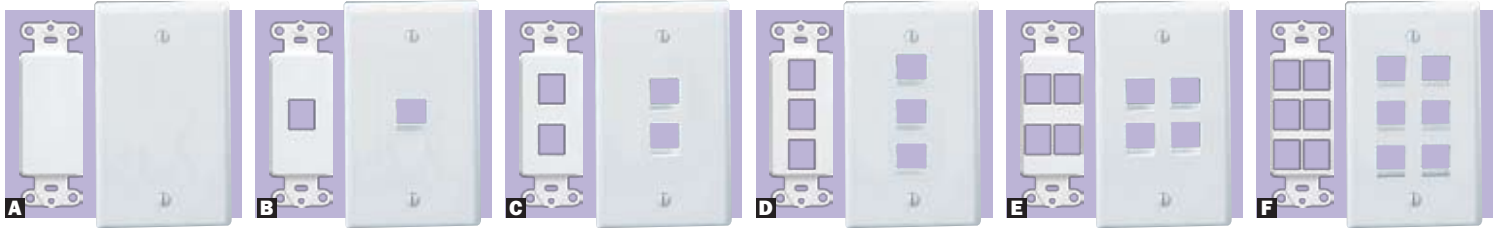

MULTIMEDIA INSERTS/STRAPS

	LEVITON QUICKPORT INSERTS		ON-Q/LEGRAND KEYSTONE INSERTS		LEVITON QUICKPORT WALLPLATES		ON-Q/LEGRAND KEYSTONE WALLPLATES	
A Blank Decorator	LV80414	\$4.75	OQWP3410	\$0.85	LV80714	\$1.45	OQWP1194	\$0.85
B 1-Port Decorator	LV41641	\$4.85	OQWP3411	\$1.15	LV410801xP	\$1.95	OQWP3401	\$1.05
C 2-Port Decorator	LV41642	\$4.85	OQWP3412	\$1.15	LV410802xP	\$1.95	OQWP3402	\$1.05
D 3-Port Decorator	LV41643	\$4.85	OQWP3413	\$1.15	LV410803xP	\$1.95	OQWP3403	\$1.05
E 4-Port Decorator	LV41644	\$4.85	OQWP3414	\$1.15	LV410804xP	\$1.95	OQWP3404	\$1.05
F 6-Port Decorator	LV41646	\$4.85	OQWP3416	\$1.15	LV410806xP	\$1.95	OQWP3406	\$1.05



MULTIMEDIA CONNECTORS

	LEVITON QUICKPORT		ON-Q KEYSTONE	
G Cat5e RJ45 Connector	LV5EHOMR x5	\$3.55	OQWP3450	\$3.65
H Cat6 RJ45 Connector	LV61HOMR x6	\$7.15	OQWP3460	\$6.65
I Audio Binding Posts Red Stripe	LV40833B	\$4.35	OQWP3457	\$6.75
J Audio Binding Posts Black Stripe	LV40833B	\$4.35	Includes Black & Red	
K RJ25 Connector	LV41106R x6	\$3.35	OQWP3425	\$2.75
L RCA Connector	RCA to RCA		RCA to F-Type (Coax)	
Red Stripe	LV40830B	\$3.85	OQWP3462	\$3.25
Green Stripe	LV40830B	\$3.85	OQWP3463	\$3.25
Blue Stripe	LV40830B	\$3.85	OQWP3464	\$3.25
Yellow Stripe	LV40830B	\$3.85	OQWP3465	\$3.25
Black Stripe	LV40830B	\$3.85		
Purple Stripe			OQWP3466	\$3.25
White Stripe			OQWP3461	\$3.25
M F-Connector	LV41084F xF	\$2.55	OQWP3481	\$1.65
N F-Connector (Gold-Plated)	LV40831B	\$3.75		
O Blank Insert	LV41084B xB	\$0.25	OQWP3455	\$3.45
	Sold Individually		Sold in packs of 10	



ADDITIONAL LEVITON QUICKPORT CONNECTORS

- P LV40837B** Banana Jack, Black Stripe **\$3.75**
- Q LV40837B** Banana Jack, Red Stripe **\$3.75**
- R LV40734SVx** S-Video to 110 Punch Down **\$9.95**
- S LV40735R** RCA to 110 **\$7.65**
- LV40782CPF** Compression F Connector **\$3.45**
- LV40782RxW** Compression RCA Connector **\$5.55**
- LV40740BE** QuickPort Labels **\$5.65**

ADDITIONAL ON-Q KEYSTONE CONNECTORS

- OQWP3456** Speaker Outlet **\$4.55**
- OQWP3458** Cat5e RJ45 Connector, Keyed **\$4.55**
- OQWP3482** F-Connector (Self-Terminating) **\$3.85**

Leviton QuickPort Colors: Choose White, Ivory, Almond, Light Almond, Grey, Black or Brown
RJ25, Cat5e and Cat6 also available in Orange, Blue, Red, Green and Purple

On-Q Keystone Colors: Choose White, Ivory, Light Almond, Black or Brown
Cat5e and Cat6 also available in Blue, Grey, Orange and Red

AVAILABLE COLORS
For Products On This Page

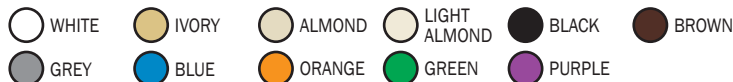

LEVITON RECESSED OUTLET

- Flush-mounted to install behind units
- Wallplates built in
- Centralizes device connection for AC power, plus opening for 6 installer-selected QuickPort connectors or blank inserts (4 inserts included)
- Plastic electrical box with a barrier to separate line and low-voltage conductors
- Colors: Choose White, Ivory, Light Almond or Black



LV690 Recessed Electrical & Low Voltage Combo Box, 2-Gang **\$25.95**

More Recessed Outlets » Page 58

CHANNEL VISION SCREWLESS WALLPLATES WITH SNAP-ON LABELS

- Works with both Leviton QuickPort and Channel-Vision jacks.
- Features snap-on labels.



CHANNEL VISION SCREWLESS WALLPLATE WITH LABELS

1-Port Wallplate	CVG1DG	\$1.75
2-Port Wallplate	CVG2DG	\$1.75
3-Port Wallplate	CVG3DG	\$1.75
4-Port Wallplate	CVG4DG	\$1.75
6-Port Wallplate	CVG6DG	\$1.75

Colors (*): Choose White, Ivory or Almond.

MULTI-MEDIA INSERT KITS

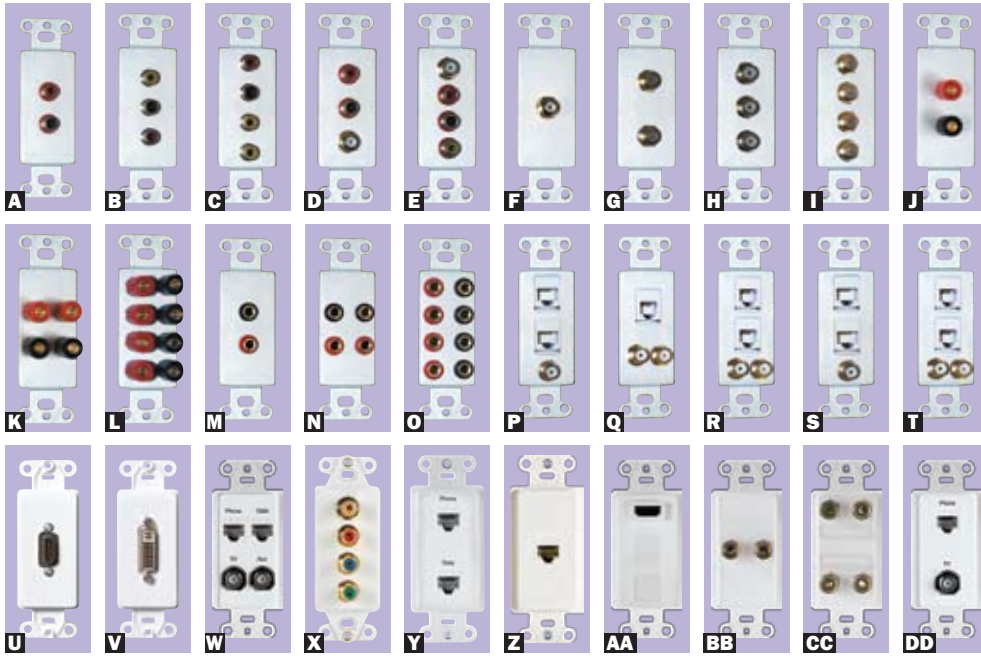

PRE-CONFIGURED COMBINATION JACK PLATES

- Pro-Wire Colors: Choose White, Ivory or Almond
- Leviton Colors: Choose White or Ivory
- On-Q Colors: Choose White, Ivory, Light Almond, Brown or Black

- | | |
|---|---|
| A OEIW2RG Pro-Wire 2 RCA \$8.15 | P OEIW1F2RJG Pro-Wire 1 Coax, 2 RJ11 \$17.95 |
| B OEIW3RG Pro-Wire 3 RCA \$8.85 | Q OEIW2F1RJG Pro-Wire 2 Coax, 1 RJ11 \$17.95 |
| C OEIW4RG Pro-Wire 4 RCA \$11.95 | R OEIW2F2RJG Pro-Wire 2 Coax, 2 RJ11 \$19.95 |
| D OEIW2R1FG Pro-Wire 2 RCA, 1 Coax \$8.85 | S OEIW1F2RJ45G Pro-Wire 1 Coax, 2 RJ45 \$17.95 |
| E OEIW3R1FG Pro-Wire 3 RCA, 1 Coax \$9.95 | T OEIW2F2RJ45G Pro-Wire 2 Coax, 2 RJ45 \$20.95 |
| F OEIW1FG Pro-Wire 1 Coax \$8.15 | U LV4164700 Leviton HDMI Jack Plate \$18.95 |
| G OEIW2FG Pro-Wire 2 Coax \$8.15 | V LV4164800 Leviton DVI Jack Plate \$29.95 |
| H OEIW3FG Pro-Wire 3 Coax \$8.85 | W OQWP3422 On-Q Phone, Data, TV, Aux \$12.95 |
| I OEIW4FG Pro-Wire 4 Coax \$9.95 | X OQWP1010 On-Q Component Video \$29.95 |
| J OEIWM2BPG Pro-Wire 2 Binding Post \$10.95 | Y OQWP3220 On-Q Phone & Data \$9.95 |
| K OEIWM4BPG Pro-Wire 4 Binding Post \$14.95 | Z OQWP3210 On-Q RJ45 \$29.95 |
| L OEIWM8BPG Pro-Wire 8 Binding Post \$24.95 | AA OQWP1011 On-Q HDMI with 2-Port (Blank) \$23.95 |
| M OEIW2BG Pro-Wire 2 Banana \$9.95 | BB OQF9006 On-Q Single Speaker \$8.55 |
| N OEIW4BG Pro-Wire 4 Banana \$13.95 | CC OQF9005 On-Q Dual Speaker \$21.95 |
| O OEIW8BG Pro-Wire 8 Banana \$25.95 | DD OQWP3211 On-Q Phone & TV \$7.25 |

More Wallplate Options Online! » www.HomeControls.com/WallplatesJacksInserts

HDMI INSERTS

PRO-WIRE HDMI JACK PLATES

- Female HDMI front & back
- Colors: Choose White, Ivory or Almond

- | |
|---|
| A OEIWMHDMI1 Pro-Wire 1 HDMI \$11.95 |
| B OEIWMHDMI2 Pro-Wire 2 HDMI \$17.95 |
| C OEIWMHDMI31 Pro-Wire 1 HDMI, 3-Port (Blank) \$11.95 |

SCP HDMI WALLPLATES

- Built-in Wallplate
- Colors: Choose White, Ivory or Almond

- | |
|---|
| D SR125 HDMI Wallplate \$16.95 |
| E SR126 HDMI with 3 RCA \$21.95 |

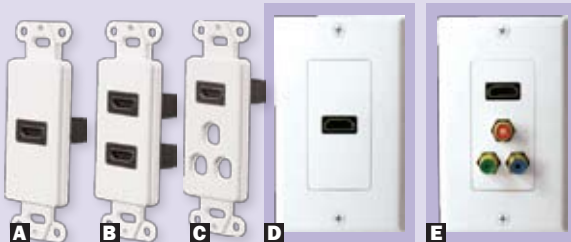

HDMI Cables.
See Page 54.



AVAILABLE COLORS
For Products On This Page



MULTI-MEDIA KITS

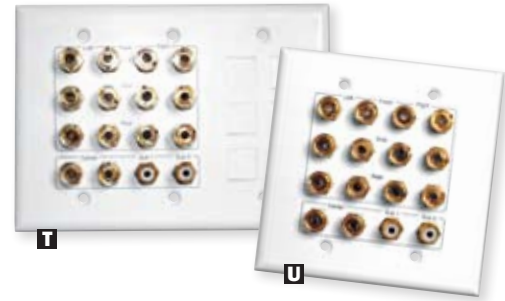

CHANNEL VISION KITS

CHANNEL VISION 3-GANG HOME THEATER KIT

- Fits in a 3-gang box
- Easy to install
- Expansion ports for additional connectors

I CVCC372 Home Theater Connection **\$34.95**

CHANNEL VISION PRECONFIGURED 2-GANG

- Fits in a 2-gang box
- Easy to install
- Ideal for 7.2 or smaller home theatre systems

U CVCC272 Home Theater Connection **\$34.95**

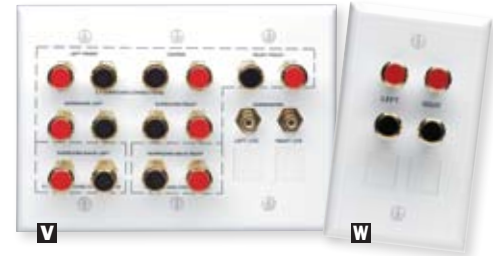

LEVITON HOME THEATER KITS

For use with low voltage rings and low voltage J-boxes.

HOME THEATER INTERFACE WALLPLATE

Accommodates from 5.1 to 7.1 channel surround-sound systems which connect to the A/V Receiver

- 2 QuickPort snap-in openings for adding other connectors (such as video connectors)
- RCA connectors for connecting subwoofers

V LVAEHTK Theater Interface Wallplate Kit **\$89.95**

MULTI-ROOM STEREO SPEAKER WALLPLATE

- Integrated wallplate for connecting Left and Right Audio Speakers (+/- connections), and 2 extra openings for additional QuickPort connectors

W LVAEMRK Multi-Room Stereo Speaker Wallplate Kit **\$29.95**

ON-Q HOME THEATER KIT

- Includes a connection for the sub-woofer in a 5.1 multi-room audio installation
- Fits into a standard 2-gang wallplate
- Colors: Choose White, Ivory, Light Almond, Brown or Black

OQF9004 5.1 Home Theater Outlet Straps **\$29.95**



Home Theater Outlets & Plates

DATA COMM RECESSED MULTI-MEDIA CONFIGURATIONS

CABLE ACCESS



CUSTOMER FAVORITE!

FLAT PANEL TV CABLE ORGANIZER KIT

Use this easy-to-install Flat Panel TV Cable Organizer Kit with Power Solution to install power and hide unwanted A/V cables in the wall behind your flat panel TV.

DT503323WHKIT Flat Panel TV Cable Organizer Kit with Power Solution **\$59.95**

Includes Recessed Cable Plate with Power Outlet, Recessed Cable Plate with Straight Blade Inlet, 6' Extension Cord, 2 Electrical Boxes & 8' Non-Metallic Electrical Wire

RECESSED PRO-POWER CABLE KIT

Install power and low voltage cables behind your flat panel TV, your amplifier or other audio and video devices to your equipment room. Can be installed upright or upside down.

DT450023WH Recessed Pro-Power Cable Kit **\$59.95**

Includes Recessed Low Voltage Cable Plate, Recessed Low Voltage Cable Plate with Recessed Straight Blade Inlet, 6' 14/2 with Ground Extension Cord & 3 Wire Nuts

RECESSED LOW VOLTAGE MEDIA PLATE

DataComm's new, patented Recessed Low Voltage Media Plate with Duplex Receptacle offers the convenience of a duplex receptacle and a recessed plate with enough room to store the low voltage cables behind your TV.

- Low profile design fits behind the industry's thinnest mounts and TV's
- Conceal multiple A/V cables behind your flat panel TV
- 15 Amp/125 Volt tamper resistant, duplex receptacle
- Mounting wings are molded into the media plate and fasten tightly against the back of the drywall

DT450031WH Recessed Low Voltage Media Plate **\$24.95**

DT450041WH Recessed Low Voltage Media Plate with Surge **\$54.95**



ON-Q/LEGRAND MULTI-MEDIA CONFIGURATIONS

HOME THEATER KITS

On-Q/Legrand kits provide recessed power and cabling connections for Home Theater, flat panel and TV installation.

- Color: White

OQHT2103WHV1 On-Q/Legrand Home Theater Connection Kit **\$54.95**

OQHT2102WHV1 On-Q/Legrand Flat Panel TV Connection Kit **\$29.95**



ARLINGTON RECESSED MULTI-MEDIA CONFIGURATIONS

ARLINGTON TV BOX

Arlington's recessed TV BOX for new or old work allows LCD and plasma TVs to mount flush against the wall.

Its double-gang design allows you to install two duplex receptacles or low voltage devices. Or you can use the supplied box separator to install one low voltage device and one duplex receptacle.

TV BOX also has two additional built-in mounts for low voltage, data/media connections. The 13" wide, non-metallic TV BOX mounts between 16" o.c. studs for a secure horizontal or vertical installation.

- Color: White or Black



AATVB613x Arlington TV Box **\$16.95**

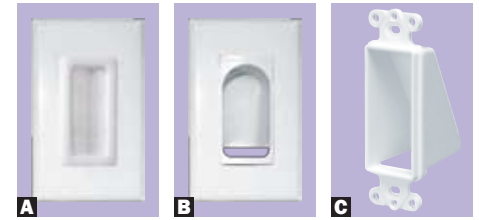

Provide clean cable access from any wall to your A/V sources with these pre-configured cable accesses.

- Wallplate not included (see page 59)
- Color: White

A OQWP1014WH On-Q Cable Access Strap **\$6.45**

E CVG1CDW Channel Vision Cable Access Strap **\$2.35**

The Arlington Scoop series of reversible non-metallic, entrance hoods protect cable to deliver good looks and installation versatility.

- Easy to install facing In or Out
- Colors: White or Black

C AACED1 Cable Access Wallplate **\$1.95**

AACEDH1x Horizontal Cable Access Wallplate **\$1.95**



These DataComm recessed low voltage cable plates can be installed upright or upside down. Install them upside down when installing flat panel TVs.

- Colors: White, Ivory, Light Almond, Black or Brown

D DT450001x Cable Access Wallplate, 1 Gang **\$2.65**

E DT450002x Cable Access Wallplate, 2 Gang **\$3.75**

F DT450003x Cable Access Wallplate, 3 Gang **\$6.95**

EASY MOUNT RECESSED WALLPLATES

Use to install low voltage cables behind your flat panel TV, your amplifier or other audio and video devices. The mounting wings are molded into the Easy Mount wallplate and fasten tightly against the back of the drywall.



CUSTOMER FAVORITE!

The Slim Fit version is designed for use in concrete wall applications where the drywall is hung with 1x4 furring strips.

- Colors: Black, Ivory, Light Almond or White

DT450008x Easy Mount Recessed Low Voltage Wallplates **\$3.75**

AVAILABLE COLORS
For Products On This Page



Designer Wallplates

ON-Q/LEGRAND STUDIO WALLPLATES

ON-Q STUDIO WALLPLATES

Featuring titanium edging and a screwless finish, the Studio design wallplates add a touch of elegance to any room. Works with any decorator-style switch.

- Available in 17 Colors

OQWP5001 1-Gang Wallplate **\$6.55**

OQWP5003 3-Gang Wallplate **\$15.95**

OQWP5002 2-Gang Wallplate **\$10.95**

OQWP5004 4-Gang Wallplate **\$18.95**



BASICS



HUES

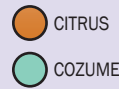

NATURALS



IN BOX

Arlington's recessed indoor IN BOX for a new or retrofit project allows LCD and plasma TVs (furniture too) to be placed flush against the wall. For power or low voltage, IN BOX mounts securely to the stud (new construction) or drywall (retrofit).



- Positioning tabs for 1/2" wall thickness ensure accurate placement on stud
- Horizontal or vertical mounting
- Multi-gang styles come with a separator that allows you to install low voltage and power devices in the same box
- Colors: White or Black

AADVFR1x Arlington IN BOX, 1-Gang **\$9.85**

AADVFR2x Arlington IN BOX, 2-Gang **\$14.95**

AADVFR3x Arlington IN BOX, 3-Gang **\$16.95**

AADVFR4x Arlington IN BOX, 4-Gang **\$18.95**

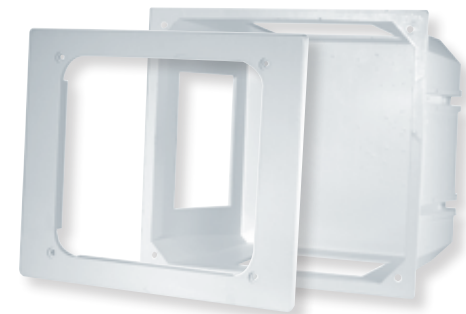

LEVITON RECESSED ENTERTAINMENT BOX (REB)

The Leviton Recessed Entertainment Box (REB) is designed to help you manage home theater electronics from a single location. The REB centralizes device connection points for all AC power, audio, video, home theater, data and phone connections.

LV47617REB REB Kit, Low Profile **\$23.95**

LEVITON DECORA WALLPLATES

LEVITON DECORA WALLPLATES

These designer wallplates are perfect for your decorative-style switches and receptacles.

- Colors: Choose White, Ivory, Almond, Light Almond, Brown, Black or Grey

A LV80401 1 Decora Wallplate **\$0.95**

B LV80409 2 Decora Wallplate **\$2.35**

C LV80405 1 Decora, 1 Toggle Wallplate **\$2.55**

D LV80455 1 Decora, 1 Duplex Wallplate **\$2.25**

E LV80411 3 Decora Wallplate **\$4.65**

F LV80431 2 Decora, 1 Toggle Wallplate **\$8.75**

G LV80421 1 Decora, 2 Toggle Wallplate **\$4.45**

LV80412 4 Decora Wallplate **\$9.15**

LV80423 5 Decora Wallplate **\$14.95**

LV80436 6 Decora Wallplate **\$17.95**

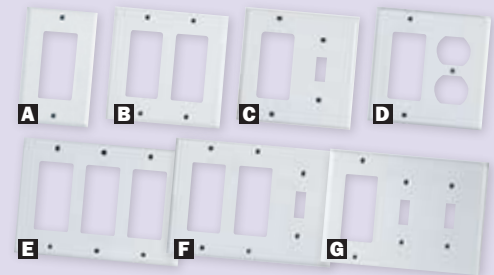

LEVITON SCREWLESS WALLPLATES

Enhance your interior with Decora Plus Wallplates. Sleek, smooth contemporary architectural styling enhances fine decor. Screwless, thermoplastic snap-on design for easy placement. Decora-compatible two piece kit allows easy retrofit to any decora installation.

- Colors: Choose White, Ivory, Almond, Light Almond, Brown, Black or Grey

LV80301 1-Gang Wallplate **\$4.65**

LV80312 4-Gang Wallplate **\$29.95**

LV80309 2-Gang Wallplate **\$9.25**

LV80321 5-Gang Wallplate **\$49.95**

LV80311 3-Gang Wallplate **\$14.95**

LV80326 6-Gang Wallplate **\$59.95**



LOW VOLTAGE WALL BRACKETS

BOX BUDDY MUD RING

These unique mud rings have flanges located to allow an unobstructed device (volume control, etc) insertion path even if conduit connectors are used. Use with or without conduit or smurf connector.



OEMR21 2-gang mud ring with 1" conduit/smurf connector holes **\$4.35**

OEMR22 2-gang mud ring with 2" conduit/smurf connector holes **\$4.35**

OEMR31 3-gang mud ring with 1" conduit/smurf connector holes **\$5.15**

OEMR32 3-gang mud ring with 2" conduit/smurf connector holes **\$5.15**

OEMR421 4-gang mud ring with 1" & 2" conduit/smurf connector holes **\$6.25**

OEMR8 8-gang mud ring with 1" & 2" conduit/smurf connector holes **\$19.95**

More Wallplate Options Online! » www.HomeControls.com/Wallplates

ARLINGTON WALL MOUNTING BRACKETS

Designed to mount wallplates flush for better-looking job.

AALV1 1-Gang Low Voltage Bracket **\$1.45**

AALV2 2-Gang Low Voltage Bracket **\$1.95**

AALV3 3-Gang Low Voltage Bracket **\$3.25**

AALV4 4-Gang Low Voltage Bracket **\$5.45**



ON-Q/LEGRAND WALL MOUNTING BRACKETS

Made of rigid plastic for precise, reliable installation

NEW CONSTRUCTION

OQAC100901 1-Gang Low Voltage Bracket with Nail **\$1.15**

OQAC100902 2-Gang Low Voltage Bracket (Face Mount) **\$1.95**

RETROFIT

OQAC101001 1-Gang Low Voltage Bracket **\$1.55**

OQAC101002 2-Gang Low Voltage Bracket **\$2.05**

OQAC101003 3-Gang Low Voltage Bracket **\$2.45**



Installation Tools



STRIPPERS

CABLE JACKET STRIPPER

- For Cat5, Cat5e and Cat6 cables
- Will not nick the inner conductors

A **PL15015** Cat5 Cable Jacket Stripper **\$12.95**

CYCLOPS CABLE JACKET STRIPPER

For many types of twisted pair, multicore and fiber optic cables. The tool self-adjusts to automatically cut PVC, plenum-rated materials and others without damaging the braids, foils or conductors.

B **PL15010** Cyclops Cable Jacket Stripper **\$29.95**



CRIMP TOOLS

ALL-IN-ONE CRIMP TOOL

The primary tool with RJ45, RJ11, RJ12 and RJ22 (Handset) modular plugs. Three crimp cavities for 4, 6 and 8 position modular plugs. Built-in cutter and two strippers for round and flat cables.

C **PL12503** All-In-One Crimp Tool **\$34.95**

SEALSMART CRIMP TOOL

D **PL16201** SealSmart Compression Crimp Tool **\$44.95**

SPECIALTY TOOLS

PUNCHDOWN/TERMINATION TOOLS

Use to make reliable connections on a variety of wire termination blocks with a simple push of the handle. Its adjustable impact setting enables wires to be terminated with less effort than with other impact tools.

- Terminates 22, 24 or 26 gauge wire
- Chamber in handle stores spare blade

PL13107B Platinum Tools Punchdown/Termination Tool **\$59.95**

Includes 110 IDC & 66-Clip Blades

PL13001 Extra 66-Clip Blade **\$14.95**

PL13002 Extra 110-Clip Blade **\$14.95**



CONNECTOR PRESSING TELCOM PLIERS

These quality pliers are designed to crimp UG, UR, UB and UY style connectors manufactured by 3M and others. Pliers are designed and manufactured in accordance with Bell Specifications. They feature a built-in side-cutter and coil spring, plus built-in stop.

PL12100 Connector Pressing Telcom Pliers **\$15.95**



SEALSMART II COMPRESSION TOOL

Easily terminate F, BNC and RCA connectors with a single tool – without switching adapters!

- Compact and lightweight design
- Universal head designed to work with all standard compression connectors available on the market – including right-angle and RGB mini
- Quickly and easily adjust crimp height
- Eliminates the need for separate adapters
- Fast and reliable terminations

PL16220C SealSmart II Compression Tool **\$29.95**

SealSmart Compression Connectors. See Page 55.

ON-Q/LEGRAND PUNCH & GO TOOL

Seat and terminate all wires at once with a squeeze of the handle.

- Consistent terminations.
- No more compromised connections or wasted jacks.

OQAC3400 On-Q/LeGrand Punch & Go Tool **\$34.95**

For use exclusively with Quick Connect connectors.



QUICK CONNECT CONNECTORS

- Colors: Choose Black, Brown, Blue, Grey, Ivory, Light Almond, Orange, Red & White.

OQWP3475x RJ45 Quick Connect Insert, Cat5e **\$3.45**

OQWP3476x RJ45 Quick Connect Insert, Cat6 **\$6.45**

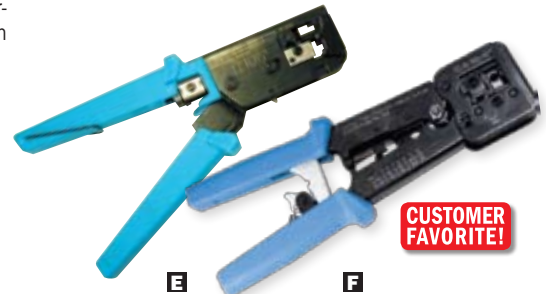

CUSTOMER FAVORITE!

EZ-RJ CRIMP TOOLS

These crimp tools are designed to quickly crimp and cut the wires of the EZ-RJ connector in one simple operation!

E **PL100004B** EZ-RJ45 Crimp Tool **\$64.95**

For use with EZ-RJ45 Cat5/5e & EZ-RJ45 Cat6 Connectors; Also works RJ-11, RJ-12 and RJ-45 connectors (Except AMP)

F **PL100054B** EZ-RJ Pro Crimp Tool **\$89.95**

For use with EZ-RJ45 Cat5E, EZ-RJ45 Shielded Cat5E, EZ-RJ45 Cat6 and EZ-RJ12/11 connectors; Also works on RJ-11, RJ-12 and RJ-45 connectors (Except AMP)

EZ-RJ CONNECTORS

PL100 EZ-RJ45 Connectors, Cat5/5e **\$34.95-\$64.95**

Available in 50 or 100 piece packs

PL100010x EZ-RJ45 Connectors, Cat6 **\$34.95-\$69.95**

Available in 50 or 100 piece packs

TEST EQUIPMENT

CABLE LOCATOR TONE-TEST SET

Amplifier Probe and Tone Generator helps locate, identify and trace cable-pairs, individual conductors and metallic wiring in electrical, CATV, data, phone and security cabling.

- Rugged High-Impact ABS Case
- Includes 9V batteries and nylon holster

ST602810 Cable Locator Tone-Test Set **\$99.95**

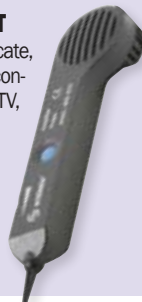

CABLE TESTER

Allows you to test wiring continuity for Cat5, Cat6, Phone and Coax cable assemblies. Identifies mis-wires, short circuits and open circuits. Features 2 piece transmitter and receiver, 2 BNC-F coax converters and coax terminator.

TPN044000R Cable Tester **\$44.95**

Includes 2-Piece Test Unit, 2 BNC/F Coax Adapters, 1 Coax Terminator & Case



SECO-LARM 6-IN-1 TESTER

Test for Voltage, Load, Polarity, Voltage Drop, PTC Fuse and Continuity.

SESTBT02Q 6-in-1 Tester **\$34.95**



RESIDENTIAL LABEL PRINTERS

RHINO 5200 PORTABLE LABEL PRINTER

Rugged, versatile and packed with time-saving features, the Rhino 5200 meets all ANSI and TIA/EIA-606-A labeling standards – and outperforms industrial labelers that cost twice as much. Just press a patented Rhino “hot key” to automatically size, space and format text for perfect patch panel labels – then press another to print matching cable flags or face plate tabs, without retyping! It’s just as easy to print module and fixed-length labels, horizontal and vertical wire wraps, terminal and 110 blocks and much more.

Print Code 39 and Code 128 barcodes. Access 100+ industry symbols, fractions and punctuation marks with a few quick keystrokes. Add the optional quick-charging lithium-ion battery for uninterrupted productivity.

DY1755749 Rhino 5200 Label Printer **\$169.95**



RHINO 6000 PORTABLE LABEL PRINTER

Bring the tough, portable Rhino 6000 to any job site – it’s packed with time-saving shortcuts for labeling any installation quickly and professionally.

Connect it to your PC, and use RHINO CONNECT software to create labels on your computer, and download them to your labeler for even faster labeling on site. Rhino 6000 meets all ANSI and TIA/EIA-606-A industry labeling standards.

Its patented, one-touch “hot keys” automatically format label text for electrical and patch panels, terminal and 110 blocks, wire and cable flags, horizontal and vertical wraps, vertical and fixed-length applications.

The Rhino 6000 also prints 6 bar code types, 250+ pre-programmed industry symbols and terms, and much more. Works with 32- and 64-bit Windows XP, Windows Vista and Windows 7.

DY1734519 Rhino 6000 Label Printer **\$279.95**



RHINO 4200 PORTABLE LABEL PRINTER

The DYMO Rhino 4200 gets labeling jobs done fast – and done right.

Easily navigate the familiar QWERTY keyboard. Use one-touch “Hot Key” shortcuts to quickly create and format wire/cable wraps, flags, Code 39 and Code 128 barcodes, fixed-length labels, breaker labels and more.

Print labels up to 3/4" wide in flexible nylon, permanent polyester and durable vinyl materials – PLUS print directly on heat-shrink tubes. Save even more time with great features – like the “Favorites” key which provides single-key access to commonly used labels, symbols and terms; and the “Custom” key which eliminates repeated steps by saving customized settings.

DY1801611 Rhino 4200 Label Printer **\$104.95**



RHINO REPLACEMENT LABELS

FLEXIBLE NYLON

DY18488 White Flexible Nylon Tape 1/2" **\$19.95**

DY18489 White Flexible Nylon Tape 3/4" **\$21.95**

DY18490 Yellow Flexible Nylon Tape 1/2" **\$19.95**

PERMANENT POLYESTER

DY18483 White Perm Poly Tape 1/2" **\$18.95**

HEAT SHRINK

DY18055 White Heat Shrink Tube 1/2" **\$44.95**

DY18053 White Heat Shrink Tube 3/8" **\$39.95**

DY18051 White Heat Shrink Tube 1/4" **\$39.95**

Complete line of Rhino Products » www.HomeControls.com

PHONE INSTALLATION

ETCON PHONE DISTRIBUTION DEVICE

- Accommodates up to 4 incoming phone lines and up to 48 Outlet cables or phone home runs
- Includes mounting screws and labels for organizing and wiring any phone system combination.

ETDD1 Eton Phone Distribution Device **\$39.95**

ET1C Eton Cover for ETDD1K **\$12.95**

ETDD3 Eton Phone Distribution Device with Standoffs **\$39.95**

ET3C Eton Cover for ETDD3 **\$12.95**

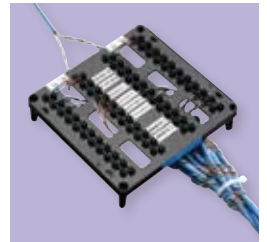

ETCON PHONE DISTRIBUTION DEVICE WITH 8-WAY SPLITTER

- Accommodates up to 4 lines and allows for up to 48 stations or phone home runs
- 8-Way 2Ghz splitter for CATV Cable runs
- Includes mounting screws and labels for organizing and wiring any phone system combination.

ETDD1X1 Eton Phone Distribution Device with 8-Way Splitter **\$54.95**

ETX1C Eton Cover for ETDD1X1 **\$11.95**

ETDD3X3 Eton Phone Distribution Device with 8-Way Splitter and Standoffs **\$59.95**

ETX3C Eton Cover for ETDD3X3 **\$11.95**

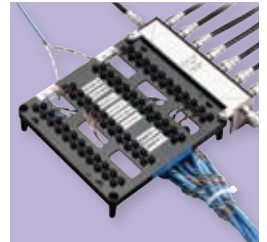

WWW.HOMECONTROLS.COM



BLOG

homecontrolsblog.com



FACEBOOK

Like our page!



TWITTER

@HomeControls

NuVo Audio Distribution Systems

GRAND CONCERTO 6-SOURCE, 8-ZONE SYSTEM

CUSTOMER FAVORITE!

NUVO GRAND CONCERTO

Experience ultimate sound. NuVo's Grand Concerto is an elegant, intelligent, whole-home audio system that combines unparalleled performance with the industry's most innovative technology – at an affordable price. With the Grand Concerto system, enjoying uninterrupted, pure, digital sound is a reality in your home.

Feel the power. Get a truly powerful audio experience with 80W per listening zone – enough to drive several speakers in one zone. Listen at loud or soft levels, and get crystal clear sound throughout your home. Our unique Generation D design protocol provides energy conservation, lower heat generation and higher power output.

Integrate seamlessly. Considered to be one of the most uncomplicated systems for integration and control, the Grand Concerto comes equipped for home automation. Because NuVo products are designed for compatibility, it's easy to incorporate your audio distribution system into a complete home automation installation with full connectivity and control.

Install with ease. Concerto's unique Ez Port connection hub neatly integrates the entire system while concealing all keypad wiring. When you compare the Grand Concerto with competitors' products – on performance and price – you'll quickly see and hear the difference NuVo makes.

- 6 audio source inputs for multi-source capability, and up to 8 zones of music
- 80W of power per zone
- Generation D design protocol with digital amplification – runs cooler, saves energy, outputs more power
- The Concerto has versatility in keypad selection. You can pair the Concerto with any mix of E6GCP Single



- gang OLED, I8GCP Double gang OLED, WCP Wireless OLED or CTP LED Color Touch Control Pads
- Flexible setup options: Source Grouping, Security, Volume Reset, Master Mode and much more

- 2 unpowered zones – for use with the NuVo Stereo Amplifier auxiliary satellite amplifier to power up to 6 speakers in a zone. Ideal for large living spaces or outdoor applications
- Built-in IR receiver for wireless control – designed to block adverse interference of plasma displays, sunlight or fluorescent lighting
- Fixed and variable line outputs – for use with high-power external amplifiers

NV18GMS NuVo Grand Concerto System \$Call

Includes Amplifier, 6 Control Pads (With White, Ivory, Almond & Black Wallplates), Remote Control, Ez Port, Network Cable, Power Cable, 6 IR Emitters & Rack Ear Mounts

NV18GZPKD2120 NuVo Grand Concerto Zone Pack \$Call

For Zones 7 & 8 – Includes the NuVo Amplifier (NVD2120) & a Grand Concerto Control Pad (NV18GCP)

NV18GXS NuVo Grand Concerto Expander System \$Call

Includes Amplifier, 6 Control Pads (With White, Ivory, Almond & Black Wallplates), Remote Control, Source Link, Digital Link Cable, Power Cable & Rack Ear Mounts

GRAND CONCERTO ACCESSORIES

NV18DLS Ez IR Learning Station & Software (required for programming) \$Call

NVLSI24 Passive Local Source Interrupt \$Call

INTEGRATE NUVO INTO AN HAI OMNI AUTOMATION SYSTEM

The advanced technology of a NuVo Audio Distribution Systems integrates seamlessly into your home when used in conjunction with HAI OmniPro II (page 26). Using an HAI OmniTouch touch screen, you can control On/Off, volume, muting, transports, audio source and many other functions for each audio zone. Additionally, you can create modes in your HAI OmniPro II to customize your music and home control experience.



ESSENTIA 6-SOURCE, 6-ZONE SYSTEM

NUVO ESSENTIA E6G

Essentia delivers the startlingly clear sound of NuVo from up to 6 different sources, and to 6 different listening zones in the house. It's diverse, expandable and surprisingly affordable. Essentia includes a stunning Control Pad interface, with OLED display providing full metadata feedback. Coplanar buttons provide a smooth, clean finish with the overall polycarbonate surface, making the entire Control Pad water-resistant.

Essentia's RS232 bi-directional control interface allows it to be controlled from most home automation systems – just one of the many features that makes Essentia an incredible value in today's home.

- 40W per zone for high-quality sound
- Allport connection hub consolidates all speaker and Control Pad connections into one connection hub
- Built-in IR receiver blocks adverse interference of plasma displays, sunlight or fluorescent lighting



NVE6GMSDC NuVo Essentia E6G System \$Call

Includes Amplifier, 6 Control Pads (With White, Ivory, Almond & Black Inserts & Trim Plates), Remote, Allport, Allport Cable, 2 Network Cables, Power Cable, 6 IR Emitters & Rack Ear Mounts

NVE6GXSDC NuVo Essentia E6G Expander System \$Call

Includes Amplifier, 6 Control Pads (With White, Ivory, Almond & Black Inserts & Trim Plates), Remote, Allport, Allport Cable, Network Cable, Power Cable, 6 RCA Stereo To Y Cables & Rack Ear Mounts

ESSENTIAE6GACCESSORIES

NV18DLS Ez IR Learning Station & Software (required for programming) \$Call

NVLSI24 Passive Local Source Interrupt \$Call

The NuVo Essentia E6G consumes less than 1W while in standby mode, making it a very eco-friendly as well as user-friendly system!





Control Concerto, Renovia or Essentia With the NuVo iPhone App »
www.HomeControls.com/iPhone-Entertainment-Apps

SIMPLESE D 4-SOURCE, 4-ZONE SYSTEM

NUVO SIMPLESE D

NuVo's Simplese D is an affordable and simple home sound system. With Simplese, homeowners enjoy clean, pure sound from 4 distinctive sound sources throughout the house – all at a price comparable to many single-source systems. Simplese gives you the flexibility to choose from 4 sounds sources. And you can experience sound in 4 different listening zones.

- 4-Source Inputs; 4-Zone outputs, 30W per zone



- Same Generation D digital amplification as the Grand Concerto and Essentia
- 56Khz and 38Khz IR outputs to be compatible with

- more source equipment
- Allport reduces the Cat5 cables and speaker wires for 4 zones to a single cable

NVA4SDC NuVo Simplese D \$Call

Includes Amplifier, 4 Keypads With White, Ivory & Almond Wallplates For Each, Remote Control & 4 IR Emitters

RETRO-FIT SOLUTION: RENOVIA 6-SOURCE, 8-ZONE POWERLINE SYSTEM

NUVO RENOVIA

NuVo's new retrofit solution is the ultimate in flexibility and audio freedom. Combining reliable technology with unprecedented simplicity, Renovia is a whole-home audio system that promises sophisticated sound incorporated almost invisibly into a home's architecture, without a disruptive installation.



NVRVM Renovia Six-Source Powerline Audio Distribution System \$Call

A NVRZA50S Renovia Zone Amplifier, In-Wall, 50W \$Call

B NVRZAF50S Renovia Zone Amplifier, Free-Standing, 50W \$Call

NVRVSAT Renovia Site Analysis Tool \$Call

NVRVIPD Renovia NuVoDock for iPod (see page 64) \$Call

COMPATIBLE WITH SEVERAL CONTROL OPTIONS (SEE PAGE 64 FOR DETAILS)

NVI8GCP NuVo I8G Control Pad \$Call

NVE6GCPDC NuVo E6G Control Pad \$Call

NVCTP36V2 NuVo Color Touch Pad \$Call

NVWCPS Wireless Control Pad Kit \$Call

Using the home's existing power lines to distribute audio to up to 8 zones (add a Zone Amplifier and Control Pad for zones 5-8), each Renovia system is comprised of a Source Hub and an unobtrusive in-wall Zone Amplifier for each intended zone. The Source Hub, complete with a built-in dual AM/FM/SIRIUS-Ready tuner, centralizes the system's six audio sources and can be easily stored out of sight. Manage the system from a variety of NuVo's attractive control options.



NUVO AUDIO AMPLIFIERS



NUVO DIGITAL POWER AMPLIFIER

The new Digital Power Amplifier delivers quality stereo amplification in a compact and high-efficiency package. Sounding off at 2 x 120 watts, this amp is first in a new generation of digital power amplifiers that offer a powerful and versatile answer to any installation's needs, even in large rooms and outdoor areas. Easily compatible with most third-party sources, the amp offers great flexibility without any sacrifice of performance.

- Perfect for large rooms, outdoor areas, or zones 7 and 8 in a Grand Concerto System
- 2 Channels at 120W
- Selectable speaker impedance of 4 or 8 ohms
- Light, single-rack unit design
- Multiple power On/Off triggers, including external voltage or audio signal
- Simple compatibility with third-party equipment

NVD2120 Digital Power Amplifier, 2x120W, Rack Mount \$Call

NVD460 Digital Power Amplifier, 4x60W, Rack Mount \$Call

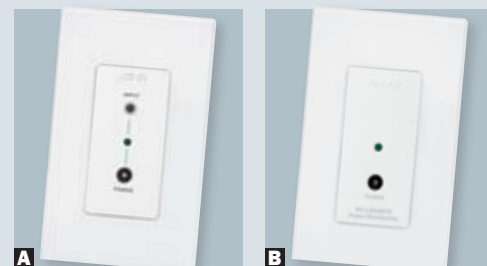

LOCAL SOURCE AMPLIFIER

A NVLSA40S Local Source Amplifier \$Call

Use With Local Power Supply

B NVLSA40 Local Source Amplifier \$Call

Use With The NuVo Power Distribution Hub

NUVO POWER DISTRIBUTION HUB

A single-gang power distribution hub designed to power up to 4 individual NuVo Local Source Amplifiers.

B NVLSA40PDS Power Hub \$Call

NuVo System Options

NUVO MUSIC SOURCE EQUIPMENT



NUVO MUSIC PORT

Consolidating networked computers' digital audio content from iTunes and Windows Media Player into a single, easily navigated library, the Music Port Server provides superior access to a home's music collection.

Additionally, the Music Port Server opens a system up to streaming audio from online sources like Pandora, Sirius and XM Internet Radio, plus more than 100,000 stations through RadioTime. Operation is simple through any of NuVo's control options, including a sleek client software interface.

NVMPS4 NuVo Music Port, Standard **\$Call**

NVMPS4E NuVo Music Port, Elite **\$Call**

Enhanced features like cloud synchronization, networked storage, and easy integration with automation systems.



Control Your NuVo Music Port With the NuVo iPhone App »

www.HomeControls.com/iPhone-Entertainment-Apps



NUVO SIRIUS SATELLITE TUNER

Radio enters the 21st Century with the revolutionary dual tuner from NuVo. Finally, you can enjoy advanced radio technology with whole-home distribution in one innovative tuner.

Exceptional technology delivers crystal clear recep-

tion and state-of-the-art sound, so you can enjoy your favorite broadcast programs on AM, FM, or SIRIUS satellite radio. No matter which option you choose, with reception this remarkable, the NuVo Tuner delivers a music experience that is out of this world.

NVT2SIR Dual Tuner (AM/FM & SIRIUS Satellite) **\$Call**

NVSCHE1 SiriusConnect Home Tuner Module **\$Call**

NVT2ANTDK Indoor/Outdoor SIRIUS Antenna for use with the NVT2SIR **\$Call**

Consuming less than 1W of power while in standby mode, the NuVo Tuner is yet another NuVo audio solution that saves energy!

CONTROL YOUR GRAND CONCERTO WITH YOUR IPOD!

WIRED NUVO DOCK

The Remote NuVo Dock for iPod is designed to communicate with the Grand Concerto System without any programming. Once the Remote NuVoDock and Grand Concerto System are installed, you will be able to place an iPod in the NuVoDock for communication with the Grand Concerto Control Pads. Now you can listen to your iPod collection from any zone in and around your home.

NVRIPS NuVoDock for iPod, Wired **\$Call**

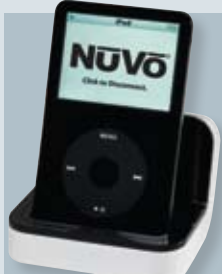

IN-WALL NUVO DOCK

NuVoDock for iPod is charting new territories - your walls.

The same great NuVoDock features of convenience and control, now available in an on-wall package.

Accessing a personal iPod through a NuVo system means guaranteeing you'll like what you hear, and the Wall-Mount NuVoDock offers this great functionality with a sleeker look than ever before.

NVWMIPSDC NuVoDock for iPod, In-Wall **\$Call**



NUVO CONTROL CHOICES

CONTROL PADS



COMPATIBLE WITH CONCERTO, ESSENTIA & RENOVIA

A NVI8GCP NuVo I8G Control Pad **\$Call**

COMPATIBLE WITH CONCERTO, ESSENTIA & RENOVIA

B NVE6GCPDC NuVo E6G Control Pad **\$Call**

COMPATIBLE WITH SIMPLESE

C NVA4DKPDC Simplese D Keypad **\$Call**

NVLR1 Learning Universal Remote **\$Call**



CUSTOMER FAVORITE!

COLOR TOUCH PAD

The new Color Touch Pad provides the most user-friendly full system control, from a sleek, easy-to-navigate touch screen. Now manage an entire house of music from one central location.

- 3.6" Full color display
- Source-specific control options
- IR pass through
- Zone to zone control
- 4 hard buttons for commonly used functions
- No programming necessary

COMPATIBLE WITH GRAND CONCERTO & RENOVIA

NVCTP36V2 NuVo Color Touch Pad **\$Call**

WIRELESS CONTROL PAD

NuVo's sleek Wireless Control Pad works with the Grand Concerto and Essentia E6G to provide all the same control and metadata as our on-wall Control Pads, but in a handheld, portable package. Choosing the zone you wish to control and full management of your audio sources are as simple as the touch of a button. The multi-line OLED display takes the guesswork out of your music listening experience.



COMPATIBLE WITH GRAND CONCERTO, ESSENTIA & RENOVIA

NVWCPS Wireless Control Pad Kit **\$Call**

Includes Wireless Control Pad, Coordinator, Charging Dock, Power Supply & Cat5 Cable

Hi-Fi 2 By HAI

8-SOURCE, 8-ZONE SYSTEM

HI-FI 2 BY HAI

The Hi-Fi 2 is HAI's all new distributed audio system. With double the zones, more than double the power, more sources, and an all new keypad with OLED display, the Hi-Fi 2 is reinvented for today's demanding homeowners.

Hi-Fi 2 plays music from devices you already own (or those you wish to purchase), and is so easy to operate that anyone can enjoy it. With Hi-Fi 2, you have the ability to listen to different sources at the same time at different volume levels throughout your home. Or set all zones to the same source and volume.

Audio sources can now be located throughout the house using Remote Input Modules, or locally inputted at the Hi-Fi 2 amplifier. Local input examples include items like HAI's Music Gateway and satellite/Internet radio tuners. Remote input examples include a home theater system, kitchen TV, iPod dock, etc.

- 50W per channel with 4 Ohm speakers
- 25W per channel with 8 Ohm speakers

HA95A001 Hi-Fi 2 8-Zone, 8-Source Kit in Enclosure **\$2169.95**

Includes Hi-Fi 2 In Enclosure, 8 Volume Source Controls & 4 Remote Input Modules

HA95A002 Hi-Fi 2 8-Zone 8-Source Kit for Structured Wiring Enclosures **\$2169.95**

Includes Hi-Fi 2 On Universal Mounting Plate, 8 Volume Source Controls & 4 Remote Input Modules

EXPANSION KITS

HA95A121 Hi-Fi 2 8-Zone, 8-Source Expansion Kit in Enclosure **\$2014.95**

HA95A122 Hi-Fi 2 8-Zone, 8-Source Expansion Kit for Structured Wiring Enclosures **\$2014.95**



HAI MUSIC GATEWAY

The HAI Music Gateway opens up your music collection to the rest of your home. A music server/renderer with 3 independent stereo channels, the Music Gateway uses an HAI IP OmniTouch Touchscreen for selecting music from anywhere in the house.



Selections can be made by artist, title, genre, or playlist. Album art and other meta-data can even be viewed. Where a Hi-Fi by HAI or other multi-room audio system is available, the Music Gateway can be fully integrated. Use existing playlists, or create new ones on the fly.

- Installs in a structured wiring enclosure.
- Includes HAI's WL3 software to allow remote access via Internet or mobile device such as an iPhone.

HA84A001 HAI Music Gateway **\$1549.95**

HAI DOCK

The HAI Dock allows you to access music on an iPod through IP-enabled devices over a wired or wireless network. When connected to a Hi-Fi 2 by HAI distributed audio system, the connected iPod or iPhone becomes a source that can be played in any audio zone connected to the Hi-Fi 2



HA96A00x HAI Music Gateway **\$429.95**

Available in Wired or Wireless



4-SOURCE- 4-ZONE SYSTEM

The new Hi-Fi 2 4x4 provides an affordable distributed audio option with 20W per channel that fits directly into a Leviton SMC wiring enclosure at half-width. As with the entire Hi-Fi 2 line, the new 4x4 model allows users to listen to and share music sources with any room that has speakers connected to the device.

HA95A003 Hi-Fi 2 4-Zone, 4-Source Controller **Coming Soon**

Encore DIGI-5 Audio Distribution

Linear

PROVIDING SUPERIOR AUDIO DISTRIBUTION AND SOUND QUALITY

DIGI-5 technology is a ground breaking, multi-source/multi-room music system providing superior audio distribution capabilities and sound quality.

- **Lossless, Cat5 Based Digital Audio Distribution:** DIGI-5 delivers audio content, loss-free, to each listening area by converting analog source signals into a high-quality 24-bit digital format and accepting native digital audio directly from source components.
- **High-Efficiency Digital Amplification:** Ultra-efficient amplifiers result in a dynamic sound that is bold, clean and detailed. They also allow for a compact size, enabling Keypad installation in a single-gang footprint.
- **Low Cost, Cat5-Based Multi-Room Installation:** DIGI-5 eliminates the need for specialty cables and long, heavy-gauge speaker wire runs, reducing overall wiring costs by as much as 65%.
- **Scalability:** The system is easily expanded up to 32 zones by adding Distribution Hubs and Keypads

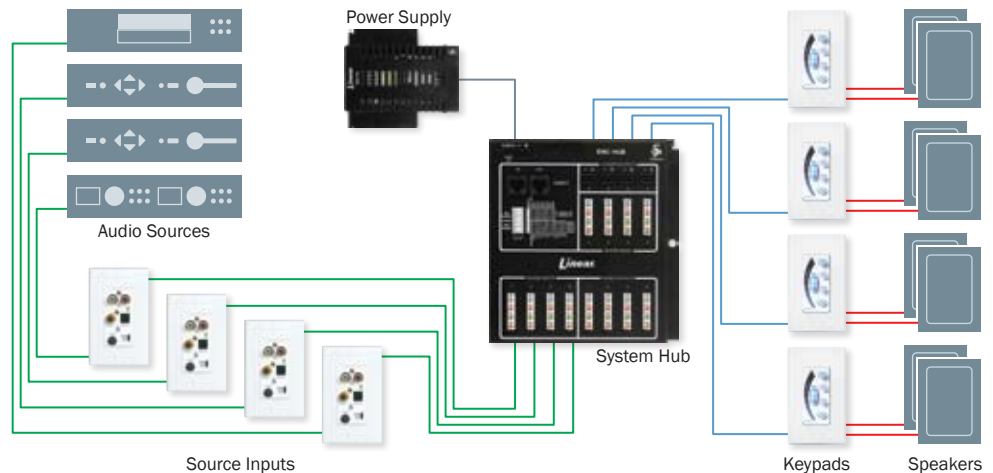

LNENCKITM Encore DIGI-5 Kit **\$1260.99**

Includes Audio Distribution System Hub, Power Supply, 4 Keypads, 4 Source Input Wallplates, 4 Single-Head IR Emitters, Standard Remote & Universal Mounting Bracket (Enclosure sold separately)

LNENCHUB Encore Audio Distribution Hub **\$296.99**

LNENCDRS Encore Keypad **\$179.99**

LNENCLIWP Local Input Wall Plate **\$61.99**

FREE PRODUCT ADVICE & SUPPORT » **800-266-8765**

65

On-Q Cat-5 Audio

legrand

ON-Q LYRIQ AUDIO DISTRIBUTION SYSTEM

ON-Q LYRIQ AUDIO SYSTEM

On-Q's multi-room audio system products integrate perfectly with any existing audio gear to deliver high-quality stereo sound. The Cat5 backbone provides amplification at the volume control in each room to provide power, fidelity and control to the speakers.

- Choose Studio Collection or Classic design



LYRIQ STUDIO DESIGN KITS

OQAU5644 LyriQ High Performance Multi-Source, 4-Zone Kit **\$1419.95**

4-Source 8-Zone Distribution Module, Flush Mount 3- & 1-Source Inputs, 4 Keypads, High Performance Power Distribution Modules, Dual IR Mouse Emitter, Universal Remote, Power Supply & Studio Design Wallplates (Kit in White Only)

OQAU5646 LyriQ High Performance Multi-Source, 6-Zone Kit **\$1949.95**

4-Source 8-Zone Distribution Module, Flush Mount 3- & 1-Source Inputs, 6 Keypads, 2 High Performance Power Distribution Modules, Dual IR Mouse Emitter, Universal Remote, Power Supply & Studio Design Wallplates (Kit in White Only)

LYRIQ CLASSIC DESIGN KITS

OQAU1006 LyriQ High Performance Multi-Source, 6-Zone Kit **\$1699.95**

4-Source 8-Zone Distribution Module, 3- & 1-Source Inputs, 6 Keypads, 2 High Performance Power Distribution Modules, Dual IR Mouse Emitter, Universal Remote, Power Supply & Wallplates (Kit in White or Light Almond only)

LYRIQ STUDIO DESIGN KEYPADS

- Colors: Choose White, Light Almond, Black or Titanium

OQAU5009 LyriQ Audio Control Keypad **\$179.95**

OQAU5010 LyriQ High Performance Audio Control Keypad **\$214.95**

OQAU5008 LyriQ Local Source Input **\$94.95**

LYRIQ COMPONENTS (Works With Classic & Studio Design Systems)

OQAU1002 4-Source, 8-Zone Distribution Module **\$244.95**

OQAU7396 1-Source, 4-Zone Distribution Module **\$109.95**

OQAU1022 LyriQ Zone Expander Module **\$129.95**

Expands an 8-Zone, Multi-Source System To 16 Zones

OQAU1001 LyriQ High Performance Keypad Power Distribution Module **\$59.95**

LYRIQ CLASSIC DESIGN KEYPADS

- Colors: Choose White, Light Almond, Ivory or Black

OQAU1000 LyriQ High Performance Audio Control Keypad **\$184.95**

OQF7399 LyriQ Audio Control Control Knob **\$109.95**

OQF7417 LyriQ Local Source Input **\$84.95**

OQAU7398 LyriQ 1-Source Input **\$129.95**

OQAU1004 Flush Mount 1-Source Input **\$129.95**
White, Black or Light Almond

OQAU1011 Flush Mount 3-Source Input **\$149.95**
White, Black or Light Almond

CONTROL LYRIQ WITH YOUR SMARTPHONE



LYRIQ AIRQAST

Designed for integration exclusively into LyriQ, airQast adds mobile device audio control and streaming to your home's LyriQ system. airQast technology and a free mobile app allow you to start using your mobile devices to select and play music, adjust volume levels, create playlists, and stream Internet radio services through your LyriQ system. Because the airQast mobile app accesses and controls music via Wi-Fi, it provides seamless, uninterrupted audio even during phone calls. Answer the phone, surf the web, even play games - all while enjoying your music.

- Control a LyriQ system with any mobile device
- Stream music from Pandora, YouTube, SiriusXM and Last.FM
- Free mobile app lets you access all your digital music with the flick of a finger

OQAU1015 LyriQ airQast **\$234.95**



NEW

ON-Q LYRIQ CHARGE & PLAY KIT

As a single-source input to the LyriQ Multi-Room Audio System, the Charge & Play Kit supports the charging of most tablets, smartphones, laptops, and digital music players via convenient USB port and the player manufacturer's cord. Left and right stereo inputs provide crystal clear sound to as many as four zones - just plug and play - while the included Universal Smart Cradle desktop stand securely holds any device connected to the system.

- Colors: Choose White or Light Almond

OQAU5015 LyriQ Charge & Play Kit **\$169.95**



On-Q high-efficiency amplifiers use half the energy of traditional amplifiers. They go into standby mode after 20 minutes of non-use, for additional savings!

NUVO PRESENTS BREATHE AUDIO

BREATHEAUDIO ELEVATE

BreatheAudio's 6-Source, 6-Zone Whole Home Audio System lets the music play with features that will amaze. The slick, clean styling of its keypad makes for an impressive interface for the consumer, while the Allport provides simple, straightforward installation. All at a price point that makes this system the best value.

NVBA6640M BreatheAudio Elevate System **\$1069.95**

Includes Amplifier, 6 Keypads, Allport Connection Hub with Cable, 6 IR Emitters, Network Cable, Rack Ear Mounts & Power Cable

- 6 audio sources are sent to 6 rooms.
- 40W of power per zone produce high-quality, full high-fidelity sound.
- Allport connection hub reduces installation time and features no fuss, behind-the-rack wiring.



HD RADIO, INTERNET STATIONS, SIRIUS, PANDORA & MORE!

GRACE DIGITAL WI-FI TUNER & INTERNET RADIO

If enjoying Wi-Fi Internet radio music on your home stereo is your pleasure, the Grace Tuner is for you. The Grace Wi-Fi Tuner provides digital audio directly from the internet to your home stereo. Listen to your personal music collection, over 35,000 internet radio stations, podcast and on demand Wi-Fi radio content or online music services like Pandora, Live365, and SIRIUS.

High Contrast LCD Display: The adjustable 4-line, backlit LCD display makes it easy to view your selections, adjust your audio settings or display song title and artist details.

Function Remote Control: With a full-function remote control you'll be able to choose 1 of your 10 preset stations, search for new stations, skip songs, and give feedback on Pandora from any location in your room.

Remote Control iPhone App/Remote Control iPhone App: The Grace Remote control



application allows you to go where no IR remote has gone before. Control 1 or more of your Grace Internet radios from your iPhone or iPod Touch. You can change the volume, turn it on or off, find stations and set presets or even set any one of your five alarms.

GDIRDT200 Grace Digital Wi-Fi Tuner & Internet Radio **\$234.95**

Wireless Audio

CHANNEL VISION

CHANNEL VISION WIRELESS AUDIO

The Wireless Audio Transmitter and Wireless Audio Receiver from Channel Vision make it possible to create a distributed audio system without running wires from one room to another. The transmitter can accept either line level or speaker level audio, making it easy to distribute signals to the rear speakers of a surround sound system.

- Wirelessly transmits audio up to 300'
- 8 transmission channels

1-TO-1 SYSTEM

A CVWA320 1-to-1 Wireless Transmitter **\$69.95**

B CVWA360 1-to-1 Wireless Receiver **\$59.95**

1-TO-MANY SYSTEM

A CVWA321 1-to-Many Wireless Transmitter **\$69.95**

B CVWA361 1-to-Many Wireless Receiver **\$59.95**

SYSTEM COMPONENTS

CVA0240 Cat5 Audio System Stereo Amplifier **\$134.95**

CVVC302 Volume Control With IR Knockout **\$34.95**

Includes White, Almond & Ivory Faceplates

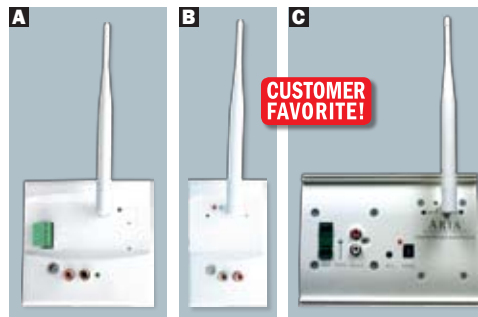

CHANNEL VISION AMPLIFIED WIRELESS AUDIO RECEIVER

The amplified wireless audio receivers work with the Channel Vision wireless transmitters. The integrated 100W amplifier is ideal for powering distributed audio speakers as well as wireless home theater applications.

C CVWA350 1-to-1 Amplified Wireless Receiver **\$194.95**

C CVWA351 1-to-Many Amplified Wireless Receiver **\$194.95**

1-to-1 System Connection To Rear Speakers

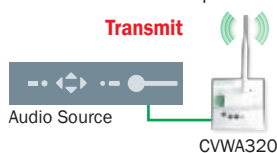

1-to-Many System Wireless Multi-Room Audio Distribution

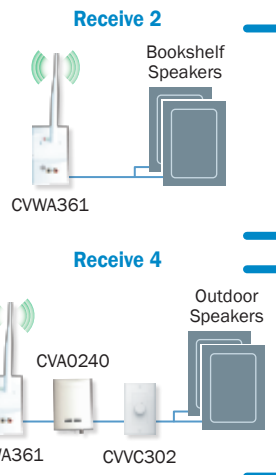
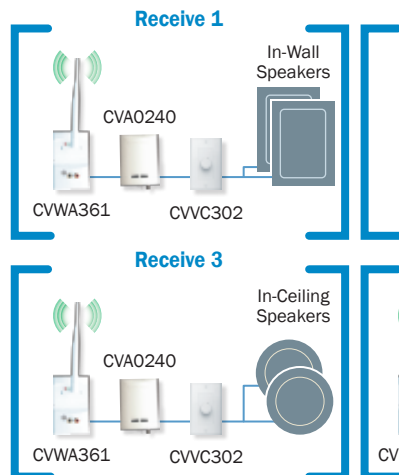
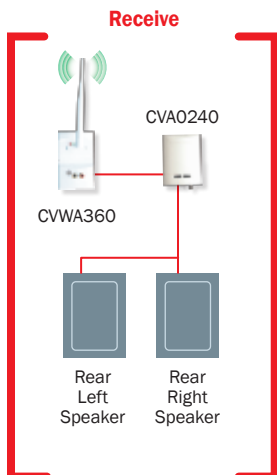
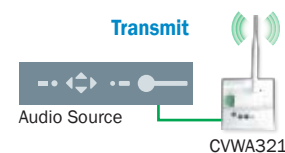

CHANNEL VISION iPad & IPOD DOCKING STATIONS

CHANNEL VISION IPAD WALL DOCK

The iPad Wall Dock allows you to securely mount your iPad to a wall, creating an elegant, touchscreen command center for home theater, whole-house automation, security and more. The iPad charges when docked, and can be easily removed, offering a completely portable controller. The dock is designed to display a photo when the iPad is gone, to help you maintain a finished appearance around the clock.

- iPad charges when docked
- Display a photo when iPad is removed
- Mounts vertically or horizontally to any wall
- Color: Choose from White or Black.

CVA0602x Channel Vision iPad Wall Dock **\$179.95**

CHANNEL VISION IPOD WALL DOCK

The Channel Vision Wall-Dock Station for iPod supports both RS-232 and IR control. The dock connector easily adjusts to fit any iPod and has a non skid pad to help keep the music player secure. With its elegant and contemporary styling, it fits into any home setting and provides the convenience of accessing an iPod from anywhere in the home.

- Supports IR control
- RS-232 interface for use with control systems
- Allows viewing of iPod videos on a TV
- Mounts in a standard 2-gang box

CVA0316 Channel Vision iPod Station **\$234.95**

OEM Systems Speaker Collection

ARCHITECH PREMIUM

GOOD: High quality in-wall speakers by OEM Systems feature Carbon Fiber cone woofers with 10 oz. magnets and 1" titanium tweeters. In-wall subwoofer features 8" Carbon Fiber woofer with a 25 oz. magnet, dual channel (stereo) high temperature voice coil and a built-in crossover network. Each speaker includes grilles, screws, cut-out templates and paint mask templates. All round speakers include the OEM Speaker Hole Compass for a perfect size mounting hole every time.

- Rigid captive clamp-ring mounting system
- Perforated metal grilles
- Lifetime Limited Warranty



ARCHITECH KEVLAR

BETTER: Kevlar strength helps the cone of the ArchiTech Kevlar speaker retain its shape at **ArchiTECH** very high energy levels, and its low mass ensures quick, accurate response. The cone's woven surface delivers smooth, uncolored mids. The kapton voice coil former and butyl rubber surround mean these woofers are designed for years of consistent, reliable audio enjoyment.

Phase Plug Technology: The phase plug pole piece extension improves driver performance and clarity.

Pivoting Textile Soft Dome Tweeters: Ferro Fluid lubricates and cools the voice coil enabling high power handling.

IR Receiver Knockouts: The 6 1/2" and 8" in-wall speakers feature a mounting provision for a remote control signal receiver behind the speaker grille.



Speaker Description	5.25" In-Wall	5.25" Ceiling	6.5" In-Wall	6.5" Ceiling	8" In-Wall	8" Ceiling	5.25" In-Wall	5.25" Ceiling	6.5" In-Wall	6.5" Ceiling	8" Ceiling	8" 3-Way In-Wall
Frequency Response	50Hz to 20kHz	50Hz to 20kHz	45Hz to 20kHz	45Hz to 20kHz	35Hz to 20kHz	35Hz to 20kHz	50Hz to 20kHz	50Hz to 20kHz	45Hz to 20kHz	45Hz to 20kHz	45Hz to 20kHz	35Hz to 20kHz
Power Handling	60W max 30W nom	60W max 30W nom	80W max 40W nom	80W max 40W nom	100W max 50W nom	100W max 50W nom	60W max 30W nom	60W max 30W nom	80W max 40W nom	80W max 40W nom	100W max 50W nom	100W max 50W nom
Sensitivity	91dB	91dB	91dB	91dB	91dB	91dB	91dB	91dB	91dB	91dB	91dB	91dB
Impedance	8 Ohms nominal	8 Ohms nominal	8 Ohms nominal	8 Ohms nominal	8 Ohms nominal	8 Ohms nominal	8 Ohms nominal	8 Ohms nominal	8 Ohms nominal	8 Ohms nominal	8 Ohms nominal	8 Ohms nominal
Overall Size	6 5/8"W 9 1/4"H	7 1/2" Round	8 5/8"W 12 1/8"H	8 3/8" Round	10 1/2"W 14 1/2"H	9 3/4" Round	6 5/8"W 9 1/4"H	7 1/2" Round	8 5/8"W 12 1/8"H	8 3/8" Round	9 3/4" Round	10 1/2"W 14 1/2"H
Cutout Size	5 9/16"W 8 3/4"H	6 1/2" Round	7 3/8"W 10 7/8"H	7 3/8" Round	9"W 13"H	8 5/8" Round	5 9/16"W 8 3/4"H	6 1/2" Round	7 3/4"W 10 7/8"H	7 3/8" Round	8 5/8" Round	9"W 13"H
Sold As	Pair	Pair	Pair	Pair	Pair	Pair	Pair	Pair	Pair	Pair	Pair	Pair
Model#	OESE691E	OESC502E	OESE791E	OESC602E	OESE891E	OESC802E	OESE694KE	OESC520KE	OESE790KE	OESC620KE	OESC820KE	OESE893KE
Price	\$84.95	\$89.95	\$129.95	\$99.95	\$159.95	\$169.95	\$124.95	\$124.95	\$159.95	\$149.95	\$199.95	\$254.95
Installation Bracket	OERI6914 \$34.95	OERIR5 \$23.95	OERIR7 \$34.95	OERIR6 \$23.95	OERIB82 \$23.95	OERIR8 \$23.95	OERI6914 \$34.95	OERIR5 \$23.95	OERIR7 \$34.95	OERIR6 \$23.95	OERIR8 \$23.95	OERIB82 \$23.95



FREE CUSTOM STOCKING FOR HOME CONTROLS DEALERS
We'll Stock Your Favorite Products! Call Bob at 1-800-266-8765 x107

IN-WALL SPEAKERS INSTALLATION

Topics include: What you need to do the job; Where to put your speakers; Painting your speakers; Cutting holes for the speakers; Running connecting wires; Hooking up your speakers; Final assembly; A short test drive; Quick Troubleshooting guide; Installing In-Wall speakers during new construction; plus many additional topics. 24 pages.

HCBOOK7 In-Wall Speaker Installation Manual **\$4.95**



ARCHITECH KEVLAR SPECIALTY SPEAKERS

- Black Kevlar woofer with butyl surround
- Dual (L+R) 3/4" dome tweeter
- Sensitivity: 91dB
- 8 Ohms



OESC622K Kevlar Ceiling Speaker, Single-Point Stereo, 6 1/2" (each) **\$79.95**
OERIR6 Installation Bracket **\$23.95**

OESC822K Kevlar Ceiling Speaker, Single-Point Stereo, 8" (each) **\$99.95**
OERIR8 Installation Bracket **\$23.95**

OESELCRKE Kevlar LCR In-Wall Speaker, 5 1/4" (each) **\$89.95**
OERIBLCR Installation Bracket **\$12.95**

All OEM Speakers include white metal grilles (paintable)

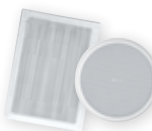

PRESENCE

PREMIUM: Practical engineering and the best materials available are present throughout the Presence line – namely Kevlar woven fiber woofers with butyl rubber surrounds and ferro fluid cooled Silk dome tweeter and midrange drivers, thick fiberglass crossover network PC boards populated with high-grade electronic components, over-drive tweeter protection, heavy gauge oxygen-free copper wiring and stout gold plated high tension connection terminals. The In-Wall speakers utilize Phase Plug technology designed to keep the midrange clean and minimize critical phase disturbances at the center of the mid-woofer driver. The Ceiling speakers utilize Pole-Mounted pivoting (lens-less) dome tweeters.

Presence

Complete Details » www.HomeControls.com/OEMPresenceSpeakers



5.25" In-Wall	5.25" Ceiling	6.5" In-Wall	6.5" Ceiling	8" In-Wall	8" Ceiling
50Hz to 20kHz	50Hz to 20kHz	45Hz to 20kHz	45Hz to 20kHz	35Hz to 20kHz	35Hz to 20kHz
80W max 40W nom	80W max 40W nom	100W max 50W nom	100W max 50W nom	120W max 60W nom	120W max 60W nom
91dB	91dB	91dB	91dB	91dB	91dB
8 Ohms nominal	8 Ohms nominal	8 Ohms nominal	8 Ohms nominal	8 Ohms nominal	8 Ohms nominal
6 ³ / ₄ "W 9 ³ / ₈ "H	7 ¹ / ₂ " Round	9 ¹ / ₁₆ "W 12 ³ / ₄ "H	8 ³ / ₈ " Round	10 ¹ / ₂ "W 14 ¹ / ₂ "H	9 ³ / ₄ " Round
5 ¹ / ₂ "W 8 ³ / ₁₆ "H	6 ¹ / ₂ " Round	8"W 11 ³ / ₄ "H	7 ³ / ₈ " Round	9"W 13"H	8 ⁵ / ₈ " Round
Pair	Pair	Pair	Pair	Pair	Pair
OEA525	OEA505	OEA650	OEA606	OEA820	OEA808
\$269.95	\$244.95	\$344.95	\$299.95	\$489.95	\$419.95
OER16914 \$34.95	OERIR5 \$23.95	OERIB62 \$23.95	OERIR6 \$23.95	OERIB82 \$23.95	OERIR8 \$23.95

PRESENCE SPECIALTY SPEAKER

In-Wall loudspeakers utilize Phase Plug technology designed to keep the midrange clean and minimize critical phase disturbances at the center of the mid-woofer driver. The pivoting dome midrange and tweeter drivers of woven (textile) silk are very open and transparent sounding. Due to their excellent design and costly manufacture they do not require troublesome diffraction contributing lenses.

- Frequency Response: 35Hz-20kHz
- Power Handling: 60 watts nom. 120 max
- Sensitivity: 91dB 1W / 1 meter

OEA830 Presence In-Ceiling Speaker, 8", 3-Way **\$534.95**

OERIB82 Installation Bracket **\$23.95**



PREFERENCE

BEST: Featuring the very finest driver materials, crossover and baffle designs. The Preference Accurate Imaging Baffles (AIB) utilize a ribbed design, which contributes strength and rigidity factors to the baffle, thereby simultaneously eliminating baffle flexure and early reflections from the drivers. Baffle mounted Midrange and High Frequency level switches provide tonal adjustments to compensate for sonic differences due to room acoustics and varying loudspeaker locations.

Preference

- Kevlar long throw woofer cones with butyl rubber surrounds
- Kapton voice coil formers
- Phase plug pole piece extensions
- Teteron soft dome pivoting tweeters
- High-grade crossovers
- Polyswitch overdrive protection
- IR knockouts on In-Wall Speakers

Complete Details » www.HomeControls.com/OEMPreferenceSpeakers



6.5" In-Wall	6.5" Ceiling	6.5" Ceiling Stereo	8" In-Wall	8" Ceiling	8" Ceiling Stereo	5.25" In-Wall LCR
42Hz to 21kHz	42Hz to 21kHz	42Hz to 21kHz	35Hz to 21kHz	35Hz to 21kHz	35Hz to 21kHz	45Hz to 21kHz
100W max 50W nom	100W max 50W nom	100W max 50W nom	120W max 60W nom	120W max 60W nom	120W max 60W nom	100W max 50W nom
90dB	90dB	90dB	91dB	91dB	91dB	90dB
8 Ohms nominal	8 Ohms nominal	8 Ohms nominal	8 Ohms nominal	8 Ohms nominal	8 Ohms nominal	8 Ohms nominal
9 ¹ / ₁₆ "W 12 ³ / ₄ "H	8 ³ / ₈ " Round	8 ³ / ₈ " Round	10 ¹ / ₂ "W 14 ¹ / ₂ "H	9 ³ / ₄ " Round	9 ³ / ₄ " Round	9"W 15 ³ / ₄ "H
8"W 11 ³ / ₄ "H	7 ³ / ₈ " Round	7 ³ / ₈ " Round	9"W 13"H	8 ⁵ / ₈ " Round	8 ⁵ / ₈ " Round	7 ⁷ / ₈ "W 14 ⁷ / ₁₆ "H
Pair	Pair	Each	Pair	Pair	Each	Each
OEK602	OEK625	OEK62	OEK802	OEK825	OEK82	OEK5LCR
\$519.95	\$399.95	\$249.95	\$649.95	\$519.95	\$299.95	\$274.95
OERIB62 \$23.95	OERIR6 \$23.95	OERIR6 \$23.95	OERIB82 \$23.95	OERIR8 \$23.95	OERIR8 \$23.95	OERIBLCR \$12.95

PREFERENCE SPECIALTY SPEAKERS

- 15° angled baffles enhance cinematic sound when layouts dictate ceiling mounted speakers
- Wide mouth baffle surfaces are covered with Anti-Diffractional foam for very open and uninterrupted sound
- Teteron soft dome pivoting tweeters
- Kevlar woofers with butyl surrounds
- Mid and high frequency EQ switches
- Polyswitch overdrive protection

OEK6LCRS Preference 15° Tilt Down 2-Way Speaker, 6¹/₂" (each) **\$279.95**

OERK615 Installation Bracket **\$12.95**

OEK8LCRS Preference 15° Tilt Down 2-Way Speaker, 8" (each) **\$334.95**

OERK815 Installation Bracket **\$12.95**



On-Q evōQ Speakers

legrand

3000 SERIES

GOOD: The evōQ 3000 Speakers provide efficient whole-house music distribution with exceptional sound. These inexpensive, high-efficiency speakers with low distortion provide a crisp, clear sound to get the most out of your equipment's power.



5000 SERIES

BETTER: Created specifically for surround sound theater applications, the evōQ 5000 Series Speakers deliver high-quality sound at higher power ratings. They are also an excellent choice for multi-room distributed audio installations.



7000 SERIES

BEST: For those who demand premium audio, the evōQ 7000 Series Speakers are the perfect solution. These top-of-the-line speakers from On-Q are the ultimate in quality and sound for home theater and distributed audio needs.



Speaker Description	6.5" In-Wall	6.5" Ceiling	8" In-Wall	8" Ceiling	6.5" Ceiling	8" In-Wall	8" Ceiling	6.5" In-Wall	6.5" Ceiling	8" In-Wall	8" Ceiling
Frequency	60-20K	60-20K	50-20K	50-20K	60-20K	50-20K	50-20K	55-20K	55-20K	45-20K	45-20K
Power (RMS)	50W	50W	75W	75W	75W	100W	100W	100W	100W	120W	120W
Efficiency	91dB	91dB	91dB	91dB	90dB	90dB	90dB	89dB	89dB	89dB	89dB
Overall Size	9.02"W 12.31"H	9" Round	10"W 12.75"H	10.9" Round	9" Round	10"W 12.75"H	10.9" Round	9.02"W 12.31"H	9" Round	10"W 12.75"H	10.9" Round
Cutout Size	7.5"W 10.75"H	7.75" Round	8.75"W 12.75"H	9.5" Round	7.75" Round	8.75"W 12.75"H	9.5" Round	7.5"W 10.75"H	7.75" Round	8.75"W 12.75"H	9.5" Round
Sold As	Pair	Pair	Pair	Pair	Each	Each	Each	Each	Each	Each	Each
Model#	OQMS3651	OQMS3650	OQMS3801	OQMS3800	OQHT5650	OQHT5801	OQHT5800	OQHT7651	OQHT7650	OQHT7801	OQHT7800
Price	\$164.95	\$104.95	\$199.95	\$174.95	\$94.95	\$134.95	\$99.95	\$139.95	\$114.95	\$164.95	\$144.95

SPECIALTY SPEAKERS

OQMS3652 6½" Ceiling Stereo (each) **\$99.95**



SPECIALTY SPEAKERS

OQHT5104 10" 150W Amplified Speaker, SubWoofer (each) **\$334.95**



SPECIALTY SPEAKERS

OQHT7652 6½" Ceiling Stereo (each) **\$174.95**

EVOQ ANGLED CEILING SPEAKERS

OQHT5655 5000 Series 6½" Angled Ceiling Speakers **\$84.95**

OQHT7655 7000 Series 6½" Angled Ceiling Speakers **\$139.95**



EVOQ CENTER CHANNEL SPEAKERS

OQHT5157 5000 Series Center Channel Speaker **\$104.95**

OQHT7157 7000 Series Center Channel Speaker **\$144.95**



FREESTANDING SUBWOOFER

FREE-STANDING POWERED SUBWOOFER

The P-1200 subwoofer features a 12" extra-long excursion woofer with high BL motor. The woofer is driven with an integral 300W class A/B amplifier utilizing the patented BASH technology for high electrical efficiency. The integral low pass crossover network is continuously variable from 40Hz to 120Hz.

Incorporates a defeatable signal-sensing circuit that automatically powers up when a signal is detected.

• Size: 15¾"W x 17½"H x 14¾"D (without feet)

OEP1200 Freestanding Powered Subwoofer **\$559.95**



IN-WALL SUBWOOFER

STUDWOOFER

This StudWoofer is a 10" in-wall subwoofer designed to be installed in standard 2" x 4" and 2" x 6" walls with drywall as thin as ½" without any need for reinforcement. It fastens directly to 16" on-center studs and will not work itself loose from the drywall.

- Frequency response: 25 to 200Hz
- Power Handling: 150W max; 8 Ohms nominal
- Cut-out Size: 14 ½"W x 16 ½"H x 3 ¾"D
- Size: 19 ½" x 19 ½", 1¾" face relief

OESE10SW StudWoofer, Single Voice Coil **\$249.95**



IN-CEILING SUBWOOFER

IN-CEILING SUBWOOFER

Designed to mount directly to wooden frames. The mounting bracket also serves as a pre-construction drywall cut-out template. Structural mount integrates system with framing of structure for excellent rigidity and therefore high-performance bass propagation.

- 10" Speaker
- Infinite baffle design
- Power Handling: 150W-250W max.; 8 ohm nom.

OEC10SW In-Ceiling SubWoofer **\$134.95**

OEMBC10 Installation Bracket (required) **\$69.95**

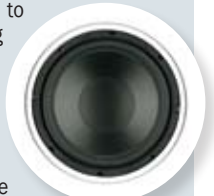

OUTDOOR SOUND!

ENDEAVOR OUTDOOR SPEAKERS

Choose from 5¼", 6½" and 8" 2-Way acoustic suspension indoor/outdoor speaker, sealed, port-less design enclosure prevents bugs and moisture from entering the cabinet.



- Grilles are epoxy paint coated, acid bathed and passivated austenitic stainless steel
- The 505, 605, 805 have Kevlar woofers and the 510 is a Poly woofer
- Colors: Choose White or Black

With versatile U-type mounting bracket, and mounting bosses on rear for double-swivel mounting brackets:

- OEI0510** Endeavor 5¼" Speakers (pair) **\$319.95**
- OEI0605** Endeavor 6½" Speakers (pair) **\$495.95**
- OEI0805** Endeavor 8" Speakers (pair) **\$629.95**
- OEI0505** Endeavor 5¼" Speakers (pair) **\$395.95**



ON-Q EVOQ OUTDOOR SPEAKERS

Weather-resistant and sealed to keep moisture out, evQ Outdoor Speakers feature durable plastic casing and bolt easily to a roof or deck. Because of their high power handling and adjustment capabilities, they guarantee the ultimate in outdoor sound.

- Colors: Choose from White or Black pairs

- OQMS3523** Outdoor Speakers, 3000 series **\$114.95**
- OQHT7653** Outdoor Speakers, 7000 series **\$249.95**

IN-WALL SPEAKER

This 6½" 2-Way speaker is designed for outdoor use. Built to weather the elements with a 1" Weatherized Titanium Dome Tweeter, rustproof aluminum grille and stainless steel hardware.

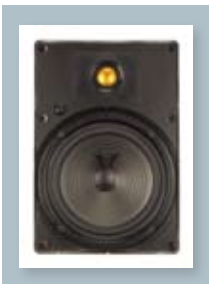

- OEA700** In-Wall Outdoor Speaker **\$174.95**

SOUND TERRAIN STEREO SPEAKER

Fully weatherproof, rugged ABS enclosure blends into any landscape scene. Provides 360° Single-Point stereo sound utilizing an 8" dual voice coil woofer and 4 piezo tweeters (2 per channel).



- Colors: Choose Green or Sand

- OESS84** SoundTerrain In-Ground Single-Point Stereo Speaker (each) **\$174.95**
- OESS8M** SoundTerrain In-Ground Mono Speaker **\$129.95** (set to left or right channel)

JBL Speakers

LEVITON/JBL ARCHITECTURAL EDITION

Leviton and JBL have partnered together to create the Leviton Architectural Edition powered by JBL program, which consists of a complete line of installed multi-room music, outdoor and home theater entertainment systems.

The Leviton/JBL multi-room Speakers feature Elliptical Oblate Spheroidal (EOS) Waveguide technology for improved high-frequency dispersion throughout a listening area. Titanium-laminate drivers ensure musical accuracy and clarity. The outdoor speakers have the same quality as their indoor counterparts but are engineered to withstand long-term exposure to the elements.



- LVAEI65** JBL In-Wall Speaker, 6½" (pair) **\$169.95**
- LVAEI80** JBL In-Wall Speaker, 8" (pair) **\$224.95**
- LVAEC65** JBL Ceiling Speaker, 6½" (pair) **\$139.95**
- LVAEC80** JBL Ceiling Speaker, 8" (pair) **\$204.95**
- LVAEM65** JBL Ceiling Stereo Speaker, 6½" (each) **\$109.95**
- LVAEN24** JBL Outdoor Speaker, 2-Way (pair) **\$149.95**
- LVAECCSVCE** JBL Dual 5" Woofer Shelf-Mount Center Channel Speaker **\$144.95**
- LVAEI55** JBL Dual 5" Woofer **\$214.95**
- LVAESUB12** JBL Powered 12" SubWoofer **\$384.95**

LEVITON/JBL 5.1 CHANNEL HOME THEATER SPEAKER SYSTEM

An extremely versatile performer, the Leviton/JBL 5.1 Channel Home Theater Speaker System is ideal for use in any application where an in-wall/in-ceiling installed home theater speaker solution is impractical but full performance is desired. The satellites can be mounted on walls or ceilings to open up as much living space as possible. Video magnetic shielding means that the satellites can be located right next to a TV screen without causing any problems.

- Colors: Choose Black or White



CUSTOMER FAVORITE!

- LVAEH50** JBL Surround Sound Speaker System **\$689.95**
- LVAESS5** JBL Extra Surround Sound Speaker **\$44.95**

STEREO SOUND FROM ONE SPEAKER!

ONE-POINT STEREO SPEAKERS

• Weatherized for high moisture/outdoor use. Ideal for bathroom and patio use. Both 6" and 8" speakers feature dual voice coil, dual spider, kevlar woofer with butyl rubber surround, 2 channels (left and right) ¾" Polycarbonate Dome Tweeters, 6dB per octave crossovers, powder coated stainless steel grill, stainless steel hardware, anti-corrosive coating on magnet and cam-nut type mounting system.

- OESC622K** One-Point Stereo Ceiling Speaker, 6" (Each) **\$79.95**
- OERIR6** Installation Bracket **\$23.95**
- OESC822K** One-Point Stereo Ceiling Speaker, 8" (Each) **\$99.95**
- OERIR8** Installation Bracket **\$23.95**



LCRS IN-WALL SPEAKERS

- Dual 5¼" 2-Way
- May be oriented vertically or horizontally
- Designed for use in left, center, right and surround loudspeaker positions of home theater systems

- OEK5LCR** Preference LCRS Speaker **\$274.95**
- OEALCRS** Presence LCRS Speaker **\$209.95**
- OESELCRKE** ArchiTech Kevlar LCRS Speaker **\$89.95**



LCRS CABINET SPEAKER

The cabinet LCRS speaker has been optimized for high fidelity home theater applications, primarily as a center speaker. It will function equally well when used for left and right front/surround. The broad dispersion design does not limit the sweet spot to just one seat in the center of the room but provides a large sound field from which to enjoy music and video soundtracks.

- OEA525CC** Presence LCRS Cabinet Speaker **\$224.95**



Volume Controls

BUFFALO VOLUME CONTROLS

BUFFALO ELECTRONICS VOLUME CONTROLS

The VC-5S is an easy to use, impedance protection volume control with the option to jumper out the impedance protection when it is not needed. The VC-5S works equally well in either mode but has the added responsibility of paying attention to the controlling jumpers.

If you want to drive a single listening zone with its own amplifier this is the volume control for you. Without the protective circuit the volume level increases allowing a lower power, less expensive amplifier to be used..

- Selectable mode: Automatic impedance protection mode or No protection mode
- Automatically protect amplifier from overload for multi listening zones or No protection for increased volume levels with separate listening zone amplifiers
- 50Wrms rating: Handles 150 watts of music power
- Frequency response: 35 Hz - 40 kHz, + 0 dB - 2 dB
- Low volume 1.5 dB level adjustments for superior room control
- Smooth, soft detent 11 position switch, 10 volume levels + off position
- Colors: Choose White, Light Almond or Ivory

BEVC5S Stereo Auto Impedance In Wall Volume Control (up to 12 Gauge Wire) **\$39.95**

PRO-WIRE VOLUME CONTROLS

PRO-WIRE VOLUME CONTROLS

Perfect for balancing the volume when 1 amplifier is driving speakers in several rooms. They are heavy duty Auto Former type controls, rated 35W, 50W, 80W and 100W RMS per channel. They have 10 indent positions with continuous music output and true Off position. Will fit J-box without modification. Installation is barewire, 14 gauge or smaller, via set screw terminals.

- Wallplate included
- Colors: Choose White, Ivory or Almond

OEIW100WV In-Wall Volume Control, 100W **\$34.95**

OEIWIMP100WV Impedance Matching In-Wall Volume Control **\$39.95**

PRO-WIRE SLIDER VOLUME CONTROLS

- 12 position autoformer
- Smooth transition between steps
- 12-tap, high-grade 100-watt autoformer
- Wallplate included
- Colors: Choose White, Ivory or Almond

OEEXL100 Slider Volume Control **\$39.95**

OEVX100 Impedance Matching Slider Volume Control **\$39.95**

Detailed Product Specifications » www.HomeControls.com/VolumeControls



SPEAKER SWITCHERS

- Maintain minimum 8 Ohm load
- Amplifier protection against impedance loads
- Great barrier termination strip construction
- 4-Speaker Size: 8 1/2"W x 2"H x 5 1/4"D
- 8-Speaker Size: 17"W x 2"H x 5 1/4" D

OESW4SPKR 4-Pair Switcher, 100W RMS/channel **\$84.95**

OESW8SPKR 8-Pair Switcher, 125WRMS/channel **\$129.95**

AVAILABLE COLORS
For Products On This Page



BUFFALO
electronics



CUSTOMER FAVORITE!

Pro-WIRE



PRO-WIRE OUTDOOR VOLUME CONTROLS

- Knob design
- Wallplate included
- Color: Grey

OEAW100WV Heavy-Duty Outdoor Volume Control **\$59.95**

OEAWIMP100WV Heavy-Duty Impedance Matching Outdoor Volume Control **\$64.95**

OEAWIMP100WVB Heavy-Duty Impedance Matching Outdoor Volume Control (with Box) **\$69.95**



SPEAKER SWITCHES

This Switch can be used to switch between 2 sources through 1 pair of speakers or to switch between 2 speakers with 1 source.

- Wallplate not included (see page 59)
- Colors: Choose White, Ivory or Almond

OEIW101 A or B Speaker Wall Switch **\$19.95**

OEIW303 A or B or A+B Speaker Wall Switch **\$44.95**

SPEAKER INSTALLATION

BOX BUDDY MUD RING

The MR1 is a speaker locator and mud ring. When used as a speaker locator, fastened to a truss, ceiling joist or wall stud (member), it should be positioned such that the score is aligned with the edge of the member so it may be easily snapped off when a speaker is to be mounted. After the sheetrock, the small opening is covered by the OEMRCVR.



OEMR1 Mud Ring, 1 Gang **\$2.25**

OEMRCVR Mud Ring Cover Plate **\$1.75**

IN-WALL SPEAKER PROTECTION

- Patented design protects from moisture and dirt
- Maintains vapor barrier integrity to meet building codes
- TonerCoil insert (included) allows zig zag wire leads at front edge without stapling for strong toner signals on retrofit applications
- 3 1/2" fits large-magnet speakers



PPBBX1 BackBoxx **\$9.95**

PPBB24166 BackBoxx Kit **\$54.95**

Includes 6 boxes, 1 BackBoxx Jr & 6 Toner Coils

CEILING SPEAKER PROTECTION

A pop-up nylon cover protects ceiling speakers against abrasive insulation fibers and dust particles. A must for all ceiling speaker installations!



OEISF147 Insu-Flate **\$5.15**



VAPOR DOMES

Pre-Construction Speaker Brackets with Vapor Domes are combination 3-in-1 devices: Rough-In Kit, Vapor Dome, and Back Box.

- Compatible with ArchiTech, Presence and Preference speakers.

OEVPD5 Vapor Dome, 5 1/4" Round Speakers **\$24.95**
For OEA505, OESC502E & SC520KE

OEVPD6 Vapor Dome, 6 1/2" Round Speakers **\$34.95**
For OEK625, OEK62, OEA606, OEASP6, OESC602E, OESC620KE & OESC622K

OEVPD8 Vapor Dome, 8" Round Speakers **\$34.95**
For OEK825, OEK82, OEA808, OEASP8, OESC820KE & OESC822K

OEVPD82 Vapor Dome, 8" In-Wall Speakers **\$34.95**
For OEK802, OEA820, OEA830, OESE891E, OESE892KE & OESE893KE

HDMI Distribution

HDMI OVER CAT5E

The TruLink HDMI over Cat5e Extender is a robust solution that allows you to extend your HDMI signal up to 200' over 2 Cat5 Unshielded Twisted Pair cables. This solution is ideal for applications where your HDMI monitor needs to be placed further than the average HDMI cable limitation. Driving a HDMI signal over Cat5 allows you to take advantage of your existing cable infrastructure for a cost-effective and reliable installation.

- Cat5 UTP cabling enables easy and cost effective in-wall installation
- Ideal for digital signage applications in retail stores, houses of worship, classrooms, and boardrooms
- Supports HDCP
- Video Bandwidth: 2.25 Gbps (HDMI 1.3)
- HDMI v1.3 with Deep Color, x.v. color, high speed refresh rates, and lossless multi-channel surround sound

CG40477 C2G TruLink HDMI Over Cat5e **\$169.95**



OMNI HDMI EXTENDER

The Omni-HDMI Extender incorporates every current HDMI feature, including 1.4a-exclusives like 3-D, 10/100T Ethernet Channel (HEC), Audio Return Channel, and 4K x 2K support. In addition, this HDMI Extender offers features not available elsewhere, including a built in 3-way Ethernet Switch, fully active (9-pin) RS-232 control, multiple IR brand compatibility, TOSLINK audio output, and one power supply for ease of installation.

- Only One Single UTP (Cat5e/Cat6) Cable necessary.
- Powered via one 24V Power Supply (included).
- Audio Return Channel (ARC) backwards compatibility via TOSLINK Digital Audio Output.
- Full Function RS-232 Control Extension
- Diagnostic Indicator Lights for monitoring performance and operation
- Highest Quality Extruded Aluminum case for cooling, shielding, and safety.
- IR Bi-Directional Pass-Thru with Power Option.
- Built-In 3-Port Ethernet Switch at each end.
- Solid Performance at 330' at 1080p with all functions.
- Fully Automatic Cable length compensation. No Dials or Switches needed.

TEHD1 Omni HDMI Extender **\$626.95**

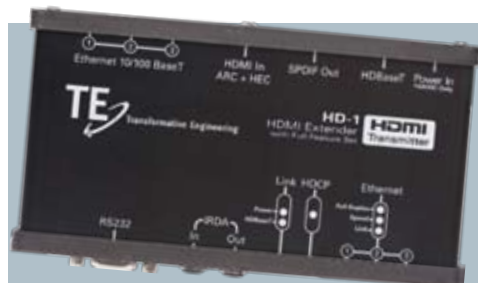

DIGITAL HDMI VOLTAGE INSERTER

At times, a source device (cable box, DVD player, video game system) will not have enough power dedicated to the HDMI output. This will cause a voltage drop and the video quality is affected, or worse, there is no video at all. The RapidRun Digital HDMI Voltage Inserter solves this problem by isolating the power from the source device and providing a dedicated power signal to give the crisp, clean signal that is expected from high definition equipment.

CG42223 Cables To Go Digital HDMI Voltage Inserter **\$21.95**



NETMEDIA INTELLIGENT HDMI SWITCH, 4x1

The NetMedia iHDMI 4x1 is an intelligent auto-sensing 4-port HDMI switch. It automatically senses and connects whichever component was last powered up to provide spontaneous access to multiple HDMI devices such as Satellites, Blu-rays, video game consoles, or computers. The iHDMI 4x1 also includes a serial port for automated control and advanced cable setup. Cascade additional 4x1 switches to make even larger intelligent arrays.

- HDMI v. 1.3a 4-input 1-output switch
- DVI/HDMI computer resolution up to 1920x1200
- Auto-senses and connects when source turns on
- 480i, 480p, 720p, 1080i, 1080p, & Deep Color

NM5WITCHHD4X1 NetMedia iHDMI 4x1 **\$104.95**

Includes iHDMI-4x1 Switch Assembly & Power Transformer



OMNI-BALUN

When is less – more? When you can do more with less! With the Omni-Balun, you now only need one part instead of four or five! The revolutionary Balun converts Analog Video (composite and component) and Analog and Digital Audio into Cat5 or Cat6 cable for extended runs of up to 300' at 1080i resolution. In addition, there's even 2 IR-Pass Thru connections (3-conductors)!

TEOB2 Omni-Balun **\$74.95**



TRIPP LITE HDMI SIGNAL EXTENDER

Use Tripp Lite's HDMI Extender to run HDMI cables beyond the 5 Meter distance limitation. It supports HDMI signals up to 150'. The Extender is ideal for home or business theaters that employ HDMI cables and equipment. Supports signal rates up to 1.65Gbps, and UXGA resolution.

TPB122 Tripp Lite HDMI Signal Extender **\$99.95**



TRIPP LITE HDMI EXTENDER CABLE

Tripp Lite's HDMI v1.3 Active Extender Cable solves the problem of running HDMI cables longer than the maximum recommended distance of 15'. The Active Chip in the adapter means that no external AC Adapter is required.

TPB123001 Tripp Lite HDMI Extender Cable **\$99.95**

TRIPP LITE HDMI OVER CAT5E/CAT6 EXTENDER WALLPLATE

With the Tripp Lite HDMI Over Cat5/Cat6 Wallplate Extender Kit, you can locate an HDMI enabled display up to 230' away from the HDMI source, using readily available Cat5 or Cat6 cable. The kit consists of a Passive wallplate at the source side, and an Active wallplate at the display side.

TPP167000 Tripp Lite HDMI Over Cat5e/Cat6 Extender Wallplate **\$129.99**



BARGAIN HUNTING FOR HOME AUTOMATION PRODUCTS
Online Specials Exclusively At www.HomeControls.com/Specials

CONNECT ALMOST ANY DEVICE TO A NETWORK



GLOBAL CACHÉ iTACH

The Global Caché iTach is a family of products designed to connect almost any electrical device to a network in a matter of minutes. Based on open systems and industry standards, the ultra-compact device fits almost anywhere (even the palm of your hand), and includes a choice of wireless (Wi-Fi) or wired connectivity to IR, serial (RS232), and contact closure (relay) equipment.

The innovative design of the Global Caché iTach allows for easy and flexible integration into any networked control solution. The iTach is a simple wired or

wireless conduit between you and your device over a network or the Internet.

This is instant network-enabling at its best, delivering the power of choice at a cost-effective price.

- Connects almost any electrical device to a network
- Access, monitor, control standalone equipment
- Supports 8 simultaneous connections
- Ultra-compact design, stylish enclosure
- On board web server for easy setup, HTTP, DHCP
- Flash upgradeable for firmware enhancements

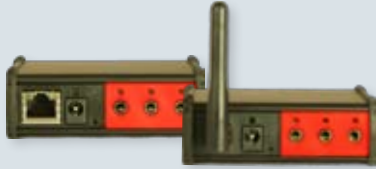
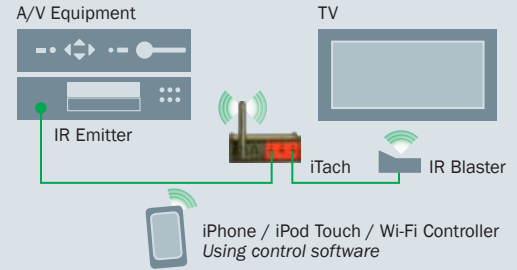

GLOBAL CACHÉ iTACH FOR IR DEVICES

- GCWF2IR** Global Caché iTach, Wi-Fi **\$149.95**
- GCIP2IR** Global Caché iTach, Wired **\$124.95**
- GCIP2IRP** Global Caché iTach, Wired with PoE **\$159.95**



GLOBAL CACHÉ iTACH FOR SERIAL DEVICES

- GCWF2SL** Global Caché iTach, Wi-Fi **\$149.95**
- GCIP2SL** Global Caché iTach, Wired **\$124.95**
- GCIP2SLP** Global Caché iTach, Wired with PoE **\$159.95**

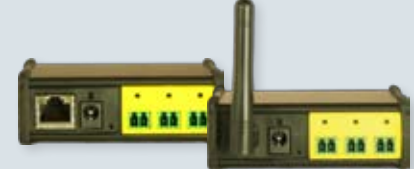

GLOBAL CACHÉ iTACH FOR CONTACT CLOSURE DEVICES

- GCWF2CC** Global Caché iTach, Wi-Fi **\$149.95**
- GCIP2CC** Global Caché iTach, Wired **\$124.95**
- GCIP2CCP** Global Caché iTach, Wired with PoE **\$159.95**

GREAT SELECTION OF VIDEO MODULATORS!

CABLETRONIX DIGITAL MODULATORS

The CableTronix modulators are frequency agile modulators that allow for insertion of a video, and left and right audio signals from a satellite receiver, VCR, laser disc, DVD or security camera to be inserted on selected TV channels. These units are switchable between off-air and CATV signals, so that one unit can be used for both applications.



- NACTARM2LTIR** Digital Agile Modulator, 2 Input with Audio Video Loop Through Outputs, IR capable **\$149.95**
- NACTARM4IR** Digital Agile Modulator, 4 Input, IR capable **\$219.95**

DIGITAL AGILE MODULATOR

Multiple video content distribution to all TVs without the purchase of additional video devices.

- Output level: 25dBmV
- Audio and Video AGC
- Precise digital PLL control
- Extended channel range, UHF 14 to 78 and CATV 65 to 135 (excluding 95 -99)
- Dual RCA inputs directly on the unit
- Built-in RF amplifier



- NACTMM10** Digital Agile Modulator **\$34.95**

DIGITAL MICRO MODULATOR

Make your own TV channels with these ultra-compact modulators!

- UHF 14-69 and cable 70-125 channels
- Compact size and weight
- Internally generated test pattern
- Built-in video amplifier
- Combined stereo inputs
- Precise digital channels



- NM70** 1-Channel Micro Modulator **\$104.95**
Size: 3 1/2" x 2 1/8" x 9/16" & Weighs 4.2oz.
- NM73** 3-Channel Micro Modulator **\$224.95**
Size: 3 9/16" x 5 1/2" x 9/16" & Weighs 8.7oz.

MULTI-CHANNEL MODULATORS

These input modulators output on a single coax to any distribution system. All models provide loop-thru capability to be used when maintaining MTS Stereo at the modulator location. Features CATV 65-125 (excluding 95-99) and UHF 14-64 and 115V AC power supply.



- MP5515** 1-Channel Modulator **\$109.99**
- MP5525** 2-Channel Modulator **\$179.99**
- MP5545** 4-Channel Modulator **\$286.99**

Many More Video Modulators » www.HomeControls.com/VideoModulators

VIDEO MODULATOR FOR HIGH DEF TELEVISIONS!

HDTV VIDEO MODULATOR

The Channel Plus 5415HD is a single channel, high definition video modulator that takes the output from a single HD source and broadcasts it over standard coax cabling to any connected HDTVs. The 5415HD supports up to 720p HD format, accepts component video input and has an integrated 25dB video amplifier.



- MP5415HD** Channel Plus HDTV Video Modulator **\$914.99**
- LNH838HHR** OpenHouse Distribution Amp **\$161.99**

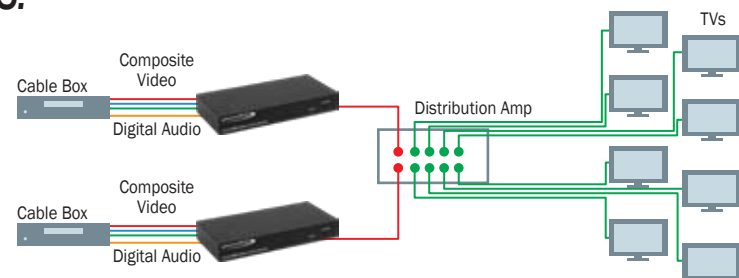

SURGE SUPPRESSORS

RESIDENTIAL SURGE PROTECTION DEVICE

Leviton's Residential Panel Surge Protection Device (SPD) is a high-performance Transient Voltage Surge Suppressor. The Residential Panel SPD unit is designed for use on 120/240VAC at the home's breaker panel. Diagnostics provide visual indicators for monitoring the 120/240VAC protection status.

LV511101 Surge Protection Device (SPD) **\$69.95**



WHOLE HOUSE SURGE SUPPRESSOR

This heavy duty surge suppressor will handle unlimited main breaker panel current, a transient surge capacity of 680 Joules, and 50,000A of surge current all with an instantaneous response time! The 51120 Series Panel Protectors are inexpensive insurance for your whole-house X10 automation system and stereo components.

LV511201 Whole House Surge Suppressor **\$244.95**



OUTDOOR WHOLE HOUSE SURGE SUPPRESSOR

This heavy duty surge protector will handle unlimited main breaker panel current, a transient surge capacity of 680 Joules, and 50,000A of surge current all with an instantaneous response time! The Whole House Surge Suppressor is excellent and inexpensive insurance for your whole-house X10 automation system and entertainment components.

LV511203R Outdoor Surge Suppressor **\$324.95**



DUPLEX OUTLET SURGE SUPPRESSOR

The Leviton Duplex Outlet Surge Suppressor is 15 Amp and 125 Volt. This Surge Suppressor is hospital grade, self grounding, and is back and side wired. It features a surge indicator light with an audible alarm.

LV8280W Duplex Outlet Surge Suppressor **\$49.95**



More Surge Suppressor Options »
www.HomeControls.com/Surge-Protectors

TRICKLESAVER

The TrickleStar PC TrickleSaver reduces standby energy consumed by electrical equipment.

When a system is turned On, the Trickle Saver switches On all peripheral devices. Conversely when a system is switched Off, the product switches Off all peripheral devices. The product is suitable for residential and office applications.

TrickleSaver can be connected directly to equipment or connected to a standard electrical power strip with a number of connected devices.

- Compatible with standard power strips and surge protectors



CUSTOMER FAVORITE!

TS150PC PC TrickleSaver **\$12.95**

For Mac & PC Computers

TS151PC PC TrickleSwitch **\$6.95**

Provides A Manual Override

Did you know your computer and A/V equipment still use power even when turned off? Here's how to save!



TRICKLESTRIP

The TrickleStar 7 Outlet Powerstrip features power outlets that can sense when an individual plug-in component is turned off. While components that are turned on remain powered, the powerstrip knows not to send electricity to its "off" outlets, radically reducing vampire/standby energy consumption. The 7 Outlet Powerstrip also provides fireproof surge protection, uniquely designed for PC and TV peripherals.

TS180SSUS7XX TrickleStar 7 Outlet Powerstrip **\$34.95**

TS180SSUS7XD TrickleStar 7 Outlet Powerstrip (with RJ11/45) **\$39.95**

TS180SSUS7CX TrickleStar 7 Outlet Powerstrip (with Coax) **\$39.95**

POWERLINE CONDITIONING FROM TRIPP LITE

AVR UPS SYSTEM

Same as the Pure Sine Wave Series with Automatic Voltage Regulation (AVR).

TPHT1000UPS AVR UPS System, 1000VA **\$229.00**

TPHTRL15UPS AVR UPS System, 1500VA **\$398.00**



ISOBAR A/V SURGE SUPPRESSOR

Provides premium protection (3134 joules), stopping damaging surges and filtering disruptive line noise!

- Choose 6 or 8 Outlets

TPAVBARx Isobar A/V Surge Suppressor **\$119.99**

POWER CONDITIONING CENTERS

8 outlet isobar rackmount/console, EMI/RFI filtering, surge/spike protection, full equipment depth.

TPAV3500PC Power Conditioning Center, 5700 joules **\$249.95**



For flat panel installation or flat-panel digital displays. Comes with 2 detachable cords (18" and 10").

- 2.2 GHz coax protection

TPAV2FP Power Conditioning Center, 5100 joules **\$179.95**



A/V BACKUP POWER BLOCK

Provides a safety net by switching your equipment to battery back-up during power anomalies.

- Recycle/reset button with 60-second outlet delay for proper reboot of router and modem
- 4 12VDC output connections for cameras, modulators, etc. - reduces number of bulky transformers
- Auto restart after long-term outage
- Complete Surge and Spike protection
- EMI/RFI filtration

TPAV550SC Backup Power Block **\$229.95**

CUSTOMER FAVORITE!

A Must For Any System That Includes A Router & Modem!



IR Distribution

1 At least 1 IR receiver to read the signals from your remote control

2 A Connecting Block to control the entire IR system

3 As many emitters as needed to control the A/V components

4 A power supply to provide power to the system

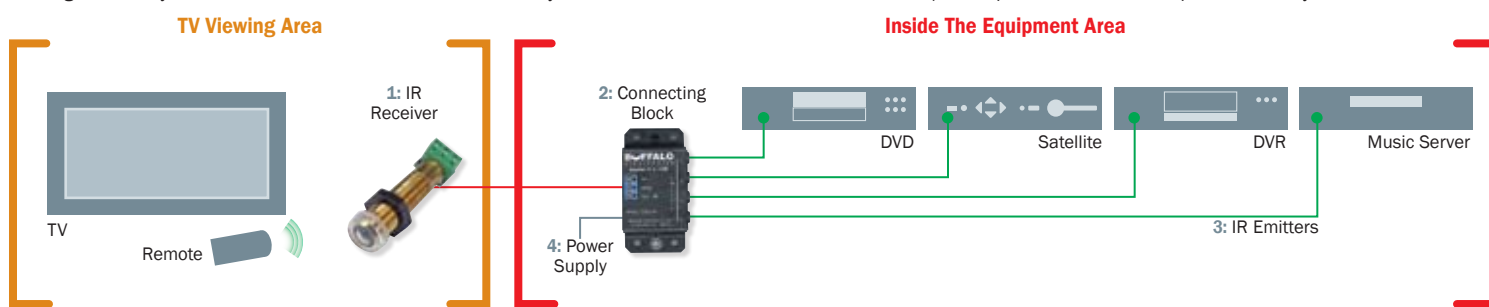

BUFFALO ELECTRONICS IR

HIGH PERFORMANCE J-BOX REPEATER

This ultra-thin, 1/2" deep, high performance voltage regulated repeater installs easily in any electrical box.

- Surface mount technology for superb noise immunity, low current draw and reliability
- Voltage regulation for consistent sensitivity at any home run wire length
- Ambient light range is 40' with an acceptance angle of 130°
- A hidden, pin-light LED flashes confirmation
- Extensive shielding for robust noise shield
- Terminal block connector accepts up to 16 gauge wire
- Installs in any standard electrical box or P-ring
- Colors: Includes White and Light Almond
- Wallplate not included (see page 59)



BEIR250WLA J-Box IR Repeater **\$39.95**

AMPLIFIED IR CONNECTING BLOCK

- 4 flasher jacks
- Will drive 15 repeaters
- Flasher voltage regulation for consistent output levels
- Signal amplification for long repeater runs
- Signal confirmation LED
- Parallel if more required



CUSTOMER FAVORITE!

BEIR100 IR Connecting Block **\$34.95**
BEDV9500 Power Supply (required) **\$7.50**

HIGH PERFORMANCE TUBE REPEATER

This standard size, 1/2" diameter, high performance voltage regulated tube repeater installs easily with a built-in terminal block connector. Tube repeaters offer many installation options to achieve a clean and uncluttered look.

- Superb noise immunity, low current draw
- Voltage regulation for consistent sensitivity at any home run wire length
- Approximate range in ambient light is 40' with an acceptance angle of 130°
- Excellent noise shielding
- Installs in any standard 1/2" mounting hole
- Attractive dark polycarbonate lens and black easy grip mounting nut (also clear lens, supplied)



BEIR350 Tube Style IR Repeater **\$37.50**

IR FLASHER

- Self-stick adhesive for easy mounting over equipment IR windows
- LED flashes signal confirmation
- Standard 1/8" mini plug with 6' cord works with most existing IR systems



BEIRE1 IR Flasher **\$6.50**

LONG-RANGE IR SOLUTION

CHANNEL VISION PLASMA-PROOF IR SYSTEM

Hide your plasma receiver, audio source, cable box, and DVD equipment in a cabinet or separate room and control it without ever having to open the doors again. The Plasma Proof IR Kit is ideal for IR distances up to 1,000'.

- Ideal for components behind closed doors
- Control up to 4 devices in a single-room

CVIR5010 Channel Vision Plasma-Proof IR System **\$94.95**

Includes IR Receiver, IR Repeater Hub, 4 IR Emitters, Mounting Accessories & Power Supply



NEW

SPEAKERCRAFT IR



SMARTPATH IR KIT

Everything you need for a complete SmartPath system all in one convenient package! Includes one desktop IR receiver, 4 IR emitters, one amplified connecting block and a power supply.

The SmartPath IR Receiver is a small, attractively-styled IR device designed to sit on a shelf, cabinet or any flat surface. Among with its unique features is an exclusive Ambient Noise Suppression (ANS) system. It acts to push down IRI, CFL, EMI, or ESI noise sources so that stronger signals from IR remotes have adequate margin for command of the controlled component.

The SmartPath Connecting Block includes a wide bandwidth amplifier for robust operation. It has blaster drive power capability and is reverse voltage protected.

SCIRC30KIT SmartPath IR Kit **\$159.95**

ADDITION SMARTPATH COMPONENTS

SCIRC10 Tube-Style IR Receiver **\$104.95**

Includes Black & White Bezels

SCIRC20x Mini IR Receiver, Surface Mount **\$99.95**

Choose from Black or White

SCIRC40x J-Box In-Wall IR Receiver **\$94.95**

SCAT10 Amplified IR Connecting Block **\$59.95**

SCIRE05 Micro Mini IR Emitter **\$29.95**

SCIRE50 IR Blaster **\$24.95**

SCILC10 IR Light Collector (10 Pack) **\$18.95**

SCIRSHIELD IR Emitter Shield **\$2.35**

More SmartPath Online

» www.HomeControls.com/SpeakerCraft



FULL LINE OF IR PRODUCTS!
 Log on to www.HomeControls.com

HIDE YOUR IR COMPONENTS

HOT LINK

Hot Link Pro repeats and enhances IR signals while hiding in your cabinet, with no remote control attachments. Drill no ugly holes! Hot Link's IR Eye can be mounted on the back of flat panel displays, behind door slots, speaker grills, cabinets and wall plates without modification or under toe kicks and sub-woofer speakers. Bounce your IR signals to your equipment behind you or to an adjacent room! Hot Link is more than 4 times as sensitive as standard receiver targets, and is broadband, eliminating the need for special receivers at different frequencies. The Receiver Eyes of all Hot Link models can be extended to 25' using RG6 adapted to RCA connections.



CUSTOMER FAVORITE!

- A complete single box solution, Hot Link Pro Remote Control Booster Systems come complete with power supply, main amplifier, emitters and receiver eye

MCHLPRO Hot Link Pro **\$89.95**

6 Emitters

MCHLPROX12 Hot Link Pro X12 **\$129.95**

12 Emitters

MCHLXL Hot Link XL **\$124.95**

6 Emitters - Eye Cable Is 6' Long, Emitters & Confirmation Led Cables Are 7' Long.

Cat5 Jumper In Box Is 6' & Can Be Changed To 200'

Main Box can be Velcro-mounted to the back of the flat panel display with Eye and Confirmation LED. Install Remote Box with Emitters and DC power entry in remote-located equipment closet. 2 Blue Status LEDs confirm fuse and proper wiring.

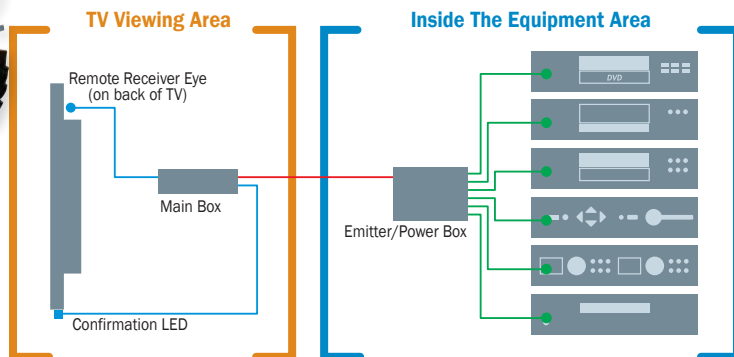

POOL/SPA VERSION

Repeating IR Remote Controls to the wet or outdoor location. The Hot Tub Hot Link repeats for 1 IR operated device and has about a 12' range from remote to eye. It is sun-proof, water-tight and has a lensed bezel for mounting.

MCHTHL Hot Tub Hot Link **\$54.95**

GLOBAL CACHÉ IR SOLUTIONS

IR LEARNER

The Global Caché IR Learner is used with a PC to learn the full spectrum (30KHz to 500KHz) of IR codes that control IR driven equipment. When used in conjunction with the free IR Utility, the learned code is displayed, converted into other formats, and automatically copied into the Windows clipboard. Stored codes can be used to control and automate devices that accept IR control signals from networked computers.

GCIRL IR Learner **\$99.95**

IR EXTENDER

The Global Caché IR Extender extends IR capability by converting signals into digital data, which can then be read from any PC or RS232 serial port. It is for use with various IR input devices to capture IR commands that can be recorded, played back and used to initiate actions across a network. It is the first extender to support the full IR frequency spectrum.

GCIRE IR Extender **\$74.95**



IR OVER CAT5

CHANNEL VISION IR HUB

The IR Hub can be used in a variety of applications and provides power to multiple IR receivers from one central location. Utilize the Hub to expand an existing IR system by simply adding IR emitters and extending the distance with the IR Receiver.

CVIR1203 IR Hub **\$29.95**

CVIR2400 IR Receiver **\$64.95**

CVIR3002 Dual IR Emitters **\$8.95**

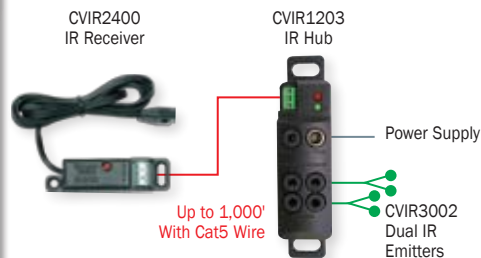

IR OVER COAX



COAX IR KIT

CVIR4500 Coax IR Starter Kit **\$69.95**

Includes IR Coax Engine, IR Coax Receiver, Dual IR Emitter & Power Supply

POWERFUL REMOTE

NEVO TOUCHSCREEN REMOTE CONTROL

The NEVO Touchscreen Remote Control is an IR/RF remote that incorporates a 2.2" touchscreen color display and 41 programmable hard keys. The remote can control up to 18 devices and is IR learning capable. The built-in RF transmitter can control DirecTV satellite receivers without any additional equipment. By adding the optional base station, RF control capabilities can be expanded to all of your equipment.

With its intuitive touchscreen setup guide, the NEVO remote will be controlling your equipment in a matter of minutes. Complex systems are no problem when using the easy web-based setup software to customize your remote and design advanced multi-step macros. The flexibility and easy setup of the NEVO make it the perfect choice for your next home theater remote control.

CVUEINEVOC3 NEVO Touchscreen Remote Control **\$174.95**

CVUEIREX433 NEVO Touchscreen Remote Base Station **\$59.95**



More Universal Remotes Online » www.HomeControls.com/UniversalRemoteControls

Smartphone Accessories

HOME PHONE MEETS CELL PHONE

CLEARSOUNDS iCREATION PHONE

Make, answer and amplify both landline and cell calls from a single, full-featured phone set. iCreation also incorporates advanced cell phone features into landline calls. For example, the wireless iCreation handset can access Siri to allow voice-commands. You can even put a cell call on hold and switch to a landline call.

- Make, answer and switch between cell calls and landline calls
- Charging cradle for your smartphone
- Adjustable cradle for more effective video calls
- DECT 6.0 cordless technology offers secure communication

The iCreation Phone includes an advanced handset with a 1.8" high-definition display screen. Designed in the "app-phone" style, the screen lets you easily navigate through calls logs, your phone-book, language options, and contrast options. And like a smart phone, you can even choose from different wallpapers or background colors!

CLCS1700 ClearSounds I700 iCreation Phone (for Apple iPhones) **\$114.95**

Colors: Choose from White or Black

CLCSG700 ClearSounds G700 iCreation Phone (for Samsung Galaxy Phones) **\$114.95**



NEVER LOSE YOUR PHONE - OR YOUR SANITY!

ZOMM WIRELESS LEASH PLUS

Using the latest in Bluetooth technology, the ZOMM Wireless Leash Plus combines several amazing features into one small and compact keychain device. It connects with your cell phone and provides a portable speakerphone, alerts you when you forget your phone, operates as a panic alarm and even calls 911 in an emergency.

Never Lose Your Valuables: Your mobile phones is not just about making a call, they are a lifestyle - photos, contacts, movies, emails and more! The Wireless Leash Plus tethers to your phone wirelessly and will alert you if it ever separates from you.

Speakerphone: With a tap of the Z-button, the ZOMM becomes a speakerphone. You can answer your mobile phone from ZOMM, as well as transfer an existing call to and from your phone. Now you can answer calls safely and hands-free while driving.

In Case of Emergency: The ZOMM Wireless Leash comes with a built-in PANIC alarm that is designed to draw attention to you if you are in an emergency situation.

ZMMFINAM ZOMM Wireless Leash Plus **\$79.95**



CUSTOMER FAVORITE!

More Smartphone Gadgets & Accessories » www.HomeControls.com/SpecialtyCellPhoneProducts

BOOST CELL PHONE RECEPTION INSIDE & OUTSIDE YOUR HOME

WILSON SLEEK UNIVERSAL SIGNAL BOOSTER KIT

For personal cell signal boosting wherever you need it, use the Wilson Sleek Universal Signal Booster Kit. The Sleek works in your car, at home or in the office. Designed for convenient use on the go, the Sleek easily mounts to your vehicle's dashboard. Simply place your phone in the universal cradle, activate your hands free talk option, and experience clear, reliable reception no matter where you roam.

- Reduces dropped calls, extends signal range, and increases data rates
- Amplifies signals both to and from cell tower
- Adjustable arms fit most any phone
- Works with all cell networks (except Nextel/iDEN, 4G)
- Also increases data performance in weak signal areas.
- Your phone requires less battery power when used in the Sleek cradle, which includes a built-in charger.
- Installs in minutes: no special tools required
- Plug-and-Play kit: package includes everything needed

W1815226 Wilson Sleek Universal Signal Booster Kit **\$109.95**

Includes Sleek Signal Booster, USB Cable, Antenna, Adjustable Arms, Mounting Bracket for Car & Power Supply

W1859970 Wilson Home & Office Accessory Kit **\$29.95**

Required to install the Sleek inside.



WILSON SIGNALBOOST DB PRO

The SignalBoost DB Pro cellular amplifier kit significantly improves the performance of any cellular device on any network (except iDEN Nextel) experiencing weak signal inside of buildings.

At the center of this kit is the DB Pro dual band bi-directional amplifier with a new high gain design. An external omni directional antenna with multiple mounting options eliminates researching cell site locations and antenna pointing. The inside panel antenna which rebroadcasts the amplified signal is designed for optional in-wall mounting.

All components are connected using provided standard coax cable.

W1841262 Wilson SignalBoost DB Pro Kit with Omni-Directional Antenna **\$499.95**

Includes SignalBoost DB Pro Amplifier, Outside Omni-Directional Antenna, Inside Wall Mount Panel Antenna & Coax Cables.

W1841263 Wilson SignalBoost DB Pro Kit with Wide Band Antenna **\$614.95**

Includes SignalBoost DB Pro Amplifier, Outside wide band directional antenna, Inside Wall Mount Panel Antenna & Coax Cables.



LEVITON MOBILE DEVICE STATION



The Leviton Mobile Device Station creates a convenient wall cradle for your cell phone, music player, and more. Now you can dock your mobile device right next to a power outlet or the controls for your home entertainment system.

The Mobile Device Station allows easy access to your device's touch screen so you can listen to your favorite music, stream video, and charge your device all from the same wall-mounted location.

- Fits iPhone, Android, Blackberry and more
- Colors: Choose White, Light Almond or Black
- Wallplate not included (see page 59)

LV47112x Leviton Mobile Device Station **\$11.95**

LEVITON USB CHARGER & RECEPTACLE

This state-of-the-art device has the ability to charge up to three electronic devices at once utilizing the USB Ports and the receptacle. Strategically designed with two vertical USB Ports, it allows additional space for maneuvering of charging cords and reduces stress on the cables while charging.

- Colors: Choose White or Light Almond
- Wallplate not included (see page 59)

LVT5630x Leviton USB Charger & Receptacle **\$25.95**



Wireless Doorbells & Chimes



HEATH ZENITH WIRELESS DOOR CHIME

The Heath Zenith Wireless Musical Door Chime has 64 different selectable tunes. The songs in your musical chime are arranged in four groups of 16 songs per group.

- Note: only one song can be selected at a time.

HZSL6164 Heath Zenith Wireless Musical Door Chime **\$44.95**



CUSTOMER FAVORITE!

DAKOTA ALERT WIRELESS DOOR CHIME

A simple do-it-yourself solution for installing a doorbell in a home or business. The wireless button sends a signal up to 1,000' back to the base. Plays 16 different tunes.

DADC1000 Dakota Alert Wireless Door Chime **\$44.95**
DADCPB1000 Extra Door Button for Dakota Alert Door Chimes **\$13.95**



NUTONE WIRELESS DOOR CHIME

White receiver and one button. Just plug receiver into a convenient wall outlet and it's ready for use. 100' range.

NULA203WH Nutone Wireless Door Chime **\$39.95**
NULA204WH Nutone Wireless Door Chime with Strobe **\$69.95**
NUPB7X Extra Door Button for Nutone Wireless Door Chimes **\$18.95**



NEW

STI WIRELESS DOOR CHIME

- Receiver works up to 250' away from transmitter
- 13 selectable doorbell chimes
- Adjustable volume

STI32500 STI Wireless Door Chime **\$39.95**
STI32530 Extra Receiver for STI Door Chime **\$24.95**
STI33010 Extra Door Button for STI Door Chimes **\$20.95**



CUSTOMER FAVORITE!

PROGRAMMABLE MUSICAL DOORBELL

Announce your visitors in style, to music you create – or choose from over 100 built-in songs, sound effects, and even voice phrases with the Musical Doorbell. Replaces the wired door bell in your home.

MDB2 Musical Doorbell **\$49.95**
MDAS2 Musical Doorbell Auxiliary Speaker **\$19.95**

PHONE INSTALLATION SYSTEMS

TWIST & MOUNT PANELS

- Offers essential phone and data distribution
- Includes Retention Force Technology
- Universal T568A and T568B wiring cards for 100 style terminations
- Fits into any Structured Media Center enclosure



LV476TM654 12 Cat5e/12 Cat6 Twist & Mount Panel **\$184.95**

LV476TM524 24 Cat5e Twist & Mount Panel **\$159.95**
LV476TM624 24 Cat6 Twist & Mount Panel **\$219.95**

TELEPHONE INPUT DISTRIBUTION PANEL

Distribute up to 4 phone lines through 12 connections,

- 4-pair 110 input
- 12 modular RJ45 jack outputs
- 4 RJ11 jack inputs
- Includes 12 8" satin patch cords to link the TIDP panel to media modules
- Ports are labeled
- Fits into any Structured Media Center enclosure



LV476TLT12 Telephone Input Distribution Panel (TIDP) **\$79.95**

Additional Telco Distribution Systems & Accessories Online »
www.HomeControls.com/TelcoDistributionHardwareAccessories

ETCON PHONE DISTRIBUTION DEVICE

- Accommodates up to 4 incoming phone lines and up to 48 Outlet cables or phone home runs
- Includes mounting screws and labels for organizing and wiring any Phone System Combination

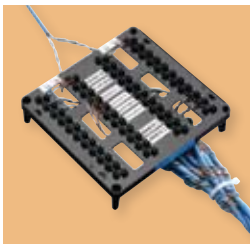

ETDD1 Phone Distribution Device **\$39.95**
ET1C Cover for ETDD1K **\$12.95**

WITH STANDOFFS

ETDD3 Phone Distribution Device with Standoffs **\$39.95**
ET3C Cover for ETDD3 **\$12.95**

ETCOON PHONE DISTRIBUTION DEVICE WITH 8-WAY SPLITTER

- Accommodates up to 4 lines and allows for up to 48 stations or phone home runs
- 8-Way 2Ghz splitter for CATV Cable runs

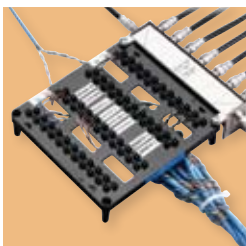

ETDD1X1 Phone Distribution Device with 8-Way Splitter **\$54.95**
ETX1C Cover for ETDD1X1 **\$11.95**

WITH STANDOFFS

ETDD3X3 Phone & Video Distribution Device with Standoffs **\$59.95**
ETX3C Cover for ETDD3X3 **\$11.95**

PHONE SURGE PROTECTOR

Provides exceptional protection against damage from lightning, voltage spikes, and surge damage coming into a phone line. It installs between the RJ31X Phone Jack and the Security Control. The ELK952 features multi-stage protection and is 5 times faster than MOVs.



ELK952 Elk 5-Stage In-Line Phone Surge Protector **\$18.95**

CALLER ID FOR YOUR TV!

CALLER TV

Screen your calls on your TV set! Caller TV places Caller ID information at the bottom of your TV screen in large, easy to read letters. It uses an RCA video input and output to display over any satellite, VCR, DVD, video game or video camera signal for 10-15 seconds.

- Requires Caller ID from your phone company

NMCTV1 Caller TV, 1-Line **\$64.95**
NMCTV1M 1-Channel Modulator/Caller ID **\$109.95**



SHOP AT HOME FOR YOUR HOME!
www.HomeControls.com For Online Shopping

Telephone Entry

CHANNEL VISION

CHANNEL VISION TELEPHONE ENTRY

Get a panel-based phone answering system at a great price! The panel provides communication between the front door and any phone in the house. A complete system requires a control panel and front door intercom.



TELEPHONE ENTRY SYSTEM COMPONENTS

- A CVP0920** Telephone Entry System, 1 Door **\$214.95**
- B CVP0921** Telephone Entry System, 2 Door **\$279.95**
- C CVP0925** Paging Module **\$49.95**
- D CVTE110DS** Door Strike Control Relay **\$39.95**

TELEPHONE ENTRY SYSTEM KITS

- CVTE0212** Telephone Entry System Kit **\$319.95**
With White IU Front Door Intercom
- CVTE0282** Telephone Entry System Kit **\$319.95**
With Black IU Front Door Intercom



DP-SERIES FRONT DOOR INTERCOMS

- DP Size: 4³/₈"W x 6¹/₂"H x 1/4"D (Includes Surface Box)
- Colors: Choose White, Brass, Antique Brass, Chrome, Oil Rubbed Bronze, Antique Copper, Black or Satin Nickel

- CVDP0x** DP Door Intercom **\$174.95**
- CVDP6x** DP Door Intercom with Color Camera **\$284.95**

IU-SERIES FRONT DOOR INTERCOMS

- IU Size: 2³/₄"W x 4¹/₂"H x 1/4"D (Fits a 1-Gang Box)
- Colors: Choose White, Brass, Antique Brass, Chrome, Oil Rubbed Bronze, Antique Copper, Black or Satin Nickel

- CVIU0x** IU Door Intercom **\$114.95**
- CVIU6x** IU Door Intercom with Color Camera **\$224.95**

DS3-SERIES FRONT DOOR INTERCOMS WITH KEYPAD

These door stations feature an integrated access control keypad which can be used to open an entrance gate or an electric door lock.

- 1/4" solid plate with metal screen
- DS3 Size: 7¹/₄"W x 5"H (Fits a 3-Gang Box)
- Colors: Choose Brass, Antique Brass, Oil Rubbed Bronze and Satin Nickel

- CVDS30x** DS Door Intercom with Keypad **\$174.95**
- CVDS36x** DS Door Intercom with Keypad & Color Camera **\$284.95**



NEW

ANSWER THE DOOR FROM YOUR TELEPHONE

DOORBELL FON

The DoorBell Fon replaces the doorbell to let you answer the door from any telephone, even cordless phones. Also open the door with one simple keystroke.



When a visitor presses the button on the doorbox, it rings your home's phones with a distinctive ring. You greet your visitor by simply picking up the phone. If you're on the phone, you'll hear a call-waiting tone that is answered with a simple switch-hook or push of your flash button. The DoorBell Fon connects to 2 doorboxes and allows you to flash between the 2 doors.

- Doorbell button rings your phones
- Uses existing single pair doorbell wires
- Distinctive tones at each door
- Can be used as an Indoor Intercom
- Call waiting tone indication
- 1- or 2-lines, key or home PBX systems
- Each controller supports 2 door stations.

S-SERIES SLIMLINE DOORBELL

These super thin Door Stations are designed to easily fit on door trim like a regular doorbell switch.

- A built-in awning provides protection from the elements plus a stylish look
- No external power required: power drawn from DoorBell Fon Controller
- Colors: Choose Aluminum or Black



NEW

- ACDP38xS** DoorBell Fon Slimline Kit **\$209.95**

Includes Doorbell Fon Controller and Slimline Doorbell.

- ACDP38NxS** DoorBell Fon Slimline Doorbell **\$79.95**



NEW

DP28-SERIES DOORBOX

- Size: 4¹/₂" x 4¹/₂" x 1⁵/₈" (Fits a 2-Gang Box)
- Colors: Brass, Black, Bronze or Aluminum

- ACDP28xF** DoorBell Fon DP28 Kit **\$274.95**

Includes Doorbell Fon Controller and DP28 Doorbox.

- ACDP28NxF** DoorBell Fon DP28 Doorbox **\$144.95**

DP38-SERIES DOORBOX

- Features housing for pinhole camera
- Size: 4¹/₂" x 4¹/₂" x 1⁵/₈" (Fits a 2-Gang Box)
- Colors: Brass, Black, Bronze or Aluminum

- ACDP38xF** DoorBell Fon DP38 Kit **\$274.95**

Includes Doorbell Fon Controller and DP28 Doorbox.

- ACDP38NxF** DoorBell Fon DP38 Doorbox **\$144.95**

M&S and NuTone Retrofit Sizes Also Available

» www.HomeControls.com/DoorbellFon

WIRELESS & PORTABLE!

OPTEX iVISION WIRELESS VIDEO DOOR INTERCOM

Instantly see who's at your door from anywhere in your home with the iVision Wireless 2-Way Intercom System with Video. This system provides both security and peace of mind by giving you the ability to know when somebody is outside your home plus view and talk to them from the safety and comfort of any location in your home.

- OPIVISION** Optex iVision Video Door Phone Kit **\$319.95**

Includes Wireless Video Monitor, Door Intercom Camera, Docking Station & Accessories



VERSATILE PHONE ENTRY & INTERCOM SYSTEM

TOUCH-N-TALK PHONE INTERCOM

Touch-N-Talk's 8000 Series provides phone-to-phone intercom on a single phone line using standard touch tone phones. Up to 8 extensions may call from phone to phone in the home, with 3 All Call zones.

- A DCTNT8000** Touch-N-Talk 8000 **\$534.95**
- DCTNT8800** Touch-N-Talk 8000 Expander Module (for 8 additional extensions) **\$234.95**

TOUCH-N-TALK PHONE INTERCOM & FRONT DOOR ENTRY

Expand the Touch-N-Talk 8000 so you can answer the door with your phone. This Add-On Module mounts inside the same enclosure.

- Uses the SP-1000 series speakers (1 Station) or the SP-2000 series speakers (2 and 4 Stations).

- DCTNT8210** 1-Station Add-On Module **\$119.95**
- DCTNT8200** 2-Station Add-On Module **\$234.95**

TOUCH-N-TALK 1-DOOR ENTRY

Touch-N-Talk's 6000 series provides 2-Way communication from an existing touch tone phone to a speaker.

- Uses the SP-2000 series speakers.

- DCTNT6001R** Entry Controller, 1-Station **\$339.95**
- DCTNT6200** Remote Answering Module **\$419.95**

TOUCH-N-TALK MULTI-DOOR ENTRY

Touch-N-Talk's multi-station system for communication with multiple entrances, such as front door, back door and gate, plus access controls.

- Uses the SP-2000 series speakers.

- DCTNT6400** Entry Controller, 4-Station **\$574.95**



TOUCH-N-TALK DOOR SPEAKERS

SP-1000 SERIES

- E DCSP1000** Speaker with Built-In Button, White **\$44.95**

- C DCSP1100** Speaker with Built-In Button, Antique Brass **\$99.95**

SP-2000 SERIES

- E DCSP2000** Speaker with Built-In Button, White **\$54.95**

- C DCSP2100** Speaker with Built-In Button, Antique Brass **\$109.95**

- DCSP2300** Front Door Speaker, White **\$34.95**

Complete List Touch-N-Talk Components

» www.HomeControls.com/TouchNTalkAnsweringSystems

On-Q Studio Intercom



SELECTIVE CALL INTERCOM PAIRS TECHNOLOGY WITH DESIGN

ON-Q SELECTIVE CALL INTERCOM

Seamlessly blending leading edge technology with stunning design, Selective Call is the most advanced intercom in the industry. The system allows broadcast or room-to-room communication at the touch of a button, and enables up to 3 simultaneous conversations – the only intercom in the industry to do so. And it's all based on efficient Cat5 wiring.

- Up to 32 locations per system
- Simple, intuitive user interface
- Up to 3 simultaneous conversations
- No main console
- 96 customizable room names
- 20 built-in digital door tones
- High-resolution color LCD interface
- Four LCD skins
- Convenient RJ45 connection
- One-person installation via system auto-discovery
- Room unit features a high resolution color LCD interface, with advanced customization options like personalized room names and dynamic list sorting
- Each unit includes a high-quality speaker and microphone for crisp, static-free sound
- Features include unit auto-discovery, self-healing capabilities, and local mute and monitor

- OQIC5400** Selective Call Intercom Kit, 4 Zone **\$1104.95**

Includes Intercom Distribution Module, 4 Intercom Room Units & Power Supply



CUSTOMER FAVORITE!

SELECTIVE CALL COMPONENTS

- Room unit colors: Choose White, Light Almond, Gloss Black or Titanium
- Door/Patio unit colors: Choose White, Antique Brass, Brushed Stainless, Bronze, and Shiny Brass

- A OQIC5000** Room Unit **\$244.95**
- B OQIC5001** Distribution Module **\$304.95**
- C OQIC5002** Door Unit **\$179.95**
- D OQIC5003** Door Unit With Video **\$419.95**
- E OQIC5004** Patio Unit **\$189.95**
- OQIC5006BK** Back Box **\$18.95**

Enables Surface Mount Of All Exterior Units

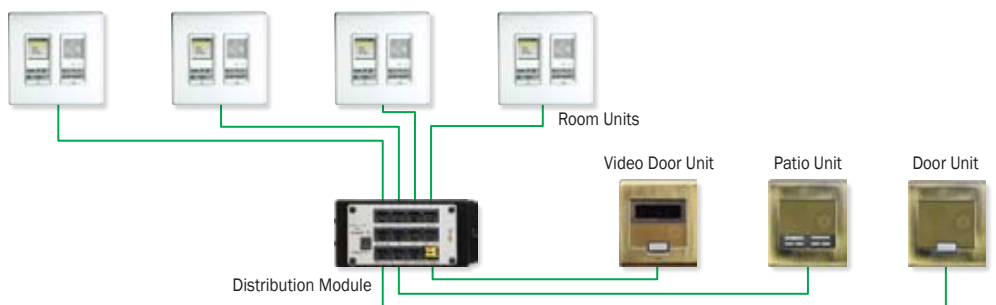
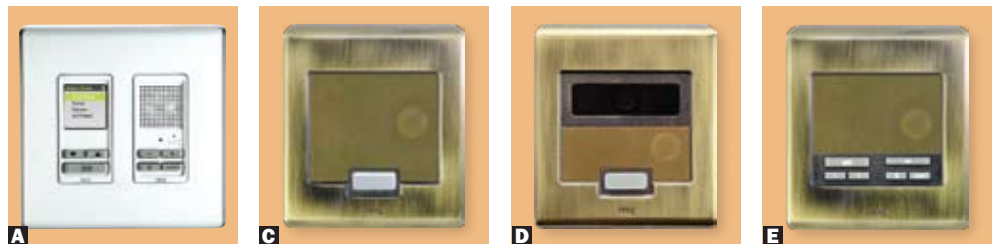

Expand your system with IyriQ Audio. See Page 66.



Integrate your Intercom with the LCD Console. See Page 48.



Studio Design Wallplates. See Page 59.

AVAILABLE COLORS
For Products On This Page

- WHITE
- LIGHT ALMOND
- GLOSS BLACK
- TITANIUM
- ANTIQUE BRASS
- BRUSHED STAINLESS
- BRONZE
- SHINY BRASS

ON-Q BROADCAST INTERCOM

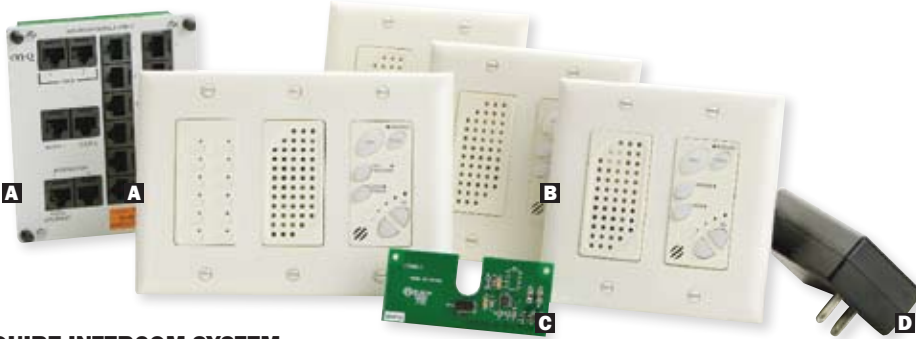

INQUIRE INTERCOM SYSTEM

Based on Cat5 wiring and offering a modern look that fits in a standard decorator wallplate, On-Q intercoms are an affordable option for every home.

- Trims with standard decorator wallplate (included)
- Page, monitor, do not disturb and hands-free reply
- Monitor multiple rooms at the same time
- Multi-level volume control

INQUIRE INTERCOM KIT

OQIC1400 inQUIRE Intercom Kit, 4-Location **\$769.95**

Includes Intercom Module, Main Console Unit, 3 Room Units, Door Chime & Power Supply (Choose White Or Ivory)

INQUIRE INDOOR INTERCOMS

- Colors: Choose White, Ivory or Light Almond

A OQIC1002 Main Control Unit & Intercom Module **\$469.95**

E OQIC1004 Intercom Room Unit **\$69.95**

INQUIRE INDOOR INTERCOMS

- Colors: Choose Black or Silver

E OQF9018 Intercom Desktop Unit **\$114.95**

INQUIRE OUTDOOR INTERCOMS

- Colors: Choose White, Antique Brass, Oil-Rubbed Bronze or Shiny Brass

OQF7596 Intercom Door Unit **\$49.95**

F OQF7641 Intercom Patio Unit **\$94.95**

INQUIRE ACCESSORIES

C OQF7601 Intercom Door Chime **\$44.95**

OQIC1001 Intercom Audio Interrupt Module **\$94.95**

D OQPW7725 Power Supply, 8 or more rooms **\$64.95**

OQPW7725 Power Supply **\$64.95**

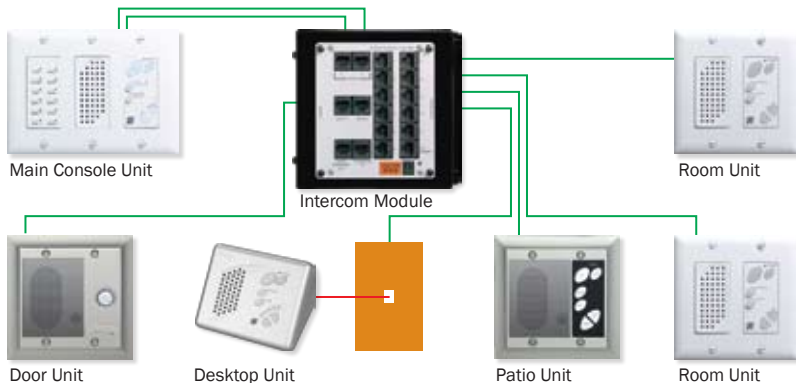

AVAILABLE COLORS

For Products On This Page



CHANNEL VISION INTERCOM

CHANNEL VISION CAT5 INTERCOM KIT

Channel Vision's Cat5 Intercom System Kit is a self-contained system, enabling you to communicate between rooms, the front door or the whole house.

- Broadcast and Room-to-Room Communication
- Control at Station or via Remote Control
- Unlock Doors or Gates Remotely
- Doorbell Chime Option
- Easily expands to 24 Stations

CVST0934 Cat5 Intercom System, 4-Room **\$594.95**

Includes Intercom Hub, 4 Intercom Stations & Remote



WIRELESS INTERCOMS

WESTINGHOUSE INTERCOMS

There are models for every size family and house with a variety of different feature sets, including one that's sure to meet your needs.

POWERLINE DOORBELL INTERCOM

A B WHDB301 3-Channel Intercom Kit **\$89.95**

Includes Intercom With Outdoor Doorbell/Intercom Box

B WHDB300 Outdoor Doorbell/Intercom Box **\$54.95**

POWERLINE INTERCOMS

WHI2C 2-Channel Intercom, 2 Units **\$54.95**

A WHI3C 3-Channel Intercom, 2 Units **\$64.95**

A WHI3S 3-Channel Intercom, 1 Unit **\$34.95**

C WHI4C 4-Channel Intercom, 2 Units **\$69.95**

C WHI4S 4-Channel Intercom, 1 Unit **\$34.95**

VOICE-ACTIVATED POWERLINE INTERCOM

Features 4-channel operation with voice activation of any channel. You can page or talk with any location. This system is easily expandable for larger homes or offices with additional pairs of intercoms.

D WHI4CUPG Voice-Activated Intercom, Pair **\$79.95**



CUSTOMER FAVORITE!



NOTE: During actual sound transmission on these units, X10 signals are blocked.

Complete Technical Specifications Online »
www.HomeControls.com/WestinghouseIntercoms



RF DOORBELL INTERCOM

Uses digital signals to control the stations called and prevents other nearby intercoms from accessing the system. Either of 2 radio frequencies can be selected for the intercoms to further eliminate the chance of interference from adjacent systems.

E F WHDB15C 5-Channel Intercom Kit **\$194.95**

Includes Intercom With Outdoor Doorbell/Intercom Box

F WHI5S Extra 5-Channel Intercom Console **\$134.95**

M&S Communication Systems



VIDEO DOOR INTERCOM

VMC1 VIDEO SECURITY INTERCOM

The VMC1 Video Security Intercom – the only residential system that integrates complete intercom functionality with live video and home automation control – gives homeowners multiple communication and security features in one efficient package.

Far from a simple door-to-video screen entry system, the VMC1 seamlessly combines security video, lighting control, e-mail notification and active camera viewing – all with hands-free response capability – to offer exceptional whole-house communication and entryway security. Supports up to 20 remote stations (including up to three color video camera stations), and controls multiple output switches that automate home security.

- View video from any camera station on any TV in the home; View live video or email a snapshot of a person



ringing the doorbell to a smartphone or remote computer monitor

- Turn lights on or off remotely or automatically
- Activate a security panel panic alert

These combined capabilities make the VMC1 Video Security Intercom attractive to homeowners seeking control and safety.



VMC1 KITS

MSVMC1PACK M&S VMC1 Kit **\$1899.99**

Includes System Master (White), Video Door Station (Metal), and 4 Room Stations (White)

VMC1 SYSTEM COMPONENTS

A MSVMC1x M&S VMC1 Master Station **\$679.99**

Color: Choose White, Black or Bronze

B MSVMC1VDS M&S VMC1 Video Door Station **\$439.99**

C MSVMC1VDS M&S VMC1 Video Door Station, Wide Angle **\$439.99**

Color: Choose Bronze or Silver

D MSVMC1RSWH M&S VMC1 Room Station **\$219.99**

INTERCOM & MUSIC SYSTEM



DMC1 MUSIC/COMMUNICATION SYSTEM

Designed for today's home, the DMC1 Music/Communication System offers you the peace of mind of being able to monitor what's going on in and outside your home. Its elegant style is irresistible – although style is conveyed more convincingly by what you can't see. Updated to accommodate Cat5e wiring with quick connectors.

- Supports 15 room stations and 3 outdoor speakers

- 2 music source inputs
- 8 AM and 8 FM music presets
- Stereo upgrade path with optional power Amp
- Speaker remote volume, source control
- Privacy, intercom only, door release feature
- Automatic On/Off feature
- Colors: Choose from White, Almond or Black

DMC1 SYSTEM KITS

MSDMC1PACK DMC1 Kit **\$981.99**

Includes Master Unit, 4 Indoor Room Stations With Remote Scan, Patio Station, 3-Note Chime Module & Door Speaker

MSDMC1CDPACK DMC1 Kit with CD **\$1605.99**

Includes Master Unit, 6-Disc CD Player, 4 Indoor Room Stations With Remote Scan, Patio Speaker, 3-Note Chime Module & Door Speaker

DMC1 SYSTEM COMPONENTS

MSDMC1MMx DMC1 iPlay Dock **\$622.99**

MSDMC1R Indoor Room Station **\$59.99**

MSDMC1RS Indoor Room Station, Remote Scan **\$59.99**

MSDMC1RW Patio Station, Remote Scan **\$88.99**

MSDS3B Door Speaker with Button, White **\$35.99**

MSBD3BN Door Station with Button, Bright Brass **\$53.99**

MSD3BN Door Speaker with Button, Antique Gold **\$53.99**

MSMC3 3-Note Chime Module **\$49.99**

MSDRW Door Release Mechanism **\$53.99**

AVAILABLE COLORS

For Products On This Page



INTERCOM SYSTEM

DMC-10 INTERCOM SYSTEM

The DMC-10 is an intercom system for structured wire installation in residential applications.

The heart of the system is the Structured Wire Intercom Hub. The hub grid mounts in a structured wiring enclosure (not included). Up to 8 room, door and patio stations in any combination can be connected to the system hub using up to 500' of standard Cat5 cable for each station. For larger installations, a second system hub can be added for expansion, providing a total system capacity of up to 16 stations.

Room station keypads are illuminated with soft blue indicators while the intercom is in use. The door and patio station keys are illuminated with white lighting for easy nighttime operation.

- Color: White (Color change kits available)



DMC-10 INTERCOM SYSTEM KIT

MSDMC10KIT DMC-10 Intercom Kit **\$738.99**

Includes Structured Wire Intercom Hub, 4 Intercom Room Stations, Intercom Door Station & Power Supply

DMC-10 INTERCOM COMPONENTS

MSDMC10H DMC-10 Intercom Hub **\$482.99**

MSDMC10AWP DMC-10 Audio Input Wallplate **\$61.99**

MSDMC10RS DMC-10 Intercom Room Station **\$61.99**

MSDMC10PS DMC-10 Intercom Patio Station **\$86.99**

MSDMC10DS DMC-10 Intercom Door Station **\$51.99**

AirVac Central Vacuum System

AIRVAC POWER UNITS

CENTRAL VACUUM SYSTEMS POWER UNITS

The best part of an AirVac central vacuum system is what it doesn't have: noise, inconvenience, dust. Much less dust left behind – in your rugs, on your furniture, in the air and in your family's lungs. Traditional vacuum cleaners allow too much dust to recirculate – on your rugs, on your furniture, throughout your home. The result: indoor air pollutant levels two to five times greater than outdoor levels.

But an AirVac central vacuum system delivers up to three times more power to lift out dirt, dust mites and animal dander from rugs, drapes and furniture upholstery. AirVac then vents it all outside – safely, quietly, permanently to eliminate this health risk to your family. And AirVac comes with a 10-year warranty (Platinum Series) – that's nothing to sneeze at.

With a little planning, it's easy to install an AirVac system in new or existing homes. The PVC tubing can run through the attic, basement or cold air returns – then lowered or raised behind interior walls to inlet valves that are installed in strategic locations throughout the house. The central power unit is located in an out-of-the-way area such as a garage, basement or utility room, keeping the living areas quiet, clean and dust free.

THE RED SERIES (BAGLESS)

The Red Series (bagless) AirVac, with its high efficiency and superior performance, delivers incredible cleaning power. You'll notice the difference in air quality. And a built-in inlet port allows you to plug the hose directly into the unit so you can clean anywhere within 30' of the canister. The Red Series AirVac offers a 5-year warranty.

- LNAVR3000** AVR3000 AirVac Central Vacuum Power Unit **\$415.99**
- LNAVR7500** AVR7500 AirVac Central Vacuum Power Unit **\$461.99**
- LNAVR12000** AVR12000 AirVac Central Vacuum Power Unit **\$554.99**
- LNAVR24000** AVR24000 AirVac Central Vacuum Power Unit **\$554.99**

	TYPE MOTOR	WATER LIFT	AIR FLOW (CFM)	AIR WATTS	FILTRATION	WASTE CAPACITY	HOME SQ. FT
AVR3000	2-stage, 120V	123"	118	537	to .1 micron	6 gals.	up to 3,000
AVR7500	2-stage, 120V	131"	118	551	to .1 micron	6 gals.	up to 7,500
AVR12000	2-stage, 120V	127"	122	570	to .1 micron	6 gals.	up to 12,000
AVR24000	2-stage, 240V	137"	124	627	to .1 micron	6 gals.	up to 12,000

THE PLATINUM SERIES (DISPOSABLE BAG)

The Platinum Series (disposable bag) AirVac offers all the benefits of the Red Series plus the convenience of a disposable paper bag and a 10-year warranty.

- LNAVP3000** AVP3000 AirVac Central Vacuum Power Unit **\$507.99**
- LNAVP7500** AVP7500 AirVac Central Vacuum Power Unit **\$600.99**
- LNAVP12000** AVP12000 AirVac Central Vacuum Power Unit **\$692.99**
- LNAVP24000** AVP24000 AirVac Central Vacuum Power Unit **\$692.99**

	TYPE MOTOR	WATER LIFT	AIR FLOW (CFM)	AIR WATTS	FILTRATION	WASTE CAPACITY	HOME SQ. FT
AVP3000	2-stage, 120V	123"	118	537	to .1 micron	5.2 gals.	up to 3,000
AVP7500	2-stage, 120V	131"	118	551	to .1 micron	5.2 gals.	up to 7,500
AVP12000	2-stage, 120V	127"	122	570	to .1 micron	5.2 gals.	up to 12,000
AVP24000	2-stage, 240V	137"	124	627	to .1 micron	5.2 gals.	up to 12,000

AIRVAC INLETS

AUTOMATIC DUSTPANS

- Colors: Choose from White, Almond or Black

- A LNV195x** Wall Inlet Valve **\$5.99**
Wall Inlet Valve With Spring Loaded Swing Open Access Cover
- B LNVMP** High-Voltage Wall Inlet Valve **\$6.99**
Controls the central vacuum power, supplies power to electric-driven carpet brushes, and seals the vacuum system when not in use.



AIRVAC HOSES



DELUXE SUPERSYSTEM HOSE

30', 1 1/4" diameter crushproof hose with 3-position swivel handle switch, high or low voltage control, built-in connection for VMVP and VMVPL high-voltage inlets.

- LNV610PS** Deluxe SuperSystem Hose **\$245.99**



DELUXE CENTRAL VACUUM HOSE

30', 1 1/4" diameter crushproof hose with 3-position swivel handle switch, high or low voltage control, 6' AC power cord with plug

- LNV510PS** Deluxe Central Vacuum Hose **\$235.99**

CENTRAL VACUUM HOSES

30', extra-wide 1 3/8" diameter crushproof hose with swivel handle, low voltage control switch.

- LNV400S** Central Vacuum Hose **\$109.99**

30', 1 3/8" diameter crushproof central vacuum hose

- LNV222** Central Vacuum Hose **\$52.99**

SLINKY CENTRAL VACUUM HOSE

3 1/2' crushproof hose that expands to 21'

- LNV361** Slinky Central Vacuum Hose **\$49.99**

ACCESSORIES

- LNV204** Fabric Hose Cover **\$44.99**
30' Stretch Cloth Central Vacuum Hose Cover, Protects Walls, Floors, Moulding & Trim From Scuffing
- LNV205** Deluxe Padded Fabric Hose Cover **\$63.99**
30' Padded Cloth Central Vacuum Hose Cover, Protects Walls, Floors, Moulding & Trim From Scuffing



NEED HELP WITH YOUR VACUUM?
Call 1-800-266-8765 For Assistance!

AUTOMATIC DUSTPANS

- Colors: Choose from White, Almond or Black

- LNVMS** Automatic Dustpan **\$50.99**
Below Cabinet Dustpan, Front Port Opens So Dirt Can Be Swept From Floor Directly Into The Vacuum System
- LNVAN** Flush Mount Automatic Dustpan **\$41.99**
Automatic Flush-Mount Central Vacuum Dustpan, Dirt Can Be Swept From Floor Directly Into The Vacuum System



Don't see what you're looking for?
Log on to www.HomeControls.com/AirVac
or call Home Controls at 1-800-266-8765!



AIRVAC TOOLS

- A LNMV4200DS** Deluxe SuperSystem Central Vacuum Accessory Package **\$447.99**
Includes Deluxe SuperSystem Central Vacuum Hose, 14" Deluxe Power Brush with Headlight, Metal Telescopic Central Vacuum Wand with High-voltage Cord, Metal Telescopic Central Vacuum Wand, Metal Hose Rack, Crevice Tool, Upholstery Tool with Brush, Floor/Wall Tool, Dusting Brush, On-board Tool Caddy & Deluxe Canvas Tool Caddy
- B LNMV2200DS** Standard Electric Central Vacuum Accessory Package **\$417.99**
Includes Deluxe Central Vacuum Hose, 14" Deluxe Power Brush with Headlight, Metal Telescopic Central Vacuum Wand with High-voltage Cord, Metal Telescopic Central Vacuum Wand, Metal Hose Rack, Crevice Tool, Upholstery Tool with Brush, Floor/Wall Tool, Dusting Brush, On-board Tool Caddy & Deluxe Canvas Tool Caddy
- C LNMV1200S** Air-driven Turbo System Central Vacuum Accessory Package **\$254.99**
Includes LNV400S Central Vacuum Hose, 12" Air-driven Turbo Brush, Metal Telescopic Central Vacuum Wand, Metal Hose Rack, Crevice Tool, Upholstery Tool with Brush, Floor/Wall Tool, Dusting Brush, On-board Tool Caddy & Deluxe Canvas Tool Caddy
- LNMVTKD** Deluxe Tool Kit **\$61.99**
Includes Metal Telescopic Central Vacuum Wand, Adjustable Carpet/Floor Tool, Crevice Tool, Upholstery Tool with Brush, Floor/Wall Tool, Dusting Brush, On-board Tool Caddy, Metal Hose Rack & Deluxe Canvas Tool Caddy
- LNMVGAR** Deluxe Garage/Car Tool Kit **\$66.99**
Includes LNV222 Central Vacuum Hose, Plastic Telescopic Central Vacuum Wand, Crevice Tool, Upholstery Tool with Brush, Floor/Wall Tool, Dusting Brush, On-board Tool Caddy & Metal Hose Rack

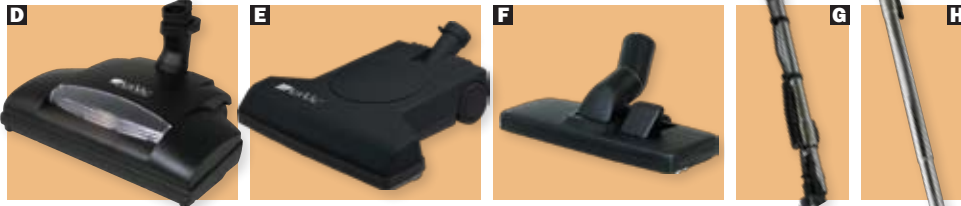

- BRUSHES**
- D LNMV458** 14" Deluxe Power Brush **\$219.99**
Electric-Driven Powerhead With Headlight, Automatic Electronic Brush Torque Control With Overload Reset Button, 14" Wide Carpet Brush, Built-In Dry Squeegee
- E LNMV179B** 12" Air-driven Turbo Brush **\$124.99**
Air-Driven Turbo Powerhead With 12" Wide Carpet Brush
- F LNMV251** Adjustable Carpet/Floor Tool **\$23.99**
For vacuuming carpets or floors

- TOOLS**
- LNMV251** Adjustable Carpet/Floor Tool **\$23.99**
- LNMV252** Floor/Wall Tool **\$12.99**
- LNMV253** Crevice Tool **\$1.99**
- LNMV254** Dusting Brush **\$3.99**
- LNMV256** Upholstery Tool with Brush **\$3.99**

- LNMV258** On-board Tool Caddy **\$4.99**
- LNMVCD** Deluxe Canvas Tool Caddy **\$8.99**

- WANDS**
- G LNMVTC** Metal Telescopic Wand with Cord **\$36.99**
Metal Telescopic Wand With High-Voltage Cord Management For Use With Crushproof Hoses V510PS & V610PS; Use With Electric Powered VM458 14" Deluxe Power Brush
- H LNMVTE** Metal Telescopic Wand **\$23.99**
Metal Telescopic Wand For Use With Crushproof Hose Model V400S; Use For Models VM178 & VM179B Air-Driven Turbo Carpet Brushes & All Other Non-Electric Powered Tools & Brushes
- LNMVTEP** Telescopic Wand **\$18.99**
Plastic Telescopic Wand For Use With Crushproof Hoses Models V222, V361, & V400S; Use For All Non-Electric Powered Tools & Brushes

REPLACEMENT BAGS & FILTERS

- LNMV6006** Disposable Paper Vacuum Bags **\$14.99**
5.8-Gallon Slide-Gate Bags For AVP Series, 6 Pack
- LNMV502** Disposable Paper Vacuum Bags **\$21.99**
11-Gallon Disposable Paper Bags For Blue & Gold Series (Except BV2000), 6 Pack
- LN226117** Filter Bag **\$59.99**
Replaceable Filter Bag For AV2500, AV3500, AV4500, AV5500, ZV3500, AVP & AVR
- LNMV600** 6x6" Secondary Foam Filter **\$59.99**
- LNMV601** 8x8" Secondary Foam Filter **\$59.99**

INSTALLATION

VACUUM TUBING

- LNMV1018** PVC Tubing (2" OD x 8'; shipped in 8 piece package, 64' total) **\$44.99**
- NU300MTL** Metal Tubing (2" OD x 8') **\$39.95**
- NUCF367** Flexible Tubing (2" ID x 36" vinyl over steel wire, interwoven with nylon cord) **\$14.95**

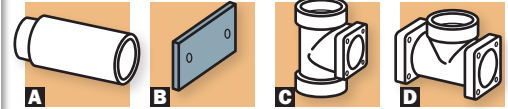

- A NU399** Extension Sleeve **\$4.95**
- B NU378** Nail Plate **\$0.85**
- C NUCF364** Flanged Tee **\$4.35**
- D NUCF365** Double-Flanged Tee **\$4.35**

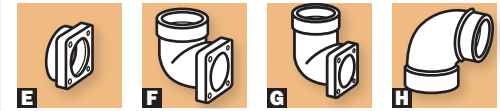

- E NUCF366** Straight Flange **\$2.55**
- F NUCF362** 90° Flanged Ell (standard) **\$2.85**
- G NUCF363** 90° Flanged Ell (for 3" walls) **\$4.35**
- H NUCF368** 90° Street Ell **\$2.55**

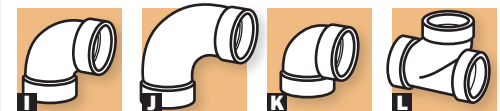

- I NUCF382** 90° Sweep Ell **\$2.05**
- J NUCF377** 90° Sweep Ell (long) **\$2.55**
- K NUCF382S** 90° Sweep Ell **\$2.05**
- L NUCF383** 90° Tee **\$3.95**



- M NUCF382XS** 90° Ell (short) **\$3.25**
- N NUCF386** 30° Ell **\$3.95**
- O NUCF385** 45° Ell **\$2.05**
- P NUCF369** 45° Street Ell **\$2.55**



- Q NUCF387** 45° Wye **\$4.35**
- R NUCF384** 3-Way Ell **\$6.85**
- S NUCF389** End Cap **\$1.85**
- T NUCF388** Stop Coupling **\$1.05**

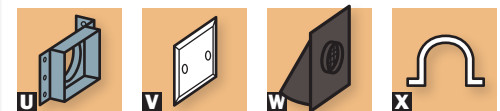

- U NUCF361** Mounting Bracket **\$7.15**
- V NU394** Blank Cover Plate, White **\$3.75**
Used In Place Of Wall Inlet In Speculative Installations
- W NU393** Metal Wall Cap **\$10.95**
- X NUCF380** Pipe Support with wire clip **\$1.65**
- NU379** Solvent Cement **\$5.45**

Smart Thermostats

HAI COMMUNICATING THERMOSTATS

HAI OMNISTAT2

Using advanced digital technology, the Omnistat2 learns your home's heating and cooling patterns and adjusts control to maximize both your HVAC's efficiency and your family's comfort.

- The backlight comes to life as you approach, making it easy to adjust in the dark - with more than 100 customizable backlight colors
- To adjust the temperature, simply turn the scroll wheel to the right or left
- 3 buttons facilitate easy to navigate menus to display information
- Selectable simplified and advanced displays
- Supports 1 indoor/outdoor temperature sensor
- Colors: Choose White, Silver or Black

Comfort

- Digital precise temperature control
- Automatic heat/cool changeover
- Fan mode periodically circulates air for comfort
- Indoor sensor averaging with remote sensor
- Humidity Control (with HARC2000)
- No batteries needed to retain settings and time

Energy Management

- Learns how your home heats and cools to control the equipment for efficiency and comfort
- Graphical display of HVAC usage, by week

OMNISTAT ACCESSORIES

- A HA23A001** Remote Indoor Temperature Sensor, Surface Mount **\$39.95**
- B HA23A002** Remote Indoor Temperature Sensor, Flush Mount **\$44.95**
- HA14A008** Water Temperature Sensor **\$84.95**
- HA31A007** Extended Range Indoor/Outdoor Temperature Sensor **\$49.95**
- HA31A008** Extended Range Indoor/Outdoor Temperature/Humidity Sensor **\$99.95**
- HA29A001** Omnistat Relay Isolation Module **\$64.95**



- 7 day schedule with copy function
- Filter reminder for peak efficiency
- Built-in vacation mode feature - restores temperatures before arriving home

Communication

- Communicates with HAI home control systems and other automation systems
- Remote Internet and phone access (optional)
- Expansion port for wireless communication

HARC1000xx Omnistat2 **\$264.95**

1-Stage Conventional & Heat Pump

HARC2000 Omnistat2 **\$309.95**

Multi-Stage & Heat Pump With Humidity Control

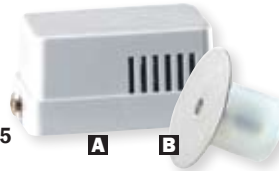

APRILAIRE

APRILAIRE COMMUNICATING TOUCHSCREEN THERMOSTAT

The Aprilaire 8800 Thermostat adds a touch of class to any décor, provides comfort your customers expect and is easy to install.



- Large touch screen with adjustable backlight - constant backlight available.
- Message center provides feedback.
- 7 day programmability or separately programmable weekday/weekend schedules.
- Thermostat can be removed from the wall for easy programming (batteries must be installed).
- Front battery door access for easy replacement.
- Displays room temperature, room humidity, temperature setting and outdoor temperature.
- Programmable fan control with circulation mode.
- Easy to use temperature control can override program schedule at any time.
- Progressive recovery ensures proper temperature at the start of a program event.
- Built-in compressor protection prevents damage to your equipment.
- RS485 communications ready.
- Universal system compatibility.
- Controls a humidifier and dehumidifier.

RP8800 Aprilaire 8800 Communicating Thermostat **\$344.95**

EXPANSION MODULES

- RP8051** Flush Temperature Sensor **\$22.95**
- RP8052** Outdoor/Duct Temp Sensor **\$8.35**
- RP8081** Temperature Support Module **\$84.95**
- RP8082** Humidity Sensor Module **\$144.95**
- RP8819** Wiring Distribution Panel **\$149.95**

Supports Up To 8 Thermostats

APRILAIRE PROGRAMMABLE THERMOSTAT

Offering an unprecedented level of control, the Aprilaire Programmable Thermostat gives you state-of-the-art control over your home's heating and cooling system.



The slim profile, ultra-sleek design offers unsurpassed performance, premium features and benefits, and is compatible with virtually all equipment types, from single or multi-stage to heat pump or hydronic systems.

RP8570 Aprilaire Programmable Thermostat **\$164.95**

» www.homecontrols.com/Aprilaire

Did you know 56% of the home's energy bill is just for heating and cooling? Save up to 10% with a programmable thermostat that automatically adjusts the temperature.

RCS

RCS COMMUNICATING THERMOSTATS

The RCS RS485 Communicating Thermostat with HVAC Control Unit is designed to control the majority of HVAC systems. It contains a robust thermostat interface and an HVAC control unit, both designed for use with home communicating systems (security, automation, etc.) where thermostat remote control and/or remote monitoring are desired.

- Remote control of all thermostat functions: supports up to two remote sensors
- Local temperature, heating/cooling setpoints, and fan mode displays on a backlit LCD
- On-screen setup of Type, Fan Type, Changeover type for HP systems, F/C mode and sensor calibration
- Text messaging via network



- Includes SmartVent Fresh Air venting and Fresh Air damper control

RCTR65 Serial Thermostat **\$249.95**

Includes HVAC Control Unit & Wall Display Unit



Integrate your HVAC Controls Into Your Home Automation System With The RCS Z-Wave Thermostat. See Page 18.



RCS RD & RDM Dampers: Ideal for HVAC zoning or switch applications, allowing for variable damper blade positioning. » www.HomeControls.com/RCS

Draperies & Windows

TOP SELLER: MAKITA DRAPERY OPENER SYSTEM

MAKITA DRAPERY OPENER

When you want the best quality drapery opener system, Makita is the choice.

- Configure for Right, Left or Center Pull
- Not just a motor – a complete system
- Reliable matched components and direct drive
- Clutch allows for manual operation
- Timer is included for programming the system to open and close up to 4 times per day
- Remote operates drape from up to 32' away
- Home theater masking is possible through the contact closure interface
- Rated for a minimum 30,000 openings/closures



EASY INSTALLATION: Installation is as easy as installing any traverse drapery rod. Just install the rod, clip the motor onto the rod & plug it in to any standard 115V electrical outlet.

Makita

MAKITA AUTOMATIC DRAPERY OPENER KITS

All kits include motor, timer, remote control, rod assembly, tracks, mounting brackets and installation video

- MKDRP20** Makita Drapery Opener Kit, 9' Single Rod **\$759.95**
- MKDRP21** Makita Drapery Opener Kit, 18' Single Rod **\$804.95**
- MKDRP22** Makita Drapery Opener Kit, 9' Double Rod **\$1254.95**
- MKDRP23** Makita Drapery Opener Kit, 18' Double Rod **\$1344.95**

Drapery Tracks Subject To Dimensional Weight Shipping Costs.

AUTOMATIC DRAPERY OPENER ACCESSORIES

- MKZZAR9** Rod Assemble, 9' with 32 Carriers **\$169.95**
- MKZZAR20** Rod Assemble, 20' with 64 Carriers **\$209.95**
- MKZZCM101** Drapery Motor (Parent) **\$434.95**
- MKZZCM301** Drapery Motor (Slave) **\$374.95**
- MKZZCT10** Timer **\$84.95**
- MKZZRC10** Remote Control, 1 Motor **\$29.95**
- MKZZRC20** Remote Control, 2 Motors **\$29.95**
- MKZZRC30** Remote Control, 3 Motors **\$29.95**
- MKZZRC60** Remote Control, 4-6 Motors **\$69.95**
- MKZZ3SWCBWH** Wall/Ceiling Single Bracket **\$21.95**
- MKZZ6DWCBWH** Wall/Ceiling Double Bracket **\$29.95**
- MKZZ6SJWH** 6" Joint for Splicing Track **\$5.95**
- MKZZ32R** Carriers, 32 Pack **\$18.95**

Home Controls Carries The Complete Line Of Makita Accessories » www.HomeControls.com/MakitaUSAInc

ADD-A-MOTOR

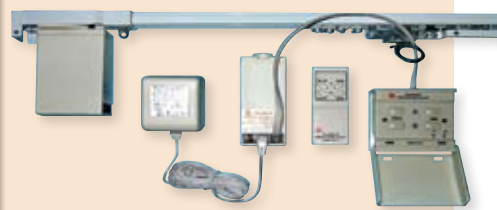

ADD-A-MOTOR DRAPERY OPENER

Ideal for home theaters, window treatments, church baptisteries and convention booth curtains. Permits hardwire connection to third-party devices that have timer controlled dry contact relays. These controllers can open and close a drapery on a time schedule. Motor can also be controlled by IR emitter, and learning remote control.

- Heavy duty motors offer quiet, reliable operation. Electronic adjustment can increase motor power to gather heavy fabric into a smaller pocket.
- Precision engineered and approved for commercial and residential use. Supplied with roller-carriers for smooth operation. Carrier eyelets accept curtain pins and hangers.
- Easy installation. Aluminum track can be cut to the desired length. Motor can be oriented on either end of track. All tracks center-opening; convertible to one-way opening.

AD1000 Remote Drapery Track, 10' **\$389.95**

AD2000 Remote Drapery Track, 20' **\$599.95**

Both Kits Include IR Remote Control, Wall Control Switch (No AC Wiring Needed), Wall & Ceiling Mounting Hardware & Power Supply With 12' Cord

OPEN & CLOSE WINDOWS – EVEN SKYLIGHTS!



VEGA WINDOW CONTROL SYSTEM

Simple and efficient motor system mounts directly to bottom- or top-hinged window or skylight.

- Low profile aluminum case
- 17.75" L x 1.8" W x 1.25" T with 12" stainless steel chain operator
- Colors: Choose Black, Gray or White

UC40900x Vega Actuator Motor **\$484.95**

UCSW56572W Vega Motor Wall Switch **\$49.95**

More Options & Configurations Online » www.HomeControls.com/DoorandWindowControl

SENTRY II WLS SYSTEM

The Truth Hardware Sentry II WLS Power Window System is for casement and awning windows. A low profile design and quiet running motor are two of the exciting and powerful features engineered into this motorized system. Sentry II Power System is suitable for on-site installation on windows that have Truth Hardware manual operators.

- 9.9" L x 2.9" W x 2.5" T

TR435100005 Sentry II WLS System **\$584.95**

Includes Motor, Wall Box With Faceplate & Rain Sensor

TR12490xx WLS Motor Cover (required) **\$15.95**

Choose Black, Bronze, Chestnut Bronze, Beige or White.

TR435300002 WLS Remote Control (optional) **\$149.95**

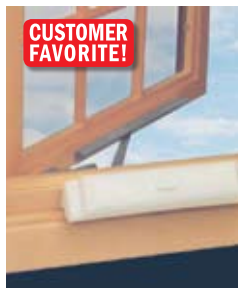

CUSTOMER FAVORITE!

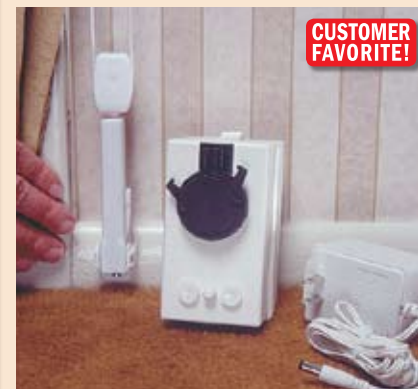

CUSTOMER FAVORITE!

ADD-A-MOTOR SYSTEM

AUTOMATIC DRAPE CONTROLLER

Add a motor to existing Drapery or Vertical Blinds. Installation takes about 15 minutes. The motor attaches to the loop end of your window covering cord or chain without modification. It can traverse drapery or vertical blinds up to 12' wide.

AD80 Automatic Drapery Controller **\$99.95**

ASDW18 Skylink Remote Kit **\$24.95**

Adds remote control for your drapes



HOME HEALTH tech

BY HOME CONTROLS

People have a desire to remain independent in their own homes. A bit of technology from **Home Health Tech by Home Controls** can provide a safer and healthier environment. Independent Living means improved convenience for you or a loved one with special needs – such as the elderly, individuals with specific challenges or impairments, and those living with disabilities. Home Health Tech provides digital health systems, covering safety and security, personal health, communication, cognition and more. Find improved quality of life with residential technology whether you have low vision or blindness, are hard of hearing or deaf, mobility impaired, physically challenged or simply enjoying your golden years.

phone orders **1-888-220-7690** online orders www.HomeHealthTechStore.com

GrandCare Systems

WHERE HOME TECHNOLOGY MEETS CARING

GrandCare offers the most feature-packed wellness and communication system on the market today. It combines aspects of smart home, online communications, and healthcare in one user-friendly and affordable package.

GrandCare is a touchscreen placed in the loved one's home. The system provides access to news, weather, pictures, email, reminders and more with the touch of a finger. They can also play games, search the Internet, listen to music and other interactive activities to improve their cognitive mind.

When a loved one's medical condition requires enhanced attention, family members and caregivers can activate the activity and wellness monitoring and alerts. The unit communicates with a wide range of unobtrusive sensors and wellness devices, which monitor activities of daily living and wellness. Monitor door openings, blood pressure, weight, medications, wake-ups and more. The system can then be accessed by family and caregivers using the web-based interface to assess the wellness and safety of the resident. The system can also be instructed to send an alert email, text message or phone call to caregivers if something is amiss.

GrandCare is fully customizable, expandable and moderately priced. It is professionally installed with little



or no new wires, and seniors need no technical or computer expertise to use GrandCare!

- Simple to set up and easy to use.
- Customized to fit any individual's needs.
- Flexible and expandable.
- Low-cost option for independent living.
- No technical expertise required!

MEDICATION REMINDERS

MED-E-LERT

Med-E-Lert is a cost-effective automatic pill dispenser that assists with medication compliance. It helps organize medications, reminds you when it's time to take each dosage, and makes sure you don't take the wrong ones.

Organize your daily medications in Med-E-Lert's 28 compartments and then set the clock for medication reminder times – for either once a day or up to four times per day. When it's time to take your medications, the system gives you access by turning the dial, and alerts you with a buzzer alarm and flashing light. The alarm continues for 30 minutes or until you take your medication. To stop the alarm and dispense the pills, pick up Med-E-Lert and tilt it over, dumping the pills into the hand or a suitable container.



GMMEQB0903B Med-E-Lert **\$69.95**

MEDFOLIO

MedFolio signifies a time when the old-fashioned "pill box" meets the 21st century. Stylish and sleek, MedFolio will alert you to take your next dose of medications by an audible sound and a unique visual LED-lighting system. Receive your medication reminders by email or text messaging. Plus, a one of a kind built-in medication identification system is right at your fingertips.



MF1001 MedFolio **\$248.00**

Monitoring service optional.



MEDREADY

When it's time to take your medication, MedReady rotates an internal pill box and unlocks the door. It's easy to use and can be programmed for up to four times a day.

- Choose from basic model, or with flashing Light and Low Frequency tones.

MR1600 MedReady, Standard model **\$149.00**

MR1650 MedReady, Modem model **\$196.00**

Monitoring service required.

Personal Alerts



FREEDOMALERT

FreedomAlert is your personal link to family, friends or caregivers. FreedomAlert allows you to program up to four phone numbers to be reached at the push of a button.

LM35911 FreedomAlert **\$279.95**

GUARDIANALERT 911

Talk directly through your GuardianAlert pendant to a 911 operator at the push of a button. The system can operate anywhere in and around the home!

LM30911 GuardianAlert **\$149.95**

LIFESENTRY

LifeSentry is the ultimate PERS. LifeSentry allows you to communicate your message instantly within many hundreds of feet.

LifeSentry is a professionally-installed model, and calls a central station (service fees may apply).

LM37911 LifeSentry **\$299.95**

FreedomAlert and GuardianAlert 911 require no activation, contracts or monthly fees.

LINEAR PERSONAL EMERGENCY REPORTING SYSTEM

The PERS-4200 brings forth a new generation of Personal Emergency Reporting Systems. Linear, one of the leaders in PERS equipment innovation, delivers advanced features and options to suit any customer with its latest offering.

The PERS-4200 Personal Emergency Reporting System is a supervised wireless emergency reporting device for medical alert applications. The main console provides push button emergency assistance to anyone who desires additional security and peace of mind. For the visually impaired, each button on the Console is molded with braille characters to identify the button's function.

- Up to 1,000' range with Linear long range transmitters
- Add-on modules for expansion
- Improved Supervision and Activity Timer
- Selectable multi-lingual software suites
- System event log with remote dealer access
- Upgradeable firmware

LNPER4200 Linear PERS-4200 Personal Emergency Reporting System **\$270.00**



Several Custom Add-On Accessory Options Available!

PORTABLE PERSONAL ALERTS

GREATCALL 5STAR URGENT RESPONSE

Whether you're experiencing mild anxiety or an immediate emergency, the 5Star personal urgent response system is always there for you. Wherever you go, with the simple press of a button, you can either immediately call 9-1-1 or connect with a 5Star Agent who is ready to communicate with you and quickly dispatch any assistance you need. The compact, discreet, and GPS-enabled 5Star conveniently attaches to your keychain, purse, backpack or belt to prepare you for any unsafe or uncertain situation.

- Nationwide coverage with GPS location tracking

GT5STARX GreatCall 5Star Urgent Response **\$36.96**

Monthly service required.



SUREPOD EMERGENCY ALERT SYSTEM

Unlike home-based alert systems, this portable device gives you peace of mind in and out of your home. Simply slip the compact device into your pocket or hang it from your key chain. If you need help, press the emergency button. It's always there for you, and always easily activated.

- Works anywhere there is cellular coverage
- Single-button emergency activation
- 2-Way Talk allows communication with emergency responders
- GPS automatically pinpoints your location

SUREPOD SurePod Emergency Alert System **\$79.99**

Monthly service required.



WANDERER ALERTS



FREEDOM

The Freedom GPS locator watch has been designed exclusively to make sure adults and seniors with health issues, such as Alzheimer's, stay safe.

A loved one wears a stylish watch. When the Freedom watch is in close proximity to the portable receiver, it uses RF mode; when it is out of range, it automatically switches to GPS or GSM (Satellite or Mobile technology) to find its location. Freedom is accurate within 10' outdoors!

LKFFREEDOM Freedom GPS Locator **\$599.00**



TRAXXIT360

With Traxxit360, you can keep the people near to your heart, close to your home. The Traxxit360 is one of the smallest and lightest GPS tracking devices in the market today. These devices are ideally suited for children, teenagers and adults with special needs. A great wandering alert system!

The Traxxit360 is a compact, electronic, keychain-size tracking device that wirelessly connects to mobile communications networks using the Global Positioning Satellite (GPS) system to locate the device. You can locate the device using a secure browser-based portal, or through the use of a smart phone application. It can locate the device with an accuracy of less than 3 meters.

- Outside use only.
- Colors: Available in Black with Grey sides, Silver with Black sides, and Red with Black sides. Additional colors available by special order.

TXT3600* Freedom GPS Locator **\$149.95**

Communication Systems

COMPUTERLESS EMAIL PRINTER

PRESTO COMPUTERLESS EMAIL

While most seniors prefer to stay in their own home as they age, loneliness can be an issue. And if they are among the 58% of adults over 65 who don't go online, keeping in touch with family and friends can be difficult. With Presto computerless email, seniors can receive email, digital photos, and other documents without the hassle and expense of a computer or Internet connection.

HOW IT WORKS

Anyone on the approved senders list simply sends email just like they would to anyone else. Presto transforms the messages into beautiful, easy-to-read e-letters, and prepares them for delivery. Up to five times per day, on a schedule you choose, the Printing Mailbox dials into the Presto service to check for messages. If there are messages, they are automatically printed. There is nothing the senior needs to do - no mail program to log on to, no attachments to download - they don't even need to push a button. They simply pick up the automatically printed messages, read and enjoy!



- No spam
- No computer or Internet needed
- Connects to the existing analog phone line
- Selection of puzzles and articles available

PRESTOPM10 Presto Computerless Email **\$99.99**

A subscription to the Presto Mail service is required.



AMPLIFIED TELEPHONES

ULTRACLEAR AMPLIFYING SPEAKERPHONE

The UltraClear Amplifying Emergency Connect Speakerphone is all about preparedness. In addition to providing an amazing amplified phone, the remote pendant provides additional assistance. With the pendant, the phone acts as an alert system, calling up to 5 pre-programmed numbers when the emergency button is pushed. You can also answer and hang-up a call through the pendant.

- 50 dB amplification with full range tone control
- Amplified speakerphone in base
- 104 dB adjustable extra loud ringer and visual ringer
- 5 one-touch speed dials, 1 voicemail speed dial, and 1 large one-touch emergency dial button

CLCSC600ER UltraClear Amplifying Phone **\$149.95**



[More Telephone Choices Online »](#)
HomeHealthTechStore.com/HHT-Amplified-Telephones



RINGER WITH STROBE

KMRA05 Krown Amplified Ringer with Strobe **\$39.95**



AMPLIFIED PHONE COMBO

AM92445 PowerTel Amplified Phone Combo Kit **\$149.95**



AMPLIFIED CORDLESS PHONE

AM92438 PowerTel 580 Amplified Cordless Phone **\$99.95**

TV LISTENING DEVICES



TV EARS

TV Ears manufactures doctor-recommended television listening solutions. These solutions have helped more than one million people hear the television clearly and once again enjoy what they are watching bringing families back together.

The system works with Plasma and LCD flat screen TVs, even in the presence of fluorescent lighting. This system covers up to 600 sq. ft.

TV Ears Tips provide an acoustically sealed chamber that reduces room noise and provides comfort and clarity for outstanding word discrimination so that TV dialog is clear and understandable.

TV11341 TV Ears Wireless System **\$129.95**

Includes Rechargeable Wireless Headset, Transmitter, Rechargeable Battery, Power Supply & Audio Cord

TV EARS ACCESSORIES

TV40707 TV Ears Foam Ear Tips (5-Pair) **\$24.95**

TV40710 TV Ears Silicone Ear Tips (5-Pair) **\$24.95**

TV40701 TV Ears Alternate Installation Kit **\$24.95**

For TVs that do not have audio out ports.

MAIL ALERT SYSTEM

MAILCHIME

No more wondering if the mail is gone and no more wasted trips to the mailbox just to find it empty. Simply mount the sensor on your mailbox door using double sided tape (included) and plug the Receiver into an electrical outlet anywhere in your home.

When the mailbox door is opened, the Mail Chime will beep four times. And, in case you missed the beeps, a bright red LED light will tell you the mail has been delivered. You'll love the convenience of knowing when your mail is delivered.

HP1200 MailChime **\$49.95**



KITCHEN STOVETOP FIRE PREVENTION SYSTEM

COOKSTOP

Unattended cooking is a top cause of fires in residences. Prevent your loved ones from being part of the statistics. CookStop continuously checks for movement in the kitchen. If the resident leaves the room, or falls asleep, CookStop shuts the stove off.

Is an unattended pan heating on a stove in a residential unit you manage – right now? Is someone asleep with the stove on? Did they get distracted talking on their cell phone and step away from cooking? CookStop can be watching for you – and shut down that fire risk!

CookStop is a proactive solution, stopping the cause of the fire. Smoke detectors, alarms and sprinklers are reactive solutions – by the time they activate, smoke, flames, and risk are already present.

CookStop is peace of mind and reduced risk for residents, property managers, and owners.

- Single family residences
- Senior apartment complexes



- Independent living residences
- Multi-family retirement communities
- Continuing care retirement communities

CSCSA*WPIRF Cookstop Fire Prevention **\$359.00**

Choose 3- or 4-Prong Configurations.

Personal Health

BRAIN FITNESS

DAKIM BRAINFITNESS

Now you can keep your mind sharp with award-winning Dakim BrainFitness Software for both PC and Mac, available at Home Controls. It's designed specifically for Boomers and Seniors to cross-train the brain in six cognitive domains and strengthen attention, focus and concentration.

Dakim's challenging brain games – based on standardized neurological exercises and tests – are like no others. Created for adults, they are engaging, sophisticated, richly produced and filled with videos, music, exciting graphics and humor that make every session fun ... for adults! No cartoons, child-like themes or robotic voices!

Dakim BrainFitness self-adjusts across five levels of challenge in real time to optimize every brain fitness workout for active individuals with the highest brain function as well as those with mild cognitive impairment.



Dakim BrainFitness is more than fun – it's been shown in a clinical trial to improve memory!

With Dakim BrainFitness, it takes just 20 minutes, 3-5 times a week, to get a cross-training workout that exercises all six cognitive domains.

DKDBX0112HKA Dakim BrainFitness **\$209.95**

Includes CDs for Mac & PC, Headphones & Instructions.

WIRELESS HEALTH MONITORING SYSTEM

WELLNESS CONNECTED

This combo pack contains the tools you need to get moving toward better health at any stage in life. Through daily tracking of blood pressure, weight and physical activity, you can become aware of your personal progress and take a proactive approach to caring for your health. The Wellness Connected software application automatically receives your measurements and graphs it in a user-friendly interface.

With ActiHealth (optional subscription), you can view your wellness data from any computer and even remotely track the progress of family and friends.

ANUC324THX A&D LifeSource Wellness Connected Precision Scale **\$119.95**

ANUA851THX A&D LifeSource Wellness Connected Blood Pressure Monitor **\$124.95**

ANXL10 A&D LifeSource Wellness Connected ActiLink **\$39.95**



More Options & Configurations Online » www.HomeHealthTechStore.com/HHT-Personal-Healthcare

SEE & RECORD WHO'S AT THE FRONT DOOR

BRINNO PEEPHOLE VIEWER

Clearly see who is at your door with the Brinno PeepHole Viewer. This powerful viewing system turns a hard to see door peephole into a big and bright image by using an LCD panel to display who is at your door. It provides safety and security, plus convenience for individuals with mild to severe vision loss.

- Simple push button to see large image without darkening the peephole.
- Clear image in LCD Panel on door, easy to see for people of any height.
- Optional zoom feature.
- Compensation for low light images.
- Compensation for "fish eye" distortion.

BRPHV1330 Brinno PeepHole Viewer **\$129.99**



ALWAYS KEEP YOUR HEALTH RECORDS SAFE

MEDI-LOK STORAGE LOCK BOX

Never get locked out of your healthcare lockbox again. The Medi-Lok Storage Lock Box allows you to safely store up to five keys, so you or your loved one has reliable, secure access whenever needed. Medi-Lok is a must have for homes with medical alarms. Simply dial in the right combination code to open the built-in key compartment. With over 10,000 possible code combinations, your keys are safe all the time.

MLMEDILOK Medi-Lok Storage Lock Box **\$34.95**



ALL-IN-ONE FALL PREVENTION SENSOR

STANDDOWN

StandDown all-in-one self contained sensor offers caregivers the ultimate in convenience in every fall prevention monitoring situation. Simply place StandDown on a chair, bed or floor. Switch to On and monitoring begins automatically! The system will not alarm as long as the patient remains seated. If the patient attempts to stand, alarm will sound. If the patient sits again, alarm will stop, the system will automatically reset, and monitoring will resume.

USSD1 StandDown for Wheelchair (15"x18") **\$99.95**

USSD2 StandDown for Bed (18x25") **\$119.95**

USSD4 StandDown for Floor (15"x25") **\$149.95**



PRODUCT INDEX

Access Control Keypads	35	Intercoms	80, 81, 82, 83	HAI Omni	26
Amplified Phones	90	In-Ceiling Speakers	68, 69, 70, 71	Linear	33
Appliance Modules	12	In-Wall Controllers	19	Skylink	34
UPB	12	EnOcean	10, 11	Security Transmitters	36, 37
SimpleWorx	15	UPB	20	Selective Call Intercoms	81
X10	21	X10	16	Sensors, Wireless	30, 31, 34, 40
Z-Wave	17	In-Wall Speakers	68, 69, 70, 71	Sirens	38
Audio Cables	54	IP Cameras	46, 47	Smoke Detectors	42
Audio Distribution Systems	62, 63, 64, 65, 66, 67	iPad Wall Docks	25, 67	Software	29
Automation Systems	31	iPod/iPhone Docks	25, 64, 65, 66, 67, 78, 95	UPB	11
Elk M1	31	IR Distribution	76, 77	Z-Wave	17
HAI Omni	26	IR Extenders	76, 77	Speaker Installation	72
NavNet	25	IR-to-UPB Modules	14	Speaker Selectors	72
On-Q Unity	25	Label Printers	61	Speaker Wires	54
Backup Power	75	Lamp Modules	19	Speakers	68, 69, 70, 71
Bridges, X10/UPB	14	EnOcean	15	Sprinkler Controls	7
Bullet Cameras	46	SimpleWorx	12	Standby Power	75
Bundled Cables	54	UPB	21	Stovetop Shutoff Systems	91
Cable Access Wallplates	58, 59	X10	17	Stripping Tools	60
Camera Mounts	48	Z-Wave	7	Strobes	38
Cameras	46	LED Bulbs	28	Subwoofers	70
Bullet	46	Lighting Controllers	10, 11	Surge Protectors	75
Dome	47	Lighting Switches	15	Telecom Modules	50, 51, 53, 79
Dummy	46	SimpleWorx	19	Telephone Controllers, X10	21
Wireless	48	EnOcean	19	Telephone Entry	80, 81
Cameras, Power Supply	48	RF Wireless	20	Telephone Installation	79
Carbon Monoxide Detectors	42	X10	16	Telephones	78, 90
Card Readers	30, 35	Z-Wave	35	Temperature Monitors	42
Caregivers	88, 89, 90, 91	Locks	31	Termination Tools	60
Ceiling Speakers	68, 69, 70, 71	M1 Controllers	88	Test Equipment	60
Cellular Phone Amplifiers	78	Medication Reminders	37	Thermostats	86
Central Vacuum Systems	84, 85	Mid-Range Transmitters & Extenders	74	Timed Controllers, UPB	13
Chime Modules, X10	20	Modulators	39	Timer Switches	8
Coaxial Cables	54	Moisture Sensors	38	Tools	60
Computer Interface Modules, UPB	12	Monitoring Systems	9, 18, 19, 22, 23, 30, 32, 33, 34, 36, 37, 40, 41, 43, 44, 45	Transceivers, X10	22
Connectors	55, 56, 57	Motion Sensors	56, 57, 58, 59	Tuners	64, 67
Contacts	40	Multi-Media Kits	62, 63, 64, 65, 66, 67	TV Listening Devices	90
Crimping Tools	60	Music Distribution Systems	64	Unity Home System	25
Curtain Controls	87	Music Servers	25	UPB-to-EnOcean Modules	14
Data Modules	51, 53	NavNet	24	UPB-to-X10 Module	14
Dead Bolts	35	Network Adapters	21	Universal Remotes	77
Digital Keypads	35	Noise Block, X10	9	Vacuums	84, 85
Digital Modulators	74	Occupancy Sensor Switches	27	Vehicle Alert Sensors	43
Digital Video Recorders (DVRs)	47, 49	Omni Consoles	26	Hard-Wired	43
Dimming Switches	19	Omni Ile	26	Wireless	43
EnOcean	15	Omni LT	26	Video Balun	48
SimpleWorx	10, 11	OmniPro II	27	Video Door Phone	80, 83
UPB	20	OmniTouch	71	Video Matrix Switchers	74
X10	16	Outdoor Speakers	54	Video Modules	51, 52
Z-Wave	47	Patch Cords	89	Voice Alerts	44
Dome Cameras	47	Personal Assistance Systems	14	Voice Dialer Systems	39
Door Sensors	40	Phase Couplers, UPB	14	Volume Controls	72
Door Strikes	35	Phase Repeaters, UPB	43, 45	Wall Brackets	59
Doorbells	79	Photobeam Sensors	60	Wallplates	59
Drapery Controls	87	Pliers	75	Wanderer Alerts	89
Dummy Cameras	46	Power Conditioning Centers	12	Water Level Sensors	39
Electric Vehicle Recharging	8	Powerline Interface Modules, UPB	60	Wheel Chair Sensors	91
Enclosures	50, 52	Punchdown Tools	64, 67	Window Controls	87
Energy Monitoring	6	Radio Tuners	12	Window Sensors	40
EnOcean RF Wireless Lights	19	Receptacles	15	Wireless Access Points	53
Entry Alert Systems	43, 44, 45	UPB	21	Wireless Controls	27
Fixture Dimmer Modules, UPB	12	Wireless	19	OmniTouch	19
Fixture Relay Modules, UPB	12	X10	16	RF	15
Glassbreak Sensors	41	Z-Wave	77	SimpleWorx	22
GPS Watch	89	Remote Controls	22	X10	22
Handheld Controllers	19	Universal	17	Z-Wave	17
EnOcean	22	X10	22	Wireless Doorbells	79
X10	17	Z-Wave	17	Wireless Lights	9
Z-Wave	54	Scene Switches	10, 11	Wireless Receivers	31, 32, 36, 37
HDMI Cables	73	UPB	20	Wireless Switches	15
HDMI Distribution	57	X10	16	Wireless Transmitters	31, 32, 36, 37
HDMI Wallplates	42	Z-Wave	36, 37	Wires	54
Heat Monitors	88, 89, 91	Security Receivers	34	X10-to-UPB Module	14
Health Monitoring Systems	38	Security Systems	31	ZigBee	6
Home Monitoring Systems	88, 89, 90, 91	AirAlarm	32		
Independent Living	12	Elk M1			
Input/Output Modules, UPB	56, 57	GE NetworX			
Inserts					

Don't see what you are looking for? Log on to www.HomeControls.com or call 1-800-266-8765!

MANUFACTURER INDEX

• Green Dot Indicates New Products

VENDOR	PRODUCTS	PAGE	VENDOR	PRODUCTS	PAGE		
AA	Arlington Industrial	Wallplates & Outlets	55, 58, 59	MC	Microsmith, Inc.	Hot Link IR Receiver	77
AC	American Communications	Door Answering Systems	80	MD	MicroSystems Development	Musical Doorbell	79
AD	Add-A-Motor Inc.	Drapery Motors	87, 95	MI	Monterey Instruments	UPB & X10 Devices	14, 21
AE	Aeon Labs	Z-Wave Devices	17, 18	MF	MedFolio	Medication Organizers	88
AI	Andev	Occupancy Sensors	9	MK	Makita, U.S.A.	Drapery Controls	87
AM	Amplicom	Amplified Phones	90	ML	MediLock	Personal Lock	91
AN	A&D / LifeSource	Home Health Devices	91	MP	Channel Plus	Video Distribution & Modulators	74
AT	Applied Digital Inc.	Computer Automation	24	MR	MedReady	Medication Organizers	88
BE	Buffalo Electronics	Audio Distribution Controls	72	MS	M&S Systems	Intercom Systems	83
		IR Distribution	76	MX	Maxsa	Lighting Controls	9, 95
BR	Brinno	Peephole Viewer	91	NA	CableTronix	Modulators	74
CG	(C2G) Cables To Go	HDMI Distribution Systems	73	NM	NetMedia	Modulators	73, 79
CI	Cross Point Industries	Entry Alert System	44	NN	NavNet	Home Automation	25
CL	ClearSounds	Amplified Phones	78, 90	NP	Napco Security Systems	Sensors	41, 42
CS	CookStop	Stovetop Fire Prevention	91	NU	NuTone	Wireless Doorbell	79
CV	Channel Vision	Surveillance Cameras	46, 47, 49	NV	NuVo	Audio Distribution Amplifiers	62, 63, 64, 66
		Wallplates, Jacks & Outlets	56, 57, 58	OE	OEM Systems	Wallplates, Jacks & Outlets	55, 57, 59
		Audio Distribution	67			Speakers	68, 69, 70, 71
		IR Distribution	76, 77	OP	Optex Inc.	Audio Distribution Controls	72
		Phone/Intercom Systems	80, 82			Vehicle & Motion Alerts	44
DA	Dakota Alert	Vehicle & Motion Alerts	43, 44	OQ	On-Q	Video Door Phone	80
		Surveillance Cameras	47			RF Wireless Lighting	19
		Wireless Doorbell	79			Unity Home System	25
DC	DFE Communications Corp.	Intercom Systems	81			Surveillance Cameras	48
DK	Dakim	Brain Fitness	91			Structured Wiring & Networking	52, 53
DQ	DynaQuip Controls	Flood Protection	39			Wallplates, Jacks & Outlets	56, 57, 58, 59, 60
DT	DataComm	Wallplates & Outlets	55, 58			Audio Systems	66
DY	Dymo	Label Printers	61			Speakers	70, 71
DZ	DreamZon	Smartphone Devices	95	PC	PCS / PulseWorx	Intercom Systems	81, 82
ED	EcoDog	Energy Savings Devices	6			UPB Devices	11, 12, 13, 14, 19
EL	Elk Products	Relay Devices	24			SimpleWorx Devices	15
		Home Automation	31	PH	Phonetics, Inc.	Remote Home Monitoring	38
		Security	38, 48	PL	Platinum Tools	Connectors & Tools	55, 60
		Phone Distribution	61, 79	PP	Professional Partners	Speaker Insulation	72
FS	Foard Systems Design	UPB/X10 Bridges & Controllers	14	PR	Presto	Computerless Email Printer	90
GA	GrandCare	Independent Living	88	RC	RCS	X10 & Serial Relay Controllers	24
GC	Global Caché	Network Adapters	24			Thermostats	18, 86
		Wireless Adapter	74	RK	Rokonet Industries	Motion Sensors	41, 45
		IR Distribution	77	RP	Aprilaire	Thermostats	86
GD	Grace Digital	Wi-Fi Tuner	67	SA	Simply Automated Inc.	UPB Devices	10, 12, 13, 14
GE	GE Security	Security	32, 40, 41, 42	SC	SpeakerCraft	IR Distribution	76
GT	Great Call	Personal Alerts	89	SE	Seco-Larm	Security	35, 36, 39, 40, 44, 45, 60
HA	HAI	ZigBee Wireless Control	6			Surveillance Cameras	46, 47, 48
		UPB Devices	11, 12, 13, 14	SK	Skylink	Lighting Controls	15, 23
		Home Automation	26, 27, 28, 29, 30			Security	34, 45
		Surveillance Cameras	46, 47, 49	SP	Speco	Security & Surveillance	38, 48, 49
		Audio Distribution	65	SR	Structured Cable Products	Wire & Cables	54
		Thermostats	86			Wallplates, Jacks & Outlets	57
HP	Hanna Products	Mail Box Sensor	91	SS	Street Smart Security	Wireless Devices	37
HZ	Heath-Zenith Company	Lighting Controls	9, 15	STI	STI	Security Sensors	44, 45
		Wireless Doorbell	79			Wireless Doorbell	79
		Z-Wave Devices	18	SU	SurePod	Personal Alerts	89
HS	HomeSeer	Batteries	30	TE	Transformative Engineering	HDMI Distribution	73
IB	Interstate Batteries	Batteries	30	TL	TekLink / SecurityMan	Security	34
IN	Inovonics	Security	37			Surveillance Cameras/DVRs	46, 48, 49
IO	iON Digital	Sensors	40	TP	Tripp Lite	Test Equipment	60
KM	Krown	Amplified Phones	90			HDMI Devices	73
KW	Kwikset	Access Control	35	TR	Truth Hardware	Powerline Conditioning	30, 75
LD	Light Emitting Designs	LED Lights	7	TS	TrickleStar	Window Control Systems	87
LE	Lee Electric, Inc.	Electric Door Strikes	35			Timers	8
LG	Letz Go Products	Sump Bobber	39			Z-Wave Devices	17
LK	Lok8u	GPS Watch	89			Surge Protection	7, 75
LM	LogicMark	Emergency Alerts	89	TV	TV Ears	Listening Devices	90
LN	Linear Corp.	Security	33, 35, 36, 37, 42	TX	Traxit	Wanderer Alerts	89
		Audio Distribution	65, 74	UC	Ultraflex Control Systems	Window Control Systems	87
		AirVac Central Vacuum System	84, 85	US	United Security Products	Sensors	39, 40, 42, 44
		Personal Alerts	89			Home Health Devices	91
LV	Leviton Manufacturing	Electric Vehicle Recharging Station	8	VM	Video Mount Products (VMP)	DVR Lockboxes	495
		Lighting Controls	9, 15	WG	WGL	UPB & X10 Devices	7, 22, 24
		Z-Wave Devices	16, 17	WH	Westinghouse	Intercoms	82
		EnOcean Devices	19	WI	Wilson Electronics	Cellular Phone Booster	78
		X10 Devices	20, 21, 22	WL	Winland Electronics Inc.	Sensors	38, 39, 40, 42, 43
		Surveillance Cameras	47	WM	Web Mountain	UPB Devices	13
		Structured Wiring System	50, 51, 54, 79	WT	Wagan Tech	Automotive Accessories	95
		Wallplates, Jacks & Outlets	56, 57, 59, 78	XP	X10	X10 Devices	20, 21, 22
		Speakers	71	ZM	ZOMM	Cell Phone Device	78
		Surge Protection	75				

Your Satisfaction Is Guaranteed!

For 23 years, Home Controls has been supplying homeowners and dealers with a wide variety of easy-to-install home automation products at competitive prices, and your satisfaction is guaranteed! We're not happy unless you are! And we back that up with:

HUGE PRODUCT SELECTION

This catalog is only the beginning of the wide variety of home automation and networking products available through Home Controls. If you don't see what you're looking for, visit our website or call 1-800-266-8765 – we'll be glad to help!

LOW PRICE GUARANTEE

We guarantee the lowest prices on items we sell! If you find a lower price from any other retailer or distributor, simply notify us within 30 days of your order and we'll gladly match it!

SAME DAY SHIPPING

Place your order by 3:00 p.m. PST, and we ship in-stock products the same day!

FREE PRODUCT ADVICE & TECH SUPPORT

We are committed to providing the best free technical support in the industry to help you with product advice, system design and of course, troubleshooting. Just call 1-800-266-8765 weekdays between 8:30 a.m. and 5:00 p.m. Pacific Time.

30 DAY REFUND

Our money back return policy guarantees you are happy with your product upon receipt, or we'll refund your money. See Terms and Conditions below

24/7 SHOPPING CONVENIENCE

Order any Home Controls product online at any time of day or night. Our website offers thousands of products with images and full detail. Visit www.HomeControls.com.



CUSTOMER SERVICE & TECH SUPPORT

1-800-266-8765

Monday - Friday, 7:00 a.m. - 5:00 p.m. Pacific Time

(Tech Support 8:30 a.m. - 5:00 p.m. Pacific Time)

Fax: 1-858-693-8892

THOUSANDS OF PRODUCTS ONLINE!

WWW.HOMECONTROLS.COM

Customer Service Email: service@HomeControls.com

Home Controls Blog: www.HomeControlsBlog.com

(Special Dealer Access Available – Call for Details)

RECOGNIZED LEADERS

CEA TechHome's Mark of Excellence Awards recognize the finest achievements in home automation. Each year manufacturers, distributors and installing dealers enter a competition that is judged by experts within the industry representing manufacturers, installing dealers, distributors and the media. Home Controls has been honored with three Mark of Excellence Leadership Awards. The Leadership Award is bestowed on a company that best personifies industry leadership. As the trade association of the home automation industry, TechHome has elected to acknowledge these leaders, and in doing so bestows a single award annually to the company and its executives. Home Controls is widely recognized for its leadership, time and financial contributions to the home automation industry.

TERMS & CONDITIONS

Payment Options: You may pay online or by phone with Visa, MasterCard, Discover, American Express and PayPal.

Money orders, checks, cashier's checks and wired funds are also accepted for phone orders only. Call 1-800-266-8765 for more information. Make checks and money orders payable to Home Controls, Inc.

Sorry, no COD orders are accepted.

Prices are subject to change without notice.

Shipping: Home Controls offers same-day shipping on in-stock products on most credit card orders received before 3 p.m. Pacific Time. Our huge inventory ensures the most timely delivery possible!

Post Office Box addresses are not accepted for online orders. Orders must be shipped to a physical street address. For Post Office Box options, contact Customer Service at 1-800-266-8765.

Our standard shipping method for domestic orders is by ground service. We also offer Second Day Air, Next Day, and Saturday shipping for an additional charge. Please specify when ordering.

Returns: To return a product, simply call our Customer

Service Department at 1-800-266-8765 to obtain the required CO (Credit Order) number. This number must appear on the outside of the shipment you make to us or it will not be accepted at our receiving dock. We recommend you insure your package, as we cannot be responsible for refund or replacement should your package get lost in shipment.

Merchandise returned within 30 days of purchase with the appropriate CO number will receive a full product cost refund or credit, provided it is in perfect unused condition in original undamaged and unmarked packaging, and is complete with all instructions and warranty card.

Defective products will be replaced or repaired according to the manufacturer's warranty policy. Call us at 1-800-266-8765 if you have any questions.

Shipping costs are not refundable, but Home Controls will pay the UPS ground freight to ship your exchanges or replacements of defective merchandise. Upgraded air shipping is available at customer expense.

Products not eligible for returns: Books, Plans and Software are not returnable due to copyright laws;

Wire products are not returnable; All sales on Surplus and Discontinued Products items are final, and are not returnable.

International Orders: Home Controls routinely ships products all over the world, and would like to do business with you. Online orders less than \$1,000 can be paid for by credit card, in U.S. currency, if issued by a U.S. bank or lending institution. All other orders must be paid for in advance with a money order, cashier's check, or wired funds. Cashiers' checks or money orders must be received prior to shipment and must be drawn on a U.S. bank. Wired funds must be received prior to shipment; call +1-858-693-8887 phone, +1-858-693-8892 fax, or send email to service@homecontrols.com to get instructions on wiring funds.

All duties, custom fees and any other fees are the responsibility of the customer.

International dealers are welcomed and encouraged to contact us for dealer pricing.

Questions? If you have any questions, just call our Customer Service Department at 1-800-266-8765 and a friendly, courteous representative will help you.

More Cell Accessories

CELL PHONE LIGHT SHOW

DREAMZON LIGHTON MOBILE PHONE SIGNALER

Tired of missing calls and texts? If your cell phone's notifications aren't quite cutting it, try the DreamZon LightOn Mobile Phone Signaler. When you receive a call or text, the signaler flashes a soft, glowing blue light to alert you. Simply set your phone to vibrate and place it in the LightOn cradle. It's that easy.

- Flashing bright LED light
- Comfortably conduct sign language calls
- Connects to external alert devices
- Low battery indicator
- Colors: Choose White or Black

DZHC DREAMZONx DreamZon LightOn Mobile Phone Signaler **\$79.95**



UNIQUE CELL CHARGERS

TURBOCHARGE

The Maxsa TurboCharge Universal is a portable and reusable backup power for your cell phone. Never run out of power when making or receiving an important call. Uses a single AA battery (included). Sleek aluminum-coated brass design is portable, storable and only the size of a lipstick tube!

- Includes 10 common phone adapters

MXTC400 Maxsa TurboCharge Cell Phone Charger **\$18.95**



SOLAR ePOWER

Using the latest in photovoltaic technology, the Solar ePower directly charges electronic devices as well as rechargeable AA and AAA batteries.

The Solar ePower is also capable of using alkaline batteries to directly charge electronic devices.

- Includes 5 common phone adapters

WT2053 Wagan Solar ePower **\$47.96**



ON THE ROAD

POWER DOME NX

All-in-One emergency and outdoor companion can be used to jump start your car engine, pump your tires, or inflate sports equipment. This power supply also has a radio, AC and DC power source, USB port, audio input socket, LED light, and a storage compartment.

- Functions: Portable & Rechargeable Power; 400Amp Cranking Power Jump-Starter; Heavy duty cables & clamps; 260 PSI air compressor; Tire pressure gauge; 2 AC outlets; 1 DC outlet; AM/FM radio; 1 USB port; LED lights; Storage Compartment

WT2485 Power Dome NX, 200W **\$119.96**



POWER DOME EX

Power Dome EX can be used as a power source for 110V AC or 12V DC applications such as computers, TVs, fax machines, audio, fans, electrical tools, etc. It can also start your car engine in an emergency situation.

- Functions: Portable & Rechargeable Power; 600Amp Cranking Power Jump-Starter; Heavy duty cables & clamps; 260 PSI air compressor; Tire pressure gauge; 2 AC outlets; 1 DC outlet; AM/FM radio; 1 USB port; Audio input socket; LED lights

WT2454 Power Dome EX, 400W **\$135.96**



APPS FOR iPhone, IPOD TOUCH & IPAD

Home Controls features a collection of home automation apps for your iPhone and iPod touch, all available through the iTunes Store. Control lighting and appliances, home automation controller, window coverings, security systems, irrigation systems, net cameras and so much more. These apps support X10, Z-Wave, UPB and more. Plus, enjoy complete control of your home's audio and video systems with several entertainment apps.

Shop Online » www.HomeControls.com/AutomationApps-iPhone-iPod-Touch



AUTOMATIC CHICKEN COOP MOTOR

CHICKEN COOP MOTOR

Add this motor to your chicken coop and it automatically opens and closes the door on a time schedule you choose. Simply plug it into your lamp timer switch and it protects your hens and eggs, and saves you valuable time every day.

- Includes motor, mounting hardware, AC-DC Adapter, lift-cable, and illustrated instructions.
- Works similar to a fishing reel. Has a reversible motor with adjustable stop settings. Motor stops door at open and closed positions you set.
- No counter-weight needed.
- Motor can lift and lower a door up to 5 pounds, with door openings up to 25". If your door swings open, then you can convert it to vertical lift by installing it in side-channels.

AD20 Chicken Coop Motor **\$109.95**



CUSTOMER FAVORITE!

PARKING SENSOR

GARAGE LASER PARK

Park your car in the garage in the exact same spot every time.

- Prevents damage to car and garage
- Simply attach to your garage ceiling with included hook-and-loop tape or screws. No wiring necessary.

MX37310 Garage Laser Park **\$19.95**

MX37312 Dual Garage Laser Park **\$29.95**



GARAGE DOOR REMOTES

Home Controls carries a great selection of garage door remote controls, including MegaCode, Multi-Code, Genie, Stanley and more.

www.HomeControls.com/Wireless-Garage-Transmitters-Receivers





Home Controls®

Automation Products & Support

8525 Redwood Creek Lane
San Diego, CA 92126

SOURCE CODE:
FA12R



LIGHTING & APPLIANCE CONTROLS

UPB

RELIABLE
DIGITAL
POWERLINE
» Page 10



Z-Wave

WIRELESS
LIGHTING
CONTROLS
» Page 16



NEW

SIMPLE
WORX
SYSTEM
» Page 15



**Plug-In
Power**

NEW: LEVITON
USB CHARGER
» Page 78



1-800-266-8765

WWW.HOMECONTROLS.COM



Door Intercom

New M&S System Features
Full Color Video » Page 47



Wireless Security

Do-It-Yourself Skylink
Security Systems » Page 34



Independent Living

TECHNOLOGY MEETS CARING
Home Health Tech » Page 82