

OWNER'S MANUAL

- ASSEMBLY
- OPERATION
- MAINTENANCE
- PARTS LIST

Model Nos.
127-260A
127-260-300

Important:

**Read Safety Rules and
Instructions Carefully**

**22" SELF
PROPELLED
ROTARY
MOWERS**

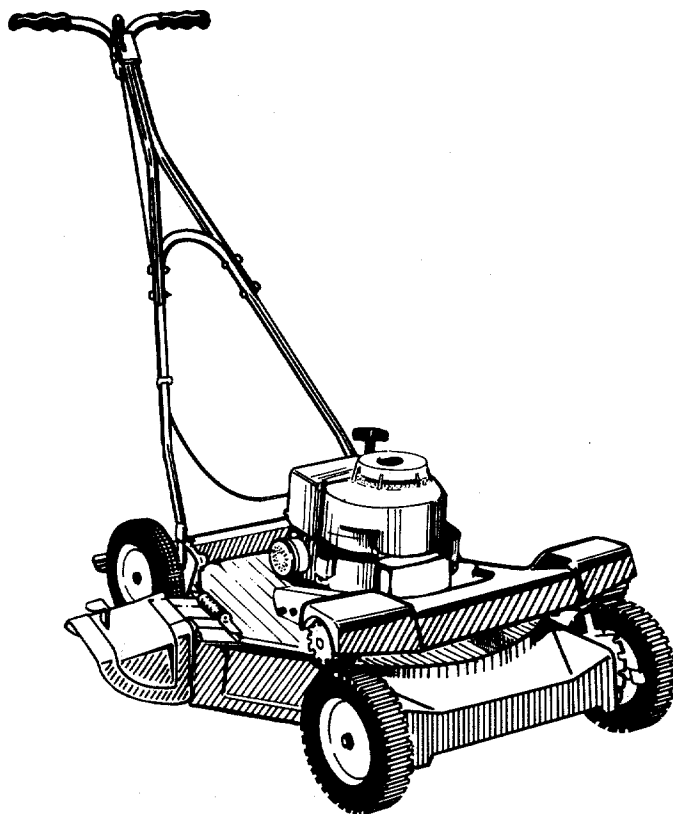

IMPORTANT

It is suggested that this manual be read in its entirety before attempting to assemble or operate. Keep this manual in a safe place for future reference and for ordering replacement parts.

This unit is shipped WITHOUT GASOLINE or OIL. After assembly, see operating section of this manual for proper fuel and amount.

Your rotary mower is a precision piece of power equipment, not a plaything. Therefore exercise extreme caution at all times.

SAFE OPERATION PRACTICES FOR WALK-BEHIND MOWERS

TRAINING

1. Read the Operating and Service Instruction Manual carefully. Be thoroughly familiar with the controls and the proper use of the equipment.
2. Never allow children to operate a power mower. Only persons well acquainted with these rules of safe operation should be allowed to use your mower.
3. Keep the area of operation clear of all persons, particularly small children and pets. Stop engine when they are in the vicinity of your mower. Although the area of operation should be completely cleared of foreign objects, a small object may have been overlooked and could be accidently thrown by the mower in any direction.

PREPARATION

1. Thoroughly inspect the area where the equipment is to be used and remove all stones, sticks, wire, bones and other foreign objects which could be picked up and thrown in any direction.
2. Do not operate equipment when barefoot or wearing open sandals. Always wear substantial footwear.
3. Do not wear loose fitting clothing that could get caught on the mower.
4. Check the fuel before starting the engine. Do not fill the gasoline tank indoors, when the engine is running, or while the engine is still hot. Wipe off any spilled gasoline before starting the engine.
5. Disengage the self-propelled mechanism or drive clutch on units so equipped before starting the engine.
6. Never attempt to make a wheel or cutting height adjustment while the engine is running.
7. Mow only in daylight or in good artificial light.
8. Never operate the equipment in wet grass. Always be sure of your footing; keep a firm hold on the handle and walk, never run.

OPERATION

1. Do not change the engine governor settings or overspeed the engine. Excessive engine speeds are dangerous.
2. Do not put hands or feet near or under rotating parts. Keep clear of the discharge opening at all times.
3. Stop the blade(s) when crossing gravel drive, walks or roads.
4. After striking a foreign object, stop the engine, remove the wire from the spark plug,

thoroughly inspect the mower for any damage, and repair the damage before restarting and operating the mower.

5. If the equipment should start to vibrate abnormally, stop the engine and check immediately for the cause. Vibration is generally a warning of trouble.
6. Stop the engine whenever you leave the mower, before cleaning the mower housing, and when making any repairs or inspections.
7. When cleaning, repairing or inspecting, make certain the blade and all moving parts have stopped. Disconnect the spark plug wire, and keep the wire away from the plug to prevent accidental starting.
8. Before attempting to unclog the mower or discharge chute, stop the engine and be sure the blade(s) have stopped completely. Disconnect the spark plug wire and keep the wire away from the plug to prevent accidental starting.
9. Do not run the engine indoors.
10. Shut the engine off and wait until the blade comes to a complete stop before removing the grass catcher.
11. Mow across the face of slopes, never up-and-down. Exercise extreme caution when changing direction on slopes. Do not mow excessively steep slopes.
12. Always disconnect electric mowers (line operated) before cleaning, repairing or adjusting.
13. Never operate mower without proper guards, plates or other safety protective devices in place.
14. Keep washout ports and other mower-housing service openings closed when mowing.

MAINTENANCE AND STORAGE

1. Check the blade and engine mounting bolts at frequent intervals for proper tightness.
2. Keep all nuts, bolts, and screws tight to be sure the equipment is in safe working condition.
3. Never store the equipment with gasoline in the tank inside of a building where fumes may reach an open flame or spark. Allow the engine to cool before storing in any enclosure.
4. To reduce fire hazard, keep the engine free of grass, leaves, or excessive grease.
5. Check the grass catcher bag frequently for wear or deterioration. For safety protection replace only with new bag meeting original equipment specifications.

HANDLE ASSEMBLY



It may be necessary to bend the ends of the lower handle inward slightly to assure a snug fit against the deck mounting area.

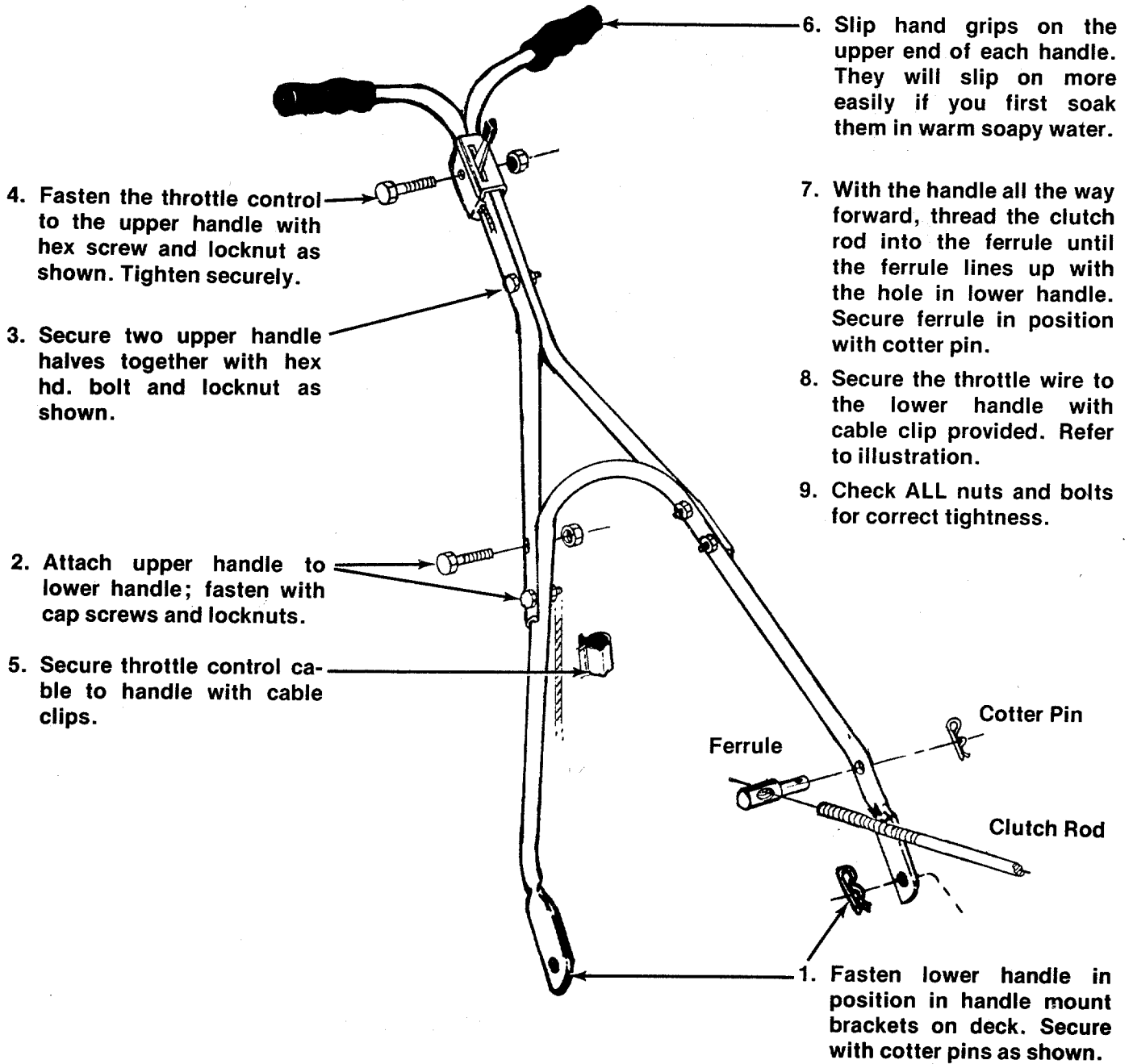

CAUTION

Please note that the chute deflector on your mower is in an upright position. It is held in that position by a shipping block. This block is used for shipping purposes only. It must be removed and discarded before your mower is put into operation.

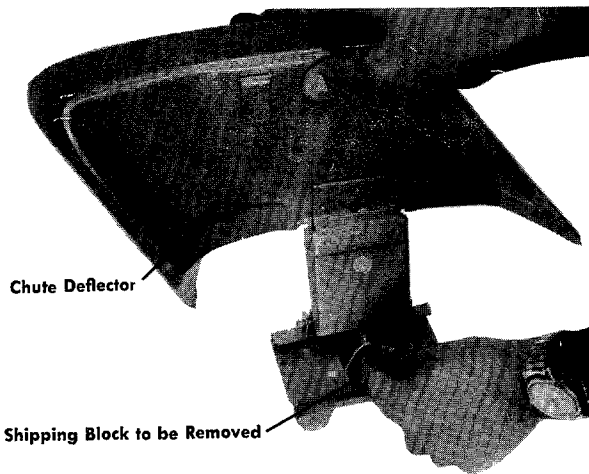

This mower should be broken in following the procedure described in the break-in instructions. The added effort here will double the service life of the unit. Particular attention should be paid to the notes on alignment.

When operating this mower, unnecessary or excessive engaging of the drive pinions with the wheels should be avoided. This is achieved by minimizing the raising and lowering of the handle during the mowing operation. Failure to observe this operating rule can reduce the service life of the front tires and drive pinions substantially. When engaging the self-propelled mechanism, a slight forward push on the mower as the drive pinions and the gear tread tires mesh will add to smoother and quieter operation. In addition to a smoother operation, it will add substantially to the service life of both the tires and the drive pinions.

HANDLE ASSEMBLY PRECAUTIONS

Although the handle is of simple design, difficulty has been encountered in its assembly. Certain precautions concerning its assembly must be heeded. The handle must be assembled as shown in the diagram on page 3. Trouble arises when certain parts are put together improperly.

BREAK-IN INSTRUCTIONS

1. Before starting the engine, lubricate all the bronze bearings on the drive shaft. The same oil which is used for the engine may be used for this.
2. Check drive assembly alignment. When the handle is lifted the clutch rod is moved to the self-propelled position. The black nylon drive pinions should mesh simultaneously with the gear tread tires.

OPERATION



For shipping purposes your mower is set with the wheels in a low cutting height position. For best results, raise the cutting position until it is determined which height is best for your lawn. See adjustments.

1. Service engine with gas and oil. See Engine Maintenance for complete instructions for care and maintenance of engine. READ DIRECTIONS CAREFULLY.
2. Lubricate bronze bearings on drive shaft.
3. Check drive assembly for correct alignment (See Break-in Instructions).
4. When ready to start engine, be sure handle is all the way back into free wheeling position. Start engine, after engine starts, move throttle control lever on handle to the desired engine speed.
5. When the handle is moved forward for self-propelled operation, the drive pinions engage with the gear tread tires and forward drive results.
6. Temporary free wheeling is achieved by depressing the handle and raising front wheels slightly off the ground. Self-propelled drive is resumed when handle is raised. Engine is stopped by placing control lever on handle into STOP position.

LUBRICATION



Always stop engine and disconnect spark plug wire before cleaning, lubricating or doing any kind of work on lawn mower.

Wheels—Rear wheel bearings are of self-lubricating Fortiflex. They require no lubrication. Front drive wheels are equipped with sintered bearings. Lubricate at least once a season with light oil.

Throttle—Periodically lubricate throttle control lever and throttle wire assembly with a few drops of light oil SAE No. 10 or 20 for ease of operations.

Bronze Bearings—Periodically lubricate all bronze bearings with a few drops of light oil SAE No. 10 or 20 to minimize friction.

Protective Shield—The pivot points on the protective shield should be lubricated periodically with light oil to prevent any rust or binding.

Chute Deflector—The torsion spring and pivot point should be lubricated periodically with light oil to prevent any rust or binding. Deflector must work freely.

Engine—See Engine Maintenance for lubrication instructions.

Chain—The chain should be lubricated periodically with a light oil to prevent any rust or binding. Note: Use very little or no oil if unit is being used in a dry or dusty area.

ADJUSTMENTS



CAUTION

Do not at any time make any adjustment to lawn mower without first stopping engine and disconnecting spark plug wire.

Chain Adjustment—

1. Loosen (do not remove) two hex head cap screws. See figure 1.
2. Pull pivot plate forward by hand. Do not force.
3. Tighten cap screws and check chain tension. Repeat adjustment if necessary.

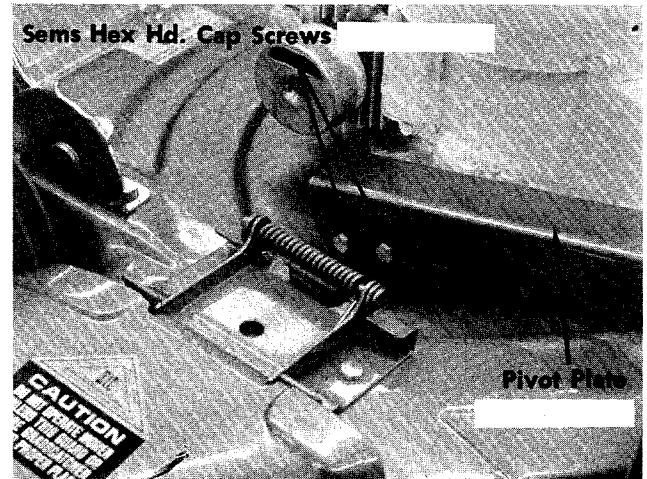

FIGURE 1.

Cutting Height—Adjustment may be made by removing and moving wheel studs to desired position. Cutting heights will be raised as wheel studs are moved to a lower hole and lowered as wheel studs are moved to a higher hole in the deck. All wheel studs must be mounted in a relative position to the deck.

Front Wheel Height Adjustment

1. Place the front of mower deck on a block so that the front wheels are off the ground.
2. Remove the hair pin cotter from ferrule, located on clutch rod.
3. Slip the ferrule out of the lower handle.
4. With an adjustable wrench, remove the axle bolt, spacer, belleville washer and front wheels.

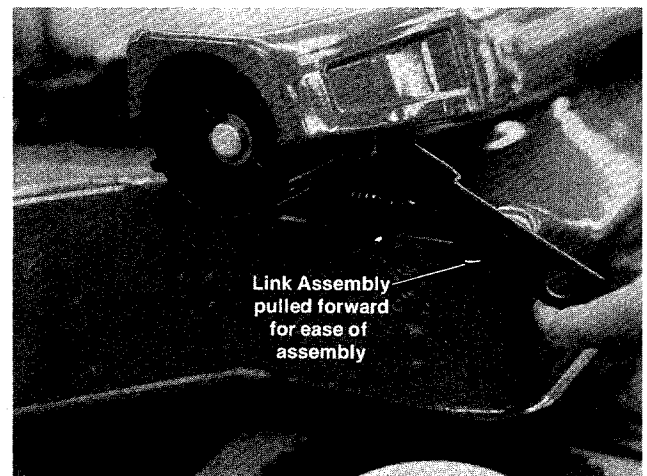

FIGURE 2.

NOTE

When axle bolt is removed from deck, the link assembly is under spring tension and will pivot back against the deck.

5. Pull the link assembly forward as far as it will go. See figure 2.
6. Reassemble wheel and axle through link assembly, then place spacer and belleville washer on axle. See figure 3.

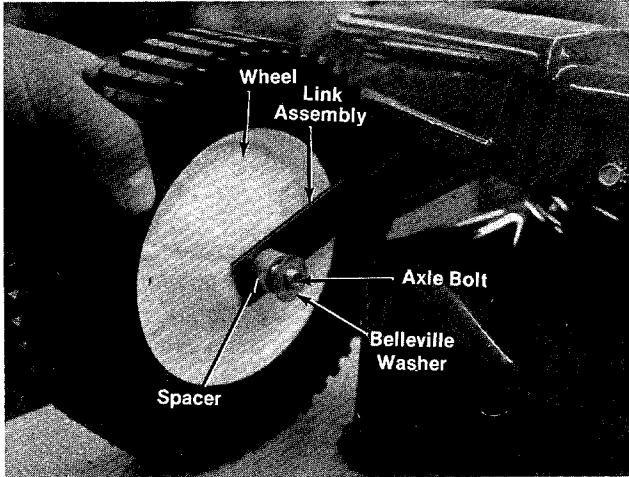

FIGURE 3.

NOTE

Belleville washer goes on axle, crown side towards spacer.

7. Select desired height and tighten axle bolt.
8. Raise the lower handle, adjust ferrule (if necessary) and slide ferrule through hole in lower handle. Secure with hair pin cotter.

Throttle—If adjustment becomes necessary, the throttle control wire assembly can be reset as follows:

1. Loosen, but do not remove, screw securing throttle control wire assembly at engine.
2. Move throttle control lever on handle to FAST position.
3. Move lever, to which control wire is fastened at engine, to full open position and retighten screw to secure throttle control wire assembly.

CLUTCH ROD ADJUSTMENT

If adjustment becomes necessary, or if the cutting height is changed from the lowest setting to the highest setting the clutch rod must be reset as follows:

1. Remove the cotter pin. See figure 4.
2. Pull the clutch rod and ferrule out of the lower handle. See figure 5.
3. Thread the ferrule on or off the rod one turn and check for alignment.
4. Place ferrule back in position and secure with cotter pin. If the engagement is still not correct, repeat the above steps.
5. The drive pinion should be about 1/8" from the drive wheels. See figure 6.

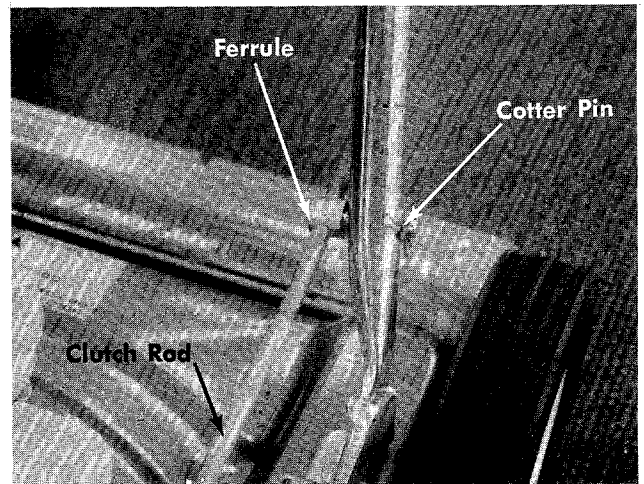

FIGURE 4.

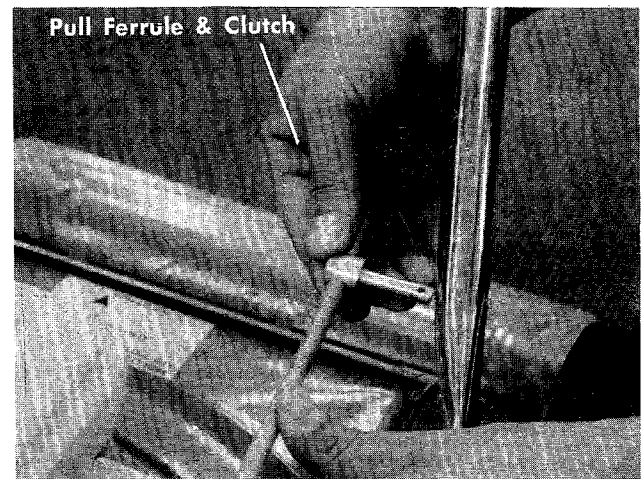

FIGURE 5.

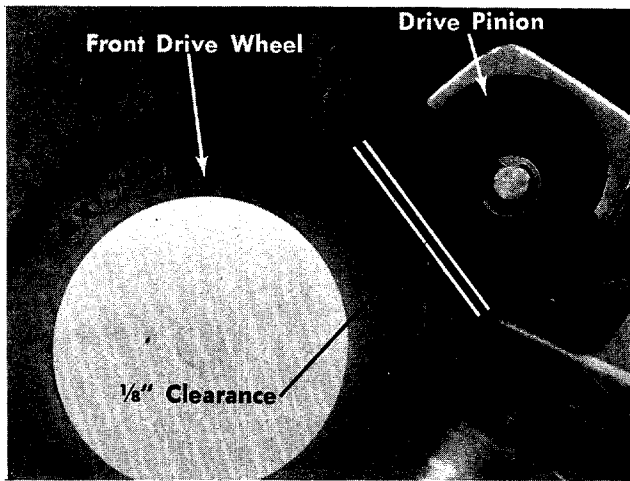

FIGURE 6.

MAINTENANCE

Cutting Blade—The blade may easily be removed for grinding or replacement as follows:

1. Remove bolt and lockwasher holding blade and blade adapter to engine crankshaft.
2. Remove blade and blade adapter from engine crankshaft.
3. Remove two bolts, lockwashers and nuts holding blade to blade adapter (if necessary).

When sharpening blade, follow the original angle of grind as a guide. It is extremely important that each cutting edge receives an equal amount of grinding to prevent an unbalanced blade. An unbalanced blade will cause excessive vibration when rotating at high speeds and may cause damage to the mower.



NOTE

To insure safe operation of your unit, ALL nuts and bolts must be checked periodically for correct tightness.

Deck—The underside of mower deck should be cleaned after each period of use as grass clippings, leaves, dirt and other matter will accumulate. This accumulation of grass clippings, etc., is undesirable as it will invite corrosion and cause an uneven discharge of grass clippings at the next cutting.

The deck may be cleaned by tilting the mower forward or on its left side and scraping clean with a suitable tool or by washing with a stream of water from a garden hose.



CAUTION

Do not direct the stream of water at a hot engine as damage to the engine may result.

STORAGE

The following steps should be taken to prepare lawn mower for storage.

1. Clean and lubricate mower thoroughly as described in the preceding instructions.
2. Refer to engine manual for correct engine storage instructions.
3. Coat mower's cutting blade with chassis grease to prevent rusting.
4. Place blocks under deck to raise tires clear of floor.
5. Store mower in a dry, clean area.

USING YOUR ROTARY MOWER

For best results do not cut wet grass because it tends to stick to the underside of the mower thus preventing proper discharge of grass clippings. If wet grass must be cut, reduce walking speed to help distribute the clippings more effectively.

New grass should be treated as wet grass, otherwise a normal walking speed is about the right pace for efficient mowing.

The best mowing pattern is one that allows the clippings to discharge towards the uncut part of the lawn. This permits recutting of the clippings to further pulverize them. When cutting high weeds, discharge towards cut portion, then recut at right angles to first direction.

Lawn should be cut in the fall as long as there is growth.

HANDLE STORAGE

The handle may be put in a storage position; use the following steps:

1. Remove hairpin cotter from ferrule on clutch rod.
2. Pull the ferrule out of the handle.
3. Replace the hairpin cotter.
4. Press inward on the lower handle and move it forward.
5. To put the handle back into the operating position, simply pull the handle back. It will lock automatically.

127-260A

IF YOU WRITE TO US ABOUT THIS ARTICLE
OR IF YOU ORDER REPLACEMENT PARTS AL-
WAYS MENTION THIS MODEL & SERIAL NO
MODEL

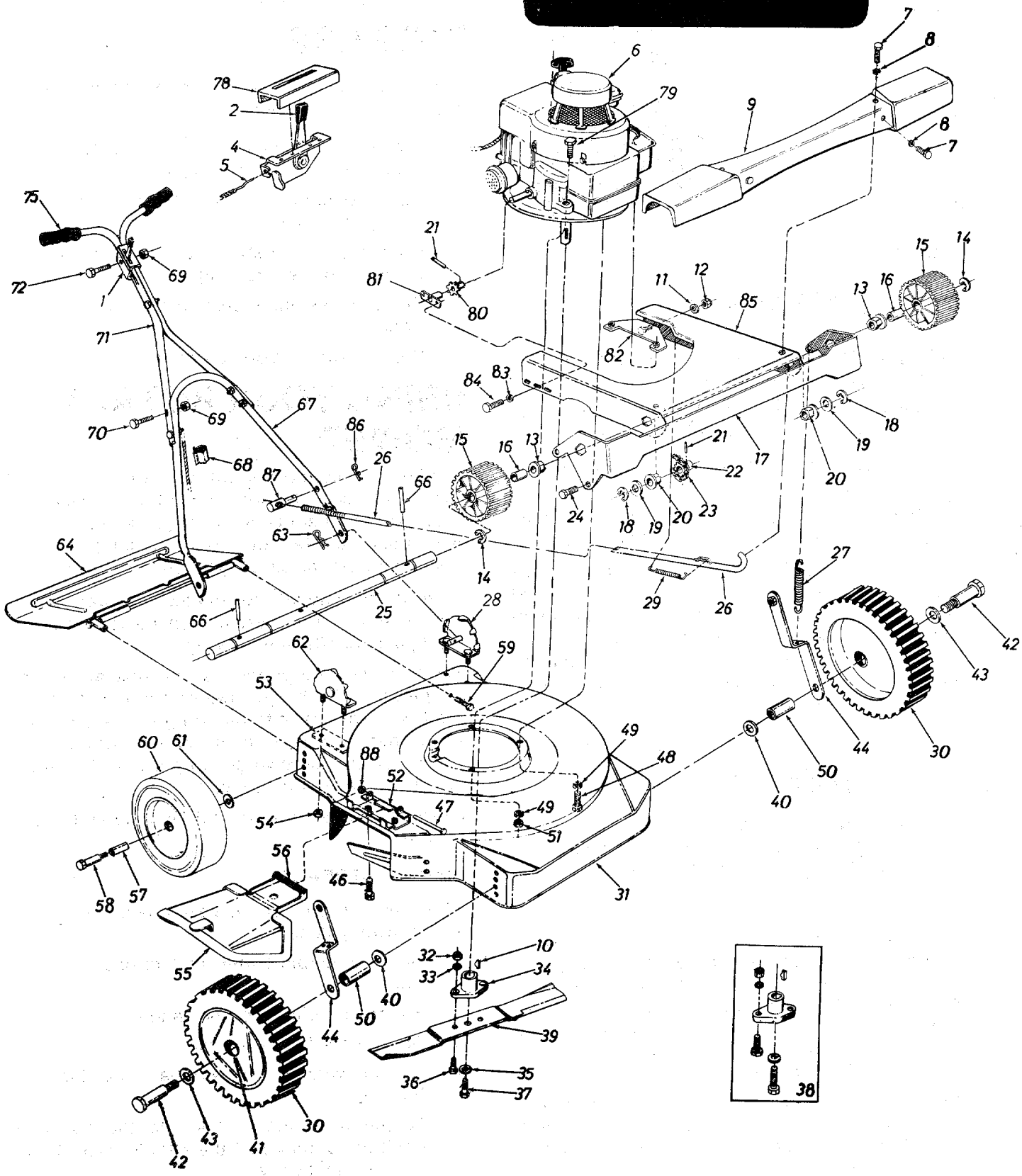

PARTS LIST FOR MODEL 127-260A

REF. NO.	PART NO.	COLOR CODE	DESCRIPTION	NEW PART	REF. NO.	PART NO.	COLOR CODE	DESCRIPTION	NEW PART
1	11609		Throttle Control Complete		42	738-0129		Axle Bolt—Front Only	
2	07470		Knob—Throttle Control		43	736-0160		Flat Washer	
4	11598		Throttle Control Ass'y.		44	10379		Link Ass'y.	
5	746-0229		Conduit and Wire		46	710-0289		Hex Scr. 1/4-20 x 1/2" Lg.*	
6	—		Engine		47	711-0555		Pivot Pin	
7	710-0289		Hex Scr. 1/4-20 x .50" Lg.*		48	710-0442		Hex Hd. Cap Scr. 5/16-18 x 1 1/2" Lg.*	
8	736-0222		Extr. L-Wash. 1/4" Scr.*		49	736-0119		Spring L-Wash. 5/16 Scr.*	
9	10913 —463		Drive Cover		50	711-0494		Spacer	
10	714-0365		Hi-Pro Key*		51	712-0123		Hex Nut 5/16-24 Thd.*	
11	736-0300		Flat Washer		52	11130 —463		Adapter Plate	
12	712-0116		Elastic Locknut 3/8-24 Thd.*		53	10459		Reinforcement Plate	
13	748-0227		Hex Bearing		54	712-0107		Hex Centerlock Nut 1/4-20 Thd.	
14	716-0106		"E" Ring 5/8 Shaft		55	11679 —463		Chute Deflector	
15	10914		Drive Pinion		56	732-0253		Torsion Spring	
16	02265		Sleeve		57	07006		Fortiflex Bearing—Rear	
17	10372 —463		Drive Support		58	738-0213		Axle Bolt—Rear Only	
18	716-0106		"E" Ring 5/8 Shaft		59	710-0567		Hex Scr. 1/4-28 x .62 Lg.	
19	736-0116		Flat Washer		60	09392-501		Rear Wheel—Complete	
20	748-0227		Hex Bearing		61	736-0105		Belleville Washer	
21	715-0247		Roll Pin 3/16 Dia. x 1" Lg.*		62	11802		Handle Mount Bracket	
22	10378		Sprocket Ass'y.		63	714-0104		Hairpin Cotter*	
23	713-0135		Chain w/Master Link No. 48 26" Lg.		64	11193 —463		Rear Pro. Shield Ass'y.—Comp.	
24	738-0147		Shoulder Bolt—Special		66	715-0246		Roll Pin 3/16 Dia. x 1.25	
25	711-0435		Shaft		67	749-0128		Lower Handle	
26	12613		Clutch Rod Ass'y.		68	746-0128		Cable Clip	
27	732-0209		Extension Spring		69	712-0107		Hex Center L-Nut 1/4-20 Thd.*	
28	11801		Handle Mount Bracket—L.H.		70	710-0606		Hex Scr. 1/4-20 x 1.50" Lg.*	
29	732-0433		Tension Spring		71	09354		Upper Handle	
30	09392-503		Front Wheel Complete		72	710-0136		Hex Hd. Cap Scr. 1/4-20 x 1 1/2" Lg.	
31	12421 —463		Deck Ass'y.		75	720-0157		Grip—Black	
32	712-0123		Hex Nut 5/16-24 Thd.*		78	731-0344		Plastic Label	
33	736-0119		Spring L-Wash. 5/16 Scr.*		79	710-0158		Hex Hd. Cap Scr. 5/16-24 x 1 1/4" Lg.*	
34	10769		Blade Adapter Kit		80	10377		Sprocket Ass'y.	
35	736-0217		Spring L-Wash. 3/8 Scr.—H.D.*		81	748-0183		Bearing Support	
36	710-0459		Hex Hd. Cap Scr. 3/8-24 x 1 1/2" Lg.—H.T.		82	10381		Engine Bracket Ass'y.	
37	710-0117		Hex Hd. Cap Scr. 5/16-24 x 1" Lg.—H.T.		83	736-0222		External L-Wash. 1/4" Scr.*	
38	10769		Blade Adapter Kit/Less Blade		84	710-0230		Hex Hd. Cap Scr. 1/4-28 x 1/2"*	
39	742-0125		Blade—22 inch		85	11240 —463		Pivot Plate Ass'y.	
40	736-0105		Belleville Washer		86	714-0104		Internal Cotter Pin	
41	748-0125		Sintered Bearing—Front		87	711-0570		Ferrule	

*For faster service obtain standard nuts, bolts and washers locally. If these items cannot be obtained locally, order by part number and size as shown on parts list.

(463—Top Flite Red)

When ordering parts if color or finish is important, use color code shown at left. (e.g. Top Flite Red Finish—11430 (463).)

The engine is not under warranty by the mower manufacturer. If repairs or service is needed on the engine, please contact your nearest authorized engine service outlet. Check the "Yellow Pages" of your telephone book under "Engines — Gasoline."



 **NOTE**

The manufacturer DOES NOT recommend the use of any accessory on this rider mower other than those manufactured by MTD Products Inc.

GRASS CATCHER Model No. 197-003A is available as optional equipment for the mowers shown in this manual.



1. The mower should not be operated without the entire grass catcher or chute deflector in place.
2. The mower should not be operated without the protective shield on the rear of the deck in place.

 **NOTE**

Under normal usage bag material is subject to wear and should be checked periodically. Be sure any replacement bag complies with the mower manufacturer's recommendations.

For replacement bags, use only factory authorized replacement bag No. 764-0119.

 **IMPORTANT**

After striking a foreign object, stop the engine, remove wire from spark plug. Thoroughly inspect the mower for any damage, and repair the damage before restarting and operating the mower.

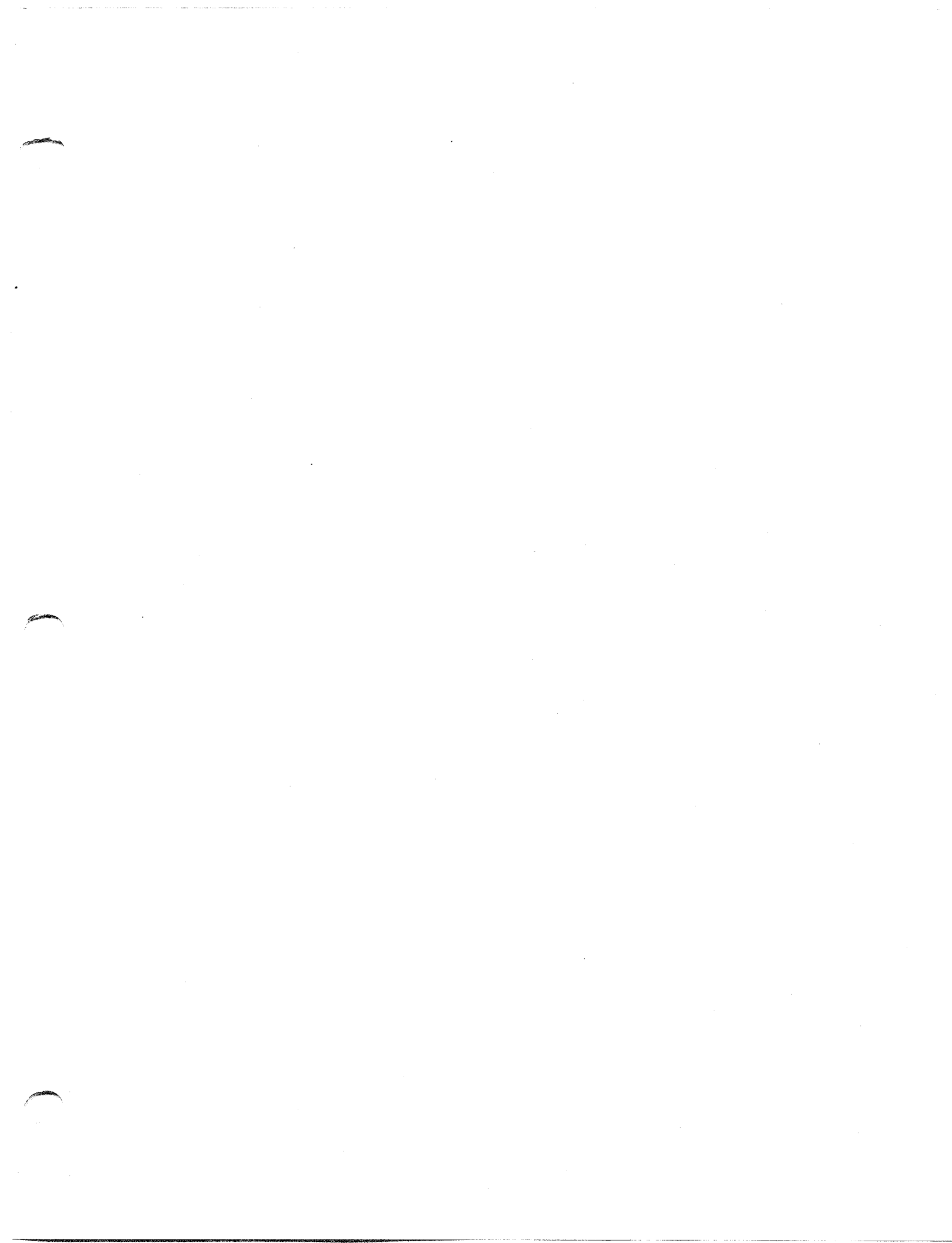

PARTS INFORMATION

POWER EQUIPMENT PARTS AND SERVICE

Parts and service for all MTD manufactured power equipment are available through the authorized service firms listed below. All orders should specify the model number of your unit, parts numbers, description of parts and the quantity of each part required.

ALABAMA	BIRMINGHAM	
	Auto Electric & Carburetor Co.	2625 4th Ave. S. 35233
ARKANSAS	NORTH LITTLE ROCK	
	Sutton's Lawn Mower Shop	Rt. 4, Box 368 72117
	FORT SMITH	
	Mity Mite Motors, Inc.	2515 Towson Ave. 72901
CALIFORNIA	SAN BERNARDINO	
	Lawn Mower Supply Co.	25608 E. Baseline 92410
	SAN FRANCISCO	
	J.W. Jewett Co.	981 Folsom St. 94107
	SACRAMENTO	
	Luttig & Severson	2030 28th St. 95818
COLORADO	DENVER	
	South Denver Lawn Equip.	527 West Evans 80223
CONNECTICUT	SUFFIELD	
	The Jones & Ramsey Co.	850 Thompsonville Rd. 06078
FLORIDA	JACKSONVILLE	
	Radco Distributors	2403 Market St. 32206
	CORAL GABLES	
	Moz-All of Florida, Inc.	365 Greco Ave. 33146
GEORGIA	EAST POINT	
	East Point Cycle & Key	2834 Church St. 30344
ILLINOIS	LYONS	
	Keen Edge Co.	8615 Ogden Ave. 60534
INDIANA	ELKHART	
	Parts & Sales Inc.	2101 Industrial Pkwy. 46514
IOWA	DUBUQUE	
	Power Lawn & Garden Equip.	2551 J.F. Kennedy 52001
KANSAS	WICHITA	
	Hixon, Inc.	3030 Mascot 67204
LOUISIANA	NEW ORLEANS	
	Suhren Engine Co.	8330 Earhart Blvd. 70118
MARYLAND	TAKOMA PARK	
	Center Supply Co.	6867 New Hampshire Ave. 20012
MASSACHUSETTS	SPRINGFIELD	
	Morton B. Collins Co.	300 Bernie Ave. 01107
MICHIGAN	MOUNT CLEMENS	
	Power Equipment Dist.	36463 South Gratiot... 48043
	LANSING	
	Lorenz Service Co.	2500 S. Pennsylvania .. 48900
MINNESOTA	MINNETONKA	
	Hance Distributing Inc.	11212 Wayzata Blvd. .. 55343
MISSISSIPPI	BILOXI	
	Biloxi Sales & Service, Inc.	506 Caillavet St. 39533
MISSOURI	KANSAS CITY	
	Automotive Equip. Service	3117 Holmes St. 64109
	ST. LOUIS	
	Henzler, Inc.	2015 Lemay Ferry Rd. 63125
NEW YORK	CARTHAGE	
	Gamble Dist., Inc.	West End Ave. 13619
	SYRACUSE	
	Kimber's, Inc.	115 N. Geddes St. 13204

BRIGGS & STRATTON, TECUMSEH AND PEERLESS PARTS AND SERVICE

Briggs & Stratton, Tecumseh and Peerless parts and service should be handled by your nearest authorized engine service firm. Check the yellow pages of your telephone directory under the listing *Engines Gasoline*, Briggs & Stratton or Tecumseh Lauson

NORTH CAROLINA	GREENSBORO	
	Dixie Sales Company	327 Battleground Ave.. 27402
	GOLDSBORO	
	Smith Hardware Co.	515 N. George St. 27530
OHIO	WADSWORTH	
	National Central	687 Seville Rd. 44281
	CLEVELAND	
	Bleckrie, Inc.	7900 Lorain Ave. 44102
	CARROL	
	Stebe's Mid-State Mower Supply Box 366	43112
	WILLARD	
	Sunshine Wholesale Tire Outlet Route 224	44890
	MANSFIELD	
	McClure Lawn & Garden Supply...1114 Lexington Ave. .	44903
OKLAHOMA	MUSKOGEE	
	Victory Motors, Inc.	605 S. Cherokee 74401
	ADA	
	Ada Auto Supply	301 E. 12th St. 74820
OREGON	PORTLAND	
	Kenton Supply Co.	8216 N. Denver Ave. . 97217
PENNSYLVANIA	LANCASTER	
	Raub Supply Co.	James & Mulberry Sts...17604
	PITTSBURGH	
	Bluemont Co.	11125 Frankstown Rd.. 15235
TENNESSEE	KNOXVILLE	
	Master Repair Service	2423 Broadway, N.E. ...37917
	MEMPHIS	
	Memphis Cycle & Supply Co.	421 Monroe Ave. 38103
	American Sales & Service, Inc. .	1922 Lynnbrook 38116
TEXAS	DALLAS	
	Marr Brothers, Inc.	423 E. Jefferson 75203
	HOUSTON	
	Bullard Supply Co.	2409 Commerce St. 77003
	SAN ANTONIO	
	Catto & Putty, Inc.	P.O. Box 2408 78206
	FORT WORTH	
	Woodson Sales Corp.	1702 N. Sylvania 76111
UTAH	SALT LAKE CITY	
	A-1 Engine & Mower Co.	437 E. 9th St. 84111
VERMONT	BURLINGTON	
	Vermont Appliance Co.	44 Lakeside Ave. 05401
VIRGINIA	RICHMOND	
	RBI Corp.	963 Myers St. 23260
WASHINGTON	SEATTLE	
	Bailey's Rebuild, Inc.	1325 E. Madison St. ...98102
WEST VIRGINIA	CHARLESTON	
	Young's, Inc.	233 Virginia St., E. ... 25301
WISCONSIN	APPLETON	
	Automotive Supply Co.	123 S. Linwood Ave. ..54911

WARRANTY PARTS AND SERVICE POLICY

The purpose of warranty is to protect the customer from defects in workmanship and materials, defects which are NOT detected at the time of manufacture. It does not provide for the unlimited and unrestricted replacement of parts. Use and maintenance are the responsibility of the customer. The manufacturer cannot assume responsibility for conditions over which it has no control. Simply put, if it's the manufacturer's fault, it's the manufacturer's responsibility; if it's the customer's fault, it's the customer's responsibility.

CLAIMS AGAINST THE MANUFACTURER'S WARRANTY INCLUDES

1. Replacement of Missing Parts on new equipment.
2. Replacement of Defective Parts within the warranty period.
3. Repair of Defects within the warranty period.

All claims MUST be substantiated with the following information:

1. Model Number of unit involved.
2. Date unit was purchased or first put into service.
3. Date of failure.
4. Nature of failure.