

**MOXI**<sup>®</sup> CABLE  
HD DVR 3012

## Safety Instructions



The symbol is intended to alert the user to presence of un-insulated "Hazardous Voltage" within the product's enclosure that may be of sufficient magnitude to constitute a risk of electric shock to persons.



The symbol is intended to alert the user that improper use of the product may result in product malfunction. The user should pay attention to avoid accidents or unnecessary problems.

### Important Safety Instructions

- 1) Read these instructions.
- 2) Keep these instructions.
- 3) Heed all warnings.
- 4) Follow all instructions.
- 5) Do not use this apparatus near water.
- 6) Clean only with dry cloth.
- 7) Do not block any ventilation openings. Install in accordance with the manufacturer's instructions.
- 8) Do not install near any heat sources such as radiators, heat registers, stoves, or other apparatus (including amplifiers) that produce heat.
- 9) Do not defeat the safety purpose of the polarized or grounding-type plug. A polarized plug has two blades with one wider than the other. A grounding type plug has two blades and a third grounding prong. The wide blade or the third prong are provided for your safety. If the provided plug does not fit into your outlet, consult an electrician for replacement of the obsolete outlet.
- 10) Protect the power cord from being walked on or pinched particularly at plugs, convenience receptacles, and the point where they exit from the apparatus.
- 11) Only use attachments/accessories supplied by the manufacturer.
- 12) See the Regulatory Information and Product Safety Information and Warnings document for further important safety and regulatory information and notices.

The information contained in this document is provided solely for use in connection with Digeo products and services. Digeo, Inc. reserves all rights in and to such information and the products and services discussed herein. This document should not be construed as transferring or granting a license to any intellectual property rights, whether express, implied, arising through estoppels or otherwise. EXCEPT, AS MAY BE AGREED IN WRITING BY DIGEO, INC., THE INFORMATION CONTAINED IN THIS DOCUMENT, AND ALL DIGEO PRODUCTS AND SERVICES ARE PROVIDED "AS IS" AND WITHOUT A WARRANTY OF ANY KIND. DIGEO, INC. HEREBY DISCLAIMS ALL WARRANTIES, EXPRESS OR IMPLIED, RELATING TO THE INFORMATION IN THIS DOCUMENT AND DIGEO PRODUCTS, INCLUDING, BUT NOT LIMITED TO, THE IMPLIED WARRANTIES OF MERCHANTABILITY, FITNESS FOR A PARTICULAR PURPOSE, AND NON-INFRINGEMENT OF THIRD PARTY INTELLECTUAL PROPERTY. The information in this document may contain inaccurate information. Digeo, Inc. makes no representations or warranties with respect to the accuracy or completeness of the information contained in this document, and Digeo, Inc. reserves the right to change the information in this document, product or service descriptions, and product or service specifications at any time, without notice.

This product incorporates copyright protection technology that is protected by U.S. patents and other intellectual property rights. Use of this copyright protection technology must be authorized by Macrovision Corporation, and is intended for home and other limited consumer uses only, unless otherwise authorized by Macrovision. Reverse engineering or disassembly is prohibited.

Contains Macromedia Flash™ Player technology by Macromedia, Inc. Copyright © 1995-2001 Macromedia, Inc. All rights reserved. Macromedia, Flash and Macromedia Flash are trademarks or registered trademarks of Macromedia, Inc. in the United States and internationally.

Digeo, Inc. reserves the right to discontinue or change any product or service, or the documentation for any product or service, at any time, without notice.

Use of the trademarks and service marks of the National Television Academy ("NATAS/NTA"), including the mark EMMY®, requires the prior express written permission of the National Television Academy.

Trademarks: Digeo, the Digeo logo, Moxi, the Moxi logo, SuperTicker, and combinations thereof are trademarks of Digeo, Inc. in the USA and other countries. All other trademarks and trade names are the property of their respective owners.

Manufactured under license from Dolby Laboratories. Dolby and the double-D symbol are trademarks of Dolby Laboratories.

HDMI, the HDMI logo and High-Definition Multimedia Interface are trademarks or registered trademarks of HDMI Licensing LLC.

CableCARD™ is a trademark of Cable Television Laboratories, Inc. Other trademarks are the property of their respective owners.

© 2008 Digeo, Inc. Reproduction in whole or in part without written permission is prohibited. All rights reserved.

# Contents

<b>Get Started</b> .....	<b>5</b>	Find & Record shows .....	20	Locking topics or items.....	30
Watch TV.....	7	Surfing channels.....	20	Enjoy Photos.....	31
Control live TV.....	8	Searching by title or keyword .....	21	Uploading photos.....	31
Record programs .....	9	Searching by category .....	22	Viewing photos .....	32
Find and playback programs .....	10	Remember your favorite channels.....	22	Read service messages.....	33
Other fun features .....	11	Use the Moxi Flip Bar.....	23	Play games .....	34
Use this guide .....	12	Use the player bar.....	23	Learn more about Moxi features.....	34
Learning the lingo.....	12	Record shows .....	24	Software version and other details.....	34
<b>Use and program the remote</b> .....	<b>13</b>	Understanding the recording icons .....	25	<b>Personalize Moxi Cable HD DVR</b> .....	<b>35</b>
Functions of the Moxi remote .....	14	Finding a previously scheduled recording.....	25	Parental Controls.....	36
Multi-function buttons.....	14	Recording options .....	26	Creating a PIN .....	36
Program the remote.....	16	Recording series .....	27	Changing a PIN .....	36
Programming with codes.....	16	Understanding the storage meter .....	28	Locking channels or programs by rating .....	36
Programming by search .....	16	Watch Pay Per View movies .....	29	Turning off parental controls.....	37
Additional programming features .....	17	Watch On Demand shows .....	29	Controlling Pay Per View or On Demand purchases .....	38
Infrared emitter .....	17	Use SuperTicker™ .....	30	If you forget your PIN .....	39
<b>Use the Moxi Menu</b> .....	<b>19</b>	Reading the whole story .....	30	Closed Caption.....	39
Navigate the Moxi Menu.....	20				

Widescreen.....	39	Opening the on-screen diagnostics menu using the front panel.....	49
HDTV Setup.....	40		
Setting standard TV video resolution.....	40		
External Hard Drive.....	41	<b>Get Connected.....</b>	<b>51</b>
Using an external hard drive.....	41	System specifications.....	52
Sound Effects.....	42	Before connecting.....	52
Channel List.....	43	Ventilation requirements.....	53
CableCARD™.....	43	Available ports.....	53
		Connect to the TV and receiver.....	56
<b>Troubleshoot.....</b>	<b>45</b>	Connect archiving components.....	57
Audio and video problems.....	46	Archiving simplified.....	58
No video displayed.....	46	<b>Moxi remote programming codes.....</b>	<b>61</b>
Static on screen or poor picture quality.....	46	TV codes for the Moxi remote control.....	62
TV audio and video out-of-sync.....	46	Audio device codes for the Moxi remote control.....	67
Cannot change TV channels.....	46	<b>Glossary.....</b>	<b>71</b>
Remote or front panel control problems.....	47	<b>Index.....</b>	<b>75</b>
Cannot control the Moxi 3012 using front panel buttons.....	47		
Cannot control TV using the remote.....	47		
External hard drive issues.....	47		
Recovering corrupted programs.....	47		
Running out of storage space.....	48		
Moxi 3012 unable to recognize your external hard drive.....	48		
Use the front panel to troubleshoot.....	49		
Changing video display output using the front panel.....	49		

# Get Started

Watch TV .....	7
Control live TV.....	8
Record programs .....	9
Find and playback programs .....	10
Other fun features .....	11
Use this guide.....	12

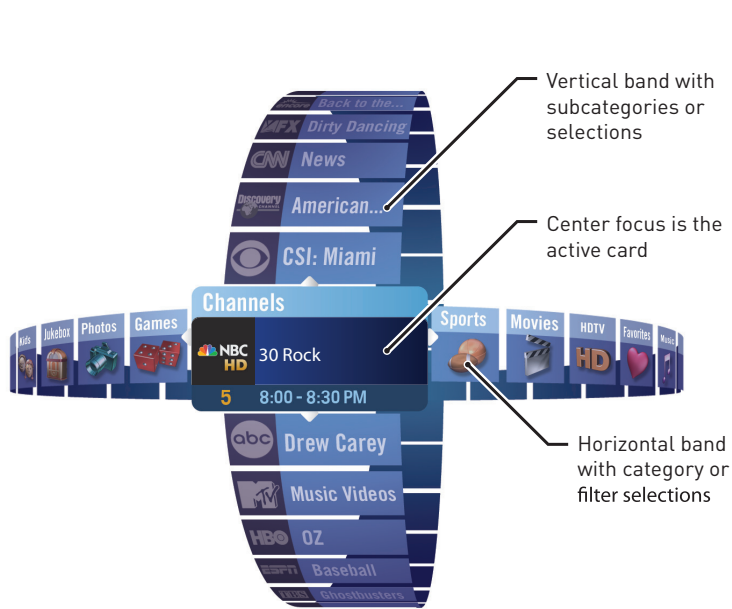

The Moxi Menu is an Emmy® Award-winning dual-axis electronic program guide that allows you to quickly surf channels while viewing live TV. The Moxi Menu turns your TV into a recording system, a casual gaming device, and a photo storage and playback device. Who knew your TV could be so versatile! Find out more on page 20.

Use the following diagrams to help you quickly get started with your Moxi@Cable HD DVR version 3012.

# Watch TV

Surf for programs and watch TV. It's only a few clicks away.



**Press the Moxi button** on the remote to launch the Moxi Menu and electronic program guide.

1



**Use the Arrow buttons** to surf the **Channels** category on the Moxi Menu.



**Press the OK button** twice to watch the selected channel program.



**Press the info button** at any time to view show details. Find out more on page 20.

# Control live TV

Control live TV with the touch of your fingertip.



**Press Pause** to pause the live program you are watching.

**Press Fwd** up to three times (three speeds) to fast forward recorded shows.

**Press Rew** up to three times (three speeds) to rewind shows.

**Press Live TV** to exit out of the paused TV program and watch the program live, immediately.

Find out more on page 24.



## Record programs

Record, and then watch your favorite programs whenever you want.



**On the Moxi Menu** press the **arrow** buttons on the remote control to surf for the show you want to record.

1



**Press Rec** twice to record the selected TV show.



**Select to record once or record series** on the action menu to record a show once, or record the entire series rather than just a single episode.

### Find and playback programs

The Moxi Menu provides several ways to search for programs to record, and to search for programs you have already recorded.



Select **Find & Record** on the Moxi Menu to search for a TV program or series and schedule it to record.

Scroll to **Recorded TV** on the Moxi Menu and select a recorded program to watch. Once you select a program, press **OK** on the remote twice to watch it.



Press the **Player Controls** on the remote control to manipulate the playback of any recorded program.

Find out more on page 23.

# Other fun features

Photos, games, on demand movies, and news headlines all from your TV.



**Play Games** such as, Video Poker, Slot Machine, and more. Use the **arrow**, **OK**, and **number** buttons on the remote to play the games. Find out more on page 34.

**Download & View Photos** on your TV. Find out more on page 31.



**Browse Pay Per View & On Demand** categories to preview and purchase On Demand and pay per view programming. Find out more on page 29.



**SuperTicker™** runs at the bottom of the screen and brings you one-touch access to weather, sports, news, and more. Use the remote to see headline details. Find out more on page 30.

## Use this guide

Each chapter includes a short table of contents at the beginning, listing all the topics provided in that chapter.

At the back of this book there is a glossary and index. Use these sections to find answers to specific questions.

Notes appear throughout this book. The notes have icons to indicate the subject.



---

Notes with a red icon contain cautionary or warning information. Failure to heed this information could lead to damaged or malfunctioning equipment or loss of data.

---



---

Notes with the blue icon contain informative tips or answers to common questions.

---



---

Notes with the orange icon contain something to try out.

---

When a word is displayed in bold text, it either refers to an element of the Moxi Menu or a button on the remote or front panel that requires user action. For example, press **OK** on the remote control.

## Learning the lingo

To help you navigate the Moxi Menu (see figure on page, 6), this guide uses the following terms to describe menu elements:

- **Horizontal categories**—Press the orange **Moxi** button on the remote control to launch the Moxi Menu that displays the options in the horizontal band. Some categories include Settings, Channels, Movies, and other similar options.
- **Vertical cards**—Navigate all horizontal categories to view more options that appear in the vertical band.
- **Center focus**—Navigate through the Moxi Menu and any category or card on which you stop is the center focus. Often, the center focus has an associated action menu.
- **Action menus**—Press **OK** on the remote for any vertical card in focus, and different action choices and commands appear. These menus require your input or a decision.
- **Flip bar**—Press the navigation **arrow** keys on the remote control while watching full screen TV, which opens a banner at the bottom of the screen. This banner enables you to browse the electronic program guide while the current show remains full screen.

For more lingo, see the *Glossary* on page 71.

# Use and program the remote

Functions of the Moxi remote ..... 14  
Program the remote ..... 16  
Infrared emitter ..... 17

This chapter provides information about remote functions and programming.

### Functions of the Moxi remote

The Moxi remote operates the Moxi 3012, and—once programmed—will simultaneously control the power, volume, and mute functions of your TV or audio receiver, depending on the number of devices you program.



---

The Moxi remote may not support certain devices.

---

Your cable operator may supply a different remote. If your remote does not look like the one pictured in the following figure, refer to the information provided with that remote for programming instructions.



---

When replacing batteries, use only high quality alkaline batteries designed for use in electronic equipment.

---

### Multi-function buttons

Some buttons have different functions depending on what application you are using, whether you are watching live TV, or navigating the Moxi Menu. For example, the **ch+** button displays the flip bar, pages through the channels category in the Moxi Menu, and also switches to the next channel while watching live TV. See the following figure for details on all the buttons and functions.

# Use and program the remote

2

**\*buy** jumps to buying PPV and toggles the SuperTicker  
**ticker** displays and hides SuperTicker™  
**power** turns the TV and other audio devices on and off  
**Moxi lens** jumps to the Video on Demand category  
**live TV** jumps to full-screen live TV

**play** starts a program or photo slideshow  
**rew** multi-speed rewind for playback (press multiple times to select speed)  
**fwd** multi-speed fast forward for playback of stored or recorded video (press multiple times to select the speed)  
**rec** starts recording a show  
**stop** stops a program or photo slideshow  
**pause** pauses a live or recorded show, or photo slideshow  
**replay** jumps back seven seconds, moves the Moxi Menu back one day  
**skip** jumps ahead in stored or recorded video (30 second default), moves the Moxi Menu forward one day

**number** tunes directly to channels, enter text in menus, make choices in games  
**1** press once to backspace during text entry  
**0** press once to add a space during text entry  
**clear** deletes items (recorded shows and photos) from menus and clears elements from full screen view  
**enter** executes numeric and text entries

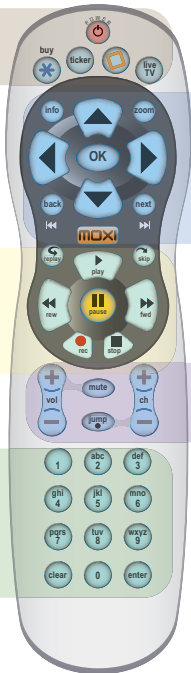

**info** displays additional information about the selected item  
**zoom** toggles between an open Moxi Menu and full-screen TV without losing menu position  
**arrow** navigate menus, play games (hold for turbo speed), and exit most menus (hold left arrow for turbo speed)  
**OK** selects or activates the chosen item  
**back** jumps back 15 minutes, shows previous note page, jumps 30 minutes in the Moxi Menu, goes to the previous photo  
**next** jumps forward 15 minutes, shows next note page, jumps 30 minutes in the Moxi Menu, goes to the next photo  
**MOXI** takes you back to the Channels category, and then back to full screen

**vol** adjust the audio volume on the TV or audio device  
**mute** toggles sound on and off  
**jump** goes to the last viewed channel.  
**ch** change channels or pages through vertical menus (hold for turbo speed)

### Program the remote

Before you begin, find the codes for your TV from the table starting on page 62. Write them here:

---

---

---

If you have an audio receiver, find the codes in the table starting on page 67. Write them here:

---

---

---

Use one of the following procedures:

- *Programming with codes*
- *Programming by search* on page 16 — use this if your brand is not listed or if the given codes do not work.

### Programming with codes

Program the Moxi remote to control TV power and volume, as well as power, volume, and mute for an audio device.



Some older devices may not be supported. If the device fails to respond to any code, use its original remote to control it.

1. In front of the TV, press and hold the **Moxi** and **OK** buttons simultaneously on the Moxi remote, until the LED at the top of the remote blinks twice.
2. Using the number buttons on the remote, enter one of the codes for your device that you wrote down or from the reference tables starting on page 61. When you enter a code correctly, the LED blinks twice. If it blinks once, the code was invalid—try entering the code again. If the code was correct for your device, then the device responds automatically (turns on or off).
3. If the TV or device does not respond, start over using another listed code. Repeat until successful, or see *Programming by search* on page 16.

### Programming by search

If the TV or audio device is not listed, or the codes listed do not work, try programming by search. Programming by search allows the remote to cycle through codes to find one that works with the TV or audio device.



## Use and program the remote

2

Once programmed with two device codes, the remote controls power for the TV and the second audio device, as well as volume and mute for the second (audio) device.



Some older devices may not be supported. If the device fails to respond to any code, use its original remote to control it.

1. In front of the device, press and hold the **Moxi** and **OK** buttons simultaneously on the Moxi remote, until the LED at the top of the remote blinks twice.
2. Slowly, press the **ch+** button repeatedly to advance through the code list until the device responds (turns on or off).
3. Once the device responds, press the **OK** button to set the current code.
4. Press the **power** button on the remote control. If the device does not respond, repeat the previous steps pressing the **ch+** button more slowly.

### Additional programming features

To view which device you have programmed for a specific remote control key:

1. Press the **Moxi** button and **OK** buttons.
2. Press the **info** button, and then press any one of the four programmable keys (such as, **vol+/-**, **mute**, or **power**).

The LED light for the power button blinks back the code, blinking the number of times equal to the first digit of the code, then pausing

before blinking the number of times equal to the second digit in the code, and so forth. For the digit 0, the LED blinks rapidly several times.



The default settings for the **vol+/-** and **mute** buttons control the TV when there is not an audio device programmed. When an audio device is programmed, then the default settings for the **vol +/-** and **mute** buttons are controlled through that device.

To reset the Moxi remote to the original factory settings:

Press the **Moxi** plus **OK** buttons simultaneously and hold until the LED light blinks twice, and then press **clear, clear, clear**.

### Infrared emitter

When a button on the remote is pressed, the infrared signal is sent to an IR receiver on the front panel of the Moxi HD digital video recorder, sending commands to electronic components.

For the IR emitter to send its signals to the Moxi 3012, it must have a clear, unobstructed view of the infrared receiver on the front panel of the Moxi digital video recorder. To see the receiver, shine a flashlight at the front panel of the set-top box.





# Use the Moxi Menu

Navigate the Moxi Menu .....	20
Find & Record shows .....	20
Remember your favorite channels .....	22
Use the Moxi Flip Bar .....	23
Use the player bar .....	23
Record shows .....	24
Watch Pay Per View movies .....	29
Watch On Demand shows .....	29
Use SuperTicker™ .....	30
Enjoy Photos .....	31
Read service messages .....	33
Play games .....	34
Learn more about Moxi features .....	34

## Use the Moxi Menu



Look here for detailed information about how to use all the fun features provided by the Moxi Menu.

## Navigate the Moxi Menu

The Moxi Menu filters TV programs and features into categories such as Channels, Movies, Sports, Kids, and more. These category cards appear in the horizontal band. The vertical band contains the list of choices for that category.



1. Press the orange **Moxi** button on the remote to open the Moxi Menu.
2. The **Channels** category card is in center focus (see the previous figure). Use the up and down arrow keys on the remote to scroll vertically.

3. Press the right arrow button once to move to the **Coming Up** menu, and then press the up and down arrows to scroll vertically and see what is showing later on that channel.
4. When you find a show to watch press **OK** and the action menu appears (see the following figure).
5. Press **OK** again to watch a show in progress or select a **record** option for shows coming up.



## Find & Record shows

There are many ways to find shows. Besides channel or menu surfing, you can search by title, keyword, or by category (for example, sports, news, and kids).

## Surfing channels

For a list of current shows, scroll through the listings in the **Channels** category, or other categories.

Use the **Change Time Slot** card to shift the list of programs to a future time slot. The **Change Time Slot** card appears in most categories and includes a menu that allows you to scroll to a specific time.

Use the right arrow to highlight the menu, and then press **OK** to select the time.

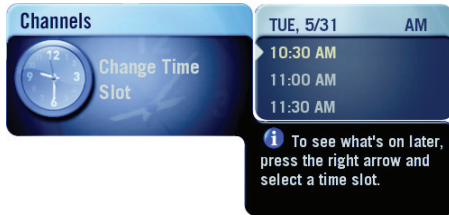

Alternatively, change the time slot by using the remote (see the following figure).

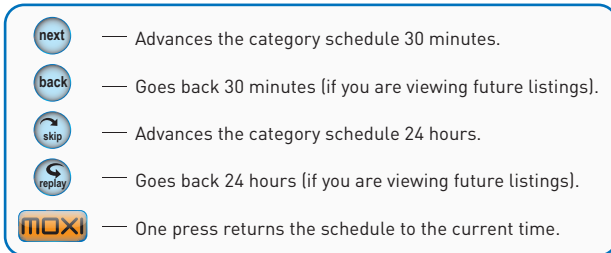

## Searching by title or keyword

1. In the Moxi Menu, scroll to the **Find & Record** category.



2. Choose **By Title** or **By Keyword**, and then enter the search word. You can use any word that may appear in the title or description. Use the arrow keys to highlight a letter, and then press **OK** to enter it. Alternatively, use the number keys as you would when entering letters on a telephone or writing a mobile phone text message.
3. Press the left arrow key repeatedly to dismiss the keyboard and view the results.
4. Select a show, and then press **OK** to open the action menu.



When searching **By Title**, the results list sorts as you type. When searching **By Keyword**, the results appear only after you use the left arrow to view the results.

## Use the Moxi Menu

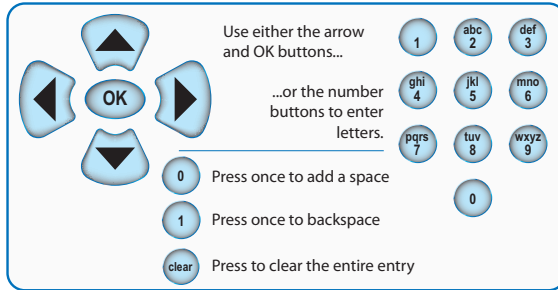

## Searching by category

Search by category organizes shows scheduled in the next 24 hours into filters such as movies, children, sports, and so on. All categories include cards, such as **More Movies** that display additional matches for the next two weeks. Shows can appear in more than one filter.

## Remember your favorite channels

The Moxi Menu automatically builds a list of the 15 channels you watch most frequently and stores them in the **Favorite channels** category (see the following figure).



The favorites list builds from channels that appear in the **Channels** category and excludes any channels blocked by parental controls. Select the **Favorite Channels** category, and then do the following:

- Delete a single channel at a time by choosing the channel, and then selecting **remove channel** on the action menu, or by pressing the **clear** button on the remote.
- Clear the entire favorites list by selecting the **Options** card (you might need to scroll down to see it), and then choosing **clear all**.

## Use the Moxi Flip Bar

While watching full-screen TV, the Moxi Flip Bar displays anytime you press the **arrow** keys, the **OK** button, or enter a channel number. The flip bar provides many of the same functions as the **Channels** card in the Moxi Menu (see the following figure).

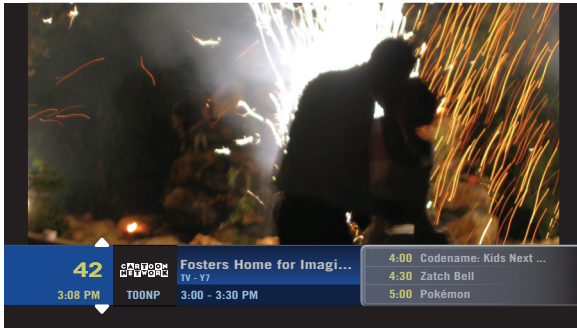

The flip bar scales back the TV picture slightly while displaying a mini program guide about the current and upcoming shows.

- Use the up and down arrows to see what is on other channels.
- Press the right arrow, and scroll down to see what is on later.
- Press **OK** to open the action menu for the chosen show.



Press **clear** to dismiss the flip bar or player bar immediately.

3

## Use the player bar

The player bar appears whenever you press a playback control button (see the following figure).

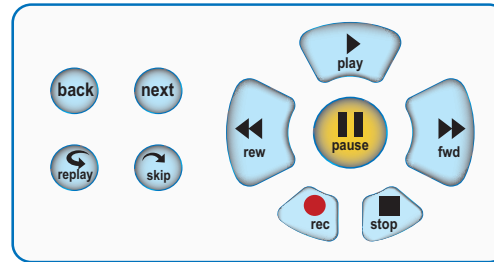

The player bar provides information about the duration of the program and your current playback state, such as:

- Current time
- Amount of the program stored in temporary memory appears in blue (see the following Live program figure)
- Program begin and end time or the duration of a recorded program (see the following Recorded program figure)

## Use the Moxi Menu



- Playing state of the program (rewind, fast-forward, pause, play, or recording)

When you start watching a show, the Moxi 3012 begins storing it in temporary memory. The amount of temporary memory varies, but is never less than 30 minutes (10 minutes for HDTV).

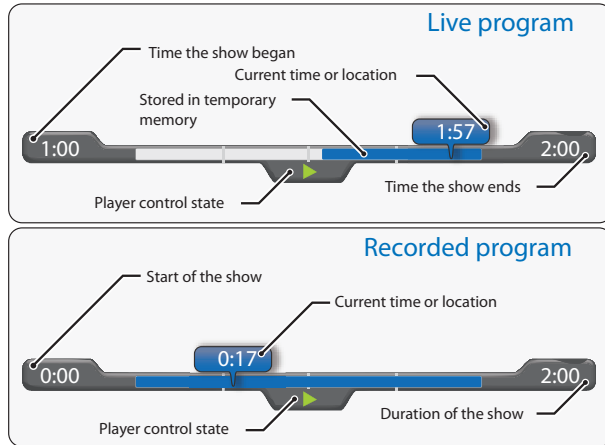

If you are watching a live program, you can use the playback controls, such as rewind or replay, on any portion of the show stored in temporary memory. To record it along with the remainder of the show, press **rec**, and then press **OK**.

## Record shows





To schedule a recording, highlight it in the Moxi Menu, and then press the **rec** button (or simply press **rec** if you are already watching the show). Alternatively, press **OK**, and then choose one of the following recording options:

- **Record once** — To record only the current episode of the show.
- **Record series** — To record this show every time it airs on the current channel.
- **See all times** — To see other times the show will air in the future. This is helpful if you missed part of a program but want to record the entire program. You can then schedule a recording from the search results.



### Understanding the recording icons

Program card icons appear in the upper right of a show's card in the Moxi Menu and let you know the status of a recorded show or scheduled recording (see the following figure).

-  The show is scheduled to be recorded.
-  The media center is recording the show right now.
-  The show is recorded and can only be deleted manually.
-  The show is recorded and may be deleted by the Moxi 3012 when space is needed for newer shows.

Once a recording is scheduled, a blue circle icon appears on the program card (see the following figure).

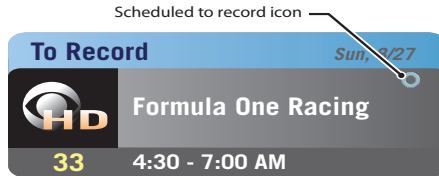

The background color of a program card indicates whether the show is on now, in the future, recorded, or being recorded (see the following figure).

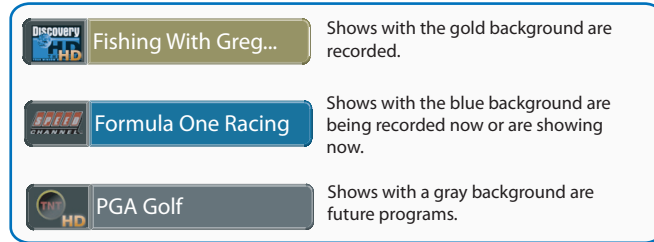

### Finding a previously scheduled recording

To find a specific show already scheduled to record, go to the **Find & Record** category. You can use one of the search features or open the **Scheduled to Record** card. A listing of all scheduled recordings in the next two weeks appears.

### Recording options

To change recording options, when the scheduled show is in center focus, press **OK**, and then choose **recording options** from the options list. The menu summarizes the current options, which you can then modify (see the following figure).

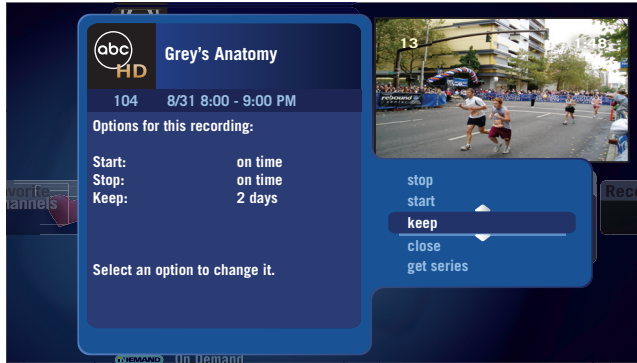

You can change the start, stop, and keep settings or choose to record the series.

- **Stop:** The default setting is **on time**. You can choose to stop the recording up to five minutes early or up to 90 minutes late.
- **Start:** The default setting is **on time**. You can choose to start the recording up to five minutes early or late.
- **Keep:** The default setting is **2 days**, which means the program is eligible for deletion after two days, but not deleted until space is needed for new recordings. You can choose to keep the program protected until space is needed, up to four days, or until you delete it manually.
- **Close:** This closes the menu and saves any changes you made.



You can press the left arrow to close and exit most menus.

- **Get series** or **series options:** This selection opens the series options menu. For more information on controlling series recordings, see *Recording series*, below.

### Recording series

The **record series** option is available from the action menu anytime you select a series episode in the Moxi Menu. If you select **record series**, The Moxi digital video recorder records the series according to your settings, which are accessible from any episode, or go to the **Find & Record** category.

1. Open the **Series Options** card.
2. Scroll to the series you want to update.
3. Press **OK**.
4. Select **recording options** from the menu. The current options for the series are summarized on the left in the following figure.

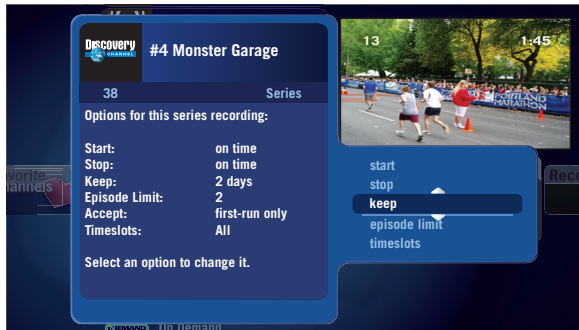

5. Select an option to change it.

- **Stop:** The default setting is **on time**. You can stop the recording up to five minutes early or up to 90 minutes late.
- **Start:** The default setting is **on time**. You can start the recording up to five minutes early or late.
- **Keep:** The default setting is **two days**, which means the program is eligible for deletion after two days, but it is not deleted until space is needed for new recordings. You can choose to keep the program protected only until space is needed, up to four days, or until you delete it manually.
- **Episode Limit:** This sets the maximum number of episodes of the series that the Moxi digital video recorder will record. If the maximum is reached, new recordings of the series replace the oldest recording of the series. The default setting is five but this can be changed to any number between one and five. You can also remove the limit by selecting **unlimited**.
- **Accept:** The default setting is **accept repeats**. If you do not want repeat episodes recorded, choose **first-run only**.
- **Timeslots:** The default setting is **all**. With some shows, you may want to record repeats but you do not want to record all the repeats. For example, if a show airs several times a day, or if a network runs a marathon, you might only want the shows that air during a specific timeslot. The Moxi 3012 checks to see which timeslots are available and allows you to select a single timeslot or set it to **all** to record every episode that meets your other criteria.

## Use the Moxi Menu



- **Priority:** By default, new series recordings are added to the bottom of the list of series recordings. Series priority only matters when more than two series recordings are scheduled for the same time slot. See *Prioritizing series recordings* for more information.

### Prioritizing series recordings

When you schedule a new series recording, it is automatically added to the bottom of the list of series recordings.

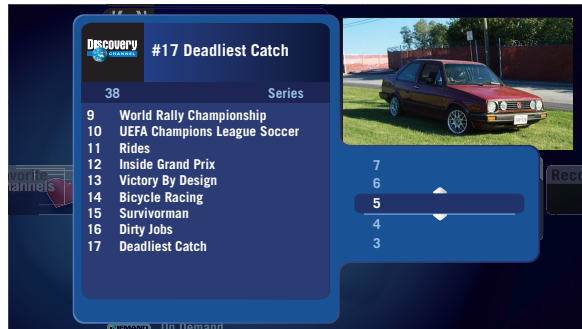

If more than two series recordings are scheduled for the same time on the same day, the Moxi 3012 checks the order in the priority list and only records the two programs with the higher priority.

For example, if there are series recordings set for Thursday evening with series priority ranks of 4, 9, and 23, all in the 9:00 PM timeslot, only the series with ranks of 4 and 9 are recorded.

To change the priority:

1. From the **Find & Record** category, select the **series options** card, choose a series from the list, and then choose **change priority** from the action menu.
2. The menu displays a numbered list of stored series.
3. Use the up or down arrows to prioritize the series (see the previous figure).

### Understanding the storage meter

The **Storage & Stats** card in the **About Moxi** category provides a disk space meter that indicates how much space is in use, storing recorded programs. If an external hard drive is connected, the Moxi 3012 adjusts the meter to account for the extra space (see *External Hard Drive* on page 41). This meter provides a general idea of how much more you can record. The exact space for future recordings depends upon the type of recording (HD or SD), the broadcasting station, and whether or not any stored programs are eligible for deletion.

### Watch Pay Per View movies



Using the **Pay Per View** category, you can see all the available movies, and then purchase them for viewing. Use the arrow buttons to navigate the pay per view movie cards, select a movie showing from the **Coming Up** menu, and then press **OK** to select it. Select the **record/buy** option for future showings or the **watch/buy** option for active programs from the action menu, and then enter your purchase PIN (if required). Select **see all times** to view other viewing show times for rent. Once rented, the movie appears in the **Find & Record** category, **Scheduled to Record** list. After your program records, you can find it in the **Recorded TV** category.

### Watch On Demand shows



Using the **On Demand** category, you can see all the shows available for rental, and then purchase them for viewing. On Demand shows also appear in the **Movies** category. Using the remote control, you can also press the **Moxi Lens**  button to view the **On Demand** category.

On Demand shows start as soon as you rent them, and you can watch them as often as you like for as long as it is available. You cannot record On Demand shows.

During playback, you can only rewind or fast forward On Demand shows using one speed (unlike normal **fwd** and **rew** operation). You can pause an On Demand show for approximately five minutes, after which live TV appears. You can resume your On Demand show where you last left off. To resume playback, in the **On Demand** category, select **resume** from the action menu, or access it from **My Rentals**.

### Use SuperTicker™

When activated, SuperTicker displays up-to-date news headlines, weather forecasts, sports scores, business and entertainment, and stock market updates.

To open or close SuperTicker, press the **ticker** button near the top of the remote or navigate to the SuperTicker category card in the Moxi Menu, and then press **OK**. SuperTicker automatically cycles through all headlines in one topic, and then goes to the next topic.

 Sports scores and stock market index numbers are delayed approximately 15 to 20 minutes. However, all information displayed in SuperTicker is updated every three minutes.

### Reading the whole story

All headlines have a story behind them. To read the story, press **info** on the remote. Use the **next** and **back** buttons to page through the story.



### Locking topics or items

1. Open the SuperTicker card, and use the arrow keys to scroll to a topic or item.
2. Press **OK**.
3. Choose **lock topic** or **lock item** (headline).

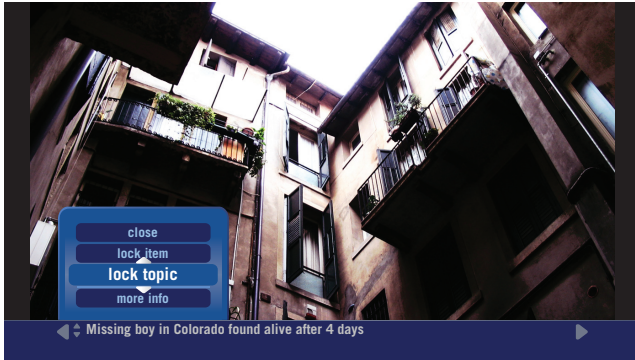

- When a *topic* is locked, the arrows at the sides of the screen change to red and SuperTicker only scrolls through that topic.
- When an *item* is locked, the left and right arrows turn red along with the up and down arrows and SuperTicker is locked on that item.



To toggle between locking and unlocking SuperTicker, press .

## Enjoy Photos

You can load hundreds of digital photos into your **Moxi Photos** category and then play them back as slideshows on your TV.



The Moxi 3012 uses a five percent reserved partition of your total hard disk drive to store photos.

## Uploading photos

1. Attach a memory card reader to a USB port on the front or back panel of the Moxi digital video recorder, insert the memory card containing the photos into the card reader. To avoid using a card reader, you can also use a USB drive.
2. In the **Photos** category, choose **load album**.



The number of photos stored depends upon the file size of each photo. The Moxi 3012 skips any photos larger than 10 MB.

When uploading photos, the Media Storage Capacity bar displays how much reserved photo storage space remains.



If there is insufficient storage space to load your photos, then manually delete photo files to make room.

## Use the Moxi Menu



3. Choose **yes, upload** to confirm. The Moxi 3012 creates a new album, labels it with the current date, and copies the photos stored on the memory card.

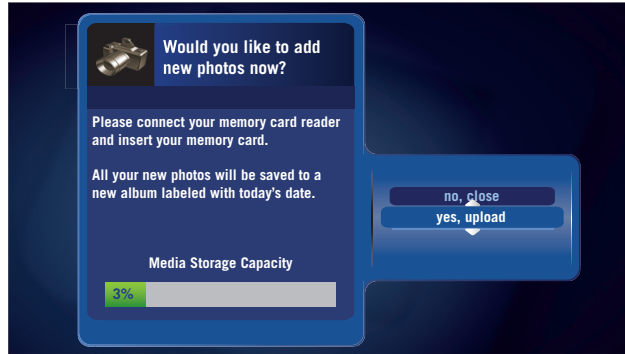

## Viewing photos

Photos are shown at the highest allowed resolution. (See *External Hard Drive* on page 41 for more information on setting TV or monitor resolutions.) Photos are sized to fit the screen without stretching them (the aspect ratio remains correct).

From the Moxi Menu, choose the **Photos** category, and then scroll to the album you want to play. The Moxi 3012 gives you several options:

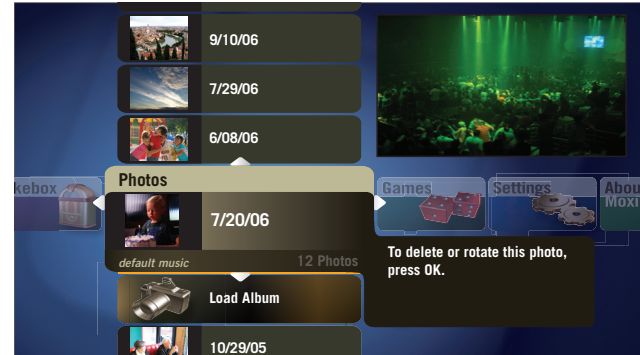

- **View photo** — Displays the photo as uploaded into Moxi.
- **Rotate 90 (clockwise)**— Rotates the image 90 degrees clockwise.
- **Rotate 90 (counter clockwise)**— Rotates the image 90 degrees counter clockwise.
- **Play slideshow** — Plays all photos in the selected album. During the slideshow, each photo appears for about seven seconds. You may use the playback controls to manually control the slideshow. The slideshow plays continuously until you press stop.
- **Open album** — Displays a single photo within an album. Scroll to the photo, and then press **OK**.



- **Delete album** — Removes the photo album.



---

There is no undo for a deleted album.

---

### Photo playback tips

While viewing photos in an album or during a slideshow, you can:

- Press **fwd** or **rew** to speed up or slow down the slideshow.
- Press **pause** to halt the slideshow at the current picture.
- Press the right arrow, **skip**, or **next** to advance to the next photo.
- Press the left arrow, **replay**, or **back** to return to the previous photo.
- When the flip bar is open, press **OK** to see editing options for the photo or the album. The **info** button also opens the editing menu.
- As with all similar products, it is recommended that you create backup files of all your photos. If you replace your Moxi 3012 at any time, you cannot copy your photos onto the replacement unit.

### Read service messages

Service messages are short alerts or notices sent directly from your service provider to your Moxi 3012 about topics such as upcoming software updates, future programming, or anything else related to your use of Moxi. When you have a service message, the message light on the front panel of the Moxi 3012 is lit.

To read the service message:

1. In the Moxi Menu, scroll to the **Service Messages** category.
2. Use the up or down arrows to select the message, and then press **OK** to open it.
3. Use the **next** and **back** buttons to page through the message.

Once you have read the message, you can choose to exit the message, mark it as unread, or delete it.

### Play games

The Moxi 3012 adds to the full entertainment package with fun games you can play directly on your TV. Available games appear in the **Games** category, each with on-screen playing instructions.

Games include:

Slot Machine	Blackjack
Solitaire	Code Breaker
Bubble Blast	Tomato
Video Poker	21 Frenzy

### Learn more about Moxi features

The **About Moxi** category offers several helpful tips on topics such as searching for shows, describing how to stop recording repeats, and more.



### Software version and other details

The **Storage & Stats** card in the **About Moxi** category lists information that may be helpful during a service call.

- **Software version** — the current version of the Moxi software running on the Moxi
- **Box ID** — serial number or hardware device ID (HDID)
- **Date** — the most recent updates for account settings, entitlements, and EPG data

# Personalize Moxi Cable HD DVR

Parental Controls .....	36
Closed Caption .....	39
Widescreen .....	39
HDTV Setup .....	40
External Hard Drive .....	41
Sound Effects .....	42
Channel List.....	43
CableCARD™ .....	43

The Moxi 3012 offers multiple ways for you to customize your personal viewing habits and preferences. Personalizing your Moxi 3012 starts in the **Settings** category.



### Parental Controls

The Moxi 3012 includes a robust parental control feature set, including a four-digit PIN, and the ability to lock shows by MPAA rating or channel.

#### Creating a PIN

The first time you use parental controls, the Moxi 3012 asks you to create a PIN.

1. In the **Settings** category, scroll to the **Parental Controls** card, and then press **OK**.
2. Use the number keys on the remote to enter a four digit PIN, and then enter the PIN again to confirm it.
3. Choose **close**.

The Moxi 3012 still records scheduled shows blocked by parental controls but you must enter the PIN before you can watch them.

#### Changing a PIN

1. In the **Settings** category, scroll to the **Parental Controls** card, and then press **OK**.
2. Choose **settings**, scroll left to the **Change PIN** card, and then press **OK**.
3. Enter the old PIN, enter the new PIN, and then enter the new PIN again to confirm it.

#### Locking channels or programs by rating

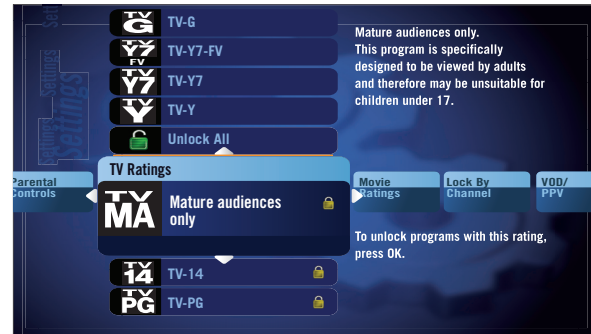

1. In the **Settings** category, scroll to the **Parental Controls** card, and then press **OK**.
2. Choose **Settings**, and then choose either **TV Ratings**, **Movie Ratings**, or **Lock By Channel**.

## Personalize Moxi Cable HD DVR

Each card contains a list of the rating system or a list of channels. Scroll to the format or channel you want to control.

3. Lock the rating or channel by choosing it, and then pressing the **OK** button on the remote. In the previous figure, TV-MA, TV-14, and TV-PG are locked.

**i** When you lock a rating, all ratings for more mature audiences are also locked. For example, if you lock the TVPG rating, then the TV14 and TVMA ratings are also locked. When unlocking, the reverse is also true.

4. To exit parental controls and return to the Moxi Menu, press the **Back** (or choose the back card).

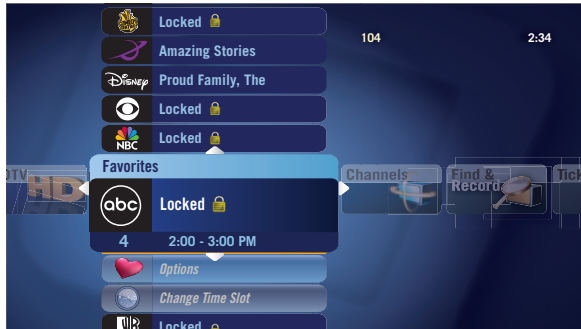

When parental controls are turned on, the names of all locked programs are replaced with "Locked" regardless of where they appear in the Moxi Menu.

**!** If the V-Chip in your TV is enabled, you may see a black screen after tuning to a channel with blocked content. No Moxi Menu, flip bar, sound effects, or any other audio or video are shown or heard. To correct this, change to an unblocked channel, or disable all V-Chip functions and use the parental control features provided by the Moxi 3012 to regulate viewing.

4

## Turning off parental controls

1. Press **OK** on any locked program.
2. Enter your PIN to unlock all programming temporarily or choose **more options** to only unlock the current channel.

To unlock or change all parental control settings, go to the **Settings** category, scroll to the **Parental Controls** card, and then press **OK**.

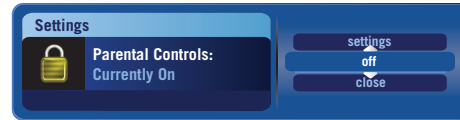

### Setting the relock timer

While configuring parental controls, you can specify how long to leave parental controls unlocked, each time you unlock them to watch a show.

1. In the **Settings** category, scroll to the **Parental Controls** card, and then press **OK**.
2. Choose **settings**, scroll left to the **Set Relock Timer** card, and then press **OK**.
3. Enter your PIN, if prompted.
4. Choose the unlock duration between one and six hours (see the following figure). This option appears anytime you unlock parental controls.

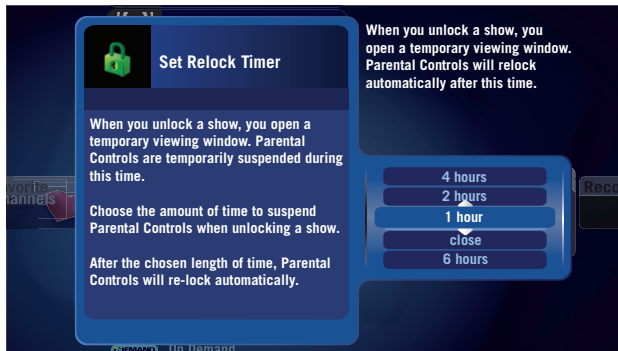

Once set, the **Parental Controls** card category displays the relock time (see the following figure).

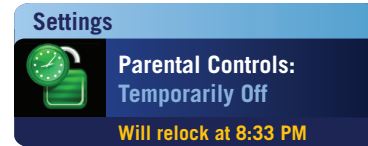

### Controlling Pay Per View or On Demand purchases

To restrict the purchase of Pay Per View or On Demand programs, use the same PIN as with parental controls. See *Creating a PIN* on page 36 for more information on creating a PIN.

1. In the **Settings** category, scroll to the **Parental Controls** card, and then press **OK**.
2. Choose **settings**.
3. Scroll to the **On Demand / Pay Per View Purchases** card, and then press **OK**.
4. Enter your PIN to require that the PIN be entered whenever a purchase is made.

### If you forget your PIN

If you forget your PIN:

1. Call your cable provider.
2. After the representative resets the PIN, create a new PIN immediately, using the Moxi Settings, Parental Controls card (see *Changing a PIN* on page 36).

### Closed Caption

Most viewers use these settings to toggle closed **captioning** on or off. However, you can select one of the following closed caption cards, to set other preferences:

- **Display Preferences**—Choose a font type, window background and color, and other similar closed caption display settings.
- **Preferred Language**—Set the primary and secondary language display reference.
- **Digital Services**—Scroll through the additional digital stream service cards provided, and press **OK** to select them. You can only have one selected at a time.
- **Basic Services**—Scroll through the various basic service cards provided, and press **OK** to select them. You can only have one selected at a time.

### Widescreen

The widescreen settings only take effect if the broadcast is presented in 16:9, or widescreen, format.

- **Letter box** — Maintains the aspect ratio of the original content and adds black or gray bars at the top and bottom of the screen. This is the best choice if you have a standard TV.

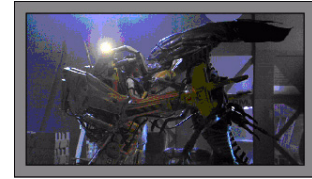

- **Cropped** — Fills the entire screen with the picture by cropping out the left and right edges of the picture. This is an alternative setting for standard TVs.

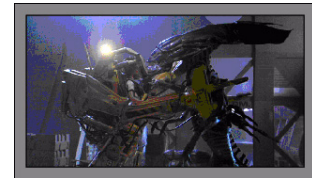
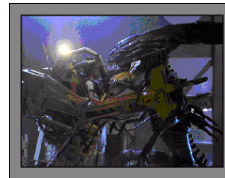

To use the Moxi 3012 to change the widescreen settings, do the following

1. Go to the **Widescreen** card in the **Settings** category.
2. Select the desired output setting (for example, cropped, wide mode, or letter box), and then choose **close**.

## HDTV Setup

The Moxi 3012 automatically adjusts the video output to match the broadcast format and the selections you make in the **HDTV Setup** card.

The video resolution options are 480i, 480p, 720p, and 1080i. Always use the best resolution allowed by your TV. The following table displays which resolutions are supported by which cables.

**Table 1:** Video connections and supported resolutions

	480i (SD)	480p	720p	1080i
HDMI digital video	X	X	X	X
Component video (YPbPr)	X	X	X	X
S-Video	X			
	X			
RF (some models)	X			

**Table 1:** Video connections and supported resolutions (Continued)

Connection	480i (SD)	480p	720p	1080i
	X	X	X	X

For information on audio cables, see table 4 on page 54.



If the screen goes blank after you select a video resolution in error, do not push any buttons, but wait thirty seconds for video to come back. If it does not, see *No video displayed* on page 46 to fix it.

## Setting standard TV video resolution

If your TV is a standard definition (SD) TV, make sure 480i is the only box checked. All other video resolutions will be output at 480i. You can still watch HD channels and they may look considerably better than their SD counterparts.



### External Hard Drive

If you have the **External Hard Drive** card in the Moxi Menu, then you may connect an external hard drive to your Moxi. To activate the external hard drive, you may need to restart the Moxi 3012 after connection. If you need to remove the external hard drive for any reason, stop all recordings, and choose **disconnect**.

The Moxi 3012 supports external hard drives that use one, distinct partition or volume. The Moxi 3012 does not recognize or support external hard drives that are formatted at the factory with two, separate, and distinct volumes.

### Using an external hard drive

To provide additional space for recorded programs, you may connect one external hard drive to the rear eSATA port on the Moxi. Currently, the Moxi 3012 supports external drives with a maximum storage capacity of one terabyte.



External hard drives are required to operate continuously. If it has a "sleep" mode, you may need to disable that mode. Consult the manufacturer documentation for instructions (see *Running out of storage space* on page 48 for troubleshooting information).

Once the Moxi 3012 recognizes the external hard drive, programs stored on it appear in the **Recorded TV** category and any other applicable categories. If the Moxi 3012 fails to recognize the external hard drive automatically, leave it connected and restart the Moxi 3012.

- There is no limit to the number of external hard drives you can associate with the Moxi 3012, but connect only one at a time.



External hard drives used with the Moxi 3012 must be dedicated for use with only that Moxi 3012. Moving the external hard drive between different units, or using it for storing other data will cause the loss of all programs previously stored on the external hard drive. Associating a used external hard drive with a different Moxi 3012 requires that you reformat the external hard drive, which results in losing stored video.

- The external hard drive is only used to store recordings, not photos.
- You do not have to decide which drive to store recorded video. The Moxi 3012 does this for you automatically.

### Connecting an external hard drive

Connect only one external hard drive at a time directly to the eSATA port on the rear of the Moxi 3012.



1. Restart the Moxi 3012 and wait for it to recognize the external hard drive. If the Moxi 3012 fails to recognize the external hard drive automatically, leave it connected and restart the Moxi 3012.
2. If this is the first time you have connected this hard drive to this Moxi 3012, or if the hard drive is not properly formatted, the system prompts you to format the hard drive.



If you choose to format the external hard drive, all data on the drive will be deleted. You must do this to use the external hard drive with the Moxi 3012.

3. If you choose to **reformat**, then select **yes** to confirm.
4. Once the external hard drive is recognized as properly formatted and ready for use, the Moxi 3012 adjusts the recording schedule to account for the additional space.

### Disconnecting an external hard drive

Disconnecting an external hard drive while it is in use (playing a recording or recording a show), can result in corrupting stored data.

To disconnect the external hard drive:

1. Manually stop all recordings in progress by selecting the program card in the Moxi Menu, and then choosing **stop recording**.
2. In the **Settings** category, select the **External Hard Drive** card.
3. Select **disconnect**, and then press **OK**.

A message appears notifying you that it is OK to disconnect the drive.

If you experience issues with recordings stored on your external hard drive, see *External hard drive issues* on page 47.

### Sound Effects

You can adjust the volume for remote key sound effects by choosing between three volume levels or mute them entirely.

1. In the **Settings** category, go to the **Sound Effects** card, and press **OK** on the remote.
2. Choose the desired output setting, and then choose **close**.



### Channel List

You can modify the channel list, if there are channels you never watch, or do not want to appear in any channel filters.

1. In the **Settings** category, navigate to the **Channel List** card.
2. Scroll up or down to the channel you want to remove or restore.
3. Press **OK**.

That channel no longer appears in the main **Channels** category or, if you restored it, appears once again.

### CableCARD™

You can view CableCARD information supplied by the CableCARD provider from the Moxi Menu. The CableCARD device is used to access premium channels, Pay Per View, and On Demand content.

1. In the **Settings** category, navigate to the **CableCARD** card.
2. Select **info** on the action menu.
3. Scroll up and down to select from the following information cards provided by the CableCARD manufacturer, and then press **OK**:
  - Conditional Access
  - CableCARD Status
  - Network Setup
  - CableCARD Pairing
  - DSG (DOCSIS Set-top Gateway)
  - Interactive Info





# Troubleshoot

Audio and video problems .....	46
Remote or front panel control problems.....	47
External hard drive issues .....	47
Use the front panel to troubleshoot .....	49

This section addresses issues related to operating the Moxi 3012.

### Audio and video problems

The following procedures address connectivity and configuration issues between your cable connection, TV, and the Moxi 3012.

#### No video displayed

1. Check the cabling between the Moxi 3012 and the TV to make sure it is connected correctly and securely.
2. Verify that the TV has the proper video settings (line 1, channel 3, S-Video, and so on).
3. Verify that the V-Chip in the TV is disabled. Instead, use the parental controls on the Moxi 3012 to control viewing.

Use the front panel controls to manually set the video resolution.

1. Press the **Up** arrow and **Menu** button for three seconds.
2. Press the **Left** or **Right** arrows twice to cycle through the options, and then press **OK** to choose the selected resolution option.
3. At the video display prompt on your TV, use the **Up** and **Down** arrows to select **Yes** or **No**, and then press **OK** to make your selection.

#### Static on screen or poor picture quality

1. Make sure the Moxi 3012 is plugged in and the TV is turned on.
2. Check that all cables are connected to the proper ports and are secure.
3. Verify that the TV is set to the correct video input.
4. Verify that the TV displays video without being connected to the Moxi 3012. If not, this can indicate a problem with the signal, wiring, or your service provider.

#### TV audio and video out-of-sync

1. For TVs that have their own audio output, connect both the audio and video from the Moxi 3012 to the TV (using cables of your choosing, such as HDMI, component, and so forth).
2. Then connect the TV's audio output to the audio device. This way, the TV applies the same delay to both, and synchronization is restored.
3. Reset the Moxi 3012 by pressing and holding the reset button until the LED display begins to change (starting with 0000). Allow about five minutes for the system to start.

#### Cannot change TV channels

1. Check the cabling between the Moxi 3012 and the TV.
2. Begin recording live TV, and then try changing the channel.
3. Make sure the remote has fresh batteries.
4. Try using the front panel to change channels.

5. Make sure the remote is programmed correctly for your TV and is set to the proper device mode. (See Use and program the remote on page 13 for more information.)

## Remote or front panel control problems

### Cannot control the Moxi 3012 using front panel buttons

Try using the Moxi remote. If it works, call customer service.

### Cannot control TV using the remote

You cannot control the Moxi Menu using the remote control; however, the Moxi 3012 front panel control buttons work.

- Make sure the remote has fresh batteries.
- Check the line of sight between the remote and the front of the Moxi 3012 for obstructions.
- If the Moxi 3012 responds sluggishly or intermittently to remote control key presses, the problem may be caused by the TV. Some TVs, including those with backlight systems, emit a frequency that interferes with the frequency used by the remote control. Try relocating the TV or the Moxi 3012 so that the Moxi 3012 is well behind the TV.

## External hard drive issues

Use the following tips if you experience issues with your external hard drive.

### Recovering corrupted programs

The Moxi 3012 may prompt you to reformat an external hard drive that has already been formatted for use with the Moxi 3012 and contains recorded programs. Your recordings may be recoverable.

1. When the message appears, select **Close** to dismiss the message.
2. Turn off the external hard drive and unplug the Moxi 3012. Then Plug in the Moxi 3012 and restart the external hard drive.
3. Wait until all disk activity stops. This may take several minutes but it indicates that the Moxi 3012 is attempting to resolve the corrupt data.
4. Check the **Recorded TV** category for recovered recordings. If they do not appear, repeat this procedure once more. If they still do not appear, the recordings are corrupt and the external hard drive must be reformatted.

### Running out of storage space

Some external hard drives have software drivers that induce a sleep mode when inactive. The Moxi software cannot awaken these particular drives from the sleep mode resulting in limited video recording storage space.



---

If you already connected the external hard drive to the Moxi 3012 and formatted the drive, then to fix this issue you must reformat the drive. Be aware that reformatting the drive results in losing shows already stored on the drive.

---

#### To fix an external hard drive already connected to the Moxi HD DVR

1. To remove the external hard drive from the Moxi 3012, in the Moxi Menu navigate to the **Settings** category, select the **External Hard Drive** card, and then press **OK**.
2. Select **disconnect** from the action menu.
3. Connect the external hard drive to a PC.
4. When you format the drive for use with the Moxi 3012, the software driver is removed, so you must reinstall it. On your PC, visit the external hard drive manufacturer's Web site, and download the software drivers for your drive type onto the external hard drive.
5. Once the software driver installs, adjust the Sleep Mode to OFF. Be aware that disabling the sleep mode could void your external hard drive warranty. Consult the manufacturer's warranty policy for more details.

6. You can now disconnect the external hard drive from the PC, and reconnect it to the Moxi 3012 for reformatting (see page 42).

#### To prevent this issue with a new external hard drive

1. Before connecting your external hard to the Moxi 3012, connect your external hard drive to a PC. The software driver application opens.
2. Adjust the Sleep Mode to OFF. Be aware that disabling the sleep mode could void your external hard drive warranty. Consult the manufacturer's warranty policy for more details.
3. You can now disconnect the external hard drive from the PC, and then connect it to the Moxi 3012 for formatting (see page 42).

### Moxi 3012 unable to recognize your external hard drive

- If the Moxi 3012 fails to recognize the external hard drive automatically, leave the external hard drive connected and unplug and then replug the Moxi 3012.
- Some external hard drives use an advanced partition scheme, which means the drive was formatted at the factory with two partitions; a CD partition and a hard disk partition. Typically, these partitions are recognized as two separate and distinct volumes. Currently, the Moxi 3012 does not recognize the two separate partitions. Therefore, you are unable to use these particular, two-partition, external hard drives with your Moxi 3012.



## Use the front panel to troubleshoot

### Changing video display output using the front panel

When you want to use the front panel buttons to change the video mode/resolution, use the following button-press combination. Resolution options include:

- SD (for 480i)
- 480p
- 720p
- 1080 (for 1080i)

To change the TV resolution using the front panel buttons:

1. Press the **Up** arrow and **Menu** button for three seconds.
2. Press the **Left** or **Right** arrows twice to cycle through the options, and then press **OK** to choose the selected resolution option.
3. At the video display prompt on your TV, use the **Up** and **Down** arrows to select **Yes** or **No**, and then press **OK** to make your selection.



---

If you have an HDTV, go to the **Settings** category in the Moxi Menu. Select **HDTV Setup** and choose the highest resolution that your TV supports.

---



# Get Connected

System specifications .....	52
Before connecting.....	52
Available ports.....	53
Connect to the TV and receiver.....	56
Connect archiving components.....	57

Use the audio, video, and additional data storage ports available when connecting your Moxi 3012 to the TV.

## System specifications

The following table lists the specifications for the Moxi 3012.

**Table 2:** Moxi 3012 specifications

	Quantifier
Model number	HD DVR 3012
Power supply	<ul style="list-style-type: none"> <li>Line input voltage 110 V to 125 VAC</li> <li>1.6 amps</li> <li>Frequency 50 Hz to 60 Hz</li> </ul>
USB power (front)	One USB 2.0 connectors, 5 V, 500 mA
USB power (rear)	One USB 2.0 connectors, 5 V, 500 mA
HDMI power	5 V, 55 mA
IEEE 1394	One large 4-pin

**Table 2:** Moxi 3012 specifications (Continued)

Feature	Quantifier
Operating temperature	<p>0 degrees Celsius to 40 degrees Celsius (32 Fahrenheit to 104 Fahrenheit) from 5% to 90% non-condensing relative</p> <p>Do not operate the Moxi 3012 at extreme hot or cold temperatures even within this range. Doing so can result in damage to the Moxi 3012 and/or other property and possibly personal injury. Please refer to the Safety Information for more instructions.</p>
Dimensions (WxHxD)	17"W x 3.2"H x 12"D
Weight	Approximately 10 pounds

## Before connecting

Before installing, the Moxi 3012 installation environment must meet the following physical requirements:

- Locate the Moxi 3012 within six feet of a power outlet.
- Do not use an extension cord, but rather use a power strip with surge protection.
- Make sure the infra-red receiver on the Moxi 3012 and the remote are free from obstructions, such as furniture and doors.

## Ventilation requirements

To prevent overheating, allow adequate ventilation and airflow around the Moxi. The Moxi 3012 requires at least a two-inch (5 cm) clearance on top and all sides with airflow to the rear.

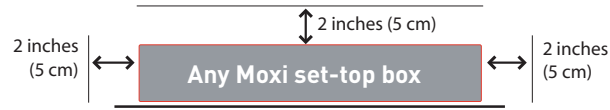

See the Regulatory Information and Product Safety Information and Warnings document for more important safety and regulatory instructions and notices.

**Table 3:** Video cables, starting with highest quality connection







Connector shapes	Cable type	Description
	HDMI	<p>A digital audio and video connection capable of displaying 480i, 480p, 720p, and 1080i video resolution. The TV must be HDCP-compliant. If your TV has a DVI-D port but no HDMI port, you may use video output from the Moxi 3012 with an HDMI to DVI conversion cable. If an HDMI cable or an HDMI to DVI conversion cable is used along with an intermediate device such as an audio/video receiver, video might not be passed through the intermediate device to the TV. If this happens, connect the Moxi 3012 directly to the TV.</p> <p>When configuring 480i, the output connection is automatically routed to the port into which the TV is plugged.</p> <p>You can also have video out from an HDMI cable and an analog port.</p>

## Available ports



Before connecting the Moxi 3012, consider the equipment to which it will be connected. Is your TV standard definition (SD) or high definition TV (HDTV)? Is there a receiver? If so, does it accept S/PDIF? Are you connecting an external storage device? If so, is it eSATA?

The characteristics of the connections offered on the Moxi 3012 are listed in table 3 (video cables), table 4 on page 54 (audio cables), and table 5 on page 55 (external hard drives).

**Table 3:** Video cables, starting with highest quality connection (Continued)

Connector shapes	Cable type	Description
	Component	A three-wire analog video connection capable of displaying 480i, 480p, 720p, and 1080i video resolutions from the Moxi. Component is the most user-friendly HD and standard video connection for the Moxi.
 	S-Video	An analog video connection with better quality than Composite. S-Video is capable of displaying 480i video from the Moxi.
 V 	Composite or RCA	An analog video connection. Composite supports 480i video output.
 	IEEE 1394	A high-bandwidth digital connection, sometimes called FireWire®. The Moxi 3012 provides an MPEG 2 audio and video stream for recording or display on a digital device in the same resolution as the broadcast. No user interface graphics appear (like, Moxi Menu, flip bar, and so forth) nor is there menu audio.

**Table 4:** Audio cables starting with highest quality connection

Connector shapes	Cable type	Description
 	S/PDIF (optical)	A digital audio connection that carries high-quality Dolby Digital audio. No need to use an S/PDIF cable, if using an HDMI video cable connection (transmits both video and audio).

**Table 4:** Audio cables starting with highest quality connection (Continued)

Connector shapes	Cable type	Description
	RCA	An analog stereo audio connection. No need to use an RCA cable, if using an HDMI video cable connection (transmits both video and audio).

**Table 5:** Data storage cables starting with highest quality connections

Connector shapes	Cable type	Description
	eSATA	Transfers data at a rate of 2400 megabits per second to and from external hard disks and optical drives. Your actual rate of data transfer can vary.

### Connect to the TV and receiver

The Moxi 3012 supports multiple types of audio and video connections. It is recommended that you use the highest-quality connection supported by both the TV or audio receiver and the Moxi.

Before installing or connecting the Moxi 3012, review all instructions and the Regulatory Information and Product Safety Information and Warnings document.

 Do not plug the Moxi 3012 into a power source just yet.

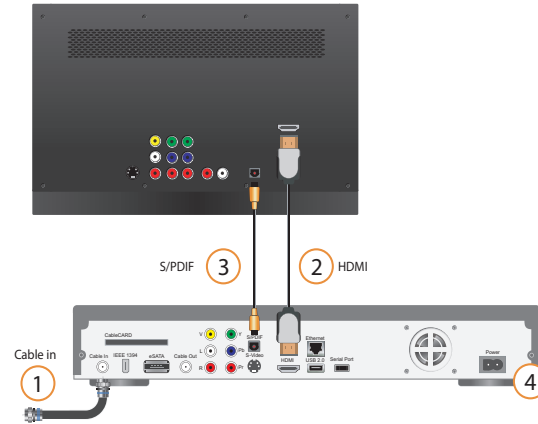

1. Place the Moxi 3012 in a well-ventilated open area near the TV and audio receiver (if used), and then connect the incoming coaxial cable to the Moxi.
2. Install one of the following video connections (refer to the previous figure):



- For HD and supported TVs, connect an HDMI cable between the Moxi 3012 and the HDTV (refer to the previous figure on page 56).

---

**i** If an HDMI cable or an HDMI to DVI conversion cable is used along with an intermediate device such as an audio/video receiver, video might not be passed through the intermediate device to the TV. If this happens, connect the Moxi 3012 directly to the TV.

---

- If an HDMI connection is unavailable, connect component (YPbPr) cables for HDTV.
- For televisions where HDMI or component is not an option connect an S-Video cable.
- When the previous options are unavailable, use a composite video cable connected to the V port.

For complete list of available connections see, table 3 on page 53.

3. Install one of the following audio connections (only if you are not using HDMI):
  - For digital audio, connect an S/PDIF cable to the Moxi 3012 and receiver or TV.
  - For analog audio to the TV, connect composite stereo cables between the TV and the L and R ports.
  - For analog audio with a receiver, connect composite stereo cables between the receiver and the L and R ports.

For complete list of available connections see, table 4 on page 54.

---

**i** Do not connect Moxi 3012 to a switched power source. Doing so increases the chance that the Moxi 3012 is turned off and is not able to record programs as scheduled.

---

# 6

## Connect archiving components

To add components to the TV connected to the Moxi, such as a DVD-recorder or VCR, refer to the manufacturer's documentation for each device.

---

**i** Copy protected programs cannot be archived to a VCR and may not work with a DVD-R.

---

When installing any secondary device, such as a VCR, do not insert the device in the primary signal path between the Moxi 3012 and the TV, as this may affect the video and audio displayed on the TV. Instead, use a secondary video input to the TV for the VCR (see the following figure). If the content is copy protected, the picture may still appear distorted.

As previously noted, content providers may protect their content with copy protection technologies that limit or prohibit the copying or viewing of their content. If the content is protected by digital copy-

right protection systems, the picture on the additional component may appear distorted or not at all.

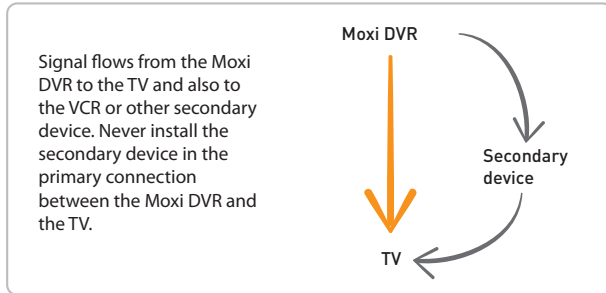

You can connect a secondary, digital monitor using the IEEE 1394 port, but the monitor will not display the Moxi Menu, any other user interface graphics, or the playback of recorded TV stored on your Moxi 3012 (see *IEEE 1394 Connectors* on page 60).

### Archiving simplified

The Moxi 3012 permits personal archiving subject to all applicable third party limitations. To archive a program, you must play back the recorded program while recording it to a connected recording device (such as a VCR). When recording to a VCR from any port, all on-screen activities are recorded. This includes channel changes, navigation of the Moxi Menu, system sounds, and playback actions (pause, stop, rewind, and fast-forward).

### Choosing the archive connection

Variations in VCR and TV technology present many connection options. Determine which connection is used between the TV and the Moxi, and then use an alternate connection to the VCR.

When selecting the connections, consider the video resolution.

- For HD programming, use a connection that supports 720p and/or 1080i.
- For standard definition (480i), use any video connection except the one used by the TV. See the following table for the resolutions supported by each connection.

**Table 6:** Video connections and supported resolutions

	480i	480p	720p	1080i
HDMI	X	X	X	X
Component (YPbPr)	X	X	X	X
IEEE 1394	X	X	X	X
S-Video	X			
Composite (V, L, R)	X			

## Archiving to a VCR

The installation instructions in this document are generic and may need to be adjusted to suit your equipment.

Refer to the VCR manufacturer's documentation before installation.

---

**i** Always maintain an uninterrupted primary video connection directly from the Moxi 3012 to the TV.

---

To use a digital VCR to archive programs:

1. Connect one video cable between the Moxi 3012 and the TV.
  - Connect component cables if they are not already used for the TV.
  - Use composite cables if component is not available.
  - Use IEEE 1394 if your VCR and the Moxi 3012 support it. Using IEEE 1394 allows you to simultaneously view and archive live TV only, it does not support the simultaneous playback and archiving of previously recorded TV stored on your Moxi 3012.

---

**i** Use an IEEE 1394 connection to the TV as a secondary connection only. No user interface graphics are transmitted via IEEE 1394. Recordings made via IEEE 1394 include any channel changes and use of the playback controls.

---

- If IEEE 1394 is not an option, use component if it is not already used for the TV.
  - Use composite if component is not available.
2. Unless you used IEEE 1394 or HDMI, which carries audio and video, connect an audio cable between the Moxi 3012 and your VCR. Use S/PDIF or composite.
  3. Connect another set of audio and video cables between the VCR and the TV.
  4. Play the recorded program while recording with the VCR.

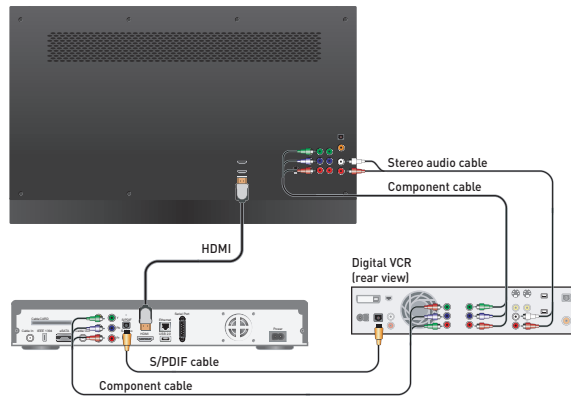

The TV now has at least two sets of video cables: one to watch live or recorded programming from the Moxi, and another to watch recorded programming from the VCR.

### IEEE 1394 Connectors

There are several IEEE 1394 connector options. Make sure you have a cable with the large 4-pin or 6-pin connector at one end for the Moxi 3012 and, at the other end, a connector that fits the digital VCR (see the following figure).

There are three types of IEEE 1394 connectors:



6-pin powered



4-pin unpowered (used on Moxi systems)



4-pin (used on many digital media devices)

A cable with a 6-pin connector works in the larger 4-pin port but does not supply power to the secondary device.

# Moxi remote programming codes

TV codes for the Moxi remote control .....	62
Audio device codes for the Moxi remote control .....	67

This chapter provides a listing of all programmable TV and audio device codes stored in the Moxi remote. See *Use and program the remote* on page 13 for more information

### TV codes for the Moxi remote control

Use the codes in table 7 to program the remote for your TV and the codes in table 8 on page 67 to program audio devices.

Table 7 TV codes

TV	Code
Admiral	026, 054, 211, 213
Advent	072, 094, 425, 447, 463
Adventura	047
Aiwa	214, 471
Akai	053, 462, 473, 522, 524, 547, 572, 586
Amark	023, 215
Amstrad	157
Anam	217, 218, 219, 220, 221, 222, 223
AOC	053
APEX	030, 038, 427

Table 7 TV codes (Continued)

TV	Code
Audiovox	191, 220, 465
Belcor	073
Bell & Howell	211, 213
BenQ	454
Broksonic	165, 167
Brokwood	073
Candle	068, 091
Centurion	095, 107, 108
Citizen	068, 091, 211, 213, 233
Coby	558
Concerto	073, 095
Contec	147
Coronado	023
Craig	223
Crown	023
Curtis Mathes	016, 054, 107, 108, 211, 213

## Moxi remote programming codes

# 7

Table 7 TV codes (Continued)

TV	Code
Daewoo	051, 068, 073, 095, 158, 159, 189, 191, 194, 196, 197, 198, 200, 202, 204, 205, 206
Daytron	073, 095, 107, 108, 207, 209
Dell	072, 094
Diamond Vision	563
Dumont	073
Dynex	167, 415, 424, 567, 577
Electro Home	073, 095
Elektra	353
Element	459
Emerson	016, 023, 053, 064, 103, 139, 158, 159, 164, 165, 166, 167, 168, 169, 392, 400, 401402, 408, 415, 424, 507, 567, 577, 590
Envision	073, 095
ESA	454, 456, 538
Fisher	355, 356
Fujitsu	460, 469, 560

Table 7 TV codes (Continued)

TV	Code
Funai	047, 048, 157, 168, 211
Gateway	426
GE	015, 018, 042, 044, 049, 054, 055, 068, 073, 090, 092, 095, 101, 102, 103, 389, 390, 396, 403, 406, 407
Gibraltar	023, 048, 053, 068, 073, 090, 095, 107, 108, 233, 360
Go Video	443
Goldstar (LG)	023, 053, 068, 073, 090, 107, 108, 233, 360, 361
Gradiente	104
Grundig	233
Haier	053, 073, 095, 108, 427, 519, 596, 587
HP (HDTV)	072
Hall Mark	073, 095
Hitachi	023, 068, 095, 096, 097, 098, 099, 100
Hyundai	453
iLo	524, 586

Table 7 TV codes (Continued)

TV	Code
Initial	470
Inkel	364
Insignia	167, 415, 424, 450, 456, 461, 507, 523, 567, 577, 586
JC Penny	039, 053, 068, 073, 092, 095, 102, 355
Jensen	062, 461
JVC	104, 105, 106, 396, 397, 410, 589
Kawasho	073, 095
KMC	023
Konka	445, 589
Kosche TV	462
KTV	023, 053, 233, 366
Kurazai	211, 213
LG (Goldstar)	023, 053, 068, 073, 090, 107, 108, 233, 360, 361, 424, 567, 577
Lodgenet	211, 213
Logik	211, 213

Table 7 TV codes (Continued)

TV	Code
Luxman	068, 073, 095
LXI	024, 026, 157, 355, 388
Mag	459
Magnavox	470, 472, 549, 595
Magnavox (Philips)	023, 068, 071, 072, 073, 089, 090, 091, 092, 093, 094, 134, 385, 387, 397, 404, 463, 470, 472, 549, 594, 595
Majestic	211, 213
Marantz	053, 107, 108, 109
Matsui	582, 583, 585
Maxent	426, 533, 534
Mcintosh	555
Megatron	215
Memorex	090, 211, 213, 355, 388, 405, 423, 459
MGA/Mitsubishi	053, 068, 073, 090, 095, 107, 108, 109, 110, 216, 384, 394, 395, 398, 399, 417
Mintek	470



## Moxi remote programming codes

# 7

Table 7 TV codes (Continued)

TV	Code
Montgomery Ward	108, 022, 023, 026, 053, 071, 072, 211, 213
NEC	028, 068, 090, 108, 200, 464
Norcent	455, 472
Olevia	073, 519, 541, 587
Orion	019, 159, 160, 161, 162, 163, 382, 423, 424, 558
Panasonic	042, 043, 044, 045, 046, 419, 429
Philco	053, 072, 023, 068, 071, 091, 463
Philips (Mag-navox)	023, 068, 071, 072, 073, 089, 090, 091, 092, 093, 094, 134, 385, 387, 397, 404, 463, 470, 472, 549, 594, 595
Pilot	073, 094, 233
Pioneer	019, 111, 144, 383, 551
Planar	474
Polaroid	384, 394, 459
Portland	023, 068
Prima	072

Table 7 TV codes (Continued)

TV	Code
ProScan	055, 070
Proton	090, 371, 372
Protron	457, 467
Proview	459
Pulsar	073
Quasar	044
Radio Shack	073
RCA	053, 042, 052, 054, 055, 068, 069, 070, 416
Realistic	022, 166, 168
Runco	525
Sampo	090, 108
Samsung	147, 015, 016, 017, 023, 031, 090, 107, 108, 134, 151, 153, 386, 411, 424, 508, 577
Sansui	423, 424
Sanyo	353, 355, 356, 376, 377
Sceptre	468

Table 7 TV codes (Continued)

TV	Code
Scott	090, 108, 168, 561
Sears	023, 030, 031, 038, 039, 068, 353, 355, 356
Sharp	028, 016, 022, 023, 024, 025, 026, 027, 029, 393, 395, 409
Signature 2000	023, 026, 108, 211, 213
Sony	014, 020, 021, 178, 540
Soundesign	091
Soyo	562
Squareview	157
SunBrite TV	587
Superscan	419
Supre-Macy	380
SVA	592
Sylvania	071, 068, 072, 090, 091, 092, 093, 107, 108, 157, 158, 419, 466, 590
Symphonic	047, 157
Tatung	044, 446

Table 7 TV codes (Continued)

TV	Code
Techwood	068
Teknika	023, 068, 072, 168, 213, 463, 091
Telerent	023, 213
Tera	381
Tevion	065, 414
TMK	068, 090
Toshiba	030, 031, 038, 039, 423, 571
Totevision	233
Universal	068, 102
Vidtech	068
ViewSonic	428, 513, 515, 527, 528, 529, 533, 534, 538, 530, 531, 532, 535, 536, 537, 538, 539
Viore	031, 508, 598, 600, 601, 602
Visco	589
Vizio	062, 073, 095, 454, 538, 561, 573, 053
Wards	068, 090

Table 7 TV codes (Continued)

TV	Code
Westinghouse	020, 458, 463
White Westinghouse	211, 408, 449
XR-1000	213
Yamaha	068
York	090, 108
Zenith	047, 048, 049, 050, 051, 391, 405, 406, 424, 434, 567, 577, 594

## Audio device codes for the Moxi remote control

Use the codes in table 8 to program audio devices.

Table 8 Audio device codes

Audio Device	Code
ADC	318
Adcom	325
Aiwa	176, 301, 521
Akai	142
Bose	302, 440
Carver	155, 176, 180
Daewoo	501
Denon	262, 307
Everquest	136
Fisher	063, 180
Fosgate Audionics	305
Goldstar (LG)	036, 308

## Moxi remote programming codes



Table 8 Audio device codes (Continued)

Audio Device	Code
Harman Kardon	130, 257, 305, 306
Hitachi	240
Jensen	140x
JVC	114, 241
Kenwood	063, 176, 277, 444
Krol	176
LG (Goldstar)	036, 308
Luxman	281
Magnavox (Philips)	080, 119, 184, 502, 503, 504, 433
Marantz	282, 283, 284, 285, 516, 517, 518, 520
Mcintosh	557
Mission	176
NSM	176
NAD	286
Onkyo	126, 171, 304, 543, 579
Optimus	142, 229, 321

Table 8 Audio device codes (Continued)

Audio Device	Code
Panasonic	032, 074, 184, 438, 441
Parasound	323
Philips (Magnavox)	080, 119, 184, 502, 503, 504, 433
Pioneer	123, 137, 251, 298
Quasar	032, 184
Radio Shack	229, 267
RCA	119, 439
Realistic	226, 268
Rotel	310
SAE	176
Samsung DVD / Reciever	546, 492
Sansui	283
Sanyo	195, 309
Scientific Atlanta	312
Scott	272
Sharp	294

Table 8 Audio device codes (Continued)

Audio Device	Code
Sherwood	229, 267, 505, 506
Sony	041, 057, 067, 232, 287, 292, 442
Soundesign	083, 088, 148, 239, 242, 265, 311, 320
SSI	313
STS	318
Taekwang	142
Teac	314, 316
Technics	032, 184, 512
Victor	114, 241
Wards	063, 114, 241
Victor	114, 241
Yamaha	145, 254, 280, 303, 521, 542, 579
Zenith	036, 083, 088, 239, 265



# Glossary

## A

**action menu:** Provides different action choices or commands. It appears in the Moxi Menu when a user decision is required.

**album:** A collection of photographs in Photos.

## C

**card:** Cards appear in a vertical list within categories in the Moxi Menu.

**center focus:** Any category or card that you stop on while navigating the Moxi menu options. Often, the focus card has an associated action menu.

## E

**episode limit:** The maximum number of episodes for the selected program that the DVR will record.

**eSATA:** External serial advance technology attachment provides a serial bus standard for connecting devices. On the DVR it is used to connect such devices as external hard disks.

## F

**favorites:** The category in the Moxi Menu that contains a list of the fifteen channels most frequently watched.

## H

**HDCP:** High-Bandwidth Digital Content Protection is a cryptographic method to control video delivery. Content is protected in such a way that only entitled devices can view it.

**HDID:** Hardware Device ID is a unique identifier that each device can access internally. This identifier allows Digeo servers to identify individual devices.

**HDMI:** High Definition Multimedia Interface is an uncompressed audio and video interface. HDMI supports standard, enhanced, and HD video. It also supports digital audio.

**HDTV:** High Definition TV provides much better resolution than TVs based on the NTSC standard of 480i. HDTVs typically show video at video resolutions of 720p and 1080i, often in addition to other resolutions.

**horizontal band:** The list of category options that display in the left and right axis on the Moxi Menu.

**IEEE 1394:** A high-bandwidth digital connection sometimes called FireWire. The DVR provides an MPEG-2 audio and video stream, from live TV, for recording or display on a digital device.

**infrared emitter:** A device to send control signals to home theater components or any other device capable of receiving and decoding them.

### M

**movie rating:** The MPAA rating system allows viewers to make decisions about which movies may be appropriate for children. Moxi allows setting parental controls based on movie ratings.

**Moxi Menu:** Digeo's user interface through which consumers can explore and access live or recorded TV programming, digital music, photos, and games using a remote control.

### P

**Parental controls:** A feature providing control of media viewing by restricting programming by rating and requiring the use of a PIN.

**Photos:** A feature that allows users to store, organize and display digital pictures.

**playback controls:** Remote controls that allow manipulation of your location within the current program. The actions include: play, pause, stop, fast-forward, slow-motion, rewind, skip, replay, next, and back.

**player bar:** A horizontal graphic that appears in the lower part of the screen whenever you press a playback control. The bar provides information about the viewing location within the current program.

**PPV:** Pay-per-view movies available for a 24-hour rental period.

### R

**recording options:** Parameters that can be altered to customize the recording. Options include: start and stop times, keep duration, and more for series recordings.

### S

**S/PDIF:** The Sony/Phillips Digital Interface Format is a set of standards for sending and receiving digital audio signals, including the connectors used by the input and output digital audio devices.

**SD:** Standard definition is the screen resolution (480 interlaced lines) of most standard TVs.

**series priority:** Used by Moxi to determine which series to record when more than two air at the same time.

**slideshow:** The playback of photo albums stored in your Moxi.

**slow motion:** Use slow motion on any program to view a show at very slow speed. Activate it by pressing pause, and then pressing the fast-forward button once.

**SuperTicker:** A feature that provides access to additional content for news, weather, sports, and stocks. When launched, it scales back the TV image and uses a small area at the bottom of the screen.

**S-Video:** An analog video connection with better quality than Composite. S-Video is capable of displaying 480i from the DVR.



### T

**time slot:** TV programs air in a time slot. Use series options to specify which time slots are recorded.

**TV rating:** A way to inform viewers on the content of broadcast programming. Moxi allows setting parental controls based on TV rating.

### V

**V-Chip:** The V-Chip is the federally-mandated parental control function built into all TVs larger than 13 inches that have been sold in the United States since 1999.

**video resolution:** The setting that determines the lines and frames making up the picture that appears on the TV screen.



# Index

## Numerics

21 Frenzy, 34

## A

About Moxi 28, 34

album, open, 32

archiving 59

audio

device codes 62

See also *Moxi remote*.

## B

Blackjack, 34

box ID 34

Bubble Blast, 34

## C

CableCARD,

conditional access, 43

digital secure gateway, 43

interactive info, 43

manufacturer information, 43

network setup, 43

pairing, 43

status, 43

card 20

background color, 25

Find & Record 21

scheduled to record, 25

category 20

channels, 22

favorites 22

games, 34

Parental Controls, 36

Closed Caption, 39

Code Breaker, 34

components, adding, 57

composite, 54

## Index

connecting  
DVR, 56  
external hard drives, 42  
HDMI cable, 57  
requirements, 52

connection  
secondary, 58

connectors  
audio, 54  
external hard drives, 42, 55  
video, 53

cropped, 39

**D**

digital VCR, 59

DVR  
connecting, 56

**E**

eSATA, 42, 55

external hard drives  
eSATA, 42, 55  
settings, 41

**F**

favorites, 22

Find & Record 21  
find. See also *search*.  
FireWire. See also *IEEE 1394*.  
first-run only, 27  
flip bar, 23

## G

Games  
21 Frenzy, 34  
Blackjack, 34  
Bubble Blast, 34  
Code Breaker, 34  
playing, 34  
Slot Machine, 34  
Solitaire, 34  
Tomato, 34  
Video Poker, 34

## H

HDMI 53  
HDMI cable, 57  
HDTV  
connections 40

## I

icons, recording, 25

IEEE 1394, 59

infrared emitter (IR blaster), 17

installation

    secondary components, 57

## L

letter box, setting, 39

locking. See also *parental control*.

## M

media center

    HDMI cable, 57

    installing secondary components, 57

    ventilation requirements, 53

Moxi Flip Bar 23

Moxi Menu

    favorite channels 22

    navigating 20

    TV setup, 40

Moxi remote

    audio codes, 62

## N

notes 12

## O

On Demand

    controlling purchases, 38

## P

parental control 36

    controlling purchases, 38

    locking channels or programs, 36

    PIN 36

    See also *PIN*.

    turning off, 37

    unlock timer, 38

Pay Per View

    controlling purchases, 38

Photos

    album, 32

    uploading, 31

    using, 31

    viewing slideshow, 32

PIN

    changing,

    creating, 36

    resetting, 39

## Index

- player bar
  - features of, 23
  - using the, 23
- preinstallation
  - storage connectors, 55
  - video connectors 53
- priority
  - changing, 28
  - setting 28
- R**
- rating, locking by, RCA 54
- recording 24
  - already scheduled, list of, icons 25
  - options, 26
  - see all times, 24
  - series options, 24, 27
  - series, repeats, 27
- remote
  - button
    - info 33
  - programming by search, 16
  - programming with codes, 16
- resolution
  - standard definition, setting, 40
  - supported, 40
- S**
- search 20
  - by category 22
  - by title or keyword 21
- secondary components 57
- see all times, 24
- series
  - changing priority, 28
  - episode limit, 27
  - priority, 28
  - recording, 27
- service messages, reading, 33

- settings
  - closed caption 39
  - cropped, 39
  - external hard drives, 41
  - letterbox, 39
  - widescreen, 39
- setup
  - TV, 40
- shows
  - recording, 24
- slideshow 32
- Slot Machine, 34
- software version, 34
- Solitaire, 34
- sound effects, 42
- standard definition, 40
- Storage & Stats 28, 34
  - additional data 55
- storage meter, understanding, 28
- SuperTicker
  - lock topic or item, 30
  - story, reading, 30
  - using, 30
- S-Video 54

**T**

- time slot
  - changing 20
- timeslots 27
- Tomato, 34
- troubleshooting 45
  - DVR, 46
  - media center,
    - audio, video, 46
    - audio/video out-of-sync, 46
    - changing channels, 46
    - static on screen, 46
    - no video displayed, 46
    - remote and front panel, 47
    - user interface control, 47
- TV setup, 40

**V**

- V-Chip, 37
- ventilation 53
- video
  - connections supported, 40
- video connectors, 53
- Video Poker, 34

## Index



### W

widescreen, settings, 39





