



EXHAUST

TIRES & ACCESSORIES

LUGGAGE

SPORTBIKE ACCESSORIES

CRUISER ACCESSORIES

TOURING ACCESSORIES

SECURITY & AUDIO

GENERAL ACCESSORIES

FAIRINGS & BODY

SEATS

HANDLEBARS & CONTROLS

LIGHTING

ELECTRICAL

SPROCKETS

CHAINS

BRAKES

SUSPENSION

ENGINE

FUEL SYSTEMS

LUBES

TOOLS

TRAILER

MERCH.

CROSS REFERENCE

INDEX

FLOORBOARDS

- Increase long-range comfort and add some style
- Bolt-on floorboards with rubber insert look great and are built to last
- Include heel/toe shifter



MC30021 Left



MC30021 Right

FITS MODEL	PART #	SUG. RETAIL
HONDA		
VT600C Shadow VLX 88-09	MC30012	\$415.95
VT750C Shadow ACE 97-03	MC3009	415.95
VT750C Shadow Aero 04-09	1621-0025	494.95
VT750C2 Shadow 07-09	1621-0025	494.95
VT750DC Shadow Spirit 01-03, 05-07	MC30018	415.95
VT1100C Shadow Spirit 97-09	MC30015	415.95
VT1100S Shadow Sabre 00-09	MC30016	415.95
VTX1300C 03-09	1621-0022	494.95

FITS MODEL	PART #	SUG. RETAIL
HONDA (CONT)		
GL1500C Valkyrie 97-03	MC30013	\$494.95
VTX1800C 02-09	MC30019	415.95
VTX1800F 05-09	MC30019	415.95
KAWASAKI		
VN800B Vulcan Classic 96-05	MC30040	415.95
SUZUKI		
V5750/800 Intruder 88-04	MC30021	494.95
S50 Boulevard 05-09	MC30021	494.95
VL800 Intruder Volusia 01-04	MC30024	415.95

FITS MODEL	PART #	SUG. RETAIL
SUZUKI (CONT)		
M50/C50 Boulevard 05-09	MC30024	\$415.95
VS1400 Intruder 87-04	MC30021	494.95
S83 Boulevard 05-09	MC30021	494.95
YAMAHA		
XVS650 V-Star Custom/Classic 98-09	MC30032	415.95
XVS1100 V-Star Custom 99-09	MC30036	415.95



1405-0005

1405-0019



1405-0027

FRONT FENDER TRIM

- Triple chrome-plated fender trim features square nose dual-rail look
- Blends with the fender as though it should have been there all the time
- Does not include emblems

FITS MODEL	PART #	SUG. RETAIL
HONDA		
VT750C Shadow ACE 98-03	MC6609	\$163.95
VT750 Shadow Aero 04-09	1405-0005	163.95
VTX1300R/S 03-09	MC66005	163.95
GL1500C Valkyrie 97-03	MC660-13	163.95
VTX1800R/S 02-09	1405-0019	119.95
KAWASAKI		
VN900 Vulcan Classic 06-09	1405-0027	163.95
VN1500 Vulcan/Classic 96-09	MC66041	163.95
VN1500G Nomad 98-04	MC66042	163.95

FITS MODEL	PART #	SUG. RETAIL
KAWASAKI (CONT)		
VN1600 Vulcan Classic 03-09	1405-0003	\$163.95
VN1600 Vulcan Nomad 05-09	1405-0018	163.95
VN2000 Vulcan 04-05	1405-0017	138.95
SUZUKI		
VL800 Volusia/C50 Boulevard 01-09	MC66024	163.95
VL1500LC Intruder/C90 Boulevard 98-09	MC66022	163.95
YAMAHA		
XVS1100 Custom 99-09	1405-0020	119.95



SADDLEBAG RAILS

- Triple chrome-plated set of rails with steel mounting brackets (not plastic) and custom-sculptured corner gussets
- Gussets are welded to top of rails and blended in to prevent rusting
- Accept M/C Enterprise's and other light bars
- Bolt on to stock bag guards
- Lights not included

SUG. RETAIL.....\$344.95

FITS MODEL	PART #
HONDA	
GL1500C Valkyrie Tourer 97-03	MC47413
GL1500C Valkyrie Interstate 99-01	MC47413

KOOL COVERS

CHROME NUT AND BOLT HEAD COVERS

- Unique finished alternative to rusty nut and bolt head covers
- Covers all visibly apparent nut and bolt heads that weren't chrome plated at the factory
- Easier and less expensive than disassembling your bike and taking all those nuts and bolts to the plater
- Made from chrome plated aerospace GFP polymer
- Interior grooves grip the length of bolt heads and nuts
- Quick installation – just press them on

SIZE	PART #	SUG. RETAIL
8mm bolt and nut covers (10-pk.)	KK-15008	\$14.95
8mm bolt and nut covers (25-pk.)	2404-0117	29.95
10mm bolt and nut covers (10-pk.)	KK-150010	14.95
10mm bolt and nut covers (25-pk.)	2404-0118	29.95
12mm bolt and nut covers (10-pk.)	KK-150012	14.95
12mm bolt and nut covers (25-pk.)	2404-0119	29.95

SIZE	PART #	SUG. RETAIL
14mm bolt and nut covers (10-pk.)	KK-150014	\$14.95
14mm bolt and nut covers (25-pk.)	2404-0120	29.95
14mm deep bolt and nut covers (5-pk.)	KK-150015	14.95
14mm deep bolt and nut covers (15-pk.)	2404-0121	29.95

SIZE	PART #	SUG. RETAIL
17mm bolt and nut covers (5-pk.)	KK-150017	\$14.95
17mm bolt and nut covers (15-pk.)	2404-0122	29.95
#5 Allen head bolt covers (10-pk.)	KK-15005	14.95
#5 Allen head bolt covers (25-pk.)	2404-0115	29.95
#6 Allen head bolt covers (10-pk.)	KK-15006	14.95
#6 Allen head bolt covers (25-pk.)	2404-0116	29.95





FORWARD CONTROLS

- Innovative billet aluminum controls ergonomically designed for maximum comfort
- Extend your legs and sit back in a vastly improved riding position
- Easy access to controls provides a confidence-inspiring ride
- Triple-plated nickel, copper and chrome construction resists corrosion and ensures years of faithful service
- Enhance the beauty and the value of your mount

NOTE: Also see Jardine's matching grips, backrests and racks.

FITS MODEL	PART #
HONDA	
VF750C Magna 94-03	39-1004-01
VT750C/CD Shadow/ACE 98-03	39-1006-01
VT750 Shadow Aero 04-09	1622-0091
VT750DC Shadow Spirit 05-08	1622-0093
VT1100C Shadow 87-96	39-1001-01
VT1100C1 Shadow Spirit 97-07	39-1005-01
VT1100C2 ACE 95-99	39-1002-01
VT1100C2 Shadow Sabre 00-08	39100801
VT1100CT Shadow ACE Tourer 98-02	39-1002-01
VT1300C 04-09	1622-0092
VTX1800C 02-08	39100901

FITS MODEL	PART #
KAWASAKI	
VN800A/B Vulcan/Vulcan Classic 95-05	39300301
VN1500E Vulcan Classic 99-04	39-3005-01
VN1500P/1600P Vulcan Mean Streak 02-08	39300701
VN2000 Vulcan 04-09	1622-0187
SUZUKI	
VS750 Intruder 88-91	39-4001-01 ¹
VL800 Intruder Volusia, C50/M50 Boulevard 01-09	39-4006-01
VS800 Intruder, S50 Boulevard 92-08	39-4001-01 ¹
VZ800 Marauder 95-04	39-4004-01 ¹

SUG. RETAIL.....\$724.95

FITS MODEL	PART #
SUZUKI (CONT)	
VS1400 Intruder, S83 Boulevard 87-09	39-4002-01 ¹
VL1500 Intruder, C90 Boulevard 98-09	39-4005-01
VZ1600 Marauder, M95 Boulevard 04-05	39300701
YAMAHA	
XVS650 V-Star/Custom/Classic 98-09	39-2003-01
XV1100 Virago 86-91, 93-00	39-2001-01
XVS1100 V-Star 99-09	39-2005-01
XV1600/1700 Road Star 99-09	39-2004-01
XV1900 Roadliner/Stratoliner 06-09	1622-0186

¹ SUG. RETAIL \$776.95.

PASSENGER FLOORBOARDS

- High-quality billet aluminum construction
- Chrome plated for an eye-catching look
- Offer a more comfortable riding position over longer rides
- Rubber pads work to reduce vibration
- Streamline design adds that perfect finishing touch
- Sold in pairs

SUG. RETAIL.....\$229.95



FITS MODEL	PART #
HONDA	
VT600 VLX 88-98	56-1002-01
VF750C Magna 94-03	56-1002-01
VT750DC Shadow Spirit 01-03, 05-07	56100601
VT1100C Shadow Spirit 99-06	56100501
VT1100C2 Shadow ACE 95-99	56-1001-01
VT1100C3 Shadow Aero 98-02	56-1001-01
VT1100CT ACE Tourer 98-02	56-1003-01
VTX1300R/S/C 03-09	56100601
GL1500C Valkyrie 97-03	56-1003-01
VTX1800R/S/N 02-06	56100601

FITS MODEL	PART #
KAWASAKI	
VN800A/B Vulcan/Vulcan Classic 95-08	56-3001-01
VN1500A/B/C/L Vulcan 87-06	56-3001-01
VN1500D/E/N Vulcan Classic 96-08	56-3001-01
VN1600A/B/C/D/E/G Vulcan 03-08	56-3001-01
VN2000 04-09	56-3001-01
SUZUKI	
VL800 Intruder Volusia 01-04, C50/M50 Boulevard 05-08	1621-0132
VS750/800 Intruder, S50 Boulevard 88-06	56-4001-01
VZ800 Marauder 97-04	56-4002-01

FITS MODEL	PART #
SUZUKI (CONT)	
VS1400 Intruder, S83 Boulevard 87-09	56-4001-01
VL1500LC Intruder, C90 Boulevard 98-09	56-4002-01
M109R Boulevard 07-09	1621-0131
YAMAHA	
XVS650 V-Star/Custom/Classic 98-09	56-2001-01
XV1100 Virago 86-91, 93-00	56-2002-01
XVS1100 V-Star 99-09	56-2001-01
XVS1300 V-Star 07-09	1621-0111
XVZ1300 Royal Star 96-00	56-2001-01
XV1600/1700 Road Star 99-09	56200301

All part numbers in **BOLD MAGENTA** are new this year.

- EXHAUST
- TIRES & ACCESSORIES
- LUGGAGE
- SPORTBIKE ACCESSORIES
- CRUISER ACCESSORIES
- TOURING ACCESSORIES
- SECURITY & AUDIO
- GENERAL ACCESSORIES
- FAIRINGS & BODY
- SEATS
- HANDLEBARS & CONTROLS
- LIGHTING
- ELECTRICAL
- SPROCKETS
- CHAIN
- BRAKES
- SUSPENSION
- ENGINE
- FUEL SYSTEMS
- LUBES
- TOOLS
- TRAILER
- MERCH.
- CROSS REFERENCE
- INDEX



- EXHAUST
- TIRES & ACCESSORIES
- LUGGAGE
- SPORTBIKE ACCESSORIES
- CRUISER ACCESSORIES**
- TOURING ACCESSORIES
- SECURITY & AUDIO
- GENERAL ACCESSORIES
- FAIRINGS & BODY
- SEATS
- HANDLEBARS & CONTROLS
- LIGHTING
- ELECTRICAL
- SPROCKETS
- CHAINS
- BRAKES
- SUSPENSION
- ENGINE
- FUEL SYSTEMS
- LUBES
- TOOLS
- TRAILER
- MERCH.
- CROSS REFERENCE
- INDEX

OIL FILTER COVER FOR MAGNA AND VALKYRIE

- Billet aluminum is CNC-machined for strength, durability and light weight
- Fits Honda VF750C Magna 94-04 and GL1500C Valkyrie 97-03



SUG. RETAIL.....\$78.95 PART # 64-1102-01

CARBURETOR COVER

FOR VT750C/
CD SHADOW/ACE 98-03

- Machined from billet aluminum for strength and light weight
- Excellent fit and looks
- Made in the U.S.A.



SUG. RETAIL.....\$71.95 PART # 64130001



2001-0251

59-1101-01



59110201

BILLET LIGHT BAR

- Billet driving light bar is machined with a unique art-deco inspired design that screams "cruiser"
- Easily mounts to the front of the bike for better light and better looks
- Spotlights included

SUG. RETAIL.....\$334.95

30W REPL. BULB (NOT FOR PROJECTOR BEAM LIGHTS)

SUG. RETAIL.....\$9.95 PART # 59000201

FITS MODEL	PART #
HONDA	
VT750C/CD ACE 98-03	59110201
VT750C Shadow Aero 04-09	2001-0152
VT750C2 Shadow Spirit 07-09	2001-0309
VT1100C3 Aero 98-02	59-1101-01
VTX1300R/S 03-09	59110901
KAWASAKI	
VN900 Vulcan Classic/Custom 06-09	2001-0310
VN1500 Vulcan Classic 05-08	2001-0311
VN1500G Vulcan Nomad 99-04	59310201
VN2000 Vulcan 04-09	2001-0153 ¹

FITS MODEL	PART #
SUZUKI	
C50/M50 Boulevard 05-08	2001-0312
VL1500LC Intruder 98-03 (OEM windshield)	59-4102-01
M109R Boulevard 06-09	2001-0253
YAMAHA	
XVS1300 V-Star 07-09	2001-0252
XV1900 Roadliner/Stratoliner 06-09	2001-0251

¹ Includes projector beam lights.



DRIVE SHAFT COVER

FOR YAMAHA XVS650/1100 V-STAR CUSTOM/CLASSIC 98-09

- Complements the entire Jardine line and many other custom parts
- Made in the U.S.A.

SUG. RETAIL.....\$119.95 PART # 64-2203-01



FLOORBOARD COVERS

- Custom chrome covers with rubber inserts for comfort
- Looks great and easy to install; fit over stock floorboards
- Sold in pairs



FITS MODEL	PART #	SUG. RETAIL
HONDA		
VTX1300 03-08 (models w/ factory floorboards)	1621-0064	\$129.95
VTX1800 03-08 (models w/ factory floorboards)	1621-0064	129.95
KAWASAKI		
VN1500 Vulcan Classic/Nomad/Drifter (all)	1621-0066	129.95
VN1600 Vulcan Classic 03-08	1621-0065	129.95
VN2000 Vulcan 04-08	1621-0065	129.95
YAMAHA		
XVS1100 V-Star 99-08	1621-0063	129.95
XV1600/1700 Road Star 99-08	1621-0063	129.95
XV1900 Roadliner/Stratoliner 06-08	1620-0371	129.95



ISO™-STIRRUPS

- Adjustable-height heel rests allow floorboard-like comfort and support to reduce fatigue on longer rides
- Compatible with Kuryakyn large ISO™-Pegs, small ISO™-Pegs, and Retro pegs
- Must be used with Kuryakyn footpegs and footpeg adapters
- Sold in pairs

SUG. RETAIL.....\$79.95 PART # 1620-0209

BRAKE PEDAL/HEEL SHIFT PAD COVERS

- Clamshell design has a chrome finish with rubber inserts
- Installs over stock rubber pad; secures with two setscrews

SUG. RETAIL.....\$29.95

FITS MODEL	PART #
HONDA (BRAKE PEDAL)	
VLX600 Shadow 96-07, VT750DC Shadow Spirit 01-03/05-08, VT750 Shadow Aero 04-08, VF750C Magna 96-03, VT1100 Shadow Sabre 02-08, VT1100 Shadow A.C.E. 97-99, VT1100 Shadow Spirit 96-08	1611-0004
KAWASAKI (BRAKE PEDAL)	
VN750 Vulcan 86-06	1611-0004
VN1500/1600 Mean Streak 02-08	1611-0011
KAWASAKI (HEEL SHIFT PEDAL)	
VN1500 Vulcan 96-08 VN1600 Vulcan 03-08	1611-0004
SUZUKI (BRAKE PEDAL)	
VL800 Volusia 01-04, VZ800 Marauder 01-04, M50 Boulevard 05-08	1611-0004

All part numbers in **BOLD MAGENTA** are new this year.



ISO™-PASSENGER FLOORBOARDS WITH SPLINED ADAPTER MOUNTS

- Kit includes our chromed ISO™-Boards with full-length rubber inserts and a cast bracket to connect with Kuryakyn's splined adapter mounts (sold separately)
- Sold in pairs

SUG. RETAIL.....\$199.95 PART # 1621-0088



DUALLY ISO™-PEGGS

FOR HONDA GL1500C VALKYRIE 98-03

- Direct replacement for stock footpegs
- Classy, comfortable and install in minutes

SUG. RETAIL.....\$69.95

PART # 1620-0146



SHIFTER PIVOT COVER

FOR HONDA VTX 1800N/R/S 03-08

- Hides the weld on the shift lever with smooth chrome
- Quick, easy installation
- Sold each

SUG. RETAIL.....\$24.95

PART # 1603-0018



FITS MODEL	PART #
SUZUKI (BRAKE PEDAL) (CONT)	
VZ1500 Marauder 04/M95 Boulevard 05	1611-0011
SUZUKI (HEEL SHIFT PEDAL)	
VL1500 Intruder LC 98-04, C90 Boulevard 05-07, C50 Boulevard 05-08	1611-0004
VICTORY (BRAKE PEDAL)	
V92C/DC/TC 99-03	1603-0067 ¹
YAMAHA (BRAKE PEDAL)	
XVS650/1100 V-Star Classic/Custom 98-08	1611-0004

¹ SUG. RETAIL \$18.95.

- EXHAUST
- TIRES & ACCESSORIES
- LUGGAGE
- SPORTBIKE ACCESSORIES
- CRUISER ACCESSORIES
- TOURING ACCESSORIES
- SECURITY & AUDIO
- GENERAL ACCESSORIES
- FAIRINGS & BODY
- SEATS
- HANDLEBARS & CONTROLS
- LIGHTING
- ELECTRICAL
- SPROCKETS
- CHAINS
- BRAKES
- SUSPENSION
- ENGINE
- FUEL SYSTEMS
- LUBES
- TOOLS
- TRAILER
- MERCH.
- CROSS REFERENCE
- INDEX



- EXHAUST
- TIRES & ACCESSORIES
- LUGGAGE
- SPORTBIKE ACCESSORIES
- CRUISER ACCESSORIES**
- TOURING ACCESSORIES
- SECURITY & AUDIO
- GENERAL ACCESSORIES
- FAIRINGS & BODY
- SEATS
- HANDLEBARS & CONTROLS
- LIGHTING
- ELECTRICAL
- SPROCKETS
- CHAINS
- BRAKES
- SUSPENSION
- ENGINE
- FUEL SYSTEMS
- LUBES
- TOOLS
- TRAILER
- MERCH.
- CROSS REFERENCE
- INDEX



STILETTO PEGS

- Add some wild style to your ride
- Can be installed on any male-mount style footpeg mounts
- Sold in pairs

SUG. RETAIL.....\$99.95

PART # 1620-0180



ERGO CRUISE PEGS

FOR HONDA GL1500 GOLD WING 88-00 AND GL1500C VALKYRIE 98-03

- Designed for maximum driver comfort
- Offer an unbelievable range of adjustment
- Articulated mounting bracket is polished stainless steel for strength and good looks
- Six-inch-long chrome swingarm has an ingenious locking mechanism and is canted at a 6° angle so the pegs are perfectly placed for ideal comfort
- Replacement arms for Ergo Cruise available separately, sold in pairs
- Not for use on Valkyrie Interstate

DESCRIPTION	PART #	SUG. RETAIL
Ergo Cruise pegs	1620-0148	\$199.95
Short repl. arms (4 1/2" L)	1624-0131	49.95
Long repl. arms (6" L)	1624-0132	49.95

PEG-MOUNTED CRUISE PEG MOUNTS WITHOUT ADAPTERS

- The simplest way to install highway pegs
- Install to the stock footpeg mounts
- Have a 6" adjustable range so you can position them exactly where you want
- Require Kuryakyn's motorcycle-specific splined adapters for installation; see page 436
- Require Kuryakyn Stiletto, Switchblade, Dually, ISO®, Retro or Pilot footpegs or Kuryakyn ISO®-Wing boards; all sold separately, see page 433
- Sold in pairs

SUG. RETAIL.....\$149.95



PART # 1620-0372

TOUR-TECH™ CRUISE PEGS

- These pegs offer an incredible amount of adjustability
- Entire assembly can be moved up or down on the engine guard or frame tubes
- Arm of the footpeg can be further adjusted along a vertical or horizontal arc
- Unique clevis permits angle adjustment of the footpeg
- Recommended for use on any bike that has 1", 1 1/8" or 1 1/4" dia. engine guards or frame tubes
- Available with 1", 1 1/8" or 1 1/4" Magnum Quick Clamps for quick, easy installation
- Sold in pairs

DESCRIPTION	PART #	SUG. RETAIL
OFFSET MOUNTS WITH QUICK CLAMPS		
Small ISO™-Pegs, 1 1/4" dia. clamps	1620-0129	\$119.95
Large ISO™-Pegs, 1 1/4" dia. clamps	1620-0130	129.95
Dually ISO™-Pegs, 1 1/4" dia. clamps	1620-0131	139.95
Dually ISO™-Pegs, 1" dia. clamps	1620-0144	139.95
Dually ISO™-Pegs, 1 1/8" dia. clamps	1620-0145	139.95



DESCRIPTION	PART #	SUG. RETAIL
CLEVIS MOUNT WITH QUICK CLAMPS		
Small ISO™-Pegs, 1 1/4" dia. clamps	1620-0132	\$89.95
Large ISO™-Pegs, 1 1/4" dia. clamps	1620-0133	99.95
Dually ISO™-Pegs, 1 1/4" dia. clamps	1620-0134	129.95
ISO™-Wings, 1 1/4" dia. clamps	1620-0135	139.95
Dually ISO™-Pegs, 1" dia. clamps	1620-0143	129.95

LONGHORN OFFSET DUALY HIGHWAY PEGS

- Combine Kuryakyn's most popular highway peg components into one easy-to-install product
- Clean looks, long-haul comfort
- Fully adjustable
- Mount on engine guards using 1" or 1 1/4" Magnum™ Quick Clamps
- Sold in pairs



DESCRIPTION	PART #	SUG. RETAIL
W/ 1 1/4" clamp	1624-0035	\$139.95

DESCRIPTION	PART #	SUG. RETAIL
W/ 1" clamp	1624-0036	\$149.95



ADJUSTABLE CRUISE PEG MOUNTS

FOR YAMAHA XVS1100 V-STAR 99-06 AND XV1600/1700 ROAD STAR 99-08
(ALL EXCEPT WARRIOR)

- Bolt directly to the OEM floorboards and allow full adjustability of the footpeg position
- Accept any male-mount footpegs (footpegs sold separately)
- Sold in pairs

SUG. RETAIL.....**\$169.95** PART # 1620-0282



CRUISE PEG MOUNTS

- Add Cruise pegs without the bulk of engine guards
- Super-clean mount plates bolt to existing floorboard mounting bosses for a sturdy, comfortable stretched-out setup
- Peg mount will accept any male mount peg
- Cruise pegs sold separately

FITS MODEL	PART #	SUG. RETAIL
HONDA		
VT1100C Shadow Spirit/Sabre 99-08	1620-0211	\$149.95
VTX1300C 04-08, VTX1300R/S 03-08	1624-0034	149.95

FITS MODEL	PART #	SUG. RETAIL
HONDA (CONT)		
VTX1800C 02-08	1620-0206	\$149.95
VTX1800S/N 03-08	1620-0210	149.95



DRIVER FOOTPEG MOUNT COVERS FOR HONDA VTX1300C 04-08

- Add a chrome finish to the driver footpeg mounts
- Easy to install, really add a highlight when used with Kuryakyn footpegs
- Sold in pairs

SUG. RETAIL.....**\$49.95** PART # 1620-0425

SHIFT PEG COVERS

- Cover your drab OEM peg with this chrome-and-rubber clamshell design
- Uses two setscrews to attach
- Complements Kuryakyn footpegs perfectly
- Covers can be used on most oval shifters with a width of 5/8" or less including heel-toe applications in addition to listed applications (except PART #1602-0110)
- Sold each



SUG. RETAIL.....**\$18.95**

FITS MODEL	PART #
HONDA	
VT750 Shadow Aero 04-08	1603-0017
VTX1300C 04-08	1602-0110
YAMAHA	
XVS650 V-Star Classic 98-00 (toe), XVS650 V-Star Custom 98-08 (toe), XVS650 V-Star Classic 01-08 (heel), XVS1100 V-Star Classic 99-08 (heel)	1611-0005

MALE MOUNT LOCKABLE OFFSETS

- Offset can be adjusted via a cogged head, so there is no fear of the peg slipping from where it is set
- Huge range of adjustment
- Works with any male-mount footpegs – highway pegs, passenger pegs or any other male-mount footpeg application
- Ends are tapered to accept any Kuryakyn footpeg
- Sold in pairs

SUG. RETAIL.....**\$59.95**

DESCRIPTION	PART #
2" lockable offset	1620-0183
4" lockable offset	1620-0184



All part numbers in **BOLD MAGENTA** are new this year.

- EXHAUST
- TIRES & ACCESSORIES
- LUGGAGE
- SPORTBIKE ACCESSORIES
- CRUISER ACCESSORIES
- TOURING ACCESSORIES
- SECURITY & AUDIO
- GENERAL ACCESSORIES
- FAIRINGS & BODY
- SEATS
- HANDLEBARS & CONTROLS
- LIGHTING
- ELECTRICAL
- SPROCKETS
- CHAINS
- BRAKES
- SUSPENSION
- ENGINE
- FUEL SYSTEMS
- LUBES
- TOOLS
- TRAILER
- MERCH.
- CROSS REFERENCE
- INDEX



SPLINED ADAPTER MOUNTS

- Provide slip-free mounting of Kuryakyn ISO-Boards™ and other Kuryakyn footpeg and foot control accessories that require splined peg mounts
- Sold in pairs



1620-0274

SUG. RETAIL..... **\$29.95**

FITS MODEL	FRONT
HONDA	
VT600 Shadow VLX/Deluxe 96-07	1620-0276
VF750C Magna 96-04	1620-0276
VT750C Shadow Aero 04-08	1620-0276
VT750DC Shadow Spirit 01-03/05-08	1620-0276
VTX1800C/F 02-08	1620-0279
KAWASAKI	
VN800 Vulcan Custom 95-05	1620-0274
VN800 Vulcan Classic 96-05	1620-0274
VN900 Vulcan Classic 07-08	1620-0274
VN1500A/B Vulcan 87-99	1620-0274
VN1500/1600 Mean Streak 02-08	1620-0274
YAMAHA	
XVS650 V-Star 98-08 (all)	1620-0275
XV750 Virago (all)	1620-0275
XVS1100 V-Star 99-08 (all)	1620-0275
XV1100 Virago (all)	1620-0275

UNIVERSAL CRUISE PEG MOUNTS

- Combines Kuryakyn's Magnum Quick Clamps and Clevis Mounts so you can install male-mount footpegs in a custom location
- 1 1/2" diameter clamping area makes these ideal for use on engine guards
- Beautiful chrome finish
- Sold in pairs



SUG. RETAIL..... **\$75.95**

PART # **1624-0151**



1620-0437



Heelrest deployed



Closed

SWITCHBLADE™ FOOTPEGS

- Comfortable, versatile and sleek
- Large-surface-area, rubber-isolated footpeg
- Concealed heelrest can be deployed to add the comfort of Kuryakyn ISO™-Stirrups
- Best for use on bikes with forward controls or forward-mounted footpegs; will work in any peg location
- Heel rests have curb feeler tabs to protect the pegs when cornering
- Pegs without male-mount ends require the use of Kuryakyn footpeg adapters, see page 437; pegs with male-mount ends require male-mount footpeg adapters
- Sold in pairs

DESCRIPTION	PART #	SUG. RETAIL
Switchblade pegs w/ male-mount ends	1620-0437	\$129.95
Switchblade pegs w/o male-mount ends	1620-0438	\$119.95

ISO® – SWEPTWING PEGS

- Simple, stylish design adds a sleek, streamlined look to your bike
- Feature the traditional ISO® design to reduce vibration and provide long-distance comfort
- Pegs without male-mount ends require Kuryakyn footpeg adapters, see page 437; pegs with male-mount ends require male-mount footpeg adapters
- Sold in pairs



1620-0369

DESCRIPTION	PART #	SUG. RETAIL
SweptWing pegs w/ male-mount ends	1620-0369	\$89.99
SweptWing pegs w/o male-mount ends	1620-0370	79.95



1611-0014



1620-0423

SWINGWING PEGS

- A convenient alternative to forward controls
- Our clever cruise peg features a fold-forward design
- Secondary fold-out peg extends 3" forward and locks into place for added legroom and comfort
- Require the use of Kuryakyn footpeg adapters, see page 437
- Sold in pairs

DESCRIPTION	PART #	SUG. RETAIL
SwingWing pegs w/ male-mount adapter	1611-0014	\$159.95
SwingWing pegs w/o male-mount adapter	1620-0423	149.95

ZOMBIE™ PEGS

- Features a sinister spire point and a skull nestled between the rubber pads
- Sturdy, rugged pegs design
- Include H-D® style male-mount ends
- Compatible with all Kuryakyn cruise peg mounts; will NOT replace stock pegs on metric cruisers
- Sold in pairs **SUG. RETAIL... \$99.95**



PART # 1620-0277

WIDOW PEGS

- Full custom footpeg design
- Ominous black widow design nestled in the rubber pads
- Available with or without male-mount adapter end; pegs without male-mount ends require the use of splined adapter mounts (sold separately)
- Sold in pairs

NOTE: Footpegs with male-mount ends will not mount directly to Metric cruiser bikes.



1611-0015



1611-0016

DESCRIPTION	PART #	SUG. RETAIL
Widow pegs w/ male-mount ends	1611-0015	\$99.95
Widow pegs w/o male-mount ends	1611-0016	89.95



KAISER™ PEGS

- The ultimate chopper footpeg
- Maltese Cross insert with spire pointed end for that old-school custom look
- Rubber pad inserts add comfort and isolate the foot from vibration
- Pegs without adapters require Kuryakyn footpeg adapters; pegs with male-mount ends require male-mount footpeg adapters
- Sold in pairs



DESCRIPTION	PART #	SUG. RETAIL
Kaiser pegs w/ male-mount ends	1620-0367	\$99.95
Kaiser pegs w/o male-mount ends	1620-0368	89.95

FORWARD CONTROL EXTENSIONS

FOR HONDA
VTX1800C/F 02-08

- Moves the driver's pegs 2" forward so you can stretch out
- Moves the stock controls
- Sold as a set

SUG. RETAIL.....\$109.95



PART # 1622-0096



FOOTPEGS AND ADAPTERS

- Replace the stock footpegs with one of our comfortable, stylish options
- Modular design – order the style of footpeg you desire and a set of our adapters
- All pegs and adapters feature a beautiful chrome finish and feature long-wearing, replaceable neoprene pads
- Rider and passenger peg adapters available
- If additional mounting hardware is necessary, it is included with adapters
- Adapters and pegs sold in pairs

ADAPTERS
SUG. RETAIL.....\$21.95



FOOTPEGS

DESCRIPTION	PART #	SUG. RETAIL	DESCRIPTION	PART #	SUG. RETAIL
Small ISO™-Pegs	1620-0157	\$34.95	Retro pegs	1620-0161	\$59.95
Large ISO™-Pegs	1620-0158	36.95	Zombie pegs	1620-0278	89.95
Dually ISO™-Pegs	1620-0159	59.95	Flame pegs	1620-0366	89.95
ISO™-Wings	1620-0160	89.95			

ADAPTERS

FITS MODEL	FRONT	REAR
HONDA		
VT600C/CD Shadow VLX/ Deluxe 96-07	1620-0149	1620-0150
VF750C/CD Magna 96-04	1620-0149	1620-0150
VT750 Aero 04-08	1620-0149	1620-0150
VT750DC Spirit 01-03/05-08	1620-0149	1620-0150
VT1100C Shadow 88-96	-	1620-0150
VT1100C Spirit 99-07	1620-0149	1620-0149
VT1100C2 Sabre 00-08	1620-0149	1620-0149
VT1100C3 Aero 99-02	-	1620-0149
VT1100CT Tourer 97-03	-	1620-0150
VTX1300C 03-08	1620-0149	1620-0150
VTX1300R 03-08	-	1620-0150
GL1500C Valkyrie 97-03	-	1620-0150
VTX1800C/F 02-08	1620-0149	1620-0150
VTX1800R/S/N 03-08	-	1620-0150
KAWASAKI		
VN800A/B Vulcan Classic/ Custom 96-05	1620-0151	1620-0152

FITS MODEL	FRONT	REAR
KAWASAKI (CONT)		
VN800C Vulcan Drifter 00-05	-	1620-0152
VN1500A/B Vulcan 87-99	1620-0151	1620-0152
VN1500D Vulcan Classic 96-08	-	1620-0152
VN1500J Vulcan Drifter 99-05	-	1620-0152
VN1500/1600 Mean Streak 02-08	1620-0151	1620-0152
VN1600A Vulcan Classic 03-08	-	1620-0152
SUZUKI		
VL800 Volusia 01-04	1620-0477	1620-0150
VZ800 Marauder 97-04	1620-0155	1620-0156
C50/M50 Boulevard 05-08	-	1620-0431
S83 05-08	1620-0155	1620-0156
VL1400 95-04	1620-0155	1620-0156
C90 05-08	-	1620-0156
VL1500LC Intruder 98-04	-	1620-0156
M95 05	1620-0151	1620-0152
VZ1600 Marauder 04	1620-0151	1620-0152
M109R Boulevard 06-08	1620-0477	1620-0430

FITS MODEL	FRONT	REAR
TRIUMPH		
Thunderbird 95-03	1620-0432	1620-0432
Thunderbird Sport 98-00, 03	1620-0432	1620-0432
Adventurer 96-01	1620-0432	1620-0432
Legend 99-01	1620-0432	1620-0432
Bonneville/T100 01-08	-	1620-0432
Bonneville America 02-08	1620-0432	1620-0432
Speedmaster 03-08	1620-0432	1620-0432
YAMAHA		
XVS650 V-Star 98-08 (all)	1620-0153	1620-0154
XV750 Virago 88-98	1620-0153	1620-0154
XV1100 Virago 86-99	1620-0153	1620-0154
XVS1100 V-Star 99-08 (all)	1620-0153	1620-0154
VMX12 Vmax 85-07	1620-0153	1620-0154
XV1300 Royal Star 96-07	-	1620-0154
XV1600/1700 Road Star 99-08	-	1620-0154
XV1700PC Road Star Warrior 02-08	1620-0208	-
XV1900 Roadliner/Stratoliner 06-08	-	1620-0429
XV1900 Raider/S 08	1620-0150	1620-0429

MAGNUM™ QUICK CLAMPS

- Stainless steel construction
- 1/2" mounting hole
- Sold in pairs

DESCRIPTION	PART #	SUG. RETAIL	DESCRIPTION	PART #	SUG. RETAIL
1 1/4" i.d.	1624-0125	\$39.95	1 1/2" i.d.	1624-0126	42.95



All part numbers in **BOLD MAGENTA** are new this year.

- EXHAUST
- TIRES & ACCESSORIES
- LUGGAGE
- SPORTBIKE ACCESSORIES
- CRUISER ACCESSORIES
- TOURING ACCESSORIES
- SECURITY & AUDIO
- GENERAL ACCESSORIES
- FAIRINGS & BODY
- SEATS
- HANDLEBARS & CONTROLS
- LIGHTING
- ELECTRICAL
- SPROCKETS
- CHAINS
- BRAKES
- SUSPENSION
- ENGINE
- FUEL SYSTEMS
- LUBES
- TOOLS
- TRAILER
- MERCH.
- CROSS REFERENCE
- INDEX



- EXHAUST
- TIRES & ACCESSORIES
- LUGGAGE
- SPORTBIKE ACCESSORIES
- CRUISER ACCESSORIES**
- TOURING ACCESSORIES
- SECURITY & AUDIO
- GENERAL ACCESSORIES
- FAIRINGS & BODY
- SEATS
- HANDLEBARS & CONTROLS
- LIGHTING
- ELECTRICAL
- SPROCKETS
- CHAINS
- BRAKES
- SUSPENSION
- ENGINE
- FUEL SYSTEMS
- LUBES
- TOOLS
- TRAILER
- MERCH.
- CROSS REFERENCE
- INDEX

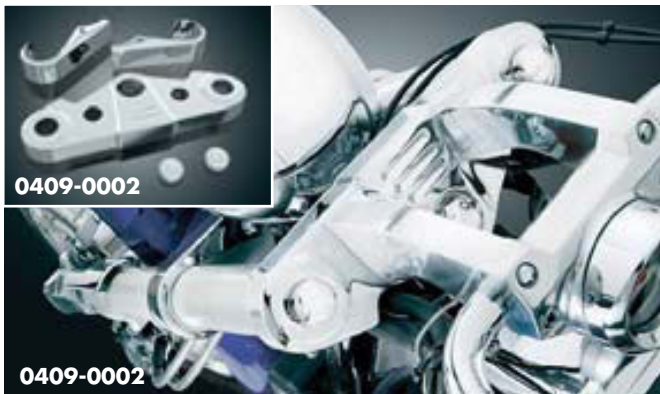

0409-0002

0409-0002

TRIPLE TREE COVER SETS FOR HONDA VTX1300/VTX1800

- The ultimate front-end dress-up kit for your VTX
- VTX1800 kit is a five-piece set that includes one-piece top triple clamp cover, die-cast fork tube caps and covers for the lower triple tree
- VTX1300 three-piece kit includes one-piece top triple clamp cover and a pair of die-cast fork tube clamps
- Gives the look of a custom chrome replacement triple tree at a fraction of the work and cost

FITS MODEL	PART #	SUG. RETAIL
HONDA		
VTX1300R/S/T 03-08, VTX1300C 04-08	0409-0003	\$59.95
VTX1800C/F 02-08	0409-0002	69.95

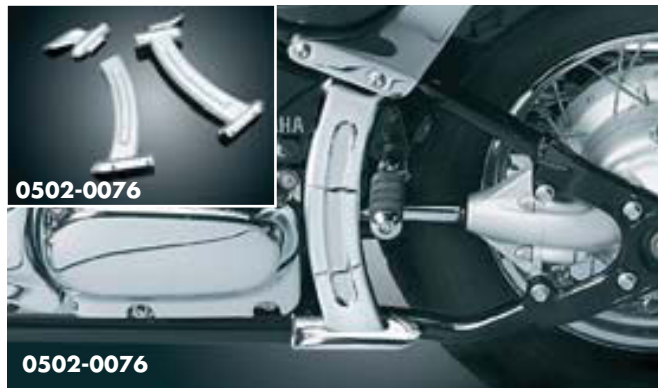

0502-0076

0502-0076

BOOMERANG FRAME COVERS

- Make your bike stand out from the rest
- Show-chromed, die-cast frame covers make artwork out of an otherwise ordinary part of your bike
- V-Star 1100 Boomerang covers include sleek covers that smooth the transition from the frame to the fender
- Sold in pairs

FITS MODEL	PART #	SUG. RETAIL
YAMAHA		
XV650 V-Star 98-08 (all)	0502-0076	\$99.95
XV1100 V-Star 99-08 (all)	0502-0077	159.95
XV1600/1700 Road Star 99-08 (all except Warrior)	0504-0162	199.95



MID-FRAME COVER FOR YAMAHA XV1100 V-STAR 99-08

- Turns the stock black frame tube into a real eye-catcher
- Looks so real, you can hardly tell it is just a cover
- Combine it with our Boomerang frame covers for a complete chrome frame appearance
- Quick, simple installation

SUG. RETAIL.....\$69.95 PART # 0504-0034



NECK COVER FOR YAMAHA V-STAR 1100 99-08 (ALL)

- A stunning replacement for the stock black components
- Not simply a replica of the stock part – sides have been smoothed and molded to provide a flowing appearance
- Right side of cover has a teardrop-shaped boss that surrounds the ignition switch to leave only the outer surface exposed
- Installs easily with simple hand tools

SUG. RETAIL.....\$79.95 PART # 0504-0033

NECK COVER FOR HONDA GL1500C VALKYRIE 97-03

- Delta-shaped cover hides the front tank mount tab and neck top
- Beautiful chrome finish
- Includes stainless steel mounting hardware

SUG. RETAIL.....\$24.95 PART # 0504-0110



FRAME TRIM COVER

- Transforms the rough black frame forging into a sleek, stylish accent
- Two-piece kit attaches with high-strength, high-temp adhesive
- Sold in pairs

SUG. RETAIL.....\$79.95

FITS MODEL	PART #
HONDA	
VTX1300 03-08 (all)	0504-0099



0504-0019

FITS MODEL	PART #
HONDA (CONT)	
VTX1800 02-08 (all)	0504-0019

All part numbers in **BOLD MAGENTA** are new this year.



PETCOCK COVER

FOR HONDA VTX1300
03-08 (ALL)

- Fully covers the unfinished petcock area with chrome
- Accents the left side of the fuel tank
- Sold each

SUG. RETAIL.....**\$39.95**

PART # 0705-0041



CURVED LICENSE PLATE FRAME WITH TURN SIGNALS

FOR YAMAHA XV1700
ROAD STAR 04-08
(ALL EXCEPT WARRIOR)

- Streamlines the look of the back fender
- Kit fully replaces stock turn signal and license plate bracket
- Sold as a kit

NOTE: Installation may be in violation of Federal Motor Vehicle Safety Standard #108; check local laws.

SUG. RETAIL.....**\$249.95**

PART # 2030-0188



FENDER LOUVERS

FOR HONDA VTX1300R/S AND VTX1800R/S/T 02-08

- Precision-fitting molded chrome inserts
- Really add classic, classy touch
- Sold in sets for one front or one rear fender

SUG. RETAIL.....**\$29.95**

DESCRIPTION	PART #
Front fender louver set	1405-0009
Rear fender louver set	1405-0010

VERTICAL LICENSE PLATE HOLDER WITH TAILLIGHT

- Moves the license plate to a sleek side-mount position
- Plate stays visible, holder has a built-in license plate light
- Built-in brake light styles have the option of mounting the light on the top or bottom of the plate
- License plate holder requires the use of Kuryakyn's motorcycle-specific mount bracket (sold separately)

DESCRIPTION	PART #	SUG. RETAIL
Lighted curved vertical side-mount	2030-0225	\$109.95
Lighted flat vertical side-mount with brake light	2030-0226	129.95
Lighted curved vertical side-mount with brake light	2030-0227	149.95



REAR GAS TANK TRIM

FOR HONDA VTX1300C 04-08

- Fills the void between the tank and the seat with beautiful chrome
- Quick, easy installation
- Sold each

SUG. RETAIL.....**\$39.95**

PART # 0701-0188

TRICEPTOR FENDER TIP

- Can be used as a fender tip accent, or mount it farther up on the fender to add a chrome highlight
- Simple peel-and-stick installation
- Fits front fender on Honda VTX1300/1800 02-08 (all) and Yamaha XVS650/1100 V-Star 99-08 (all), XVS1300 V-Star 07-08 (all), XV1600/1700 Road Star 99-08 (all except Warrior) and XV1900 Stratoliner/Roadliner 06-08 (all)
- Also designed for universal use on 4" wide or wider fenders; not recommended for use on fenders with a flat center width
- Sold each

SUG. RETAIL.....**\$39.95**

PART # 1421-0004

MOUNTS FOR VERTICAL SIDE- MOUNT LICENSE PLATE HOLDERS

- Motorcycle-specific mounts, designed for use with Kuryakyn side-mount license plate holders

SUG. RETAIL.....**\$29.95**



FITS MODEL	PART #
HONDA	
VTX1300 03-08 (all)	2030-0220
VTX1800 02-08 (all)	2030-0220
YAMAHA	
XVS650 V-Star 99-08 (all)	2030-0222
XVS1100 V-Star 99-08 (all)	2030-0222
XV1600/1700 Road Star 99-08 (all except Warrior)	2030-0221 ¹
XV1600/1700 Road Star 99-08 (all except Warrior) with Kuryakyn swingarm covers	2030-0223

¹ Also fits other motorcycles that have 1 1/4" diameter swingarms.

All part numbers in **BOLD MAGENTA** are new this year.

EXHAUST

TIRES & ACCESSORIES

LUGGAGE

SPORTBIKE ACCESSORIES

CRUISER ACCESSORIES

TOURING ACCESSORIES

SECURITY & AUDIO

GENERAL ACCESSORIES

FAIRINGS & BODY

SEATS

HANDLEBARS & CONTROLS

LIGHTING

ELECTRICAL

SPROCKETS

CHAINS

BRAKES

SUSPENSION

ENGINE

FUEL SYSTEMS

LUBES

TOOLS

TRAILER

MERCH.

CROSS REFERENCE

INDEX



- EXHAUST
- TIRES & ACCESSORIES
- LUGGAGE
- SPORTBIKE ACCESSORIES
- CRUISER ACCESSORIES
- TOURING ACCESSORIES
- SECURITY & AUDIO
- GENERAL ACCESSORIES
- FAIRINGS & BODY
- SEATS
- HANDLEBARS & CONTROLS
- LIGHTING
- ELECTRICAL
- SPROCKETS
- CHAINS
- BRAKES
- SUSPENSION
- ENGINE
- FUEL SYSTEMS
- LUBES
- TOOLS
- TRAILER
- MERCH.
- CROSS REFERENCE
- INDEX

CURVED LAYDOWN LICENSE PLATE MOUNT WITH FRAME

FOR HONDA VTX1300R/S 03-08 AND VTX1800R/S 02-08

- Curved backing plate and frame meet cleanly for a finished look
- Designed for use with a 4" x 7" license plate
- Mounts in stock license plate location

SUG. RETAIL.....\$69.95



PART # 2030-0192



LOWER FORK SKINS

- Sleek, stylized covers that add a smooth chrome finish to the fork leg sliders
- Easy installation
- Sold in sets

NOTE: VTX1300R/S/T applications do not include upper covers (above the fender bolt mounts) in order to maintain clearance for the OEM fork shrouds.



FITS MODEL	PART #	SUG. RETAIL
HONDA		
VTX1300C 03-08	0403-0020	\$159.95
VTX1300R/S/T 03-08	0403-0021	139.95
VTX1800 02-08 (all)	0403-0019	129.95

REFLECTOR COVERS

- Adds a chrome accent while leaving the reflectors on the bike for visibility
- Large cover fits reflectors that measure 3 1/2" x 13/8" or smaller with a clearance of 1/4" around the reflector in addition to models listed
- Small cover fits reflectors that measure 3 5/16" x 1 1/4" or smaller with a clearance of 1/4" around the reflector in addition to models listed
- Sold in pairs



SUG. RETAIL.....\$19.95

FITS MODEL	PART #
FRONT (SMALL)	
HONDA	
VT600C/CD Shadow VLX 99-07	0521-0322
VT750DC Shadow Spirit 01-03/05-08	0521-0322
VT1100C Shadow Spirit 97-08	0521-0322
VTX1800 02-08 (all)	0521-0322
FRONT (LARGE)	
YAMAHA	
XVS1100 V-Star 99-04 (all)	0521-0323
XVZ1300A/AT Royal Star/Royal Star Venture 96-03	0521-0323
XV1600/1700 Road Star 99-08 (all)	0521-0323
REAR (LARGE)	
HONDA	
VT1100C Spirit 97-08	0521-0322
VTX1300R/S 03-08	0521-0323
VTX1800 02-08 (all except VTX1800C)	0521-0323

SNAP-ON FORK COVERS FOR HONDA VTX1800 02-08 (ALL)

- Covers make it easy to have a fully-chromed front end in just minutes
- Just snap into place and ride
- Available with or without turn signal mounts – covers with turn signal mounts include turn signal mounts with 5/16"-18 bolts for OEM turn signals (or use for custom turn signal/driving lights)
- Installation requires relocation of the stock turn signals
- Sold as a complete set

NOTE: Not for use with OEM chrome forks



DESCRIPTION	PART #	SUG. RETAIL
Covers w/o turn signal mounts	0404-0046	\$179.95
Covers w/ turn signal mounts	0404-0047	229.95



DRIVE HUB TOP COVER FOR HONDA VTX1300/1800 02-08

- Sturdy construction with brilliant chrome finish
- Designed for use with Kuryakyn's shaft drive cover
- Sold each

SUG. RETAIL.....\$89.95

PART # 0213-0249



REGULATOR COVERS

- Add some sparkle to a bland area
- Traditional finned-style cover has slots to allow plenty of cooling airflow
- Sold each

SUG. RETAIL.....\$39.95

FITS MODEL	PART #
YAMAHA	
XV1600/1700 Road Star 99-07 (except Warrior)	2112-0173
For XV1600 99-03 only	2130-0011



HORN COVER

- Chrome cover bolts on over stock horn

SUG. RETAIL.....\$39.95



FITS MODEL	PART #
YAMAHA	
XV650 V-Star 98-08 (all)	2107-0012
XVS1100 V-Star 99-08 (all)	2107-0012

FINNED SPARK PLUG COVERS

FOR YAMAHA XV1700 ROAD STAR 04-08 (ALL EXCEPT WARRIOR)

- Gives the motor a full, clean look by filling in the area around the spark plug caps with chrome
- Simple installation
- Sold in pairs



SUG. RETAIL.....\$69.95 PART # 2103-0064

SPARK PLUG COVERS

FOR HONDA VTX1800C/R/S 02-08

- Beautiful replacement for the plain stock covers
- Slotted design with a chrome-plated finish
- Sold as a set of four



SUG. RETAIL.....\$59.95 PART # 0940-0285

0504-0012
Left



0504-0012
Right



ENGINE COVER INSERTS

- Racy, speed-lined inserts dress up the OEM engine covers
- Molded ABS chrome-plated inserts attach to the smooth stock covers with adhesive to add depth and a machined-from-billet look
- Install without tools
- Sold in sets of three (engine, timing and left crankcase cover)

SUG. RETAIL.....\$89.95

All part numbers in **BOLD MAGENTA** are new this year.

FITS MODEL	PART #
HONDA	
VTX1300 03-08 (all)	0504-0013
VTX1800 02-08 (all)	0504-0012



0940-0509

ENGINE CASE COVERS AND CLUTCH SHROUD

- Case covers fit along the base of the engine below the fins on both sides
- Bolt on in minutes and give the appearance of chromed engine cases
- Stamped steel, chrome-plated clutch cover finishes the job
- Clutch cover attaches with adhesive to cover the exposed upper surface of the clutch housing
- Case covers sold as a set, clutch shroud sold each

0940-0511



FITS MODEL	DESCRIPTION	PART #	SUG. RETAIL
HONDA			
VTX1300 03-08 (all)	Engine case covers	0940-0676	\$189.95
VTX1800 02-08 (all)	Engine case covers	0940-0509	189.95
	Clutch shroud	0940-0511	69.95

ENGINE CYLINDER BASE COVERS

FOR YAMAHA ROAD STAR XV1600/1700 (ALL EXCEPT WARRIOR)

- Add a brilliant chrome highlight to the left side of the motor and top of the transmission with these metal covers
- Simple installation
- Sold as a set



SUG. RETAIL.....\$99.95 PART # 0940-0594

- EXHAUST
- TIRES & ACCESSORIES
- LUGGAGE
- SPORTBIKE ACCESSORIES
- CRUISER ACCESSORIES
- TOURING ACCESSORIES
- SECURITY & AUDIO
- GENERAL ACCESSORIES
- FAIRINGS & BODY
- SEATS
- HANDLEBARS & CONTROLS
- LIGHTING
- ELECTRICAL
- SPROCKETS
- CHAINS
- BRAKES
- SUSPENSION
- ENGINE
- FUEL SYSTEMS
- LUBES
- TOOLS
- TRAILER
- MERCH.
- CROSS REFERENCE
- INDEX



- EXHAUST
- TIRES & ACCESSORIES
- LUGGAGE
- SPORTBIKE ACCESSORIES
- CRUISER ACCESSORIES
- TOURING ACCESSORIES
- SECURITY & AUDIO
- GENERAL ACCESSORIES
- FAIRINGS & BODY
- SEATS
- HANDLEBARS & CONTROLS
- LIGHTING
- ELECTRICAL
- SPROCKETS
- CHAINS
- BRAKES
- SUSPENSION
- ENGINE
- FUEL SYSTEMS
- LUBES
- TOOLS
- TRAILER
- MERCH.
- CROSS REFERENCE
- INDEX

LOWER BELT GUARD ACCENT

FOR YAMAHA XV1600/1700 ROAD STAR 99-08 (ALL EXCEPT WARRIOR)

- Covers the stock black plastic guard with gleaming chrome
- Easy to install

SUG. RETAIL.....\$79.95



PART # 1203-0010

MOTOR MOUNT ACCENTS

FOR HONDA VTX1800C/R/S 02-08

- Cut from stainless steel and polished to a mirror finish
- Cover plain black motor mounts and fill in some of the dead space around the engine
- Three of the four mounts are slotted so you may back-mount accent lights for a vibrant look
- Sold in a set of four

SUG. RETAIL.....\$69.95

PART # 0940-0284



TAPPET BLOCK COVERS

- Metal covers bolt directly over the bottom of the pushrod tubes
- Finish the look with included bottom trim piece (available for some applications)
- Brilliant chrome finish
- Sold as a set of tappet block covers and lower trim piece or a pair of tappet blocks only; see chart

FITS MODEL PART # SUG. RETAIL

YAMAHA		
XV1600/1700 Road Star 02-08, XV1700 Road Star Warrior 02-08 (set of tappet block covers and trim piece)	0940-0593	\$89.95
XV1900 Roadliner/Stratoliner 06-08, XV1700 Road Star 04-08, XV1700 Road Star Warrior 02-08 (tappet block covers only)	0950-0246	79.95



RADIATOR TRIM

- A great way to dress up the drab OEM radiator
- Beautifully chrome finished with beveled edge
- Amber LEDs add a touch of class
- Measures 1" x 6 7/8"; universal fitment
- Can be mounted on top or bottom of radiator with ease

SUG. RETAIL.....\$49.95

PART # 1904-0025



MID ENGINE TRIM

FOR HONDA VTX1800 02-08 (ALL)

- Add a chrome highlight to the cylinder heads of your VTX
- Mount behind stock or Kuryakyn spark plug covers
- Sold as set of four

SUG. RETAIL.....\$79.95



PART # 0940-0587

PUSHROD TOP COVERS

FOR YAMAHA ROAD STAR

- Small detail, big improvement
- Links the chrome of the pushrod tubes with the stock valve covers
- Sold in pairs



SUG. RETAIL.....\$39.95

FITS MODEL	PART #
YAMAHA	
XV1600A Road Star 99-03	0940-0588
XV1700A Road Star 04-08 (all except Warrior)	0940-0589

FLAMED PUSHROD TUBE ACCENTS

FOR YAMAHA ROAD STAR, ROAD STAR WARRIOR, ROADLINER, STRATOLINER AND RAIDER

- Chromed metal flames accent Yamaha or any 2" diameter pushrod tubes
- Install in minutes
- Sold in pairs

NOTE: Not recommended for use on exhaust pipes.

SUG. RETAIL.....\$39.95

PART # 0940-0595



RADIATOR SIDE TRIM

FOR HONDA VTX1800C/R 02-03

- Instant eye-catcher
- Sturdy chrome inserts with LEDs provide slick details and really dress up the bike
- LEDs function as additional running and turn signal lights for added visibility

SUG. RETAIL.....\$99.95

PART # 1904-0024





SHIFT ROD LINKAGE

FOR YAMAHA
XV1600/1700 ROAD
STAR 99-08
(ALL EXCEPT WARRIOR)

- Stainless steel construction with show-chrome finish
- Direct replacement, bolts right on
- Sold each

SUG. RETAIL... **\$89.95**



1601-0227



1601-0228

DESCRIPTION	PART #
Zombie	1601-0227
Widow	1601-0228

REAR MASTER CYLINDER COVER

FOR YAMAHA XV1600/1700 ROAD
STAR 99-08 (ALL EXCEPT WARRIOR)

- Quick, stylish upgrade
- Stick on the chrome cover, bolt on the chrome shroud and get a clean, finished look

SUG. RETAIL..... **\$29.95**



PART #	1731-0114
--------	-----------



1731-0161



17310070

MASTER CYLINDER COVERS

- Brake master cylinder cover cures the dull stock look
- Fits over the stock reservoir for a quick, easy installation
- Deluxe set for VTX1800 includes brake and clutch master cylinder covers
- Sold each; deluxe set sold in pairs

FITS MODEL	PART #	SUG. RETAIL
HONDA		
VT1100C Shadow 99-08 (all)	1731-0071	\$39.95
VTX1300 02-08 (all)	1731-0071	39.95
VTX1800 02-08 (all)	1731-0071	39.95
Deluxe set	1731-0072	69.95
YAMAHA		
XV650 V-Star 98-07 (all)	1731-0069	39.95
XV650 V-Star 08	1731-0161	49.95
XV1100 V-Star 99-07 (all)	1731-0069	39.95
XV1100 V-Star 08	1731-0161	49.95
XV1300 V-Star 07-08	1731-0161	49.95
XV1600/1700 Road Star 99-08	1731-0070	39.95

ACCESSORY SWITCHES

FOR MASTER CYLINDER RESERVOIR COVERS

- Convenient way to get fingertip control of accent lights and other motorcycle electrical accessories
- Cover has three switches; each is rated for 12V and up to 12A
- Fit the following Honda models: GL1500 Gold Wing 88-00, GL1800 Gold Wing 01-08, VTX1300/1800 02-08 (all), VT600C/CD Shadow VLX 96-07, VT750C Shadow Spirit 01-08, VT750CD Shadow American Classic Edition (A.C.E.) Deluxe 98-03, VT750C Shadow Aero 04-08, VF750C Magna 96-03, VT1100C Honda Shadow Spirit/Aero/Tourer/Sabre 97-08, GL1500C Valkyrie 97-03 (all)
- Fit the following Yamaha models: XV1300 Royal Star 96-01, XV1300AT Royal Star Venture 02, XV1600/1700 Road Star 99-08 (all)
- Sold each



SUG. RETAIL..... **\$69.95**

PART #	2106-0046
--------	-----------

STARTER MOTOR COVER

FOR YAMAHA XV1600/1700 ROAD
STAR 99-08 (ALL EXCEPT WARRIOR)

- Gives the starter motor end top a clean, chromed appearance
- Included block-off plates remove the rubber hoses next to the starter motor and all the clutter between the front frame tubes and front cylinder

NOTE: Installation of this cover or any emissions modifications may be in violation of local regulations. Check local laws before ordering.

SUG. RETAIL..... **\$69.95**



PART #	2110-0211
--------	-----------

FRONT DRIVE PULLEY COVER

FOR YAMAHA XV1600/1700
ROAD STAR 99-08 (ALL
EXCEPT WARRIOR)

- Adds the look of motion to the front pulley drive cover
- Simple installation

SUG. RETAIL..... **\$49.95**

PART #	1201-0230
--------	-----------



BRAKE PEDAL AND SHIFT PEG COVERS

FOR KAWASAKI VULCAN

- Customize stock controls in just minutes
- Black rubber inserts with a chrome finish
- Encapsulate OEM pieces
- Fit VN1500 Vulcan 87-04, VN1600 Vulcan Classic 03-04
- Sold each

NOTE: Some VN1500 models will require minor modifications for installation.

DESCRIPTION	PART #	SUG. RETAIL	DESCRIPTION	PART #	SUG. RETAIL
Brake pedal cover	1611-0006 ¹	\$29.95	Shift peg cover	1611-0007	\$18.95

¹ Will not fit J/R/L/N/P models.



All part numbers in **BOLD MAGENTA** are new this year.

EXHAUST

TIRES & ACCESSORIES

LUGGAGE

SPORTBIKE ACCESSORIES

CRUISER ACCESSORIES

TOURING ACCESSORIES

SECURITY & AUDIO

GENERAL ACCESSORIES

FAIRINGS & BODY

SEATS

HANDLEBARS & CONTROLS

LIGHTING

ELECTRICAL

SPROCKETS

CHAINS

BRAKES

SUSPENSION

ENGINE

FUEL SYSTEMS

LUBES

TOOLS

TRAILER

MERCH.

CROSS REFERENCE

INDEX



- EXHAUST
- TIRES & ACCESSORIES
- LUGGAGE
- SPORTBIKE ACCESSORIES
- CRUISER ACCESSORIES**
- TOURING ACCESSORIES
- SECURITY & AUDIO
- GENERAL ACCESSORIES
- FAIRINGS & BODY
- SEATS
- HANDLEBARS & CONTROLS
- LIGHTING
- ELECTRICAL
- SPROCKETS
- CHAINS
- BRAKES
- SUSPENSION
- ENGINE
- FUEL SYSTEMS
- LUBES
- TOOLS
- TRAILER
- MERCH.
- CROSS REFERENCE
- INDEX

LOWER SWINGARM EXTENSION COVER

FOR YAMAHA XV1600/1700 ROAD STAR 99-08 (ALL EXCEPT ROAD STAR WARRIOR)

- Covers the lower right swingarm tube with chrome
- Looks great with a custom exhaust or with Kuryakyn swingarm covers



SUG. RETAIL.....\$29.95

PART # 1303-0090

1205-0050



1303-0034



SHAFT DRIVE AND SWINGARM COVERS FOR HONDA VTX

- Sets a new standard in style
- Shaft drive cover is a two-piece stamped steel construction with a chrome-plated finish
- Covers both the differential and the shaft tube, giving the appearance of a completely chromed assembly
- Drive shaft cover fits all VTX1300 03-08 models and all VTX1800 02-08
- Right side swingarm cover completes the look on the VTX1800, giving the appearance of a chromed swingarm at a fraction of the cost
- Swingarm cover fits VTX1800 02-08 models only
- Shaft drive and swingarm covers sold separately

DESCRIPTION	PART #	SUG. RETAIL
Shaft drive cover	1205-0050	\$139.95
Swingarm cover	1303-0034	99.95

1205-0051



1303-0007

SHAFT DRIVE/PHANTOM COVERS FOR YAMAHA XV650/1100 V-STAR 98-08 (ALL)

- Shaft drive cover gives your bike the chromed housing look at a fraction of the cost
- Simple installation
- Phantom covers create a smooth, streamlined look that is a beautiful highlight
- Chrome-finish covers go over the rear fasteners, frame tubes, axles, hubs, etc.
- Shaft drive cover sold each, Phantom covers sold in pairs

DESCRIPTION	PART #
Shaft drive cover	1205-0051

SUG. RETAIL.....\$79.95

DESCRIPTION	PART #
Phantom covers	1303-0007

REAR SHOCK TOP COVERS FOR HONDA

- Kuryakyn's stylish Blood Groove design with a chrome finish
- Covers measure 3 1/8" in diameter and 3/4" from the shock bolt eye to the top of the cover
- Fit models listed and other models with shocks that match the cover dimensions
- Sold in pairs



SUG. RETAIL.....\$49.95

PART # 1320-0011

FITS MODEL

HONDA

VT750C Shadow A.C.E./Spirit/Aero (all), VT1100C Shadow Sabre/Spirit (all), VTX1300 (all) and VTX1800 (all except VTX1800N)

PHANTOM COVERS AND SWINGARM COVERS

FOR YAMAHA XV1600/1700 ROAD STAR (ALL EXCEPT WARRIOR)

- Smooth the lines of the bike and hide welds and rough-cast areas
- Cover the axle, adjustment bolts and rough castings in one easy step
- Add extra shine in just minutes
- Phantom covers sold in pairs; swingarm covers sold as a set



DESCRIPTION	PART #	SUG. RETAIL
Phantom covers	1303-0036	\$79.95
Swingarm covers	1303-0037	159.95



TRANSMISSION COVER SET

FOR HONDA GL1500C VALKYRIE 97-03

- Add a beautiful chrome finish to the stock cast transmission cases
- Bolt-on covers include all necessary hardware for an easy, classy looking installation



SUG. RETAIL.....\$159.95

PART # 1107-0046



STILETTO™ FRONT AXLE CAPS

FOR HONDA
VTX1300/1800 (ALL)

- Aggressive styling
- Look great by themselves, or couple them with other Kuryakyn Stiletto™ line accessories
- Simple bolt-on installation
- Sold in pairs

SUG. RETAIL.....\$79.95



PART # 0214-0135

FRONT AXLE CAPS

FOR KAWASAKI VN1500
VULCAN 95-04 (ALL)

- Covers the axle ends with brilliant chrome
- Quick, easy installation
- Sold in pairs

SUG. RETAIL.....\$19.95

PART # 0214-0251



BRAKE LINE ACCENT COVERS

FOR HONDA VTX1800 (ALL)

- Covers the bare, stamped brackets with blood-groove chrome accents
- Clean up the lower fork area
- Sold in pairs

SUG. RETAIL.....\$39.95



PART # 1742-0113



1703-0028



1703-0029

BRAKE CALIPER COVERS

- Show-chrome caliper covers
- Easy to install
- Honda VTX1800 front covers sold in pairs; all others sold each

FITS MODEL	POS.	PART #	SUG. RETAIL
HONDA			
VTX1300 03-08 (all)	Front	1703-0056	\$39.95
	Rear	1703-0045	39.95
VTX1800 03-08 (all)	Front	1703-0028	49.95
VTX1800 02-08 (all)	Rear	1703-0029	39.95
KAWASAKI			
VN900 Vulcan 06-08 (all)	Front	1703-0048	19.95
	Rear	1703-0059	39.95
VN1500/1600 Mean Streak 02-08	Rear	1703-0059	39.95
VN1600 Vulcan 03-08	Rear	1703-0059	39.95
VN2000 Vulcan 04-08	Rear	1703-0059	39.95
SUZUKI			
VL800 Volusia 01-04/C50 Boulevard 05-08	Front	1703-0048	19.95
M109R Boulevard 06-08	Rear	1703-0044	29.95
C109R Boulevard 08	Rear	1703-0059	39.95
YAMAHA			
XVS1100 V-Star 99-08 (all)	Front	1703-0048	19.95
XV1300 V-Star 06-08 (all)	Front	1703-0048	19.95
XV1300 Royal Star Venture 99-07	Front	1703-0048	19.95



REAR BRAKE COMPONENT DRESS-UP KITS FOR HONDA VTX1800

- Turn dull stock components into chrome-finished artwork
- Kits include replacement fluid reservoir cap and wraparound reservoir cover
- VTX1800C kit also has a streamlined cover for the master cylinder
- All necessary installation hardware included

FITS MODEL	PART #	SUG. RETAIL
HONDA		
VTX1800C 02-06	1731-0056	\$49.95
VTX1800R/S 03-08	1731-0057	29.95



CLUTCH CABLE ADJUSTER COVER

- Dress up that crude, zinc-plated cable adjuster
- Two-piece design encapsulates the threaded adjuster
- Installs using spring clips so it can be easily removed to adjust the cable
- Sold each

SUG. RETAIL.....\$29.95



FITS MODEL	PART #
HONDA	
VLX600 Shadow 88-02, VT750 Shadow/Shadow A.C.E. 98-03, VF750C Magna 96-01, CB750 Nighthawk 00-02, VTX1300 02-08 (all)	0659-0006

SUZUKI	
VZ800 Marauder 99-02	0659-0006

YAMAHA	
XVS650 V-Star 98-08 (all)	0659-0006

All part numbers in **BOLD MAGENTA** are new this year.



CLUTCH CABLE FERRULE ACCENT

- Slip-on chrome accent
- Installs quickly and easily
- Sold each

SUG. RETAIL.....\$19.95

PART # 0660-0002

- EXHAUST
- TIRES & ACCESSORIES
- LUGGAGE
- SPORTBIKE ACCESSORIES
- CRUISER ACCESSORIES**
- TOURING ACCESSORIES
- SECURITY & AUDIO
- GENERAL ACCESSORIES
- FAIRINGS & BODY
- SEATS
- HANDLEBARS & CONTROLS
- LIGHTING
- ELECTRICAL
- SPROCKETS
- CHAINS
- BRAKES
- SUSPENSION
- ENGINE
- FUEL SYSTEMS
- LUBES
- TOOLS
- TRAILER
- MERCH.
- CROSS REFERENCE
- INDEX



BANJO BOLT COVERS

- Cover up those ugly zinc or cad-plated banjo and brake caliper bolts with these chrome-plated beauties
- Standard and Long Bullet styles available
- Standard style fits any banjo fitting that requires a 12mm wrench
- Long Bullet style fits any banjo or bolt fitting that requires 12mm wrench, and only has one brake line protruding
- Sold each

DESCRIPTION	PART #	SUG. RETAIL
Standard	1742-0080	\$14.95
Long bullet	1742-0081	15.95



REAR SUSPENSION LOWERING KIT FOR YAMAHA XV650 V-STAR CLASSIC/CUSTOM 98-07

- Replaces the stock shock head
- Lowers the rear of the motorcycle approximately 1 1/2", maintains full suspension travel to minimize bottoming out

SUG. RETAIL.....\$94.95

PART #	1304-0180
--------	-----------



REAR SUSPENSION LOWERING KITS

- Replace the stock suspension arms
- Give your bike the low look without losing suspension travel
- Kits include everything needed for a complete installation

FITS MODEL	LOWERED DISTANCE	PART #	SUG. RETAIL
SUZUKI			
C90 Boulevard 05-08	1" - 2"	1304-0183	\$54.95
VL1500LC Intruder 98-04	1" - 2"	1304-0183	54.95
YAMAHA			
XVS1100 V-Star Classic/Custom 99-08	1" - 1 3/4"	1304-0181	54.95
XV1300 V-Star 07-08	1" - 1 3/4"	1304-0181	54.95
XV1600/1700 Road Star/Warrior 99-07	1 1/2"	1304-0184	94.95



BANJO BOLT KITS FOR VICTORY

- Banjo bolt and bleeder bolt covers for all Victory models
- Sold in sets or each, depending on application

DESCRIPTION	PART #	SUG. RETAIL
Clutch banjo bolt/cover (set)	1742-0082	\$24.95
Banjo bolt cover (ea.)	1742-0083	14.95
Brake bleeder screw cover (ea.)	1742-0084	9.95



BULLET COVERS

- Smooth, stylish covers add an accent to almost anywhere
- Measure just 3/4" W x 15/16" H
- Fit all Honda VTX1800 12mm brake caliper bolts
- Universal fit with most 12mm and 7/16" hex bolts
- Sold each

SUG. RETAIL.....\$14.95

PART #	1742-0114
--------	-----------



SHOCK SPRINGS FOR YAMAHA

- Springs are rated at 200 lb. greater than stock shock spring
- Provides better damping and smooth ride
- Ideal for use with L.A. Chopper's lowering kits
- Also a great upgrade for heavier riders or riders who regularly ride with a passenger and/or luggage
- Sold each

SUG. RETAIL.....\$74.95

FITS MODEL	PART #
YAMAHA	
XVS650 V-Star Classic/Custom 98-08	1312-0159
XVS1100 V-Star Classic/Custom 98-08	1312-0160

FITS MODEL	PART #
YAMAHA (CONT)	
XV1600/1700 Road Star 99-08	1312-0159
XV1700 Road Star Warrior 02-08	1312-0159



REAR SHOCK DROP BRACKET LOWERING KITS

- Quickly and easily give your bike that low-down custom look
- Kits include brackets and all necessary hardware for a complete installation

SUG. RETAIL.....\$94.95

FITS MODEL	DISTANCE LOWERED	PART #
HONDA		
VT600 Shadow VLX 88-07	1 1/2" - 2 1/2"	1304-0189
VT750 Shadow Ace 98-03	1 1/2"	1304-0186
VT750 Aero 04-08	1 1/2"	1304-0188
VT750 Shadow Spirit 02-07 (chain drive)	1 1/2"	1304-0186
VT750C2 Shadow Spirit 07-08	1 1/2"	1304-0188
VT750DC Shadow Spirit 01-03/05-07	1 1/2"	1304-0188
KAWASAKI		
VN900 Vulcan 06-08	1" - 2"	1304-0185 ¹

FITS MODEL	DISTANCE LOWERED	PART #
SUZUKI		
M109R Boulevard 06-08	2"	1304-0213
YAMAHA		
XV1700 Road Star/Warrior 02-07	1" - 2"	1304-0190 ²
XV1900 Raider 08	1 3/4"	1304-0223
XV1900 Roadliner/Stratoliner 06-08	1 3/4"	1304-0212 ³

¹ SUG. RETAIL \$149.95.
² SUG. RETAIL \$119.95.
³ SUG. RETAIL \$103.95.

STORAGE TUBES

- Billet aluminum construction
- The perfect place to store tools, a T-shirt, registration papers, glasses or other loose items while on the ride
- Measure 8" L x 4" diameter
- Install securely on any frame downtube with a 1 1/4" diameter clamp

SUG. RETAIL.....\$185.95

DESCRIPTION	PART #
Smooth	3550-0082
Fluted	3550-0083





1312-0212

PERFORMANCE SPRINGS YAMAHA CRUISER MODELS

- Engineered to allow your shock to work effectively
- This spring is a necessity for heavier riders or when carrying passengers
- Improves damping control while eliminating bounce
- Provides better control in corners and rough roads
- Great with or without lowering kits



SUG. RETAIL.....**\$82.95**

FITS MODEL	PART #
YAMAHA	
XVS650 V-Star Classic/Custom 98-08	1312-0212 ¹
XVS1100 V-Star Classic/Custom 99-08	1312-0213 ²
XV1600/1700 Road Star 99-07	1312-0212 ¹
XV1700PC Road Star Warrior 02-08	1312-0212 ¹

¹ 930 lb. spring rate is the best possible to suit most riders.
² 800 lb. spring rate is the best possible to suit most riders.



1302-0253

REAR LOWERING KITS ROAD STAR/WARRIOR

- Engineered to safely lower the rear of your motorcycle 1 5/8"
- Makes it easier to hold up at a stop
- Lowers the center of gravity for improved handling
- Gives the bike a tough, custom look
- Precision machined from T6061 billet aluminum
- Uses OEM bearings for best fit
- Performance spring available (sold separately)

SUG. RETAIL.....**\$94.95**

FITS MODEL	PART #
YAMAHA	
XV1600/1700 Road Star 99-09	1302-0253
XV1700PC Road Star Warrior 02-09	1302-0253



1302-0255

REAR LOWERING KITS YAMAHA AND SUZUKI CRUISER MODELS

- Engineered to safely lower the rear of the motorcycle
- Offers three adjustment heights: 2" drop, 1" drop or stock height
- Makes the bike easier to control when stopped
- Lower center of gravity enhances handling
- Easy do-it-yourself installation guide included
- Recommend use of heavy-duty rear spring for heavier riders or two up riding on Yamaha models (sold separately)

SUG. RETAIL.....**\$54.95**

FITS MODEL	PART #
SUZUKI	
C50/T Boulevard 06-08	1302-0255
C90/T Boulevard 06-08	1302-0256
VL800 Intruder Volusia 01-04	1302-0255
VL1500 Intruder LC 98-04	1302-0256
YAMAHA	
XVS1100 V-Star Classic/Custom 99-08	1302-0255
XVS1300A V-Star 07-08	1302-0255



1302-0254

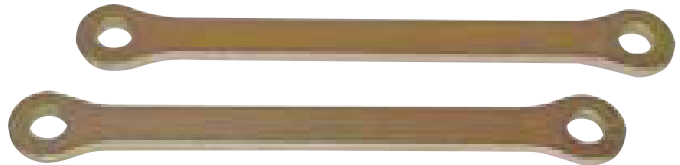

REAR LOWERING KIT VENTURE AND ROYAL STAR

- Engineered to lower the rear of the motorcycle a safe and perfect 1"
- Makes it easier to hold up bike while stopped
- Lowers the center of gravity for improved handling
- Properly relocates the stock caliper to a new position to eliminate interference with fender
- Lowering arms, caliper relocation bracket included
- Caution! Lowering your bike will reduce its cornering angles and the stability of the bike while on its side stand

SUG. RETAIL.....**\$194.95**

FITS MODEL	PART #
YAMAHA	
XVZ1300TF Royal Star Venture 99-08	1302-0254
XVZ1300CT Royal Star Tour Deluxe 05-08	1302-0254

LOWERING KIT

FOR XVS650 V-STAR CLASSIC/CUSTOM 99-08

- Engineered to safely lower the rear of your bike
- Lowers motorcycle 1 1/2"
- Lower center of gravity enhances handling
- Replaces OEM stock head
- Reuses stock damper bushing
- Precision machined from T6061 billet aluminum
- Installs quickly with the included easy to follow installation guide



SUG. RETAIL.....**\$79.95** PART # 1302-0252

All part numbers in **BOLD MAGENTA** are new this year.

- EXHAUST
- TIRES & ACCESSORIES
- LUGGAGE
- SPORTBIKE ACCESSORIES
- CRUISER ACCESSORIES
- TOURING ACCESSORIES
- SECURITY & AUDIO
- GENERAL ACCESSORIES
- FAIRINGS & BODY
- SEATS
- HANDLEBARS & CONTROLS
- LIGHTING
- ELECTRICAL
- SPROCKETS
- CHAINS
- BRAKES
- SUSPENSION
- ENGINE
- FUEL SYSTEMS
- LUBES
- TOOLS
- TRAILER
- MERCH.
- CROSS REFERENCE
- INDEX



- EXHAUST
- TIRES & ACCESSORIES
- LUGGAGE
- SPORTBIKE ACCESSORIES
- CRUISER ACCESSORIES**
- TOURING ACCESSORIES
- SECURITY & AUDIO
- GENERAL ACCESSORIES
- FAIRINGS & BODY
- SEATS
- HANDLEBARS & CONTROLS
- LIGHTING
- ELECTRICAL
- SPROCKETS
- CHAINS
- BRAKES
- SUSPENSION
- ENGINE
- FUEL SYSTEMS
- LUBES
- TOOLS
- TRAILER
- MERCH.
- CROSS REFERENCE
- INDEX



After



Before

CABLE, HOSE AND WIRE CHROME DRESS-UP KIT

- Use what the professionals use to cover cables, hoses and wires quickly and inexpensively
- Cover your wire harnesses, handlebar wiring, brake lines, throttle lines and fuel hose
- Expands easily to fit over ends for smooth installation and long lasting protection
- Dynamic chrome covering adds a bright, shiny appearance
- Fits snugly for a clean, custom look
- More than enough product to do your entire motorcycle
- Can be used to customize any motorcycle
- Kit includes 6 ft. of 1/2", 20 ft. of 3/8", 8 ft. of 1/4" diameter, expandable chrome covering plus six chrome zip ties and black and clear shrink tubing

SUG. RETAIL.....\$39.95 PART # 0659-0009



ROAD STAR CHROME BELT GUARD

- Direct replacement for stock plastic guard
- Installation does not require removal of rear wheel, unlike other belt guards
- Beautifully styled and chromed
- Features belt adjustment window
- Sturdy, steel construction does not dent easily like aluminum covers
- Includes all necessary instructions and hardware

SUG. RETAIL.....\$109.95

FITS MODEL	PART #
YAMAHA	
XV1600/1700 Road Star 99-08	1202-0068



1731-0147

FLAME MASTER CYLINDER RESERVOIR COVERS

- Cap off your brake or clutch master cylinder with a flashy look
- Adds style to a high visibility area
- Replaces stock master cylinder cap
- Beautifully chromed billet aluminum
- Complete with mounting instructions

SUG. RETAIL.....\$29.95

FITS MODEL	PART #
HONDA	
VTX1300C/R 02-08	1731-0147
VTX1800 03-08	1731-0147
KAWASAKI	
VN900 Vulcan Classic/Custom/LT 06-08	1731-0149
VN1500/1600 Vulcan Mean Streak 02-08	1731-0149
VN1600 Vulcan Classic/Nomad 03-08	1731-0149
VN2000A Vulcan 04-08	1731-0149
SUZUKI	
C50/T Boulevard 05-08	1731-0150
C90/T Boulevard 05-08	1731-0150
VL1500 Intruder LC 98-04	1731-0150
YAMAHA	
XVS650 V-Star Classic/Custom 98-08	1731-0148
XVS1100 V-Star Classic/Custom 98-08	1731-0148
XVZ1300A Royal Star 96-01	1731-0147
XVZ1300TF Royal Star Venture 99-08	1731-0147
XV1600/1700 Road Star 99-07	1731-0147
XV1700PC Road Star Warrior 02-08	1731-0147

FORK BULLETS/AXLE NUT COVERS

- Adds style to your front end
- Tapers front forks to a dynamic bullet point
- Beautifully chromed billet aluminum
- Covers axles and exposed hardware
- Very easy to install

0412-0162



SUG. RETAIL.....\$139.95

FITS MODEL	PART #
HONDA	
VTX1300C 02-07	0412-0162
VTX1300 Retro 05-08	0412-0162
KAWASAKI	
Vulcan 900 Classic/LT 06-08	0412-0162
Vulcan 1500 Classic 97-08	0412-0162
Vulcan 1500 Drifter 99-05	0412-0162
SUZUKI	
Volusia 800 01-04	0412-0162
Intruder 1400 87-04	0412-0162
Intruder LC 1500 98-04	0412-0162
YAMAHA	
V-Star 1100 Classic/Custom 99-08	0412-0162
XVZ1300A Royal Star 96-01	0412-0162
XVZ1300CT Royal Star Tour Deluxe 05-08	0412-0162
V-Star 1300 07-08	0412-0162
XVZ1300 Venture 99-08	0412-0162
XV1600A Road Star 99-03	0412-0162
XV1900C Raider 08	0412-0162

BULLET GRIP ENDS

- Bullet grip ends give your Kuryakyn ISO™ grips a finished aggressive look
- Beautifully shaped and chromed
- Weighted bullets act as bar-end weights, reducing handlebar vibration
- Works with ISO Throttle Boss
- Very quick and easy to install

SUG. RETAIL..... **\$51.95** PART # **0634-0191**



0630-0544



BULLET TACHOMETER

- Sleek beautifully chromed housing
- Accurate 0-8000 RPM data every biker needs
- Mounts easily in multiple locations and positions
- Super bright illuminated for night riding
- Choice of black or white analog face
- Available for 1" or 1 1/4" handlebars
- Compact 27/8" D x 3 1/2" L housing
- Hardware and easy to follow instructions included
- Fits most 2- or 4-cylinder motorcycles
- Includes Tach adapter for single-fire ignition



2211-0048

2211-0049

DESCRIPTION	PART #	SUG. RETAIL
1" HANDLEBARS		
White face	2211-0048	\$199.95
Black face	2211-0049	199.95
1 1/4" HANDLEBARS		
White face	2211-0050	209.95
Black face	2211-0051	209.95

MINI-BULLET TACHOMETER

- Super compact beautifully chromed 25/16" x 33/8" mini housing
- Accurate 0-8000 RPM data every biker needs
- Mounts easily in multiple locations and positions
- Brightly illuminated for night riding
- 1" bar clamp allows through-the-bar wire exit point
- Fits most 2- or 4-cylinder motorcycles
- Optional master cylinder mount available (sold separately)
- Special base allows custom mounting applications



2211-0059

2211-0060

DESCRIPTION	PART #	SUG. RETAIL
WITH 1" BAR MOUNT		
White face	2211-0059	\$229.95

DESCRIPTION	PART #	SUG. RETAIL
WITH 1" BAR MOUNT (CONT)		
Black face	2211-0060	\$229.95

FITS MODEL	PART #	SUG. RETAIL
MASTER CYLINDER MOUNTS		
HONDA		
VTX1300C 02-07	2211-0061	\$39.95
VTX1300 Retro 05-08	2211-0061	39.95
VTX1800 02-07 (all)	2211-0061	39.95
KAWASAKI		
VN900 Vulcan Classic/LT 06-08	2211-0063	39.95
VN900C Vulcan Custom 07-08	2211-0063	39.95
VN1600E Vulcan Classic 03-08	2211-0063	39.95
VN1600G Vulcan Nomad 05-08	2211-0063	39.95
VN2000A Vulcan 04-08	2211-0063	39.95
SUZUKI		
C50/T Boulevard 06-08	2211-0064	39.95
YAMAHA		
XVS650 V-Star Classic/Custom 98-08	2211-0062	39.95
XVS1100 V-Star Classic/Custom 98-08	2211-0062	39.95
XVZ1300A Royal Star 96-01	2211-0061	39.95
XVZ1300CT Royal Star Tour Deluxe 05-08	2211-0061	39.95
XVZ1300TF Royal Star Venture 99-08	2211-0061	39.95
XV1600/1700 Road Star 99-07	2211-0061	39.95
XV1700PC Road Star Warrior 02-08	2211-0061	39.95

TACHOMETER ADAPTER

- Provides correct RPM display
- Fits most accessory electronic tachometers
- Required for most 2- or 4-cylinder engines with single-fire ignitions
- Required for most bikes equipped with fuel injection
- Reduces needle fluctuation
- Has been redesigned for owners that have had tach bounce issues in the past
- This adapter is the cure for your tach bouncing headaches

SUG. RETAIL..... **\$30.95**
PART # **2211-0052**



All part numbers in **BOLD MAGENTA** are new this year.

- EXHAUST
- TIRES & ACCESSORIES
- LUGGAGE
- SPORTBIKE ACCESSORIES
- CRUISER ACCESSORIES
- TOURING ACCESSORIES
- SECURITY & AUDIO
- GENERAL ACCESSORIES
- FAIRINGS & BODY
- SEATS
- HANDLEBARS & CONTROLS
- LIGHTING
- ELECTRICAL
- SPROCKETS
- CHAIN
- BRAKES
- SUSPENSION
- ENGINE
- FUEL SYSTEMS
- LUBES
- TOOLS
- TRAILER
- MERCH.
- CROSS REFERENCE
- INDEX



- EXHAUST
- TIRES & ACCESSORIES
- LUGGAGE
- SPORTBIKE ACCESSORIES
- CRUISER ACCESSORIES
- TOURING ACCESSORIES
- SECURITY & AUDIO
- GENERAL ACCESSORIES
- FAIRINGS & BODY
- SEATS
- HANDLEBARS & CONTROLS
- LIGHTING
- ELECTRICAL
- SPROCKETS
- CHAINS
- BRAKES
- SUSPENSION
- ENGINE
- FUEL SYSTEMS
- LUBES
- TOOLS
- TRAILER
- MERCH.
- CROSS REFERENCE
- INDEX

2030-0310



LAYDOWN LICENSE KIT YAMAHA CRUISER MODELS

- Super-cool chrome laydown license kit eliminates the ugly stock license assembly
- Lays license down to match fender angle
- Hidden fasteners provide a seamless, custom look
- Beautifully chromed billet aluminum mount, backing plate and frame
- Allows use of custom turn indicators and mounts (sold separately)
- Hardware and easy to follow do-it-yourself instructions are included

NOTE: Some state license plates may require minor trimming to fit inside license plate frame. **SUG. RETAIL.....\$175.95**

FITS MODEL	PART #
YAMAHA	
XVS650A V-Star classic 98-08	2030-0310
XVS1100A V-Star Classic 99-08	2030-0310
XVZ1300A Royal Star 96-01	2030-0310
XVZ1300CT Royal Star Tour Deluxe 05-08	2030-0310
XVZ1300TF Royal Star Venture 99-08	2030-0310
XV1600 Road Star 99-03	2030-0310



CURVED LICENSE KIT

YAMAHA XV1900 ROADLINER/STRATOLINER 06-08

- Beautifully chromed curved license assembly replaces the stock stand-up license mount
- Shaped to contour and blend with your fender
- Appears to float on air as the hidden hardware design provides seamless mounting
- Unique backing plate allows for super-quick and easy installation in minutes
- Mounting position provides perfect alignment for illumination by your stock taillight
- Kit is complete with hardware and mounting instructions

SUG. RETAIL.....\$144.95 PART # **2030-0313**

450

2030-0312



LAYDOWN LICENSE KIT KAWASAKI VULCAN MODELS

- Super-cool chrome laydown license kit eliminates the ugly stock license assembly
- Lays license down to match fender angle
- Hidden fasteners provide a seamless, custom look
- Beautifully chromed billet aluminum mount, backing plate and frame
- Allows use of custom turn indicators and mounts (sold separately)
- Hardware and easy to follow do-it-yourself instructions are included

NOTE: Some state license plates may require minor trimming to fit inside license plate frame. **SUG. RETAIL.....\$175.95**

FITS MODEL	PART #
KAWASAKI	
VN1500 Vulcan Drifter/Nomad 99-05	2030-0312
VN2000A Vulcan 04-08	2030-0312



WARRIOR STEALTH LED LICENSE MOUNT KIT

FOR YAMAHA XV1700PC ROAD STAR WARRIOR 02-08

- Rids your bike of the huge, plastic stock sub fender and license assembly
- Cleans up and streamlines the rear of your Warrior
- Beautifully chromed license frame has built-in LED lighting for plate illumination
- Custom mounting bracket re-angles the license plate for a better appearance while acting as a splatter shield
- Uses stock brake light
- Integrated mounts allow you to use stock turn signals or your choice of custom marker lights
- All hardware and do-it-yourself instructions are included

SUG. RETAIL.....\$133.95 PART # **2030-0321**



**M109
STEALTH
LICENSE KIT
FOR SUZUKI M109R
BOULEVARD 06-08**

- Gets rid of the large, unattractive sub-fender and huge license assembly
- Integrated one-piece hidden mounting platform places your license on a sweeping angle
- Exposes more of your fat rear tire to give your bike an aggressive look
- Sculpted chrome license frame with integrated dynamic LED lighting included
- Recessed turn signal mounts allow use of custom indicator lights or stock turn signals
- All hardware and do-it-yourself instructions are included for easy installation

SUG. RETAIL.....\$123.95 **PART #** 2030-0314



2030-0311

**VTX
LAYDOWN
LICENSE
PLATE KIT**

- Beautifully chromed billet assembly replaces the stock stand-up license mount
- Lays license plate down to profile the fender angle
- Hidden fasteners provide a seamless custom look
- Allows use of custom turn indicators and mounts (sold separately)
- Chrome backing plate, chrome frame and mounting hardware included

NOTE: Some state license plates may need trimming to fit.

SUG. RETAIL.....\$123.95

FITS MODEL	PART #
HONDA	
VTX1300 Retro 05-08	2030-0311
VTX1800R 03-07	2030-0311
VTX1800S 02-07	2030-0311



**"POPSICLE"
FOOTPEGS
WITH O-RINGS**

- Die-cast, diamond-shaped and highlighted by a black paint outline
- Mount to any 1" diameter engine guard or frame and come complete with a three-piece tube clamp for easy mounting
- Unique design won't "pinch" the ankle like a round peg might
- Come complete with necessary O-rings; replacement rings available separately
- Sold in pairs

DESCRIPTION	PART #	SUG. RETAIL
Footpegs	DS-253800	\$54.95
Repl. O-rings (10-pk.)	DS-253019	1.95 (ea.)



FOOTPEGS WITH RUBBER INLAY

- Fold-up design with a chrome finish
- Available in bolt-on or U-clamp style
- Sold in pairs

SUG. RETAIL.....\$19.95

DESCRIPTION	PART #
Bolt-on (5/16" mount bolts)	1904-6452
U-clamp (fits 1"-1 1/4" tube)	1904-1764

**CUSTOM
FOOTPEGS**

- Drag Specialties offers custom footpegs with two mount styles
- Clamp mount includes chromed 1" and 1 1/4" steel clamps; designed for clamping pegs to frames or safety bars
- Stud mount includes chromed 5/8" square steel block with 3/8"-24 thread for custom frame tab mounting

SUG. RETAIL.....\$27.95

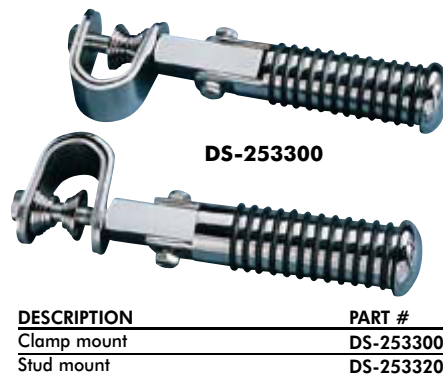

DESCRIPTION	PART #
Clamp mount	DS-253300
Stud mount	DS-253320



DS-253320

All part numbers in **BOLD MAGENTA** are new this year.

- EXHAUST
- TIRES & ACCESSORIES
- LUGGAGE
- SPORTBIKE ACCESSORIES
- CRUISER ACCESSORIES**
- TOURING ACCESSORIES
- SECURITY & AUDIO
- GENERAL ACCESSORIES
- FAIRINGS & BODY
- SEATS
- HANDLEBARS & CONTROLS
- LIGHTING
- ELECTRICAL
- SOCKETS
- CHAINS
- BRAKES
- SUSPENSION
- ENGINE
- FUEL SYSTEMS
- LUBES
- TOOLS
- TRAILER
- MERCH.
- CROSS REFERENCE
- INDEX



CHROME UNIVERSAL MOUNTS FOR 1"-DIAMETER TUBING

- Chrome mounts with universal fitment may be used to mount driving lights, footpegs and many other types of accessories
- Sold in pairs



SUG. RETAIL.....\$29.95 PART # DS-720218



BRAKE LIGHT BANJO BOLT COVER

- Chrome billet aluminum
- Designed to fit over most banjo bolts with built-in brake light switch
- Sold each



SUG. RETAIL.....\$9.95 PART # 1742-0041



0713-0053

0713-0018



OIL COOLER KIT

- Billet aluminum oil cooler is chrome plated and features cooling louvers in tube body
 - Available with or without oil temperature gauge
- NOTE: Will not fit with highway bars.

FITS MODEL	DESCRIPTION	PART #	SUG. RETAIL
YAMAHA			
For Road Star 99-04 and Road Star Warrior 02-04	Cooler kit w/ temperature gauge	0713-0053	\$442.95
	Cooler kit w/o gauge	0713-0018	384.95



LOWER TRIPLE CLAMP COVER FOR YAMAHA ROAD STAR MODELS

- Available with recessed turn signals
- Custom headlight required; available separately
- Turn signals must be removed

DESCRIPTION	PART #	SUG. RETAIL
Lower triple clamp cover w/ turn signals	DS280299	\$210.95
Repl. bulb and socket	DS-280282	5.95



DS-310214

CHROME BILLET OIL FILTER COVER

- Covers the stock Honda oil filter
- Available in smooth or ball-milled style

SUG. RETAIL.....\$55.95

FITS MODEL	DESCRIPTION	PART #
HONDA		
For VF750C Magna 88-03, Valkyrie	Ball-milled	DS-310214
GL1500C 97-00	Smooth	DS-310216

DS-325717

DS-325718

CHROME BILLET CARBURETOR COVER

FOR HONDA 750 SHADOW ACE 98-03

- Hides the carb and fills in the gap on the left side of the engine
- Available in smooth or ball-milled style

SUG. RETAIL.....\$55.95



DESCRIPTION	PART #
Smooth	DS-325717
Ball-milled	DS-325718



DS272401



DS272402

HORN COVERS

- Dress up Yamaha Road Star black plastic horns
- Covers fit snugly over front and rear horn for custom look
- Available in smooth or ball-milled style
- Sold in pairs

SUG. RETAIL.....\$132.95

DESCRIPTION	PART #
Smooth	DS272401
Ball-milled	DS272402

CHROME BELT GUARD

FOR YAMAHA ROAD STAR 99-07

- Chrome-plated aluminum belt guard
- Easy installation; does not require removal of tire

SUG. RETAIL.....\$212.95

PART # 1202-0001



All part numbers in **BOLD MAGENTA** are new this year.



1624-0093



0505-0284



1624-0147



0505-0281



1624-0148

HIGHWAY BARS

- Chrome steel-tube highway bars
- Accommodate 1 1/4" clamps for mounting pegs
- Mount to existing holes in frame



DESCRIPTION	PART #	SUG. RETAIL
HONDA		
VT750C Shadow Aero 04-07	1624-0093	\$232.95
VT1100 Shadow Sabre 00-08	1624-0135	232.95
VTX1300R/S/N 03-08	0505-0284	232.95
VTX1800R/S/N 02-07	1624-0158	232.95
KAWASAKI		
VN900 Vulcan 06-08	1624-0147	232.95
SUZUKI		
VL800 Intruder Volusia 01-04, C50/M50 Boulevard 05-09	1624-0106	196.95
YAMAHA		
XVS650/A V-Star Custom/Classic 98-08	0505-0281	161.95
XVS1300 V-Star 07-08	1624-0148	232.95



1621-0017



VANTAGE HIGHWAY BOARDS



- Stylish and functional highway boards constructed of durable CNC-machined aluminum with a brilliant chrome finish
- Sold in pairs

SUG. RETAIL.....**\$277.95**

FITS MODEL	POS.	PART #
HONDA		
VTX1300 04-07	Passenger	1621-0118
VTX1800 02-04	Passenger	1621-0117
VTX1800 05-07	Passenger	1621-0118
KAWASAKI		
VN900 Vulcan 06-08	Rider	1621-0117
VN1500 Vulcan 96-04	Rider	1621-0117
VN2000 04-07	Rider	1621-0117
SUZUKI		
VL800 Intruder Volusia 01-04	Passenger	1621-0118
C50 Boulevard 06-08	Passenger	1621-0118
YAMAHA		
XVS1100 V-Star Custom/Classic 99-07	Rider	1621-0118
XVS1300 V-Star 07	Passenger	1621-0118



1624-0144

PAC-A-DERMS™

- Front engine guard covers block wind and water spray
- One convenient, built-in storage pouch on each side with braided, corded edges and concho trim
- Mount easily with corrosion-resistant snaps
- Designed for use with Show Chrome highway bars



FITS MODEL	USE WITH SHOW CHROME HIGHWAY BAR PART #	PART #	SUG. RETAIL
HONDA			
VT750 Shadow Aero 04-08	1624-0093	1624-0143	\$117.95
VTX1800 02-08	1624-0158	3509-0001	111.95
KAWASAKI			
VN900 Vulcan 06-08	1624-0147	1624-0144	117.95
SUZUKI			
VL800 Intruder Volusia 01-04, C50/M50 Boulevard 05-09	1624-0106	1624-0146	117.95

HIGHWAY CLAMPS WITH RAIL PEG



- Billet aluminum clamps attach to highway bars
- Rail peg has pivot for folding back when not in use
- For use with 1 1/4" highway bars/engine guards
- Sold in pairs

SUG. RETAIL.....**\$149.95**

PART # 1624-0105

HIGHWAY FLOORBOARDS FOR CRUISERS

- Folding highway boards with a variety of different mounts
- More comfort due to ability to change position of feet
- Offsets allow adjustment up, down, forward and back
- Stepped offset moves highway board out about 1"
- Sold in pairs

SUG. RETAIL.....**\$301.95**

DESCRIPTION	PART #
Highway boards w/ 1" case guard mount (straight offset extension)	DS253439
Highway boards w/ 1" case guard mount (stepped offset extension)	DS253440



DS253439

DS253440

All part numbers in **BOLD MAGENTA** are new this year.

- EXHAUST
- TIRES & ACCESSORIES
- LUGGAGE
- SPORTBIKE ACCESSORIES
- CRUISER ACCESSORIES
- TOURING ACCESSORIES
- SECURITY & AUDIO
- GENERAL ACCESSORIES
- FAIRINGS & BODY
- SEATS
- HANDLEBARS & CONTROLS
- LIGHTING
- ELECTRICAL
- SPROCKETS
- CHAINS
- BRAKES
- SUSPENSION
- ENGINE
- FUEL SYSTEMS
- LUBES
- TOOLS
- TRAILER
- MERCH.
- CROSS REFERENCE
- INDEX



- EXHAUST
- TIRES & ACCESSORIES
- LUGGAGE
- SPORTBIKE ACCESSORIES
- CRUISER ACCESSORIES**
- TOURING ACCESSORIES
- SECURITY & AUDIO
- GENERAL ACCESSORIES
- FAIRINGS & BODY
- SEATS
- HANDLEBARS & CONTROLS
- LIGHTING
- ELECTRICAL
- SPROCKETS
- CHAINS
- BRAKES
- SUSPENSION
- ENGINE
- FUEL SYSTEMS
- LUBES
- TOOLS
- TRAILER
- MERCH.
- CROSS REFERENCE
- INDEX



DS253441



DS253443

PASSENGER FLOORBOARD SETS

- Both rider and passenger floorboards for a variety of applications
- High-quality chrome boards with rubber inserts
- Available with either frame clamps or model-specific mounting hardware
- Boards can rotate on mounting hardware for personalized installation
- Sold in pairs

DESCRIPTION	PART #	SUG. RETAIL
Universal passenger boards w/ 1" frame clamps	DS253441	\$198.95
Universal passenger boards w/ 1 1/4" frame clamps	DS253443	198.95

CRUISE BOARD PASSENGER SYSTEM

- High-quality boards are cast construction with chrome finish
- Inset, heavy-duty rubber pads
- Boards can rotate on mounting hardware for personalized set-up
- Mounting hardware included
- Sold in pairs

SUG. RETAIL..... **\$198.95**



1621-0047

FITS MODEL	PART #
HONDA	
VT600 Shadow VLX 88-99	1621-0048
VF750 Magna 88-03	1621-0048
VT750 ACE 98-99 (all)	1621-0043
VT750DC Shadow Spirit 01-03, 05-07	1621-0047
VT1100 Shadow ACE/Aero 98-06	1621-0044
VT1100 Shadow Sabre/Spirit 97-07	1621-0043
VTX1800C 02-07	1621-0044
YAMAHA	
XVS650/1100 V-Star 98-07 (all)	1621-0047
XV1600/1700 Road Star 99-07	1621-0047

DRIVER MINI BOARDS

- Chrome finish with rubber inserts
- Sold in pairs

SUG. RETAIL..... **\$117.95**



FITS MODEL	PART #
HONDA	
VTX1300C 04-06, VTX1800R 02-07	1621-0045
KAWASAKI	
VN900 Vulcan 06-08	1621-0109
SUZUKI	
C50 Boulevard 05-08	1621-0110
VL800 Intruder Volusia 01-04	1621-0045

RAIL



DIAMOND



TEARDROP



EDGE



FLAME

SLIDER OEM MOUNT PEGS

- Six styles of elliptical footpegs for most cruisers
- Elliptical profile features more foot support area for greater comfort
- Feature highly polished chrome with decorative rubber inserts
- Pegs rotate on mounting studs for infinite adjustment
- Mount directly to OEM mounting points
- Sold in pairs

U.S. Patent #6.161.859.

SUG. RETAIL..... **\$117.95**

FITS MODEL	POSITION	RAIL	DIAMOND	TEARDROP	EDGE	FLAME
HONDA						
VT600C Shadow VLX 88-03	Driver	DS253417	DS253418	DS253419	DS253421	DS253422
VF750C Magna 84-03	Driver	DS253423	-	-	-	DS253428
VT750C Shadow ACE 98-99	Driver/passenger	DS253417	DS253418	DS253419	DS253421	DS253422
VT750C Shadow ACE 00-03	Driver	DS253423	-	-	-	DS253428
VT750DC Shadow Spirit 01-03	Driver	DS253423	-	-	-	DS253428
VT1100 Shadow 87-96	Driver/passenger	DS253417	DS253418	DS253419	DS253421	DS253422
VT1100C1 Shadow Spirit 97-04	Driver/passenger	DS253417	DS253418	DS253419	DS253421	DS253422
VT1100C2 Shadow ACE 95-99	Driver	DS253423	-	-	-	DS253428
VT1100C2 Shadow Sabre 00-04	Driver/passenger	DS253417	DS253418	DS253419	DS253421	DS253422
VT1100CT Shadow ACE Tourer 98-02	Driver	DS253423	-	-	-	DS253428
GL1500 Valkyrie 97-02 (all)	Driver	DS253423	-	-	-	DS253428
VTX1800C 02-06	Driver	DS253423	-	-	-	DS253428
KAWASAKI						
VN900 Vulcan 06-08	Passenger	1620-0445	-	-	-	-
YAMAHA						
XVS650 V-Star Classic/Custom 99-08	Driver	DS253417	DS253418	DS253419	DS253421	DS253422
XVS1100 V-Star Custom 99-06	Driver	DS253417	DS253418	DS253419	DS253421	DS253422



SHIFTER PEG COVER

- Chrome-plated, die-cast shifter peg cover with rubber inserts
- Secures with setscrews
- Fits 7/8" round shifter peg

SUG. RETAIL.....**\$43.95**

FITS MODEL	PART #
HONDA	
VT750C/DC ACE/Spirit 98-06, VT1100 Shadow 85-07 (all)	1602-0079
SUZUKI	
VL800 Intruder Volusia 01-04	1602-0079



SLIDER BRAKE PEDALS FOR CRUISERS

- The perfect complement to Slider pegs – same great features, same great designs
- Bolt directly to OEM rear brake pedal

U.S. Patent #6.161.859.



FITS MODEL	RAIL	FLAME	SUG. RETAIL
HONDA			
VT600C Shadow VLX 88-06	DS253455	DS253460	\$53.95
VF750C Magna 94-03	DS253455	DS253460	53.95
VT1100 Shadow 87-06 (all)	DS253455	DS253460	53.95
GL1500C Valkyrie 97-02	DS253455	DS253460	53.95
YAMAHA			
XVS1100 V-Star Custom 99-06	DS253455	DS253460	53.95
XVS1100A V-Star Classic 00-07	DS253468	DS253466	62.95
XVZ1300 Royal Star 96-07	DS253468	DS253466	62.95
XV1600 Road Star 99-07	DS253468	DS253466	62.95



0410-0061



0410-0060



0410-0087



0410-0063



0410-0058



0410-0082



0410-0057

BULLET FORK COVERS

- Dress up fork bottoms with these polished, die-cast chrome covers
- Mount easily with included set screws

SUG. RETAIL.....**\$183.95**

FITS MODEL	PART #
HONDA	
VT750 Shadow Aero 04-08	0412-0165
VTX1300R/S 03-07	
SUZUKI	
VL800 Intruder Volusia 01-04	
VN900 06-08	
C50 05-08	
YAMAHA	
XVZ1300 Royal Star 96-04	
XV1600/1700 Roadstar 99-07	
XVS1100 V-Star 99-08	



NECK COVERS

- ABS chrome covers replace black OEM covers
- Mounts using existing hardware
- Sold in pairs

SUG. RETAIL.....**\$86.95**

FITS MODEL	PART #
HONDA	
VT750C Shadow Aero 04-08	0410-0061
VT750C Shadow ACE 98-00	0410-0060
VT1100 Shadow ACE/Aero/Sabre/Tourer 95-08	0410-0087
VTX1300R/S/C 03-07	0410-0063
KAWASAKI	
VN900 Vulcan 06-08	1731-0126
VN1600 Classic/Nomad 03-08	0410-0088
SUZUKI	
C50/M50 Boulevard 05-08	0410-0058
VL800 Intruder Volusia 01-04	0410-0058
C90 Boulevard 05-08	0504-0082
VL1500 Intruder 98-04	0504-0082
YAMAHA	
XVS650 V-Star 98-08	DS110960
XVS1100/A Custom/Classic 99-08	0410-0057

TRIPLE TREE ACCENTS

- Steel triple tree accents deliver a finished look; perfectly cover OEM brushed aluminum for a cast appearance
- Attach with double-sided tape

SUG. RETAIL.....**\$76.95**

FITS MODEL	PART #
HONDA	
VT750 Shadow ACE 98-03 (all)	0409-0009
VT750 Shadow Aero 04-08 (all)	0409-0008
VTX1300R/S 03-08	0409-0011
VTX1800R/S 02-08	0409-0010



0409-0009



0409-0008



0409-0011



0409-0010

All part numbers in **BOLD MAGENTA** are new this year.

- EXHAUST
- TIRES & ACCESSORIES
- LUGGAGE
- SPORTBIKE ACCESSORIES
- CRUISER ACCESSORIES
- TOURING ACCESSORIES
- SECURITY & AUDIO
- GENERAL ACCESSORIES
- FAIRINGS & BODY
- SEATS
- HANDLEBARS & CONTROLS
- LIGHTING
- ELECTRICAL
- SPROCKETS
- CHAINS
- BRAKES
- SUSPENSION
- ENGINE
- FUEL SYSTEMS
- LUBES
- TOOLS
- TRAILER
- MERCH.
- CROSS REFERENCE
- INDEX



EXHAUST

TIRES & ACCESSORIES

LUGGAGE

SPORTBIKE ACCESSORIES

CRUISER ACCESSORIES

TOURING ACCESSORIES

SECURITY & AUDIO

GENERAL ACCESSORIES

FAIRINGS & BODY

SEATS

HANDLEBARS & CONTROLS

LIGHTING

ELECTRICAL

SPROCKETS

CHAIN

BRAKES

SUSPENSION

ENGINE

FUEL SYSTEMS

LUBES

TOOLS

TRAILER

MERCH.

CROSS REFERENCE

INDEX



DS393643



DS393644



DS393641

FENDER EXTENSIONS

- Dress up front and rear fenders with these chromed extensions
- Help reduce amount of water spray in wet conditions
- Sold each



DS393642

FITS MODEL	LOCATION	PART #	SUG. RETAIL
HONDA			
VT750C Shadow ACE 98-03	Front	DS393643	\$86.95
	Rear	DS393644	86.95
VT1100C2 Sabre 00-07	Front	DS393643	86.95
	Rear	DS393644	86.95
GL1500C Valkyrie 97-02	Front	DS393641	76.95
	Rear	DS393642	86.95

1405-0107



1405-0021



1405-0108

FRONT FENDER RAILS

- Protect and complement cruiser front fenders
- Tubular chrome steel
- Easy to mount



FITS MODEL	PART #	SUG. RETAIL
HONDA		
VT750 Shadow ACE 98-03	1405-0013	\$86.95
VT750 Shadow Aero 04-08	1405-0014	86.95
VT1100 Shadow Sabre 00-08	1405-0097	86.95
VTX1300R 05-08	1405-0022	86.95
VTX1800N/R/S 02-08	1405-0021	86.95
KAWASAKI		
VN900 Vulcan 06-08	1405-0090	86.95
VN2000 Vulcan 04-08	1405-0089	86.95
SUZUKI		
C50 Boulevard 05-08	1405-0087	86.95
VL800 Intruder Volusia 01-04	1405-0087	86.95
YAMAHA		
XVS650A V-Star Classic 98-08	1405-0107	86.95
XVS1100A V-Star Classic 98-06	1405-0107	86.95
XVS1300 V-Star 07-08	1405-0108	86.95
XV1600/1700 Road Star 99-07	DS719965	76.95

REAR FENDER RAIL

- Protects and complements cruiser rear fenders
- Tubular chrome steel
- Easy to mount



SUG. RETAIL.... \$86.95

FITS MODEL	PART #
SUZUKI	
C50 Boulevard 05-08	1405-0088
VL800 Intruder Volusia 01-04	1405-0088

V-TWIN HORN COVER

- Fits models listed and all other 3 1/4" round horns

FITS MODEL	PART #	SUG. RETAIL
Yamaha		
XVS650/1100		
V-Star Custom		
Classic 98-07	2107-0015	\$14.95



FORK STEM COVERS

- Chrome fork stem covers deliver a finishing touch
- Available in blunt or domed design
- Sold each



FITS MODEL	DESIGN	PART #	SUG. RETAIL
Honda VT600C Shadow VLX 88-04, VF750C Magna 99-03, VT750C/D Shadow ACE 98-03 (all), VT1100C Shadow 87-04 (all), VTX1300R/S 03-08, GL1500C/D/F Valkyrie 97-03 and VTX1800R/S 02-08	Blunt	0410-0059	\$35.95
	Domed	0410-0062	35.95

LICENSE PLATE HOLDER MOUNT

- Die-cast chrome construction; replaces OEM bracket
- Holds any size license plate
- Mounts with existing screws



FITS MODEL	PART #	SUG. RETAIL
Honda VTX1300/1800R 02-08	2030-0142	\$35.95

CHROME FLAME ACCENTS

- Steel accents give style to your ride
- Mount to any flat surface with double-sided tape (included)
- Available in 1" x 3" and 1 3/4" x 6" sizes
- Sold in pairs



SIZE	PART #	SUG. RETAIL
3"	DS719869	\$22.95
6"	DS719870	43.95



FORK CAP COVERS

- Billet aluminum fork cap covers
- Available with blunt or domed design
- Sold in pairs

SUG. RETAIL..... **\$59.95**

FITS MODEL	DESIGN	PART #
HONDA		
VT750C/DC Shadow ACE/Aero/Spirit 00-07	Domed	0412-0064
	Blunt	0412-0066
VTX1300R/S 03-08	Domed	0412-0065
GL1500C/CF Valkyrie/Valkyrie Interstate 97-02	Blunt	DS-720720
SUZUKI		
VL800 Intruder Volusia 01-03	Domed	0412-0118
C50/C90 Boulevard 05-08	Domed	0412-0117



FITS MODEL	DESIGN	PART #
YAMAHA		
XVS650/1100/1300 V-Star 98-07	Domed	0412-0117
	Blunt	0412-0066
XV1600/1700 Road Star 99-07	Domed	0412-0117
	Blunt	0412-0066

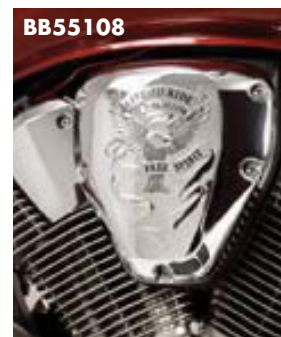
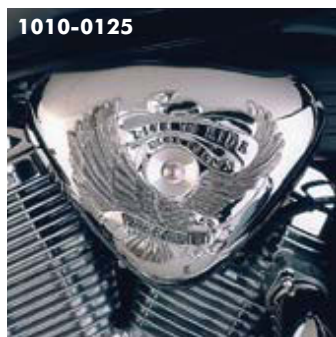

AIR CLEANER COVERS

- High-quality chrome finish
- Replace the OEM cover
- Free Spirit and Eagle Head designs

SUG. RETAIL..... **\$108.95**

FITS MODEL	STYLE	PART #
HONDA		
VT600 Shadow VLX 99-08	Free Spirit	1010-0125
VT750C Shadow ACE 98-03	Free Spirit	DS720732
VT750 Shadow Aero 04-08	Free Spirit	1010-0124
VT750DC Shadow Spirit 01-03, 05-08	Free Spirit	1010-0123
VTX1300R/S 03-06	Free Spirit	BB55108
VTX1800C/R 02-07	Free Spirit	BB55108
KAWASAKI		
VN900 Vulcan 06-08	Free Spirit	1014-0036
VN1500J/R Vulcan Drifter 99-05	Free Spirit	1014-0014
VN1500L Vulcan Nomad Fi 00-04	Free Spirit	1014-0014
VN1500P Vulcan Mean Streak 02-03	Free Spirit	1014-0014
VN1600 Vulcan Mean Streak 04-08	Free Spirit	1014-0014
VN2000 Vulcan 04-08	Free Spirit	1014-0032



FITS MODEL	STYLE	PART #
SUZUKI		
M50 Boulevard 05-08	Free Spirit	1014-0033
C50 Boulevard 05-08	Free Spirit	1014-0015
VL800 Intruder Volusia 01-04	Free Spirit	1014-0015
M95 Boulevard 05-06	Free Spirit	1014-0014
VZ1600 Marauder 04	Free Spirit	1014-0014
YAMAHA		
XVS650 V-Star 98-03 (all)	Eagle Head	DS-720705
	Free Spirit	DS-720706
XVS1100 V-Star 99-06 (all)	Free Spirit	DS720736
XVS1300 V-Star 07-08	Free Spirit	1014-0038
XV1600 Road Star 99-03 (all)	Free Spirit	DS720746



GAS TANK TOP COVER

- High-quality chrome finish
- Replaces the stock black plastic cover

FITS MODEL	PART #	SUG. RETAIL
Yamaha XV1300 Royal Star Venture 99-08	DS391298	\$47.95



GAS TANK MOUNT TRIM

- Attaches to existing gas tank mount
- Ribbed design and chrome finish accent a normally unattractive area

FITS MODEL	DESCRIPTION	PART #	SUG. RETAIL
HONDA			
GL1500C/CF Valkyrie/Valkyrie Interstate	Complete tank accent set	DS391295	\$76.95
VT1100 Shadow, GL1500C/CF Valkyrie/Valkyrie Interstate	Tank base mount trim only	DS391299	35.95

All part numbers in **BOLD MAGENTA** are new this year.

- EXHAUST
- TIRES & ACCESSORIES
- LUGGAGE
- SPORTBIKE ACCESSORIES
- CRUISER ACCESSORIES
- TOURING ACCESSORIES
- SECURITY & AUDIO
- GENERAL ACCESSORIES
- FAIRINGS & BODY
- SEATS
- HANDLEBARS & CONTROLS
- LIGHTING
- ELECTRICAL
- SPROCKETS
- CHAINS
- BRAKES
- SUSPENSION
- ENGINE
- FUEL SYSTEMS
- LUBES
- TOOLS
- TRAILER
- MERCH.
- CROSS REFERENCE
- INDEX



- EXHAUST
- TIRES & ACCESSORIES
- LUGGAGE
- SPORTBIKE ACCESSORIES
- CRUISER ACCESSORIES**
- TOURING ACCESSORIES
- SECURITY & AUDIO
- GENERAL ACCESSORIES
- FAIRINGS & BODY
- SEATS
- HANDLEBARS & CONTROLS
- LIGHTING
- ELECTRICAL
- SPROCKETS
- CHAINS
- BRAKES
- SUSPENSION
- ENGINE
- FUEL SYSTEMS
- LUBES
- TOOLS
- TRAILER
- MERCH.
- CROSS REFERENCE
- INDEX

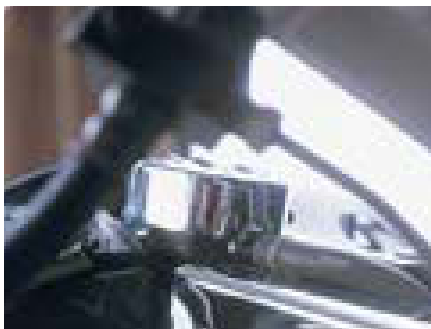

RADIATOR TOP COVER

- Chrome-plated steel cover fits over OEM radiator

FITS MODEL	PART #	SUG. RETAIL
Honda GL1500C/CF Valkyrie/ Valkyrie Interstate 97-02	DS720740	\$43.95



CHROME RADIATOR CAP COVER

- Chrome cover dresses up top of radiator
- Fits over OEM radiator cap

FITS MODEL	PART #	SUG. RETAIL
Honda GL1500C/CF Valkyrie/ Valkyrie Interstate 97-02	DS-719948	\$16.95



COOLANT OVERFLOW COVER

- Mounts to existing rubber cap
- Sold each

FITS MODEL	PART #	SUG. RETAIL
Honda VT750 Shadow ACE/ Spirit 98-07	1904-0037	\$16.95



DS720738



1904-0041



DS720737



1904-0045



DS-720710



1904-0070



1904-0071



1904-0032



1904-0036



1904-0033



1904-0067



1904-0068



DS720745

RADIATOR GRILLES

- Four styles to choose from: chromed mesh screen, Eagle, Celestar or V-Style
- All are high-quality chrome steel
- Replace the stock OEM plastic covers
- Sold each

FITS MODEL	STYLE	PART #	SUG. RETAIL
HONDA			
VT600C Shadow VLX 88-08	Mesh	DS-720723	\$155.95
	Eagle	DS720743	155.95
	V-Style	1904-0042	164.95
VT750C Shadow ACE/Spirit 98-08 (except VT750C2 Shadow Spirit)	Mesh	DS-720725	155.95
	Eagle	DS720738	155.95
	V-Style	1904-0039	164.95
VT750 Shadow Aero 04-08	V-Style	1904-0041	164.95
	Mesh	1904-0040	161.95
VT1100 Shadow 87-06 (all)	Mesh	DS-720722	155.95
	Eagle	DS720737	155.95
VT1100 Shadow ACE/Aero/ Sabre/Spirit 95-08	V-Style	1904-0038	164.95
VTX1300R/S/C 03-07	Mesh	1904-0045	161.95
	V-Style	1904-0046	164.95
GL1500C/CF Valkyrie/ Valkyrie Interstate 97-02	Mesh	DS-720710	43.95
VTX1800 02-08	Mesh	1904-0070	161.95
	Celestar	1904-0071	173.95
KAWASAKI			
VN800A/B Vulcan/Vulcan Classic 95-03	Mesh	DS-719690	155.95

FITS MODEL	STYLE	PART #	SUG. RETAIL
KAWASAKI (CONT)			
VN900 Vulcan 06-08	Mesh	1904-0054	\$161.95
	Celestar	1904-0055	173.95
VN1500/1600 Vulcan Mean Streak 02-08	Mesh	1904-0032	161.95
VN2000 Vulcan 04-08	Mesh	1904-0048	161.95
	V-Style	1904-0049	164.95
SUZUKI			
C50/M50 Boulevard 05-08	Celestar	1904-0036	173.95
	V-Style	1904-0035	164.95
	Mesh	1904-0069	161.95
VL800 Intruder Volusia 01-04	Celestar	1904-0036	173.95
	V-Style	1904-0035	164.95
	Mesh	1904-0069	161.95
VS800 Intruder 92-03	Mesh	DS-719691	155.95
VZ1600 Marauder 04	Mesh	1904-0032	161.95
	Celestar	1904-0033	173.95
M95 Boulevard 05	Celestar	1904-0033	173.95
YAMAHA			
XVST1300 V-Star 07-08	Mesh	1904-0067	161.95
	Celestar	1904-0068	173.95
XVZ1300 Royal Star Venture 99-04	Celestar	DS720745	155.95



FUEL SHUT OFF PLATE COVER AND KNOB

- Stamped steel cover hides fuel shut-off valve assembly; knob sold separately
- Cover and knob sold each



FITS MODEL	DESCRIPTION	PART #	SUG. RETAIL
HONDA			
VT750 Shadow ACE 98-03, VT1100 Shadow 85-06 (all) and VTX1300R/S 03-07	Cover	0705-0026	\$28.95
VT750/1100 Shadow, VTX1300C/R 98-07 (all except Aero models)	Knob	0705-0025	10.95

CHOKE KNOB COVER

- Simple, easy-to-install accent is worth ten times its weight in looks



FITS MODEL	PART #	SUG. RETAIL
HONDA		
VT600C Shadow VLX 88-04, VF750 Magna 94-01, VT750 Shadow 98-03 (all), VT1100 Shadow 85-06 (all), VTX1300R 05-07	BB-63-124	\$32.95
YAMAHA		
XVS650 and XVS1100 V-Stars 98-07, XVZ1300 Royal Star Venture 98-04 and XV1600 Road Star 99-03	BB-63-124	



OIL FILLER CAPS

- Chrome-plated caps replace the black OEM caps
- Use OEM O-ring
- Sold each

SUG. RETAIL..... \$19.95

FITS MODEL	PART #	SUG. RETAIL
HONDA		
VT1100 87-03 (all)	DS310219	
GL1500C Valkyrie 97-02 (all)	DS-310212	
SUZUKI		
VL800 Intruder Volusia 01-04	0521-0211	
YAMAHA		
XVS650/1100 V-Star 98-07 (all)	0521-0205	
XVZ1300 Royal Star/Royal Star Venture 99-08	DS310221	



OIL DIPSTICK WITH CAP

- Chrome dipstick with cap
- Replaces OEM plastic cap and dipstick
- Uses existing OEM O-ring

SUG. RETAIL..... \$32.95

FITS MODEL	PART #	SUG. RETAIL
HONDA		
VT600C Shadow VLX 88-07	DS-720704	
VT750 Shadow Aero 04-08	0710-0025	
VT750C Shadow ACE 98-03	DS-720731	
VT1100 Shadow 95-04 (all except Aero, Sabre)	DS310220	
VTX1300R/S 03-08	0710-0026	
GL1500C Valkyrie 97-02 (all)	DS-310211	
VTX1800C/R 02-08	DS310200	

DRIVE SHAFT BOLT TRIM

- Offers a clean look by covering OEM black plate and bolts



FITS MODEL	PART #	SUG. RETAIL
HONDA		
Honda VT1100 Shadow Sabre/Spirit 99-07 and VTX1300/1800R/S 02-07	1205-0049	\$43.95



DRIVE SHAFT COVER

- Chrome stamped-steel construction
- Mounts with double-sided tape (included)

FITS MODEL	PART #	SUG. RETAIL
HONDA		
VT750C Shadow Aero 04-08, VT1100 Shadow 85-06 (all) and VTX1300/1800R/S 02-07	1303-0029	\$61.95
SUZUKI		
VL800 Intruder Volusia 01-04, C50/M50 Boulevard 05-08	1303-0085	70.95



DRIVE SHAFT BOLT COVERS

- CNC machined
- Sold in sets of four

FITS MODEL	PART #	SUG. RETAIL
Honda VT1100 Shadow 97-04 (all), VTX1300/1800R/S 02-07 and GL1500 Valkyrie 97-03 (all)	1205-0048	\$32.95

SWINGARM COVERS

- Chrome stamped-steel covers mask the black OEM swingarm
- Attach with double-sided tape (included)
- Sold in pairs



1303-0030



1303-0028



1703-0017



SWINGARM ACCENT TRIM

- Four-piece chrome-plated trim set
- Features the raised teardrop design
- Mounts with included double-adhesive tape

FITS MODEL	PART #	SUG. RETAIL
Honda VT750C Shadow ACE 98-03	DS110961	\$70.95

FITS MODEL	PART #	SUG. RETAIL
HONDA		
VT750C Shadow Aero 04-08	1303-0048 ¹	\$129.95
VTX1300C/R 05-08	1303-0030	146.95
GL1500C/CF Valkyrie/Valkyrie Interstate 97-03	DS190939	59.95
VTX1800N/R/S 02-08	1303-0028	146.95
KAWASAKI		
VN900 Vulcan 06-08	1303-0095	137.95
VN2000 Vulcan 04-08	1303-0057	140.95

FITS MODEL	PART #	SUG. RETAIL
SUZUKI		
VL800 Intruder Volusia 01-04	1703-0017	\$135.95
C50/M50 Boulevard 05-07	1703-0017	135.95
YAMAHA		
XVS650/1100 V-Star Custom Classic 04-07	1303-0056	117.95

¹ Sold each.

All part numbers in **BOLD MAGENTA** are new this year.

- EXHAUST
- TIRES & ACCESSORIES
- LUGGAGE
- SPORTBIKE ACCESSORIES
- CRUISER ACCESSORIES
- TOURING ACCESSORIES
- SECURITY & AUDIO
- GENERAL ACCESSORIES
- FAIRINGS & BODY
- SEATS
- HANDLEBARS & CONTROLS
- LIGHTING
- ELECTRICAL
- SPROCKETS
- CHAINS
- BRAKES
- SUSPENSION
- ENGINE
- FUEL SYSTEMS
- LUBES
- TOOLS
- TRAILER
- MERCH.
- CROSS REFERENCE
- INDEX

EXHAUST
TIRES & ACCESSORIES
LUGGAGE
SPORTBIKE ACCESSORIES
CRUISER ACCESSORIES
TOURING ACCESSORIES
SECURITY & AUDIO
GENERAL ACCESSORIES
FRAME & BODY
SEATS
HANDLEBARS & CONTROLS
LIGHTING
ELECTRICAL
SPROCKETS
CHAIN
BRAKES
SUSPENSION
ENGINE
FUEL SYSTEMS
LUBES
TOOLS
TRAILER
MERCH.
CROSS REFERENCE
INDEX

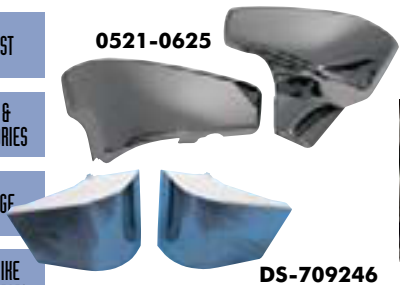

0521-0625

DS-709246

CHROME SIDE COVERS

- Chromed ABS covers to replace OEM plastic
- Sold in pairs



0521-0220



0521-0219



0521-0663



0521-0404



0521-0209

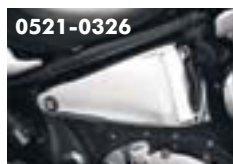

0521-0326



0521-0210



0521-0206

FITS MODEL	PART #	SUG. RETAIL
HONDA		
VT600 Shadow 99-08	0521-0625	\$135.95
VT750 Shadow ACE 98-03	DS-709246	173.95
VT750 Shadow Aero 04-08	0521-0220	135.95
VT1100C Shadow 98-99, VT1100 Shadow ACE 98-99, VT1100 Shadow Sabre 95-01	0521-0219	135.95
VTX1300C/R/S 03-08	0521-0663	135.95
VTX1800C 02-08	0521-0324	135.95
VTX1800F/N/R/S 02-08	0521-0222	135.95
KAWASAKI		
VN800 Vulcan 95-05	0521-0448	135.95

FITS MODEL	PART #	SUG. RETAIL
KAWASAKI (CONT)		
VN900 Vulcan 06-08	0521-0404	\$135.95
	0521-0405¹	35.95
VN1500D/G/L/N Vulcan Classic/Nomad/Nomad FI/ Classic FI 99-05	0521-0327	135.95
VN1500/1600 Vulcan Meanstreak 03-08	0521-0209	135.95
VN2000 Vulcan 04-08	0521-0326	135.95
SUZUKI		
C50/M50 Boulevard 05-08, VL800 Intruder Volusia 01-04	0521-0210	135.95

FITS MODEL	PART #	SUG. RETAIL
SUZUKI (CONT)		
M95 Boulevard 05, VZ1600 Marauder 04	0521-0209	\$135.95
YAMAHA		
XVS650/A V-Star Custom/ Classic 98-07	0521-0206	135.95
XVS1100 V-Star Classic 99-08	0521-0207	135.95
XVS1300 V-Star 07-08	0520-0616	135.95
XVZ1300 Royal Star 96-04	0521-0325	177.95

¹ Right-side lower side panel; sold each.

REGULATOR COVERS

- Chrome stamped-steel cover replaces OEM regulator cover
- Uses existing hardware and screw holes



DS-720728



0521-0208



BB62110

FITS MODEL	STYLE	PART #	SUG. RETAIL
HONDA			
VT600C Shadow VLX 88-03	Smooth	DS-720728	\$43.95
KAWASAKI			
VN900 Vulcan 06-08	Celestar	0521-0403	43.95
VN1500J/R Drifter 98-04	Celestar	0521-0208	86.95
VN1500P Vulcan Mean Streak 02-03	Celestar	0521-0208	86.95
VN1600B Vulcan Mean Streak 04-06	Celestar	0521-0208	86.95

FITS MODEL	STYLE	PART #	SUG. RETAIL
KAWASAKI (CONT)			
VN2000 Vulcan 04-08	-	0521-0402	\$53.95
SUZUKI			
VZ1600K Marauder 04	Celestar	0521-0208	86.95
YAMAHA			
XV1600 Road Star 99-03	Celestar	BB62110	38.95

MASTER CYLINDER COVERS

- Highly polished chrome master cylinder covers
- Features Raised Teardrop or Free Spirit design
- Replaces the OEM cover
- Sold each



1731-0164



DS373899

DS373898



1731-0163



FITS MODEL	DESIGN	PART #	SUG. RETAIL
HONDA			
VT600 88-04 (all)	Free Spirit	1731-0164	\$17.95 (ea.)
VT600C Shadow VLX 88-04	Raised Teardrop	DS373899	26.95 (ea.)
	Free Spirit	1731-0063	38.95 (pr.)
VF750 99-03 (all)	Free Spirit	1731-0164	17.95 (ea.)
VF750C Magna 94-03	Raised Teardrop	DS373899	26.95 (ea.)
	Free Spirit	1731-0063	38.95 (pr.)
VT750 99-07 (all)	Free Spirit	1731-0164	17.95 (ea.)
VT750C Shadow ACE 98-03	Raised Teardrop	DS373899	26.95 (ea.)
	Free Spirit	1731-0063	38.95 (pr.)
VT1100 Shadow 97-08 (all)	Free Spirit	1731-0164	17.95 (ea.)
VT1100 Shadow 96-07 (all)	Raised Teardrop	DS373899	26.95 (ea.)
	Free Spirit	1731-0063	38.95 (pr.)
VTX1300 02-08 (all)	Free Spirit	1731-0164	17.95 (ea.)
VTX1300R/S 03-07	Raised Teardrop	DS373899	26.95 (ea.)
	Free Spirit	1731-0063	38.95 (pr.)
Valkyrie and Valkyrie Interstate 97-02	Raised Teardrop	DS373898	53.95 (pr.)
VTX1800R/S 02-07	Raised Teardrop	DS373898	53.95 (pr.)
	Free Spirit	1731-0063	38.95 (pr.)
KAWASAKI			
VN900 Vulcan 06-08	Free Spirit	1731-0163	20.95 (ea.)

FITS MODEL	DESIGN	PART #	SUG. RETAIL
KAWASAKI (CONT)			
VN500/800/1500 Vulcan 85-06 (all)	Free Spirit	DS-720707	\$47.95 (pr.)
VN1500/1600P/B Vulcan Mean Streak 02-08	Free Spirit	1731-0163	20.95 (ea.)
VN1600A Vulcan Classic 03-08	Free Spirit	1731-0163	20.95 (ea.)
VN2000 Vulcan 04-08	Free Spirit	1731-0163	20.95 (ea.)
SUZUKI			
VL800 Intruder Volusia 01-04	Free Spirit	1731-0062	25.95 (ea.)
VS800/1400 Intruder 87-03	Free Spirit	DS-720708	47.95 (pr.)
C50/M50 Boulevard 05-07 (except C50 06-07)	Free Spirit	1731-0062	25.95 (ea.)
M95 Boulevard 05	Free Spirit	1731-0163	20.95 (ea.)
VZ1600 Marauder 04	Free Spirit	1731-0163	20.95 (ea.)
YAMAHA			
XVS650 V-Star 98-08	Free Spirit	1731-0162	26.95 (ea.)
XVS1100 V-Star 99-08	Free Spirit	1731-0162	26.95 (ea.)
XVZ1300 Royal Star Venture 99-07	Raised Teardrop	DS373898	53.95 (pr.)
	Free Spirit	1731-0063	38.95 (pr.)
XV1600 Road Star 99-07	Raised Teardrop	DS373899	26.95 (ea.)
	Free Spirit	1731-0063	38.95 (pr.)
XV1600/1700 99-08	Free Spirit	1731-0164	17.95 (ea.)



- EXHAUST
- TIRES & ACCESSORIES
- LUGGAGE
- SPORTBIKE ACCESSORIES
- CRUISER ACCESSORIES
- TOURING ACCESSORIES
- SECURITY & AUDIO
- GENERAL ACCESSORIES
- FAIRINGS & BODY
- SEATS
- HANDLEBARS & CONTROLS
- LIGHTING
- ELECTRICAL
- SPROCKETS
- CHAINS
- BRAKES
- SUSPENSION
- ENGINE
- FUEL SYSTEMS
- LUBES
- TOOLS
- TRAILER
- MERCH.
- CROSS REFERENCE
- INDEX

MASTER CYLINDER SWITCH BLOCK ASSEMBLY

- Houses three switches for auxiliary lighting controls
- Available with chrome or matte black finish



FITS MODEL	POSITION	FINISH	PART #	SUG. RETAIL
HONDA				
VT600 Shadow VLX 88-04, VF750 Magna 94-03 (all), VT750 Shadow 98-03 (all), VT1100 Shadow 96-07 (all), VTX1300/1800R/S 02-07, GL1500 Valkyrie 97-03	Clutch-side	Chrome	2106-0028	\$76.95
		Matte black	2106-0044	77.95
VT600 Shadow VLX 96-03, VT750C Shadow ACE 98-03, VT750DC Shadow Spirit 01-03, VT1100C1 Shadow Spirit 97-04, VT1100C2 Shadow ACE 95-99, VT1100C2 Shadow Sabre 00-04, VT1100C3 Shadow Aero 98-02, VTX1300R/S 03-07, GL1500C/CT Valkyrie/Valkyrie Tourer 97-02, VTX1800C/R 02-06	Brake-side	Chrome	BB-52-605	76.95
YAMAHA				
XVZ1300 Royal Star 96-97, XV1600/1700 Road Star 99-07	Clutch-side	Chrome	2106-0028	76.95
		Matte black	2106-0044	77.95
XVZ1300 Royal Star 99-04, XV1600 99-03	Brake-side	Chrome	BB-52-605	76.95

CHROME MASTER CYLINDER FACE CLAMP

- Chrome replacement for OEM face clamp
- Sold each



FITS MODEL	PART #	SUG. RETAIL
Most Honda cruisers	1731-0064	\$17.95

CALIPER ACCENT

- Chrome accent dresses up the brake caliper
- Easy installation



FITS MODEL	PART #	SUG. RETAIL
Honda VT600 99-04, VT750 ACE 99-03, VT1100 99-04 (all) and GL1500C/CF Valkyrie/Valkyrie Interstate 99-02	DS720742	\$32.95

REAR BRAKE CALIPER COVER

- Chrome finish
- Mounting hardware included



FITS MODEL	PART #	SUG. RETAIL
HONDA		
VTX1300R/S 03-08	1703-0021	\$76.95
KAWASAKI		
VN2000 Vulcan 04-08	1703-0040	86.95

COMFORT BRAKE PEDAL COVER

- Chrome-plated die-cast construction with raised rubber inserts
- Mounts easily with included hardware



SUG. RETAIL.....\$38.95 PART # 1611-0019

FITS MODEL
HONDA
VT600 Shadow VLX 98-08
VT750C Shadow Aero 04-08

FITS MODEL
HONDA (CONT)
VT1100 Shadow 85-08 (all)



BRAKE PEDAL COVERS

- Die-cast construction with raised rubber inserts
- Mounts easily with provided setscrews
- PART #DS-720714 fits Big Bike Parts and Markland floorboards in addition to the bikes listed below

FITS MODEL	PART #	SUG. RETAIL
HONDA		
VT600C 88-04	DS-720702	\$38.95
VT750C 98-03	DS-720701	38.95
VT1100C 87-04 (except Spirit)	DS-720702	38.95
GL1500C 97-02	DS-720714	43.95
SUZUKI		
VL800 Intruder Volusia 01-04	1611-0009	38.95



REAR BRAKE RESERVOIR COVERS

- Stamped-steel cover replaces black OEM cover
- Side cutout for viewing of fluid level
- Uses OEM mounting screw

FITS MODEL	PART #	SUG. RETAIL
HONDA		
VTX1300R/S 03-08	1703-0023	\$32.95
VTX1800R/S 02-08	1731-0065	32.95
KAWASAKI		
VN900 Vulcan 06-08	0410-0089	32.95
	1731-0146 ¹	86.95
YAMAHA		
XVZ1300 Royal Star 97-06, XV1600 Road Star 99-03	DS720747 ¹	32.95

¹ Celestar design.

All part numbers in **BOLD MAGENTA** are new this year.



- EXHAUST
- TIRES & ACCESSORIES
- LUGGAGE
- SPORTBIKE ACCESSORIES
- CRUISER ACCESSORIES**
- TOURING ACCESSORIES
- SECURITY & AUDIO
- GENERAL ACCESSORIES
- FAIRINGS & BODY
- SEATS
- HANDLEBARS & CONTROLS
- LIGHTING
- ELECTRICAL
- SPROCKETS
- CHAINS
- BRAKES
- SUSPENSION
- ENGINE
- FUEL SYSTEMS
- LUBES
- TOOLS
- TRAILER
- MERCH.
- CROSS REFERENCE
- INDEX

DS-720709

CALIPER COVERS

- Chromed stamped steel covers
- Install easily with two bolts



1703-0020



1703-0022



BB55107R



1703-0042



1703-0016



BB62108R

FITS MODEL	POSITION	PART #	SUG. RETAIL
HONDA			
VT600/750 Shadow 97-04 (all)	Left	DS-720709	\$76.95
VF750C Magna 97-03	Left	DS-720709	76.95
VT750 Shadow Aero 04-07	Left	1703-0020	76.95
VTX1300R/S 03-08	Right	1703-0022	76.95
GL1500C/CF Valkyrie/Valkyrie Interstate 97-03	Left	DS-720709	76.95
VTX1800C/R 02-07	Left	BB55107L	86.95
	Right	BB55107R	86.95
KAWASAKI			
VN1600 Vulcan Mean Streak 04-06 (pr.)	Both	1703-0015	86.95
VN2000 Vulcan 04-08	Right	1703-0041	86.95
	Left	1703-0042	86.95

FITS MODEL	POSITION	PART #	SUG. RETAIL
SUZUKI			
VL800 Intruder Volusia 01-04	Right	1703-0016	\$76.95
C50/M50 Boulevard 05-07	Right	1703-0016	76.95
VZ1600 Marauder 04 (pr.)	Both	1703-0015	86.95
YAMAHA			
XV650 V-Star 98-07 (all)	Right	BB62108R	76.95
XV1100 V-Star 99-06 (all, except Classic),	Left	BB62108L	76.95
XVS1300 V-Star 07-08	Right	BB62108R	76.95
XVS1100/A V-Star Custom/Classic 99-07 (pr.)	Both	1703-0014	153.95
XV1300 Royal Star 99-04 (all)	Left	BB62108L	76.95
	Right	BB62108R	76.95
XV1600 Road Star 99-03	Left	BB62108L	76.95
	Right	BB62108R	76.95



V-STYLE BRAKE PEDAL COVER

- Die-cast brake pedal cover with attractive V-style rubber pad
- Replaces rubber boot on brake pedal
- Slides on and secures with set-screw

FITS MODEL	PART #	SUG. RETAIL
Honda VTX1300/1800 02-06	1611-0012	\$53.95



REAR AXLE COVERS

- Sold in pairs

FITS MODEL	PART #	SUG. RETAIL
Honda VT600C		
Shadow VLX 88-04	DS-720729	\$102.95



1320-0004



1320-0006



1320-0005

BILLET FRONT AXLE CAPS AND PLUG

- Cover the front axle nuts and bolt heads

FITS MODEL	SIDE	PART #	SUG. RETAIL
FRONT AXLE CAP			
HONDA			
VF750 Magna 94-03 (all), VT750 Shadow 98-03 (all),			
VT1100 Shadow 87-04 (all, except Aero) (pr.)	Both	1320-0004	\$32.95
VTX1300/1800R/S 02-07, GL1500 Valkyrie/Interstate 97-03 (ea.)	Right	1320-0006	19.95
FRONT AXLE PLUG			
HONDA			
VTX1300/1800R/S 02-07, GL1500 Valkyrie/Interstate 97-03 (ea.)	Left	1320-0005	16.95
KAWASAKI			
VN1600B Vulcan Mean Streak 04-06, VN2000 Vulcan 04-07	Left	1320-0020	26.95
SUZUKI			
M95 Boulevard 05, VZ1600 Marauder 04	Left	1320-0020	26.95



BILLET REAR AXLE CAP

- Chrome-plated billet aluminum construction
- Covers the left rear axle nut

FITS MODEL	PART #	SUG. RETAIL
KAWASAKI		
VN2000 Vulcan 04-08 (pr.)	0214-0234	\$59.95
YAMAHA		
XVS650 V-Star Custom/Classic 98-07 (pr.)	0214-0235	49.95



REAR SPROCKET COVER

- Chrome plated and highly polished
- Covers the stock wheel sprocket
- Offers traditional cruiser styling
- Helps keep the rear of the bike cleaner looking
- Sold each

FITS MODEL	PART #	SUG. RETAIL
Honda VT600C		
Shadow VLX 88-04	DS-720726	\$32.95



FACE MOUNT TURN SIGNAL VISORS

- Raised teardrop design gives that custom look everyone wants
- Easily attach to stock turn signals using double-sided adhesive tape; sold in pairs



FITS MODEL	PART #	SUG. RETAIL
Honda VT600C Shadow VLX 98-04, VT750C Shadow ACE 98-03, VT1100C2 Shadow Sabre 00-07, VTX1300/S 04-08, GL1500CF Valkyrie Interstate 99-01, VTX1800C/R 02-08, VN2000 Vulcan 04-08	DS719001	\$43.95

TURN SIGNAL GRILLES

- Add flair to round-face turn signals
- Chrome stamped-steel construction
- Come complete with mounting screws and spacers
- Available in two styles
- Sold in sets of four



FITS MODEL	STYLE	PART #	SUG. RETAIL
HONDA			
VT600C Shadow VLX 88-98, VF750C Magna, VT1100 Shadow 87-99 (all except Aero), GL1500C Valkyrie 97-00	Standard	DS-719997	\$32.95
SUZUKI			
LS650P Savage 95-03, VS800GL Intruder 92-03, VZ800 Marauder 97-03, VL1500 Intruder LC 98-03	Round	0521-0212	38.95

SCREW MOUNT TURN SIGNAL VISORS

- Smooth design for a sleek look
- Mount easily using existing lens-mounting screws



FITS MODEL	PART #	SUG. RETAIL
Honda VT600C Shadow VLX 88-97, VF750C Magna 94-03, VT1100 Shadow 87-04 (all, except VT1100 Shadow Aero), GL1500C Valkyrie 97-02 (all)	DS719002	\$35.95

CELESTAR TURN SIGNAL GRILLES

- Celestar design matches other Show Chrome Celestar accessories
- Mount easily with double-sided adhesive tape
- Fit most cruiser turn signals with smooth lens faces



SUG. RETAIL.....	PART #	SUG. RETAIL
\$16.95	DS719964	

REFLECTOR GRILLES

- Chrome ABS grilles fit over 2 1/2" W x 1 7/16" H reflectors
- Sold in pairs



FITS MODEL	PART #	SUG. RETAIL
Honda VT750 Shadow Aero 04-08	0521-0221	\$16.95



SPEED VISORS

- CNC-machined billet chrome construction
- Reduces glare and reflection

FITS MODEL	PART #	SUG. RETAIL
HONDA		
VT750 Shadow Aero 04-08	2210-0114	\$58.95
VTX1800S 02-08	2210-0042	53.95
SUZUKI		
VL800 Intruder Volusia 01-04, C50 Boulevard 05-07	2210-0114	58.95

VANTAGE HORN COVERS

- Aggressively-styled horn cover delivers a custom look at a budget-friendly price
- Will not affect horn's resonance
- Inner tapered profile snaps onto OEM horn; no tools required



SUG. RETAIL.....	PART #	SUG. RETAIL
\$14.95	2107-0039	

FITS MODEL	PART #	SUG. RETAIL
Honda cruisers w/ 3 1/2" round horns	2107-0039	
Kawasaki and Yamaha cruisers w/ 3" or 3 1/4" round horns	2107-0040	

TAILLIGHT ACCENT GRILLE

- Chrome-plated grille with Celestar design
- Highlights and changes the appearance of the stock taillight
- Mounts using existing lens mounting screws



SUG. RETAIL.....	PART #	SUG. RETAIL
\$17.95	DS719003	

FITS MODEL	PART #	SUG. RETAIL
Yamaha XVS650 V-Star 98-07, XVZ1300 Royal Star 96-06, XV1600 Road Star 99-03	DS719003	

LED MARKER LIGHTS

- Replace OEM reflectors; enhance visibility
- Attach with double-sided tape (included)
- Measure 1 1/4" H x 3 1/2" W
- Sold in pairs



DESCRIPTION	PART #	SUG. RETAIL
FOR HONDA AND YAMAHA CRUISERS		
Amber	2040-0168	\$70.95

DESCRIPTION	PART #	SUG. RETAIL
FOR HONDA AND YAMAHA CRUISERS (CONT)		
Red	2040-0169	\$70.95

TAILLIGHT VISORS

- Brilliantly chrome-plated
- Three styles available
- Mount with double-sided adhesive tape



FITS MODEL	STYLE	PART #	SUG. RETAIL
HONDA			
VT750C Shadow ACE 98-03, VT1100C2/C3 Shadow	Ribbed	DS719004	\$47.95
Sabre/Aero 98-04, GL1500C Valkyrie 97-02	Teardrop	DS719006	43.95
VTX1300/1800C 02-08	Teardrop	BB55104	35.95

FITS MODEL	STYLE	PART #	SUG. RETAIL
YAMAHA			
XVS650/1100 V-Star Classic 98-07, XVZ1300 Royal Star 96-04, XV1600/1700 Road Star 99-07	Celestar	2010-0188	\$32.95

All part numbers in **BOLD MAGENTA** are new this year.

- EXHAUST
- TIRES & ACCESSORIES
- LUGGAGE
- SPORTBIKE ACCESSORIES
- CRUISER ACCESSORIES
- TOURING ACCESSORIES
- SECURITY & AUDIO
- GENERAL ACCESSORIES
- FAIRINGS & BODY
- SEATS
- HANDLEBARS & CONTROLS
- LIGHTING
- ELECTRICAL
- SPROCKETS
- CHAINS
- BRAKES
- SUSPENSION
- ENGINE
- FUEL SYSTEMS
- LUBES
- TOOLS
- TRAILER
- MERCH.
- CROSS REFERENCE
- INDEX

LINDBY
CUSTOM, INC.

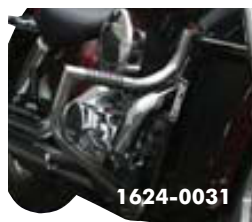

LINBAR FRONT AND REAR HIGHWAY BARS

- Triple-chrome-plated
 - Come complete with built-in O-ring footpegs for comfort
 - Front highway bars constructed from 1 1/4" tubing
 - Rear highway bars constructed from 1" tubing; compatible with most stock exhaust systems; require removal of rear footpegs/floorboards
- U.S. Patent #D361311



NOTE: Not recommended for use with extended forward controls. **SUG. RETAIL..... \$349.95**

FITS MODEL	PART #
HONDA	
VT750C Shadow ACE 98-03 (w/ OEM floorboards)	1624-0028
VT750C Shadow Aero 04-09	1624-0031
VT750DC Shadow Spirit 01-03/05-08	1624-0063
VT750C2 Shadow Spirit 07-09	1624-0031
VT1100C3 Shadow Sabre 97-08	7805-0031
VT1100C Shadow Spirit 01-08	7805-0031
VTX1300C/R/S Retro 03-09	1907-9071
VTX1800C 02-09	1907-5014
VTX1800R/N 02-09	1907-5015

FITS MODEL	PART #
KAWASAKI	
VN1500 96-08 (all except Mean Streak)	1907-5013
VN1600 Vulcan 03-08 (all)	1624-0027
SUZUKI	
VL800 Volusia 01-04	1624-0041
C50 Boulevard 05-09	1624-0041
VL1500 LC Intruder 98-04	1907-5012
C90 Boulevard 05-09	1907-5012
VICTORY	
V92C 99-01	DS190179
Kingpin/Vegas 03-05	1624-0042

FITS MODEL	PART #
VICTORY (CONT)	
Vegas 06-09	1624-0117
YAMAHA	
XVS650 V-Star 98-09	DS190178
XVS1100 V-Star 98-09	1907-5011
XV1300 V-Star 07-09 (all)	1624-0152
XVZ1300 Royal Star 97-01	DS190176
XV1600/1700 Road Star 99-09	DS190177
XV1900 Stratoliner 06-09	1624-0118

REPLACEMENT O-RINGS AND DRESS-UP KIT FOR HIGHWAY BARS

DESCRIPTION	PART #	SUG. RETAIL
Repl. O-rings (20-pk.)	7805-6969	\$8.95

DESCRIPTION	PART #	SUG. RETAIL
Wide O-ring Linbar dress-up kit (10-pk.)	1624-0104	\$18.95



CLAMP-ON FOOTPEGS

- High-quality billet aluminum clamp-on footpegs will fit any highway bar or frame with 1 1/4" o.d. tubing
- Sold in pairs

1624-0038

DESCRIPTION	PART #	SUG. RETAIL
Black anodized clamp-on O-rings footpegs	1624-0155	\$189.95
Black anodized clamp-on wide band footpegs	1624-0156	189.95
Black anodized clamp-on ribbed footpegs	1624-0157	189.95

DESCRIPTION	PART #	SUG. RETAIL
Chrome clamp-on O-rings footpegs	1624-0037	\$187.95
Chrome clamp-on wide band footpegs	1624-0038	187.95
Chrome clamp-on ribbed footpegs	1624-0039	187.95

MULTIBAR

- Each bar is made from a single piece of 1 1/4" tubing that's triple chrome-plated or finished in black powder-coat
- Patent-pending design with built-in bonded rubber footrests that provide traction and allow riders to adjust their position
- Easily installed with included hardware **SUG. RETAIL... \$269.95**

1624-0153

1624-0154

1624-0094

FITS MODEL	FINISH	PART #
HONDA		
VT750 Aero 04-09	Chrome-plated	1624-0102
VT750DC Spirit 01-03/05-08	Chrome-plated	1624-0103
VT750C2 Spirit 07-09	Chrome-plated	1624-0102
VTX1300S 02-09	Chrome-plated	1624-0101
VTX1800C/F 02-09	Chrome-plated	1624-0099
VTX1800R/S/N 02-09	Chrome-plated	1624-0100
KAWASAKI		
VN1500 Vulcan 98-08 (all)	Chrome-plated	1624-0097
VN1600 Vulcan 03-08 (all)	Chrome-plated	1624-0098
VICTORY		
Jackpot, Kingpin, Vegas 06-09	Chrome-plated	1624-0141
	Black powder-coat	1624-0168

FITS MODEL	FINISH	PART #
YAMAHA		
XVS650 V-Star 98-09 (all)	Chrome-plated	1624-0095
XVS1100 V-Star 98-09 (all)	Chrome-plated	1624-0096
XV1300 V-Star 07-09 (all)	Chrome-plated	1624-0153
	Black powder-coat	1624-0154
XV1600/1700 Road Star 99-09	Chrome-plated	1624-0094 ¹
XV1900 Stratoliner 06-09	Chrome-plated	1624-0119
	Black powder-coat	1624-0140

¹ Must drill 1 1/32" hole into the frame to install.

LOWERS FOR LINDBY HIGHWAY BARS



- Constructed of a durable water-resistant all-weather material
- Help keep feet and legs dry and clean
- Feature a pouch on each lower for extra storage capacity
- Positive hook-and-loop system for easy access; fold easily for storage
- Available plain or with chrome studs (studs on stud version are only on the front)
- Sold in pairs



PLAIN

STUDED

Studded backside

SUG. RETAIL.....\$100.95

SUG. RETAIL.....\$107.95

DESCRIPTION	PLAIN	STUDED
HONDA		
For 1907-9071, VTX1300R/S Retro 03-06	3550-0039	3550-0040
For 1907-5014, VTX1800C 02-06	3550-0043	3550-0044
For 1907-5015, VTX1800R/S 02-06	3550-0045	3550-0046

DESCRIPTION	PLAIN	STUDED
YAMAHA		
For DS190178, XVS650 V-Star 98-06	3550-0037	3550-0038
For 1907-5011, XVS1100 V-Star 98-06	3550-0041	3550-0042
For DS190177, XV1600/1700 Road Star 99-06	3550-0037	3550-0038

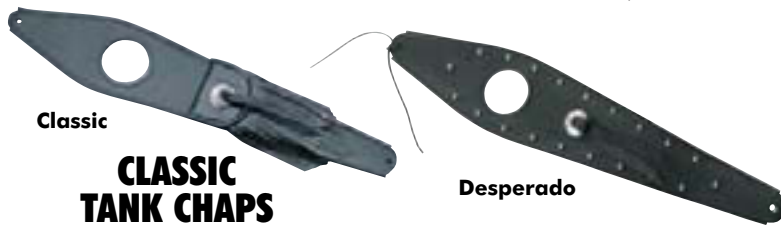

Classic

CLASSIC TANK CHAPS

- Classic fringe look combined with a handy pouch that is easy to open and close on the road
- Pouch will expand for larger loads using a hook-and-loop system
- Feature leather attachment laces
- Custom tailored to fit each tank shape with simple installation
- Matching seat and saddlebags also available

CLASSIC TANK CHAPS

SUG. RETAIL.....\$59.95

Desperado

DESPERADO TANK CHAPS

- Definitely mean business with a serious cruiser attitude
- A great way to dress up any cruiser and give it that custom look
- Classic styling with antique-style concho, leather ties and plated metal studs
- Custom tailored to fit each tank shape with simple installation
- Matching saddlebags also available

DESPERADO TANK CHAPS

SUG. RETAIL.....\$53.95

FITS MODEL	CLASSIC	DESPERADO	DRIFTER EXPANDABLE
HONDA			
CMX125/250 Rebel 85-06	H72N ¹	H721	-
VT600C Shadow VLX 91-02	H76N	H761-MP	-
VT750C Shadow ACE 98-00	H70N	H701	H70E ²
VT750DC Spirit 01-03/05-06	HZ70N	HZ701 ¹	HZ70E
VT1100C2 Shadow ACE 94-99	H79N ¹	H791-MP	H79E
VT1100C3 Shadow Aero 98-03	-	H741	H74E
GL1500C Valkyrie 97-03	-	H751	-
VTX1800C 02-06	H71N	H711 ¹	H71E
KAWASAKI			
VN700/750 Vulcan 85-04	-	K771-MP	-
VN800A/B Vulcan/Classic 95-05	-	K781MP	-
VN1500D Vulcan Classic 96-04	-	K761	K76E
VN1500P/1600 Mean Streak 02-04	0701-0086	0701-0084	0701-0085

DESPERADO FENDER CHAPS

- Decorative trim installs under solo seat and rear seat mount tab
- Perfect match for Travelcade/Saddlemen seats, luggage and chaps
- Desperado styling features studs, conchos, leather ties and distinctive edge welting
- Soft fender backing protects paint

FITS MODEL	PART #
HONDA	
VT750 Shadow ACE 98-00	H703R
VT750DC Spirit 01-03/05-06	HZ703R
VTX1800 02-06	H713R

SUG. RETAIL.....\$43.95

FITS MODEL	PART #
SUZUKI	
800 Volusia 01-04	S793R
VZ800 Marauder 97-04	S733R
VL1500 Intruder LC 99-04	S783R



Drifter Expanded



Drifter

DRIFTER EXPANDABLE TANK CHAPS

- Add loads of style and convenient storage
- Large, expandable pouch hidden beneath heavy-duty top flap, strap and buckle
- Bellows-styled sides expand nearly 4"; sides lay flat when empty
- Access pouch through large, zippered opening
- Match other Travelcade/Saddlemen Drifter products

Drifter Expandable



DRIFTER EXPANDABLE TANK CHAPS

SUG. RETAIL.....\$75.95

FITS MODEL	CLASSIC	DESPERADO	DRIFTER EXPANDABLE
KAWASAKI (CONT)			
VN1600 Vulcan Classic 03-05	-	-	0701-0025
SUZUKI			
VS700/750/800/1400 Intruder 87-04	S77N	S771-MP	-
800 Volusia 01-04	S79N	S791	S79E
VZ800 Marauder 97-04	-	S731	-
VZ1600 Marauder 04	0701-0086	0701-0084	0701-0085
YAMAHA			
XVS650 V-Star/Classic/Custom 96-06	Y76N	Y761	-
XVS1100 V-Star 99-06	Y71N	Y711 ³	Y71E

¹ Does not have concho.

² SUG. RETAIL \$69.95.

³ Has studs, no concho.



FITS MODEL	PART #
YAMAHA	
XVS650 V-Star/Dragstar Classic 00-06	Y773R
XVS1100 V-Star 99-06	Y713R
XVS1600 Road Star 99-03/XVS1700 Road Star 04-06	Y793R

All part numbers in **BOLD MAGENTA** are new this year.

- EXHAUST
- TIRES & ACCESSORIES
- LUGGAGE
- SPORTBIKE ACCESSORIES
- CRUISER ACCESSORIES
- TOURING ACCESSORIES
- SECURITY & AUDIO
- GENERAL ACCESSORIES
- FAIRINGS & BODY
- SEATS
- HANDLEBARS & CONTROLS
- LIGHTING
- ELECTRICAL
- SPROCKETS
- CHAINS
- BRAKES
- SUSPENSION
- ENGINE
- FUEL SYSTEMS
- LUBES
- TOOLS
- TRAILER
- MERCH.
- CROSS REFERENCE
- INDEX



- EXHAUST
- TIRES & ACCESSORIES
- LUGGAGE
- SPORTBIKE ACCESSORIES
- CRUISER ACCESSORIES**
- TOURING ACCESSORIES
- SECURITY & AUDIO
- GENERAL ACCESSORIES
- FAIRINGS & BODY
- SEATS
- HANDLEBARS & CONTROLS
- LIGHTING
- ELECTRICAL
- SPROCKETS
- CHAINS
- BRAKES
- SUSPENSION
- ENGINE
- FUEL SYSTEMS
- LUBES
- TOOLS
- TRAILER
- MERCH.
- CROSS REFERENCE
- INDEX

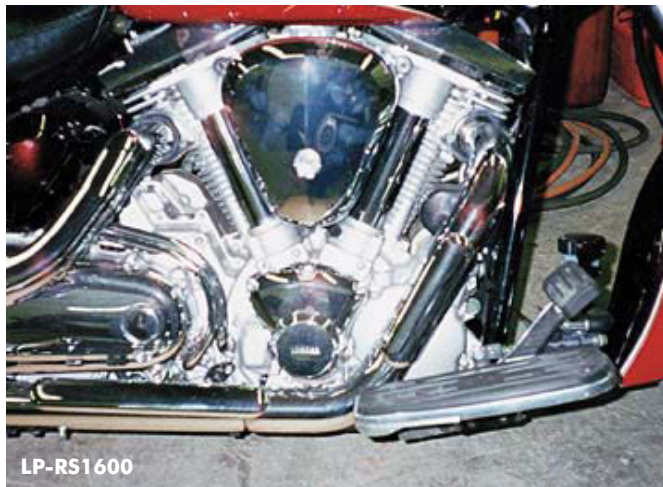

FORWARD CONTROL RELOCATION KITS

- Reposition floorboards, rear brake pedal and shift lever up to 3 1/4" further forward than stock
- Kit for Yamaha Road Star also angles floorboards 3° downward to keep legs in a more comfortable position for more relaxed riding
- Kit includes all necessary mounting hardware and instructions
- Black color finish

FITS MODEL	MOVES FORWARD	CONTROLS PART #	SUG. RETAIL
HONDA			
VT750 Shadow Aero 04-09	2 3/4"	1622-0024	\$172.95
VT750DC Shadow			
Spirit 01-03, 05-08	1 1/2"	LP-SS750	103.95
VT1100C2 Shadow Sabre 00-07	3"	LP-SS1100	129.95
VTX1800C 02-09	2 1/2"	LP-0034128	103.95
SUZUKI			
VL800 Volusia 01-04	2"	LP-FC001	141.95
VL1500 Intruder 98-04	3 1/4"	1622-0025	141.95
YAMAHA			
XV650 V-Star Custom 98-09	2 1/2"	1622-0009	141.95

FITS MODEL	MOVES FORWARD	CONTROLS PART #	SUG. RETAIL
YAMAHA (CONT)			
XV1100 V-Star 99-09	3"	VS-1100	\$84.95
XV1300 V-Star 07-09	3"	1622-0188	129.95
XV1600 Road Star 99-03	3"	LP-RS1600	84.95
XV1700 Road Star 04-09	3"	LP-RS1600	84.95
XV1700 Road Star Warrior 02-09	3"	LP-RW1600 ¹	103.95
XV1900 Roadliner 06-09	3"	1622-0142	129.95
XV1900 Stratoliner 06-09	3"	1622-0142	129.95

¹ Wrinkle finish.

REAR FOOTPEG REPOSITIONING KITS

- Lowers footpegs 2" and moves them ahead 3" to increase passenger comfort



FITS MODEL	COLOR	PART #	SUG. RETAIL
SUZUKI			
VL800 Volusia 01-04	Black	1620-0212	\$74.95
YAMAHA			
XV1700 Road Star Warrior 02-09	Wrinkle	LP-RW1602	124.95

DRIVE SHAFT COVER

FOR YAMAHA XV650/1100 V-STAR 98-09

- A bright, shining way to cover the dull gray drive shaft on your V-Star
- Chrome-plated aluminum cover, ball milled for style
- Mounts easily to the swingarm for a clean, custom look



SUG. RETAIL.....\$86.95 PART # 1201-0002

CHROME BELT GUARDS

- Sharp-looking chromed belt guards replace dull stock guards
- Easy bolt-on installation

SUG. RETAIL.....\$99.95

FITS MODEL	POSITION	PART #
KAWASAKI		
VN2000 Vulcan 05-09	Lower	1202-0053
YAMAHA		
XV1600 Road Star 99-09	Lower	LP-RS1602
XV1700 Road Star Warrior 02-09	Lower	1202-0050
	Upper	1202-0051
XV1900 Roadliner/Stratoliner 06-09	Lower	1202-0052 ¹

¹ Mounts over stock guard (small hole in stock guard required).



NESS-TECH® FOOTPEGS

- Machined from 6061 T-6 billet aluminum
- Feature male mounts
- Available in chrome
- Made in the U.S.A.

NOTE: Footpegs with male mount require an adapter to mount on Metric bikes.

SUG. RETAIL.....\$125.95



FRONT FOOTPEGS

FITS MODEL	DIAMOND FLATBAND	FLAMED	RETRO
HONDA			
VT600C Shadow VLX 96-06	1620-0488	1620-0489	1620-0490
VT600CD Shadow VLX Deluxe 96-07	1620-0488	1620-0489	1620-0490
VF750 Magna 96-04	1620-0488	1620-0489	1620-0490
VT750C Aero 04-08	1620-0488	1620-0489	1620-0490
VT750C/DC Spirit /ACE 00-08	1620-0488	1620-0489	1620-0490
VT1100 Sabre 00-07	1620-0488	1620-0489	1620-0490
VT1100 Spirit 99-07	1620-0488	1620-0489	1620-0490
VTX1300C 03-08	1620-0488	1620-0489	1620-0490
VTX1800C/F 02-08	1620-0488	1620-0489	1620-0490
KAWASAKI			
VN800 Vulcan Classic 96-05	1620-0491	1620-0492	1620-0493
VN800 Vulcan Custom 95-05	1620-0491	1620-0492	1620-0493
VN900 Vulcan Custom 07-08	1620-0491	1620-0492	1620-0493

FITS MODEL	DIAMOND FLATBAND	FLAMED	RETRO
KAWASAKI (CONT)			
VN1500/1600 Mean Streak 02-07	1620-0491	1620-0492	1620-0493
VN1500A/B Vulcan 87-99	1620-0491	1620-0492	1620-0493
SUZUKI			
M95 Boulevard 05	1620-0491	1620-0492	1620-0493
VZ1600 Marauder 04	1620-0491	1620-0492	1620-0493
YAMAHA			
XVS650 V-Star 98-08	1620-0494	1620-0495	1620-0496
XV750 Virago 88-98	1620-0494	1620-0495	1620-0496
XV1100 Virago 86-99	1620-0494	1620-0495	1620-0496
XVS1100 V-Star 99-08	1620-0494	1620-0495	1620-0496
VNX12 V-Max 85-88/90-07	1620-0494	1620-0495	1620-0496
XV1900 Raider 08	1620-0497	1620-0498	1620-0499

REAR FOOTPEGS

FITS MODEL	DIAMOND FLATBAND	FLAMED	RETRO
HONDA			
VT600C Shadow VLX 96-06	1620-0497	1620-0498	1620-0499
VT600CD Shadow VLX Deluxe 96-07	1620-0497	1620-0498	1620-0499
VF750 Magna 96-04	1620-0497	1620-0498	1620-0499
VT750C Aero 04-08	1620-0497	1620-0498	1620-0499
VT750C/DC Spirit /ACE 00-08	1620-0497	1620-0498	1620-0499
VT1100 Sabre 00-07	1620-0488	1620-0489	1620-0490
VT1100 Spirit 99-07	1620-0488	1620-0489	1620-0490
VT1100C Shadow 88-96	1620-0497	1620-0498	1620-0499
VT1100C3 Aero 99-02	1620-0497	1620-0498	1620-0499
VT1100CT ACE Tour 97-03	1620-0497	1620-0498	1620-0499
VTX1300C 03-08	1620-0497	1620-0498	1620-0499
VTX1300R/S 03-08	1620-0497	1620-0498	1620-0499
GL1500 Valkyrie 97-04 (all)	1620-0497	1620-0498	1620-0499
VTX1800C/F 02-08	1620-0497	1620-0498	1620-0499
VTX1800R/S/N/T 02-08	1620-0497	1620-0498	1620-0499
KAWASAKI			
VN800 Vulcan Classic 96-05	1620-0500	1620-0501	1620-0502
VN800 Vulcan Custom 95-05	1620-0500	1620-0501	1620-0502
VN1500/1600 Mean Streak 02-07	1620-0500	1620-0501	1620-0502

FITS MODEL	DIAMOND FLATBAND	FLAMED	RETRO
KAWASAKI (CONT)			
VN1500 Vulcan Classic 96-08	1620-0500	1620-0501	1620-0502
VN1500A/B Vulcan 87-99	1620-0500	1620-0501	1620-0502
VN1500J Drifter 99-05	1620-0500	1620-0501	1620-0502
VN1600A Vulcan Classic 03-08	1620-0500	1620-0501	1620-0502
VN2000A Vulcan 04-07	1620-0500	1620-0501	1620-0502
SUZUKI			
M95 Boulevard 05	1620-0500	1620-0501	1620-0502
M109R 06-08	1620-0506	1620-0507	1620-0508
VL800 Intruder Volusia 01-04	1620-0497	1620-0498	1620-0499
VZ1600 Marauder 04	1620-0500	1620-0501	1620-0502
YAMAHA			
XVS650 V-Star 98-08	1620-0503	1620-0504	1620-0505
XV750 Virago 88-98	1620-0503	1620-0504	1620-0505
XV1100 Virago 86-99	1620-0503	1620-0504	1620-0505
XVS1100 V-Star 99-08	1620-0503	1620-0504	1620-0505
VNX12 V-Max 85-88/90-07	1620-0503	1620-0504	1620-0505
XVZ1300A/AT Royal Star 96-01 w/ OEM rear pegs	1620-0503	1620-0504	1620-0505
XV1600/1700 Road Star 99-08	1620-0503	1620-0504	1620-0505
XV1700PC Road Star Warrior 02-08	1620-0497	1620-0498	1620-0499

BATTISTINIS CUSTOM CYCLES BILLET FOOTPEGS

- Machined from 6061 T-6 billet aluminum with chrome finish
- Footpegs are available with male mounts
- Made in the U.S.A.

SUG. RETAIL.....\$149.95



FITS MODEL	FRONT	REAR
HONDA		
600 VLX 96-06	1620-0478	1620-0483
600 VLX Deluxe 96-07	1620-0478	1620-0483
750 Aero 04-08	1620-0478	1620-0483
750 Magna 96-04	1620-0478	1620-0483
750 Spirit/Ace 00-08	1620-0478	1620-0483
1100 ACE Tourer 97-03	-	1620-0483
1100 Aero 99-02	-	1620-0483
1100 Sabre 00-07	1620-0478	1620-0478
1100 Shadow 85-96	-	1620-0483
1100 Spirit 99-07	1620-0478	1620-0478
VTX1300C 03-08	1620-0478	1620-0483
VTX1300R/S 03-08	-	1620-0483
GL1500 Valkyrie 97-03	-	1620-0483
GL1800 Gold Wing 01-08	1620-0481	-
VTX1800C/F 02-08	1620-0478	1620-0483
VTX1800R/R/S/T 02-08	-	1620-0483
KAWASAKI		
Vulcan 800 Classic 96-05	1620-0479	1620-0484
Vulcan 800 Custom 95-05	1620-0479	1620-0484
Vulcan 900 Custom 07-08	1620-0479	-
Vulcan 1500A/B 87-99	1620-0479	1620-0484
Vulcan 1500 Classic 96-08	-	1620-0484
Vulcan 1500 Drifter 99-05	-	1620-0484

FITS MODEL	FRONT	REAR
KAWASAKI (CONT)		
Vulcan 1500 Mean Streak 02-07	1620-0479	1620-0484
Vulcan 1600 Classic 03-08	-	1620-0484
Vulcan 1600 Mean Streak 02-07	1620-0479	1620-0484
Vulcan 2000/Classic 05-08	-	1620-0484
SUZUKI		
Boulevard M50 05-08	1620-0481	-
Marauder 800 97-04	1620-0480	1620-0485
Volusia 800 01-04	1620-0481	1620-0483
Boulevard C90 05-08	-	1620-0485
Intruder 1500LC 98-04	-	1620-0485
Boulevard M95 05	1620-0479	1620-0484
Marauder 1600 04	1620-0479	1620-0484
M109R Boulevard 06-08	1620-0481	1620-0486
YAMAHA		
V-Star 650 98-08	1620-0482	1620-0487
Virago 750 81-97	1620-0482	1620-0487
V-Star 1100 99-08	1620-0482	1620-0487
Virago 1100 86-99	1620-0482	1620-0487
V-Max 1200 85-07	1620-0482	1620-0487
Royal Star 1300 96-01 (w/ OEM rear pegs)	-	1620-0487
Road Star 1700 99-08	-	1620-0487
Road Star Warrior 1700 02-08	-	1620-0483
Raider 1900 08	1620-0483	-

All part numbers in **BOLD MAGENTA** are new this year.

- EXHAUST
- TIRES & ACCESSORIES
- LUGGAGE
- SPORTBIKE ACCESSORIES
- CRUISER ACCESSORIES
- TOURING ACCESSORIES
- SECURITY & AUDIO
- GENERAL ACCESSORIES
- FAIRINGS & BODY
- SEATS
- HANDLEBARS & CONTROLS
- LIGHTING
- ELECTRICAL
- SPROCKETS
- CHAINS
- BRAKES
- SUSPENSION
- ENGINE
- FUEL SYSTEMS
- LUBES
- TOOLS
- TRAILER
- MERCH.
- CROSS REFERENCE
- INDEX

- EXHAUST
- TIRES & ACCESSORIES
- LUGGAGE
- SPORTBIKE ACCESSORIES
- CRUISER ACCESSORIES
- TOURING ACCESSORIES
- SECURITY & AUDIO
- GENERAL ACCESSORIES
- FAIRINGS & BODY
- SEATS
- HANDLEBARS & CONTROLS
- LIGHTING
- ELECTRICAL
- SPROCKETS
- CHAINS
- BRAKES
- SUSPENSION
- ENGINE
- FUEL SYSTEMS
- LUBES
- TOOLS
- TRAILER
- MERCH.
- CROSS REFERENCE
- INDEX



1622-0026

CHROME FORWARD CONTROL KITS



- Beautifully designed and crafted forward controls with sealed ball bearing pivots
- Machined from 6061 T-6 aluminum, then chrome plated
- Assembled with chrome-plated hardware and ready to install
- Include master cylinder, hardware, pegs, shift and brake rods
- Available in diamond, elite and slotted styles

FITS MODEL	DESIGN	PART #	SUG. RETAIL
HONDA			
VTX1300 03-08	Diamond	1622-0026	\$949.95
VTX1800 02-08	Slotted	1622-0094	949.95



NEOPRENE O-RINGS FOR SUNDANCE® PEGS



- Replacements for original Sundance neoprene O-rings
- Sold in 10-pk.

DESCRIPTION	PART #	SUG. RETAIL
7/8" O-rings for highway and passenger pegs (10-pk.)	DS-253017	\$3.95
1" O-rings for large driver pegs and flat kick pedal (10-pk.)	DS-253019	5.95



FOOTPEG MOUNTS



- Add pegs where you want them
- CNC-machined from billet 6061 T-6 aluminum
- Fit all standard male-mount-style pegs
- Measure 1.5" x 1" dia.
- Sold in pairs

SUG. RETAIL.....\$33.95 PART # HPB-590



Sleek style

Original

SLEEK FOOTPEG BOLTS



- Bolts screw into each other, eliminating unsightly nut and extra thread
- Stainless steel construction with mirror polished heads
- 3/8" dia. barrel
- Sold in pairs

SUG. RETAIL.....\$24.95 PART # SFB-740



PASSENGER FOOTPEG MOUNTS FOR HONDA VTX1300/1800



- Machined from billet aluminum with a chrome finish
- Can be used with most aftermarket footpegs
- Sold in pairs
- Made in the U.S.A.

SUG. RETAIL.....\$74.95 PART # 1620-0106



HCM-208



HCM-207



HCM-209

HIGHWAY FOOTPEG CLAMP AND MOUNT SETS



- Three-piece design features chrome-plated steel clamp with billet 6061 T-6 aluminum footpeg mount
- State-of-the-art design resists slipping
- Available in 7/8", 1" and 1 1/8" dia.
- Sold in pairs

SUG. RETAIL.....\$52.95

DESCRIPTION	PART #	DESCRIPTION	PART #
7/8" dia.	HCM-207	1 1/8" dia.	HCM-209
1" dia.	HCM-208	1 1/4" dia.	HCM-210



PORK CHOP FOOT PADS



- Unique pads look and work great
- 6061 T-6 billet aluminum construction with faceted edges and rubber pads
- Use as peg replacements or as footrest when used with highway pegs
- Design allows the pads to be angled to rider's preference
- Measure 7" L x 4 1/2" W

SUG. RETAIL.....\$199.95 PART # PRK-790



MULTI-FACET FOOTPEGS

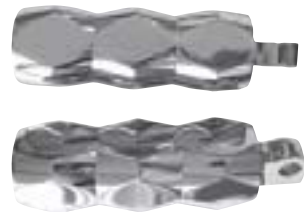

- Unique design and mirror-like polish reflects light like nothing else
- Made of show-quality chrome-plated 6061 T-6 billet aluminum
- Male mount
- Measure 4.3" L x 1.375" dia.
- Sold in pairs

SUG. RETAIL.....\$99.95 PART # FTP-200



FORWARD CONTROLS WITH MASTER CYLINDER

- Manufactured from 6061 billet aluminum with a high-quality chrome, anodized or polished finish
- All feature 3/4" bore master cylinder, splined shift arms and banjo brake switch
- Mounting hardware and instructions included
- Made in the U.S.A.

NOTE: Matching grips and rear pegs also available.

DESCRIPTION	PART #	SUG. RETAIL
HONDA		
VTX1300 04-09 (ALL)		
Classic, chrome	1622-0291	\$814.95
Classic, black anodized	1622-0292	824.95
Pro smooth, chrome	1622-0295	814.95
Pro smooth, black anodized	1622-0296	824.95
Medieval, chrome	1622-0299	939.95
Medieval, black anodized	1622-0300	949.95
VTX1800 02-09 (ALL)		
Classic, chrome	1622-0293	824.95
Classic, black anodized	1622-0294	834.95
Pro smooth, chrome	1622-0297	824.95
Pro smooth, black anodized	1622-0298	834.95
Medieval, chrome	1622-0301	949.95
Medieval, black anodized	1622-0302	959.95
VICTORY		
ALL MODELS 03-09 (EXCEPT VISION AND TOURING CRUISER)		
Pro smooth, chrome	1622-0327	874.95
Pro smooth, black anodized	1622-0328	884.95
Valor, chrome	1622-0329	904.95

DESCRIPTION	PART #	SUG. RETAIL
VICTORY (CONT)		
ALL MODELS 03-09 (EXCEPT VISION AND TOURING CRUISER) (CONT)		
Valor, black anodized	1622-0330	\$914.95
YAMAHA		
XVS1300 V-STAR 07-09		
Classic, chrome	1622-0305	749.95
Classic, black anodized	1622-0306	759.95
Pro smooth, chrome	1622-0313	749.95
Pro smooth, black anodized	1622-0314	759.95
Medieval, chrome	1622-0321	874.95
Medieval, black anodized	1622-0322	884.95
XVS1600/1700 ROAD STAR 99-09		
Classic, chrome	1622-0303	749.95
Classic, black anodized	1622-0304	759.95
Pro smooth, chrome	1622-0311	749.95
Pro smooth, black anodized	1622-0312	759.95
Medieval, chrome	1622-0319	874.95
Medieval, black anodized	1622-0320	884.95
XVS1700 WARRIOR 02-09		
Classic, chrome	1622-0307	824.95

DESCRIPTION	PART #	SUG. RETAIL
YAMAHA (CONT)		
XVS1700 WARRIOR 02-09 (CONT)		
Classic, black anodized	1622-0308	\$834.95
Pro smooth, chrome	1622-0315	824.95
Pro smooth, black anodized	1622-0316	834.95
Medieval, chrome	1622-0323	949.95
Medieval, black anodized	1622-0324	959.95
XV1900 RAIDER 08-09		
Classic, chrome	1622-0309	899.95
Classic, black anodized	1622-0310	909.95
Pro smooth, chrome	1622-0317	899.95
Pro smooth, black anodized	1622-0318	909.95
Medieval, chrome	1622-0325	1,024.95
Medieval, black anodized	1622-0326	1,034.95
ROADLINER/STRATOLINER 06-09		
Classic, chrome	1622-0331	899.95
Classic, black anodized	1622-0332	909.95
Pro smooth, chrome	1622-0333	899.95
Pro smooth, black anodized	1622-0334	909.95
Medieval, chrome	1622-0335	1,027.95
Medieval, black anodized	1622-0336	1,034.95



PASSENGER FOOTPEGS

- Billet aluminum construction
- Matching forward controls available; see above
- Available with a chrome-plated or black anodized finish
- Sold in pairs

DESCRIPTION	PART #	SUG. RETAIL
HONDA		
VTX1300 04-09 (ALL)		
Classic, chrome	1620-0576	\$144.95
Classic, black anodized	1620-0577	154.95
Pro smooth, chrome	1620-0574	144.95
Pro smooth, black anodized	1620-0575	154.95
Medieval, chrome	1620-0578	146.95
Medieval, black anodized	1620-0579	156.95
VTX1800 02-09 (ALL)		
Classic, chrome	1620-0582	144.95
Classic, black anodized	1620-0583	154.95
Pro smooth, chrome	1620-0580	144.95
Pro smooth, black anodized	1620-0581	154.95
Medieval, chrome	1620-0584	146.95
Medieval, black anodized	1620-0585	156.95

DESCRIPTION	PART #	SUG. RETAIL
VICTORY		
ALL MODELS 03-09 (EXCEPT VISION AND TOURING CRUISER)		
Pro smooth, chrome	1620-0570	\$154.95
Pro smooth, black anodized	1620-0571	164.95
Valor, chrome	1620-0572	154.95
Valor, black anodized	1620-0573	164.95
YAMAHA		
XVS1300 V-STAR 07-09, XVS1600/1700 ROAD STAR 99-09 AND XVS1700 WARRIOR 02-09		
Classic, chrome	1620-0588	144.95
Classic, black anodized	1620-0589	154.95
Pro smooth, chrome	1620-0586	144.95
Pro smooth, black anodized	1620-0587	154.95
Medieval, chrome	1620-0590	146.95

DESCRIPTION	PART #	SUG. RETAIL
YAMAHA (CONT)		
XVS1300 V-STAR 07-09, XVS1600/1700 ROAD STAR 99-09 AND XVS1700 WARRIOR 02-09 (CONT)		
Medieval, black anodized	1620-0591	\$156.95
XV1900 RAIDER 08-09		
Classic, chrome	1620-0594	144.95
Classic, black anodized	1620-0595	154.95
Pro smooth, chrome	1620-0592	144.95
Pro smooth, black anodized	1620-0593	154.95

All part numbers in **BOLD MAGENTA** are new this year.

- EXHAUST
- TIRES & ACCESSORIES
- LUGGAGE
- SPORTBIKE ACCESSORIES
- CRUISER ACCESSORIES
- TOURING ACCESSORIES
- SECURITY & AUDIO
- GENERAL ACCESSORIES
- FAIRINGS & BODY
- SEATS
- HANDLEBARS & CONTROLS
- LIGHTING
- ELECTRICAL
- SPROCKETS
- CHAINS
- BRAKES
- SUSPENSION
- ENGINE
- FUEL SYSTEMS
- LUBES
- TOOLS
- TRAILER
- MERCH.
- CROSS REFERENCE
- INDEX

CRUISER ACCESSORIES

EXHAUST

TIRES & ACCESSORIES

LUGGAGE

SPORTBIKE ACCESSORIES

CRUISER ACCESSORIES

TOURING ACCESSORIES

SECURITY & AUDIO

GENERAL ACCESSORIES

FAIRINGS & BODY

SEATS

HANDLEBARS & CONTROLS

LIGHTING

ELECTRICAL

SPROCKETS

CHAINS

BRAKES

SUSPENSION

ENGINE

FUEL SYSTEMS

LUBES

TOOLS

TRAILER

MERCH.

CROSS REFERENCE

INDEX



0630-0522



0630-0526



0630-0519



0630-0515

BILLET GRIPS



- 6061 T-6 billet aluminum construction with a chrome-plated or black anodized finish
- Fit 1" handlebars
- Matching forward controls and grips available; see page 469
- Sold in pairs

DESCRIPTION	PART #	SUG. RETAIL
HONDA		
Classic, chrome	0630-0523	\$144.95
Classic, black anodized	0630-0524	154.95
Pro Smooth, chrome	0630-0521	144.95
Pro Smooth, black anodized	0630-0522	154.95
Medieval, chrome	0630-0525	184.95
Medieval, black anodized	0630-0526	195.95

DESCRIPTION	PART #	SUG. RETAIL
VICTORY		
Valor, chrome	0630-0519	\$149.95
Valor, black anodized	0630-0520	159.95
Classic, chrome	0630-0515	144.95
Classic, black anodized	0630-0516	154.95
Pro Smooth, chrome	0630-0513	144.95
Pro Smooth, black anodized	0630-0514	154.95
Medieval, chrome	0630-0517	184.95
Medieval, black anodized	0630-0518	194.95

DESCRIPTION	PART #	SUG. RETAIL
YAMAHA		
Valor, chrome	0630-0519	\$149.95
Valor, black anodized	0630-0520	159.95
Classic, chrome	0630-0515	144.95
Classic, black anodized	0630-0516	154.95
Pro Smooth, chrome	0630-0513	144.95
Pro Smooth, black anodized	0630-0514	154.95
Medieval, chrome	0630-0517	184.95
Medieval, black anodized	0630-0518	194.95

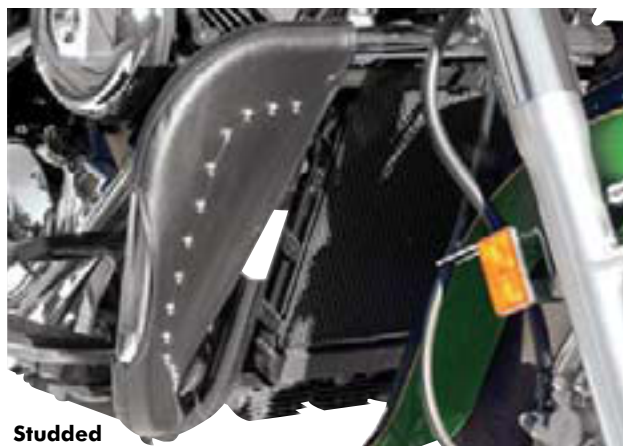

Studded



Plain

HIGHWAY BAR RAIN GUARDS



- Designed to help keep rain and road debris off your boots and lower legs
- Produce minimal wind resistance and do not affect airflow to the motor
- Available in plain or studded
- Sold as a set
- For Cobra® Standard Freeway or Fatty bars, see page 419
- Made in the U.S.A.

FITS MODEL	PLAIN	SUG. RETAIL	STUDED	SUG. RETAIL
HONDA				
VT750C Shadow Aero 04-09 w/ Cobra Standard Freeway engine guard bars	2350-0009	\$113.95	-	-
VTX1300C/S 03-09 w/ Cobra Standard Freeway engine guard bars	4050-0019	118.95	-	-
VTX1800R/S 02-09/VTX1800N 04-09 w/ Cobra Standard Freeway engine guard bars	4050-0017	118.95	-	-
KAWASAKI				
Vulcan 800 95-05 (all) w/ Cobra standard freeway bars	4050-0006	113.95	-	-
VN900B/C Vulcan Classic/Custom 06-09 w/ Cobra Standard Freeway engine guard bars	1624-0136	113.95	1624-0137	\$128.95
VN1500D/E Vulcan Classic 96-09 w/ Cobra Standard Freeway engine guard bars	4050-0008	113.95	-	-
VN1500D/E Vulcan Classic 96-09 w/ factory engine guard bars	2350-0015	118.95	-	-
VN1500G/L Nomad/Fi 99-04 w/ factory engine guard bars	4050-0004	113.95	-	-
VN1500J/R Drifter 99-04 w/ factory engine guard bars	4050-0002	113.95	4050-0003	128.95
VN1600 Vulcan 03-09 w/ factory engine guard bars	2350-0017	118.95	-	-
VN1600D Vulcan Nomad 05-09 w/ factory engine guard bar	1624-0091	113.95	1624-0092	128.95
Vulcan2000 04-09 (all) w/ Cobra "Fatty" engine guard bars	1624-0138	113.95	-	-
SUZUKI				
VL800 Volusia/C50 Boulevard 01-09 w/ Cobra Standard Freeway engine guard bars	4050-0021	113.95	4050-0022	128.95
VL1500 Intruder LC 98-09 w/ Cobra Standard Freeway engine guard bars	4050-0002	113.95	4050-0003	128.95
VICTORY				
V92C 98-02	4050-0002	113.95	4050-0003	128.95
YAMAHA				
XVS1100 V-Star 99-09 w/ factory engine guard bars	2350-0011	113.95	2350-0012	128.95
XVS1100 V-Star 99-09 w/Cobra standard freeway bars	4050-0002	113.95	4050-0003	128.95
XVS1300 V-Star 07-09 w/ factory engine guard bars	1624-0150	118.95	-	-
XVS1300 V-Star 07-09 w/ Cobra standard freeway bars	4050-0008	113.95	-	-
XV1600A/1700 Road Star 99-09 w/ Cobra Standard Freeway engine guard bars	4050-0002	113.95	4050-0003	128.95
XV1600A/1700 Road Star 99-09 w/ factory engine guard bars	2350-0013	113.95	2350-0014	128.95
XV1900CT/M/S Stratoliner 06-09, XV1900M/S Roadliner 06-09 w/ Yamaha "Big Bar" highway bar	1624-0116	118.95	-	-
XV1900CT/M/S Stratoliner/Roadliner 06-09, XV1900M/S Roadliner 06-09 w/ Cobra "Fatty" engine guard bars	4050-0008	113.95	-	-



0701-0209

0701-0222

0701-0226



DS-900662

0701-0213



0701-0198

PLAIN BIB

SUG. RETAIL... **\$48.95**

W/ STUDS AND CONCHO

SUG. RETAIL... **\$58.95**

0701-0380



0701-0215



0701-0230



0701-0325

0701-0324



CRUISER TANK BIBS

- Contour-formed to tightly hug the gas tank
- Felt-backed to protect paint
- Premium-quality expanded vinyl cover
- Available with studs and a leather-tied concho or plain
- Braided edge trim
- Utilize stock mounts and hook-and-loop fasteners for easy installation

FITS MODEL	WITH STUDS AND CONCHO		PLAIN
	WITH STUDS AND CONCHO	PLAIN	
HONDA			
VT600VLX 88-98 (all)	DS-900665	0701-0202	
VF750C V45 Magna 94-03	DS-900658	DS-900657	
VT750 Shadow A.C.E. 98-03	0701-0207	0701-0206	
VT750C Shadow Aero 04-08	0701-0239	0701-0238	
VT750DC Shadow Spirit 01-03, 05-08	0701-0221	0701-0220	
VT1100C Shadow 87-97	DS-900664	0701-0199	
VT1100C3 Shadow Aero 98-02	0701-0209	0701-0208	
VT1100 Shadow A.C.E./A.C.E. Tourer/Sabre/Spirit 95-01	DS-900656	DS-900655	
VTX1300C 04-08	0701-0233 ³	0701-0232	
VTX1300 Retro 02-08	0701-0233 ³	0701-0232	
GL1500C Valkyrie 97-03 (all)	DS-900666	0701-0203	
VTX1800C 02-07	0701-0223 ³	0701-0222	
VTX1800F 05-08	0701-0323	0701-0325	
VTX1800 Retro 02-08	0701-0229 ³	0701-0228	
VTX1800N 04-08	0701-0229 ³	0701-0228	
KAWASAKI			
VN800A Vulcan 95-05	DS-900668	0701-0200	
VN800C Vulcan Drifter 99-00	DS-900668	0701-0200	
VN900B/D Vulcan Classic 06-08	0701-0324	0701-0326	
VN1500D/E Vulcan Classic 96-08	DS-900667 ¹	0701-0201 ¹	
VN1500D/E Vulcan Classic 96-08	0701-0219 ²	0701-0218 ²	
VN1500G/L Vulcan Nomad/Fi 99-04	0701-0219 ²	0701-0218 ²	
VN1500P Vulcan Mean Streak 02-03	0701-0227 ³	0701-0226	

FITS MODEL	WITH STUDS AND CONCHO		PLAIN
	WITH STUDS AND CONCHO	PLAIN	
KAWASAKI (CONT)			
VN1600A Vulcan Classic 03-08	0701-0235	0701-0234	
VN1600B Vulcan Mean Streak 04-08	0701-0227 ³	0701-0226	
VN1600D Vulcan Nomad 05-08	0701-0235	0701-0234	
VN2000 04-08	0701-0237	0701-0236	
SUZUKI			
VS700/800 Intruder 85-04	DS-900662	-	
C50 Boulevard 05-08	0701-0225	0701-0224	
M50 Boulevard 05-08	0701-0386	0701-0385	
VL800 Intruder Volusia 01-04	0701-0225	0701-0224	
VZ800 Marauder 97-04	0701-0213	0701-0212	
VS1400 Intruder 87-04	DS-900660 ⁴	0701-0198 ⁴	
VZ1600 Marauder 04	0701-0227	0701-0226	
YAMAHA			
XVS650/AT V-Star 98-08	0701-0211	0701-0210	
XVS1100 V-Star Custom/Classic 99-08	0701-0217	0701-0216	
XVS1300A V-Star 07-08	0701-0380	0701-0379	
XVZ1300CT Royal Star Tour Deluxe 05-08	0701-0241	0701-0240	
XV1600 Road Star 99-03 (all)	0701-0215	0701-0214	
XV1700 Road Star 04-08 (all)	0701-0215	0701-0214	
XV1700PC Road Star Warrior 02-03	0701-0231 ³	0701-0230	

¹ For 4.2-gal. tank.
² For 5-gal. tank.
³ Studded only. No concho.
⁴ Not for California models.



1405-0096



1405-0095



1405-0100



1405-0073



1405-0072

FENDER BIBS

- Add style to your ride
- Made with waterproof black synthetic leather that will look good for years to come
- Felt-backed to protect your bike's paint
- Use stock mounts and fit snug to edge of fender without any gaps

FITS MODEL	STUDED		VINTAGE
	STUDED	VINTAGE	
HONDA			
VT750 Shadow A.C.E. 98-03	1405-0041	1405-0040	
VT750C Shadow Aero 04-08	1405-0065	1405-0064	
VT1100 Shadow A.C.E./A.C.E. Tourer 95-01	1405-0035	1405-0034	
VT1100C3 Shadow Aero 98-02	1405-0049	1405-0048	
VTX1300C 04-08	1405-0055	1405-0054	
VTX1300 Retro 02-08	1405-0059	1405-0058	
VTX1300S 02-08	1405-0059	1405-0058	
VTX1800C 02-07	1405-0055	1405-0054	
VTX1800F 05-08	1405-0096	1405-0095	
VTX1800N 04-08	1405-0067	1405-0066	
VTX1800 Retro 02-08	1405-0059	1405-0058	
KAWASAKI			
VN800A Vulcan 95-05	1405-0045	1405-0044	
VN800B Vulcan Classic 96-05	1405-0045	1405-0044	
VN1500D Vulcan Classic 96-08	DS-900677	1405-0029	
VN1500D Vulcan Nomad 99-04	DS-900677	1405-0029	
VN1500P Vulcan Mean Streak 02-03	1405-0057	1405-0056	
VN1600A Vulcan Classic 03-08	1405-0061	1405-0060	
VN1600B Vulcan Mean Streak 04-08	1405-0057	1405-0056	
VN1600D Vulcan Nomad 05-08	1405-0061	1405-0060	
VN2000A Vulcan 04-08	1405-0063	1405-0062	

FITS MODEL	VINTAGE		STUDED	
	SUG. RETAIL..... \$30.95		SUG. RETAIL..... \$35.95	
FITS MODEL	STUDED	VINTAGE	STUDED	VINTAGE
SUZUKI				
M50 Boulevard 05-08	1405-0110	1405-0109		
VL800 Intruder Volusia 01-04	1405-0031	1405-0030		
VZ800 Marauder 97-04	1405-0051	1405-0050		
C90 Boulevard 05-08	1405-0069	1405-0068		
VL1500 Intruder LC 98-04	1405-0053	1405-0052		
YAMAHA				
XVS650 V-Star Classic 98-08	1405-0071	1405-0070		
XVS650 V-Star Custom 98-08	1405-0043	1405-0042		
XVS1100 V-Star Custom 99-08	1405-0043	1405-0042		
XVS1100A V-Star Classic 00-08	1405-0047	1405-0046		
XVS1100AT V-Star Silverado 02-08	1405-0047	1405-0046		
XVS1300A V-Star 07-08	1405-0100	1405-0099		
XVZ1300CT Royal Star Tour Deluxe 05-08	1405-0037	1405-0036		
XV1600A Road Star 99-03	1405-0039	1405-0038		
XV1700A Road Star 04-08	1405-0039	1405-0038		
XV1700PC Road Star Warrior 02-03	1405-0033	1405-0032		
XV1900 Raider 08	1405-0112	1405-0111		
XV1900 Roadliner 06-08	1405-0073	1405-0072		
XV1900CT Stratoliner 06-08	1405-0073	1405-0072		

All part numbers in **BOLD MAGENTA** are new this year.

- EXHAUST
- TIRES & ACCESSORIES
- LUGGAGE
- SPORTBIKE ACCESSORIES
- CRUISER ACCESSORIES
- TOURING ACCESSORIES
- SECURITY & AUDIO
- GENERAL ACCESSORIES
- FAIRINGS & BODY
- SEATS
- HANDLEBARS & CONTROLS
- LIGHTING
- ELECTRICAL
- SPROCKETS
- CHAINS
- BRAKES
- SUSPENSION
- ENGINE
- FUEL SYSTEMS
- LUBES
- TOOLS
- TRAILER
- MERCH.
- CROSS REFERENCE
- INDEX



- EXHAUST
- TIRES & ACCESSORIES
- LUGGAGE
- SPORTBIKE ACCESSORIES
- CRUISER ACCESSORIES**
- TOURING ACCESSORIES
- SECURITY & AUDIO
- GENERAL ACCESSORIES



TUXEDO™ TIES

- Signature series Hopnel Tuxedo™ Ties are made of marine-grade vinyl with black ostrich material
- Accented with corded edges and custom-decorative braiding
- Non-marring felt back to prevent scratching
- Mount easily with existing hardware
- Include a handy storage pouch with chrome concho

SUG. RETAIL...\$62.95



FITS MODEL	PART #
HONDA	
VT600 Shadow VLX 88-06	3502-0052
VT750 Shadow Aero 04-08	3502-0051
VT750 Shadow Spirit 01-08	3502-0138
VT1100 Shadow ACE, Sabre, Spirit 96-07	3502-0052
VTX1300R/S 03-08	3502-0056
GL1500C Valkyrie 97-02	3502-0137
VTX1800C 02-07	3502-0055
VTX1800R/S 02-08	3502-0114
KAWASAKI	
VN900 Vulcan 06-08	3502-0132

FITS MODEL	PART #
SUZUKI	
C50 Boulevard 05-08	3502-0059
VL800 Intruder Volusia 01-04	3502-0059
YAMAHA	
XVS650 V-Star 98-07	3502-0133
XVS1100 V-Star 99-07	3502-0061
XVZ1300 Royal Star Venture 98-03	3502-0139
XV1600 Road Star 99-03	3502-0140

TUXEDO™ TAILS

- Signature series design matches Tuxedo™ Ties
- Available in marine-grade vinyl with black ostrich material
- Mount to existing hardware on rear fender
- Non-marring felt backing



FITS MODEL	PART #	SUG. RETAIL
HONDA		
VT750C Shadow ACE 98-03	3502-0049	\$20.95
VTX1300R/S 03-08	3502-0057	20.95
VTX1800R 02-08	3502-0057	20.95
KAWASAKI		
VN2000 Vulcan 04-07	3502-0100	22.95

FITS MODEL	PART #	SUG. RETAIL
SUZUKI		
C50 Boulevard 05-08	3502-0103	\$22.95
VL800 Intruder Volusia 01-04	3502-0103	22.95
YAMAHA		
XVS650A V-Star Classic 98-07	1405-0105	20.95
XV1600 Road Star 99-03	1405-0105	20.95

- EXHAUST
- TIRES & ACCESSORIES
- LUGGAGE
- SPORTBIKE ACCESSORIES
- CRUISER ACCESSORIES**
- TOURING ACCESSORIES
- SECURITY & AUDIO
- GENERAL ACCESSORIES
- FAIRINGS & BODY
- SEATS
- HANDLEBARS & CONTROLS
- LIGHTING
- ELECTRICAL
- SPROCKETS
- CHAINS
- BRAKES
- SUSPENSION
- ENGINE
- FUEL SYSTEMS
- LUBES
- TOOLS
- TRAILER
- MERCH.
- CROSS REFERENCE
- INDEX

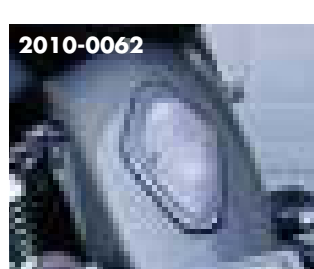
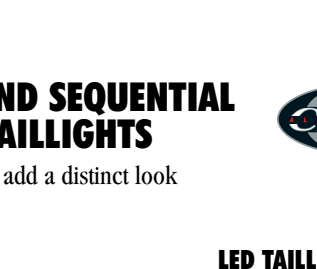
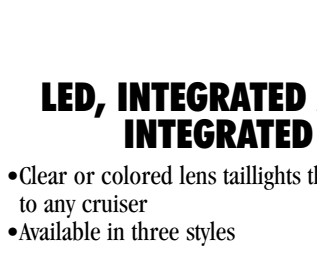
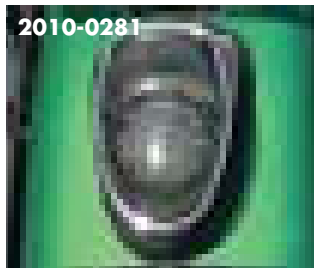
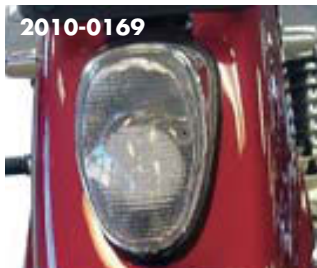

LED, INTEGRATED AND SEQUENTIAL INTEGRATED TAILLIGHTS



- Clear or colored lens taillights that add a distinct look to any cruiser
- Available in three styles

LED TAILLIGHT KITS

- Complete units; include two 2" round clusters with 50 LED taillights on a circuit board and a clear taillight lens
- Cluster is mounted inside the taillight housing assembly and connected to an 1157 or 3057 bulb adapter plug that installs directly into the factory wiring harness
- When brake lights are off, 100% of LED red is eliminated for a true clear taillight look
- Superbright LED bulbs are rated for 100,000 hours of continuous use and require less power than standard 1157 bulbs
- Some clusters are lens and bulb kits (no housing assembly); these include a 1.5" round cluster with 30 LEDs on an 1157 circuit-board-type bulb
- No wire cutting or other modifications needed for installation
- DOT approved

INTEGRATED LED TAILLIGHT KITS

- When turn signals are activated, half of the taillight is cancelled and blinks with amber LEDs
- Use over 100 red and amber LED lights
- Complete units; require no modification or lens removal

SEQUENTIAL INTEGRATED LED TAILLIGHT KITS

- The next generation of customized taillights, these kits feature the clean, compact style of the Integrated LED kits with a unique light effect
- Each row of LEDs lights up in succession toward the direction of the turn

LED, INTEGRATED AND SEQUENTIAL INTEGRATED TAILLIGHTS continued on next page.

FITS MODEL	LENS COLOR	LED KIT PART #	SEQUENTIAL INTEGRATED KIT	
			INTEGRATED KIT PART #	INTEGRATED KIT PART #
HONDA				
VT600C/CD Shadow				
VLX/VLX Deluxe 99-05	Clear	CTL-0026-L	2010-0203	2010-0497
	Smoke	2010-0264	2010-0263	-
VF750 Magna 94-03	Clear	2010-0266	-	-
	Smoke	2010-0267	-	-
VT750C Shadow Aero 04-07	Clear	2010-0269	2010-0206	-
	Smoke	2010-0270	-	-
VT750CD Shadow ACE Deluxe 98-01	Clear	CTL-0039-L	2010-0204	-
	Smoke	-	2010-0205	-
VT750DC Shadow Spirit 01-03, 05-07	Clear	2010-0266	-	-
	Smoke	2010-0267	-	-
VT1100C1 Shadow Spirit 99-05	Clear	CTL-0026-L	2010-0203	-
VT1100C2 Shadow Sabre 00-07	Clear	CTL-0039-L	2010-0204	-
	Smoke	-	2010-0205	-
VT1100C3 Shadow Aero 98-03	Clear	CTL-0039-L	2010-0204	-
	Smoke	-	2010-0205	-
VTX1300/1800C 02-05	Clear	2010-0063	-	-
	Smoke	2010-0268	-	-
VTX1300/1800R 02-05	Clear	2010-0062	-	-
GL1500C Valkyrie 97-03	Clear	CTL-0039-L	2010-0204	-
	Smoke	-	2010-0205	-
KAWASAKI				
BN125 Eliminator 125 99-06	Clear	CTL-0021-L	2010-0215	-
EN500A Vulcan 96-07	Clear	CTL-0021-L	2010-0215	-
ZL600B Eliminator 96-97	Clear	CTL-0021-L	2010-0215	-

FITS MODEL	LENS COLOR	LED KIT PART #	SEQUENTIAL INTEGRATED KIT	
			INTEGRATED KIT PART #	INTEGRATED KIT PART #
KAWASAKI (CONT)				
VN750A Vulcan 85-05	Clear	2010-0074	-	-
VN800 Vulcan 95-05	Clear	2010-0168	2010-0209	-
VN800B Vulcan Classic 96-05	Clear	2010-0168	2010-0209	-
VN800C Vulcan Drifter 99-06	Clear	2010-0169	-	-
	Smoke	2010-0281	-	-
VN900B Vulcan Classic 06	Clear	2010-0034	2010-0208	-
	Smoke	2010-0282	2010-0541	-
VN1500 Vulcan 87-05 (all)	Clear	2010-0168	2010-0209	-
VN1500P Vulcan Mean Streak 02-05	Clear	2010-0034	2010-0208	-
	Smoke	2010-0282	-	-
VN1500J/R/1600A Vulcan Drifter/Classic 00-05	Clear	2010-0169	-	-
VN1600 Vulcan 02-05	Clear	2010-0034	2010-0208	-
	Smoke	2010-0282	2010-0541	-
VN1600A/C Vulcan Classic 00-07/Drifter 00-06	Clear	2010-0169	-	-
	Smoke	2010-0281	-	-
VN1600B Vulcan Mean Streak 04-05	Clear	2010-0034	2010-0208	-
	Smoke	2010-0282	2010-0541	-
VN1600G Vulcan Nomad 05-07	Clear	2010-0169	-	-
	Smoke	2010-0281	-	-
VN2000 Vulcan 04-07	Clear	-	2010-0366	-
	Smoke	-	2010-0367	-
	Red	-	2010-0368	-

All part numbers in **BOLD MAGENTA** are new this year.



LED, INTEGRATED AND SEQUENTIAL INTEGRATED TAILLIGHTS (CONT)

FITS MODEL	LENS COLOR	LED KIT PART #	INTEGRATED KIT PART #	SEQUENTIAL INTEGRATED KIT PART #
SUZUKI				
C50 Boulevard 05-06	Clear	2010-0051	2010-0213	-
	Smoke	2010-0291	-	-
M50 Boulevard	Clear	2010-0050	-	-
VL800 Intruder Volusia 01-04	Clear	2010-0051	2010-0213	-
	Smoke	2010-0291	-	-
VZ800 Marauder 97-04	Clear	2010-0050	-	-
S83 Boulevard 05	Clear	2010-0049	-	-
VS1400 Intruder 87-04	Clear	2010-0049	-	-
C90 Boulevard 05	Clear	2010-0051	2010-0213	-
	Smoke	2010-0291	-	-
VL1500 Intruder LC 98-04	Clear	2010-0051	2010-0213	-
	Smoke	2010-0291	-	-
VZ1600 Marauder 97-04	Clear	2010-0050	-	-
M109R Boulevard 06-08	Clear	-	2010-0383	2010-0440
	Smoke	-	2010-0384	2010-0443
	Red	-	2010-0385	2010-0442
	Blue	-	2010-0397	2010-0441
YAMAHA				
XV650 V-Star Custom 98-07	Clear	CTL-0021-L	2010-0215	2010-0491

FITS MODEL	LENS COLOR	LED KIT PART #	INTEGRATED KIT PART #	SEQUENTIAL INTEGRATED KIT PART #
YAMAHA (CONT)				
XV650A V-Star Classic 98-07	Clear	2010-0182	-	2010-0492
	Smoke	2010-0217	2010-0218	-
XV700/750/1000/1100 Virago 84-03	Clear	CTL-0043-L	-	-
	Smoke	2010-0301	-	-
XVS1100 V-Star Custom 99-07	Clear	CTL-0021-L	2010-0215	2010-0491
	Smoke	-	-	2010-0492
XVS1100A V-Star Classic 00-05	Clear	2010-0182	-	-
	Smoke	2010-0217	2010-0218	-
VMX1200 V-max 85-07	Clear	CTL-0043-L	-	-
	Smoke	2010-0301	-	-
XVZ1300 Royal Star 96-03	Clear	2010-0182	-	-
	Smoke	2010-0217	2010-0218	-
XV1600 Road Star 99-03	Clear	2010-0182	-	-
	Smoke	2010-0217	2010-0218	-
XV1700 Road Star 04-08	Clear	-	2010-0219	-
	Smoke	-	2010-0300	-
XV1700PC Road Star Warrior 02-08	Clear	-	2010-0183	2010-0472
	Smoke	-	-	2010-0473

PRICE LIST

PART #	SUG. RETAIL	PART #	SUG. RETAIL	PART #	SUG. RETAIL	PART #	SUG. RETAIL	PART #	SUG. RETAIL
2010-0034	\$91.95	2010-0183	\$124.95	2010-0218	\$118.95	2010-0282	\$91.95	2010-0397	\$149.95
2010-0049	74.95	2010-0203	118.95	2010-0219	134.95	2010-0291	84.95	2010-0440	199.95
2010-0050	99.95	2010-0204	109.95	2010-0263	118.95	2010-0300	134.95	2010-0441	199.95
2010-0051	84.95	2010-0205	109.95	2010-0264	79.95	2010-0301	84.95	2010-0442	199.95
2010-0062	84.95	2010-0206	118.95	2010-0266	79.95	2010-0366	134.95	2010-0443	199.95
2010-0063	79.95	2010-0208	134.95	2010-0267	79.95	2010-0367	134.95	2010-0472	174.95
2010-0074	84.95	2010-0209	149.95	2010-0268	79.95	2010-0368	134.95	2010-0473	174.95
2010-0168	91.95	2010-0213	129.95	2010-0269	79.95	2010-0383	149.95	2010-0491	159.95
2010-0169	54.95	2010-0215	109.95	2010-0270	79.95	2010-0384	149.95	2010-0492	159.95
2010-0182	79.95	2010-0217	79.95	2010-0281	54.95	2010-0385	149.95	2010-0497	169.95
								CTL-0026-L	79.95
								CTL-0039-L	79.95
								CTL-0043-L	84.95

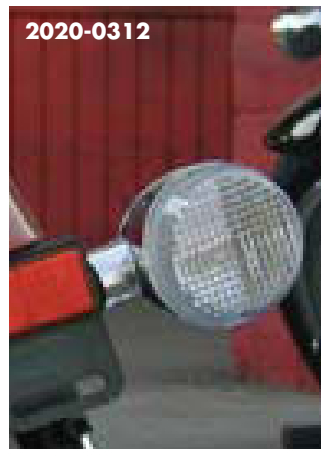

CLEAR TURN SIGNAL LENSES



- Direct replacement for stock amber signal lenses
- Lenses give you a true clear look; some kits available with smoke lenses
- Amber bulbs included
- Sold in pairs
- DOT approved

FITS MODEL	LENS COLOR	FRONT	REAR	SUG. RETAIL
HONDA				
All cruisers (except Magna, Shadow Spirit, Shadow ACE Tourer and Valkyrie)	Clear	2020-0306	2020-0307	\$18.95
	Smoke	2020-0311	2020-0312	18.95
VT1100 Shadow Spirit 97-06	Clear	2020-0308	2020-0309	18.95
GL1500 Valkyrie 97-03	Clear	2020-0308	2020-0309	18.95
KAWASAKI				
VN1600 Vulcan Classic 03-06	Clear	2020-0306	2020-0307	18.95
	Smoke	2020-0311	2020-0312	18.95

FITS MODEL	LENS COLOR	FRONT	REAR	SUG. RETAIL
KAWASAKI (CONT)				
VN2000 Vulcan 04-06	Clear	2020-0306	2020-0307	\$18.95
	Smoke	2020-0311	2020-0312	18.95
SUZUKI				
All cruisers 88-03	Clear	2020-0237	2020-0238	24.95
All cruisers 04-08	Clear	2020-0239	2020-0240	29.95
YAMAHA				
All cruisers (except Warrior)	Clear	2020-0245	2020-0246	18.95
XV1700PC Road Star Warrior 02-06	Clear	2020-0247	2020-0248	18.95
	Smoke	2020-0249	2020-0250	18.95



CLEAR TAILLIGHT LENSES

FOR YAMAHA XVS650/
1100 V-STAR CUSTOM 98-04

- They're cool, and they're DOT approved
- NOTE: Must use red-tinted taillight bulbs.



SUG. RETAIL..... **\$46.95**
PART # 2010-0149

All part numbers in **BOLD MAGENTA** are new this year.

- EXHAUST
- TIRES & ACCESSORIES
- LUGGAGE
- SPORTBIKE ACCESSORIES
- CRUISER ACCESSORIES
- FAIRINGS & BODY
- SEATS
- HANDLEBARS & CONTROLS
- LIGHTING
- ELECTRICAL
- SPROCKETS
- CHAINS
- BRAKES
- SUSPENSION
- ENGINE
- FUEL SYSTEMS
- LUBES
- TOOLS
- TRAILER
- MERCH.
- CROSS REFERENCE
- INDEX



Diesel



Ronin



Mission



Diesel Chrome



STREET CRUISER ONE-PIECE ALUMINUM WHEELS FOR SUZUKI M109R 06-08

- These forged wheels place the highest material strength in the same direction as the operating load, creating a light and strong wheel
- Contrast Cut™ finish starts with a polished wheel that has been black anodized, then recut to open up the design
- Made in the U.S.A.

FITS MODEL	DIESEL	MISSION	RONIN	SUG. RETAIL	DIESEL CHROME	SUG. RETAIL
Front (18" x 3.5")	0201-0654	0201-1142	0201-1148	\$1,149.95	0201-0665	\$1,199.95
Rear (18" x 8.5")	0202-0670	0202-1258	0202-1269	1,549.95	0202-0688	1,599.95
(18" x 10")	0202-0671	0202-1259	0202-1270	1,649.95	0202-0689	1,699.95



Torque



Domino



Cartel

FORGED ALUMINUM CRUISER WHEELS FOR SUZUKI M109 06-08



- Chrome forged aluminum for strength, durability and show-quality good looks
- Chrome-plated for durability and lasting beauty
- Available in three styles: Torque, Domino and Cartel
- Work with stock brake calipers and rotors
- Front wheels measure 18" x 3.5"
- Rear wheels measure 18" x 8.5" or 18" x 10"
- Made in the U.S.A.

FITS MODEL	TORQUE	DOMINO	CARTEL	SUG. RETAIL
Front	0201-1162	0201-1163	0201-0605	\$1,249.95
Rear, 18" x 8.5"	0202-1287	0202-1288	0202-0608	1,599.95
18" x 10"	0202-1289	0202-1290	0202-0612	1,699.95

Warning: When selecting custom wheels, the tires used for your application must have a load index and speed rating equal to or greater than the tires fitted as original equipment. Consult manufacturer's publication(s) and/or website(s) for complete tire information.

All part numbers in **BOLD MAGENTA** are new this year.

CRUISER ACCESSORIES

- EXHAUST
- TIRES & ACCESSORIES
- LUGGAGE
- SPORTBIKE ACCESSORIES
- CRUISER ACCESSORIES**
- TOURING ACCESSORIES
- SECURITY & AUDIO
- GENERAL ACCESSORIES
- FAIRINGS & BODY
- SEATS
- HANDLEBARS & CONTROLS
- LIGHTING

Imperial Front



Calypso Front



Savage Front



Czar Front



Imperial Rear



Calypso Rear



Savage Rear

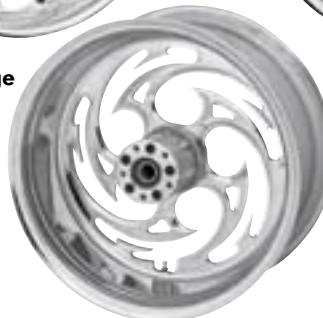

Czar Rear



CHROME FORGED WHEELS

- Made from the highest quality forged aluminum available to create a strong and durable wheel
- Each wheel is CNC-machined and quality tested to ensure the finest product possible
- Available in four styles: Imperial, Calypso, Savage and Czar
- Front wheels measure 18" x 3.5"
- Rear wheels measure 18" x 5.5", except where noted
- Honda and Yamaha applications require the use of a brake adapter to run the stock rear rotor; see chart for applications
- Pulley bolts are required to mount wheels to Yamaha applications
- Matching belt pulleys and brake rotors available when applicable
- Applications for most popular models
- RC pulley bolts required for Yamaha applications
- Made in the U.S.A.

FRONT WHEELS

FITS MODEL	IMPERIAL	CALYPSO	SAVAGE	CZAR	SUG. RETAIL
HONDA					
VTX 1300C 03-07, 18" x 3.5"	0201-1180¹	0201-1166¹	0201-1185¹	0201-0636¹	\$1,196.95
VTX 1300R/S 03-07, 18" x 3.5"	0201-1180¹	0201-1166¹	0201-1185¹	0201-0636¹	1,196.95
VTX 1800 02-07, 18" x 3.5"	0201-1181¹	0201-1167¹	0201-1186¹	0201-0637¹	1,196.95
SUZUKI					
M-109 06-07, 18" x 3.5"	0201-1184	0201-1170	0201-0641	0201-0640	1,196.95
YAMAHA					
1100 V-Star 00-06, 18" x 3.5"	0201-1182²	0201-1168²	0201-1187²	0201-0638²	1,196.95
XV1600/1700 99-07, 18" x 3.5"	0201-1183²	0201-1169²	0201-1188²	0201-0639²	1,196.95
XV1900XC Raider, 21" X 3.5"	0201-1190¹	0201-1191¹	0201-1189¹	0201-1192¹	1,236.95

¹ Requires the use of RC Components rotors.

² Requires the use of model specific brake adapter when using the stock rotor.

REAR WHEELS

FITS MODEL	IMPERIAL	CALYPSO	SAVAGE	CZAR	SUG. RETAIL
HONDA					
VTX 1300/1800 02-07, 18" x 5.5"	0202-1350^{1,2}	0202-1344^{1,2}	0202-1356^{1,2}	0202-0646^{1,2}	\$1,325.95
VTX 1300/1800 02-07, 18" x 8.5"	0202-1351^{1,2}	0202-1345^{1,2}	0202-1357^{1,2}	0202-0647^{1,2}	1,676.95
SUZUKI					
M-109 06-07, 18" x 8.5"	0202-1354	0202-1348	0202-0652	0202-0650	1,676.95
M-109 280 Tire, 18" x 10.0"	0202-1355	0202-1349	0202-0653	0202-0651	1,876.95
YAMAHA					
1100 V-Star 00-06, 18" x 5.5"	0202-1352¹	0202-1346¹	0202-1358¹	0202-0648¹	1,325.95
XV1600/1700 99-08, 18" x 5.5"	0202-1353¹	0202-1347¹	0202-1359¹	0202-0649¹	1,196.95
XV1900XC Raider 08, 18" X 8.5"	0202-1361³	0202-1362³	0202-1360³	0202-1363³	1,545.95

¹ Requires the use of model specific brake adapter when using the stock rotor.

² Custom wide swingarm required for 18" x 8.5."

³ Must use RC pulley and rotor.

BRAKE ADAPTERS

FITS MODEL	PART #	SUG. RETAIL	FITS MODEL	PART #	SUG. RETAIL
FRONT ADAPTERS			REAR ADAPTERS (CONT)		
YAMAHA					
V-Star 1100, XV1600/1700 99-07,			1100 V-Star 00-06	1701-0291	\$61.95
XV1700 Warrior 02-05	1701-0175	\$66.95	XV1600/1700 99-07, right	1701-0176	66.95
REAR ADAPTERS					
HONDA					
VTX 1800 02-07, w/ cast wheels	1701-0173	66.95	XV1700 Warrior 02-07, right	1701-0176	66.95
VTX 1300/1800 02-07, w/ spoke wheels (all)	1701-0174	66.95			

Warning: When selecting custom wheels, the tires used for your application must have a load index and speed rating equal to or greater than the tires fitted as original equipment. Consult manufacturer's publication(s) and/or website(s) for complete tire information.



Imperial



Calypso



Savage



Czar

CHROME PULLEYS

- Chrome-plated billet aluminum pulleys are CNC-machined and quality tested
- Available in four distinct styles: Imperial, Calypso, Savage and Czar
- Pulley bolts are required to mount RC Components wheels to Yamaha applications
- Made in the U.S.A.

SUG. RETAIL..... **\$495.95**

FITS MODEL	IMPERIAL	CALYPSO	SAVAGE	CZAR
YAMAHA				
Roadstar 00-03, 70T, 1 1/2"	1201-0405	1201-0335	1201-0404	1201-0285
Roadstar 04-07, 70T, 1 1/8"	1201-0407	1201-0336	1201-0406	1201-0286
XV1900XC Raider 08, 66T	1201-0459	1201-0460	1201-0458	1201-0457

PULLEY BOLTS

FITS MODEL	PART #	SUG. RETAIL
7/16" x 14 x 1 1/4"	2401-0312	\$12.95



Imperial



Calypso



Savage

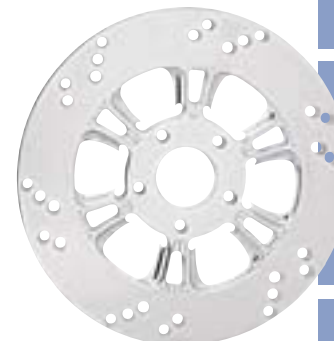

Czar

ONE-PIECE ROTORS

- One-piece polished stainless steel rotors
- Each brake rotor is CNC-machined and quality tested to ensure the finest product possible
- Front rotors fit left or right applications
- Rotors are cut to match RC Components Imperial, Calypso, Savage and Czar wheel designs
- Rotor bolts are required when using RC Components rotors (except Suzuki M-109 which uses stock bolts)
- Made in the U.S.A.

ROTOR BOLTS

DESCRIPTION	PART #	SUG. RETAIL
Front	2401-0313	\$10.95
Rear	2401-0314	10.95

FRONT

FITS MODEL	IMPERIAL	CALYPSO	SAVAGE	CZAR	SUG. RETAIL
HONDA					
VTX1300 02-06	1710-0576	1710-0577	1710-0575	1710-0402	\$275.95
VTX1800 02-07	1710-0522	1710-0425	1710-0521	1710-0381	265.95
SUZUKI					
M-109 06-07	1710-0578	1710-0579	1710-0397	1710-0396	275.95
YAMAHA					
Roadstar 02-05	1710-0530	1710-0430	1710-0529	1710-0384	265.95
Warrior 06-07	1710-0520	1710-0424	1710-0519	1710-0380	265.95
XV1900XC Raider 08	1710-0549	1710-0550	1710-0548	1710-0547	265.95

REAR

FITS MODEL	IMPERIAL	CALYPSO	SAVAGE	CZAR	SUG. RETAIL
HONDA					
VTX 1300 02-06	1710-0526	1710-0426	1710-0525	1710-0383	\$265.95
VTX 1800 02-07	1710-0573	1710-0574	1710-0572	1710-0400	275.95
YAMAHA					
T100 V-Star 00-06	1710-0558	1710-0557	1710-0555	1710-0556	265.95
XV1600/1700 99-08	1710-0560	1710-0561	1710-0559	1710-0394	275.95
XV1700 Warrior 06-08	1710-0554	1710-0553	1710-0551	1710-0552	265.95
XV1900XC Raider 08	1710-0573	1710-0574	1710-0572	1710-0400	275.95

Warning: When selecting custom wheels, the tires used for your application must have a load index and speed rating equal to or greater than the tires fitted as original equipment. Consult manufacturer's publication(s) and/or website(s) for complete tire information.

All part numbers in **BOLD MAGENTA** are new this year.

- EXHAUST
- TIRES & ACCESSORIES
- LUGGAGE
- SPORTBIKE ACCESSORIES
- CRUISER ACCESSORIES
- TOURING ACCESSORIES
- SECURITY & AUDIO
- GENERAL ACCESSORIES
- FAIRINGS & BODY
- SEATS
- HANDLEBARS & CONTROLS
- LIGHTING
- ELECTRICAL
- SPROCKETS
- CHAINS
- BRAKES
- SUSPENSION
- ENGINE
- FUEL SYSTEMS
- LUBES
- TOOLS
- TRAILER
- MERCH.
- CROSS REFERENCE
- INDEX

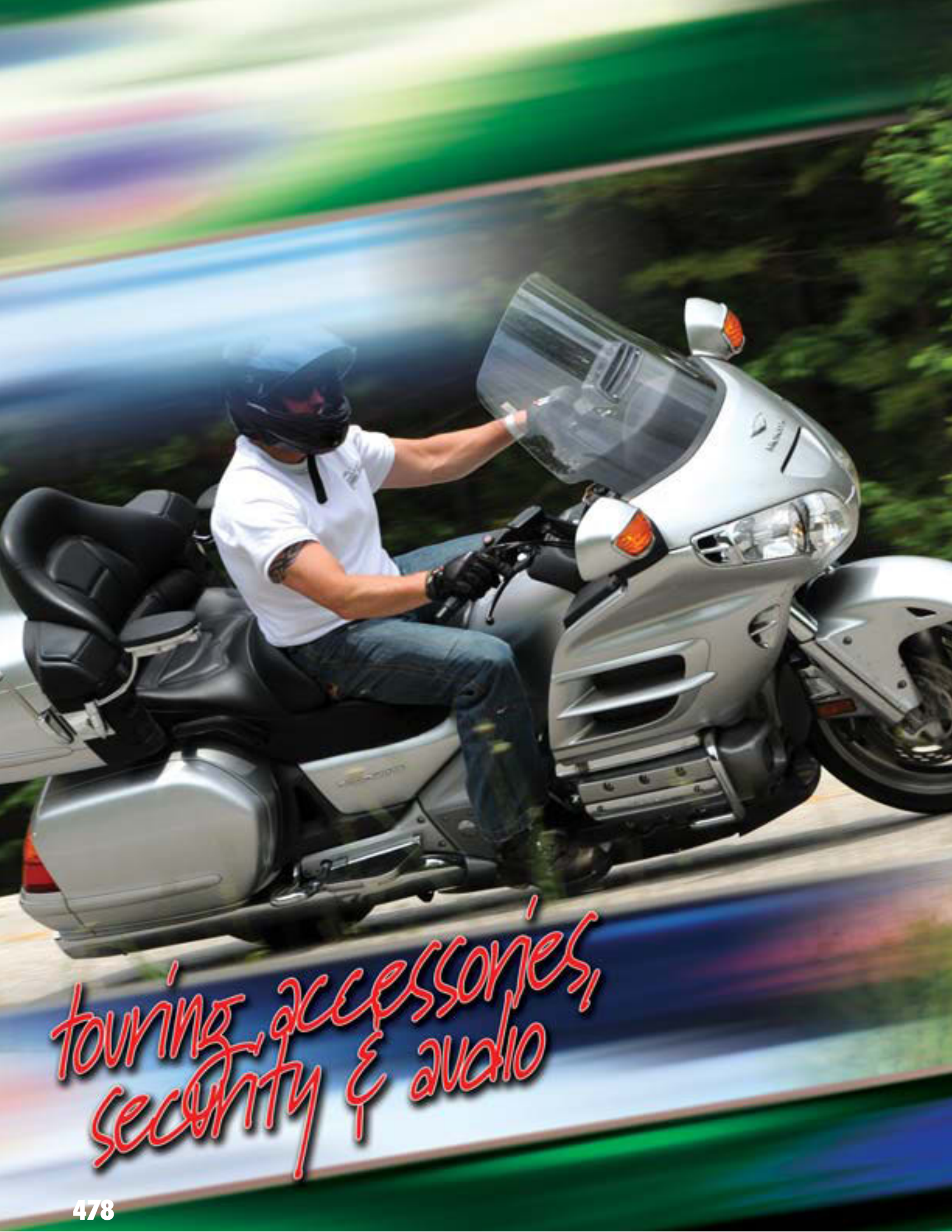

*touring accessories,
security & audio*



WINGLEADER® MIRROR HOUSINGS FOR HONDA GL1800 GOLD WING 01-08

- Chrome plastic mirror housings add a distinctive custom touch
- Designed to replace the OEM mirror housing
- Use stock mirror components
- Sold in pairs

SUG. RETAIL.....**\$74.95** PART # **0641-0058**



WINGLEADER® MIRROR ACCENTS FOR GL1800 GOLD WING 01-08

- Chromed plastic accents for turn signal side of mirror
- Install in minutes with adhesive tape (included)

SUG. RETAIL.....**\$29.95** PART # **1901-0025**



WINGLEADER® SADDLEBAG MOLDING FOR HONDA GL1800 GOLD WING 01-08

- Chrome-plated, injection-molded ABS plastic accents
- Adds style to GL1800 saddlebags

SUG. RETAIL.....**\$62.95** PART # **DS715086**



WINGLEADER® SADDLEBAG SCUFF COVERS FOR HONDA GL1800 GOLD WING 01-08

- Chrome cover keeps passenger's heels from scratching saddlebags
- Contour design means easy installation and a factory fit
- Sold in pairs

SUG. RETAIL.....**\$79.95** PART # **DS715088**



WINGLEADER® TRUNK KEY ACCENT FOR HONDA GL1800 GOLD WING 01-08

- Accent gives a custom look and protects from scratches
- Chrome finish
- Simple installation with included adhesive tape

SUG. RETAIL.....**\$11.95** PART # **0521-0615**



WINGLEADER® TRUNK HANDLE WITH LED FOR HONDA GL1800 GOLD WING 01-08

- Plastic chrome trunk handle provides extra lift support
- Red LEDs can be used as auxiliary running or brake lights
- Minor drilling required for installation
- Includes instructions and installation hardware

SUG. RETAIL.....**\$39.95** PART # **0521-0616**



WINGLEADER® MIRROR TRIM FOR HONDA GL1800 GOLD WING 01-08

- Add a custom touch
- Plastic with chrome finish
- Install quickly using included adhesive tape
- Sold in pairs

SUG. RETAIL.....**\$29.95** PART # **0641-0057**



WINGLEADER® WINDSHIELD ACCENT PANEL FOR HONDA GL1800 GOLD WING 01-08

- Chrome panel accents any paint scheme or other chrome items
- Install easily with OEM hardware

SUG. RETAIL.....**\$82.95** PART # **DS-710285**



All part numbers in **BOLD MAGENTA** are new this year.

- EXHAUST
- TIRES & ACCESSORIES
- LUGGAGE
- SPORTBIKE ACCESSORIES
- CRUISER ACCESSORIES
- TOURING ACCESSORIES
- SECURITY & AUDIO
- GENERAL ACCESSORIES
- FAIRINGS & BODY
- SEATS
- HANDLEBARS & CONTROLS
- LIGHTING
- ELECTRICAL
- SPROCKETS
- CHAINS
- BRAKES
- SUSPENSION
- ENGINE
- FUEL SYSTEMS
- LUBES
- TOOLS
- TRAILER
- MERCH.
- CROSS REFERENCE
- INDEX



- EXHAUST
- TIRES & ACCESSORIES
- LUGGAGE
- SPORTBIKE ACCESSORIES
- CRUISER ACCESSORIES
- TOURING ACCESSORIES
- SECURITY & AUDIO
- GENERAL ACCESSORIES
- FAIRINGS & BODY
- SEATS
- HANDLEBARS & CONTROLS
- LIGHTING
- ELECTRICAL
- SPROCKETS
- CHAINS
- BRAKES
- SUSPENSION
- ENGINE
- FUEL SYSTEMS
- LUBES
- TOOLS
- TRAILER
- MERCH.
- CROSS REFERENCE
- INDEX

WINGLEADER® LUGGAGE RACK BAG WITH SIDE POUCHES AND RAIN COVER



- 1000-denier Cordura® nylon construction
- Tear-resistant, water-repellent and won't stain or mildew
- Rain cover stows away in zippered compartment when not in use
- Hook-and-loop closure strip and nylon zippers
- Measures 22" L x 11" W x 10" H with 3 1/2" deep side pouches
- Black with silver piping
- Made in the U.S.A.

SUG. RETAIL.....\$129.95

PART # DS-110653

WINGLEADER® RADIO KNOB KIT FOR HONDA GL1800 GOLD WING 01-08



- Dress up the radio control area with these great looking custom knobs
- Replaces dull black OEM knobs with chrome

SUG. RETAIL.....\$4.95

PART # DS-719625

WINGLEADER® FUEL DOOR ACCENT FOR HONDA GL1800 01-08



- Great looking chrome accent adds a unique custom look
- Installs with included adhesive tape

NOTE: Not for use with airbag equipped models.

SUG. RETAIL.....\$18.95

PART # DS-719623



WINGLEADER® CHROME FRONT ROTOR COVERS FOR HONDA GL1800 GOLD WING 01-08

- Great looking rotor covers
- Help build a unique, custom look
- Sold in pairs

NOTE: Not for use with airbag equipped models.

SUG. RETAIL.....\$138.95

PART # DS376672

WINGLEADER® TOURBOX LUGGAGE RACK FOR HONDA GL1800 01-08

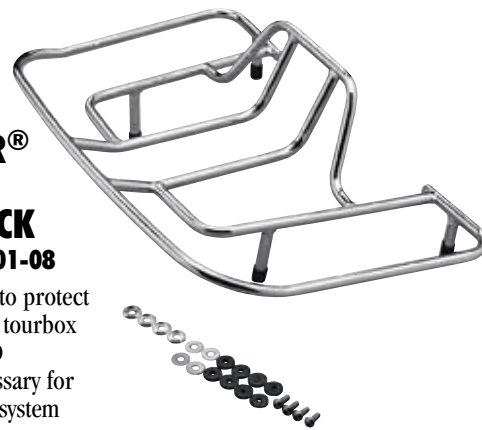

- Chrome rack with a rail to protect the raised portion of the tourbox
- Measures 22" W x 11" D
- Includes hardware necessary for the four-point mounting system

NOTE: Will not fit with spoiler.

SUG. RETAIL.....\$77.95

PART # DS710210

WINGLEADER® RADIO PANEL ACCENT FOR HONDA GL1800 GOLD WING 01-08



- Adds a custom look to the radio panel
- Plastic with a chrome finish
- Quick installation using included adhesive tape

NOTE: Not for airbag equipped models.

SUG. RETAIL.....\$39.95

PART # 2202-0057

WINGLEADER® RADIATOR GRILLES FOR HONDA GL1800 GOLD WING 06-08

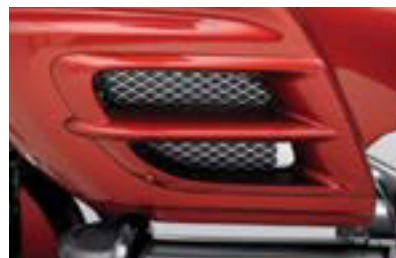

- Plastic radiator grilles with a brilliant chrome finish
- Replace the stock black grilles
- Sold in pairs

SUG. RETAIL.....\$62.95

PART # 0521-0618

WINGLEADER® CHROME 2" FRONT FENDER EXTENSION FOR HONDA GL1800 01-08



- Matches the look of the stock front fender
- Adds 2" to fender length
- Installs easily; all mounting hardware included

NOTE: Check clearance with lower cowl.

SUG. RETAIL.....\$24.95

PART # DS393647



WINGLEADER® CHROME FRONT LOWER COWL

FOR HONDA GL1800 01-08

- Chrome-plated ABS cowl replaces stock cowl
- Mounts with OEM hardware

SUG. RETAIL.....**\$129.95**

PART # **DS708534**



WINGLEADER® SWINGARM PIVOT COVERS FOR HONDA GL1800 GOLD WING 01-08

- Plastic, chrome covers replace existing dull covers
- Accent frame and other Wingleader products
- Install in minutes with OEM hardware

SUG. RETAIL.....**\$37.95**

PART # **DS375590**



WINGLEADER® REAR FENDER TRIM FOR HONDA GL1800 GOLD WING 01-08

- Chrome plastic fender trim adds a highlight
- Installs with included adhesive tape

SUG. RETAIL.....**\$29.95**

PART # **1405-0098**

WINGLEADER® CAM END COVERS

FOR HONDA
GL1500 GOLD WING 88-00

- Chrome replacement cam end cover set
- Offer an exact fit and impressive looks
- Sold in pairs

SUG. RETAIL.....**\$24.95**

PART # **DS-373935**



WINGLEADER® OFFSET ENGINE-GUARD CRUISE BOARDS

FOR GL1500 88-00

- Your best value for looks and comfort
- No need to drill unsightly holes in expensive OEM engine guards
- Unique mounting system allows full adjustability fore and aft to accommodate tall and short riders
- Brackets offset away from motorcycle to ensure rider's legs do not make contact with fairing
- Work with or without OEM-style valve covers with vents
- Trim plates and all necessary hardware included
- Available in chrome; sold in pairs



CRUISE BOARDS

DESCRIPTION	PART #	SUG. RETAIL
Chrome, GL1500 98-00	DS-720221	\$139.95
Chrome, GL1500 88-97	DS-720208	139.95

REPLACEMENT COMPONENTS AND ACCESSORIES

DESCRIPTION	PART #	SUG. RETAIL
Repl. rubber pads (pr.)	DS-720213	\$11.95
Repl. hose clamp (ea.)	DS-720207	1.55
Repl. saddle bracket for clamps for GL1500 88-97	DS-720209	7.95

All part numbers in **BOLD MAGENTA** are new this year.

WINGLEADER® MUD FLAP WITH LIGHTS

FOR HONDA GL1500 88-00 MODELS

- Deluxe rear mud flap with lights
- Injection-molded flap designed for GL 1500 88-00 models, but fits other bikes
- Two Baron® Mini Twin marker lights with red lenses
- Chromed steel accent plate
- Chromed mud flap mounting strap, hardware and wiring
- Replacement red lens for Baron® Mini Twin light sold separately
- Made in the U.S.A.

SUG. RETAIL.....**\$84.95**

PART # **DS-393740**



WINGLEADER® HANDLEBAR DAMPERS

FOR HONDA GL1800 01-08

- Replace black OEM bar end weights with chrome
- Install in minutes with OEM hardware

SUG. RETAIL.....**\$24.95**

PART # **DS-273947**



WINGLEADER® CHROME DRIVER FOOTREST BRACKETS

FOR HONDA GL1800 GOLD WING 01-08

- Chrome brackets give unique, custom look
- Accents other Wingleader products
- Mounts in just minutes with OEM hardware
- Sold in pairs

SUG. RETAIL.....**\$76.95**

PART # **DS-720318**

EXHAUST

TIRES &
ACCESSORIES

LUGGAGE

SPORTBIKE
ACCESSORIES

CRUISER
ACCESSORIES

TOURING
ACCESSORIES

SECURITY
& AUDIO

GENERAL
ACCESSORIES

FAIRINGS
& BODY

SEATS

HANDLEBARS
& CONTROLS

LIGHTING

ELECTRICAL

SPROCKETS

CHAINS

BRAKES

SUSPENSION

ENGINE

FUEL SYSTEMS

LUBES

TOOLS

TRAILER

MERCH.

CROSS
REFERENCE

INDEX



- EXHAUST
- TIRES & ACCESSORIES
- LUGGAGE
- SPORTBIKE ACCESSORIES
- CRUISER ACCESSORIES
- TOURING ACCESSORIES
- SECURITY & AUDIO
- GENERAL ACCESSORIES
- FAIRINGS & BODY
- SEATS
- HANDLEBARS & CONTROLS
- LIGHTING
- ELECTRICAL
- SPROCKETS
- CHAINS
- BRAKES
- SUSPENSION
- ENGINE
- FUEL SYSTEMS
- LUBES
- TOOLS
- TRAILER
- MERCH.
- CROSS REFERENCE
- INDEX

WINGLEADER® FLOORBOARD ACCENT PANELS FOR HONDA GL1800 01-08



- Replace those dull painted covers behind the passenger floorboards
- These are brilliantly chrome-plated, injection-molded covers
- Easy to install; sold in pairs

SUG. RETAIL.....\$61.95 PART # DS325544



1904-0015



1904-0014

WINGLEADER® FOOTPEG KITS FOR HONDA GL1800 01-08

- Chrome, billet aluminum brackets and footpegs
- Adjust in seconds for several alternative foot positions
- Driver kit installs on OEM engine guards
- Passenger kit works in conjunction with OEM floorboards
- Include all necessary hardware for installation

DESCRIPTION	PART #	SUG. RETAIL
Driver	1904-0015	\$174.95
Passenger	1904-0014	129.95

WINGLEADER® MINI DRIVER'S FLOORBOARDS FOR HONDA GL1800 GOLD WING 01-08



- Provide more room than the OEM footrests
- Add style and comfort
- Chrome finish
- Install using OEM hardware
- Sold in pairs

SUG. RETAIL.....\$149.95 PART # 1621-0116

SADDLEBAG SIDE LIGHT SET FOR HONDA GL1500 88-00



DS-280821

- Replaces the stock reflectors found on the sides of GL1500 saddlebags
- Includes light panels and wiring

DESCRIPTION	PART #	SUG. RETAIL
Saddlebag side light set	DS-280821	\$74.95
Repl. red lens kit	2040-0345	22.95
Repl. bulbs (10-pk.)	DS-280325PK	.99(ea.)

WINGLEADER® PASSENGER FLOORBOARD UNDERCOVERS FOR HONDA GL1800 GOLD WING 01-08



- Chrome-plated ABS covers replace stock undercovers on passenger floorboards
- Simple installation uses OEM hardware
- Sold in pairs

SUG. RETAIL.....\$29.95 PART # DS720317

WINGLEADER® BRAKE PEDAL HEEL PIVOT PAD FOR GL 84-00



- Chrome heel pivot pad features a rubber pad and bolts around the rear pivot on Drag floorboards
- Provides a heel rest for added comfort when braking
- Fits the brake side of GL models equipped with any D.S. Aspencade-style or Wingleader driver floorboards (not economy models)
- Also fits any 1" dia. tubing

SUG. RETAIL.....\$5.95 PART # DS-720417



WINGLEADER® SADDLEBAG LIGHT GRILLES FOR HONDA GL1800 GOLD WING 01-05

- Plastic covers with a brilliant chrome finish
- Designed to adhere to the OEM saddlebag lights
- Install quickly using the included adhesive tape
- Sold in pairs

SUG. RETAIL.....\$44.95 PART # 2040-0466

TOURBOX LUGGAGE RACK FOR HONDA GL1500 GOLD WING 88-00



- Supports up to 10 lb. of weight or any of our great rack bags
- Will fit with or without OEM spoiler
- Measures 22" W x 11" D
- Complete with all necessary mounting hardware

PART # DS-710216 SUG. RETAIL.....\$77.95

All part numbers in **BOLD MAGENTA** are new this year.



SADDLEBAG LENS GRILLE SET

FOR HONDA GL1500 GOLD WING 88-00

- Fits stock saddlebag reflectors and Drag side light kits
- Installs easily with included adhesive tape and self-tapping screws

NOTE: Not to be used with OEM saddlebag side lighting kit.

SUG. RETAIL.....**\$61.95**



PART # DS-719706

SADDLEBAG/TOURBOX FLOOR MATS

FOR GL1500 88-00 GOLD WING

- Redesigned black carpet floor mats are easily held in place with hook-and-loop-type fastening
- Sold in complete sets for tourboxes and saddlebags

SUG. RETAIL.....**\$24.95**

PART # DS-710115



TRUNK MARKER LIGHT HARNESS

FOR HONDA GL1500 88-00

- Converts the tourbox side reflectors to running lights
- Plugs into existing lens

DESCRIPTION	PART #	SUG. RETAIL
Light harness	DS-280325	\$19.95
Repl. bulbs (10-pk.)	DS-280325-PK	.99 (ea.)



CB ANTENNA KIT

FOR HONDA GL1800 01-08

- Complete kit, includes 44" L antenna, mounting bracket and all necessary hardware

SUG. RETAIL.....**\$89.95**

PART # 2130-0006

TOURBOX LIGHT GRILLE SET

FOR HONDA GL1500 GOLD WING 88-00

- Chrome-plated to add a distinctive look to the stock lights and reflectors on the tourbox
- Attaches easily with small Phillips head screws and improved pressure-sensitive, automotive-grade adhesive foam tape



DS-719701

DESCRIPTION	PART #	SUG. RETAIL
For 88-97 models	DS-719701	\$54.95
For 98-00 models	DS-719702	53.95

DS-280820

BUMPER SADDLEBAG LIGHT

FOR HONDA GL1200/1500 GOLD WING 84-00

- Versatile light pod fits into center bumper panel on GL 88-00
- Can also be used as a side saddlebag light on Interstate and Aspencade 84-87 if clearance is made for sockets
- Replacement bulb for DS-280825 is PART #GE-67; replacement bulb for DS-280820 is PART #DS-282089-PK, available in Electrical section

NOTE: Not intended as OEM replacement on SE-i and Limited Edition models.

FITS MODEL	PART #	SUG. RETAIL
GL1200 84-87	DS-280820	\$24.95
GL1500 88-00	DS-280825	25.95



DS-280825

CB ACCENT

FOR HONDA GL1800 GOLD WING 01-08

- Chrome-plated accent panel is easy to install

SUG. RETAIL.....**\$19.95**

PART # 0616-0050



CHROME RADIO KNOB SET

FOR HONDA GL1500 GOLD WING 88-00

- Dress up that radio system with these chrome knob replacements
- Simply pull off the colored knobs and replace them with these custom-looking knobs
- Knobs fit specific shafts – note flat portion of shaft as compared to black dot on knob

SUG. RETAIL.....**\$18.95**

PART # DS-719926



All part numbers in **BOLD MAGENTA** are new this year.

EXHAUST

TIRES & ACCESSORIES

LUGGAGE

SPORTBIKE ACCESSORIES

CRUISER ACCESSORIES

TOURING ACCESSORIES

SECURITY & AUDIO

GENERAL ACCESSORIES

FAIRINGS & BODY

SEATS

HANDLEBARS & CONTROLS

LIGHTING

ELECTRICAL

SPROCKETS

CHAINS

BRAKES

SUSPENSION

ENGINE

FUEL SYSTEMS

LUBES

TOOLS

TRAILER

MERCH.

CROSS REFERENCE

INDEX



- EXHAUST
- TIRES & ACCESSORIES
- LUGGAGE
- SPORTBIKE ACCESSORIES
- CRUISER ACCESSORIES
- TOURING ACCESSORIES
- SECURITY & AUDIO
- GENERAL ACCESSORIES
- FAIRINGS & BODY
- SEATS
- HANDLEBARS & CONTROLS
- LIGHTING
- ELECTRICAL
- SPROCKETS
- CHAINS
- BRAKES
- SUSPENSION
- ENGINE
- FUEL SYSTEMS
- LUBES
- TOOLS
- TRAILER
- MERCH.
- CROSS REFERENCE
- INDEX



FRONT SPEAKER ACCENT TRIM FOR HONDA GL1500 GOLD WING 88-00

- Trim outlines speaker grilles perfectly
- Attaches easily with two-sided tape (included)
- Sold in pairs



SUG. RETAIL.....\$30.95

PART # DS-719991

DASH TOP ACCENTS FOR HONDA GL1500 GOLD WING 88-00

- Chrome, two-piece dash top accents outline the emblem below the ignition key and follow top of dash to radio
- Installed with special adhesive tape (included)
- Sold in sets

SUG. RETAIL.....\$17.95

PART # DS-719862



AIR PRESSURE CONTROL ACCENT FOR HONDA GL1500 GOLD WING 88-00

- Distinctively chromed air pressure control accent
- Easily installed with included two-sided tape

SUG. RETAIL.....\$13.95

PART # DS-719935

FUEL DOOR ACCENT TRIM FOR HONDA GL1500 GOLD WING 88-00

- Chrome accent trim is an eye-catching addition to the top of the fuel door
- Follows top of the gas tank beautifully
- Mounts easily with included two-sided tape

SUG. RETAIL.....\$17.95

PART # DS-719835



4405-0129



4405-0130



SPEAKER GRILLES

FOR HONDA GL1800 GOLD WING 06-08

- Chrome-plated speaker grilles for front or rear speakers
- Mount using included two-sided adhesive tape
- Sold in pairs

SUG. RETAIL.....\$29.95

DESCRIPTION	PART #
Front speaker grilles (pr.)	4405-0129
Rear speaker grilles (pr.)	4405-0130

GLOVE BOX ACCENT PLATE FOR HONDA GL1500 GOLD WING 88-00

- Chromed glove box accent plate adds a touch of class
- Right-side accent attaches to OEM cover
- Includes all mounting hardware

SUG. RETAIL.....\$25.95



PART # DS-719875



WINGLEADER® IGNITION KEY ACCENT FOR HONDA GL1800 GOLD WING 01-08

- Plastic with a chrome finish
- Adds a custom look
- Installs with included adhesive tape

SUG. RETAIL.....\$11.95

PART # 2202-0056

BRAKE SWITCH BOX FOR HONDA GL1500 GOLD WING 88-00

- Chrome box highlights the switches on the brake lever side
- Includes four red rocker switches, plus complete wiring
- Red replacement rocker switch PART #DS-272147 available separately

SUG. RETAIL.....\$31.95

PART # DS-373775





REPLACEMENT FAIRING MIRRORS FOR GL 84-87

- Redesigned left- and right-side replacement mirrors match stock mirrors
- Each comes with two satin-finish backing plates
- All the customer has to do is install the backing plates
- A pair with matching plates can also be used to replace both mirrors on GL 84 models

DESCRIPTION	PART #
Left-side repl. mirror	DS-302079

SUG. RETAIL.....\$46.95

DESCRIPTION	PART #
Right-side repl. mirror	DS-302080

SWITCH PANEL FOR HONDA GL1500 GOLD WING 88-00

- Chrome knock-out panel comes complete with four illuminated rocker switches and a cigarette lighter
 - Makes a grand touring addition
- NOTE:** Cannot use switch panel on models with factory CB system.

SUG. RETAIL.....\$32.95

PART #	DS-719805
--------	-----------



CORNERING LIGHTS FOR HONDA GL1500 88-97

- Replace the knock-out panels in the right and left fairing lowers
- Turn on when the blinker is used; not recommended for running lights
- Plug into the existing wire harness
- All wiring and mounting hardware is included
- Replacement bulb PART #A7025-BP available; see Electrical section

SUG. RETAIL.....\$58.95



PART #	DS-280780
--------	-----------



SHARK GILLS™ FOR HONDA GL1500 GOLD WING 88-00

- Designed specifically to mount in front of the lower fairing air exit vents
- Sold in pairs

All part numbers in **BOLD MAGENTA** are new this year.



SUG. RETAIL.....\$21.95

PART #	DS-715098
--------	-----------



SNAP-IN CHROME FAIRING VENT GRILLES FOR HONDA GOLD WING 85-87

- Gleaming chrome-plated left- and right-vent grilles offer custom looks
- Great looking and easy to install – simply remove OEM grilles with a flat screwdriver and snap these into place
- Allow airflow through a series of rectangular perforations
- Sold in pairs

SUG. RETAIL.....\$34.95

PART #	DS-715096
--------	-----------



FAIRING MARKER LIGHT HARNESS FOR HONDA GL1500 GOLD WING 88-00

- Converts the fairing side reflectors to running lights
- Replacement bulb PART # DS-280508-PK available separately; see Electrical section
- Sold in pairs

SUG. RETAIL.....\$11.95

PART #	DS-280320
--------	-----------

WINGLEADER® CLEAR LED TURN SIGNAL LENSES

FOR HONDA GL1800
GOLD WING 01-08

- Clear plastic lenses replace OEM lenses
- Amber LED bulbs included
- Sold in pairs

SUG. RETAIL.....\$39.95



PART #	2020-0379
--------	-----------

DS-280807



FAIRING MARKER LIGHT SET FOR HONDA GL1200 GOLD WING 84-87

- Kit includes two marker lights with injection-molded amber lenses
- 12V set provides additional visibility
- Replaces the fairing side reflectors on Interstate and Aspencade 84-87 (will not fit SE-i or Limited Edition)
- Can also be used on the fairings of many other motorcycles
- Wiring harness included

DESCRIPTION	PART #	SUG. RETAIL
Fairing side marker light set	DS-280807	\$16.95
Repl. amber lens	DS-280808	3.95

EXHAUST

TIRES & ACCESSORIES

LUGGAGE

SPORTBIKE ACCESSORIES

CRUISER ACCESSORIES

TOURING ACCESSORIES

SECURITY & AUDIO

GENERAL ACCESSORIES

FAIRINGS & BODY

SEATS

HANDLEBARS & CONTROLS

LIGHTING

ELECTRICAL

SPROCKETS

CHAIN

BRAKES

SUSPENSION

ENGINE

FUEL SYSTEMS

LUBES

TOOLS

TRAILER

MERCH.

CROSS REFERENCE

INDEX



- EXHAUST
- TIRES & ACCESSORIES
- LUGGAGE
- SPORTBIKE ACCESSORIES
- CRUISER ACCESSORIES
- TOURING ACCESSORIES
- SECURITY & AUDIO
- GENERAL ACCESSORIES
- FAIRINGS & BODY
- SEATS
- HANDLEBARS & CONTROLS
- LIGHTING
- ELECTRICAL
- SPROCKETS
- CHAINS
- BRAKES
- SUSPENSION
- ENGINE
- FUEL SYSTEMS
- LUBES
- TOOLS
- TRAILER
- MERCH.
- CROSS REFERENCE
- INDEX



FAIRING AIR EXIT LOUVERS FOR HONDA GL1500 88-97

- Fit over the OEM black vents in the fairing side air exits
- Mount easily with the stock hardware
- Completely chrome-plated
- Sold in pairs

SUG. RETAIL.....\$27.95 PART # DS-719845



WINGLEADER® FORK REFLECTOR GRILLES FOR HONDA GL1800 GOLD WING 01-08

- Designed to install over the OEM fork reflectors
- Plastic with a chrome finish
- Install with included adhesive tape
- Sold in pairs

SUG. RETAIL.....\$14.95 PART # 2040-0465



CHROME FRONT FENDER EXTENSION FOR HONDA GL1500 GOLD WING 88-00

- Matches the look of stock front fenders
- Installs easily and comes complete with all necessary mounting hardware

NOTE: Check clearance with lower cowl.

SUG. RETAIL.....\$26.95 PART # DS-393645



FAIRING SIDELIGHT LENS GRILLES FOR HONDA GL1500 GOLD WING 88-00

- Come with screw-on hardware and chrome snap caps
- Add exceptional looks to the fairing
- Sold in pairs

SUG. RETAIL.....\$35.95 PART # DS-719891

LATE-STYLE ROTOR COVERS FOR HONDA GL1500 GOLD WING 88-00

FOR HONDA GL1500 GOLD WING 88-00

- Identical-look replacement for GL1500 98-00 OEM covers
- Updates the look of GL1500 88-97
- Sold as a set

SUG. RETAIL.....\$105.95 PART # DS-376664



FRAME COVER FOR HONDA GL1800 GOLD WING 01-08

FOR HONDA GL1800 GOLD WING 01-08

- Injection-molded plastic with a flawless chrome-plated finish
- Adds a spark of chrome to your GL1800's frame
- Attaches using double-sided adhesive tape (order separately), no drilling required

SUG. RETAIL.....\$84.95 PART # 0504-0017



RADIATOR ACCENTS FOR HONDA GL1800 01-05

- Chrome-plated ABS accent adds a bright touch to the radiator air inlet
- No tools necessary for installation; includes double-sided tape
- Sold in pairs

SUG. RETAIL.....\$129.95 PART # 0521-0197



EXHAUST

TIRES & ACCESSORIES

LUGGAGE

SPORTBIKE ACCESSORIES

CRUISER ACCESSORIES

TOURING ACCESSORIES

SECURITY & AUDIO

GENERAL ACCESSORIES

FAIRINGS & BODY

SEATS

HANDLEBARS & CONTROLS

LIGHTING

ELECTRICAL

SPROCKETS

CHAINS

BRAKES

SUSPENSION

ENGINE

FUEL SYSTEMS

LUBES

TOOLS

TRAILER

MERCH.

CROSS REFERENCE

INDEX



RADIATOR GRILLE FOR HONDA GL1500 GOLD WING 88-00

- Chromed-steel radiator grille adds a touch of class to the front
- Complete with all necessary mounting hardware and instructions

SUG. RETAIL.....**\$61.95** PART # DS-719980



FAIRING SIDE ACCENTS FOR HONDA GL1800 GOLD WING 01-08

- Chrome accents complement any paint scheme
- Easy installation – no tools required
- Sold in pairs

SUG. RETAIL.....**\$54.95** PART # DS719804

REVERSE LEVER ACCENTS FOR HONDA GL1500 GOLD WING 88-00

- Perfectly formed chrome accent covers fit easily over reverse lever
- Sold each

FITS MODEL	PART #	SUG. RETAIL
GL1500 88-89	DS-719887	\$15.95
GL1500 90-00	DS-719886	14.95



DS-719886

CHROME KICKSTAND FOR HONDA GL1500 GOLD WING

- Highly polished, chrome plated
- Replaces the plain original
- Complete with chrome hardware and spring

NOTE: Kickstands are designed to support the motorcycle only. Over-stressing by sitting on motorcycle while supported by kickstand may lead to kickstand failure.

SUG. RETAIL.....**\$46.95** PART # DS240209



DASH SIDE ACCENTS FOR HONDA GL1500 GOLD WING 88-00

- Right and left chrome dash side accents fit on raised area of each side of the radio/cassette player
- Installed with special adhesive tape
- Sold in pairs

SUG. RETAIL.....**\$25.95** PART # DS-719863

GAS TANK SIDE TRIMS FOR HONDA GL1500 GOLD WING 88-00

- Perfectly formed chrome side trims fit along lower angled edge of gas tank and fairing lower
- Special tape holds trims in place and complements our lower fairing exit vent trims PART #DS-719811

SUG. RETAIL.....**\$31.95** PART # DS-719889



MODERN-STYLE FAIRING WIND DEFLECTORS

FOR HONDA GL500/650/1100/1200 GOLD WING 80-87

- Sculptured wind deflectors feature chrome hardware and smoked acrylic wings
- Adjustable to direct air flow in any direction
- Designed to fit stock fairing
- Sold in pairs

SUG. RETAIL.....**\$49.95** PART # DS-710355

All part numbers in **BOLD MAGENTA** are new this year.





FAIRING WIND DEFLECTORS

FOR HONDA GL1200 84-87

- Fully adjustable wind deflectors mount to the edge of the stock fairing on Interstate, Aspencade, SE-i and Limited Edition 84-87 models
- Made of acrylic and can be easily positioned by hand to direct air flow wherever it's desired
- A very economical alternative to enduring the elements
- Each includes all necessary chromed-steel mounting brackets
- Sold in pairs

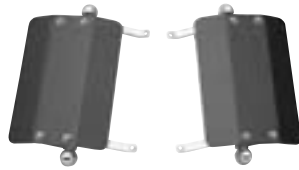

DS-710350

DESCRIPTION	PART #	SUG. RETAIL
Wind deflectors (w/ chrome balls)	DS-710350	\$47.95
Repl. std. deflector only (ea.)	DS-710351	8.95

E-Z WIND DEFLECTORS

FOR HONDA GL1500 GOLD WING 88-00

- Sculptured wind deflectors feature chrome hardware and smoked acrylic wings
- May be adjusted to direct airflow to cool the rider and passenger on hot days or to deflect the wind entirely on cold days
- Sold in pairs

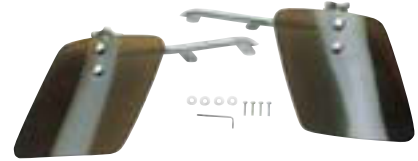

SUG. RETAIL..... **\$44.95**

PART # **DS-710357**

CHROME DRIVER FLOORBOARDS

FOR HONDA GL GOLD WING 75-83

- Floorboard set is made of heavy-gauge steel and features a heel-toe shifter
- Sold in pairs



DS-720232

DESCRIPTION	PART #	SUG. RETAIL
Floorboard set	DS-720232	\$134.95
Repl. pads (pr.)	DS-720281	10.95

ELEVATED PASSENGER FLOORBOARDS

FOR GL 84-87

- Vertically adjustable mounts offer three different riding positions for the passenger
- Mount onto front saddlebag guards to allow passengers to move their feet farther away from hot exhaust pipes
- Match the styling on existing Drag Specialties or stock Honda boards
- Built-in guides lock the boards horizontally, preventing unwanted rotation
- Die-cast aluminum boards with chrome trim feature real EPDM rubber pads
- Available in chrome
- All mounting hardware included; sold in pairs



NOTE: Not intended to be used for boarding motorcycle.

WARNING: All floorboards reduce cornering clearance.

DESCRIPTION	PART #	SUG. RETAIL
Passenger boards	DS-720200	\$102.95
Repl. rubber pads (pr.)	DS-720211	11.95

ENGINE-GUARD CRUISE BOARDS

FOR HONDA GL 80-87, SUZUKI CAVALCADE 86-89

- No other boards on the market even come close!
- Two optional mounting brackets work with all GL 80-87 equipped with OEM case guards
- Each set of brackets may be adjusted to accommodate tall or short riders
- Easy flip-up design with a positive locking mechanism holds boards in up or down position
- Real EPDM rubber inserts match the OEM Aspencade pattern (unlike the hard plastic used by many others)
- One part number fits all GL 80-87 and Suzuki GV1400 Cavalcade 86-89
- Available in chrome plated (die-cast rather than sand-cast) and with chromed bottom trim plates for that finishing touch
- Include all hardware; sold in pairs



DS-720215

DESCRIPTION	PART #	SUG. RETAIL
Chrome engine-guard cruise boards	DS-720215	\$139.95
Repl. rubber pads (pr.)	DS-720211	11.95

TRAILER WIRE HARNESS

FOR HONDA GL1800 GOLD WING 01-08

- Easy plug-in installation requires no wire cutting or splicing
- Avoids flasher and fuse overloads by isolating the trailer lights from the main vehicle electrical system
- Comes with all necessary installation hardware and detailed instructions



2120-0021

DESCRIPTION	PART #	SUG. RETAIL
For models w/ ABS	2120-0021	\$31.95
For models w/o ABS	2120-0249	14.95



0521-0613

0521-0614

WINGLEADER® SIDE COVER GROMMETS

- Replace OE rubber grommets
- Sold in 10-pk.

SUG. RETAIL (ea.)..... **\$.95**

DESCRIPTION	PART #
Round (repl. OEM #83504-GE0-000)	0521-0613
Oval (repl. OEM #83551-GE2-000)	0521-0614

All part numbers in **BOLD MAGENTA** are new this year.



DUAL TURNDOWN EXHAUST EXTENSION

FOR HONDA GL1800 GOLD WING 01-09

- Really dresses the rear of your motorcycle
- Fits models with or without OEM saddlebag spoiler or deluxe saddlebag and lightbar
- Large 5" diameter turndown tips
- Easy installation; all hardware included

SUG. RETAIL.....**\$156.95**

PART # **DS200976**



CHROME WINDSHIELD GARNISH

FOR HONDA GL1800 GOLD WING 01-09

- Replaces OEM color-matched garnish

SUG. RETAIL.....**\$146.95**

PART # **2331-0017**



LED WINDSHIELD GARNISH

FOR HONDA GL1800 GOLD WING 01-09

- Mounts above the opening inside the windshield garnish
- Features 13 LEDs inside a plastic housing
- Mounts with double-sided tape (included)

SUG. RETAIL.....**\$38.95**



FITS MODEL	PART #
GL1800 01-05	2040-0166
GL1800 06-09	2040-0350

SADDLEBAG TAILLIGHTS WITH TURN SIGNALS

FOR HONDA GL1500 GOLD WING 98-00

- Convert rear taillight/brake light to taillight/brake light with turn signals
- Match the turn signal in the tourbox
- Make turn signals more visible from the rear
- Easy installation; plugs into taillight/brake light in OEM wiring; simple one-wire connection to turn signal in tourbox

SUG. RETAIL.....**\$202.95**

PART # **DS-280831**



DS-710120



BB52690

TOURBOX CUBBYHOLDS®

FOR HONDA GL1500/1800 GOLD WING

- Made of clear acrylic plastic
- Mount to existing screw holes
- Helps organize inside of tourbox
- Sold in pairs

SUG. RETAIL.....**\$25.95**

FITS MODEL	PART #
HONDA	
GL1500 88-00	DS-710120
GL1800 01-09	BB52690

All part numbers in **BOLD MAGENTA** are new this year.

LENS GRILLE FOR MARKER LIGHTS

- Chromed ABS grille fits K.D.- and Peterson-type saddlebags or GL1200 marker lights
- Includes chrome-plated fasteners

SUG. RETAIL.....**\$8.95**



PART # **DS-719998**

SIX-LIGHT SADDLEBAG SIDE LIGHT SET

FOR HONDA GL1500 GOLD WING 88-00

- Replace OEM reflectors
- Bulbs are mounted on circuit boards; easily changeable

SUG. RETAIL.....**\$96.95**



PART # **2040-0165**

LIGHTED REAR MUDFLAP

FOR HONDA GL1500 GOLD WING 98-00, GL1800 01-09

- Easily installs between stock exhaust pipes or aftermarket doubles/triples
- Can be used as running light or auxiliary brake light

SUG. RETAIL.....**\$92.95**



PART # **1420-0027**

EXHAUST

TIRES & ACCESSORIES

LUGGAGE

SPORTBIKE ACCESSORIES

CRUISER ACCESSORIES

TOURING ACCESSORIES

SECURITY & AUDIO

GENERAL ACCESSORIES

FAIRINGS & BODY

SEATS

HANDLEBARS & CONTROLS

LIGHTING

ELECTRICAL

SPROCKETS

CHAINS

BRAKES

SUSPENSION

ENGINE

FUEL SYSTEMS

LUBES

TOOLS

TRAILER

MERCH.

CROSS REFERENCE

INDEX



EXHAUST

TIRES & ACCESSORIES

LUGGAGE

SPORTBIKE ACCESSORIES

CRUISER ACCESSORIES

TOURING ACCESSORIES

SECURITY & AUDIO

GENERAL ACCESSORIES

FAIRINGS & BODY

SEATS

HANDLEBARS & CONTROLS

LIGHTING

ELECTRICAL

SPROCKETS

CHAINS

BRAKES

SUSPENSION

ENGINE

FUEL SYSTEMS

LUBES

TOOLS

TRAILER

MERCH.

CROSS REFERENCE

INDEX

CHROME KEY PLATE

- Chrome-plated ABS construction
- Features rubber scuff-pad

SUG. RETAIL.....\$22.95



FITS MODEL	PART #
HONDA	
GL1800 Gold Wing 01-05	0521-0305

FITS MODEL	PART #
HONDA (CONT)	
GL1800 Gold Wing 06-09	0521-0306



MEDALLION SERIES™ KEY PLATE ACCENTS FOR HONDA GL1800 GOLD WING 01-09

- ABS accent fits around trunk key hole
- Chrome edge with either gold or black insert
- Attaches with double-sided tape

DESCRIPTION	PART #	SUG. RETAIL
Gold insert	2202-0013	\$28.95
Black insert	2202-0071	17.95



CUBBYNETS™ LID ORGANIZERS FOR HONDA GL1500 GOLD WING 88-00

- Cargo nets attach to the saddlebag or tourbox lid
- Create a secure place to store various items, especially covers, rainsuits, etc.
- Allow easy access without unloading the saddlebag or tourbox
- Saddlebag organizers sold in pairs; tourbox organizers sold each

DESCRIPTION	PART #	SUG. RETAIL
Tourbox lid net	DS-710121	\$7.95
Saddlebag lid nets	DS-710131	8.95



INSTRUMENT PANEL ACCENT FOR HONDA GL1500 GOLD WING 88-00

- Chrome accent adds a finishing touch to the instrument panel
- Installs easily with double-sided tape and screws (included)

SUG. RETAIL.....\$28.95 PART # DS-719822

FUEL DOOR ACCENT TRIM

- Enhances look of fuel door
- Outlines door and encircles keyhole
- Mounts easily with double-sided adhesive tape



SUG. RETAIL.....\$26.95

FITS MODEL	PART #
HONDA	
GL1800 Gold Wing 01-09 (except airbag models)	BB-52-629
GL1800 Gold Wing 01-08 airbag models	0521-0626



CONTROL PANEL ACCENT FOR HONDA GL1800 GOLD WING 01-08

- Left- and right-side, stamped-steel chrome control panel accents
- Attach with double-sided tape

FITS MODEL	DESCRIPTION	PART #	SUG. RETAIL
GL1800 01-05	Left-side panel	2201-0017	\$32.95
	Right-side panel	2201-0018 ¹	32.95
GL1800 06-09 w/ navigation system (except airbag models)	Right-side panel	2120-0147	35.95
GL1800 06-08 w/ navigation system and airbag	Right-side panel	2201-0058	35.95

¹ Does not fit models with navigation system.

TRUNK CARGO NET

FOR HONDA GL1800 GOLD WING 01-09

- Corded, elastic net provides more trunk storage
- Easily attaches to existing screw holes in front or back of trunk



SUG. RETAIL.....\$10.95 PART # 3502-0046



CHROME INSTRUMENT PANEL ACCENT FOR HONDA GL1800 GOLD WING 01-05

- Mounts over the black plastic OEM piece to provide instant character and definition to the gauge area
- Attaches quickly and securely with double-sided adhesive tape

SUG. RETAIL.....\$35.95 PART # BB-52-647

All part numbers in **BOLD MAGENTA** are new this year.



CONTOUR SERIES SPEAKER ACCENTS

- Chrome-plated ABS accents offer a custom shine and enhance the Gold Wing's classic lines
- Install easily with included double-sided tape
- Sold in pairs

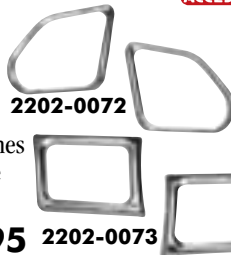

SUG. RETAIL.....\$44.95 2202-0073

FITS MODEL	FRONT PART #	REAR PART #
GL1800 Gold Wing 01-05	2202-0072	2202-0073



FITS MODEL	FRONT PART #	REAR PART #
GL1800 Gold Wing 06-09	2202-0074	2202-0075

CHROME REAR SPEAKER GRILLES

**FOR HONDA GL1500
GOLD WING 88-00**

- Chrome ABS grilles replace OEM grilles
- Slotted design will work with or without speakers
- Sold as a pair



SUG. RETAIL.....\$32.95 PART # DS-719923

CHROME KILL SWITCH COVERS

FOR HONDA GOLD WING

- Chrome-plated ABS covers add a finishing touch in seconds
- Mount with foam tape (included)
- Work on all Honda GL1500/1800 Gold Wing models
- Sold each

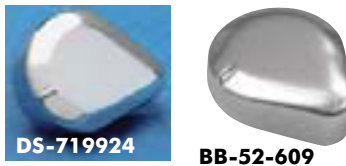

FITS MODEL	PART #	SUG. RETAIL
HONDA		
GL1500 88-00	DS-719924	\$11.95
GL1800 01-09	BB-52-609	10.95

CHROME FORK COVER CAP

**FOR HONDA GL1500A/I
GOLD WING ASPENCADE/SE 90-00**

- These ABS chrome caps replace the threaded OEM caps
- Sold in pairs



SUG. RETAIL.....\$11.95 PART # DS-720127

MASTER CYLINDER SWITCH BLOCK ASSEMBLIES

**FOR HONDA GL1500/
1800 GOLD WING 88-09**

- Houses three switches for auxiliary lighting controls
- Available with chrome or matte black finish



POSITION	FINISH	PART #	SUG. RETAIL
Clutch-side	Chrome	2106-0028	\$76.95
	Matte black	2106-0044	77.95
Brake-side	Chrome	BB-52-605	76.95



CHROME MIRRORS

FOR HONDA GL1500 GOLD WING 88-00

- Replace those scratched, painted mirrors today
- Exact OEM replacement
- Sold in pairs

SUG. RETAIL.....\$119.95 PART # DS-302078



CHROME MIRROR MOUNT COVERS

FOR HONDA GL1500 GOLD WING 88-00

- Covers replace the trim that holds the rubber boots on the mirrors
- Brilliant chrome plating matches any paint color
- Sold in pairs

SUG. RETAIL.....\$65.95 PART # DS-719922

LED MIRROR LIGHTS/ AUXILIARY TURN SIGNALS

**FOR HONDA GL1800
GOLD WING 01-08**

- Designed to give great side visibility without distracting rider
- Look like chrome-and-black mirror accents when not activated by turn signals
- Attach with double-sided adhesive tape



SUG. RETAIL.....\$62.95 PART # BB52649

MIRROR-BACK ACCENT GRILLES

**FOR HONDA GL1800
GOLD WING 01-09**

- Chrome ABS grilles outline the turn signal lens on the back of the side-view mirrors
- Attach with double-sided tape (included)
- Sold in pairs



SUG. RETAIL.....\$53.95 PART # 0641-0009

All part numbers in **BOLD MAGENTA** are new this year.

- EXHAUST
- TIRES & ACCESSORIES
- LUGGAGE
- SPORTBIKE ACCESSORIES
- CRUISER ACCESSORIES
- TOURING ACCESSORIES
- SECURITY & AUDIO
- GENERAL ACCESSORIES
- FAIRINGS & BODY
- SEATS
- HANDLEBARS & CONTROLS
- LIGHTING
- ELECTRICAL
- SPROCKETS
- CHAINS
- BRAKES
- SUSPENSION
- ENGINE
- FUEL SYSTEMS
- LUBES
- TOOLS
- TRAILER
- MERCH.
- CROSS REFERENCE
- INDEX



EXHAUST

TIRES & ACCESSORIES

LUGGAGE

SPORTBIKE ACCESSORIES

CRUISER ACCESSORIES

TOURING ACCESSORIES

SECURITY & AUDIO

GENERAL ACCESSORIES

FAIRINGS & BODY

SEATS

HANDLEBARS & CONTROLS

LIGHTING

ELECTRICAL

SPROCKETS

CHAINING

BRAKES

SUSPENSION

ENGINE

FUEL SYSTEMS

LUBES

TOOLS

TRAILER

MERCH.

CROSS REFERENCE

INDEX

LED VISORED MIRROR TRIM

FOR HONDA GL1800 GOLD WING 01-08

- Adds a touch of ABS chrome and LED to existing mirrors
- LEDs function with turn signals
- Available with red or amber LED
- Sold in pairs

SUG. RETAIL.....\$117.95



2040-0353

FITS MODEL	RED	AMBER
GL1800 01-05	2040-0180	2040-0356
GL1800 06-09	2040-0353	2040-0354



VISORED MIRROR TRIM

FOR HONDA GL1800 GOLD WING 01-09

- Chrome ABS mirror trim keeps sun glare off the mirror
- Attaches with double-sided tape (included)
- Sold in pairs

SUG. RETAIL.....\$58.95

PART # 0641-0010

CHROME SIDE FAIRING ACCENT

FOR HONDA GL1800 GOLD WING 01-09

- ABS chrome accent adds a touch of flair to side fairing vent
- Attach with double-sided tape
- Sold in pairs

SUG. RETAIL.....\$129.95



PART # 0521-0216

LED SIDE FAIRING VENTS

FOR HONDA GL1800 GOLD WING 01-09

- ABS chrome fairing vents with two amber strip lights
- Lights are sealed in weather-resistant housing
- Lights can be wired as running or auxiliary turn signals
- Mount with double-sided tape

SUG. RETAIL.....\$262.95

PART # BB52623A



LED SIDE FAIRING VENT ACCENT TRIM

FOR HONDA GL1800 GOLD WING 01-09

- ABS chrome accents feature 43 embedded amber LEDs
- Can be wired as running lights or auxiliary turn signals
- Attach with double-sided tape
- Sold in pairs

SUG. RETAIL.....\$256.95

PART # 0521-0627



FAIRING AIR INTAKE ACCENT GRILLES

FOR HONDA GL1800 GOLD WING 01-09

- Similar in design to upper fairing intake vents
- Fit into air intake openings
- Install with double-sided tape

SUG. RETAIL.....\$35.95

PART # BB52620



LED FAIRING AIR INTAKE GRILLES

FOR HONDA GL1800 GOLD WING 01-09

- Each chrome-plated ABS grille glows with six amber LEDs
- Increase visibility
- Function as running or marker lights
- Include all necessary wire connectors
- Sold in pairs

SUG. RETAIL.....\$70.95

PART # 0521-0304



HOT AIR VENTS

FOR HONDA GL1500 GOLD WING 88-00

- ABS chrome replacements for OEM black plastic vents
- Easily snap into place

SUG. RETAIL.....\$102.95

PART # 0521-0214

CHROME AIR VENTS

FOR HONDA GL1500 GOLD WING 88-00

- Chrome replacements for upper vents
- Sold in pairs

SUG. RETAIL.....\$49.95

PART # 0521-0213

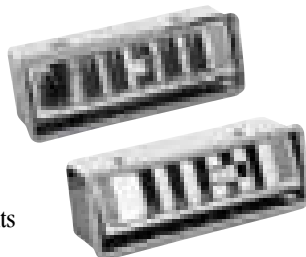



CHROME UPPER AND LOWER VENTS

FOR HONDA GL1800 GOLD WING 01-09

- Replace OEM black plastic vents with chrome-plated ABS
- Snap easily into place
- Sold in pairs of uppers and pairs of lowers

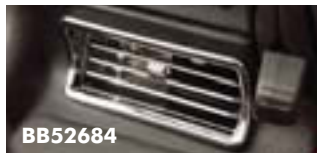

DESCRIPTION	PART #	SUG. RETAIL
Upper (01-05)	BB52684	\$58.95
Lower (01-09)	BB52642	70.95

FRONT FAIRING NOSE TRIM

FOR HONDA GL1800 GOLD WING 01-09

- ABS chrome piece replaces OEM
- Mounts with existing hardware

SUG. RETAIL.....\$62.95



PART # 2331-0018



FRONT FENDER RAIL

FOR HONDA GL1500/1800 GOLD WING 88-09

- Smoothly complements the graceful lines of your Gold Wing fender
- Four-point mounting system
- Won't slip or move and interfere with tire

SUG. RETAIL.....\$76.95

FITS MODEL	PART #
HONDA	
GL1500 88-00	DS-719996

FITS MODEL	PART #
HONDA (CONT)	
GL1800 01-09	DS719909

FRONT CALIPER COVERS

FOR HONDA GL1800 GOLD WING 01-09 (EXCEPT AIRBAG MODELS)

- Chromed ABS caliper covers that match the front contour of the OEM covers
- Mount with included hardware
- Sold in pairs

SUG. RETAIL.....\$84.95

All part numbers in **BOLD MAGENTA** are new this year.



PART # 1703-0043

FAIRING FACE MOLDING

FOR HONDA GL1800 GOLD WING 01-09

- Reinforced to prevent breakage

SUG. RETAIL.....\$70.95



PART # BB52643

LED FRONT FENDER ACCENT

FOR HONDA GL1800 GOLD WING 01-09

- Chrome ABS trim with eight amber LEDs
- Mounts with double-sided tape; requires no drilling
- Sold in pairs

SUG. RETAIL.....\$76.95



PART # 1405-0012



1405-0106



1405-0028

CHROME FRONT FENDER EXTENSIONS

FOR HONDA GL1800 GOLD WING 01-09 (EXCEPT AIRBAG MODELS)

- Adds shape and depth to GL1800 front fender while adding extra protection
- Chrome ABS construction
- Standard version is 6 5/8" H and extends the fender 4"
- Tapered version is perfectly contoured to the front fender and adds 7"
- Installs with two screws and included double-sided tape; requires two holes be drilled

DESCRIPTION	PART #	SUG. RETAIL
Standard	1405-0106	\$35.95
Tapered	1405-0028	58.95



BB52624



BB52654

FRONT ROTOR COVERS

FOR HONDA GL1800 GOLD WING 01-09 (EXCEPT AIRBAG MODELS)

- Chrome-plated ABS rotor covers available with or without integrated LED lights
- Tri-colored lights ring the outside of lit version; amber lights enhance bottom of fork
- Attach quickly and easily

DESCRIPTION	PART #	SUG. RETAIL
W/ lights	BB52624	\$384.95
W/o lights	BB52654	156.95



EXHAUST

TIRES & ACCESSORIES

LUGGAGE

SPORTBIKE ACCESSORIES

CRUISER ACCESSORIES

TOURING ACCESSORIES

SECURITY & AUDIO

GENERAL ACCESSORIES

FAIRINGS & BODY

SEATS

HANDLEBARS & CONTROLS

LIGHTING

ELECTRICAL

SPROCKETS

CHAIN

BRAKES

SUSPENSION

ENGINE

FUEL SYSTEMS

LUBES

TOOLS

TRAILER

MERCH.

CROSS REFERENCE

INDEX

REAR FENDER TRIM FOR HONDA GL1800 GOLD WING 01-09

- Chrome ABS trim wraps around rear fender
- Measures 1" W
- Installs with double-sided tape (included)

SUG. RETAIL.....\$26.95



PART # 1405-0011

SIX-LIGHT FORK LIGHT KIT FOR HONDA GL1500 GOLD WING 88-00

- Similar to our flush-mount four-light kit
- Includes six amber lights, mounting brackets, wiring, hardware and instructions

SUG. RETAIL.....\$174.95

PART # DS-280103



BB-52-617



1904-0050

FAIRING SIDE AND RADIATOR ACCENTS FOR HONDA GL1800 GOLD WING 01-09

- Molded, chrome ABS fairing accents add a sleek, custom touch to the side vents of fairings
- Easily attach with double-sided adhesive tape (included)
- Chrome ABS radiator grilles beat the OEM black plastic grilles by miles
- Unique diamond pattern complements GL1800 features
- Radiator grilles and fairing accents both sold in pairs

DESCRIPTION	PART #	SUG. RETAIL
Fairing side accent	BB-52-617	\$59.95
Radiator grille for GL1800 01-05	DS719910	70.95
Radiator grille for GL1800 06-09	1904-0050	70.95

SWINGARM PIVOT SCUFF PLATES FOR HONDA GL1800 GOLD WING 01-09

- Replace boring gray plastic OEM scuff protectors
- Put chrome and rubber scuff plates between rider's boots and frame
- Great-looking covers mount with OEM hardware
- Sold in pairs

SUG. RETAIL.....\$70.95



PART # BB-52-640

FRONT FENDER TRIM FOR HONDA GL1800 GOLD WING 01-09

- Chrome-plated ABS front fender trim makes OEM front fenders look great
- Side trim wraps around front
- Front medallion with black acrylic insert adds a finishing touch
- Front medallion with amber LED light combines visibility with style
- All attach with double-sided adhesive tape

DESCRIPTION	PART #	SUG. RETAIL
Side accents	BB52648	\$38.95
Front medallion w/ black insert	BB52650	25.95
Front medallion w/ LED insert	BB52651	43.95



BB52651

FRONT LOWER COWL FOR HONDA GL1800 GOLD WING 01-09

- Chrome-plated ABS replacement for the gray plastic OEM cowl
- Designed to work with OEM and Big Bike Parts lower fog lights PART #DS282118
- Mount with OEM hardware

SUG. RETAIL.....\$135.95

PART # BB-52-608



CHROME STEEL SCUFF PLATES FOR HONDA GL1800 GOLD WING 01-09

- Stamped steel construction with chrome finish
- Attach with included double-sided tape
- Sold in sets of four

SUG. RETAIL.....\$87.95

PART # 3550-0085



0504-0020



0504-0021

FRAME COVER

FOR HONDA GL1800 GOLD WING 01-09

- Replaces the plastic OEM swingarm cover up to the frame
- Available in chrome or chrome with rubber inserts
- Uses existing hardware

DESCRIPTION	PART #	SUG. RETAIL
Chrome	0504-0020	\$135.95
Chrome w/ rubber inserts	0504-0021	146.95

All part numbers in **BOLD MAGENTA** are new this year.



CHROME LOWER COWL

- Chrome stamped-steel lower cowl to replace OEM panel
- Use existing OEM screws and gaskets

FITS MODEL	PART #	SUG. RETAIL
GL1800 01-05	0521-0215	\$337.95
GL1800 06-08 (Comfort models)	1861-0409	640.95

CHROME LOWER ENGINE SIDE COVERS

FOR HONDA GL1500 GOLD WING 88-00

- Replace colored pieces found between the upper engine side cover and rear step cover
- Installation is easy – just remove stock covers and replace them with new covers
- Use existing hardware to mount
- Sold in pairs

SUG. RETAIL.....\$92.95 PART # DS-719854



CRUIS WING™ KICKSTAND

FOR HONDA GL1800 GOLD WING 01-08

- Larger base ensures stability
- Mounts directly to OEM kickstand mounting location

SUG. RETAIL.....\$108.95 PART # DS240200



LOWER FAIRING FRESH AIR VENTS

FOR HONDA GL1500 GOLD WING 88-00

- Exact OEM replacement
- Chrome-plated for great appearance
- Easy snap-in installation
- Sold in pairs

SUG. RETAIL.....\$59.95 PART # DS719986



CHROME HANDLEBAR CLAMP PLUGS

FOR HONDA GL1800 GOLD WING 01-08

- Replace the plugs that cover the screw-in clamps on handlebar master cylinder
- Brilliant chrome finish
- Sold in pairs

SUG. RETAIL.....\$10.95 PART # 0603-0127

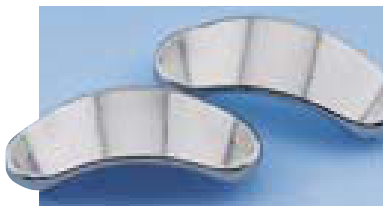

CHROME LOWER COWL

FOR HONDA GL1500 GOLD WING 88-00

- Chrome-plated ABS cowl replaces the stock front cowl
- Sold each

SUG. RETAIL.....\$146.95 PART # DS-708536



LOWER COWL DEFLECTOR

FOR HONDA GL1800 GOLD WING 01-08

- Smoke-colored acrylic panels; close gap between cowl and case guard
- Mounting hardware included
- Sold in pairs

SUG. RETAIL.....\$70.95 PART # 2350-0006



LOWER FAIRING CHROME PLUGS

FOR HONDA GL1500 GOLD WING 88-00

- Chrome covers replace OEM plugs
- Sold as a pair

SUG. RETAIL.....\$7.95 PART # DS-719928



PLASTIC RIVETS

FOR HONDA GL1800 GOLD WING 01-08

- Reusable plastic rivets for Gold Wing fairings
- Available in standard and low-profile
- Sold in 10-pk.

SUG. RETAIL.....\$7.95

DESCRIPTION	PART #
Standard	2402-0084
Low-profile	2402-0085

CHROME BATTERY SIDE COVER TRIM

FOR HONDA GL1800 GOLD WING 06-08

- Chrome ABS replacement for boring, black plastic OEM trim
- Mounts with existing screws
- Also available with raised rubber inserts for a more custom look
- Sold in pairs

DESCRIPTION	PART #	SUG. RETAIL
Chrome	BB-52-630	\$86.95
Chrome w/ rubber inserts	0521-0447	111.95



HANDLEBAR DAMPERS

FOR HONDA GL1800 GOLD WING 01-08

- CNC-machined chrome dampers
- Replace OEM black ends
- Sold in pairs

SUG. RETAIL.....\$35.95 PART # 0604-0005



EXHAUST

TIRES & ACCESSORIES

LUGGAGE

SPORTBIKE ACCESSORIES

CRUISER ACCESSORIES

TOURING ACCESSORIES

SECURITY & AUDIO

GENERAL ACCESSORIES

FAIRINGS & BODY

SEATS

HANDLEBARS & CONTROLS

LIGHTING

ELECTRICAL

SPROCKETS

CHAINS

BRAKES

SUSPENSION

ENGINE

FUEL SYSTEMS

LUBES

TOOLS

TRAILER

MERCH.

CROSS REFERENCE

INDEX

All part numbers in **BOLD MAGENTA** are new this year.

FLAG POLES WITH MOUNTS FOR HONDA GOLD WING

- Die-cast chrome-plated flag poles with mounts; available for antenna or luggage rack
- Antenna mount attaches to Honda GL1500/1800; includes 3/8" pole with fold-down ability
- Luggage rack mount attaches to any 1/2" diameter tubing like luggage racks on Honda GL1800; includes 1/2" pole
- Both kits include heavy-duty polyester American flag



0502-0107

0502-0108

DESCRIPTION	PART #	SUG. RETAIL
Antenna mount	0502-0107	\$86.95
Luggage rack mount	0502-0108	83.95



CHROME TRUNK AND SADDLEBAG MOLDING INSERTS

FOR HONDA GL1800 GOLD WING 01-09

- Chrome inserts dress up the back end
- Install easily into OEM molding recesses



DESCRIPTION	PART #	SUG. RETAIL
Trunk	BB-52-611	\$59.95
Saddlebag	BB-52-612	76.95

SADDLEBAG AIR DAM SPOILERS

FOR HONDA GL1800 GOLD WING 01-09

- Chrome-plated ABS air dams are the perfect complement to Show Chrome trunk and saddlebag molding inserts
- Mount with existing hardware



SUG. RETAIL.....\$141.95 PART # BB52646

TRUNK HANDLE FOR HONDA GL1800 GOLD WING 01-09

- Die-cast, chrome-plated trunk handle accentuates the trunk design
 - All mounting hardware included
- NOTE: Must drill four holes to mount.



SUG. RETAIL.....\$108.95 PART # BB52653

TANK SCUFF PADS

FOR HONDA GL1800 GOLD WING 01-09

- Durable scuff pads with carbon fiber look
- Attach with 3M adhesive backing
- Measure 12 3/4" L x 4 3/4" H
- Sold in pairs



SUG. RETAIL.....\$31.95

PART # 0702-0002

TIMING CHAIN COVER FOR HONDA GL1800 GOLD WING 01-08

- Stamped steel cover with chrome finish dresses up the brushed aluminum OEM cover
- Chromed zinc cap replaces OEM cap
- Mounts using included double-sided tape



SUG. RETAIL.....\$116.95 PART # 0940-0783

TIMING BELT COVERS

FOR HONDA GL1000/1100 GOLD WING 75-83

- Decorative, high-quality covers dress up original Gold Wings
- Sold in pairs



SUG. RETAIL.....\$161.95

PART # DS325645

CHROME VALVE COVERS

FOR HONDA GOLD WING 75-00

- Chrome-plated, die-cast replacement valve covers
- Clean appearance with no center emblems
- Use stock gaskets
- GL1500 covers sold in pairs; include mounting screws
- GL1000/1100 and GL1200 covers sold each; do not include mounting screws



FITS MODEL	PART #	SUG. RETAIL
HONDA		
GL1000/1100 75-83	DS372001	\$108.95
GL1200 84-87	DS372002	108.95
GL1500 88-00	DS-325991	417.95

EASY-CLIP CORD HOLDERS

FOR HONDA GL1200/1500 GOLD WING 84-00

- Design allows easy one-handed use
- Firmly holds the headset cord plug
- Chrome plating adds to the appearance of your Wing
- Foam tape and screws for secure attachment
- Sold as a pair



SUG. RETAIL.....\$19.95 PART # DS-715106



CHROME CORD CLIPS

FOR HONDA GL1500 GOLD WING 88-00

- Chrome-plated cord clips replace standard cord clips
- Each clip firmly holds headset cord
- Allows one-handed connection of headset cord to motorcycle

SUG. RETAIL.....\$11.95 PART # DS-715105

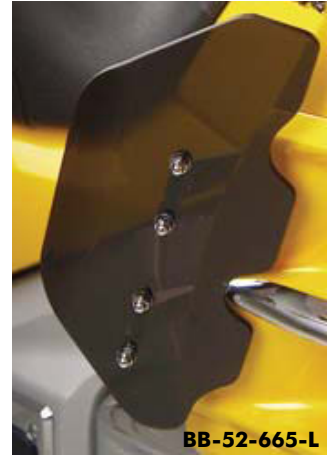

UPPER AND LOWER WIND DEFLECTORS FOR HONDA GL1800 GOLD WING 01-09

- Upper deflectors have incorporated, movable vent panel that can be adjusted to direct air onto rider
- Protection pocket widens by 4" per side
- Lower deflectors can be positioned to direct air onto or away from rider
- All mount with no drilling required; use supplied, die-cast mounting brackets
- Sold in pairs of uppers and pairs of lowers

UPPER

SUG. RETAIL.....	\$146.95
COLOR	PART #
UPPER	
Clear	BB-52-668-U
Red	BB52666U
Smoke	BB-52-665-U

LOWER

SUG. RETAIL.....	\$126.95
COLOR	PART #
LOWER	
Clear	BB-52-668-L
Red	BB52666L
Smoke	BB-52-665-L



500 SERIES CONTOURED WIND DEFLECTORS FOR HONDA GL1500 GOLD WING 88-00

- Contoured wind deflectors closely match the contour of the fairing for superior wind deflection
- Different tints to match most any Gold Wing
- Include chrome-plated hardware
- Sold in pairs

SUG. RETAIL..... \$96.95

DESCRIPTION	PART #
Red	DS-710393
Smoke	DS-710392

LOWER RAIN DEFLECTORS

FOR HONDA GL1800 GOLD WING 01-05

- Smoke-colored acrylic rain deflectors
- Mount to bottom case guard with acrylic clamps
- Sold in pairs

SUG. RETAIL..... \$59.95



PART #	2350-0007
--------	-----------

PASSENGER FLOORBOARD BOTTOM LIGHTS

FOR HONDA GL1800 GOLD WING 01-09

- Visible whether boards are up or down, these amber running lights add a nice touch
- All necessary mounting and wiring hardware is included
- Work with OEM passenger floorboards and Big Bike Parts chrome floorboard bottom covers PART #BB-52-626

SUG. RETAIL..... \$147.95

PART #	BB52619
--------	---------



CHROME PASSENGER FLOORBOARD SIDE AND BOTTOM COVERS

FOR HONDA GL1800 GOLD WING 01-09

- Replace boring, gray OEM covers with these eye-catchers
- Molded, chrome-plated ABS accents for an otherwise dull area
- Mount with OEM hardware
- Sold in pairs

DESCRIPTION	PART #	SUG. RETAIL
Side covers	BB-52-613	\$70.95
Bottom covers	BB-52-626	47.95

All part numbers in **BOLD MAGENTA** are new this year.

EXHAUST

TIRES & ACCESSORIES

LUGGAGE

SPORTBIKE ACCESSORIES

CRUISER ACCESSORIES

TOURING ACCESSORIES

SECURITY & AUDIO

GENERAL ACCESSORIES

FAIRINGS & BODY

SEATS

HANDLEBARS & CONTROLS

LIGHTING

ELECTRICAL

SPROCKETS

CHAINS

BRAKES

SUSPENSION

ENGINE

FUEL SYSTEMS

LUBES

TOOLS

TRAILER

MERCH.

CROSS REFERENCE

INDEX



- EXHAUST
- TIRES & ACCESSORIES
- LUGGAGE
- SPORTBIKE ACCESSORIES
- CRUISER ACCESSORIES
- TOURING ACCESSORIES
- SECURITY & AUDIO
- GENERAL ACCESSORIES
- FAIRINGS & BODY
- SEATS
- HANDLEBARS & CONTROLS
- LIGHTING
- ELECTRICAL
- SPROCKETS
- CHAINS
- BRAKES
- SUSPENSION
- ENGINE
- FUEL SYSTEMS
- LUBES
- TOOLS
- TRAILER
- MERCH.
- CROSS REFERENCE
- INDEX

FLOORBOARD RISERS

FOR HONDA GL1500/1800 GOLD WING 88-09



- Allows floorboards to be raised up to 35/8" higher and 1 1/2" further forward than stock location
- Steel plates mount to stock holes
- Floorboards can be relocated to ten different positions without removal of bolts

SUG. RETAIL.....\$96.95 **PART #** 1621-0135

DRIVER PEG MOUNTING BRACKET

FOR HONDA GL1800 GOLD WING 01-09



- CNC-machined, chrome-plated mounting bracket replaces dull, gray OEM piece
- Reinforced mounting tabs are stronger than OEM
- Mounts with OEM hardware

SUG. RETAIL.....\$135.95 **PART #** BB52659

SHIFTER PEG COVER

FOR HONDA GL1800 GOLD WING 01-09



- Chrome-plated, die-cast shifter peg cover with rubber inserts
- Secures with setscrews
- Fits over 7/8" round shifter peg

SUG. RETAIL.....\$43.95 **PART #** 1602-0079

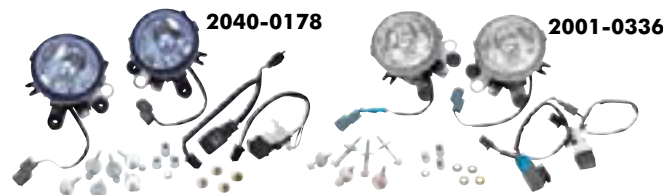

LOWER FOG LIGHT KIT

FOR HONDA GL1800 GOLD WING 01-09

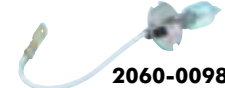

- Features H3, 35W halogen lights with blue lens for increased clarity
- Includes all necessary wiring, lights and switches

DESCRIPTION	PART #	SUG. RETAIL
Lower fog light kit for models w/o airbag	2040-0178	\$235.95
Lower fog light kit for models w/ airbag	2001-0336	235.95
Repl. bulb	2060-0098	8.95



MINI-HALOGEN DRIVING LIGHTS

FOR HONDA GL1500 GOLD WING 88-00

- One of the smallest driving lights available
- Bright 55W H3 halogen bulbs
- Mounting bracket and wiring harness included
- Use replacement H3 halogen bulb PART #DS-282000

SUG. RETAIL.....\$171.95 **PART #** DS-282116

SLIDER BRAKE PEDALS

FOR HONDA GL1500/1800 GOLD WING 88-09



DS253455



1611-0010

- The perfect complement to Slider pegs – same great features, same great designs
- Rail design
- Bolts directly to OEM brake lever
- U.S. Patent #6,161,859.

SUG. RETAIL.....\$53.95

DESCRIPTION	PART #
GL1500 Gold Wing 88-00	DS253455
GL1800 Gold Wing 01-08	1611-0010

HEEL-TOE SHIFTER

FOR HONDA GL1800 GOLD WING 01-09



- Increases shifting ease and comfort
- Reinforced nylon bushings offer extended life
- Compatible with Show Chrome, most aftermarket and OEM pegs; will not work with full-length floorboards

SUG. RETAIL.....\$153.95 **PART #** 1602-0118

SADDLEBAG KICKPLATE SET

FOR HONDA GL1500 GOLD WING 88-00



- Chromed steel plates prevent heel scuff marks from passengers
- Attach with pressure-sensitive tape
- Sold in pairs

SUG. RETAIL.....\$32.95 **PART #** 0521-0217



MINI HALOGEN DRIVING LIGHTS

FOR HONDA GL1800 GOLD WING 01-09

- Smallest spotlights available
- Use high-intensity 50W halogen bulbs
- Kit includes lights, mounting bracket, wiring harness, switch and relay
- Clean up the hand controls by upgrading the included rocker switch to Show Chrome's master cylinder switch block assembly, PART #BB-52-605; sold separately
- Sold in pairs

SUG. RETAIL.....\$205.95

PART # 2001-0210

REPLACEMENT 50W HALOGEN BULB

SUG. RETAIL.....\$11.95

PART # 2060-0144



CB CONTROLLER COVER

FOR HONDA GL1800 GOLD WING 01-09

- Add some high-luster chrome to the OEM CB controller
- Mounts easily with double-sided tape
- Sold each



SUG. RETAIL.....\$26.95

PART # 0521-0628

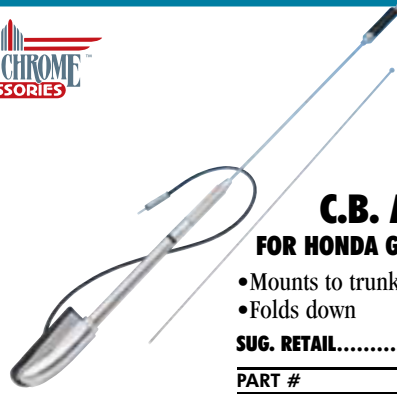

C.B. ANTENNA KIT

FOR HONDA GL1800 GOLD WING 01-09

- Mounts to trunk like OEM; hardware included
- Folds down

SUG. RETAIL.....\$135.95

PART # 4401-0015



AMBER LED OPERA LIGHT

FOR HONDA GL1800 GOLD WING 06-09

- Fits above cylinder head; has running light and turn signal functions
- Attaches with adhesive tape (included)
- Plugs into existing wiring harness

SUG. RETAIL.....\$117.95

PART # 2040-0351

PASSENGER AUDIO CONTROLLER

FOR HONDA GOLD WING

- Allows passenger control over speaker volume and press-to-talk CB capabilities
- Plugs directly into existing wiring harness; no splicing required

SUG. RETAIL.....\$73.95



4405-0125

FITS MODEL	PART #
GL1500 Gold Wing 88-00	4405-0125
GL1800 Gold Wing 01-09	4405-0124



LAMPGARD™ HEADLIGHT PROTECTOR

FOR HONDA GL1800 GOLD WING 01-09

- Clear headlight protector offers superior protection against flying rocks and debris
- Attaches with 3M Dual Lock™ fasteners
- Sold in pairs

SUG. RETAIL...\$49.95

PART # 2001-0125



2201-0045

CHROME RADIO PANEL ACCENT

FOR HONDA GOLD WING

- Chrome stamped-steel accent

FITS MODEL	PART #	SUG. RETAIL
GL1500 SE 90-00	2201-0045	\$35.95
GL1500 Aspencade 99-00	2201-0045	35.95
GL1800 01-09 (except models w/ airbag)	2201-0019	52.95
GL1800 06-08 airbag models	2201-0057	35.95



2201-0019



2201-0057

ACCESSORY SOCKET

FOR HONDA GL1800 GOLD WING 01-09

- Allows easy use of GPS units, cell phone chargers, etc.
- Plugs into on-bike accessory harness; no splicing required
- Drilling required for installation

SUG. RETAIL.....\$11.95

PART # 2130-0023



3 1/2" ROUND LAMPGARD™ PROTECTORS

FOR HONDA GL1800 GOLD WING 01-09

- Protect driving and fog lights from flying rocks and debris
- Attach with dual-lock fasteners
- Sold in pairs

SUG. RETAIL.....\$11.95



PART # 2040-0179



DS282148



DS282118



2060-0097



2060-0102

FOG LIGHTS

- Vast improvement on OEM cornering lights

DESCRIPTION	PART #	SUG. RETAIL
LIGHT KITS		
For Honda GL1500 Gold Wing 88-00	DS282148	\$138.95
For Honda GL1800 Gold Wing 01-09 (except models w/ airbag)	DS282118	235.95

DESCRIPTION	PART #	SUG. RETAIL
REPLACEMENT BULBS		
Repl. bulb for DS282148 (ea.)	2060-0097	\$8.95
Repl. bulb for DS282118 (ea.)	2060-0102	7.95

All part numbers in **BOLD MAGENTA** are new this year.

- EXHAUST
- TIRES & ACCESSORIES
- LUGGAGE
- SPORTBIKE ACCESSORIES
- CRUISER ACCESSORIES
- TOURING ACCESSORIES
- SECURITY & AUDIO
- GENERAL ACCESSORIES
- FAIRINGS & BODY
- SEATS
- HANDLEBARS & CONTROLS
- LIGHTING
- ELECTRICAL
- SPROCKETS
- CHAIN
- BRAKES
- SUSPENSION
- ENGINE
- FUEL SYSTEMS
- LUBES
- TOOLS
- TRAILER
- MERCH.
- CROSS REFERENCE
- INDEX



EXHAUST

TIRES & ACCESSORIES

LUGGAGE

SPORTBIKE ACCESSORIES

CRUISER ACCESSORIES

TOURING ACCESSORIES

SECURITY & AUDIO

GENERAL ACCESSORIES

FAIRINGS & BODY

SEATS

HANDLEBARS & CONTROLS

LIGHTING

ELECTRICAL

SPROCKETS

CHAINS

BRAKES

SUSPENSION

ENGINE

FUEL SYSTEMS

LUBES

TOOLS

TRAILER

MERCH.

CROSS REFERENCE

INDEX

CHROME DRIVING/ CORNERING LIGHT TRIM

FOR HONDA GL1500
GOLD WING 88-00

- Sought-after SE-style trim
- Fit PART #DS282148 and 98-00 OEM lights
- Sold in pairs



SUG. RETAIL.....\$43.95

PART # BB-52-573

CIGARETTE LIGHTER KIT

FOR HONDA
GL1800
GOLD WING 01-09

- Use as cigarette lighter or accessory socket
- Plugs into on-bike accessory harness
- Plug-and-go on the GL1800; additional connectors included for universal application
- Drilling is required for installation



2130-0022

DESCRIPTION	PART #	SUG. RETAIL
Cigarette lighter kit	2130-0022	\$16.95
Repl. lighter element	2130-0024	7.95



2040-0184

2060-0100

LED SPOILER LIGHT

FOR HONDA GL1800 GOLD WING 01-09

- Works with running and brake light
- Mounts with existing hardware
- Requires dual-function converter to function as running and brake light; sold separately

DESCRIPTION	PART #	SUG. RETAIL
Spoiler light	2060-0100	\$96.95
Dual-function converter	2040-0184	19.95

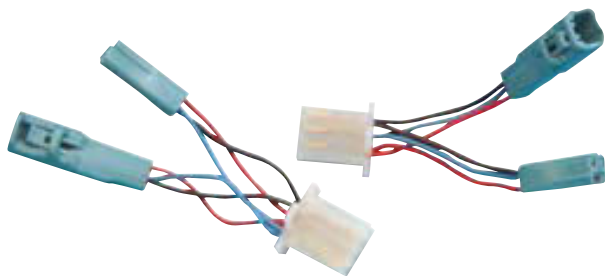

THREE-PIN CONNECTOR ADAPTER PIGTAIL FOR HONDA GL1800 GOLD WING 06-09

- Allows front lighting accessories with Gold Wing 01-05 connectors to be used on 06 and up models
- Plugs into existing wiring harness; no splicing required

SUG. RETAIL.....\$22.95

PART # 2040-0404

CLEAR FRONT TURN SIGNAL LIGHTS

FOR HONDA GL1800
GOLD WING 01-09

- Replace OEM amber lights
- Come with amber incandescent bulbs
- Mount with existing hardware
- Sold in pairs
- Use replacement #7443 bulb PART #2060-0124



SUG. RETAIL.....\$76.95

PART # 2040-0239

LED CLEAR TURN SIGNAL LIGHTS

FOR HONDA GL1800
GOLD WING 06-09

- 21 amber LEDs offer optimal visibility
- Easily install; plug into existing harness
- Require dual load equalizer (PART #2050-0044, SUG. RETAIL \$28.95) to return signals to stock flash rate
- Sold in pairs



SUG. RETAIL.....\$153.95

PART # 2040-0349

MINI LED COURTESY LIGHT

- 12V LED light with chrome housing and domed lens
- Attach with double-sided tape
- Measure 1 1/2" L x 1" W x 4" H



COLOR	PART #	SUG. RETAIL
Amber	2040-0355	\$16.95
Red	2040-0359	16.95
White	2040-0360	22.95
Blue	2040-0361	22.95

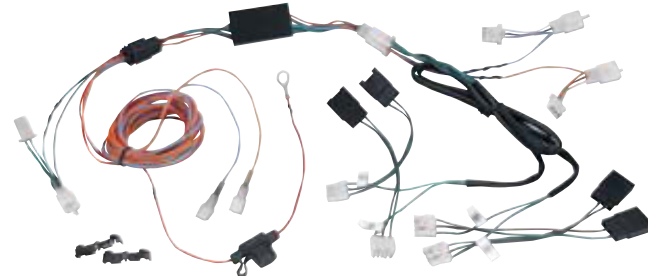

TRUNK TURN SIGNAL CONVERSION HARNESS

FOR HONDA GL1800 GOLD WING 01-09

- Converts trunk lights into running/turn/brake lights; will not affect OEM turn signals

SUG. RETAIL.....\$53.95

PART # 2010-0386



2040-0409



2040-0471

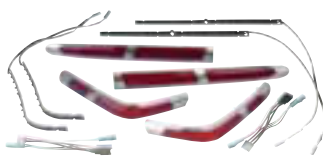

LED TRUNK AND SADDLEBAG MOLDING INSERTS

FOR HONDA GL1800 GOLD WING 01-09

- Dual-function running and brake lights increase illumination on rear and sides of the bike while adding a custom touch
- Install into existing OEM recess
- Plugs directly into existing wire harness
- Each kit includes red LED inserts with either red or clear lenses

DESCRIPTION	CLEAR LENS KIT PART #	RED LENS KIT PART #	SUG. RETAIL
Trunk inserts	2040-0408	2040-0409	\$162.95
Saddlebag inserts	2040-0472	2040-0471	173.95

CLEAR LED TRUNK AND SADDLEBAG LIGHTS

FOR HONDA GL1800 GOLD WING

- Last longer and shine brighter than conventional lights
- Plug directly into OEM wire harness and mount using existing hardware
- Saddlebag lights require load equalizer PART #2050-0044



FITS MODEL	DESCRIPTION	PART #	SUG. RETAIL
GL1800 Gold Wing 01-09	Trunk lights	2040-0473	\$232.95
GL1800 Gold Wing 06-09	Saddlebag lights	2040-0474	273.95

ELECTRONICALLY ISOLATED TRAILER WIRE HARNESS

FOR HONDA GL1800 GOLD WING 01-09

- Isolates wiring between bike and trailer to prevent electrical feedback into the bike
- Plugs into existing wiring

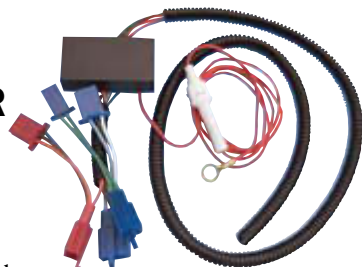

SUG. RETAIL.....\$59.95
PART # 3902-0015

RECEIVER HITCH RACK

- The perfect stowage solution when the trunk and saddlebags are full
- Perfect for extra bags, coolers, etc.
- Steel construction with a black powder-coat finish
- Fits any 1 1/4" horizontal receiver (including Show Chrome receivers PART #s 3902-0041 and 3902-0042)
- Measures 9" L x 15" W



SUG. RETAIL.....\$76.95
PART # 4510-0329

All part numbers in **BOLD MAGENTA** are new this year.

SADDLEBAG AND TRUNK LENS GRILLES

FOR HONDA GL1800 GOLD WING 06-09

- Chrome ABS lens grilles for Gold Wing trunks or saddlebags
- Sold in pairs

SUG. RETAIL.....\$53.95

DESCRIPTION	PART #
Saddlebag lens grilles	0521-0397
Trunk lens grilles	0521-0398

0521-0398



0521-0397

CLEAR SADDLEBAG LIGHTS

FOR HONDA GL1800 GOLD WING 01-05

- Clear saddlebag corner lights; replace OEM lights
- Include red and amber incandescent lights
- Sold in pairs
- Use replacement #7443 bulbs PART #s 2060-0124 (amber) and 2060-0125 (red)

SUG. RETAIL.....\$104.95



PART # 2040-0185

CLEAR LED TRUNK LIGHTS

FOR HONDA GL1800 GOLD WING 01-09

- Replace OEM incandescent trunk lights with clear lens LED lights
- Sold in pairs

SUG. RETAIL.....\$181.95



PART # 2040-0352



3902-0041

3902-0042

RECEIVER HITCHES FOR HONDA GOLD WING

- Black powder-coated receiver hitches easily mount to frame
- Kits include receiver, 17/8" hitch ball, ball mount and mounting tabs for mud flaps

FITS MODEL	PART #	SUG. RETAIL
GL1500 88-00	3902-0042	\$279.95
GL1800 01-05	3902-0041	352.95

EXHAUST

TIRES & ACCESSORIES

LUGGAGE

SPORTBIKE ACCESSORIES

CRUISER ACCESSORIES

TOURING ACCESSORIES

SECURITY & AUDIO

GENERAL ACCESSORIES

FAIRINGS & BODY

SEATS

HANDLEBARS & CONTROLS

LIGHTING

ELECTRICAL

SPROCKETS

CHAINS

BRAKES

SUSPENSION

ENGINE

FUEL SYSTEMS

LUBES

TOOLS

TRAILER

MERCH.

CROSS REFERENCE

INDEX



EXHAUST

TIRES & ACCESSORIES

LUGGAGE

SPORTBIKE ACCESSORIES

CRUISER ACCESSORIES

TOURING ACCESSORIES

SECURITY & AUDIO

GENERAL ACCESSORIES

FAIRINGS & BODY

SEATS

HANDLEBARS & CONTROLS

LIGHTING

ELECTRICAL

SPROCKETS

CHAINS

BRAKES

SUSPENSION

ENGINE

FUEL SYSTEMS

LUBES

TOOLS

TRAILER

MERCH.

CROSS REFERENCE

INDEX



PASSENGER ARMRESTS FOR GL1800 GOLD WING 01-08

- Chrome mounting brackets fasten to the trunk and provide a sturdy mount for the swing-away armrests
- Padding matches the OEM texture and color
- Swing-out cup holder included for the ultimate passenger convenience
- Sold in pairs

SUG. RETAIL.....**\$249.95**

PART # **0822-0060**

LOUVERED CHROME BATTERY BOX COVERS FOR HONDA GL1800 GOLD WING 01-08

- Louvered styling with a beautiful chrome finish
- Designed with provisions to allow optional custom back-lighting
- Sold in pairs

SUG. RETAIL.....**\$99.95**

PART # **0521-0718**



1861-0067



1861-0067

LUGGAGE RACK FOR HONDA GL1800 GOLD WING 01-08

- Brilliant chrome finish over sturdy aluminum construction
- All necessary mounting hardware included

SUG. RETAIL.....**\$239.95**

PART # **1510-0028**



EXHAUST EXTENSIONS FOR HONDA GL1800 GOLD WING 01-08

- Give your exhaust a sleek, finished appearance
- Sturdy steel construction with a beautiful chrome finish
- Easily replace stock muffler tips, require no modifications to stock exhaust
- Include all necessary installation hardware

DESCRIPTION	PART #	SUG. RETAIL
Straight	1861-0067	\$169.95
Turndown	1861-0103	129.95



1861-0103

LIGHTED SADDLEBAG MOLDING FOR HONDA GL1800 GOLD WING 01-08

- Adds sparkle and elegance
- Molding has eye-catching LEDs that draw minimal power and generate very little heat
- Replace existing parts with no added bulk; all stock mounting points and hardware are retained
- Sold as a four-piece set

SUG. RETAIL.....**\$239.95**

PART # **2040-0148**



LIGHTED TRUNK HANDLE FOR HONDA GL1800 GOLD WING 01-08

- Handle is chrome-plated
- Includes LED brake light that adds visibility when the bike is seen from the rear
- Can be used with the Honda OEM spoiler

SUG. RETAIL.....**\$99.95**

PART # **2040-0492**



LUGGAGE RACK RISERS FOR HONDA GL1800 GOLD WING 01-08

- Raises Kuryakyn's luggage rack by 5/8"
- Spreads out the load better and makes it easier to clean under the rack
- Reuses stock mounting holes
- Risers sold as a set
- For use with Kuryakyn luggage rack PART #1510-0028 only

SUG. RETAIL.....**\$39.95**

PART # **1510-0091**



LIGHTED TRUNK MOLDING FOR HONDA GL1800 GOLD WING 01-08

- Pure class and easy to install
- Two-circuit LEDs function as both running and brake lights
- Minimal draw on electrical system
- Install quickly and easily compared to old-fashioned light bars

SUG. RETAIL.....**\$179.95**

PART # **2040-0147**





SADDLEBAG SIDE EMBLEMS

FOR HONDA GL1800 GOLD WING 01-08

- Chrome accent highlights the contour of the OEM saddlebag
- Creates an illusion of depth and forward motion
- Simple peel-and-stick installation
- Sold in pairs



SUG. RETAIL.....\$39.95

PART # 3501-0445

SADDLEBAG TOP ACCENTS

FOR HONDA GL1800 GOLD WING 01-08

- Adds eye candy to the plain Jane saddlebag tops
- Keeps the top corner protected from annoying surface scratches
- Install quickly with double-sided tape
- Sold in pairs



SUG. RETAIL.....\$39.95

PART # 3550-0074

SADDLEBAG BOTTOM TRIM MOLDING

FOR HONDA GL1800 GOLD WING 01-08

- Chrome and LED mini-strips replace stock trim pieces
- LEDs completely light up the rear of your bike
- Sold as a set



SUG. RETAIL.....\$159.95

PART # 2040-0344

SADDLEBAG TAILLIGHT ACCENTS

FOR HONDA GL1800 GOLD WING 06-08

- Peel-and-stick chrome accents divide the clear and red sections of the GL1800 saddlebag taillight
- Sold as a set



SUG. RETAIL.....\$49.95

PART # 0521-0409

TRUNK TAILLIGHT ACCENTS

FOR HONDA GL1800 GOLD WING 01-08

- Peel-and-stick chrome accents
- Sold in pairs

SUG. RETAIL.....\$39.95

PART # 0521-0408



ANTENNA FLAG MOUNT WITH FLAG

FOR HONDA GOLD WING

- Easy, out-of-the-way flag mount
- Sturdy aluminum construction
- Flag measures 4 1/2" x 8 1/2" with a total height of 12"
- Stays in place with setscrew
- Will also fit any tube with approximately 0.6" o.d.

SUG. RETAIL.....\$59.95

FITS MODEL	PART #
HONDA	
GL1500 88-00	0521-0640
GL1800 01-08	0521-0410



SHARK GILLS FAIRING ACCENTS

FOR GL1800/A GOLD WING 01-08

- Incorporate a streamlined main beam with six stylish vanes in a sleek chrome accent
- Gives a high-speed appearance to the fairing exit vent
- Install using a high-tech adhesive, no drilling required
- Sold in pairs

SUG. RETAIL.....\$79.95

PART # 0521-0321

CHROME EYEBROWS™

FOR HONDA GL1800 GOLD WING 01-08

- Chrome strip melds the fairing components together beautifully by closing the gap between the fairing and headlamps
- Sold in pairs

SUG. RETAIL.....\$49.95

PART # 0521-0319



CHROME FAIRING EXIT GRILLE COVERS

FOR HONDA GL1500 GOLD WING 98-00

- Accent the "black hole" on the side of the fairing
- Flat surfaces are highly polished for a flawless, smooth finish
- Easy installation; no need to disassemble fairing
- Chrome hardware included

SUG. RETAIL.....\$69.95

PART # DS-720013

All part numbers in **BOLD MAGENTA** are new this year.

- EXHAUST
- TIRES & ACCESSORIES
- LUGGAGE
- SPORTBIKE ACCESSORIES
- CRUISER ACCESSORIES
- TOURING ACCESSORIES
- SECURITY & AUDIO
- GENERAL ACCESSORIES
- FAIRINGS & BODY
- SEATS
- HANDLEBARS & CONTROLS
- LIGHTING
- ELECTRICAL
- SPROCKETS
- CHAINS
- BRAKES
- SUSPENSION
- ENGINE
- FUEL SYSTEMS
- LUBES
- TOOLS
- TRAILER
- MERCH.
- CROSS REFERENCE
- INDEX



LED LIZARD FAIRING LIGHTS FOR HONDA GL1800 GOLD WING 01-08



- Light accents add a blaze of color to the front fairing scoop and side intake vents
- Included controller lets you choose from three modes: one constant color hue, one color flash, or continuously change between all seven colors (red, lime, ice blue, sky blue, dark blue, purple and green)
- Controller lets you set the rate of color change
- Kit is plug-and-play installation and includes all necessary hardware, wiring, lights, control module and instructions
- Sold as a complete set

SUG. RETAIL.....**\$189.95**
PART # **2040-0476**

FAIRING SIDE MOLDING TRIM

FOR HONDA GL1500 GOLD WING 88-00



- Chrome, radiused edges complement the flowing lines of the fairing
- Stock-like fit allows for the use of OEM reflectors or accessory lights
- Special fasteners and "Hot Spot" chrome end plugs place the finishing touches on this great looking piece of trim

SUG. RETAIL.....**\$59.95** PART # **DS-719803**

FAIRING SCOOP TRIM

FOR HONDA GL1800 GOLD WING 01-08



- Easily installed, looks great
- Sold each

SUG. RETAIL.....**\$29.95**

PART # **0521-0320**

HEEL-TOE SHIFTER

FOR HONDA GL1800 GOLD WING 01-08

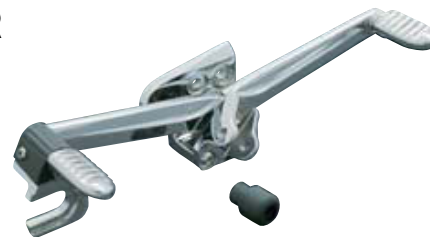

- The convenience of a heel-toe shifter without having to convert to floorboards
- Retains the stock footpegs
- Easy to install

SUG. RETAIL.....**\$179.95**

PART # **1602-0109**

LOWER COWL COVERS

FOR HONDA GL1800 GOLD WING 01-08



- Chrome covers streamline the look of the bulky lower cowl
- Work with or without fog lights
- Install in minutes
- Sold in pairs

SUG. RETAIL.....**\$119.95**
PART # **0521-0442**

FAIRING INTAKE VENT INSERTS

FOR HONDA GL1800 GOLD WING 01-08



- Transforms the black fairing air inlets into a chrome highlight
- Easy installation, just peel and stick
- Sold in pairs

SUG. RETAIL.....**\$32.95** PART # **2350-0020**



TRANSFORMER™ FLOORBOARDS

- Highly chromed floorboards that offer style, function and comfort
- Direct replacements for OEM floorboards that install in minutes
- Retractable folding arm deploys a hidden footrest for an alternate foot position 4" higher and 5" farther forward than the stock position

NOTE: PART #DS-720284 will work on GL1500i models that have been equipped with Hondaline passenger boards.

FITS MODEL	PART #	SUG. RETAIL
HONDA		
GL1500SE 90-00	DS-720283	\$219.95
GL1500A 90-00	DS-720284	249.95
GL1800 01-08	DS-720285	239.95

FLOORBOARD KIT

FOR HONDA GL1800 GOLD WING 01-08

- Updates the controls, improves comfort and adds style all at once
- Kit has a built-in heel-toe shifter and brake lever for the ultimate in convenience
- Floorboards have a chrome finish and full-length ISO™ rubber inserts to absorb vibration
- Floorboards fold up for easy maneuvering in tight spaces and allow full access to the kickstand
- Install in just minutes
- Sold as a set

SUG. RETAIL.....**\$399.95**
PART # **1621-0074**



ISO™ -WINGS MINI FLOORBOARDS

FOR HONDA GL1800 GOLD WING 01-08

- An attractive alternative to footpegs
- Size provides more support than OEM footpegs, yet the stylish design remains unobtrusive
- Mount to stock footpeg brackets
- Sold in pairs



1620-0207

DESCRIPTION	PART #	SUG. RETAIL
ISO™ -Wing boards	1620-0207	\$99.95
Repl. rubber pads (8 pieces)	1620-0179	19.95

ERGO TO ERGO II UPGRADE

FOR HONDA GL1800 GOLD WING 01-08

- Now you can upgrade from the original Ergo pegs to the Ergo II pegs clamp style
- Retains the existing arm and footrest
- Sold in pairs



SUG. RETAIL.....\$119.95

PART #	1624-0133
--------	-----------

DUALY ISO™ -PEGS FOR HONDA GOLD WING

- Direct replacement for stock rider pegs
- Classy, comfortable and install in minutes

SUG. RETAIL.....\$69.95

FITS MODEL	PART #
HONDA	
GL1500 88-00	1620-0146
GL1800 01-08	1620-0147



1620-0146



1620-0147

BRAKE PEDAL AND ARM COVER

FOR HONDA GL1800 GOLD WING 01-08

- Easy, economical way to improve the style and function of your bike
- Brake pedal cover installs over stock pedal; second cover goes over the stock brake arm to cover the area completely in chrome
- Sold as a set



SUG. RETAIL.....\$49.95

PART #	1611-0013
--------	-----------

FOOTPEG ADAPTERS

FOR HONDA GL1800 GOLD WING 01-08

- Lets you replace the stock driver footpegs with any Kuryakyn footpeg
- Sold in pairs
- Footpegs available separately

SUG. RETAIL.....\$21.95



PART #	1620-0477
--------	-----------

All part numbers in **BOLD MAGENTA** are new this year.



1624-0127



1624-0127



1624-0128



1624-0129

ERGO II CRUISE MOUNTS FOR HONDA GL1800 GOLD WING 01-08 (ALL)

- The finest highway peg setup available for the Honda Gold Wing
- Mount assembly is a sturdy two-piece design that is easily installed
- Locates the cruise arm mounting point high and tight to keep good cornering clearance
- Highly adjustable for a just-right feel on the bike
- Sold in pairs

NOTE: Check to ensure the pegs do not interfere with the operation or cornering clearance of the motorcycle before riding.

DESCRIPTION	PART #	SUG. RETAIL
W/ Dually ISO™ -Pegs	1624-0127	\$199.95
W/ Switchblade Pegs	1624-0134	249.95
W/ ISO™ -Wings (5 1/4" L x 4 1/4" W)	1624-0128	229.95
W/ lighted cruise boards (8 1/2" L x 4" W)	1624-0129	279.95
W/ unlighted cruise boards (8 1/2" L x 4 1/4" W)	1624-0130	259.95

ISO™ -BRAKE PEDAL PAD

FOR HONDA GL1500 GOLD WING 88-00, VALKYRIE GL1500C 97-03

- Covers the raw, unfinished end of brake pedal
- Beautiful chrome with rubber inserts provides a nonslip surface

SUG. RETAIL.....\$29.95



PART #	DS-720357
--------	-----------



BRAKE ROTOR COVERS FOR HONDA GL1800 GOLD WING 01-08

- Flawless, smooth show chrome finish that gives your bike a streamlined appearance
- All edges and openings are rounded smooth
- Durable, lightweight construction will not rust
- Sold in pairs

SUG. RETAIL.....\$119.95

PART #	1710-0041
--------	-----------





- EXHAUST
- TIRES & ACCESSORIES
- LUGGAGE
- SPORTBIKE ACCESSORIES
- CRUISER ACCESSORIES
- TOURING ACCESSORIES
- SECURITY & AUDIO
- GENERAL ACCESSORIES
- FAIRINGS & BODY
- SEATS
- HANDLEBARS & CONTROLS
- LIGHTING
- ELECTRICAL
- SPROCKETS
- CHAINS
- BRAKES
- SUSPENSION
- ENGINE
- FUEL SYSTEMS
- LUBES
- TOOLS
- TRAILER
- MERCH.
- CROSS REFERENCE
- INDEX

WHEEL SPOKE COVERS

FOR HONDA GL1800 GOLD WING 01-08

- Easy to install chrome accents really add flash to the front wheel
- Lightweight, no need to re-balance wheel after installation
- Sold as a set

SUG. RETAIL.....\$139.95

PART # 0212-0056



LED RING OF FIRE™

FOR HONDA GL1500/ GL1800 GOLD WING



DS-280508

- Features super-bright, pinpoint LEDs that last longer than incandescent strip lights
- Provides a much more stunning lighting effect
- All versions feature two separate rows of lights (an amber row shines outward on all versions and your choice of several other colors shines inward)
- Sold as a set

COLOR	PART #	SUG. RETAIL
GL1500 88-00		
Amber/amber	DS-280505	\$119.95
Amber/blue/green	DS-280507	169.95
Amber/red/blue	DS-280508	169.95
GL1800 01-08		
Amber/amber	2040-0434	139.95
Amber/blue	2040-0435	179.95
Amber/green/blue	2040-0436	179.95
Amber/red/blue	2040-0437	179.95



LAZER™ SPOKE ACCENTS

FOR HONDA GL1500 GOLD WING 88-00

- Beautifully chromed accents make your wheel come alive
- They pick up flashes of sunlight or reflect an array of light flashes
- Easy installation with included hardware

SUG. RETAIL.....\$89.95 PART # DS-376653

SWINGARM PIVOT COVERS

FOR HONDA GL1800 GOLD WING 01-08

- Plastic chrome covers replace existing dull covers
- Accent frame and other Kuryakyn products
- Install in minutes with OEM hardware

SUG. RETAIL.....\$29.95 PART # DS-375595



LICENSE AREA TRIM WITH LIGHTS

FOR HONDA GL1800 GOLD WING 01-08

- Gives the back of your Gold Wing a whole new personality
- Brilliant LEDs light up while running and go "super bright" when you hit the brakes
- Simple plug-in wiring, no cutting/splicing required

SUG. RETAIL.....\$119.95



2030-0155

DESCRIPTION	PART #
Red LED/red lens	2030-0155
Red LED/clear lens	2030-0156



1710-0194

CHROME BRAKE ROTOR COVERS WITH LED RING OF FIRE™

FOR HONDA GL1800 GOLD WING 01-08

- Covers feature a flawless, smooth chrome finish
- Composite construction means they will never rust
- All cover openings feature rounded edges
- LED Ring of Fire™ features super-bright pinpoint LEDs that have a stunning lighting effect
- Two separate rows of LEDs on each cover: one amber LED row shines out, the second colored LED row shines in towards the wheel, illuminating it with a brilliant glow
- Improved design has an encapsulated circuit board that withstands exposure to the elements
- Sold in pairs

DESCRIPTION	PART #	SUG. RETAIL
Amber/amber	1710-0194	\$259.95
Amber/red/blue	2040-0438	299.95

REAR WHEEL RING OF FIRE

FOR HONDA GL1800 GOLD WING 01-08

- Red/red LED lights cast an eye-catching glow from under the saddlebags
- Include all necessary mounting hardware

SUG. RETAIL.....\$139.95

PART # 2040-0332



LED FRONT FENDER ACCENTS

FOR HONDA GL1800 GOLD WING 01-08

- Blends with the smooth lines of the stock fender
- Chrome molding encases a bright series of LEDs for added visibility and stunning good looks
- Sold in pairs

SUG. RETAIL.....\$79.95

PART # 2040-0146



All part numbers in **BOLD MAGENTA** are new this year.



LIGHTED FORK TOWER ACCENTS

FOR HONDA GL1800 GOLD WING 01-08



- Chrome-plated three spear towers feature amber LED running lights; the top tower light doubles as an auxiliary turn signal
- Plug-and-play installation
- GL1800 06-08 models require PART #2020-0381 for plug-and-play installation (sold separately)

NOTE: Not for use with airbag models.

SUG. RETAIL.....\$169.95

PART # 2040-0493



FRONT FENDER EXTENSION

FOR HONDA GL1800 GOLD WING 01-08

- Easy install on stock front fender, even if the Honda extension has been previously installed
- Extends the fender a full 4" to help keep rain spray and road grime away
- Chrome finish with black rubber lower tip



SUG. RETAIL....\$69.95

PART # 1405-0008



SHARK TOOTH FENDER ACCENTS

FOR HONDA GL1800 GOLD WING 01-08

- Chrome accent finishes the look of the front fender
- Sold in pairs

SUG. RETAIL.....\$49.95

PART # 1405-0025



FRONT FENDER TIP

FOR HONDA GL1800 GOLD WING 01-08

- Perks up the front fender, takes just seconds to install
- Sold each

SUG. RETAIL.....\$29.95

PART # 1405-0026



REAR FENDER TRIM

FOR HONDA GL1800 GOLD WING 01-08

- Installs easily on bottom edge of the rear fender
- Adds a classy finishing touch

SUG. RETAIL.....\$29.95

PART # 1405-0016



BOOMERANG FRAME COVERS

FOR HONDA GL1800 GOLD WING 01-08

- Show-chromed, die-cast frame covers make artwork out of an otherwise ordinary part of your bike
- Carefully designed and placed rubber scuff protectors in crucial areas
- Sold in pairs

SUG. RETAIL.....\$129.95

PART # 0504-0032



STEALTH LIGHT II

FOR HONDA GL1800 GOLD WING 01-05

- Streamlined LED lighted accents work as running lights and accent blinkers
- Plug into existing turn signal connectors so they install in just minutes

SUG. RETAIL.....\$79.95

PART # 2040-0331



STEALTH LED LIGHTBARS AND LED MIRROR LIGHTS

FOR HONDA GL1800 GOLD WING 01-05

- Adds visibility and style
- Lightbars function as running lights and accessory turn signal lights
- Halo of light really brings the valve covers alive at night
- Mirror lights serve as auxiliary turn signals
- Slim construction does not detract or interfere with visible mirror surface; when not in use they are nearly invisible
- Plug right into factory wiring harness without splicing
- Complete kit includes two lightbars and two mirror lights
- Mirror lights sold in pairs

DESCRIPTION	PART #	SUG. RETAIL
Stealth LED mirror lights	2040-0143	\$59.95
Kit (lightbars and mirror lights)	2040-0144	119.95



BEAR CLAW MIRROR ACCENT

FOR HONDA GL1800 GOLD WING 01-08

- Aggressive chrome accents look great from any angle
- Simple peel-and-stick application
- Sold in pairs

SUG. RETAIL.....\$59.95

PART # 0641-0088

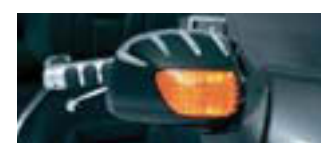

EXHAUST

TIRES & ACCESSORIES

LUGGAGE

SPORTBIKE ACCESSORIES

CRUISER ACCESSORIES

TOURING ACCESSORIES

SECURITY & AUDIO

GENERAL ACCESSORIES

FAIRINGS & BODY

SEATS

HANDLEBARS & CONTROLS

LIGHTING

ELECTRICAL

SPROCKETS

CHAINS

BRAKES

SUSPENSION

ENGINE

FUEL SYSTEMS

LUBES

TOOLS

TRAILER

MERCH.

CROSS REFERENCE

INDEX

All part numbers in **BOLD MAGENTA** are new this year.



AERO HEAD MARKER LIGHTS

FOR HONDA GL1800 GOLD WING 01-05

- Amber LED lights add visibility
- Install on Kuryakyn or Honda OEM front rotor covers
- Plug-and-play installation



SUG. RETAIL.....\$69.95

PART # 2040-0333

0940-0510



CHROME TIMING CHAIN COVER SET

FOR HONDA GL1800 GOLD WING 01-08

- Covers the entire timing chain cover in minutes with beautiful chrome
- Installs with a strong adhesive that is specially designed for high-temperature applications
- Includes a chrome version of the stock screw-in cap
- Cap also available separately

0940-0508



DESCRIPTION	PART #	SUG. RETAIL
Timing chain cover set	0940-0510	\$89.95
Cap only	0940-0508	29.95



LED REAR REFLECTOR CONVERSION KIT

FOR HONDA GL1800 GOLD WING 01-08

- Replaces the stock rear red reflector on the rear center panel with an eye-catching LED
- Functions as both a running and brake light
- Plug-in wiring lets you install the kit in minutes

SUG. RETAIL.....\$59.95

PART # 2040-0255

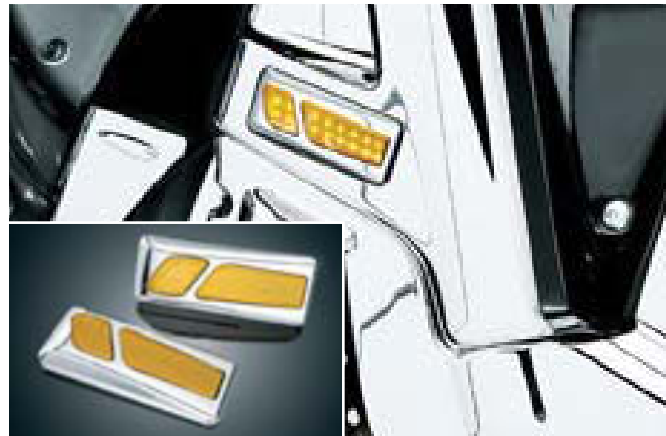

LED FRONT REFLECTORS

FOR HONDA GL1800 GOLD WING 01-08

- Replace those ho-hum amber reflectors on the lower fork leg covers with these LED dazzlers
- Function as running lights and turn signals
- Great looks and added visibility
- Sold in pairs

SUG. RETAIL.....\$59.95

PART # 2040-0145

LIGHTNING VALVE COVERS

FOR HONDA GL1800 GOLD WING 01-08

- Get a sleek, uniform look without compromising the integrity of the stock valve covers
- Chrome covers are held on by a two-sided adhesive pad that is specially designed for high-temperature applications
- Fit snugly over stock valve covers
- Sold as a set of four

SUG. RETAIL.....\$159.95

PART # 2040-0254



TRAILER HITCH

FOR HONDA GL1800/A GOLD WING 01-08

- Stylish, plug-in receptacle hitch features a six-point mounting system for strength and rigidity
- Mounting system is completely out of sight when installed
- Rear support plate removes easily for tire changes
- Easy installation can be performed with bike on center stand

SUG. RETAIL.....\$299.95

PART # DS-708161

TRAILER HITCH

FOR HONDA GL1500 88-00

- The strongest hitch on the market
- Unique vertical receiver tube makes this hitch virtually invisible when the receiver is removed

SUG. RETAIL.....\$299.95

PART # 3902-0007



All part numbers in **BOLD MAGENTA** are new this year.



TRAILER HITCH RACK

FOR HONDA GL1800 GOLD WING 01-08

- Install the mount plate below your trailer hitch ball and this rack can attach/detach in less than a minute
- Durable construction, designed to hold up to 35 lb.
- Measures 18" W x 12" L x 1 1/2" D; weighs 6.5 lb.
- Requires Trailer Hitch PART #DS-708161 for installation (sold separately)

NOTE: Not for use when a trailer is being towed.

SUG. RETAIL.....**\$159.95** PART # **3930-0006**



DEBRIS MODULATOR MUD FLAP

FOR HONDA GL1800 GOLD WING 01-08

- Practical and good-looking
- Features a full 8 square inches of brilliant red LEDs in two stylized lenses
- Lens shape complements shape of the saddlebags
- Run/brake function of LEDs adds extra measure of visibility
- For use with or without Kuryakyn™ trailer hitch
- Mud flap and mounting kit sold separately



1420-0008



DESCRIPTION	PART #	SUG. RETAIL
Debris modulator mud flap	1420-0008	\$149.95
Mount kit for use w/o Kuryakyn trailer hitch	1420-0009	39.95
Mount kit for use w/ Kuryakyn trailer hitch	1420-0010	21.95

STAND-RITE KICKSTAND

FOR HONDA GL1800 GOLD WING 01-08 (ALL)

- Chromed kickstand is super-strong and looks great
- Footpad design resists sinking into warm blacktop
- Easy to reach, even with running floorboards or aftermarket shifters
- Sold each



SUG. RETAIL..... **\$89.95** PART # **0510-0075**

KICKSTAND EXTENSION

- Improves access to the kickstand, can be used on almost any motorcycle
- If used with Kuryakyn's Driver Floorboard Kits, you can access the kickstand without having to fold up the floorboard
- Fully adjustable; sold each



SUG. RETAIL..... **\$39.95** PART # **0510-0074**



MC-298

FLOORBOARDS FOR HONDA GOLD WING

- Feature 1" diameter heavy-duty steel tubing board supports
- Heel/toe shifter is polished chrome
- Stock shift and brake linkages are retained
- All steel parts are chrome plated
- Large rubber brake pad to use on stock brake pedal is included



MC-297-8



MC2977

FITS MODEL	PART #	SUG. RETAIL
HONDA		
GL1200 Interstate/Aspenade 84-87	MC-298	\$415.95
GL1500 Gold Wing 88-94	MC-297-8	470.95
GL1800 Gold Wing 01-06	MC2977	494.95

FLOORBOARDS WITH HEEL/TOE SHIFTER

FOR HONDA GL1500 GOLD WING 95-00

- Floorboards are cast aluminum construction with rubber footpads
- Provide convenient shifting and additional comfort on long rides
- Mount to original footpeg location
- Include brake extension, heel rests and sidestand extension



SUG. RETAIL..... **\$470.95** PART # **1621-0094**

FRONT FENDER TRIM

- Triple chrome-plated fender trim features square nose dual-rail look
- Blends with the fender striping as though it should have been there all the time
- Does not include emblems

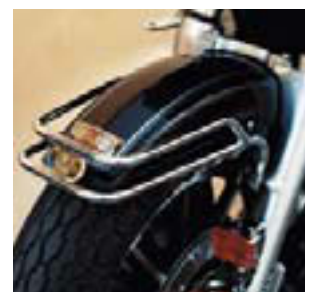

SUG. RETAIL..... **\$103.95**

FITS MODEL	PART #
HONDA	
GL1100 Interstate, Aspenade 80-83	MC-660
GL1200 Interstate, Aspenade 84-87	MC-660-5

TOURBOX LUGGAGE RACK

FOR GL1800/A GOLD WING 01-09

- Unique design features wide support for better weight control with rubber pads to protect paint
- Upswept rear blends well with bike and prevents gear from sliding off
- Triple chrome-plated



SUG. RETAIL..... **\$208.95**

PART # **MC4717**

All part numbers in **BOLD MAGENTA** are new this year.



EXHAUST

TIRES & ACCESSORIES

LUGGAGE

SPORTBIKE ACCESSORIES

CRUISER ACCESSORIES

TOURING ACCESSORIES

SECURITY & AUDIO

GENERAL ACCESSORIES

FAIRINGS & BODY

SEATS

HANDLEBARS & CONTROLS

LIGHTING

ELECTRICAL

SPROCKETS

CHAINS

BRAKES

SUSPENSION

ENGINE

FUEL SYSTEMS

LUBES

TOOLS

TRAILER

MERCH.

CROSS REFERENCE

INDEX



ARMREST POUCH

FOR HONDA GL1800 GOLD WING 01-08

- Matches OEM seat
- Mounts to passenger armrest

SUG. RETAIL.....\$37.95

PART # 3505-0030

SADDLEBAG LINERS

FOR HONDA GL1200/1500/1800 GOLD WING

- Makes loading and unloading saddlebags easy and convenient
- Made of sturdy, weather-resistant, urethane-coated nylon
- Handy carrying handles
- Measures 20" W x 11 1/2" H x 5 1/2" D
- Sold each



SUG. RETAIL.....\$20.95

PART # 3501-0276

DELUXE SADDLEBAG LINER

FOR HONDA GL1500/1800 GOLD WING

- Heavy-duty, water-resistant polyester construction
- Features two large external zippered pockets and two inner compartments
- Padded carrying handles and shoulder strap
- Sold each



SUG. RETAIL.....\$31.95

PART # 3501-0299



HPNL-57



HPNL-18AP



HPNL-18LP

DOUBLE "ADD-A-POCKET"

FOR HONDA GL1500/1800 GOLD WING

- Handy bags with large zipper compartment and roomy utility pouch slip over fairing pocket hard covers
- Add usable storage space for keys, wallets, garage door openers, etc.

SUG. RETAIL.....\$41.95

FITS MODEL	POSITION	PART #
HONDA		
GL1500 88-00	Left	HPNL-57
GL1800 01-08	Right	HPNL-18AP
	Left	HPNL-18LP

TRIPLE TRUNK POUCH

FOR HONDA GL1800 GOLD WING 01-08

- Adds storage to trunk
- Hook-and-loop material keeps contents in line
- Two 12" x 6" main compartments and two 5" x 6" side compartments



SUG. RETAIL.....\$28.95

PART # H50-103BK

TOUR TRUNK LINER

FOR HONDA GL1500/1800 GOLD WING

- Makes loading and unloading trunks easy and convenient
- Made of sturdy, weather-resistant, urethane-coated nylon
- Handy carrying handles



SUG. RETAIL.....\$20.95

PART # 3516-0035

TANK POUCH

FOR HONDA GL1500/1800

- Made of marine-grade vinyl, this pouch fits neatly on the gas tank door
- Extra carrying space without the bulk of a tank bag



HPNL-47

FITS MODEL	PART #	SUG. RETAIL
GL1500 88-00	HPNL-47	\$28.95
GL1800 01-08	H18TPVBK	28.95

CUSTOM FAIRING POCKET COVERS

FOR HONDA GL1200 84-87

- Innovative design incorporates a handy sunglass case/pocket into the cover
- Custom snaps will not pull through material
- Pockets on covers are hinged for ease of entry
- Available in black



SUG. RETAIL.....\$29.95

PART # HPNL-21

TANK MAP POCKET

FOR HONDA GL1800 GOLD WING 01-08

- Convenient see-through map pocket made of quality marine-grade vinyl with non-marring back
- Rear slips onto Gold Wing tank door; front mounts with hook-and-loop strap



SUG. RETAIL.....\$19.95

PART # HPNL-18MP



FRONT BRAKE/ CLUTCH RESERVOIR CAP

FOR HONDA GL1800 GOLD WING 01-08 (ALL)

- CNC-machined from billet aluminum and highly polished
- Design features a clean appearance without logos for a smooth, custom look
- Polished stainless steel screws included; sold each

SUG. RETAIL.....**\$41.95**

PART # 1731-0101



CLEAR TURN SIGNAL LENSES

FOR HONDA GL1800
GOLD WING 01-06

- Direct replacement for stock amber signal lenses
- Lenses give you a true clear look; also available with smoke lenses
- Amber bulbs included
- Sold in pairs
- DOT approved

LENS COLOR	PART #	SUG. RETAIL
Clear	2020-0166	\$66.95
Smoke	2020-0227	59.95



EXHAUST

TIRES &
ACCESSORIES

LUGGAGE

SPORTBIKE
ACCESSORIES

CRUISER
ACCESSORIES

TOURING
ACCESSORIES

SECURITY
& AUDIO

GENERAL
ACCESSORIES

FAIRINGS
& BODY

SEATS

HANDLEBARS
& CONTROLS

LIGHTING

ELECTRICAL

SPROCKETS

CHAINS

BRAKES

SUSPENSION

ENGINE

FUEL SYSTEMS

LUBES

TOOLS

TRAILER

MERCH.

CROSS
REFERENCE

INDEX



OEM REPLACEMENT MIRRORS

FOR HONDA GL1200, GL1100 INTERSTATE

- High-quality, true-vision replacement mirrors
- GL1100 mirrors are chrome-plated
- GL1200 mirrors are black with brushed-finished back
- Sold each

FITS MODEL	LEFT SIDE	RIGHT SIDE	SUG. RETAIL
HONDA			
GL1100 80-83	2087002	2087001	\$17.95
GL1200 84-87	2087052	2087051	35.95



CHROME PASSENGER FLOORBOARDS

FOR GL1000/
1100 75-83

- Chromed-steel passenger floorboards feature a ribbed pattern
- Sold in pairs

DESCRIPTION	PART #	SUG. RETAIL
Passenger floorboards	DS-720233	\$76.95
Repl. rubber (pr.)	DS-720282	10.95



deluxeCAM CAMERA MOUNT

FOR ALL GOLD WING MODELS

- All Leader hardware is machined aluminum and chrome-plated
- Leader hardware features a patented slot-and-lug design that makes all parts interchangeable (including RoadRunner drink holder)
- deluxeCAM features eCaddy Deluxe's extraordinary durability paired with a PanaVise adjustable, flexible swivel camera mount
- Mounts a camera to left hand or right hand controls on Gold Wings, controls every angle and helps to ensure camera will never fall off
- Chrome mounting hardware looks like it belongs on the motorcycle; easy to install with no special tools required
- Made in the U.S.A.

SUG. RETAIL.....**\$108.95** PART # 0615-0111

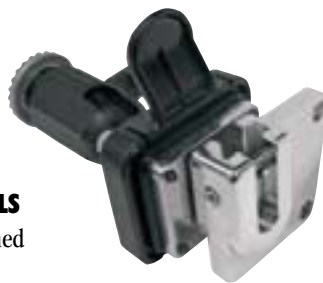

ROADRUNNER BIKE CUP WITH HOLDER

FOR GL1500/GL1800 GOLD WING

- Hot or cold 16 oz. stainless steel cup features an insulated spill-proof lid
- Tapered cup drops into a specially-designed, chromed aluminum, 12-position holder designed specifically for left hand or right hand controls on Gold Wing models
- Made in the U.S.A.

SUG. RETAIL.....**\$79.95** PART # 0603-0093



0603-0131



0603-0134



eCADDY LITE AND eCADDY DELUXE

FOR ALL GOLD WING MODELS

- All Leader hardware is machined aluminum and chrome-plated
- Leader hardware features a patented slot-and-lug design that makes all parts interchangeable (including RoadRunner drink holder)
- eCaddy Lite is ideal for mounting most items with standard belt clips, including cell phones, satellite radios, MP3 players, CBs and lighter GPS units; plate area measures 1³/₈" x 2⁷/₈" x 5¹/₁₆"
- eCaddy Deluxe is ideal for mounting larger GPS units and XM satellite; plate area measures 1¹³/₁₆" x 1¹/₂" x 5¹/₁₆"
- Two-piece kits mount on the left hand or right hand handlebar control
- Multi-faceted lugs offer secure mounting at six different angles
- eCaddy Deluxe works with the standard four-hole "AMPS" pattern (1¹/₂" x 1¹/₄")
- eCaddy Deluxe also works with diamond shaped "RAM" pattern (plate area: 1¹³/₁₆" x 1¹/₂" x 5¹/₁₆"), however some units will require a cradle between component and eCaddy
- Made in the U.S.A.

SUG. RETAIL.....**\$64.95**

DESCRIPTION	PART #
eCaddy Lite	0603-0131
eCaddy Deluxe	0603-0134

All part numbers in **BOLD MAGENTA** are new this year.



SR-i900 RFID MOTORCYCLE SECURITY SYSTEM

- The SR-i900R is a new generation two-way FM security system offering hands-free RFID technology
- Simply walk towards or away from your bike, and the remote transceiver will automatically communicate an arm or disarm command using its proximity recognition system
- This unique auto-arm and hands-free disarm operation provides the highest standard of security and convenience
- Standard features include:
 - RF-ID for hands-free operation
 - Programmable auto or manual arming and disarming
 - Long-range FM transceiver (up to a 1/2 mile)
 - Range and signal status display
 - Compact design (3 1/16" x 2 3/4" x 7/8")
 - Dual-axis accelerometer for detecting impact/inclination
 - Built-in 120 dB multi-tone siren with soft chirp
 - Sensor violation display
 - Audible/vibrating alert
 - Remote motorcycle finder/panic alarm
 - Programmable perimeter sensor with warn away that detects motion around the bike, protecting saddlebags, luggage and accessories
 - Built-in battery backup system allows the pager to operate even if wires are cut or circumvented
 - Ignition disable feature allows the user to remotely cut off the engine in case of hijack
 - Includes charging cord for remote receiver
 - Factory connector kits allow the alarm system to be integrated into the OEM-style harness without any cutting or splicing (sold separately, see page 514)

NOTE: Includes module, mounting kit and hardwire kit (not shown)



SUG. RETAIL.....**\$439.95**

PART # **4020-0052**

SR-i800 RFID MOTORCYCLE SECURITY SYSTEM

- The SR-i800R is a new generation two-way FM security system offering hands-free RFID technology
- Simply walk towards or away from your bike, and the remote transceiver will automatically communicate an arm or disarm command using its proximity recognition system
- This unique auto-arm and hands-free disarm operation provides the highest standard of security and convenience
- Standard features include:
 - Passive arm disarm
 - Built in G sensor
 - Programmable perimeter sensor
 - Back up battery
 - Flash loadable MCU (enables future software upgrades)
 - RS232 data output for additional option (GPS tracking, external lights, saddle bags/trunk locking, air horn)
- Factory connector kits allow the alarm system to be integrated into the OEM-style harness without any cutting or splicing (sold separately, see page 514)

NOTE: Includes module, mounting kit and hardwire kit (not shown)



SUG. RETAIL.....**\$219.95**

PART # **4020-0065**

SR-i600 SERIES TWO-WAY FM TRANSCEIVER – CONTROLLED MOTORCYCLE ALARMS

- Ultra-compact two-way FM security system with waterproof remote
- Include a handheld LCD transceiver that features both pager and remote functions
- Transceiver constantly monitors and displays the current alarm status and confirms all commands with easy-to-understand icons and text
- From up to 1/2 mile away, the two-way remote allows the user to control all of the alarm functions as well as receiver detailed information on the motorcycle's status
- Two-axis digital accelerometer detects both impacts and inclination; module can be placed in any position or mounting angle and requires no adjustments
- Include a built-in 120 dB programmable multi-tone siren with soft chirp arm/disarm feature
- Other standard features include: audible/vibrating alert, smart battery safeguard, sensor violation display, range and signal status display, clock with alarm, motorcycle battery condition display, rolling codes, ignition sensor, flashing light with memory, key lock and remote motorcycle finder
- PART # 4020-0049 also features a programmable perimeter sensor that detects motion around the bike, protecting saddlebags, luggage, etc., and a built-in battery backup system that allows alarm to function even if battery wires are cut
- PART # 4020-0050 also features a anti-hijack/ignition disable module that allows the user to remotely cut off the engine in case of a hijack situation
- Factory connector kits allow the alarm system to be integrated into the OEM-style harness without any cutting or splicing (sold separately, see page 514)

NOTE: Includes module, mounting kit and hardware kit (not shown).



4020-0049

DESCRIPTION	PART #	SUG. RETAIL
SR-i600 two-way FM alarm w/ silver/orange remote	4020-0049	\$319.95
SR-i600SE two-way FM alarm w/ silver/orange remote, anti-hijack/ignition disable module, perimeter sensor module, and battery back-up	4020-0050	399.95



SR-C400 SECURITY SYSTEM

- All new SR-c400 offers two-way FM technology incorporating a small LED transceiver and an ultra-compact module, offering a perfect solution for limited-space vehicles
- Standard features include a long-range FM transceiver with a range of up to 1/2 mile
- Built-in 120 dB siren with soft chirp
- Dual-axis accelerometer for detecting impact/inclination
- Sensor violation notification
- Range confirmation status
- Audible/vibrating alert
- Remote motorcycle finder/panic alarm
- Smart battery safeguard with motorcycle battery condition display
- Built-in battery backup system that allows the pager and siren to operate even if wires are cut or circumvented
- Main control module measures 23/16" L x 37/16" W x 15/16" H
- Optional programmable perimeter sensor available (sold separately, see below)
- Factory connector kits allow the alarm system to be integrated into the OEM-style harness without any cutting or splicing (sold separately, see page 514)

NOTE: Includes module, mounting kit and hardware kit (not shown).



SUG. RETAIL.....**\$329.95** PART # **4020-0031**

OEM 500i FACTORY-STYLE PLUG-IN SECURITY SYSTEM

- State-of-the-art factory-style security system
- Incorporates the analog-devices dual-axis acceleration sensor
- Two-axis digital accelerometer detects both impact and inclination with an extremely high degree of accuracy; module can be placed in any position or mounting angle and requires no adjustments
- Loud 120 dB programmable multi-tone siren with soft-chirp arm/disarm feature
- Waterproof three-button remote transmitter with rolling-code feature
- Flashing lights with memory display
- Manual- and auto-arming feature
- Optional anti-hijack kit and perimeter sensor available (sold separately, see below)
- Optional OEM-style factory connector kits allow the alarm system to be integrated into the factory wiring without any cutting or splicing (sold separately, see page 514)

NOTE: Includes module, mounting kit and hardware kit (not shown).



SUG. RETAIL.....**\$139.95** PART # **4020-0003**

4020-0041

4020-0051



ALARM ACCESSORIES

- Programmable perimeter sensor with warn-away detects motion around the bike, protecting saddlebags, luggage and accessories; built-in battery backup system allows the pager to operate even if wires are cut or circumvented
- Ignition disable allows the user to remotely cut off the engine in case of a hijack (included with PART #4020-0006)
- Remote transceiver 4020-0041 is impact-resistant/waterproof and comes with a rechargeable battery and charger (included with PART #4020-0034)

DESCRIPTION	PART #	SUG. RETAIL
Ignition disabler/anti-hijack kit for PART #S 4020-0003, 4020-0034, 4020-0048 and 4020-0049	4020-0007	\$29.95
Perimeter sensor for PART #S 4020-0003, 4020-0031 and 4020-0049	SN-4	49.95
Repl. or add-on silver remote transceiver for PART #S 4020-0034, 4020-0048, 4020-0049 and 4020-0050	4020-0041	99.95
Repl. or add-on black remote transceiver for PART #S 4020-0034, 4020-0048, 4020-0049 and 4020-0050	4020-0051	99.95

All part numbers in **BOLD MAGENTA** are new this year.

- EXHAUST
- TIRES & ACCESSORIES
- LUGGAGE
- SPORTBIKE ACCESSORIES
- CRUISER ACCESSORIES
- TOURING ACCESSORIES
- SECURITY & AUDIO**
- GENERAL ACCESSORIES
- FAIRINGS & BODY
- SEATS
- HANDLEBARS & CONTROLS
- LIGHTING
- ELECTRICAL
- SPROCKETS
- CHAIN
- BRAKES
- SUSPENSION
- ENGINE
- FUEL SYSTEMS
- LUBES
- TOOLS
- TRAILER
- MERCH.
- CROSS REFERENCE
- INDEX



FACTORY CONNECTOR KITS

• Allow all Scorpio alarms to be integrated into the OEM-style harness without any cutting or splicing

SUG. RETAIL..... **\$24.95**



FITS MODEL	PART #
AMERICAN IRON HORSE	
All models 00-06	4020-0008
All models 07	4020-0053 ²
BIG DOG	
All models 00-02	BD-1
All models 05-07	4020-0032 ¹
CAN-AM	
Spyder 07-08	4020-0056 ³
DAUCATI	
MultiStrada 620/1000 04-06	4020-0028
Superbike 749/999 04-06	4020-0028
Monster 620/900/1000 02-08	4020-0029
Sport 1000/GL 1000 06-08	4020-0046
Superbike 848/1098 07-08	4020-0055
HARLEY-DAVIDSON	
Sportster 97-03	HD-1
Dyna 97-08	HD-1
Softail 97-08	HD-1
Roadking 97-06	HD-1
Glides 97-06	HD-1
Sportster 04-08	4020-0022
V-Rod 04-08	4020-0022
Electra Glides/Road King 07-08	4020-0054
HONDA	
CBR600F3/F4/F4i 97-06	HON-2
CBR600RR 03-06	4020-0023
CBR600RR 07-08	4020-0024
CB750 Nighthawk 95-03 (all)	HON-3
VT750 Shadow 97-03 (all)	HON-3
VT750 Shadow 04-08 (all)	4020-0024
VFR800 98-07	HON-1
CBR900RR/929RR/954RR 95-03	HON-2
CBR 919 02-06	4020-0025
CBR929RR 00-01	HON-2
CBR1000RR 03-07	4020-0023
CBR1000RR 08	4020-0024
RC51 00-06	HON-2
VTR1000F Super Hawk 98-05	HON-3
CBR1100XX 97-07	HON-2
ST1100 97-02	4020-0010
VT1100 95-03 (all)	HON-3
VT1100 04-08 (all)	4020-0024
VTX1300 00-05	HON-3
VTX1300S 05-08	4020-0061 ³
GL1500 88-00	HON-3
VTX1800 00-02	HON-3
VTX1800 05-08	4020-0035
GL1800 Gold Wing 00-01	HON-4
VTX1800F 05-08	4020-0062 ³
INDIAN	
Chief 99-01	IND-1

FITS MODEL	PART #
INDIAN (CONT)	
Scout/Sprint 99-03	IND-1
Chief 02-03	4020-0009
KAWASAKI	
EX250 Ninja 08	4020-0012
EX250 Ninja 07	4020-0059 ³
EX500 Ninja 07	4020-0060 ³
ZX-6 93-02	KAW-3
ZX-6R 97-02	KAW-1
ZX-6R 03-08	4020-0012
ZZR600 03-04	4020-0012
ZZR600 05-06	KAW-1
EX650R Ninja 06-07	4020-0012
ZR-7S 01-03	KAW-1
ZX-7R 96-03	KAW-2
Z750S 05-06	4020-0012
VN800 Vulcan 95-05	4020-0037
VN900 Vulcan 08	4020-0058 ³
VN900 Vulcan 06-07	4020-0037
ZX-9R 98-02	KAW-2
ZX-9R 03	KAW-1
Z1000 06-08	4020-0012
ZX-10R 04-05, 08	4020-0012
ZX-10R 06-07	4020-0042
ZX-11 93-02	KAW-3
ZG1200 Voyager 86-03	4020-0039
ZRX1200 01-05	KAW-1
ZX-12R 00-05	KAW-1
ZZR1200 02-04	4020-0011
ZN1300 Voyager 83-88	4020-0039
ZX-14 06-08	4020-0042
ZG1400 Concours 08	4020-0042
VN1500 Vulcan 87-97	4020-0037
VN1500 Vulcan 87-08 (except Drifter)	4020-0038
VN1500 Vulcan Drifter 99-06	4020-0036
VN1600 Vulcan 03-08	4020-0037
SUZUKI	
Burgman 400 03-08	4020-0040
GS500 94-02	SUZ-1
GSX650 Katana 00-04	SUZ-2
GSX650 Katana 05-06	SUZ-1
GSX-R600 97-02	SUZ-1
GSX-R600 03-05	4020-0015
GSX-R600 06-08	4020-0027
GSF600 Bandit 96-03	SUZ-1
Burgman 650 03-08	4020-0064 ³
DL650 V-Strom 03-04	4020-0014
DL650 V-Strom 05-07	4020-0040
SV650/S 98-02	SUZ-1
SV650/S 03-08	4020-0015
GSX750 Katana 00-04	SUZ-2

FITS MODEL	PART #
SUZUKI (CONT)	
GSX750 Katana 05-06	SUZ-1
GSX-R750 97-02	SUZ-1
GSX-R750 03-05	4020-0015
GSX-R750 06-08	4020-0027
VL800 Intruder 87-04	SUZ-3
DL1000 V-Strom 02	SUZ-1
DL1000 V-Strom 03-04	4020-0014
DL1000 V-Strom 05-07	4020-0040
GSX-R1000 01-02	SUZ-1
GSX-R1000 03-04	4020-0015
GSX-R1000 05-08	4020-0027
SV1000/S 03-08	4020-0015
TL1000R 98-02	SUZ-1
TL1000S 97-01	SUZ-1
GSF1200S Bandit 97-05	SUZ-1
GSX1300R Hayabusa 99-07	SUZ-1
GSX1300R Hayabusa 08	4020-0027
Boulevard 05-08 (except M50/M109)	SUZ-3
M50/M109 Boulevard 06-07	4020-0040
TRIUMPH	
All models 04-08	4020-0045
VESPA	
GT/GTS 05-08	4020-0047
VICTORY	
All models 05-08 (except Vision)	4020-0033 ¹
Vision 08	4020-0057 ³
YAMAHA	
FZ6 05-07	4020-0016
YZF600R 00-08	YAM-3
YZF-R6 97-99	YAM-2
YZF-R6 00-02	YAM-4
YZF-R6 03-08	4020-0016
XVS650 V-Star 99-04	4020-0018
FZ1 01-04	YAM-2
FZ1 05-07	4020-0016
YZF1000R 97	YAM-2
YZF-R1 98-01	YAM-2
YZF-R1 02-08	4020-0016
XVS1100 V-Star 99-04	4020-0018
VMX1200 V-Max 85-04	4020-0018
FJR1300 03-05	4020-0017
FJR1300 06-08	4020-0044
XVZ1300 Royal Star 96-08	4020-0018
XV1600/1700 Road Star 99-08	4020-0018
XV1900 Roadliner/Stratoliner 06-08	4020-0063 ³
XV1900 Raider 08	4020-0063 ³

¹ SUG. RETAIL \$25.95
² SUG. RETAIL \$49.95
³ SUG. RETAIL \$29.95

CYCLE ALARM WITH REMOTE TRANSMITTER



- Powerful five-tone 120 dB piezo siren
- Remote transmitter operation
- Adjustable shock sensor with seven levels of sensitivity to match your surroundings
- Programmable five-tone siren allows you to pick the siren tone you want
- Warn-away mode sounds warning prior to full alarm activation
- 100% waterproof
- Panic feature enables you to activate the alarm siren from up to 100' away
- Includes everything needed for a simple under-20-minute installation

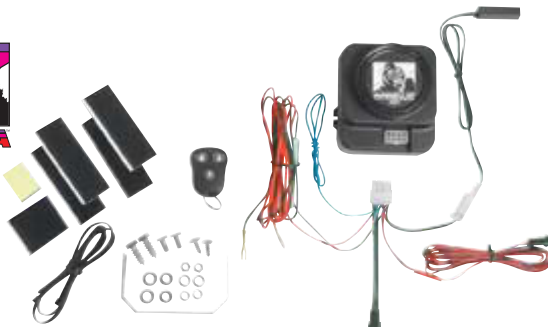

SUG. RETAIL..... **\$114.95**

PART # **4020-0019**



RADAR DETECTOR MOUNT KIT

- Mount kit allows most radar detectors to be mounted to 7/8" or 1" diameter handlebars
- Black anodized aluminum with a 3/16" clear-acrylic mounting plate
- Measures 4 1/4" L x 3 1/4" W

DESCRIPTION	PART #	SUG. RETAIL
For 7/8" dia. handlebars	RM	\$38.95
For 1" dia. handlebars	RM-1	34.95

**ROADLOK® DEFENDER™ DISC LOCK
FOR VICTORY 03-09 (ALL EXCEPT VISION)**



- Unique motorcycle locking system which prevents the motorcycle from moving and cannot cause damage if you forget to unlock it before trying to ride
- Permanently mounts to the left side front fork of your motorcycle
- Billet aluminum construction
- BrakeBolt™ hardened stainless steel locking pin
- ABLOY™ EXEC locking mechanism
- Two RoadLoK® specific keys (prevents unauthorized duplication)
- ReKey™ secure key replacement program
- Features theft-deterrent lanyard, dome decal, all necessary mounting hardware and installation instructions
- 100% made in the U.S.A.

DESCRIPTION	PART #	SUG. RETAIL
Polished	4010-0147	\$289.95
Chrome	4010-0148	309.95

4010-0149

4010-0147

4010-0150

DESCRIPTION	PART #	SUG. RETAIL
Black satin anodized	4010-0149	\$289.95
Clear satin anodized	4010-0150	289.95

MAX60 U-LOCK



- Short-shackle disc U-lock
- Features three flat keys with one key equipped with a mini flashlight, and a durable PVC sleeve covers the chrome shackle to prevent marring and scratching
- The hardened solid steel lock prevents prying, sawing and hammer impacts
- Ideal for motorcycles, spare tires, trailers, ATVs, snowmobiles and watercraft



SUG. RETAIL.....\$34.95

PART # 4010-0072

REMINDER CABLE

- Dual-loop reminder cable for disc locks

SUG. RETAIL.....\$7.95

PART # 4010-0008



ULTRA-HIGH-SECURITY DISC/CABLE LOCKS

- For use on motorcycle discs and looped cables
- The strongest short-shackle locks available

SUG. RETAIL.....\$29.95

COLOR	PART #
Max 40, black	4010-0057



4010-0057

COLOR	PART #
Max 40, yellow	4010-0058

ULTRA-MAX SUPER STRENGTH U-LOCKS

- Ultra-Max 90 maximum-security lock features hardened chromoly construction with an oversize 16mm shackle; Max 80 is ideal for most motorcycle or bicycle applications and uses a 14mm shackle
- Ultra-Max 90 is constructed from hardened chromoly steel and features an exclusive dual shear plate locking mechanism
- Dual case bolt lock withstands more than 6.5 tons of pull force; shackle can withstand more than 8,000 lb. of expansion force
- Shackle length and width specifically designed for motorcycles; hardened chromoly lock body
- Max 80 features a hardened lock body
- Both feature locking mechanisms placed in the center of a hardened chromoly crossbar for maximum strength, seven-pin tubular pick-and-drill-resistant lock cylinders and ballistic-grade polymer lock body housings to resist hammer strikes and scratching of painted surfaces
- Shackles have protective PVC skins



4010-0003

4010-0004

DESCRIPTION	PART #	SUG. RETAIL
Max 80 (14mm)	4010-0003	\$32.95
Ultra-Max 90 (16mm)	4010-0004	55.95

TRIMAFLEX® COILED CABLE LOCKS

- High-strength Trimaflex quadra-braid cable with PVC protective coating to prevent surface scratching
- Lock mechanisms are covered in rugged plastic for durability and trouble-free use



4010-0015 4010-0017

DESCRIPTION	PART #	SUG. RETAIL
72" cable w/ U-lock	4010-0015	\$43.95
72" cable w/ combination lock	4010-0016	17.95
72" cable w/ quick-release lock	4010-0017	17.95

GLADIATOR SERIES ARMORED CABLES

- Indestructible maximum-security armor-plated cable locks
- Plastic-covered braided stainless steel covers with patented hardened armor-plated steel cups that repel saw cuts and bolt cutters
- Flexible for easy transport
- Ballistic-grade polymer lock housing cover resists hammer strikes; protects lock mechanism
- Patented key cover resists grime and moisture



DESCRIPTION	PART #	SUG. RETAIL
48" x 26mm dia.	4010-0010	\$50.95
72" x 26mm dia.	4010-0011	59.95
36" x 22mm dia.	4010-0012	29.95

All part numbers in **BOLD MAGENTA** are new this year.

- EXHAUST
- TIRES & ACCESSORIES
- LUGGAGE
- SPORTBIKE ACCESSORIES
- CRUISER ACCESSORIES
- TOURING ACCESSORIES
- SECURITY & AUDIO
- GENERAL ACCESSORIES
- FAIRINGS & BODY
- SEATS
- HANDLEBARS & CONTROLS
- LIGHTING
- ELECTRICAL
- SPROCKETS
- CHAINS
- BRAKES
- SUSPENSION
- ENGINE
- FUEL SYSTEMS
- LUBES
- TOOLS
- TRAILER
- MERCH.
- CROSS REFERENCE
- INDEX

EXHAUST
TIRES & ACCESSORIES
LUGGAGE
SPORTBIKE ACCESSORIES
CRUISER ACCESSORIES
TOURING ACCESSORIES
SECURITY & AUDIO
GENERAL ACCESSORIES
FRAMINGS & BODY
SEATS
HANDLEBARS & CONTROLS
LIGHTING
ELECTRICAL
SPROCKETS
CHAIN
BRAKES
SUSPENSION
ENGINE
FUEL SYSTEMS
LUBES
TOOLS
TRAILER
MERCH.
CROSS REFERENCE
INDEX

VERSA CABLE LOCK

- Multi-use versa cable lock
- Trimaflex cable with locking cinching feature
- 10' x 10mm

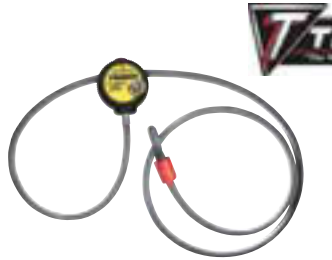

SUG. RETAIL..... \$25.95

PART # 4010-0071

MULTI-USE CABLE LOCKS

- Feature 10' x 10mm Trimaflex™ ultra-tough braided cable
- Great for use on bikes, bike carriers, trailers or watercraft on the beach



DESCRIPTION	PART #	SUG. RETAIL
10' x 10mm cable w/ resettable combination		
MAG series lock	4010-0049	\$21.95
48" cable lock	4010-0073	39.95
72" cable lock	4010-0074	45.95

4010-0026

4010-0060



ULTRA-MAX T-HEX™ SUPER CHAIN

- Hexagonal-shaped, case-hardened and triple-heat-treated; withstands over 6 tons of pulling force and 11 tons of cutting force
- Durable Nylonex™ sleeve protects against scratches
- Chain sold separately or with Tri-Max U-lock or integrated lock
- Chains with integrated locks feature noose link so chain can be looped

4010-0028

DESCRIPTION	PART #	SUG. RETAIL
3' T-Hex chain	4010-0026	\$47.95
5' T-Hex chain	4010-0027	59.95
3' T-Hex chain w/ U-lock	4010-0028	73.95
5' T-Hex chain w/ U-lock	4010-0029	85.95
36" / 8mm T-Hex chain w/ integrated lock	4010-0059	45.95
36" / 10mm T-Hex chain w/ integrated lock	4010-0060	38.95

RETRACTABLE CABLE LOCK

- Rugged three-digit resettable combination lock
- 36" L x 3mm dia. retractable cable



SUG. RETAIL..... \$21.95

PART # 4010-0050



4010-0013



4010-0052



4010-0014



TRIMAFLEX™ MAX SECURITY BRAIDED CABLES 4010-0053

- Quadra-braid cables
- Available with integrated lock or for use with Tri-Max disc and U-locks

DESCRIPTION	PART #	SUG. RETAIL
WITH KEYED CABLE LOCK		
32" x 15mm	4010-0013	\$24.95
72" x 15mm	4010-0014	32.95
DUAL-LOOP CABLES		
30' x 10mm	4010-0052	28.95

DESCRIPTION	PART #	SUG. RETAIL
DUAL-LOOP CABLES (CONT)		
15' x 10mm	4010-0053	\$17.95
12' x 12mm	4010-0054	17.95
8' x 15mm	4010-0055	17.95



4010-0018

4010-0019

RESETTABLE COMBINATION PADLOCKS

- Easy-to-use, resettable combination padlocks feature 2" W solid brass bodies and hardened shackles

SUG. RETAIL..... \$19.95

DESCRIPTION	PART #
1.25" x 5/16" dia. shackle	4010-0018
2.25" x 5/16" dia. shackle	4010-0019

WEATHER PROOF PADLOCK

- Rugged weather-resistant PVC housing covers laminated solid brass lock body
- Dual-locking 1 1/8" x 5/16" dia. hardened shackle

DESCRIPTION	PART #	SUG. RETAIL
Single padlock	4010-0001	\$9.95
Set of three keyed-alike padlocks	4010-0002	23.95



4010-0002

MAXIMUM SECURITY PADLOCKS

- Hardened chrome steel padlocks
- Commercial grade
- Ideal for enclosed trailers, forks, cases, or use with T-Hex™ chain and cargo boxes



4010-0023

4010-0022

DESCRIPTION	PART #	SUG. RETAIL
50mm square body, 1.25" x 10mm shackle	4010-0021	\$19.95
50mm square body, 2.25" x 10mm shackle, rekeyable	4010-0022	19.95
64mm round body, 1.25" x 11mm shackle, rekeyable	4010-0023	24.95
64mm round body, 2.25" x 11mm shackle, rekeyable	4010-0024	24.95

STAINLESS STEEL HIGH-SECURITY SHIELDED PADLOCKS

- 70mm round padlock with 10mm hardened shackle and exclusive armor-plated key core for additional security; and ultra-high secure 2 7/8" lock with solid steel body and hidden 3/8" dia. internal shackle
- Ideal for enclosed trailers, forks, cases with T-Hex™ chain and cargo boxes



4010-0025



4010-0020

DESCRIPTION	PART #	SUG. RETAIL
70mm stainless steel round padlock	4010-0020	\$15.95
2 7/8" solid steel body padlock	4010-0025	32.95

GERMAN  ENGINEERED

DETECTO 7000 RS SERIES LOCKS

- Combines electric and mechanic lock technology into one great lock
- The lock is directly bolted in one go when mounted on the brake disk
- Separate locking is no longer necessary
- Lock body and the square bolt are made from hardened steel
- In case of an attack a vibration sensor triggers a 110 decibel strong signal
- RS 2 functions are supported by optic signals (LED)



DESCRIPTION	PART #	SUG. RETAIL
RS 2		
Red	4010-0159	\$123.95
Yellow	4010-0160	123.95
RS 3		
Yellow	4010-0158	113.95

PROVOGUE 300 AND 305 BRAKE DISC LOCKS

- Small, handy, compact and secure
- Easy one-hand operation
- Impact-resistant solid cast metal with a shiny metal finish or colored rubberized surface
- Hardened alloy steel locking bolt: 10mm for Provogue 300 and 5mm for Provogue 305



SUG. RETAIL.....	\$54.95	
300 LOCK		
305 LOCK		
SUG. RETAIL.....	\$45.95	
COLOR	300	305
White	4010-0116	4010-0111
Red	4010-0117	4010-0112
Chrome	4010-0118	4010-0113
Gold	4010-0119	4010-0114
Black	4010-0120	4010-0115

STRADA 34 MINI BRAKE DISC LOCK

- Small (50mm), handy, compact and secure
- Special hardened steel construction
- All-around drill protection
- Double-bolted shackle
- Disc memory reminds you to detach the lock before starting
- ABUS EXTRA-Class cylinder with symmetrical dimple key



SUG. RETAIL.....	\$93.95
PART #	4010-0107

WBA 100 LOCK ANCHOR

- 16mm hardened steel shackle for extreme resistance against theft
- Indoor/outdoor use on floor or walls
- Flat shape and high-quality materials allow anchor to be driven over in fixed position
- Includes hardware



SUG. RETAIL.....	\$112.95
PART #	4010-0121

4010-0108



4010-0110



4010-0109

GRANIT VICTORY X-PLUS 68 BRAKE DISC LOCKS

- For very narrow brake discs
- ABUS-X-Plus locking system for extremely high protection against unlawful opening
- Disc memory reminds you to detach lock before starting
- Includes lighted key
- Optional carrier available separately

DESCRIPTION	PART #	SUG. RETAIL
Black brake disc lock	4010-0108	\$116.95
Yellow brake disc lock	4010-0109	116.95
Carrier	4010-0110	31.95

GRANIT QUICK MAXI AND MINI BRAKE DISC LOCK

- Special hardened steel construction
- Locking system features all-around drill protection
- ABUS-Plus locking system for extremely high protection against unlawful opening
- Includes disc memory to prevent forgetting lock in brake disc
- Manual cylinder cover
- Available in yellow



DESCRIPTION	PART #	SUG. RETAIL
70mm Maxi	4010-0105	\$144.95
53mm Mini	4010-0106	130.95

ELECTRONIC GRANIT DETECTO 800 BRAKE DISC LOCK

- Electronic brake disc lock with a 14mm hardened bolt
- 3-D position control for immediate alarm when position changes or shocks are detected
- High-quality steel lock has ABUS X-Plus locking for extreme protection against unlawful opening
- Includes batteries



SUG. RETAIL.....	\$247.95	PART #	4010-0104
-------------------------	-----------------	---------------	------------------

GRANIT EXTREME PLUS 59 CHAIN LOCKS

- Special hardened chain protects against theft from even the most aggressive mechanical attacks
- Chain link locks directly into lock
- Extreme resistance against pulling link out of lock
- ABUS-X-Plus locking system includes more than one million key variations



DESCRIPTION	PART #	SUG. RETAIL
66" x 12mm	4010-0090	\$523.95
55" x 12mm	4010-0091	466.95

All part numbers in **BOLD MAGENTA** are new this year.

GERMAN



ENGINEERED

GRANITE X-PLUS

- Links made from 5.5mm thick hardened special steel
- Protects against brutal opening methods
- Offers maximum flexibility for external securing
- Easy to transport

SUG. RETAIL.....\$154.95

PART # 4010-0157



GRANIT CITY X-PLUS 1060 CHAIN LOCKS

- 10mm hexagonal chain is as hard as granite with a high resistance to cutting, pulling and torsion
- ABUS Power Cell technology locks chain directly into lock body
- Interlocked lock housing protects against the most determined attacks
- ABUS X-Plus cylinder for high-picking protection
- Automatic keyhole cover

DESCRIPTION	PART #	SUG. RETAIL
66" x 10mm	4010-0094	\$222.95
55" x 10mm	4010-0095	213.95
43" x 10mm	4010-0096	195.95



4010-0094

GRANIT DETECTO ELECTRONIC CHAIN LOCK/ BRAKE DISC LOCK

- Combines famous ABUS disc brake lock with a hardened 47" x 12mm chain
- Electronic brake disc lock features 14mm special hardened bolt
- High-quality steel lock can be used without chain
- 3-D position control for immediate alarm when position changes or shocks are detected
- ABUS X-Plus locking system
- Includes batteries

SUG. RETAIL.....\$362.95

PART # 4010-0097



GRANIT VICTORY X-PLUS 68 CHAIN LOCK

- Combines famous ABUS brake disc lock with 18" x 12mm hardened steel chain
- Steel brake disc lock can be used separately
- ABUS X-Plus locking system for the highest protection against unlawful opening
- Includes lighted key and memory cable

SUG. RETAIL.....\$196.95

PART # 4010-0098



CITYCHAIN 1010 CHAIN LOCK

- Hardened 55" x 9mm chain with a robust textile webbing
- ABUS-Plus cylinder for high picking protection
- Automatic keyhole cover

SUG. RETAIL.....\$166.95

PART # 4010-0099



PLATINUM 34 CHAIN LOCKS

- Hardened 10mm square chain with fabric sleeve
- High-quality ABUS padlock for all-around protection
- Lock features a hardened shackle and body, plus extra shackle guard to protect against bolt cutter and sawing attacks

DESCRIPTION	PART #	SUG. RETAIL
78" x 10mm	4010-0092	\$166.95
55" x 10mm	4010-0093	146.95



4010-0092

WINNER 92 CHAIN LOCK

- Strong 55" x 8mm hardened square chain
- Lock features hardened shackle for extra protection against brutal attacks

SUG. RETAIL.....\$97.95

PART # 4010-0100



STEEL-O-FLEX 900 CABLE LOCKS

- Compact, flexible and secure
- Hardened steel shells around a strong 27mm Steel-O-Flex cable
- ABUS high-quality five-pin cylinder

DESCRIPTION	PART #	SUG. RETAIL
66" x 27mm	4010-0101	\$102.95
39" x 27mm	4010-0102	77.95



4010-0101

CENTURO 860 CABLE LOCK

- Hardened steel shells protect flexible 43" x 19mm steel cable
- ABUS cylinder features a self-locking mechanism

SUG. RETAIL.....\$48.95

PART # 4010-0103



DISC LOCKS

- State-of-the-art disc locks feature dual motion and shock sensor that trigger a 110 dB warning siren when bike is disturbed
- High-security key and barrel
- No switches to think about: arms and disarms automatically
- Include travel case, keys and pouch

XR1

- 0.25" (7mm) dia. double-locking pin
- 2" (49mm) of throat
- Features zinc alloy body construction
- Push-pin locking system

XX-6/XZN-6/XZZ-6

- Ideal for smaller bikes and scooters
- High-nickel-content stainless steel body
- Push-down locking system
- Ice spray-proof body and key barrel
- XZZ model features painted yellow body
- 1.7" (42mm) of throat
- 0.24" (6mm) dia. hardened-steel locking pin

XX-10/XX-14

- New design with a flared, attack-resistant body shape
- High nickel-content stainless-steel mono-block construction
- The shorter, squatter body gives it a sport and streetbike-oriented fit profile
- XX-10 features 1.92" (48mm) of throat with 0.4" (10mm) dia. carbide-reinforced hardened-steel locking pin
- XX-14 features 1.6" (41mm) of throat with 0.5" (14mm) dia. carbide-reinforced hardened-steel locking pin

DESCRIPTION	PART #	SUG. RETAIL
XR1		
Red	4010-0061	\$79.95
Yellow	4010-0062	79.95
Stainless	4010-0063	79.95
Chrome	4010-0081	84.95
Black/orange	4010-0082	84.95
XX-6		
Stainless/yellow	4010-0151	84.95
Stainless	4010-0152	89.95
XZN-6		
Yellow	4010-0155	79.95



4010-0061



4010-0062



4010-0065



4010-0081

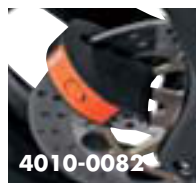

4010-0082



4010-0151



4010-0155



4010-0156



4010-0179



4010-0154



4010-0076



4010-0080

XH-14/XN-14

- 0.5" (14mm) dia. double-locking pin
- 1.84" (46mm) of throat
- XH-14 features inert-gas-hardened steel
- XN-14 features high-nickel-content stainless steel body
- Double-barrel locking system

XE-15/XN-15

- 0.5" (14mm) dia. locking pin
- 2.5" (62mm) of throat
- XE15 features hardened-steel body
- XN15 features high-nickel-content stainless steel body
- Double-barrel locking system

DESCRIPTION	PART #	SUG. RETAIL
XZZ-6		
Stainless	4010-0156	\$84.95
XX-10		
Yellow	4010-0153	105.95
XN14		
Stainless	4010-0079	99.95
XX-14		
Stainless	4010-0154	114.95
XH-14		
Black/yellow	4010-0076	99.95



XN-18

- Features re-inforced carbide substructure
- 120 dB warning siren
- Flashing blue LED armed signal
- Fortified barrel with carbide underpinning
- Four-pin locking system
- Fully removable unique key barrel
- 2.6" (65mm) of throat
- 0.72" (18mm) dia. locking pin

DESCRIPTION	PART #	SUG. RETAIL
XE15		
Yellow/black	4010-0064	\$99.95
XN-15		
Stainless	4010-0065	109.95
XN-18		
Carbide	4010-0080	199.95
REPLACEMENT BATTERY		
For all lock models (except XN18) (ea.)		
(comes in 6 pk)	4010-0075	6.95



XV CABLE LOCK

- High-security high-tensile steel cable for use with all Xena locks, except XN18
- 6 1/2' L
- Disc lock not included

SUG. RETAIL.....\$69.95

PART # 4010-0083



4010-0088

CLAW ADAPTOR

- Lets you lock a chain with your Xena disc-lock alarm
- Ideal for use with Xena or other generic chain
- Perfect for ground anchoring bike or other vehicle
- Stainless steel construction

DESCRIPTION	PART #	SUG. RETAIL
For XM14/XH14/XN14 disc lock	4010-0087	\$41.95
For XE15/XN15 disc lock	4010-0088	44.95
For XN18 disc lock	4010-0089	53.95



DISC LOCKS

- Made of hardened steel to prevent roll-away theft
- Disc lock has a 5mm locking pin
- Inside slot measures 5/16" W x 2 3/4" L
- Mounting kit can be attached in an out-of-the-way location on motorcycle

SUG. RETAIL.....\$27.95

COLOR	PART #
Black	1703-10-001
Red	1703-10-002
Chrome	1703-10-003

All part numbers in **BOLD MAGENTA** are new this year.

- EXHAUST
- TIRES & ACCESSORIES
- LUGGAGE
- SPORTBIKE ACCESSORIES
- CRUISER ACCESSORIES
- TOURING ACCESSORIES
- SECURITY & AUDIO
- GENERAL ACCESSORIES
- FAIRINGS & BODY
- SEATS
- HANDLEBARS & CONTROLS
- LIGHTING
- ELECTRICAL
- SPROCKETS
- CHAINS
- BRAKES
- SUSPENSION
- ENGINE
- WHEEL SYSTEMS
- LUBES
- TOOLS
- TRAILER
- MERCH.
- CROSS REFERENCE
- INDEX



- EXHAUST
- TIRES & ACCESSORIES
- LUGGAGE
- SPORTBIKE ACCESSORIES
- CRUISER ACCESSORIES
- TOURING ACCESSORIES
- SECURITY & AUDIO
- GENERAL ACCESSORIES
- FAIRINGS & BODY
- SEATS
- HANDLEBARS & CONTROLS
- LIGHTING
- ELECTRICAL
- SPROCKETS
- CHAINS
- BRAKES
- SUSPENSION
- ENGINE
- FUEL SYSTEMS
- LUBES
- TOOLS
- TRAILER
- MERCH.
- CROSS REFERENCE
- INDEX



DSR-1003G DIGITAL RECORDER AND CAMERA SYSTEM

- Complete system lets you record your ride
- Now features 3GP technology – saves videos in 3GP format
- Improved video color and detail
- Built-in MP3 player allows you to listen to music, now includes Thumper helmet speakers
- Can be used as an active rearview camera system
- Weatherproof, bullet-style camera has a rugged aluminum housing and weatherproof connectors
- Digital recorder/playback unit has full-color display, records video and audio from camera and remote-mount microphone
- Records using standard compression and file formats
- Saves videos in 320x240 resolution at 30 frames/second
- Accepts SD cards up to 4GB in size (1 GB SD card equals four hours of video/audio recording)
- Color LCD and built-in speaker for on-the-go playback or rearview use
- Helmet speakers included
- Uses USB connection for transfer of video/audio files to a computer
- Analog RCA video/audio output allows you to play videos direct to TV
- Includes multiple camera mounts, all necessary hardware and adapters for battery-powered operation and 12V DC power cable for operation off of the vehicle battery
- All cables and accessories included in convenient carrying case
- Replacement bike camera mount and helmet camera mounts available separately
- DSR DC5 power adapter cable powers and charges the DSR-100 recorder from the vehicle's battery or any other 12V DC power supply
- Regulates and filters the DC voltage
- Power cable measures approximately 6'

4402-0057

4402-0037

4402-0038

4402-0056



4402-0038

DESCRIPTION	PART #	SUG. RETAIL
DSR-100 3G camera/recorder kit	4402-0057	\$359.95
Bike camera mount	4402-0037	9.95
Helmet/universal camera mount	4402-0038	9.95
DSR DC5 power adapter cable	4402-0056	29.95

RIDERLINK ST-1

- Full-duplex driver-to-passenger intercom
- System includes driver and passenger headsets; each headset comes with full-face and open-face-style microphones
- Speakers are music grade with excellent base response
- Music input with built-in amplifier (adapter cable included)
- Mobile phone input with included adapter cable
- Two-way radio input with two adapter cables and PTT switch; cable is compatible with Motorola, Cobra, Midland and many other two-way radio brands
- Radar detector/GPS audio input with included adapter cable
- Built-in FM radio with seek and volume controls
- Auto-mute circuit and microphone sensitivity control
- All adapter and extension cables are included and removable when not in use
- All mini DIN connections feature weatherproof moldings
- Durable mounting straps with high-impact plastic buckles
- Portable battery-powered unit (uses 2AA batteries)
- Main unit measures 2.75" W x 4" H, approximately 1" thick

SUG. RETAIL..... **\$189.95**

PART #

4402-0031



SIDEKICK SK-1000 COMMUNICATOR

- Complete communications system for all types of powersports uses
- GMRS hand-held 2-way radio can be used on or off the machine; has a range of up to 10 miles
- Universal helmet headset includes full-face and open-face microphones
- Modular 3-way adapter cable design and coiled extension cables provide flexible mounting options
- All push-to-talk switches and connectors are weatherproof
- Rechargeable battery pack and desktop charger included
- All necessary installation accessories included
- Sold each



SUG. RETAIL.....\$149.95 PART # 4402-0036

- EXHAUST
- TIRES & ACCESSORIES
- LUGGAGE
- SPORTBIKE ACCESSORIES
- CRUISER ACCESSORIES
- TOURING ACCESSORIES

- SECURITY & AUDIO**
- GENERAL ACCESSORIES

- FAIRINGS & BODY
- SEATS
- HANDLEBARS & CONTROLS

- LIGHTING
- ELECTRICAL
- SPROCKETS

- CHAINS
- BRAKES
- SUSPENSION

- ENGINE
- FUEL SYSTEMS
- LUBES

- TOOLS
- TRAILER
- MERCH.
- CROSS REFERENCE
- INDEX



MAGNUM® F14 COMMUNICATOR HEADSETS

- All headset/communicator connectors are weatherproof with easy-connect waterproof plugs and molded strain reliefs
- All cables have generous length and coiled sections
- Full-face microphone headsets have button microphone; open-face helmet headsets have boom microphone
- All headset kits include helmet-mount dual-speaker set and microphone, handlebar-mount PTT switch, interface cable and all necessary mounting hardware
- Optional small push-to-talk switch with 20" cord available separately
- MXR-1 music mixer cable is a 2-way radio inline switch box
- Allows the addition of a music player or other audio device (MP3 player, CD player, etc.) to a MotoComm MC- or SK-series headset

DESCRIPTION	PART #	SUG. RETAIL
FULL-FACE HEADSETS		
Compatible w/ Motorola TalkAbout 200, 250, Distance (DPS) and most GMRS/FRS radios w/ separate speaker and microphone jacks	MC-551	\$59.95
Compatible w/ Motorola TalkAbout 280SLK, T289, fr50, fr60, T6300, T6310, T6320, Sprint GT and Sprint GT+	MC-552	59.95
Compatible w/ Garmin RINO 110, 120 and 130 series 2-way radios	4403-0006	59.95
OPEN-FACE HEADSETS		
Compatible w/ Motorola TalkAbout 200, 250, Distance (DPS) and most GMRS/FRS radios w/ separate speaker and microphone jacks	MC-751	59.95
Compatible w/ Motorola TalkAbout 280SLK, T289, fr50, fr60, T6300, T6310, T6320, Sprint GT and Sprint GT+	MC-752	59.95
Compatible w/ Garmin RINO 110, 120 and 130 series 2-way radios	4403-0007	59.95
ACCESSORIES		
Small PTT (push-to-talk) switch w/ 20" cord	4403-0008	19.95
Headset extension cable, 6-pin	EXT-6	14.95
MXR-1 music mixer cable	4403-0028	29.95

THUMPER 1 ENHANCED BASS HELMET SPEAKERS

- Enhanced bass response speakers for your helmet
- Install using hook-and-loop backing material
- Weatherproof connectors
- Coiled extension cable included
- Speakers measure less than 1/2" thick and just 1 1/2" diameter (2" diameter with speaker covers installed)
- See merchandising section for speaker display



SUG. RETAIL.....\$24.95 PART # 4403-0043

All part numbers in **BOLD MAGENTA** are new this year.

N-COM COMMUNICATION SYSTEM



- Nolan's N-COM system allows the freedom to talk on a mobile phone, listen to music on an MP3 player, get directions from a GPS navigation system, connect to a bike-to-bike radio, connect to some bikes' existing audio systems or talk to a passenger via intercom
- N-COM is for use with Nolan N-COM-ready helmets (like the N42/E, N84, N102/S and N103) and offers multiple configurations

N-COM MOBILE

- Utilizes the N-COM Basic Kit to connect to a mobile phone using a model-specific mobile wire accessory (not available from Drag Specialties) or to a multimedia source (MP3, CD, GPS, etc.) using a multimedia wire accessory (sold separately)
- Requires Basic Kit only

N-COM INTERCOM

- Allows all the features of N-COM MOBILE but adds the ability to speak with their passenger (passenger must also have N-COM Basic Kit installed)
- Can also be connected to some bikes' existing audio systems using motorcycle audio wire accessory
- Requires Basic Kit and Intercom E-Box

N-COM BLUETOOTH®

- Allows all the features of N-COM MOBILE but adds the ability to connect to a Bluetooth mobile phone, GPS unit or another N-COM BLUETOOTH helmet within range
- Can also be connected to some bikes' existing audio systems using motorcycle audio wire accessory
- Requires Basic Kit and Bluetooth E-Box



N-COM COMPONENTS

- Basic Kit includes earphones, microphone and leads for connecting devices and charger; installs easily in minutes without tools or modification
- Intercom E-Box fits in the side of an N-COM helmet and includes a 110V charger, a rechargeable lithium battery and an intercom wire; allows rider to answer phone and control volume directly from their helmet
- Bluetooth E-Box fits in the side of an N-COM helmet and includes a 110V charger and a rechargeable lithium battery; allows rider to answer phone, connect/disconnect with other N-COM BLUETOOTH helmet and control volume directly from their helmet

ACCESSORIES

- Standard multimedia wire "S" connects any device with a 3.5mm, 4-pole audio port
- GPS multimedia wire "T" connects Garmin Quest and Quest 2
- GPS multimedia wire "U" connects TomTom Rider and Garmin 2610, 2720 and 2820
- GPS multimedia wire "V" connects Garmin 2820, Zumo 400, Zumo 450, Zumo 500 and Zumo 550
- Bike-to-bike multimedia wire "K" includes push-to-talk button and connects Alan 445 and BT and Midland GXT600, GXT600VP4, GXT650VP1, GXT650VP4, LXT420, LXT420VP3, LXT320, LXT320VP3, GXT500, GXT550VP1, GXT500VP4, GXT550VP4, LXT410, LXT410VP3, GXT400, GXT450VP1, GXT450VP4, LXT300, LXT300VP3, LXT315VP3, G300, GXT300, GXT300VP3, LXT310, LXT210, LXT210VP, G225, GXT250, GXT550, LXT310 and LXT350
- Bike-to-bike multimedia wire "W" includes push-to-talk button and connects Alan 777, K1 and 421 and Midland G5
- Motorcycle audio wire allows rider to plug into the bike's existing audio system; helmet must be equipped with Basic Kit and either Intercom E-Box or Bluetooth E-Box
- 12V motorcycle charger allows rider to charge N-COM system without a power outlet; includes cigarette-lighter-style plug that can be hard-wired to a motorcycle battery and a cable to connect the N-COM system

NOTE: Only authorized dealers can purchase N-COM products.



DESCRIPTION	PART #	SUG. RETAIL
N-COM COMPONENTS		
Basic Kit 2 for N103 helmets (stereo)	4403-0045	\$104.95
Basic Kit for N102 helmets	4403-0029	104.95
Basic Kit 2 for N102 helmets (stereo)	4403-0046	104.95
Basic Kit for N42/E helmets	4403-0030	104.95
Basic Kit 2 for N42/E helmets (stereo)	4403-0047	104.95
Basic Kit for N84 helmets	4403-0031	104.95
Intercom E-Box	4402-0052	149.95
Bluetooth® E-Box	4402-0051	244.95
Bluetooth E-Box 2 (stereo)	4402-0059	249.95

DESCRIPTION	PART #	SUG. RETAIL
OPTIONAL ACCESSORIES AND REPLACEMENT PARTS		
Multimedia wire "S", standard	4403-0032	\$25.95
Multimedia wire "T", GPS	4403-0037	25.95
Multimedia wire "U", GPS	4403-0038	25.95
Multimedia wire "V", GPS	4403-0039	45.95
Multimedia wire "K", bike-to-bike communication	4403-0041	56.95
Multimedia wire "W", bike-to-bike communication	4403-0042	56.95
Motorcycle audio wire for BMW K1200LT	4403-0035	45.95
Motorcycle audio wire for Harley-Davidson FLHTCU 05-07	4403-0034	45.95

DESCRIPTION	PART #	SUG. RETAIL
OPTIONAL ACCESSORIES AND REPLACEMENT PARTS (CONT)		
Motorcycle audio wire for Honda GL1500/1800 Goldwing	4403-0033	\$45.95
12V motorcycle charger	3807-0038	43.95
Repl. lithium battery	2113-0073	36.95
Repl. 110V charger	3807-0037	29.95
Repl. rubber seal for Basic Kit	0935-0244	5.95
Repl. board for Basic Kit	4402-0053	7.95
Repl. microphone windscreens (pr.)	4402-0054	10.95

HOW TO BECOME AN AUTHORIZED N-COM DEALER

- Purchase one N-COM starter package; see Partsnetweb, Dragnetweb or ask your sales representative for details
- Dealer must be informed about the product, be able to perform installations in helmets and understand basic troubleshooting
- Dealer's name will be added to the authorized N-COM dealer list and referred to by his/her region
- Authorized dealers can then buy N-COM products on an as needed basis
- Contact your sales representative for full details

HS-ECD584 SERIES HEADSETS

- Utilizes the new AeroMike® III miniature boom microphone with Dual Mode™ technology that allows one headset to function with any factory-installed motorcycle audio system ever built just by interchanging the lower-section hook-up cord
- Feature fidelity-enhanced DynaPort® speakers for open-face helmets
- Upper section of two-piece hook-up cord included with headset; lower section sold separately



DESCRIPTION	PART #	SUG. RETAIL
HEADSETS		
For most open-face (3/4) style helmets	4403-0014	\$229.95
For full-coverage style helmets	4403-0012	229.95
For most flip-front style helmets	4403-0013	229.95
HOOK-UP CORDS AND ACCESSORIES		
Lower cord for 80-09 Honda and J&M 5-pin systems	DS-112376	59.95
Lower cord for 83-09 Honda, Kawasaki, Suzuki and Yamaha 5-pin systems and 88-00 GL-1500 w/ J&M passenger controller	DS-112377	59.95
Lower cord for 99-09 BMW and J&M 6-pin systems	4403-0053	69.95
Lower cord for 08-09 Kawasaki 7-pin systems	4403-0054	69.95
Repl. upper cord for ECD584 series	4403-0019	39.95
Repl. windsock kit (three piece) for AeroMike III® miniature microphones	4403-0062	13.95

HS-247/284 HELMET HEADSETS

- Provide the industry's best combination of wind and ambient noise reduction with standard and high-output (HO) AeroMike® III miniature microphones
- Superior audio fidelity has been achieved with our new ultra-slim, wide-fidelity and ported DynaPort® helmet speakers
- The versatility of our convenient two-piece cord system allows these headsets to be connected to any factory installed motorcycle audio system ever built, now and in the foreseeable future, just by interchanging the lower-section hook-up cord
- Available in clamp-on or integrated styles



DESCRIPTION	PART #	SUG. RETAIL
HEADSETS		
Clamp-on for most full-face style helmets (w/ standard microphone)	4403-0055	\$169.95
Clamp-on for most open-face (3/4) style helmets (w/ standard microphone)	4403-0056	169.95
Clamp-on for most open-face (3/4) style helmets (w/ HO microphone)	4403-0057	169.95
Integrated short-style (w/ standard microphone)	4403-0058	199.95
Integrated short-style (w/ HO microphone)	4403-0059	199.95
HOOK-UP CORDS AND ACCESSORIES		
Lower cord for 80-09 Honda and J&M 5-pin audio systems	HC-PB	22.95
Lower cord for 80-09 Honda and J&M 5-pin audio systems w/ volume control	4403-0049	79.95
Lower cord for 83-09 Honda, Kawasaki, Suzuki and Yamaha 5-pin systems and 88-00 GL-1500 w/ J&M passenger controller	HC-PC	22.95
Lower cord for 99-09 BMW and J&M 6-pin systems	4403-0050	79.95
Lower cord for 08-09 Kawasaki 7-pin systems	4403-0051	24.95
Repl. windsock kit (three piece) for AeroMike III® miniature microphones	4403-0062	13.95

HEADSET CORDS, BOOM MICS AND HARDWARE

- Fit a wide variety of J&M headsets as well as Drag Specialties headsets from J&M
- Cords feature top-quality connectors
- Hardware kit includes clamp, screws, nuts, clamp backs and hook-and-loop pieces to fit 88 and up J&M headsets



DESCRIPTION	PART #	SUG. RETAIL	DESCRIPTION	PART #	SUG. RETAIL
Repl. one-piece headset cord without boot for J&M HS-E164	DS-112354	\$50.95	Repl. upper cord for BCE174 series	4403-0018	\$22.95
Headset hardware kit	DS-112107	14.95	Repl. windsock kit for AeroMike II®	4403-0061	9.95
Lower cord for J&M six-pin audio systems (BCD257, BCD277 and Shorby series)	4402-0047	24.95	Repl. windsock kit for standard J&M and Hondaline low-noise boom mike	4403-0060	7.95

All part numbers in **BOLD MAGENTA** are new this year.

- EXHAUST
- TIRES & ACCESSORIES
- LUGGAGE
- SPORTBIKE ACCESSORIES
- CRUISER ACCESSORIES
- TOURING ACCESSORIES
- SECURITY & AUDIO
- GENERAL ACCESSORIES
- FAIRINGS & BODY
- SEATS
- HANDLEBARS & CONTROLS
- LIGHTING
- ELECTRICAL
- SPROCKETS
- CHAINS
- BRAKES
- SUSPENSION
- ENGINE
- FUEL SYSTEMS
- LUBES
- TOOLS
- TRAILER
- MERCH.
- CROSS REFERENCE
- INDEX



MRC-11X RADIO COMMUNICATOR

- The newly redesigned MRC-11X allows you to speak to another rider up to 7 miles away – several times the range of other communicators
- Bike-to-bike communication can either be push-to-talk or automatically voice activated
- Special noise-cancelling/wind-blocking headset for maximum clarity and freedom with no shouting necessary, even in noisiest conditions
- Simultaneous driver/passenger conversations
- 22 FRS/GMRS channels and 38 privacy codes
- Large LCD with 16-function readout helps monitor the selected channels and codes, including battery condition and transmit/receiver status
- Auxiliary input allows you to listen to CDs or other external music sources
- MHS-11XO premium open-face helmet-mount headset and push-to-talk switch included
- Sold each



SUG. RETAIL.....\$128.95

PART # 4402-0018

PMC-2X DRIVER/PASSENGER INTERCOM

- Includes one communicator and two headsets for communication from driver to passenger on one vehicle
- Optional adapter cables let you communicate with other bikes by plugging any FRS/GMRS or PMR 2-way radio with VOX into the added jack
- Full duplex – driver and passenger talk simultaneously as though on telephones
- Electronic touch controls – no knobs
- Noise-cancelling unidirectional microphones for clear conversation, even at higher speeds
- Small (4" W x 2.75" L x .65" D), rugged, lightweight case weighs just 4.1 oz. and mounts on belt, or the clip can be removed and inserted in pocket
- AUX IN jack for listening to CD players
- No cumbersome handlebar or helmet mount – and no theft worries
- Includes two MO-type headsets for driver and passenger
- Fits all helmets; no drilling or cutting required
- Powered by three AAA batteries (included) or by vehicle battery with optional Battery Eliminator



SUG. RETAIL.....\$92.95 **PART # 4402-0016**

PMC-3X DRIVER/PASSENGER INTERCOM

- All the features of the PMC-2X plus a powerful built-in FM receiver for on-the-road entertainment
- Includes one communicator and two headsets for communication from driver to passenger on one vehicle
- Optional adapter cables let you communicate with other bikes by plugging any FRS/GMRS or PMR 2-way radio with VOX into the added jack
- Full duplex – driver and passenger talk simultaneously as though on telephones
- Electronic touch controls – no knobs
- Noise-cancelling unidirectional microphones for clear conversation, even at higher speeds
- Small (4" x 2.75" x .65"), rugged, lightweight case weighs just 4.1 oz. and mounts on belt, or the clip can be removed and inserted in pocket
- AUX IN jack for listening to CD players
- No cumbersome handlebar or helmet mount – and no theft worries
- Includes two MO-type headsets for driver and passenger
- Fits all helmets; no drilling or cutting required
- Powered by three AAA batteries (included) or by vehicle battery with optional Battery Eliminator



SUG. RETAIL.....\$118.95 **PART # 4402-0017**

All part numbers in **BOLD MAGENTA** are new this year.

- EXHAUST
- TIRES & ACCESSORIES
- LUGGAGE
- SPORTBIKE ACCESSORIES
- CRUISER ACCESSORIES
- TOURING ACCESSORIES
- SECURITY & AUDIO
- GENERAL ACCESSORIES
- FAIRINGS & BODY
- SEATS
- HANDLEBARS & CONTROLS
- LIGHTING
- ELECTRICAL
- SPROCKETS
- CHAINING
- BRAKES
- SUSPENSION
- ENGINE
- FUEL SYSTEMS
- LUBES
- TOOLS
- TRAILER
- MERCH.
- CROSS REFERENCE
- INDEX

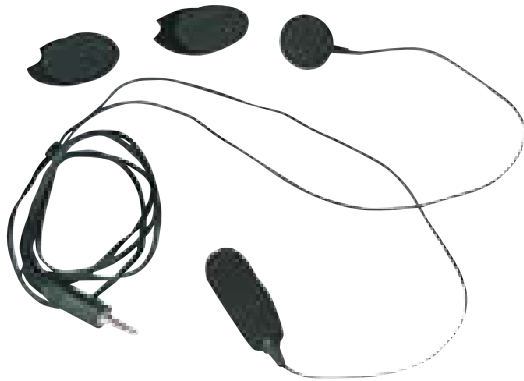

MC HEADSET

- Microphone mounts inside mouth guard of full-face helmets with hook-and-loop fastener
- Foam-padded speaker fits in ear
- No helmet modifications required to mount

SUG. RETAIL.....**\$24.95** PART # _____ MC



BATTERY ELIMINATOR

FOR PMC-2X/3X NADY COMMUNICATORS/INTERCOMS

- Forget about replacing expensive dry-cell batteries in Nady Communicators
- Battery Eliminator taps directly into your bike's power source via lugs applied directly to the battery

SUG. RETAIL.....**\$34.95** PART # _____ 2812-01



MO HEADSET

- Mounts inside any open- or full-face helmet with hook-and-loop fastener
- Includes adjustable boom microphone
- Standard on all our communicators and intercoms

SUG. RETAIL.....**\$21.95** PART # _____ MO



OPEN-FACE/ FULL-FACE HEADSET KITS

FOR PMC-2X OR PMC-3X

- Complete helmet cable assembly kit for use with two-way radios and cell phones
- Include connecting cables, premium open-face or full-face helmet-mount headsets, remote PTT-11X push-to-talk switch and PMC-XC/XY cable adapters

SUG. RETAIL.....**\$49.95**

DESCRIPTION	PART #
Open-face kit	4402-0019
Full-face kit	4402-0020



OPEN-FACE OR FULL-FACE HEADSETS FOR MRC-11X

- Your choice of premium open-face or full-face helmet-mount headset with microphone for driver or passenger

SUG. RETAIL.....**\$39.95**

DESCRIPTION	PART #
Open-face headset	4402-0021

DESCRIPTION	PART #
Full-face headset	4402-0022



HELMETALK HEADSETS AND ACCESSORIES

- Work with most popular two-way FRS/GMRS radios
- Come with both single- and double-prong connectors for easy hookup
- Use hook-and-loop pads for easy installation and removal of microphones and earpad speakers
- Replace your old push-to-talk (PTT) switch with Nady's new waterproof PTT switch; sold separately

DESCRIPTION	PART #	SUG. RETAIL
Headset w/ boom mic for use w/ open-face helmets	4403-0004	\$49.95
Headset w/ helmet-mount mic for use w/ full-face helmets	4403-0005	49.95
Waterproof push-to-talk (PTT) switch	4403-0003	12.95

All part numbers in **BOLD MAGENTA** are new this year.

- EXHAUST
- TIRES & ACCESSORIES
- LUGGAGE
- SPORTBIKE ACCESSORIES
- CRUISER ACCESSORIES
- TOURING ACCESSORIES
- SECURITY & AUDIO
- GENERAL ACCESSORIES
- FAIRINGS & BODY
- SEATS
- HANDLEBARS & CONTROLS
- LIGHTING
- ELECTRICAL
- SPROCKETS
- CHAINS
- BRAKES
- SUSPENSION
- ENGINE
- FUEL SYSTEMS
- LUBES
- TOOLS
- TRAILER
- MERCH.
- CROSS REFERENCE
- INDEX



SCALA RIDER® Q2™ MULTI-HEADSET COMMUNICATOR SYSTEM

- Includes two Scala Rider® Q2 headsets
- Bike-to-bike intercom communication up to 540 yards
- Multiple device connection technology (MDC) that allows bikers to connect to four different devices including: Bluetooth-enabled mobile phone, GPS unit, another Scala Rider Q2 headset and Scala Rider headset (solo, FM and Teamset) for communication up to 33 feet
- Includes an embedded FM radio with scan/seek features and six station channel memory
- Rider-to-passenger communications with passenger able to conduct mobile phone calls or listen to the FM radio independently
- Full duplex function that allows simultaneous talking and listening between bikers
- Include MP3 jacks to connect MP3 player (not included) to headsets
- Incoming intercom messages and mobile phone calls automatically override MP3 player
- AGC Technology allows headset to automatically adjust its volume based on ambient noise
- Noise-canceling microphone
- Features voice dial, redial and call reject functions
- Fits virtually all helmets with easy five-minute installation
- Talk time up to 8 hours; standby time up to 10 days

SUG. RETAIL.....**\$395.95** PART # **4402-0060**



SCALA RIDER® Q2™ COMMUNICATOR SYSTEM

- Bike-to-bike intercom communication up to 540 yards
- Multiple device connection technology (MDC) that allows bikers to connect to four different devices including: Bluetooth-enabled mobile phone, GPS unit, another Scala Rider Q2 headset and Scala Rider headset (solo, FM and Teamset) for communication up to 33 feet
- Includes an embedded FM radio with scan/seek features and six station channel memory
- Rider-to-passenger communications with passenger able to conduct mobile phone calls or listen to the FM radio independently
- Full duplex function that allows simultaneous talking and listening between bikers
- AGC Technology allows headset to automatically adjust its volume based on ambient noise
- Noise-canceling microphone
- Features voice dial, redial and call reject functions
- Fits virtually all helmets with easy five-minute installation
- Talk time up to 8 hours; standby time up to 10 days
- Includes MP3 jack to connect MP3 player (not included) to headset
- Sold each

SUG. RETAIL.....**\$219.95**
PART # **4402-0072**



SCALA RIDER™ TEAMSET™

- Cell phone and rider-to-passenger communication
- Receive, initiate and reject calls by voice control (subject to cellphone capabilities)
- Two-way radio between rider and passenger
- Conference-call feature adds passenger to conversation with third party
- Weather-protected headset fits 3/4 and full-faced helmets
- Self-installation of entire system within five minutes, leaving no traces on helmet
- High-impact balancing microphone for high-speed conditions
- Automatically self-adjusts speaker volume according to ambient noise level and driving speed
- VOX technology provides voice-controlled receiving and rejecting of incoming calls
- Special clamp allows attachment and release of the headset within seconds
- Up to seven hours talk-time or one week standby
- Includes MP3 jack to connect MP3 player (not included) to headset
- Sold as pair

SUG. RETAIL.....**\$229.95** PART # **4402-0071**



SCALA RIDER® MP3 AUDIO UPGRADE KIT

- Adds the ability to listen to an MP3 player (not included) to the earlier model Scala Rider® Q2 and Scala Rider® Teamset™ Bluetooth® headset communicators that previously did not allow the direct plug-in of an MP3 player
- Included cable links MP3 player (not included) to jack located at back of audio kit
- Audio unit attaches to helmet with clamp or glue (glue plate included)

SUG. RETAIL.....**\$49.95**
PART # **4402-0061**





4402-0023

4402-0040

4402-0039

THROAT-MIC COMMUNICATORS

- No more yelling over loud pipes with the finest, full-duplex throat-mic intercom systems on the market
- Designed specifically for noisy environments
- Throat-mic picks up voice signals from vibrations in the neck, not the air, so background noise does not register



4402-0027

Route 66 and Vanquish storage case

FOX TALK RIDER/PASSENGER INTERCOM

- Fox Talk system includes an intercom unit, a neck-ring with throat-mic for each the rider and the passenger and D-ring earpieces that can be placed in a helmet if desired
- Intercom unit has 3.5mm receptor that may be used to plug in an MP3 player
- Includes a Fox Sox carrying case

ROUTE 66 RIDER/PASSENGER INTERCOM AND VANQUISH THROAT-MIC

- The next generation of throat-mic transponders offer better quality sound, requiring only one mic
- Neck rings are 50% larger with a soft rubber covering; include an extension to allow a perfect fit on almost any neck size
- Ear bud speakers have a higher max volume than previous models and feature comfortable silicone tips
- Both systems allow the rider to connect any headphones, ear buds or helmet speakers with standard 3.5mm plug
- Vanquish includes one neck ring with throat-mic, one set of ear bud speakers and coiled, waterproof PTT button (extends to 5'); simply plug the Vanquish into an intercom unit or any radio (Motorola, Cobra, Garmin, AudioVox, Uniden, etc.) that accepts a standard 3.5mm plug and be heard clearly
- Route 66 includes a full duplex intercom unit, two neck rings with throat-mics and two sets of ear bud speakers

ACCESSORIES

- Cobra two-pin adapter allows the headset to be connected to older, two-pin radios by Cobra, Midland and more
- Fox Sox neoprene carrying case will protect your throat-mic system from everyday damage

DESCRIPTION	PART #	SUG. RETAIL
RIDER/PASSENGER INTERCOMS		
Fox Talk	4402-0023	\$89.95
Route 66	4402-0040	164.95

DESCRIPTION	PART #	SUG. RETAIL
THROAT-MIC		
Vanquish	4402-0039	\$94.95

DESCRIPTION	PART #	SUG. RETAIL
ACCESSORIES		
Cobra two-pin adapter	4402-0027	\$9.95
Fox Sox carrying case	4402-0026	9.95

Metrix Audio

by HOOTUNES

HANDLEBAR MOUNTED SPEAKER SYSTEM

- Play music on bikes with 7/8", 1" or 1 1/4" diameter handlebars
- Uses your MP3 player, satellite radio receiver or similar portable audio device
- 2" custom designed speakers in chromed "bullet" cabinets
- Includes a 50W "hide-able" amplifier with MAXXBASS®
- Digital volume control is built into the system
- Charge your audio device or cell phone with the USB Port
- Comes with a customizable clear sleeve for the speaker cabinets
- Universal audio input form headphone jacks
- Requires 12V negative ground charging system with battery



SUG. RETAIL..... **\$399.95**
PART # **4050-0034**



FRONT AND REAR REPLACEMENT SPEAKERS FOR GOLD WING GL1800 01-05

- Direct replacement speakers
- Play loud and clear at highway speeds
- Feature titanium impregnated neodymium tweeters and ultra light weight treated paper cones
- Includes parts for rear installation
- 40W RMS/80W peak

SUG. RETAIL..... **\$99.95**
PART # **4405-0131**

All part numbers in **BOLD MAGENTA** are new this year.

- EXHAUST
- TIRES & ACCESSORIES
- LUGGAGE
- SPORTBIKE ACCESSORIES
- CRUISER ACCESSORIES
- TOURING ACCESSORIES
- SECURITY & AUDIO
- GENERAL ACCESSORIES
- FAIRINGS & BODY
- SEATS
- HANDLEBARS & CONTROLS
- LIGHTING
- ELECTRICAL
- SPROCKETS
- CHAINS
- BRAKES
- SUSPENSION
- ENGINE
- FUEL SYSTEMS
- LUBES
- TOOLS
- TRAILER
- MERCH.
- CROSS REFERENCE
- INDEX

- EXHAUST
- TIRES & ACCESSORIES
- LUGGAGE
- SPORTBIKE ACCESSORIES
- CRUISER ACCESSORIES
- TOURING ACCESSORIES
- SECURITY & AUDIO
- GENERAL ACCESSORIES
- FAIRINGS & BODY
- SEATS
- HANDLEBARS & CONTROLS
- LIGHTING
- ELECTRICAL
- SPROCKETS
- CHAINS
- BRAKES
- SUSPENSION
- ENGINE
- FUEL SYSTEMS
- LUBES
- TOOLS
- TRAILER
- MERCH.
- CROSS REFERENCE
- INDEX



WINGLEADER® REAR SPEAKER KIT

FOR HONDA GL1800 01-05



- Technically advanced kit enhances stereo sound
- Made to fit in OEM tourbox armrests perfectly
- Water-resistant speakers and wire harness included; unit plugs into stock wire harness

SUG. RETAIL.....\$59.95 **PART #** **DS319931**



DS-319934

WINGLEADER® REAR SPEAKER KITS

FOR HONDA GL1500 88-98



- Advanced kits enhance stereo sound
- Made to fit perfectly in OEM tourbox armrests
- Include front/rear fader control, water-resistant speakers and wiring harness

NOTE: Does not fit Interstate models.

DESCRIPTION	PART #	SUG. RETAIL
Speaker kit	DS-319934	\$44.95
Repl. fader control switch	DS-319935	14.95

NEODYMIUM REAR SPEAKER KIT

FOR HONDA GOLD WING



4405-0116

- Lightweight, water-resistant, two-way speakers with Butyl rubber surround, suspended tweeter and plastic cone
- 30W at 3 ohm; 0.8 ohm tweeter
- Measure 4 1/2" dia. x 2 1/4" D
- Kit includes wiring harness

DESCRIPTION	FITS MODEL/POSITION	PART #	SUG. RETAIL
Neodymium speaker kit	GL1800 01-05/rear	4405-0116	\$96.95
Repl. speakers (pr.)	GL1500 88-00/front, GL1800 01-05/front and rear, GL1800 06-08/rear	4405-0117	73.95

REAR SPEAKER KIT

FOR HONDA GL1800 GOLD WING 01-05



- Withstands more abuse from the weather than OEM speakers, yet matches them in sound quality
- Can handle up to 30W
- Plugs directly into Honda GL1800 Gold Wing 01-05 OEM audio system

SUG. RETAIL.....\$55.95 **PART #** **BB-52-607**

FIVE-PIN DIN VOLUME CONTROL

- Gives the rider left and right speaker control and microphone volume
- Plugs inline with current five-pin headset
- Fits most five-pin DIN jacks

SUG. RETAIL.....\$64.95 **PART #** **4403-0023**



TWO-WAY SPEAKER KIT

FOR HONDA GL1800 GOLD WING 01-05

- Features Butyl rubber surround and plastic cone for better sound quality than OEM speakers
- Suspended tweeter
- 30W
- Water-resistant

SUG. RETAIL.....\$81.95

PART # **4405-0069**

MODEL 221 XS HELMET HEADSET

- First on the market to feature individual left and right speaker volume control
- Microphone has sensitivity control, an on/off switch and a flexible boom
- High-frequency output offers crisp sound
- Quick-disconnect plug for simple detachment
- Headset cord included; five-pin DIN works with Honda, Kawasaki, Suzuki and Yamaha
- Fits full, open-face and most modular helmets



4403-0024

DESCRIPTION	PART #	SUG. RETAIL
Helmet headset	4403-0024	\$141.95
Repl. headset cord	4403-0025	20.95



RUMBLE ROAD™ ULTRA AMPLIFIED STEREO SPEAKERS

- Clear and powerful sound even at highway speeds
- RCA or Blaupunkt 4" Coaxial full-range speakers
- Built-in amplifiers and standard stereo mini-plug
- Produces approximately 70W continuous; 100W peak; into 4 OHM at 13.6 VDC with high-gain input
- Operates with or without the motorcycle running
- Packaged in an attractive chrome or black spotlight shell, it does not distract from the look of the motorcycle
- Features stainless steel or black grilles and all hardware included
- Works with most portable MP3 players and other personal stereos featuring a standard mini-plug headphone jack
- Installs easily on handlebars, spotlight mounting bars, forks or engine guards
- Made in the U.S.A.



DESCRIPTION	PART #	SUG. RETAIL
Chrome	4405-0160	\$369.95

DESCRIPTION	PART #	SUG. RETAIL
Black	4405-0161	\$399.95

RUMBLE ROAD™ PREMIUM AMPLIFIED STEREO SPEAKERS

- High-output, high-fidelity stereo speaker system produces crisp, powerful sound even at highway speeds
- Attractively packaged in lustrous chrome or black spotlight shells to enhance the look of most any motorcycle
- Can be installed on handlebars, crash bars, forks or other locations
- Work with any portable MP3, personal stereo or satellite radio
- Feature standard miniplug headphone jack
- Approximately 32W continuous, 46W peak into 4 ohms at 13.6 VDC
- Includes two 4" Rumble Road amplified speakers from Blaupunkt®, noise filter, all audio cabling and power wiring and 3' of black wire dressing



COLOR	PART #	SUG. RETAIL
Chrome w/ 1" mounting hardware	4405-0001	\$269.95
Chrome w/o mounting hardware	4405-0115	249.95
Black w/ 1" mounting hardware	4405-0002	299.95

RUMBLE ROAD™ LIMITED NON-AMPLIFIED SPEAKERS

- Custom product for motorcycles with existing car-stereo setups
- Attractively packaged in chrome or black spotlight shells to enhance the look of most any bike
- Based on the Rumble Road Premium Amplified speaker system, the non-amplified Rumble Road Limited is easily installed on handlebars, spotlight mounting bars, forks or crash bars
- Speakers work with any car-stereo system (either ground or bridged) to provide high-quality sound on the go or while parked
- 4 ohms at 105W peak/35W RMS
- Include two Rumble Road non-amplified speakers, two three-piece 1" mounting clamps in matching finish, wiring and 3' of black wire dressing



NOTE: The non-amplified Rumble Road Limited series requires an amplifier-equipped car stereo and is not designed for use with personal stereos. If you plan to use a portable MP3 or other personal stereo instead of a car stereo, check out the Rumble Road Premium Amplified speaker system PART #4405-0001 or PART #4405-0002.

COLOR	PART #	SUG. RETAIL
Chrome	4405-0003	\$169.95
Black	4405-0004	199.95



THREE-PIECE CLAMP SET

- Perfect for mounting Rumble Road™ speakers on handlebars or engine guard bars
- Clamps separate to slip easily over the bar to the desired mounting location
- Sold in pairs

DESCRIPTION	PART #	SUG. RETAIL	DESCRIPTION	PART #	SUG. RETAIL
7/8", chrome	4405-0009	\$19.95	1", black	4405-0014	\$29.95
7/8", black	4405-0013	29.95	1 1/4", chrome	4405-0012	19.95
1", chrome	4405-0010	19.95			



L-BRACKET SET

- Right-angled clamps are just the ticket for vertical mounts or other space-defying installations of Rumble Road™ speakers, AudioBox™ Audio Controller or other accessories
- Available in polished stainless steel or black
- Sold in pairs

DESCRIPTION	PART #	SUG. RETAIL
Polished	4405-0017	\$24.95
Black	4405-0162	29.95

All part numbers in **BOLD MAGENTA** are new this year.

- EXHAUST
- TIRES & ACCESSORIES
- LUGGAGE
- SPORTBIKE ACCESSORIES
- CRUISER ACCESSORIES
- TOURING ACCESSORIES
- SECURITY & AUDIO
- GENERAL ACCESSORIES
- FAIRINGS & BODY
- SEATS
- HANDLEBARS & CONTROLS
- LIGHTING
- ELECTRICAL
- SPROCKETS
- CHAINS
- BRAKES
- SUSPENSION
- ENGINE
- FUEL SYSTEMS
- LUBES
- TOOLS
- TRAILER
- MERCH.
- CROSS REFERENCE
- INDEX



EXHAUST
TIRES & ACCESSORIES
LUGGAGE
SPORT ACCESSORIES
CRUISE ACCESSORIES
TOURING ACCESSORIES
SECURITY & AUDIO
GENERAL ACCESSORIES
FAIRINGS & BODY
SEATS
HANDLEBARS & CONTROLS
LIGHTING
ELECTRICAL
SPROCKETS
CHAIN
BRAKES
SUSPENSION
ENGINE
FUEL SYSTEMS
LUBES
TOOLS
TRAILER
MERCH.
CROSS REFERENCE
INDEX



RCA TWO-WAY COAXIAL SPEAKERS

- These RCA speakers are designed with volume, clarity, and weather-resistance in mind
- Can be used as replacements for most factory-installed fairing speakers and aftermarket radio housing speakers
- Sold in pairs

DESCRIPTION	PART #	SUG. RETAIL
100W 4 OHM (4")	4405-0126	\$49.95
150W 4 OHM (5.25")	4405-0127	59.95



IN-LINE VOLUME CONTROLLER

- An economic alternative to MH Instruments custom-designed CrankCase™ volume controller/power switch
- Provides remote sound-level adjustment of personal stereos equipped with a 1/8" stereophone jack
- Includes a pocket/belt clip for storage and security

SUG. RETAIL.....	\$9.95
PART #	4405-0163

CRANKCASE™ AUDIO CONTROLLER/POWER SWITCH

- Keep your gloves on while controlling the volume; oversize knob makes it easy
- On/off switch can be heard and felt with an audible click
- High-visibility blue LED and chrome plating for superior design and function
- Precision-machined billet aluminum; 1.7" W x 1.8" H x 1.3" D
- 1" mounting clamp can be placed anywhere on the tube, even next to the brake or throttle controls
- Comes with removable two-piece clamp for handlebars other than 1" standard; mount using your own hardware
- Universal line-level input with 1/8" stereo plug
- Built-in fuse (5A) for internal/external power
- Compatible with standard electrical hardware
- Surface-mounted electronics and weather resistant



SUG. RETAIL.....	\$179.95	PART #	4405-0070
------------------	-----------------	--------	-----------

ROUND ACOUSTIC Baffles

- Protect your speakers from water, rust, dust and electrical problems
- Foam basket forms a protective layer between speaker and enclosure, reducing resonance and other distortion
- Available in round 5.25" sizing
- Sold in pairs



SUG. RETAIL.....	\$14.95	PART #	4405-0076
------------------	----------------	--------	-----------

ELECTRICAL NOISE FILTER

- Greatly reduces electrical noise or whine produced by some motorcycle electrical/ignition systems
- One filter is good for powering both Rumble Road™ speakers in the system



SUG. RETAIL.....	\$9.95	PART #	4405-0007
------------------	---------------	--------	-----------

GROUND LOOP ISOLATOR

- Suppresses any resulting noise in the audio line for those who use their bike's battery to operate a personal stereo
- Breaks the ground loop that would otherwise occur between a personal stereo and amplified speakers
- A necessary accessory for some satellite radio systems



SUG. RETAIL.....	\$12.95	PART #	4405-0008
------------------	----------------	--------	-----------

UNIVERSAL STEREO MOUNTING KIT

- Clamps are perfect for mounting speakers on handlebars or engine crash bars – clamps separate to slip easily over the bar to the desired mounting location
- Designed for 1" handlebars
- Kit and stereo are easily removable with only three points of attachment
- Black hardware and clear Lucite® tray safely hold your personal stereo



SUG. RETAIL.....	\$39.95	PART #	4405-0075
------------------	----------------	--------	-----------

EXHAUST

TIRES & ACCESSORIES

LUGGAGE

SPORTBIKE ACCESSORIES

CRUISER ACCESSORIES

TOURING ACCESSORIES

SECURITY & AUDIO

GENERAL ACCESSORIES

FAIRINGS & BODY

SEATS

HANDLEBARS & CONTROLS

LIGHTING

ELECTRICAL

SPROCKETS

CHAINS

BRAKES

SUSPENSION

ENGINE

FUEL SYSTEMS

LUBES

TOOLS

TRAILER

MERCH.

CROSS REFERENCE

INDEX



JMCB-2003 HANDLEBAR-MOUNTED CB AUDIO SYSTEM

- This exciting product from J&M features a 40-channel CB radio, NOAA weather band, rider/passenger intercom and stereo music amplification from any Walkman®-type music device
- Mount it to your left handlebar with the proper bracket kit, connect the headset/power harness to your bike's electrical system (choose below between solo or rider/passenger kits), install a J&M license-plate mounted CB antenna (or any other properly tuned CB antenna, sold separately), plug in your favorite J&M dual-mode helmet headset/headsets and you are ready to go
- No other hidden black boxes to mount or clutter up your bike; complete system is on your handlebar (your Walkman-source music device is plugged into the system as a separate item)
- All knobs and controls have been designed for ease of use while riding, even with gloves on; water-resistant unit so you won't have to worry about getting caught out in the rain
- Audio performance is superb, even at high speeds
- Mounting bracket and lower-section hook-up cord sold separately

NOTE: The JMCB-2003 is a J&M 6-pin audio system that requires the pre-amplified microphone signal provided by the J&M dual-mode (ECD/ICD/BCD/CD prefixed) helmet headsets along with the lower section hook-up cord PART #4402-0047.

DESCRIPTION	PART #	SUG. RETAIL
JMCB-2003 kit for solo (driver only) headset operation	4402-0005	\$299.95
JMCB-2003 kit for driver/passenger headset operation	4402-0006	359.95
MOUNTING BRACKETS AND ACCESSORIES		
Mounting bracket for Honda cruisers/ST-1300	4402-0007	46.95
Mounting bracket for Honda cruisers (polished)	4403-0016	46.95
Mounting bracket for Honda Silverwing	4402-0069	46.95
Mounting bracket for Kawasaki cruisers (except Concours)	4402-0011	46.95
Mounting bracket for Kawasaki Concours	4402-0067	46.95
Mounting bracket for Suzuki cruisers	4402-0010	46.95
Mounting bracket for Yamaha cruisers (except Stratoliner)	4402-0009	46.95
Mounting bracket for Yamaha Stratoliner	4402-0066	46.95
Mounting bracket for Victory cruisers	4402-0068	46.95
6-pin lower-section hook-up cord (HC-PWY)	4402-0047	24.95



REPLACEMENT FAIRING/REAR SPEAKERS FOR GL1500 AND GL1800 01-06

- Manufactured as exact replacements for the stock units, both front and rear, as installed on the GL1800 and front and rear for the GL1500
- Designed for the specific power levels of the Gold Wing's audio system to deliver maximum output and fidelity
- 3 ohms impedance and 100+ watts power
- Mylar/aluminum waterproof cone construction makes them impervious to the weather and repeated trips to the carwash
- Complete kit includes wiring harness that plugs into the factory wiring harness plug located under the seat
- Sold in pairs



LICENSE PLATE-MOUNT CB ANTENNA KITS

- These license plate-mount CB antenna kits include a black powder-coated mounting bracket, 2', 3' or 4' antenna staff, mounting stud, frame attachment grounding strap, antenna connection cable, right-angle adapter, cable ties, mounting hardware and complete installation instructions

SUG. RETAIL..... \$99.95

FITS MODEL	POSITION	PART #	SUG. RETAIL
HONDA			
GL1500 88-00 (all)	Repl. fairing speakers (pr.)	4405-0105	\$69.95
	Repl. rear speakers (pr.)	DS-319933	69.95
GL1800 01-06 (all)	Repl. fairing/rear speakers (pr.)	4405-0103	69.95
	Rear speaker kit complete w/ harness	4405-0104	99.95

DESCRIPTION	PART #
2' antenna kit	4402-0012
3' antenna kit	4402-0013
4' antenna kit	4402-0014

All part numbers in **BOLD MAGENTA** are new this year.



general
accessories

ULTRA COVERS

- Top-quality construction with tons of features
- Ultra I is made of heavy polyester fabric, while Ultra II features heavyweight, durable army duck canvas
- Sewn-in vents minimize condensation
- Flannel liner (on L-XXL sizes) protects windshield from scratches (Ultra I only)
- Include convenient carry bag
- Full two-year warranty against defects in material
- S = standard motorcycles with mirrors, M = sport and stock motorcycles with mirrors (fits most small fairings), L = up to 1,200cc with saddlebags and fairings, XL = touring dressers and XXL = full dressers

NOTE: Not for use when trailering.

SIZE	PART #	SUG. RETAIL
ULTRA 1		
Small	BG-0101	\$70.95
Medium	BG-0102	72.95
Large	BG-0103	76.95

SIZE	PART #	SUG. RETAIL
ULTRA 1 (CONT)		
X-large	BG-0104	\$89.95
XX-large	BG-0105	89.95



SIZE	PART #	SUG. RETAIL
ULTRA 2		
Small	BG-0111	\$73.95
Medium	BG-0112	81.95
Large	BG-0113	85.95

SIZE	PART #	SUG. RETAIL
ULTRA 2 (CONT)		
X-large	BG-0114	\$92.95
XX-large	BG-0115	98.95

FITS	SIZE
APRILIA	
Scooters (all)	M
Caponord, Futura	L
Falco R, RSV Mille, R	M
BIMOTA	
All	M
BMW	
F650	L
F700	M
K100LT	L
K100RS	M
K100RT	L
K1100RS	M
K1200/K1200RS	L
K1200LT	XXL
K75	M
K75RT	L
R100/R100GS	M
R100R/R100RS/R100RT	L
R1100RT	L
R1100S/R1100RS/ R1150RS	M
R1150GS	L
R1200 CE Euro	L
R1200 Montana	L
R1200C/R1200CE	L
R1200C Phoenix	L
R1200 CST Stilleto	L
R65/R65LS/R75S/ R80/R80ST	M
RB0R/RB0RT	L
ST2	L
ST4	L
BUELL	
All	M
CAGIVA	
All	M
DUCATI	
600/900 S4/Monster	M
748/748S/750 Sport	M
750 Supersport/900	M

FITS	SIZE
DUCATI (CONT)	
996R/996/996S	M
ST2	L
ST4	L
EXCELSIOR-HENDERSON	
Super-X	L
HONDA	
ACE 750/ ACE Deluxe 750	L
Aero	L
Dual-purpose (all)	S
Helix	XL
Sabre	L
Shadow Aero	L
Shadow Sabre	L
Shadow VLX/Deluxe	M
Silver Wing	L
CB250/CB125	M
Nighthawk	M
CM250/450 Rebel	S
CB450 Nighthawk	M
FT500 Ascot	S
VF500 Interceptor	M
VF500 Magna	M
CX550	S
CBR600 Hurricane/ CBR600 F3	M
CBR600 F4/F4i	M
VT600 Shadow/ Shadow DLX 600	L
VF700 Magna	L
VF700 Sabre/V45	M
CB700 Nighthawk/ CB550	L
CB750 Nighthawk	M
VF750 Interceptor	M
VT750 Shadow Spirit	M
PC800 Pacific Coast	L
VFR800	M
CBR900RR/929RR	M
CB1/CB1000	M

FITS	SIZE
HONDA (CONT)	
CBR1000 Hurricane	M
RC51	M
VG1000 Interceptor	M
ST1100	L
VF1100 Magna	M
VF1100 Sabre	M
VT1100 Shadow ACE/ Shadow Spirit	L
VT1100 Shadow Tour	L
VTR1000 Super Hawk	M
GL1200 Gold Wing	XL
VTX1300S	L
GL1500 Valkyrie	XL
GL1500 Valkyrie	XL
Interstate	XXL
GL1500 Valkyrie Touring	XL
GL1800 Gold Wing	XXL
VTX1800C	L
INDIAN	
Scout, Spirit	L
Chief (w/o windshield)	L
Chief (w/ windshield)	XL
Chief Roadmaster	XL
KAWASAKI	
Ninja (all)	M
Classic 800	L
BN125 Eliminator	M
KZ440LTD/KZ450LTD	M
EN500	M
KZ550LTD	M
ZR550/750 Zephyr	M
ZL600/1000 Eliminator	M
W650	L
VN750/800 Vulcan	L
ZN750LTD/ZN1100LTD	M
VN800/1500 Drifter	XL
ZX-9R	M
ZG1000 Concourse	XL
ZRX1100	L
ZX-11	M

FITS	SIZE
KAWASAKI (CONT)	
ZG1200 Voyager	XL
ZRX1200	M
ZX-12	M
ZN1300 Voyager	XXL
VN1500 Nomad	XL
VN1500 Vulcan Classic	L
VN1500L Vulcan	L
VN1500 Vulcan Mean Streak	L
MOTO GUZZI	
All sport bikes	M
California 3/Centauro V10/V11/Jackal (all)	L
SUZUKI	
Savage	M
GZ250	M
GS450GA/450L	S
GS500E	M
GS550GL/550L/1100GL	M
GSX600/750 Katana	M
GSX-R600/750/ 1000/1100	M
SV650S	M
VS700/1400GL Intruder	M
VL800 Volusia	M
VZ800 Marauder	M
GS850G/850GL	M
RF900R	M
TL1000S	M
GS1100GKE	XL
GSX1300R Hayabusa	M
GV1400 Cavalcade	M
VS1400 Intruder	L
VL1500 Intruder	XL
TRIUMPH	
Bonneville	M
Daytona	M
Daytona 900/955	M
Legend	M
Sprint/Sprint ST/Sprint RS	M

FITS	SIZE
TRIUMPH (CONT)	
Thunderbird/ Thunderbird Sport	M
Tiger	M
Trophy 900/1200	L
TT600	M
VICTORY	
V92C/925C	M
V92C Deluxe	XL
YAMAHA	
Maxim	M
Road Star Silverado	XL
Road Star Warrior	L
Road Star	L
Royal Star Classic	XL
Royal Star Venture	XXL
Seca	M
Star Venture	XXL
Venture Royale	XL
XV250 Virago	M
SRX250/600	M
RZ350/500	S
YV535 Virago	M
V-Star 650 (all)	M
FJ600/1100/1200	M
FZ600/700/750	M
YX600 Radian	M
YZF R-6/R-1	M
FZX700 Fazer	M
XJ700 Maxim/ XJ750 Maxim	M
XV700/750/1000/ 1100 Virago	L
FZR1000	M
YZF1000	M
V-Star 1100 Classic/ Custom	M
V-Star 1100/ Silverado 650	L
VMX1200	M

SCOOTER COVERS

- Made of 300 x 300 water-repellent polyester fabric
- Vented system allows scooter to breathe
- Cover has sewn-in pouch for convenient storage
- Heat shield material protects cover from warm exhaust
- Has shock cord perimeter for positive fit and two sewn-in loops for additional security
- Small/medium cover fits most scooters up to 250cc with mirrors only
- Large/X-large cover fits most scooters 80cc to 250cc with full windshield and trunk
- Use PART # BG0101 for scooters over 250cc

Cover folds into its own pouch



SIZE	PART #	SUG. RETAIL
Small/Medium	4001-0060	\$44.95
Large/X-large	4001-0061	47.95

All part numbers in **BOLD MAGENTA** are new this year.

- EXHAUST
- TIRES & ACCESSORIES
- LUGGAGE
- SPORTBIKE ACCESSORIES
- CRUISER ACCESSORIES
- TOURING ACCESSORIES
- SECURITY & AUDIO
- GENERAL ACCESSORIES
- FAIRINGS & BODY
- SEATS
- HANDLEBARS & CONTROLS
- LIGHTING
- ELECTRICAL
- SPROCKETS
- CHAIN
- BRAKES
- SUSPENSION
- ENGINE
- FUEL SYSTEMS
- LUBES
- TOOLS
- TRAILER
- MERCH.
- CROSS REFERENCE
- INDEX

- EXHAUST
- TIRES & ACCESSORIES
- LUGGAGE
- SPORTBIKE ACCESSORIES
- CRUISER ACCESSORIES
- TOURING ACCESSORIES
- SECURITY & AUDIO
- GENERAL ACCESSORIES
- FAIRINGS & BODY
- SEATS
- HANDLEBARS & CONTROLS
- LIGHTING
- ELECTRICAL
- SPROCKETS
- CHAINS
- BRAKES
- SUSPENSION
- ENGINE
- FUEL SYSTEMS
- LUBES
- TOOLS
- TRAILER
- MERCH.
- CROSS REFERENCE
- INDEX



TRK-350

- Made of medium-weight Tri-Max® polyester, this is the only trike cover guaranteed to be 100% waterproof
- Double-stitched, electronically sealed seams
- Heat-shielded lower panel; soft windshield protector
- Exclusive Perma-Venting® system prevents condensation buildup by allowing constant air circulation
- 50" rear zipper gives access to trunk without cover removal
- Snug-fitting, elasticized bottom has 1" grommets in center and at front wheel
- Folds into its own carryall
- Available in black; one size fits most

SUG. RETAIL.....\$129.95 **PART #** _____ **TRK-350**



TRK-350D TRIKE DUST COVER

- Protect your trike from dust and spills when garaged
- Made from a breathable soft non-scratch brushed poly/cotton
- One size fits most

SUG. RETAIL.....\$59.95 **PART #** _____ **4001-0010**



DEFENDER® 2000 AND 3000

- Guaranteed 100% waterproof
- Made of full-strength top-quality Tri-Max®-treated polyester
- Treated with UV to block out harmful UV rays that cause color fading
- Double-stitched, electrically heat-sealed seams and heat-shielded lower panels
- Perma-Venting® system prevents condensation buildup
- Soft windshield panel protector
- Snug elastic bottom with 1" grommets at center and front wheel
- Packed in its own tough backpack
- Available in black/silver 2000 and gray/silver 3000
- Available in M, L, XL and XXL; also fits Honda Gold Wings

SIZE	PART #	SUG. RETAIL
(A) 2000		
Medium	D2-500	\$94.95
Large	D2-750	99.95
X-large	D2-1000	109.95
XX-large	D2-1500	119.95



SIZE	PART #	SUG. RETAIL
(B) 3000		
Medium	4001-0093	\$94.95
Large	4001-0094	99.95
X-large	4001-0095	109.95
XX-large	4001-0096	119.95



DEFENDER® 400, 500 AND 600

- The Defender® is guaranteed 100% waterproof
- Made from medium-weight top-quality Tri-Max® treated polyester
- The exclusive UV process blocks out harmful UV rays that are the leading cause of color fading
- Double-stitched, electrically heat-sealed seams and heat-shielded lower panels
- Soft windshield panel protector
- Perma-Venting® system prevents condensation buildup and allows constant air circulation
- Snug elastic bottom with 1" grommets at center and front wheel
- Packed into its own tough zipper storage bag with handle
- Available in black/silver 400, gray/silver 500 and navy/silver 600

SIZE	PART #	SUG. RETAIL
(A) BLACK/SILVER 400		
Medium	D4-200	\$84.95
Large	D4-300	89.95
X-large	D4-400	94.95
XX-large	D4-500	99.95
(B) GRAY/SILVER 500		
Medium	D5-200	84.95
Large	D5-300	89.95

SIZE	PART #	SUG. RETAIL
(C) NAVY/SILVER 600		
Medium	D6-200	84.95
Large	D6-300	89.95
X-large	D6-400	94.95
XX-large	D6-500	99.95



FC-628

- Guaranteed 100% waterproof
- Made from medium-weight top-quality Tri-Max® treated polyester
- Treated with our exclusive UV process to block out harmful UV rays that cause color fading
- Double-stitched, electrically heat-sealed seams and heat-shielded lower panels
- Soft windshield panel protector
- Perma-Venting® system prevents condensation buildup and allows constant air circulation
- Snug elastic bottom with 1" grommets at center and front wheel
- Packed in a matching tough-zippered bag with handle
- For all cruiser-style bikes including Harley, Valkyrie, Vulcan, Intruder and Virago models
- Available in black/silver; sizes M, L and XL

NOTE: Not intended for trailering.

SIZE	PART #	SUG. RETAIL
Medium	FC628M	\$79.95
Large	FC628L	84.95
X-large	FC628XL	89.95



FC-428

- Made of rain-resistant polyester in sizes to accommodate longer wheelbases, windshields and luggage
- Vent-Air System® prevents condensation buildup underneath cover
- Full-length heat-resistant lower panels protect cover from engine and exhaust
- Elasticized bottom has grommets and bungee cord; can be used with locks
- Comes with zippered carryall
- Available in black/silver

SIZE	PART #	SUG. RETAIL
Medium	FC428M	\$54.95
Large	FC428L	59.95
X-large	FC428XL	64.95



UV2000

- Specially treated UV protected nylon
- Blocks more than 97% of sun's harmful rays
- 100% waterproof; protects against all natural elements
- Seams are four-folded, stitched and electronically heat sealed
- Shock cord allows for snug fit on all shapes
- Sewn-in elastic bungees
- Packed in durable fanny pack made of 300mm polyester, with adjustable straps
- Sizes M, L and XL to fit every bike

NOTE: Not intended for trailering.

SIZE	PART #	SUG. RETAIL
Medium	UV2000M	\$42.95
Large	UV2000L	49.95
X-large	UV2000XL	54.95



MC-900/MC-901 ECONO COVERS

- Guaranteed to be 100% waterproof
- Made from ripstop-designed soft PVC
- Front, middle and rear grommets for safety tie-downs
- Fully ventilated using the exclusive Cool-Vent system
- Sized to fit every bike and scooter
- Available in S, M, L, XL or XXL; choose from graphite black or sonic gray

NOTE: Not intended for trailering.

SIZE	PART #	SUG. RETAIL
(A) MC900 GRAPHITE BLACK		
Small	MC900S	\$24.95
Medium	MC900M	27.95
Large	MC900L	27.95
X-large	MC900XL	29.95
XX-large	MC900XXL	34.95

SIZE	PART #	SUG. RETAIL
(B) MC901 SONIC GRAY		
Small	MC901S	\$24.95
Medium	MC901M	27.95
Large	MC901L	27.95
X-large	MC901XL	29.95
XX-large	MC901XXL	34.95

All part numbers in **BOLD MAGENTA** are new this year.

- EXHAUST
- TIRES & ACCESSORIES
- LUGGAGE
- SPORTBIKE ACCESSORIES
- CRUISER ACCESSORIES
- TOURING ACCESSORIES
- SECURITY & AUDIO
- GENERAL ACCESSORIES
- FAIRINGS & BODY
- SEATS
- HANDLEBARS & CONTROLS
- LIGHTING
- ELECTRICAL
- SPROCKETS
- CHAINS
- BRAKES
- SUSPENSION
- ENGINE
- FUEL SYSTEMS
- LUBES
- TOOLS
- TRAILER
- MERCH.
- CROSS REFERENCE
- INDEX

MC902/3/4

- Made from high-density treated polyester to withstand today's elements and be water-resistant
- Treated with exclusive UV to block out harmful UV rays that are the leading cause of color fading
- Air ventilators to prevent condensation; heat shield on lower panels
- Four oversize grommets with bungees at front wheel and middle of bike for security
- Soft windshield liner and snug, fully elasticized hem
- Packed into its own attractive carryall
- Available in navy/silver, burgundy/silver and black/silver
- Sizes to fit every model; M, L, XL and XXL

SIZE	PART #	SUG. RETAIL
(A) MC902 NAVY/SILVER		
Medium	MC902M	\$49.95
Large	MC902L	52.95
X-large	MC902XL	55.95
XX-large	MC902XXL	59.95

SIZE	PART #	SUG. RETAIL
(B) MC903 BURGUNDY/SILVER		
Medium	MC903M	\$49.95
Large	MC903L	52.95
X-large	MC903XL	55.95
XX-large	MC903XXL	59.95

SIZE	PART #	SUG. RETAIL
(C) MC904 BLACK/SILVER		
Medium	MC904M	\$49.95
Large	MC904L	52.95
X-large	MC904XL	55.95
XX-large	MC904XXL	59.95



- EXHAUST
- TIRES & ACCESSORIES
- LUGGAGE
- SPORTBIKE ACCESSORIES
- CRUISER ACCESSORIES
- TOURING ACCESSORIES
- SECURITY & AUDIO
- GENERAL ACCESSORIES
- FAIRINGS & BODY
- SEATS
- HANDLEBARS & CONTROLS
- LIGHTING
- ELECTRICAL
- SPROCKETS
- CHAINS
- BRAKES
- SUSPENSION
- ENGINE
- FUEL SYSTEMS
- LUBES
- TOOLS
- TRAILER
- MERCH.
- CROSS REFERENCE
- INDEX

SCOOTER COVER

- Made from a water-resistant lightweight Tri-Max® polyester
- 1" grommets at center and front wheel
- Matching carryall included
- Available in silver and cobalt blue

SIZE	PART #	SUG. RETAIL
(A) SILVER		
Medium	4001-0001	\$49.95
Large	4001-0002	54.95
(B) COBALT BLUE		
Medium	4001-0035	49.95
Large	4001-0036	54.95



DC-500 DUST COVER

- Protect your bike from dust and spills in the garage
- Soft, non-scratch brushed poly/cotton
- Folds to fit in small compartment or saddlebag
- Available in light blue

SIZE	PART #	SUG. RETAIL
Large	DC500LG	\$39.95
X-large	DC500XL	49.95
XX-large	DC500XX	59.95



POCKET TRAVEL COVER

- Made from water-resistant superlight-weight Tri-Max® Ripstop® nylon
- Snug elastic with 1" grommets at center and front wheel
- Packs tightly into its own matching carryall
- Available in black
- Sizes to fit every model

SIZE	PART #	SUG. RETAIL
Medium	4001-0067	\$44.95
Large	4001-0068	47.95
X-large	4001-0069	49.95
XX-large	4001-0070	54.95



GUARDIAN® LIMITED EDITION WEATHERALL SPORTBIKE/SCOOTER COVERS – DELUXE SERIES

• DELUXE SERIES •

- Cover in an urban camo design
- Fabricated from medium-weight polyester with waterproof ClimaShield® Plus fabric protection and Moisture-Guard™ ventilation system
- Aluminized heat panels protect the hot parts of the bike; soft fabric lining prevents windshield scratches
- Tape sealed seams make cover waterproof
- Lockable grommets allow for cable lock use (lock not included) and elastic bottom rim for snug fit
- Alarm ready for use with Dowco's Guardian Secure Alarm for additional security (alarm sold separately)



4001-0072

DESCRIPTION	PART #	SUG. RETAIL	DESCRIPTION	PART #	SUG. RETAIL
For sportbikes	4001-0072	\$94.95	For 50-80cc scooters	4001-0073	\$46.95

GUARDIAN® EZ ZIP MOTORCYCLE COVER

• ELITE SERIES •

- Eliminates hassles associated with putting a cover on a bike or removing it
- A zipper located at the rear of the cover makes cover installation and removal fast, easy and convenient
- Constructed of heavy-duty polyester material for long-lasting durability
- ClimaShield™ Plus fabric coatings ensure water repellency and UV stability and retard the growth of mildew
- Exclusive Moisture-Guard™ venting system prevents the accumulation of unwanted moisture under the cover
- Scorch-resistant aluminized heat shield panel allows the cover to be put on the bike before the pipes have cooled
- Unique locking grommets facilitate the use of a cable lock to secure your motorcycle
- Elastic cord sewn into the hem of the cover ensures a snug fit
- Special soft cover liner in the area of the motorcycle windshield protects against possible scratching
- EZ On and EZ Off zipper to make the installation and removal of the cover hassle-free
- Includes convenient storage bag



SIZE	PART #	SUG. RETAIL
X-large	50020-00	\$123.95
XX-large	50021-00	129.95
XXX-large	50022-00	133.95

GUARDIAN® WEATHERALL™ PLUS

• ELITE SERIES •

- Fabricated from heavy polyester with waterproof ClimaShield® Plus fabric protection and Moisture-Guard™ ventilation system
- Aluminized heat shields allow immediate use after riding
- Reinforced sewn-in grommets for cable or bar lock use and elastic bottom rim for snug fit
- Interior pockets where Guardian Alarms can be added for additional security (alarms sold separately)
- Protects windshield with a layer of scratch-resistant lining bonded to the inside of the cover
- Three sizes fit motorcycles listed



4001-0003

4001-0071

G-175

DESCRIPTION	PART #	SUG. RETAIL
Angled front, small-to-medium cruisers w/ windshield, sissy bar and saddlebags	4001-0003	\$94.95
For Adventure Touring bikes	4001-0071	95.95
Trike cover (fits conversions from Lehman, Motor Trike, Trike Shop and most others)	G-175	103.95

All part numbers in **BOLD MAGENTA** are new this year.

- EXHAUST
- TIRES & ACCESSORIES
- LUGGAGE
- SPORTBIKE ACCESSORIES
- CRUISER ACCESSORIES
- TOURING ACCESSORIES
- SECURITY & AUDIO
- GENERAL ACCESSORIES
- FAIRINGS & BODY
- SEATS
- HANDLEBARS & CONTROLS
- LIGHTING
- ELECTRICAL
- SPROCKETS
- CHAINS
- BRAKES
- SUSPENSION
- ENGINE
- SYSTEMS
- LUBES
- TOOLS
- TRAILER
- MERCH.
- CROSS REFERENCE
- INDEX

- EXHAUST
- TIRES & ACCESSORIES
- LUGGAGE
- SPORTBIKE ACCESSORIES
- CRUISER ACCESSORIES
- TOURING ACCESSORIES
- SECURITY & AUDIO
- GENERAL ACCESSORIES
- FAIRINGS & BODY
- SEATS
- HANDLEBARS & CONTROLS
- LIGHTING
- ELECTRICAL
- SPROCKETS
- CHAINS
- BRAKES
- SUSPENSION
- ENGINE
- FUEL SYSTEMS
- LUBES
- TOOLS
- TRAILER
- MERCH.
- CROSS REFERENCE
- INDEX

DOWCO®

• DELUXE SERIES •



4001-0050



4001-0055



GUARDIAN® WEATHERALL™ PLUS MOTORCYCLE COVERS

- Features four built-in alarm sleeves so you can make your bike more secure by adding Secure Alarm Systems to your cover
- Alarms sold separately
- Fabricated from heavy polyester with waterproof undercoating and Moisture-Guard™ ventilation system
- Reinforced grommets for cable or bar locks and elastic bottom rim for snug fit
- Black with silver side panels; storage bag included

DESCRIPTION	PART #	SUG. RETAIL
Medium	4001-0054	\$84.95
Large	4001-0050	94.95
X-large	4001-0051	105.95

DESCRIPTION	PART #	SUG. RETAIL
XX-large	4001-0052	\$115.95
XXX-large	4001-0053	126.95
Sportbike	4001-0055	99.95

GUARDIAN® SECURE ALARM

- Added security for the Weatherall™ Plus cover
- Pin-pull alarm emits an ultraloud 130 dB tone when activated by unauthorized movement of the cover
- Battery-powered alarm (battery not included) requires no special wiring and installs in minutes; 9V battery required
- For all Guardian Weatherall covers with sewn-in alarm sleeves

SUG. RETAIL.....\$20.95
PART # 4020-0030

GUARDIAN® WEATHERALL™

- Water-repellent urethane-coated polyester material with aluminized panels to cover hot engine and exhaust pipes
- Flannel panel protects windshield from scratches (XX-large, X-large and large only)
- Reinforced grommets for cable or bar locks and elastic bottom rim for snug fit
- Available in gray with silver panels
- Product may be labeled or packaged as Protector or Guardian Weatherall



DESCRIPTION	SIZE	PART #	SUG. RETAIL
Sport/custom	M	PX-50	\$76.95
Full dress	L	PX-100	81.95
Touring	XL	PX-125	86.95

DESCRIPTION	SIZE	PART #	SUG. RETAIL
Large touring	XXL	PX-150	\$91.95
Gold Wing 1832cc 01	XXXL	PX-200	97.95

GUARDIAN® WEATHERALL™ MOTORCYCLE COVER

- Specifically designed to fit sportbikes
- Medium-weight polyester construction provides excellent protection and durability, while offering a cover light enough for easy use
- ClimaShield™ fabric coatings ensure water repellency, UV stability and retard the growth of mildew
- Exclusive Moisture-Guard™ venting system prevents the accumulation of moisture under the cover
- Unique locking grommets facilitate the use of a cable lock to secure your motorcycle
- Scorch-resistant aluminized heat shield panel allows the cover to be put on the bike before the pipes have cooled
- Elastic cord sewn into the hem of the cover to ensure a snug fit
- Special soft cover liner on windshield
- Includes a convenient storage bag



SUG. RETAIL.....\$84.95 **PART # 50007-00**

DOWCO®



GUARDIAN® ULTRALITE™ PLUS MOTORCYCLE COVER

- Small, compact design is ideal for longer rides; stores easily anywhere
- Lightweight ripstop polyester fabric construction for enhanced tear and abrasion resistance
- Combined UV and water-repellant coating provides protection from dirt, pollution and harsh sunlight; two vent flaps expel moisture
- Sewn-in storage bag on the cover's interior is a place for storing gloves, sunglasses and other small items
- Features full-perimeter elastic on bottom, underbelly straps for a secure fit, soft interior lining to protect windshields and lockable grommets for added security



DESCRIPTION	PART #	SUG. RETAIL
Medium, sportbikes, small cruisers w/o windshields	4001-0056	\$49.95
Large, cruisers, touring/sport touring	4001-0057	51.95

DESCRIPTION	PART #	SUG. RETAIL
X-large, large touring	4001-0058	\$55.95
For Adventure Touring bikes	4001-0074	56.95

LEG-02



4001-0023



4001-0032



GUARDIAN® ULTRA LITE

- Water-resistant nylon with Vent-Aire system to protect your bike from moisture
- Reinforced grommets for cable or bar locks and elastic bottom rim for snug fit
- Storage bag included
- Three sizes provide great protection for larger motorcycles

DESCRIPTION	SIZE	COLOR	PART #	SUG. RETAIL
Sportbikes/small cruisers w/o windshields	M	Gray/silver	LEG-01	\$35.95
Cruisers/touring	L	Gray/silver	4001-0034	39.95
Touring/full dress	XL	Gray/silver	LEG-02	41.95
Sportbikes/small cruisers w/o windshields	M	Blue/silver	4001-0023	35.95

DESCRIPTION	SIZE	COLOR	PART #	SUG. RETAIL
Sportbikes/small cruisers w/o windshields	L	Blue/silver	4001-0024	\$39.95
Cruisers/touring	XL	Blue/silver	4001-0025	41.95
Sportbikes/small cruisers w/o windshields	L	Yellow/silver	4001-0032	39.95
Cruisers/touring	XL	Yellow/silver	4001-0033	41.95

GUARDIAN® DUSTER

• DELUXE SERIES •

- Store your prized motorcycle inside and keep dirt and dust off
- Ideal for indoor storage
- Designed to keep the bike clean at an affordable price
- Constructed of a soft cotton material that won't scratch or harm the finish of the motorcycle
- Natural cotton materials are breathable to let potentially harmful moisture escape from inside the cover
- Elastic cord sewn into the hem of the cover ensures a snug fit
- Unique locking grommets facilitate the use of a cable lock to secure your motorcycle

SIZE	PART #	SUG. RETAIL
Medium	50034-00	\$69.95
Large	50035-00	73.95
XXX-large	50036-00	84.95



All part numbers in **BOLD MAGENTA** are new this year.

- EXHAUST
- TIRES & ACCESSORIES
- LUGGAGE
- SPORTBIKE ACCESSORIES
- CRUISER ACCESSORIES
- TOURING ACCESSORIES
- SECURITY & AUDIO
- GENERAL ACCESSORIES
- FAIRINGS & BODY
- SEATS
- HANDLEBARS & CONTROLS
- LIGHTING
- ELECTRICAL
- SPROCKETS
- CHAINS
- BRAKES
- SUSPENSION
- ENGINE
- FUEL SYSTEMS
- LUBES
- TOOLS
- TRAILER
- MERCH.
- CROSS REFERENCE
- INDEX

- EXHAUST
- TIRES & ACCESSORIES
- LUGGAGE
- SPORTBIKE ACCESSORIES
- CRUISER ACCESSORIES
- TOURING ACCESSORIES
- SECURITY & AUDIO
- GENERAL ACCESSORIES
- FAIRINGS & BODY
- SEATS
- HANDLEBARS & CONTROLS
- LIGHTING
- ELECTRICAL
- SPROCKETS
- CHAINS
- BRAKES
- SUSPENSION
- ENGINE
- FUEL SYSTEMS
- LUBES
- TOOLS
- TRAILER
- MERCH.
- CROSS REFERENCE
- INDEX

DOWCO®



LEG03



26015-00

GUARDIAN® TRAVELER™ MOTORCYCLE COVER

- Protect your bike on the road when you don't have room for a full-size cover
- Traveler covers the essentials, then folds compactly for storage
- Tough, lightweight urethane-coated poly construction, water repellent and quick drying
- Will enclose fairing, seat and rear trunk
- Includes shock cord hem and footpeg straps

DESCRIPTION	SIZE	COLOR	PART #	SUG. RETAIL
Touring	XL	Gray	LEG03	\$41.95

DESCRIPTION	SIZE	COLOR	PART #	SUG. RETAIL
Sportbikes	SP	Gray	26015-00	\$36.95

GUARDIAN® STORE AWAY

- Now an inexpensive indoor storage cover that's intended to replace that old sheet, blanket or tarp
- A universal-fit cover that will protect the motorcycle from dust and dirt while it is being stored in a garage
- Made of soft material to prevent scratching of the motorcycle's finish
- Breathable fabric to prevent the accumulation of moisture inside of the cover
- Two sizes to fit most all motorcycles, including the largest touring models



SIZE	PART #	SUG. RETAIL
Large	50012-00	\$35.95

SIZE	PART #	SUG. RETAIL
X-large	50008-00	\$41.95



PVC MOTORCYCLE COVERS

- Basic motorcycle cover constructed of heavy-duty PVC plastic to protect the motorcycle from the elements
- 100% PVC construction means a cover that is 100% waterproof
- Include grommets in the hem to allow for the use of a motorcycle locking device
- Two sizes to fit most motorcycles

SIZE	PART #	SUG. RETAIL
Large	50037-00	\$23.95
X-large, up to 1400cc	50038-00	25.95

All part numbers in **BOLD MAGENTA** are new this year.



• DELUXE SERIES •

GUARDIAN® WEATHERALL™ SCOOTER COVERS

- Waterproof and lightweight urethane-coated polyester with aluminized panels to cover hot engine and exhaust pipes
- Reinforced grommets for cable or bar locks and elastic bottom rim for snug fit
- Four sizes fit all scooters

DESCRIPTION	PART #	SUG. RETAIL
Most scooters up to 650cc	4001-0004	\$48.95
Most scooters 80cc to 250cc w/ full windshield and trunk	SX-100	46.95
Most scooters 80cc to 250cc w/ mirrors only	SX-50	42.95
Most scooters and mopeds 50cc and under w/ mirrors only	SX-45	42.95

GUARDIAN® COVER COMPRESSION TOOL

- Available in two sizes to compress any bike cover to its true packed potential
- Made from tough, lightweight nylon
- Uses four cinch straps and two compression pockets to squeeze cover to minimum size
- Small measures 15" x 5"; 6.7" x 5" compressed
- Large measures 23" x 7.5"; 11" x 7.5" compressed

DESCRIPTION	PART #	SUG. RETAIL
Small (for Traveler, Ultralite and Ultralite Plus covers)	3515-0067	\$20.95
Large (for Weatherall and Weatherall Plus covers)	3515-0068	23.95

4001-0004

SX-45

3515-0067

3515-0068

DOWCO COVER APPLICATIONS

FITS MODEL	SIZE
APRILIA	
All sport bikes	M
BUELL	
All bikes	M
BIMOTA	
All bikes	M
BMW	
R65/R65LS/R75S/R80/R80ST	M
K75	M
K75RT	LG
R80R/R80RT	LG
K100LT	LG
K100RS	M
K100RT	LG
R100/R100GS	M
R100R/R100RS/R100RT	LG
F650	LG
F700	M
K1100RS	M
R1100S/R110RS	M
R1100RT	LG
R1150GS	LG
K1200/K1200RS	LG
K1200LT	XXL
R1200C/R1200CE	LG
R1200 Phoenix	LG
CAGIVA	
All bikes	M
DUCATI	
748/748S/750 Sport	M
966R/996/996S	M
Monster/600/900S4	M
ST2	LG
ST4	LG
Supersport 750/900	M
EXCELSIOR-HENDERSON	
Super X	LG
HONDA	
All dual purpose	M
Silver Wing	LG
CB125/CB250 Nighthawk	M
CM250/CM450	M
CMX250 Rebel/450 Rebel	M

FITS MODEL	SIZE
HONDA (CONT)	
CN250 Helix	XL
CB450 Nighthawk	M
V45 Sabre	M
VF500F Interceptor	M
VF500 Ascot	M
VF500C Magna	M
CB550 Nighthawk/CB750 Nighthawk S	M
CX550	M
CBR600 F3/CBR600 Hurricane	M
VT600 Shadow/Shadow DLX 600	LG
VF700 Magna	LG
VFR700 Interceptor	M
VF750 Magna	LG
VF750 Interceptor	M
VFR750	M
VT750 Shadow ACE Deluxe/ACE 750	LG
VT750 Shadow Spirit	M
CB750 Nighthawk	M
PC800	LG
VFR800	M
VFR800 Interceptor	M
CBR900RR/CBR1000 Hurricane	M
CBR929RR	M
CB1/CB1000	M
RV1000 RC51	M
VG1000 Interceptor	M
VTR1000 Superhawk	M
CBR1100/CBR600 F4/CBR900RR	M
ST1100	LG
VF1100C Magna	M
VF1100S Sabre	M
VT1100 Shadow Aero	LG
VT1100 Shadow Sabre	LG
VT1100 Shadow ACE/Shadow Spirit	LG
VT1100 Shadow Tour	LG
VT1100C Shadow Sabre	XL
GL1200 Gold Wing	XL
GL1500 Gold Wing	XXL
GL1500 Gold Wing w/ accessories	XXXL
GL1500 Valkyrie	XL
GL1500 Valkyrie Interstate	XXL
GL1500 Valkyrie Touring	XL

FITS MODEL	SIZE
HONDA (CONT)	
GL1800 Gold Wing	XXXL
VTX1800	LG
KAWASAKI	
Ninja (all)	M
KZ440 LTD/KZ450 LTD	M
EN500/Eliminator 125	M
550 LTD	M
KZ550 LTD/KZ750 LTD	M
ZR550 Zephyr/ZR750 Zephyr	M
ZL600 Eliminator	M
KL650	M
W650	M
VN750/800 Vulcan	LG
ZN750 LTD	M
VN800J Drifter	XL
ZG1000 Concours	XL
ZL1000 Eliminator	M
ZN1100 LTD	M
ZR1100	M
ZRX1100	M
ZG1200 Voyager	M
ZN1300 Voyager	XXL
VN1500 Vulcan Classic	LG
VN1500 Vulcan Drifter/Nomad	XL
VN1500L Vulcan	LG
MOTO GUZZI	
All sport bikes	M
California 3/Centauro V10/V11/Jackal	LG
SUZUKI	
GZ250	M
GS450G/GS450L	M
GS500E	M
GS550GL/GS550L/GS1100GL	M
GSF600/1200S Bandit	M
GSF600/GS1100	M
GSX-R600/GSX-R750/GSX-R1100	M
GSX600F/GSX750F Katana	M
LS650 Savage	M
SV650S/TL1000S	M
VS700 Intruder	M
VL800 Volusia	M
VZ800 Marauder	M

FITS MODEL	SIZE
SUZUKI (CONT)	
GS850G/GS850GL	M
RF900R	M
GS1100GKE	XL
GSX-R1300R Hayabusa	M
CV1400 Cavalcade	XL
VS1400 Intruder	LG
VL1500 Intruder	XL
TRIUMPH	
Daytona 900/955	M
Daytona	M
Legend	M
Sprint/Sprint ST/Sprint RS	M
Thunderbird/Thunderbird Sport	M
Tiger	M
Trophy 900/1200	LG
TT600	M
VICTORY	
V92C/V925C	M
V92C Deluxe	XL
YAMAHA	
SRX250/SRX600	M
RZ350/RZ500	M
XV500 Virago	M
XV535 Virago	M
F1600/FJ1100/FJ1200	M
FZ600/FZ700/FZ750/FZR1000	M
YZF600 R6/YZF1000 R1	M
YX600 Radian	M
XJ600S Seca	M
FZ700 Fazer	M
XJ700/XJ750 Maxim	M
XV700/XV750/XV1100/XV1100 Virago	LG
XJ1100 Maxim	M
XV1100 V-Star	M
VMX1200 V-Max	M
XVZ1300 Royal Star	LG
XVZ1300 Royal Star Classic	XL
XVZ1300 Venture/Venture Royale	XL
XV1600 Road Star	LG
XV1600 Road Star Silverado	XL
XV1700 Road Star Warrior	XXL

All part numbers in **BOLD MAGENTA** are new this year.

- EXHAUST
- TIRES & ACCESSORIES
- LUGGAGE
- SPORTBIKE ACCESSORIES
- CRUISER ACCESSORIES
- TOURING ACCESSORIES
- SECURITY & AUDIO
- GENERAL ACCESSORIES
- FAIRINGS & BODY
- SEATS
- HANDLEBARS & CONTROLS
- LIGHTING
- ELECTRICAL
- SPROCKETS
- CHAIN
- BRAKES
- SUSPENSION
- ENGINE
- FUEL SYSTEMS
- LUBES
- TOOLS
- TRAILER
- MERCH.
- CROSS REFERENCE
- INDEX



ULTRAGARD® CLASSIC COVERS

- Water-resistant, lightweight polyurethane-coated polyester construction
- Scorch-resistant exhaust protection
- Elastic hem
- SoftTek windshield protection
- Bungee cord for tie-down
- Storage pouch
- Cruiser cover also features an expandable windshield pocket
- Available in medium (M), large cruiser (L) and extra-large touring (LT) sizes



COLOR	PART #	SUG. RETAIL
M		
Black/charcoal	4001-0082	\$41.95
Sand/black	4001-0083	41.95
L		
Black/charcoal	4001-0085	53.95

COLOR	PART #	SUG. RETAIL
L (CONT)		
Sand/black	4001-0086	\$53.95
LT		
Sand/black	4001-0084	53.95



ULTRAGARD® CLASSIC II COVERS



- Water-resistant, lightweight, polyurethane-coated polyester construction
- UV stability prevents material breakdown and fading
- Scorch-resistant exhaust protection
- Elastic hem
- SoftTek windshield protection
- Ultragard® vent system
- Available in scooter (S), medium cruiser (M), large cruiser (L), extra-large touring (LT), extra-large bagger (XL) and trike (T)

COLOR	PART #	SUG. RETAIL
SCOOTER		
Blue/black	4001-0111	\$41.95
Red/black	4001-0112	41.95
M		
Blue/black	4001-0106	56.95
Charcoal/black	4001-0107	56.95
Red/black	4001-0108	56.95
L		
Blue/black	4001-0046	80.95

COLOR	PART #	SUG. RETAIL
L (CONT)		
Charcoal/black	4001-0047	\$80.95
Red/black	4001-0048	80.95
LT		
Blue/black	4001-0039	73.95
Black/gold	4001-0040	73.95
Charcoal/black	4001-0042	73.95
Red/black	4001-0043	73.95

COLOR	PART #	SUG. RETAIL
XL		
Charcoal/black	4001-0091	\$73.95
Red/black	4001-0092	73.95
TRIKE		
Black/gold	4001-0109	80.95
Charcoal/black	4001-0110	80.95



ULTRAGARD® CLASSIC HALF COVERS

- Water-resistant, lightweight polyester construction
- Scorch-resistant exhaust protection
- SoftTek windshield protection
- Ultragard® vent system

DESC.	PART #
Gray	4001-0037
Sand	4001-0038
Black	4001-0105

SUG. RETAIL..... **\$38.95**



UNIVERSAL HALF COVER

- Compact motorcycle cover is ideal for traveling; takes up far less storage space than full cover
- Covers seat, windshield, and front of bike
- Expandable windshield pocket
- Universal fit

SUG. RETAIL..... **\$37.95**

COLOR	PART #	COLOR	PART #
Black	4001-0089	Gray	4001-0090



ULTRAGARD® DUST COVERS

- Lightweight non-woven construction for minimal condensation
- Elastic hem
- Bungee cord for tie-down
- Expandable windshield and backrest pouches
- Storage pouch
- Available in beige in cruiser (DC) and touring (DT) sizes

SUG. RETAIL..... **\$37.95**

SIZE	PART #
Cruiser (DC)	4001-0087
Touring (DT)	4001-0088



ULTRAGARD® FITMENT CHART

MOTORCYCLE

FITS MODEL	SIZE
BMW	
F650/CS/GS	M
R1100RT	M
R1150RT/GS	M
K1200GT/RS/S	XL, Half
K1200LT	XL
R1200C/CE	M
R1200GS	M
R1200RT	M, Half
R1200S/ST	M
HONDA	
CB250 Nighthawk	M
CMX250 Rebel	M
CBR600/900/929/954/1000/1100	M
VT600 Shadow VLX	M
VF750 Magna	M
VT750C/CD Shadow Aero/ACE	L, DC
VT750 Shadow Spirit	M
GL1000 Gold Wing	L, DC
ST1100/1300	XL, Half

FITS MODEL	SIZE
HONDA (CONT)	
GL1100/1200 Gold Wing	LT, Half
VT1100 Shadow	L, DC
VTX1300/1800R/S	L, DC
GL1500C/CT Valkyrie/Tourer	L, DC
GL1500 Valkyrie Interstate	XL, Half
GL1500/1800 Gold Wing	Half, LT, DT
KAWASAKI	
EX250/500/ZX600/636/750/900/1000/1200/1400 Ninja	M
VN750/800/900 Vulcan	L, DC
ZG1200/ZN1300 Voyager	LT, Half
Concourse	M
VN1500/1600/2000 Vulcan	L, DC
VN1500 Vulcan Mean Streak	L, DC
SUZUKI	
GSF400/600 Bandit	M
DL650/1000	M
S40 Boulevard	M
SV650/1000	M

FITS MODEL	SIZE
SUZUKI (CONT)	
C50/90 Boulevard	L, DC
S50/83 Boulevard	L, DC
M50/95/109 Boulevard	L, DC
GSX-R600/750/1000	M
VL800 Intruder Volusia	L, DC
VS800/1400 Intruder	L, DC
VZ800 Marauder	L
GSX1300R Hayabusa	M
VS1400GLF/GLP Intruder	L
VL1500 Intruder	L, DC
VZ1600 Marauder	L
TRIUMPH	
America/Speedster	L, DC
Bonneville	M
Daytona	M
Legend	M
Rocket III	L, DC
Speed Triple/Four	M
Sprint ST	M
Thunderbird	M

FITS MODEL	SIZE
TRIUMPH (CONT)	
Tiger	M
VICTORY	
Hammer	L, DC
Kingpin	L, DC
Kingpin Tourer	XL
Vegas	L, DC
V92C	L, DC
YAMAHA	
XV250/535 Virago	M
FZS600/1000 FZ6/FZ1	M
YZF-R6/R1	M
XVS650/100 V-Star	L, DC
XV700/1100 Virago	L, DC
VMX1200 V-Max	M
FJR1300	XL, Half
XVZ1300 Royal Star	L, DC
XVZ1300 Royal Star Venture	XL, Half
XVZ1300 Royal Star Tour Deluxe	XL
XV1600/1700 Road Star	L, DC
XV1700 Road Star Warrior	L, DC
XV1900 Roadliner/Stratoliner	L, DC

SCOOTER

FITS MODEL	SIZE
APRILIA	
Scarabeo 50/125	S
SR 50	S
HONDA	
Elite 50/80	S
Helix	M
Metropolitan	S
Reflex	M

FITS MODEL	SIZE
HONDA (CONT)	
Ruckus	S
Big Ruckus	M
Silver Wing	M
KYMCO	
Cobra Cross/Racer	S
Filly	S
Grand Vista 250	M

FITS MODEL	SIZE
KYMCO (CONT)	
People 50/150	S
Super 9	S
Vitality	S
Xciting 250/500	M
ZX 50	S
SUZUKI	
Burgman 400/650	M

FITS MODEL	SIZE
VESPA	
ET2/ET4	S
Grandturismo 200	M
YAMAHA	
Majesty 400	M
Lehman	S
Vino	S
XC 125	S

TRIKE

FITS MODEL	SIZE
DFT	T
Hannigan	T
Lehman	T
Motor Trike	T
Trike Shop	T

All part numbers in **BOLD MAGENTA** are new this year.

- EXHAUST
- SEAT & BAGS
- TRUNKAGE
- SPORTBIKE ACCESSORIES
- CRUISER ACCESSORIES
- TOURING ACCESSORIES
- SECURITY & AUDIO
- GENERAL ACCESSORIES
- FAIRINGS & BODY
- SEATS
- HANDLEBARS & CONTROLS
- LIGHTING
- ELECTRICAL
- SPROCKETS
- CHAINS
- BRAKES
- SUSPENSION
- ENGINE
- FUEL SYSTEMS
- LUBES
- TOOLS
- TRAILER
- MERCH.
- CROSS REFERENCE
- INDEX

EXHAUST
TIRES & ACCESSORIES
LUGGAGE
SPORTBIKE ACCESSORIES
CRUISER ACCESSORIES
TOURING ACCESSORIES
SECURITY & AUDIO
GENERAL ACCESSORIES
FAIRINGS & BODY
SEATS
HANDLEBARS & CONTROLS
LIGHTING
ELECTRICAL
SPROCKETS
CHAIN
BRAKES
SUSPENSION
ENGINE
FUEL SYSTEMS
LUBES
TOOLS
TRAILER
MERCH.
CROSS REFERENCE
INDEX

4001-0097



GEARS

PREMIUM MOTORCYCLE COVERS

- Heavy-duty 600-denier polyester construction with polyurethane coating for UV-protection and water-resistance
- Vent guard system allows cover to breathe, reducing moisture buildup
- Aluminum-coated heat shields allow cover to be used on hot pipes
- Windshield area is made of non-abrasive material to prevent scratching
- Elastic hems and web tie-down
- X-large features hook-and-loop slot in the rear for easy access to luggage and accommodation of dual antennas

DESCRIPTION	PART #	SUG. RETAIL
Medium (up to 95"), for small cruisers and 400cc-600cc sportbikes	4001-0097	\$69.95
Large (up to 100"), for cruisers, sport touring and over 600cc sportbikes	4001-0098	69.95
X-large (up to 104"), for large touring and large cruisers	4001-0099	73.95
GL, for Honda GL1200/1500/1800 Gold Wing/Valkyrie	4001-0101	95.95

4001-0101



FORM-FIT MOTORCYCLE COVERS

- Body-hugging polyester knit outer shell is made with spandex to provide stretch and recovery
- Inside the shell is a 100% cotton terry loop that is sheared to a luxurious fleece finish so it won't mar painted or finished surfaces
- Follow every curve of your bike for a truly custom fit
- For indoor use only
- Available in black

FITS MODEL

For full-dress touring bikes w/ fairing or windshield, saddlebags, backrest/sissy bar and/or top trunk
For large sport bikes w/ or w/o saddlebags

4001-0066



PART #	SUG. RETAIL
4001-0064	\$258.95
4001-0066	186.95



READY-FIT MOTORCYCLE COVERS

- Waterproof silver urethane-coated polyester fabric efficiently reflects heat; soft fabric inner liner protects against scratches in the windshield area
- Overlapping double-stitched seams give strength and durability; aluminized liner protects cover from hot bike parts
- Elastic hem front and rear holds cover in place
- Steel cable reinforced fastening grommets help discourage theft; will accept any long hasp bike lock or Covercraft ZCML lock/cable kit
- Protects against sun, rain, snow, bird and tree droppings, industrial pollutants and salt air
- Includes sewn-in storage bag

DESCRIPTION	PART #	SUG. RETAIL
For largest touring machines; 1100cc/up	XM-100	\$110.95
For 500-1000cc/full dress	XM-101X	103.95
For up to 750cc w/ or w/o mirrors	XM-104X	86.95



XM-100



DESCRIPTION	PART #	SUG. RETAIL
For most sportbikes with fairings up to 1100cc	XM-105X	\$88.95
For large cruiser (1100-1500cc) cover w/ accessories	XM-107X	97.95
Cable and lock, 30"	ZCML	8.95

4001-0102



MOTORCYCLE COVERS

- Full size, lightweight cover
- Polyester construction with an elastic hem
- Available in black

DESCRIPTION	PART #	SUG. RETAIL
Medium, fits small cruisers without windshield and sport bikes	4001-0102	\$27.95
Large, fits large cruisers, Touring and Sport Touring models	4001-0103	31.95
X-large, fits large Touring bikes	4001-0104	37.95



**PARTS
UNLIMITED**

HEAVY-DUTY CAM BUCKLE TIE-DOWNS

- 1" nylon web strap, 66" long heavy-duty; rated at more than 1,200 lb. straight pull strength
- Cam action buckle
- Vinyl-coated 3/8" hooks
- Easy operation with maximum holding power
- Packaged and sold in pairs

SUG. RETAIL.....\$19.95



COLOR	PART #
Red	TD100
Blue	TD200
Black	TD300
Lime green	TD600
Purple	TD800

HEAVY-DUTY RATCHETING TIE-DOWNS

- 1" nylon web strap, 6' long, rated at 1,500-lb. strength
- Ratchet for easy cinching
- Vinyl-coated 3/8" hooks rated at 1,200 lb.
- Available in red, black or blue; packaged and sold each

SUG. RETAIL.....\$18.95



COLOR	PART #
Red	131021
Black	131022
Blue	131023

HEAVY-DUTY CAM BUCKLE TIE-DOWNS

- 1 1/2" x 6' webbing is rated at 5,000 lb. strength
- Nonslip cam buckles are made of strong cast aluminum
- Hooks are 3/8" in diameter and rated at 1,200 lb. strength
- Full vinyl coating to protect chrome and paint
- Packaged and sold in pairs

SUG. RETAIL.....\$18.95



COLOR	PART #
Black	3920-0077
Red	3920-0078
Blue	3920-0079

HEAVY-DUTY RATCHETING TIE-DOWNS WITH BUILT-IN ASSIST

- 1 1/2" W x 6' L with built-in assist
- Webbing is rated at 5,000-lb. strength
- Ratcheting for easy cinching
- Two vinyl-coated hooks rated at 1,200-lb. straight-pull strength
- Available in red, black or blue; packaged and sold each

SUG. RETAIL.....\$23.95



COLOR	PART #
Red	1702-1000
Black	1702-1001
Blue	1702-1002

TIE-DOWN EXTENSIONS

- Extend reach or may be used as soft ties to protect handlebars, finishes, etc.
- Made of 1" top-quality web straps
- 18" with loops on both ends
- Sold in pairs

SUG. RETAIL.....\$5.95



COLOR	PART #
Red	13-0001
Black	13-0002
Blue	13-0003

HEAVY-DUTY CAM BUCKLE TIE-DOWNS WITH BUILT-IN ASSIST

- 1" nylon web strap, 66" long heavy-duty with built-in assist; rated at more than 1,200-lb. straight pull strength
- Cam action buckle
- Vinyl-coated 3/8" hooks
- Easy operation with maximum holding power
- Packaged and sold in pairs



SUG. RETAIL.....\$19.95

COLOR	PART #
Black	3920-0071
Red	3920-0072
Blue	3920-0073

HEAVY-DUTY RATCHETING TIE-DOWNS WITH BUILT-IN ASSIST

- 1" nylon web strap, 6' long with built-in assist; rated at more than 1,200 lb. straight pull strength
- Ratchet for easy cinching
- Vinyl-coated 3/8" hooks
- Available in red, black or blue; packaged and sold each

SUG. RETAIL.....\$17.95



COLOR	PART #
Black	3920-0074
Red	3920-0075
Blue	3920-0076

HEAVY-DUTY CAM BUCKLE TIE-DOWNS WITH BUILT-IN ASSIST

- 1 1/2" W x 6' L with built-in assist
- Webbing is rated at 5,000-lb. strength
- Nonslip cam buckles are made of strong cast aluminum with twice the strength of foreign buckles to promote longer life for the tie-down
- Hooks are 3/8" in diameter and rated at 1,200-lb. strength
- Full vinyl coating to protect chrome and paint
- Available in red, blue and black
- Packaged and sold in pairs

SUG. RETAIL.....\$22.95



COLOR	PART #
Red	TD00100
Blue	TD00200
Black	TD00300

HEAVY-DUTY RATCHETING TIE-DOWNS

- 1 1/2" x 6' webbing is rated at 5,000-lb. strength
- Ratcheting for easy cinching
- Two vinyl-coated hooks rated at 1,200 lb. straight pull strength
- Packaged and sold each

SUG. RETAIL.....\$20.95



COLOR	PART #
Black	3920-0080
Red	3920-0081
Blue	3920-0082

TIE-DOWN EXTENSIONS

- 1 1/2" wide 18" long looped nylon straps
- Use to extend tie-down reach or for added protection of handlebars, seat rails, etc.
- 3,000-lb. assembly strength
- Sold in pairs

SUG. RETAIL.....\$7.95

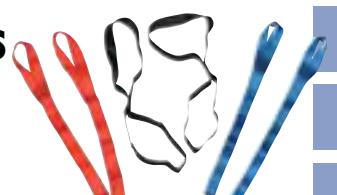

COLOR	PART #
Black	3920-0083
Red	3920-0084
Blue	3920-0085

All part numbers in **BOLD MAGENTA** are new this year.

- EXHAUST
- TIRES & ACCESSORIES
- LUGGAGE
- SPORTBIKE ACCESSORIES
- CRUISER ACCESSORIES
- TOURING ACCESSORIES
- SECURITY & AUDIO
- GENERAL ACCESSORIES
- FAIRINGS & BODY
- SEATS
- HANDLEBARS & CONTROLS
- LIGHTING
- ELECTRICAL
- SPROCKETS
- CHAINS
- BRAKES
- SUSPENSION
- ENGINE
- FUEL SYSTEMS
- LUBES
- TOOLS
- TRAILER
- MERCH.
- CROSS REFERENCE
- INDEX



HANDLEBAR HANDCUFFS

- Provide convenient hooking points to attach a tie-down
- Include soft plush cover to protect tank and neoprene grip guards
- Adjustable for any size bike
- Sold in pairs

SUG. RETAIL..... **\$25.95** PART # **3920-0178**



1" STANDARD TIE-DOWNS

- 4,500-lb. test nylon webbing
- Industrial-grade PowerTie cam buckle
- 3/8" heavy-duty vinyl-coated hooks
- 1,200-lb. assembly strength
- Hand loops for pulling tight
- 5 1/2' length
- Double security stitching
- Sold in pairs

SUG. RETAIL... **\$18.95**



COLOR	PART #
(A) Black	3920-0035
(B) Red	3920-0036
(C) Blue	3920-0037

1" SOFT-TYE TIE-DOWNS

- Original PowerTie design features sewn-in soft-tye
- 4,500-lb. test nylon webbing
- 3/8" heavy-duty vinyl-coated hooks
- PowerTie EZ-release, non-slipping teardrop buckle
- 1,200-lb. assembly strength
- Hand loop for pulling tight
- 5 1/2' length plus soft-tye
- Double security stitching
- Sold in pairs

SUG. RETAIL..... **\$21.95**

COLOR	PART #
Black	3920-0038
Red	3920-0039
Blue	3920-0040
Silver	3920-0041
Green	3920-0042
Yellow	3920-0043



FAT STRAPS

- Feature 6,000-lb. test nylon and 1,200-lb.-rated assembly strength
- 1 1/2" W with a choice of quick-lock buckle or ratchet
- 3/8" heavy-duty, vinyl-coated S-hook
- Snap-hook secure ends fit 1" rails
- Ideal for thicker Pro-bars or a tight area not suitable for hooks
- Soft-Tye is sewn-in so you won't lose it
- PowerTie teardrop buckle
- Double security stitching
- Hand loop for pulling tight
- 5 1/2' L
- Sold in pairs
- Made in the U.S.A.



DESCRIPTION	PART #	SUG. RETAIL
(A) Cam buckle	3920-0027	\$23.95
(B) Ratchet	3920-0028	38.95

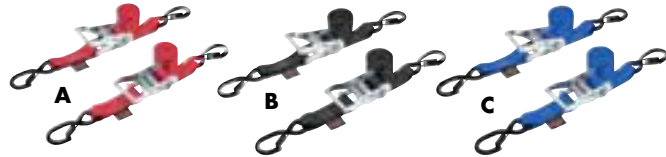

1 1/2" RATCHET WITH SAFETY LATCH HOOKS

- 1 1/2" ratchet tie-downs with vinyl-coated secure hook ends
- 6,000-lb. test nylon webbing; 1,500-lb.-rated assembly
- Double security stitching
- 6 1/2' L
- Sold in pairs
- Made in the U.S.A.

SUG. RETAIL..... **\$35.95**

DESCRIPTION	PART #
(A) Red	3920-0145
(B) Black	3920-0146
(C) Blue	3920-0147

1 1/2" FAT STRAP DELUXE

- 1 1/2" W Chromacoat ratchet
- Vinyl-coated, S-style snap-hook end
- Sewn-in sheepskin Soft-Tye
- 6,000-lb. test nylon webbing
- 1,500-lb. rated assembly
- 6 1/2' length
- Double security stitching
- Sold in pairs



DESCRIPTION	PART #	SUG. RETAIL
(A) Black	3920-0173	\$40.95
(B) Orange	3920-0174	40.95

FAT STRAP TRAILER KITS

- Everything needed for a secure tie down
- Kits include two pair of Fat Strap 1 1/2" deluxe ratchet tie-downs with genuine sheepskin sleeve and vinyl-coated secure hook ends
- 6,000-lb. test nylon webbing; 1,500-lb.-rated assembly
- Double security stitching
- 6 1/2' L
- Include heavy-duty Cordura® nylon storage bag with zipper top closure
- Made in the U.S.A.



SUG. RETAIL..... **\$89.95**

DESCRIPTION	PART #
(A) Black	3920-0137
(B) Orange	3920-0138

BIG DADDY'S TIE-DOWNS

- Feature 7,400-lb. test nylon and 2,600-lb.-rated assembly
- 2" wide with a choice of quick-lock buckle or ratchet
- Available with vinyl-coated snap-hook ends with or without sewn-in Soft-Tye, or vinyl-coated snap hook with 3/8" S-hook bar end
- Measure 6 1/2' long
- Sold in pairs
- Made in the U.S.A.



DESCRIPTION	PART #	SUG. RETAIL
(A) Ratchet w/ two snap-hook ends	3920-0010	\$43.95
(B) Ratchet w/ two snap-hook ends and sewn-in sheepskin Soft-Tye; black	3920-0011	54.95

DESCRIPTION	PART #	SUG. RETAIL
(C) Ratchet w/ two snap-hook ends and sewn-in sheepskin Soft-Tye; orange	3920-0172	\$54.95
(D) Ratchet w/ snap-hook/S-hook end combination	DS-110213	38.95
(E) Quick-lock w/ snap-hook/S-hook end combination	DS-110215	33.95



3920-0044 3920-0045

1" SOFT-TYE TIE-DOWNS WITH SECURE HOOK

- Feature sewn-in Soft-Tye and locking safety secure hook
- 4,500-lb. test nylon webbing
- 3/8" heavy-duty vinyl-coated hooks
- PowerTie EZ-release, non-slipping teardrop buckle
- 1,200-lb. assembly strength
- Hand loop for pulling tight
- 5 1/2' length plus soft-tye
- Double security stitching
- Sold in pairs



3920-0046

SUG. RETAIL.....\$22.95

COLOR	PART #
Black	3920-0044
Red	3920-0045
Blue	3920-0046

SHEEPSKIN SOFT-TYE

- 1.5" Soft-Tyes have 6,000-lb. test and 1" Soft-Tyes have 4,500-lb. test nylon
- 18" L with a 9" L sheepskin sleeve to protect paint and chrome
- Reusable storage pouch
- Sold in pairs
- Made in the U.S.A.



3920-0012

DS-110217

3920-0013

DESCRIPTION	PART #	SUG. RETAIL
1.5" w/ sheepskin sleeves	3920-0012	\$21.95
1.5" w/o sleeves	3920-0013	9.95
1" w/ sheepskin sleeves	DS-110217	18.95

PLUSH SOFT-TYE COVERS

- Slide over existing 1" or 1 1/2" tie-down extensions to guard against scratching paint or chrome
- Strap not included
- Sold in pairs



SUG. RETAIL.....\$7.95 PART # 3920-0136



3920-0143

3920-0142

3920-0144

1 1/2" CAM-BUCKLE WITH SAFETY LATCH HOOKS

- 1 1/2" cam-buckle tie-downs with vinyl-coated secure hook ends
- 6,000-lb. test nylon webbing; 1,200-lb.-rated assembly
- Double security stitching
- 5 1/2' L
- Sold in pairs
- Made in the U.S.A.

SUG. RETAIL.....\$24.95

DESCRIPTION	PART #	DESCRIPTION	PART #
Red	3920-0142	Blue	3920-0144
Black	3920-0143		

TIE-DOWN DUFFLE BAG

- Ideal for storing your PowerTie tie-downs
- Made of heavy-duty Cordura nylon
- Zipper closure
- Holds up to four pairs of Big Daddy's tie-downs or eight pairs of 1" tie-downs
- PowerTie logo



SUG. RETAIL....\$10.95

PART # 3550-0076

1" SOFT-TYE/EXTENSIONS

- Perfect for bars or secure areas too thick for hooks
- Won't scratch paint or chrome
- 4,500-lb. test nylon webbing
- 18" length
- Sold in pairs

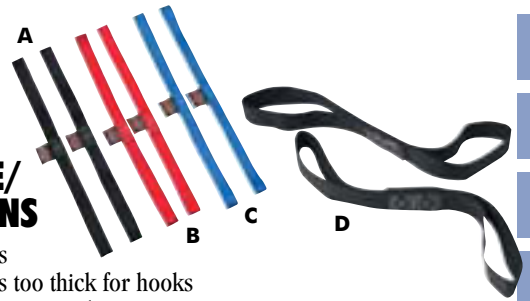

SUG. RETAIL.....\$6.95

COLOR	PART #
(A) Black	3920-0049
(B) Red	3920-0050
(C) Blue	3920-0051
(D) Black (1" x 12")	3920-0120



3920-0139

3920-0140

3920-0141

1 1/2" CAM-BUCKLE WITH SAFETY-LATCH HOOKS AND SOFT-TYE

- 6,000-lb. test nylon webbing; 1,200-lb.-rated assembly
- Double security stitching and sewn-in soft-tye
- 6' L
- Sold in pairs
- Made in the U.S.A.

SUG. RETAIL.....\$24.95

DESCRIPTION	PART #	DESCRIPTION	PART #
Black/red	3920-0139	Black/blue	3920-0141
Black/black	3920-0140		

SHEEPSKIN STRAP COVERS

- 12" long covers with hook-and-loop closures are manufactured from genuine sheepskin
- Can be attached to any 1"-2" wide web straps
- Protect paint and chrome from scratches and scuffing
- Sold in pairs



SUG. RETAIL.....\$23.95 PART # 3920-0014

TIE-DOWN STORAGE BAG

- Perfect for storing your PowerTie tie-downs
- Constructed of heavy-duty Cordura® nylon
- Barrel lock-string closure
- Holds five pairs of 1" tie-downs or two pairs of 2" tie-downs
- PowerTie logo
- Sold each

SUG. RETAIL.....\$5.95

PART # 3550-0024



ADJUSTABLE CARGO NETS

- Premium net is constructed with smaller 2" x 2" mesh (compared to 3" x 3" standard mesh) to secure cargo and help eliminate fall through
- Six ABS plastic hooks are adjustable, durable and designed to reduce scratching
- Sub-hooks for quick tightening adjustments
- 4.5mm (11/64") bungee thickness
- Measures 15" x 15"
- Three colors to choose from

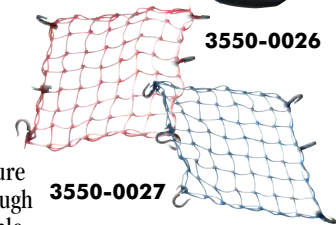

3550-0026

3550-0027

3920-0119

SUG. RETAIL.....\$9.95

COLOR	PART #	COLOR	PART #
Black	3550-0025	Blue	3550-0027
Red	3550-0026	Black (15" x 30")	3920-0119 ¹

¹ SUG. RETAIL \$14.95.

All part numbers in **BOLD MAGENTA** are new this year.

- EXHAUST
- TIRES & ACCESSORIES
- LUGGAGE
- SPORTBIKE ACCESSORIES
- CRUISER ACCESSORIES
- TOURING ACCESSORIES
- SECURITY & AUDIO
- GENERAL ACCESSORIES
- FAIRINGS & BODY
- SEATS
- HANDLEBARS & CONTROLS
- LIGHTING
- ELECTRICAL
- SPROCKETS
- CHAINS
- BRAKES
- SUSPENSION
- ENGINE
- FUEL SYSTEMS
- LUBES
- TOOLS
- TRAILER
- MERCH.
- CROSS REFERENCE
- INDEX



- EXHAUST
- TIRES & ACCESSORIES
- LUGGAGE
- SPORTBIKE ACCESSORIES
- CRUISER ACCESSORIES
- ACCESSORIES
- SECURITY & AUDIO
- GENERAL ACCESSORIES
- FAIRINGS & BODY
- SEATS
- HANDLEBARS & CONTROLS
- LIGHTING
- ELECTRICAL
- SPROCKETS
- CHAIN
- BRAKES
- SUSPENSION
- ENGINE
- FUEL SYSTEMS
- LUBES
- TOOLS
- TRAILER
- MERCH.
- CROSS REFERENCE
- INDEX

E-TRACK CLIPS

- Clip into standard E-tracks (E/A series)
- Can be repositioned for best attachment point
- Available in D-ring with 2" Big Daddy strap (rated 2,000-lb. pull) and heavy-duty O-ring (rated 6,000-lb. pull)
- Sold in 4-packs
- Track not included

DESCRIPTION	PART #	SUG. RETAIL
D-ring clips	3920-0148	\$23.95



DESCRIPTION	PART #	SUG. RETAIL
O-ring clips	3920-0149	\$29.95



E-TRACK HORIZONTAL TRACKS

- 58" L
- Strong 12-gauge steel
- Silver zinc-plated
- Great for personal or commercial trailers

DESCRIPTION	PART #	SUG. RETAIL
E-tracks (2 pack)	3920-0169	\$47.95 (pr.)
E-tracks (8 pack)	3920-0170	21.95 (ea.)

3920-0169

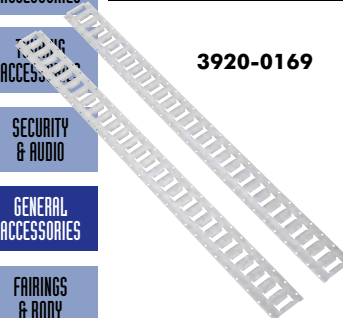

E-TRACK RUBBER END PIECE

- Made of durable, high-impact rubber
- Fits horizontal E-Tracks
- Prevents things getting caught underneath the track ends
- Gives your E-Track a clean, professional look
- Sold in pairs



SUG. RETAIL.....\$11.95

PART # 3920-0171

1 1/2" RATCHET/CAM STRAP

- Great for single-person loading
- Quick-adjusting and easy release with cam buckles
- Sold in pairs



SUG. RETAIL.....\$52.95

PART # 3920-0175

RETRACTOR-1 TIE-DOWNS

- Automatic retracting strap allows for easy setup and removal
- Ratchet allows for precision tension control
- Snap hooks ensure a solid fitting no matter what the conditions
- 1" W black webbing
- 7' L
- Assembly rated to 2,000 lb.
- Sold in pairs



SUG. RETAIL.....\$67.95

PART # 3920-0121

1 1/2" BACK-END RATCHET TIE-DOWN

- Designed especially to secure the back end of custom bikes (via the swingarm) where the distance from floor to frame is very short
- Wraparound area on bike where no hooking point is available
- Ratchet length can be made as short as 9"
- 54" L
- Adjustable sheepskin sleeve
- Sold in pairs
- NOTE: May require the use of a Soft-Tye for some applications.



SUG. RETAIL.....\$28.95

PART # 3920-0029

NEOPRENE RATCHET COVER

- Keeps the metal ratchet from damaging paint and chrome
- Also keeps excess webbing together
- Makes the ratchet stay in the locked position
- Will fit 1" to 2" strap
- PowerTie logo
- Patent pending
- Sold in pairs



SUG. RETAIL...\$15.95

PART # 3920-0052



3920-0122

RETRACTOR-2 TIE-DOWNS

- Automatic retracting strap allows for easy setup and removal
- Ratchet allows for precision tension control
- Available with S-hooks or secure hooks that ensure a solid fitting no matter what the conditions
- Attached "secure hook" carabiner design provides additional security, or use the built-in bolt mount to permanently secure the tie-down to the walls or floor of a trailer



3920-0123

DESCRIPTION	PART #	SUG. RETAIL
Retractor-2 tie-downs w/ S-hooks	3920-0122	\$68.95
Retractor-2 tie-downs w/ secure hooks	3920-0123	73.95

- 2" W black webbing
- 6' L
- Assembly rated to 3,000 lb.
- Sold in pairs

1" RATCHET

- Intended for middle-weight snowmobiles, bikes, ATVs, PWC and shop equipment
- Industrial-grade PowerTie ratchet
- 4,500-lb. test nylon webbing
- 3/8" heavy-duty vinyl-coated hooks
- 1,200-lb. assembly strength
- Double security stitching
- 6' length
- Sold in pairs



SUG. RETAIL.....\$29.95

PART # 3920-0047

1" RATCHET WITH SOFT-TYE

- Intended for middle-weight bikes, ATVs, snowmobiles, PWC and shop equipment
- Industrial-grade PowerTie ratchet
- Sewn-in soft-tye
- 4,500-lb. test nylon webbing
- 3/8" heavy-duty vinyl-coated hooks
- 1,200-lb. assembly strength
- Double security stitching
- 6' length
- Sold in pairs



SUG. RETAIL.....\$32.95

PART # 3920-0048

HONDA BY MOOSE TIE-DOWNS



Licensed ATV Accessories
MOOSE UTILITY DIVISION

- Burly, 6' L x 1 1/2" W nylon strap for strength and security
- Oversize, high-strength rubber-coated hooks
- Available in standard or ratchet buckles
- Sold in pairs
- Made in the U.S.A.



Standard

Ratchet

NOTE: Available only to authorized Honda dealers.

COLOR	PART #	SUG. RETAIL
STANDARD		
Black	3920-0020	\$20.95
Red	3920-0021	20.95
Blue	3920-0022	20.95

COLOR	PART #	SUG. RETAIL
RATCHET		
Black	3920-0023	\$28.95
Red	3920-0024	28.95
Blue	3920-0025	28.95



HEAVY-DUTY TIE-DOWNS

- High-quality tie-downs from a brand you trust
- Built-in soft strap extension
- 1" W x 7' L straps are a foot longer than standard
- Durable rubber-coated hooks
- Exclusive Moose Racing imprinted webbing
- 1,350-lb. strength
- Sold in pairs
- Available in black, blue or red
- Made in the U.S.A.



SUG. RETAIL..... **\$23.95**

COLOR	PART #
Black	3920-0016
Blue	3920-0017

COLOR	PART #
Red	3920-0018

HEAVY-DUTY TIE-DOWNS

- High-quality tie-downs that last
- Two oversized, high strength rubber-coated hooks
- 6' long straps are printed with Moose Utility Division logo
- Available in standard, ratchet, and quad pack, which includes two standard and two ratchet



1" TIE-DOWNS

1" RATCHETING TIE-DOWNS

QUAD PACK

SUG. RETAIL..... **\$19.95**

SUG. RETAIL..... **\$29.95**

SUG. RETAIL.... **\$46.95**

COLOR	1" TIE-DOWNS	1" RATCHETING TIE-DOWNS	QUAD PACK
Black	MD-001	MD-101	MD-201
Red	MD-002	MD-102	MD-202
Blue	MD-003	MD-103	MD-203

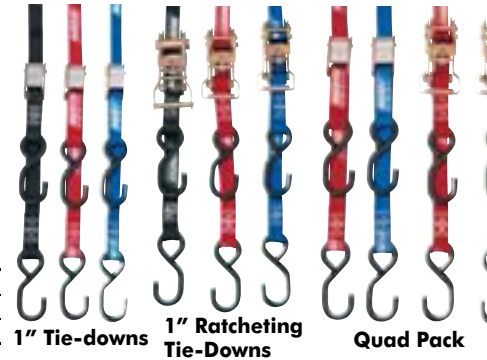

1" Tie-downs

1" Ratcheting Tie-Downs

Quad Pack



INTEGRA RAT PAK

- Twin pack of ratchet-buckle tie-downs with soft-hook tie-down straps for securing motorcycles, snowmobiles, ATVs and other equipment
- Same features as the original Rat Pak but with a soft-hook tie-down strap
- Each measures 6' L
- Vinyl-coated hooks protect finish
- Durable nylon-web straps
- Ratchet buckles feature safety locks
- 1,200-lb. assembly strength; 400-lb. working load limit



SUG. RETAIL..... **\$39.95**

COLOR	PART #
Red	3920-0005
Black	3920-0006

COLOR	PART #
Blue	3920-0007



RAT PAK

- Twin pack of ratchet-buckle tie-down straps with safety locks for securing motorcycles, snowmobiles, ATVs and other equipment
- Each measures 6' L
- Vinyl-coated hooks protect finish
- Durable nylon-web straps
- 1,200-lb. assembly strength; 400-lb. working load limit



SUG. RETAIL..... **\$35.95**

COLOR	PART #
Red	3920-0008
Black	3920-0009

INTEGRA TIE-DOWNS



- Premium-quality cam-buckle tie-downs
- Same features as original tie-downs but with a soft-hook-extension strap
- 69" usable length with 1,200-lb. straight tension strength
- 1" aircraft-quality nylon straps
- Patented pressure plate cam-lock buckles
- 1,800-lb. cam-buckle strength
- Vinyl-coated S-hooks
- Sold in pairs

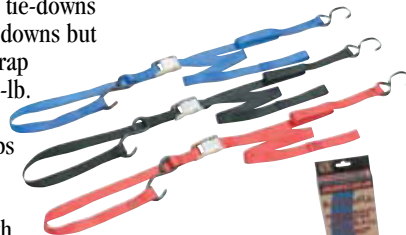

SUG. RETAIL.... **\$36.95**

COLOR	PART #
Red	3920-0002
Black	3920-0003

COLOR	PART #
Blue	3920-0004



STANDARD 5 1/2' TIE-DOWNS



- 1" aircraft-quality nylon straps
- 66" L with 1,200-lb. straight tension strength
- Patented pressure plate cam-lock buckles
- Vinyl-coated S-hooks
- Sold in pairs

SUG. RETAIL..... **\$30.95**

COLOR	PART #
Red	40888-10
Black	40888-26
Neon lime	40888-28
Neon turquoise	40888-29

COLOR	PART #
Neon orange	40888-30
Olive	40888-31
Blue	40888-34

All part numbers in **BOLD MAGENTA** are new this year.

- EXHAUST
- TIRES & ACCESSORIES
- LUGGAGE
- SPORTBIKE ACCESSORIES
- CRUISER ACCESSORIES
- TOURING ACCESSORIES
- SECURITY & AUDIO
- GENERAL ACCESSORIES
- FAIRINGS & BODY
- SEATS
- HANDLEBARS & CONTROLS
- LIGHTING
- ELECTRICAL
- SPROCKETS
- CHAIN
- BRAKES
- SUSPENSION
- ENGINE
- FUEL SYSTEMS
- LUBES
- TOOLS
- TRAILER
- MERCH.
- CROSS REFERENCE
- INDEX

EXHAUST

TIRES & ACCESSORIES

LUGGAGE

SPORTBIKE ACCESSORIES

CRUISER ACCESSORIES

TOURING ACCESSORIES

SECURITY & AUDIO

GENERAL ACCESSORIES

FAIRINGS & BODY

SEATS

HANDLEBARS & CONTROLS

LIGHTING

ELECTRICAL

SPROCKETS

CHAIN

BRAKES

SUSPENSION

ENGINE

FUEL SYSTEMS

LUBES

TOOLS

TRAILER

MERCH.

CROSS REFERENCE

INDEX

RED SNAPPER



- A heavy-duty nylon strap for added security and strength
- One vinyl-coated S-hook; one industrial-quality snap hook
- A spring-loaded latch keeps your cargo stationary
- 66" L with 1,200-lb. straight tension strength
- Sold in pairs

SUG. RETAIL.....\$27.95 PART # 45216-10



TIE-DOWN ANCHOR



- Quick-disconnect tie-down rings bolt to trailer beds, truck boxes, etc.
- Ring detaches from contoured aluminum base quickly when not in use
- 4,000-lb. straight, 2,000-lb. side pull strength
- Sold each

SUG. RETAIL.....\$15.95 PART # 40890-10



13' RED TIE-DOWN

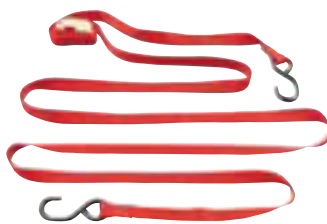

- 1" abrasion-resistant nylon strap
- 13' length with 1,200-lb. straight tension strength
- Vinyl-coated S-hooks
- Sold each

SUG. RETAIL.....\$20.95 PART # 40888-25



WHEEL TIE-DOWNS



- Hold wheels tightly against chocks
- 1" x 36" black polypropylene
- Nickel-plated spring-loaded side buckles
- Sold in pairs

SUG. RETAIL.....\$9.95 PART # 41075-10



SOFT-TIE NYLON TIE-DOWN STRAPS

- 18" L looped nylon tie-down straps
- 3,500 lb. assembled strength
- Sold in pairs

SUG. RETAIL.....\$5.95

PART # 3920-0057



TIE-DOWN ANCHOR

- Designed to fit trucks with or without stake pocket holes
- Can be used with bedliners
- Easy to install
- Sold in pairs

SUG. RETAIL.....\$14.95 PART # 3920-0064



QUAD PACK

- Four 66" x 1" tie-downs with 1,200-lb. straight tension strength
- Two ratcheting buckles, two cam-lock buckles
- Six vinyl-coated and two cad-plated S-hooks



SUG. RETAIL.....\$56.95

COLOR	PART #
Red	45211-10
Black	45211-11



LITES AND BRITES

- Five hot colors
- 1" x 66" nylon straps with 1,000-lb. straight tension strength
- Popular Ankra cam-lock buckles
- One vinyl-coated, one zinc-plated S-hook per strap
- Available in Brite fluorescent and standard Lite colors
- Sold in pairs



SUG. RETAIL.....\$23.95

BRITE FLUORESCENT	PART #
Orange	47295-14
Lime green	47295-16

LITE COLORS	PART #
Black	47295-10
Red	47295-11
Blue	47295-12



TIE-DOWN EXTENSIONS

- 18" looped nylon straps
- Use for extension or additional protection of handlebars, seat rails, etc.
- 3,000-lb. assembly strength
- Sold in pairs; black only



SUG. RETAIL.....\$6.95

PART # 45214-10



15' TIE-DOWN

- Red 1" nylon web strap rated for 1,200-lb. straight-pull strength
- The longest tie-down we sell
- Cam-lock buckle
- Two vinyl-coated hooks
- Packaged and sold each



SUG. RETAIL.....\$17.95

PART # 13-1020



QUALITY TIE-DOWNS

- 1" W x 66" L top-quality nylon web straps
- Rated at over 1,200-lb. straight-pull strength
- Cam-lock buckles
- Vinyl-coated hooks on both ends
- Packaged and sold in pairs



COLOR	PART #	SUG. RETAIL
Red	13-1001	\$18.95
Black	13-1002	18.95

COLOR	PART #	SUG. RETAIL
Blue	13-1003	\$18.95
Fluorescent green	13-1010	19.95
Neon orange	13-1012	19.95

All part numbers in **BOLD MAGENTA** are new this year.



RATSHET CAT TIE-DOWNS

- Same features as the Power Cat, but with a ratchet buckle
- 1 1/8" nylon webbing with 1,200-lb. tensile strength
- Soft-end loops protect handlebars from scratches or scrapes
- S-hooks at both ends feature innovative dual-locking clips that prevent the S-hook from falling off after clipped
- Adjusts in length from 24" to 78"
- Sold in pairs

SUG. RETAIL..... **\$39.95**

DESCRIPTION	PART #
Black/white checks	3920-0094
Black/red checks	3920-0095
Black/blue checks	3920-0096
Black/green checks	3920-0097

DESCRIPTION	PART #
Black w/ orange stripe	3920-0098
Flame	3920-0099
Black	3920-0100

DESCRIPTION	PART #
Red	3920-0102
Pink floral	3920-0126
Pink camo	3920-0127

DESCRIPTION	PART #
Sprockets	3920-0160
Chain	3920-0161
Skulls	3920-0162



1 1/8" POWER CAT TIE-DOWNS

- 1,200-lb. tensile strength nylon webbing
- Soft-end loops protect handlebars from scratches or scuffs
- S-hooks at both ends feature innovative safety-lock clips that prevent the S-hook from falling off after clipped
- Zinc metal cam buckle provides an anti-slip connection
- Adjusts in length from 24" to 78"
- Sold in pairs

SUG. RETAIL..... **\$29.95**

DESCRIPTION	PART #
Black/white checks	3920-0086
Black/red checks	3920-0087
Black/blue checks	3920-0088
Black/green checks	3920-0089

DESCRIPTION	PART #
Black w/ orange stripe	3920-0090
Flame	3920-0091
Black	3920-0092

DESCRIPTION	PART #
Red	3920-0093
Pink floral	3920-0124
Pink camo	3920-0125

DESCRIPTION	PART #
Sprockets	3920-0157
Chain	3920-0158
Skulls	3920-0159

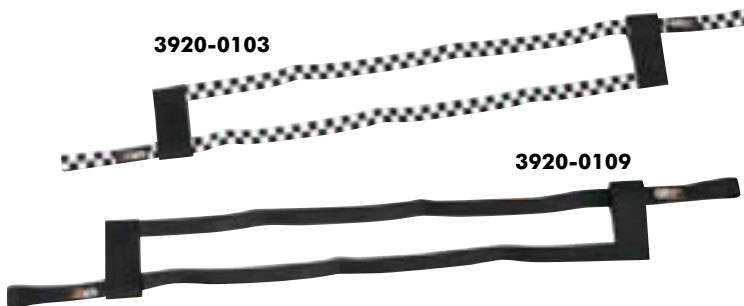

RACE-READY TIE-DOWN STRAPS

- Extension strap is designed to protect sportbike fairings when tied down
- Constructed from durable 1 1/8" nylon webbing

SUG. RETAIL..... **\$16.95**

DESCRIPTION	PART #
Black/white checks	3920-0103
Black	3920-0109



CAT'S TAIL SLEEVES

- Soft berber fleece sleeve protects chrome or painted finishes
- Designed for use with soft-end tie-down straps
- Available in black only
- Sold in pairs

SUG. RETAIL..... **\$10.95**

BAD BUNGEE TIE-DOWN STRAP

- 1" adjustable bungee tie-down firmly secures accessories and riding equipment
- Easy to use
- Adjusts in length from 18" to 42"
- Available in black only
- Sold in pairs

SUG. RETAIL..... **\$13.95**

All part numbers in **BOLD MAGENTA** are new this year.

- EXHAUST
- TIRES & ACCESSORIES
- LUGGAGE
- SPORTBIKE ACCESSORIES
- CRUISER ACCESSORIES
- TOURING ACCESSORIES
- SECURITY & AUDIO
- GENERAL ACCESSORIES
- FAIRINGS & BODY
- SEATS
- HANDLEBARS & CONTROLS
- LIGHTING
- ELECTRICAL
- SPROCKETS
- CHAINS
- BRAKES
- SUSPENSION
- ENGINE
- FUEL SYSTEMS
- LUBES
- TOOLS
- TRAILER
- MERCH.
- CROSS REFERENCE
- INDEX

- EXHAUST
- TIRES & ACCESSORIES
- LUGGAGE
- SPORTBIKE ACCESSORIES
- CRUISER ACCESSORIES
- TOURING ACCESSORIES
- SECURITY & AUDIO
- GENERAL ACCESSORIES
- FAIRINGS & BODY
- SEATS
- HANDLEBARS & CONTROLS
- LIGHTING
- ELECTRICAL
- SPROCKETS
- CHAINS
- BRAKES
- SUSPENSION
- ENGINE
- FUEL SYSTEMS
- LUBES
- TOOLS
- TRAILER
- MERCH.
- CROSS REFERENCE
- INDEX



FOLDING ALUMINUM MOTORCYCLE RAMP



- Folds to carry like a briefcase
- 1,000-lb. capacity
- Never rusts; 100% aluminum
- Measures 96" L x 12 1/2" W (extended); 52 1/2" L x 12 1/2" W x 4" D (collapsed)

SUG. RETAIL.....\$209.95 PART # MC1296



STEEL LOADING RAMPS



- Heavy-duty steel construction
- Motorcycle ramp measures 72" L x 6" W
- Heavy cycle/ATV ramp measures 72" L x 10" W and weighs 32 lb.; use two for easy ATV loading
- Both have a 950-lb. capacity

DESCRIPTION	PART #	SUG. RETAIL
Motorcycle ramp	8000-7100	\$89.95
Heavy cycle/ATV ramp	8000-7105	119.95



EZ CHOCK



- Does not require any mounting hardware
- Non-slip rubber pad on the bottom plate ensures the chock stays put
- Plate and tab strap design secures your bike in place
- Sold each

DESCRIPTION	PART #	SUG. RETAIL
3.5" W	3911-0035	\$89.95
5.5" W	3911-0036	99.95
6.5" W	3911-0037	99.95

EZ CHOCK DADDY MACK



- Top strap features cam buckle operation, lower strap is ratchet operation – pull top strap tight, then ratchet lower strap to fully secure the bike
- 1.5" wide 5,000 lb. test nylon webbing
- Double security stitching
- 1.5" premium ratchet with 1,800 lb. test buckle
- Straps measure 6' total length
- Soft strap with neoprene soft sleeve included
- Vinyl-coated S-hooks
- Sold in pairs



SUG. RETAIL.....\$49.95
PART # 3920-0177



CYCLE JAWS®



- Easy one-person operation
- Stabilizes the front wheel of a motorcycle for trailer transportation
- Maximum tire contact for maximum security; adjusts to the exact size of the tire
- Effortless motorcycle removal, with no bulky hardware to roll over
- No pinch points to wear and deform the tire's sidewalls
- Smooth, easy clamping motion on tire sizes from 3" to 6 1/2" W
- Can quickly and easily be removed from the truck or trailer; tie-downs recommended
- Adjustable tire locator prevents damage to valuable rotors and rims
- Heavy-duty thick-wall yellow zinc-plated steel construction so Cycle Jaws will withstand the test of time
- Can be used free-standing for use on garage floors, driveways and racetrack pits
- Made in the U.S.A.

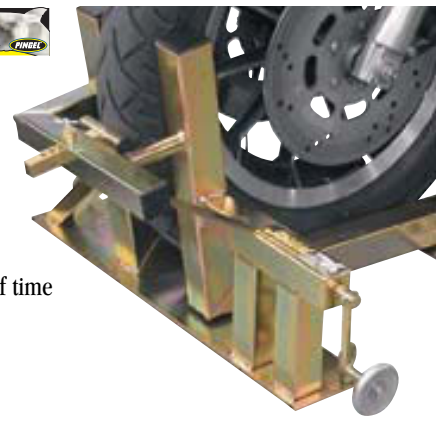

WARNING: Do not ride motorcycle on ramp at any time.
SUG. RETAIL.....\$289.95 PART # 4101-0059



DS390095

REMOVABLE WHEEL CHOCKS

- Stabilize the front wheel of a motorcycle for trailer transportation
- Wheel chocks can easily be removed when not in use
- Chocks are made of thick-wall steel tube construction and feature a chrome finish
- 6 1/2" wheel chock has clearance for motorcycles with large rotors and is designed with a three-bend radius that will keep any width tire centered in the chocks
- Mounting brackets remain fastened while the chocks are easily removed by unscrewing the T-bolt hold-down screw
- Additional mounting kits may be purchased separately, enabling you to move the chock from one surface to another without removing the mounting brackets
- Wheel chock mounting brackets are patented
- If it doesn't say "Pingel®," it isn't the real thing
- Made in the U.S.A.

DESCRIPTION	PART #	SUG. RETAIL
3 1/2" - fits tire widths up to 3 1/2" (w/ mounting kit)	DS390095	\$68.95
6 1/2" - fits tire widths up to 6 1/2" (w/ mounting kit)	3911-0001	68.95
Mounting kit only w/ T-bolt and threaded insert (ea.)	3911-0033	27.95
Repl. T-bolt w/ threaded insert (ea.)	DS-380149	6.95



3911-0002

PERMANENT WHEEL CHOCKS

- Stabilize the front wheel of a motorcycle for trailer transportation
- Chrome wheel chocks are designed to be fastened down and stay in one place
- Available in two sizes to fit a large variety of motorcycles
- 6 1/2" chock has clearance for motorcycles with large rotors and is designed with a three-bend radius that will keep any width tire centered in the chock
- Made in the U.S.A.

SUG. RETAIL..... **\$44.95**

DESCRIPTION	PART #
3 1/2" - fits tire widths up to 3 1/2"	DS-380173
6 1/2" - fits tire widths up to 6 1/2"	3911-0002



3911-0008

3920-0132

REMOVABLE WHEEL CHOCKS AND TIE-DOWN FITTING FOR SERIES E TRACK

- Stabilize the front wheel of a motorcycle for trailer transportation
- Fit securely into recessed or floor-mounted Series E Tracks
- Wheel chocks are made of thick-wall steel tube construction and feature a chrome finish
- Design lets you move your wheel chock, tie-downs and bike virtually anywhere along the Series E Track for the best position to accommodate multiple bikes, trikes or choppers, giving optimum space utilization
- 6 1/2" wheel chock has clearance for motorcycles with large rotors and is designed with a three-bend radius that will keep any width tire centered in the chock
- Tie-down fitting (sold each) installs into Series E track in seconds; moves along the track for perfect tie-down angle
- Patented mounting bracket
- If it doesn't say "Pingel®," it isn't the real thing
- Made in the U.S.A.

DESCRIPTION	FLOOR-MOUNT	SUG. RETAIL
WHEEL CHOCKS		
Floor mount, 3 1/2" W for tire widths up to 3 1/2"	3911-0006	\$158.95
Recessed, 3 1/2" W for tire widths up to 3 1/2"	3911-0007	158.95
Floor mount, 6 1/2" W for tire widths up to 6 1/2" or 150mm	3911-0008	158.95
Recessed, 6 1/2" W for tire widths up to 6 1/2" or 150mm	3911-0009	158.95
TIE-DOWN FITTING		
W/ 1" ring (sold each)	3920-0132	15.95

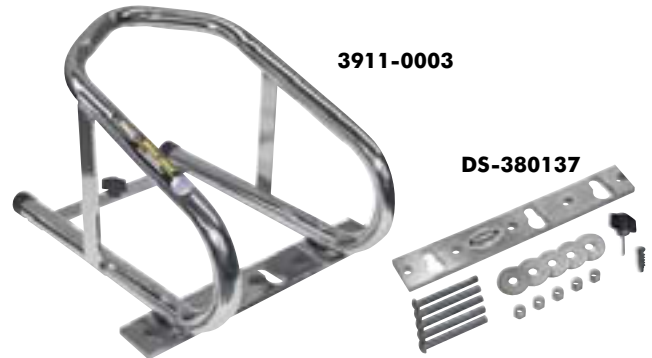

3911-0003

DS-380137

REMOVABLE WHEEL CHOCKS FOR CORRUGATED OR TRAILER FLOORS

- Stabilize the front wheel of a motorcycle for truck, van or trailer transportation
- Removable chock is made of thick-wall steel tube construction and has a chrome finish
- Unique mounting bracket is designed to use either the 3 1/2" or 6 1/2" Pingel® removable wheel chock
- 6 1/2" wheel chock has clearance for motorcycles with large rotors and is designed with a three-bend radius that will keep any width tire centered in the chock
- Only the mounting bracket fastens to the trailer, truck or van
- Easy removal of the chock when not in use
- If it doesn't say "Pingel®," it isn't the real thing
- Mounting brackets used with wheel chocks are patented
- Made in the U.S.A.

DESCRIPTION	PART #	SUG. RETAIL
3 1/2" - fits tire widths up to 3 1/2" (w/ mounting kit)	DS-380136	\$115.95
6 1/2" - fits tire widths up to 6 1/2" (w/ mounting kit)	3911-0003	115.95
Additional mounting plate kit for corrugated floors (ea.)	DS-380137	59.95

All part numbers in **BOLD MAGENTA** are new this year.

- EXHAUST
- TIRES & ACCESSORIES
- LUGGAGE
- SPORTBIKE ACCESSORIES
- CRUISER ACCESSORIES
- TOURING ACCESSORIES
- SECURITY & AUDIO
- GENERAL ACCESSORIES
- FAIRINGS & BODY
- SEATS
- HANDLEBARS & CONTROLS
- LIGHTING
- ELECTRICAL
- SPROCKETS
- CHAINS
- BRAKES
- SUSPENSION
- ENGINE
- FUEL SYSTEMS
- LUBES
- TOOLS
- TRAILER
- MERCH.
- CROSS REFERENCE
- INDEX



- EXHAUST
- TIRES & ACCESSORIES
- LUGGAGE
- SPORTBIKE ACCESSORIES
- CRUISER ACCESSORIES
- TOURING ACCESSORIES
- SECURITY & AUDIO
- GENERAL ACCESSORIES
- FAIRINGS & BODY
- SEATS
- HANDLEBARS & CONTROLS
- LIGHTING
- ELECTRICAL
- SPROCKETS
- CHAINS
- BRAKES
- SUSPENSION
- ENGINE
- FUEL SYSTEMS
- LUBES
- TOOLS
- TRAILER
- MERCH.
- CROSS REFERENCE
- INDEX

CHOPPER WHEEL CHOCKS

- Makes tying down a motorcycle simple and easy for one person
- Available in two cradle choices: one for the 120 wide tire and another for the 80-90 wide tire
- Patented locking mechanism effortlessly and securely supports motorcycle in an upright position
- Works on all low fender applications
- Can be used on pavement, concrete, dirt, sand, gravel and also trailers and pickup trucks
- Mounted on a trailer it easily snaps on and off when used with included trailer adapter kit; in a pickup truck, it may be used free standing
- Self locking and folds to become compact
- Weighs only 26 lb.
- Upright dimensions: 25" L x 9" W x 15" H; folded dimensions: 25" L x 9" W x 6" H

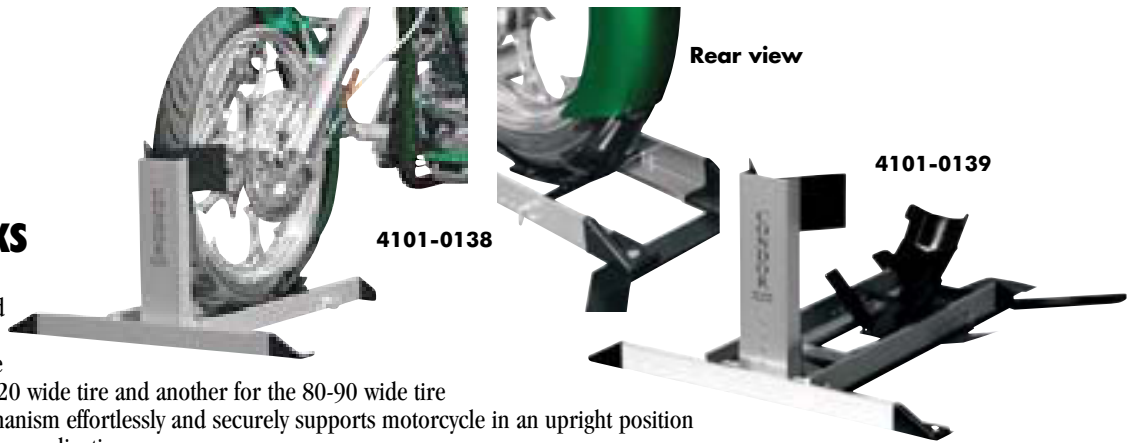

SUG. RETAIL..... **\$314.95**

DESCRIPTION	PART #
For 80-90 wide front tire	4101-0138
For 120 wide front tire	4101-0139



PIT STOP/TRAILER STOP WHEEL CHOCK

- Fully adjustable wheel locking system; holds bikes weighing up to 2,400 lb.
- Accommodates front or rear wheel sizes from 15"-22" and 80-220mm wide
- Patented locking mechanism effortlessly and securely supports motorcycle in an upright position on the ground or on a trailer
- Makes tying down the motorcycle for transport a simple task
- Works on pavement, gravel, concrete, dirt or even sand
- Use as a work stand or trailer chock
- Trailer adapter kit quickly and easily attaches to trailer or pickup beds
- Folds down for easy storage; weighs just 21 lb.
- Upright dimensions: 30" L x 29" W x 15" H; folded dimensions: 30" L x 29" W x 6" H

DESCRIPTION	PART #	SUG. RETAIL
Pit Stop/Trailer Stop	4101-0135	\$249.95
Trailer Stop adapter kit	4101-0136	21.95



TRAILER ONLY WHEEL CHOCK STAND

- Fully adjustable wheel locking system; accommodates front and rear wheel sizes from 15"-22"/80-220mm wide
- Patented locking mechanism effortlessly and securely supports motorcycle in an upright position on all transport platforms
- As a trailer chock it easily snaps on and off all transport platforms; attaching and detaching the unit takes only a few seconds
- Makes tying down a motorcycle a simple and an easy task for one person
- Accommodates bikes weighing up to 3,000 lb.; folds down for easy storage and weighs just over 26 lb.
- Dimensions upright are 25" L x 9" W x 15" H; dimensions folded are 25" L x 9" W x 7" H

SUG. RETAIL..... **\$184.95** PART # **4101-0137**

SCOOTER WHEEL CHOCK

- Fully adjustable wheel locking system
- Works with front and rear tires on mopeds and scooters; fits front tires only on most sport bikes
- Patented locking mechanism securely supports your ride in an upright position; works on all trailers, trucks and transport platforms
- Floor adapter kit (sold separately) allows you to use Scooter Wheel Chock in a garage, on pavement, dirt, sand or gravel; can also be used for transport in back of a minivan, SUV or truck bed without the use of mounting hardware
- Accommodates bikes weighing up to 800 lb., folds down for easy storage and weighs only 22 lb.
- Upright dimensions: 24" L x 8" W x 14" H; folded dimensions: 24" L x 8" W x 6" H

DESCRIPTION	PART #	SUG. RETAIL
Scooter wheel chock	4101-0140	\$154.95
Floor adapter kit	4101-0141	89.95





3911-0023

LOCK CHOCKS



- Chock includes a security pin that can be used to lock your bike to the chock (padlock not included)
- Flush-mount T-base fits all trailers and truck beds with no hassle of aligning separate cleats
- Chock mounts to base at four points for strength and stability
- Ultra-durable powder-coat finish
- Large models fit street/supermoto machines and provide clearance for all disc brakes
- All mounting hardware and instructions
- Made in the U.S.A.



3911-0024



3911-0025

DESCRIPTION	PART #	SUG. RETAIL
3.5"	3911-0023	\$74.95
5.5"	3911-0024	89.95
6.5"	3911-0025	89.95

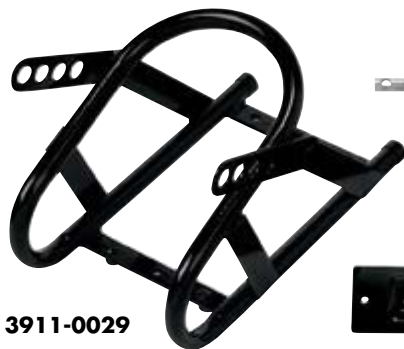

3911-0029



3911-0027



LOCK CHOCK SEPARATES



- Prepare your trailer with T-bases and use the right chock for the day's haul
- All chocks are interchangeable on the same T-base plate
- Made in the U.S.A.

DESCRIPTION	PART #	SUG. RETAIL
3.5" Chock and security pin	3911-0028	\$49.95
5.5" Chock and security pin	3911-0029	64.95

DESCRIPTION	PART #	SUG. RETAIL
6.5" Chock and security pin	3911-0030	\$64.95
T-base plate and mounting hardware	3911-0027	34.95



MOTORCYCLE WHEEL STABILIZERS

- Designed to hold the front wheel
- Mount to the bed of any truck, van or trailer
- 5" sport-style chocks feature a special bend to accommodate disc brakes; 3 1/2" minicycle chocks feature a shorter overall height for smaller cc bikes
- All chocks can be bolted in or made removable with quick mount/release kits (sold separately)
- Available with polyester plastic-coat or chrome finish
- Chocks and mount/release kits sold each

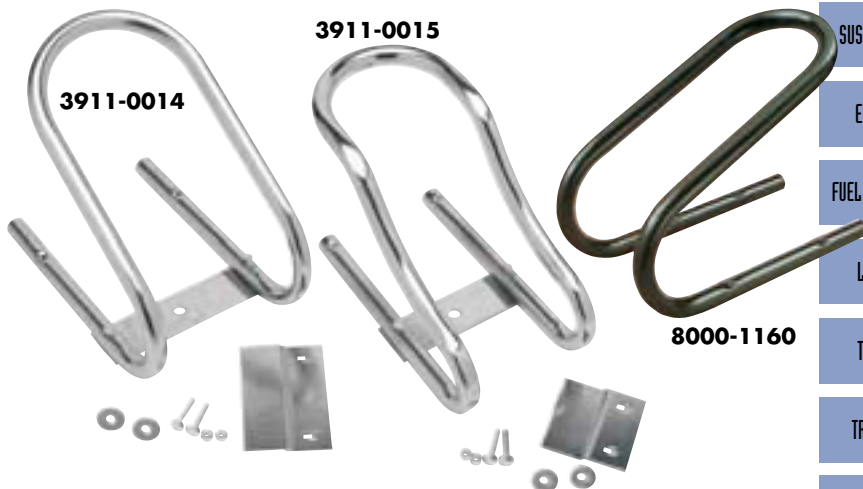

3911-0014

3911-0015

8000-1160

DESCRIPTION	BLACK PART #	SUG. RETAIL	CHROME PART #	SUG. RETAIL
WHEEL CHOCKS				
3 1/2" inside width	8000-1163	\$19.95	3911-0012	\$29.95
3 1/2" inside width, mini-cycle	8000-1165	19.95	3911-0013	29.95
5" inside width, sport style	3911-0010	19.95	3911-0015	29.95
5" inside width	8000-1160	19.95	3911-0011	29.95
6 1/2" inside width	-	-	3911-0014	29.95

DESCRIPTION	BLACK PART #	SUG. RETAIL	CHROME PART #	SUG. RETAIL
QUICK MOUNT/RELEASE KITS				
For 3 1/2" chocks	8000-1164	\$21.95	3911-0018	\$28.95
For 5" chocks	8000-1161	21.95	3911-0017	28.95
For 6 1/2" chocks	-	-	3911-0019	28.95

All part numbers in **BOLD MAGENTA** are new this year.

- EXHAUST
- TIRES & ACCESSORIES
- LUGGAGE
- SPORTBIKE ACCESSORIES
- CRUISER ACCESSORIES
- TOURING ACCESSORIES
- SECURITY & AUDIO
- GENERAL ACCESSORIES
- FAIRINGS & BODY
- SEATS
- HANDLEBARS & CONTROLS
- LIGHTING
- ELECTRICAL
- SPROCKETS
- CHAINS
- BRAKES
- SUSPENSION
- ENGINE
- FUEL SYSTEMS
- LUBES
- TOOLS
- TRAILER
- MERCH.
- CROSS REFERENCE
- INDEX

GENERAL ACCESSORIES

EXHAUST
TIRES & ACCESSORIES
LUGGAGE
SPORTBIKE ACCESSORIES
CRUISER ACCESSORIES
TOURING ACCESSORIES
SECURITY & AUDIO
GENERAL ACCESSORIES
FAIRINGS & BODY
SEATS
HANDLEBARS & CONTROLS
LIGHTING
ELECTRICAL
SPROCKETS
CHAINS
BRAKES
SUSPENSION
ENGINE
FUEL SYSTEMS
LUBES
TOOLS
TRAILER
MERCH.
CROSS REFERENCE
INDEX



BAR-HARNESS

- A hassle-free way to secure motorcycles; virtually eliminates the possibility of damage to bodywork
- Simple, quick and very easy to use; mounts on the grips and keeps tie-downs away from the body
- Nylon webbing has tensile strength of over 5,500 lb.
- Best solution when using tie-downs on sport bikes
- Can be used on wide variety of motorcycles



BAR-HARNESS

SUG. RETAIL..... **\$29.95**

COLOR	PART #
SHORT (FITS BARS UP TO 28" W)	
Red	3920-0058
Blue	3920-0059
Black	3920-0060
SPORT/STANDARD (FITS BARS UP TO 32" W)	
Red	37105

COLOR	PART #
SPORT/STANDARD (FITS BARS UP TO 32" W) (CONT)	
Blue	37205
Black	37505
WIDE (FITS BARS UP TO 34" W)	
Black	3920-0061

STRAP WRAPPERS

- Slip over tie-down hooks; prevent strap rash and buckle bruise
- Measure approximately 12" L x 1 1/2" W
- Sold in pairs



STRAP WRAPPERS (PR.)

SUG. RETAIL..... **\$3.95**

PART #	SUG. RETAIL
3920-0062	\$3.95



TRACK STAR™ WHEEL CHOCK

- Patented lock 'n load system uses high-strength aircraft-style track for attachment to bike hauler
- Reinforced, powder-coated tubular steel; solid base plate and aircraft fasteners provide superior strength
- Universal design works on both ribbed truck beds and flat floor trailers
- Fits wheel sizes from 3 1/2" W to 5 1/2" W
- Includes necessary hardware and instructions
- Accessory mounting kit allows chock to be used in more than one vehicle



DESCRIPTION	PART #	SUG. RETAIL
Track Star wheel chock	3911-0026	\$82.95

DESCRIPTION	PART #	SUG. RETAIL
Accessory mounting kit	3911-0034	\$15.95



CHROME CABLE TIES

- Electroplated finish is impregnated into the ties for less discoloration when bending

DESCRIPTION	PART #	SUG. RETAIL
4"		
100-pk.	DS-193027	\$54.95
10-pk.	DS-193048	8.95
7"		
100-pk.	DS-193026	61.95
10-pk.	DS-193047	10.95
11"		
100-pk.	DS-193025	99.95
10-pk.	DS-193046	13.95

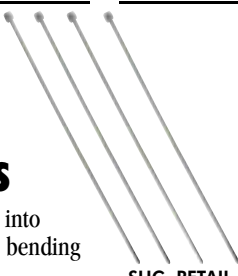

SHOCK CORDS

- Heavy-duty shock cords
- Nylon hooks resist cracking, even at -45°F
- Easy to adjust and has a flat profile cord
- Available in 16", 24" and 36"
- Hippo strap works well to tie down tarps and covers
- Sold each

DESCRIPTION	PART #	SUG. RETAIL
HIPPO		
16"	3920-0163	\$7.95
24"	3920-0164	8.95
36"	3920-0165	9.95



BAR-HARNESS II



- New and improved bar-harness has a glass-filled injection molded polycarbonate "cup" to replace the old handlebar "cuff"
- Eliminates possible damage to soft grips and holds the cross straps farther away from the switchgear
- Sized to fit the widest grips on the market
- Uses a heavier thread with more stitches to provide greater strength
- Available in four black sizes: short, standard, X-wide and XX-wide

SUG. RETAIL..... **\$29.95**

DESCRIPTION	PART #
Short (fits bars up to 28" W)	3920-0150
Standard (fits bars up to 32" W)	3920-0151
X-wide (fits bars up to 36" W)	3920-0152
XX-wide (fits bars up to 40" W)	3920-0153

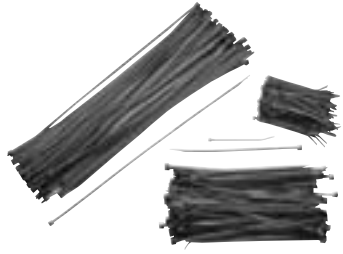

BULK CABLE TIES



- Top-quality black ties in bulk quantities
- Built strong with the highest tensile-strength nylon
- Bulk packs include 100 poly-bagged ties
- Five lengths

LENGTH	PART #	SUG. RETAIL
4"	LCT4	\$5.95
5 1/2"	LCT5	7.95
7 1/2"	LCT7	9.95
11"	LCT11	15.95
15"	LCT15	19.95



DESCRIPTION	PART #	SUG. RETAIL
SWIVEL		
16"	3920-0166	\$6.95
24"	3920-0167	7.95
36"	3920-0168	8.95



CARGO NETS

- Quality black cargo nets made of strong elastic cord
- Include unbreakable, noncorroding hooks

SUG. RETAIL..... \$7.95

DESCRIPTION	PART #	DESCRIPTION	PART #
15" x 15"	DS-110211	12" x 17"	DS-110212

DS-110211

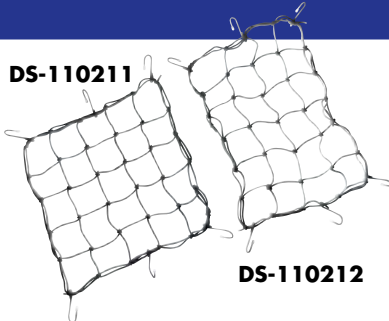

DS-110212



BUNGEE NETS

- Versatile nets hold down nearly anything
- Stretch to over double their 15" square size
- Six coated, nonabrasive hooks

COLOR	PART #	COLOR	PART #
Black	K31-6539	Purple	K316546
Blue	K31-6543	Red	K31-6541

SUG. RETAIL..... \$5.95

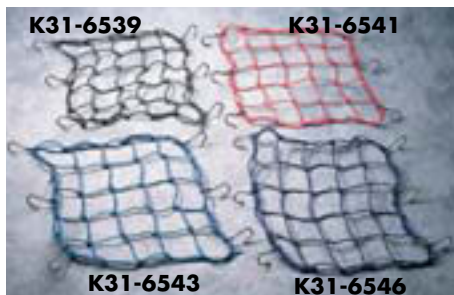

K31-6539

K31-6541

K31-6543

K31-6546



1012

1033B

4024B

BUNGEE CORDS

- Multicolored, unless PART # includes "B" suffix (black)

LENGTH	PART #	SUG. RETAIL	LENGTH	PART #	SUG. RETAIL
2-HOOK			3-HOOK		
12"	1012	\$1.95	24"	1033B	\$2.95
18"	1018B	2.95	4-HOOK		
24"	1024B	2.95	24"	4024B	4.95
30"	1030	2.95			
36"	1036	2.95			



THE HOOKER

- No more scratched paint or chrome from bungee hooks
- Black synthetic leather
- Slips easily under passenger seat giving added carrying capacity with four padded D-ring mounting points
- Fully adjustable; fits most bikes and simple to use with bungee cords or nets
- Measures 12" L x 7 1/2" H and can adjust to approximately 21 1/2" L

SUG. RETAIL..... \$27.95 PART # **HK622**

All part numbers in **BOLD MAGENTA** are new this year.



DOUBLE HOOK BUNGEE CORDS

- Double-folded heavy-duty coated hooks
- 9mm natural rubber with cloth cover
- 2-hook bungee cords are sold in a 10-pack and the 4-hook are sold each



3920-0067

3920-0065

LENGTH	PART #	SUG. RETAIL	LENGTH	PART #	SUG. RETAIL
TWO-HOOK			FOUR-HOOK		
12"	3920-0066	\$1.95 (ea.)	24"	3920-0065	\$2.95 (ea.)
18"	3920-0067	1.95 (ea.)			
24"	3920-0068	1.95 (ea.)			



BLACK ELASTIC STRAPS

- Strong, black 10mm elastic straps in varying lengths
- Quick, easy way to attach and carry extra items
- Completely plastic-coated heavy-gauge hooks
- Available in two- and four-hook designs

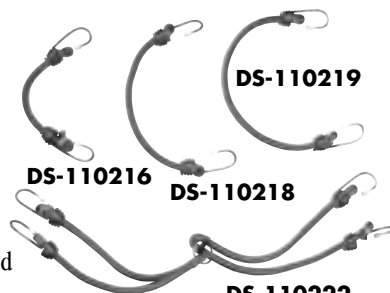

DS-110216

DS-110219

DS-110218

DS-110222

DESCRIPTION	PART #	SUG. RETAIL	DESCRIPTION	PART #	SUG. RETAIL
Two hooks, 12"	DS-110216	\$1.95	Two hooks, 20"	DS-110219	\$2.95
Two hooks, 16"	DS-110218	1.95	Four hooks, 24"	DS-110222	2.95



BUNGEE NUTS

- Made of chrome-plated, high-carbon steel
- Replace top shock nut to work as an excellent bungee cord tie-down knob
- Available in three sizes to fit all popular motorcycles
- Sold in pairs



SUG. RETAIL..... \$9.95

SIZE	PART #	SIZE	PART #
8 x 1.25mm	BN-2C	10 x 1.25mm	BN-4C
3/8" x 24 SAE	BN-3C		



NET-NUTS

- Ideal for attaching bungee cords and nets
- Available in six popular sizes
- Sold in pairs

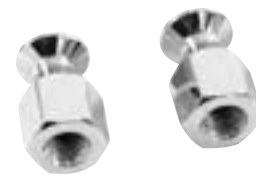

SUG. RETAIL..... \$4.95

SIZE	PART #	SIZE	PART #
8mm x 1.25mm	85-83404	5/16" x 18 SAE	85-83407
10mm x 1.25mm	85-83405	3/8" x 16 SAE	85-83409
10mm x 1.50mm	85-83406	3/8" x 24 SAE	85-83408



CHROME PLASTIC FASTENERS

- Each kit contains two round-headed bolts with nuts
- Bolts are 1/4" dia. by 1/2" L
- Can be used on a variety of applications

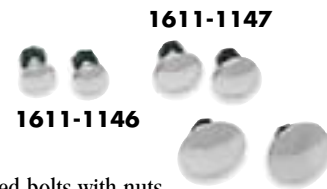

1611-1147

1611-1146

1611-1148

SUG. RETAIL..... \$7.95

DESCRIPTION	PART #
15mm/.590" head fastener	1611-1146
21mm/.827" head fastener	1611-1147
30mm/1.18" head fastener	1611-1148

- EXHAUST
- TIRES & ACCESSORIES
- LUGGAGE
- SPORTBIKE ACCESSORIES
- CRUISER ACCESSORIES
- TOURING ACCESSORIES
- SECURITY & AUDIO
- GENERAL ACCESSORIES
- FAIRINGS & BODY
- SEATS
- HANDLEBARS & CONTROLS
- LIGHTING
- ELECTRICAL
- SPROCKETS
- CHAINS
- BRAKES
- SUSPENSION
- ENGINE
- FUEL SYSTEMS
- LUBES
- TOOLS
- TRAILER
- MERCH.
- CROSS REFERENCE
- INDEX



- EXHAUST
- TIRES & ACCESSORIES
- LUGGAGE
- SPORTBIKE ACCESSORIES
- CRUISER ACCESSORIES
- TOURING ACCESSORIES
- SECURITY & AUDIO
- GENERAL ACCESSORIES
- FAIRINGS & BODY
- SEATS
- HANDLEBARS & CONTROLS
- LIGHTING
- ELECTRICAL
- SPROCKETS
- CHAINS
- BRAKES
- SUSPENSION
- ENGINE
- FUEL SYSTEMS
- LUBES
- TOOLS
- TRAILER
- MERCH.
- CROSS REFERENCE
- INDEX



FOOTPEGS

- Dress up your bike or add the finishing custom touch
- Sold in pairs

DESCRIPTION	PART #	SUG. RETAIL
1" - 1 1/4" U-clamp mount	MC220	\$62.95
1" aluminum mount, index adjustable	MC320	65.95



FOOTPEGS WITH 1 1/4" CLAMPS

- Cast-aluminum clamps fit 1 1/4" diameter tubing
- Fit on most engine guards/crash bars and eliminate the need to purchase separate highway pegs
- Polished finish
- Sold in pairs

DESCRIPTION	PART #	SUG. RETAIL
W/ O-ring pegs	1620-0217	\$50.95
W/ Alligator pegs	1620-0218	63.95



ALUMINUM DESIGNER FOOTPEGS WITH ANGLE-ADJUST ALUMINUM CLAMPS FOR 1" BARS

- Triple chrome footpegs feature brand names in brass inlays
- Feature angle-adjustable clamps for added comfort
- Sold in pairs

DESCRIPTION	PART #	SUG. RETAIL
Kawasaki	MC-313	\$40.95
Suzuki	MC-314	45.95
Yamaha	MC-315	45.95



DESIGNER FOOTPEGS FOR 1" - 1 1/4" TUBES

- Triple chromed folding aluminum footpegs
- Brand names in bold black letters on polished brass inlay
- Come with all needed clamps
- Sold in pairs

DESCRIPTION	PART #	SUG. RETAIL.....	DESCRIPTION	PART #	SUG. RETAIL.....
Kawasaki	MC-213	\$32.95	Yamaha	MC-215	\$32.95
Suzuki	MC-214				

O-RING FOOTPEGS WITH ALUMINUM CLAMP



- Triple chrome-plated O-ring footpegs with strong, computer-designed aluminum clamp
- Adjustable mounting angle
- Fit 1" tube
- Sold in pairs

SUG. RETAIL.....**\$51.95**

PART #	MC-209
--------	--------

O-RING FOOTPEGS

- Lightweight steel construction
- Folding pegs fit 1" - 1 1/4" tube
- All clamps included
- Sold in pairs



SUG. RETAIL.....**\$41.95**

PART #	MC-210
--------	--------



CHROME FOOTPEGS WITH RUBBER SLEEVES

- Die-cast construction, rubber sleeves and highly polished chrome ends
- Feature molded rubber sleeves instead of O-ring grooves; small female mounts
- Sold in pairs

SUG. RETAIL.....**\$23.95**

PART #	DS-253405
--------	-----------

All part numbers in **BOLD MAGENTA** are new this year.



DS-253546

DS-253547

DS-253543

CHROME ADJUSTABLE DESIGNER FOOTPEGS

- Footpegs feature 180° internal splines allowing pegs to be mounted at many different angles
- Durable rubber pad inserts in several designs
- Footpeg mounts have four engagement locking teeth to hold pegs in place
- Footpegs and mounts are sold separately (in pairs)

NOTE: Use of a thread locking product is recommended on all mounting bolts.

DESCRIPTION	PART #	SUG. RETAIL
DESIGNER FOOTPEGS		
Rail	DS-253546	\$53.95
Flamed	DS-253547	53.95
FOOTPEG MOUNTS		
Small female mounts	DS-253543	27.95



FRAME MOUNT/ TWISTED FOLD-UP HI-WAY BARS

- Solid steel twisted hi-way bars feature M/C's "Holy" folding footpegs
- Triple chrome-plated and polished
- Hardware included



SUG. RETAIL.....\$127.95

DESCRIPTION	WIDTH WITH PEGS	PART #
For single down tube and narrow double down tube models	24 1/2"	MC-371
For all wide double down tube models	28"	MC-372



ALUMINUM "HOLY" FOLD-UP PEGS

- Unique cast-alloy folding footpeg
- High-quality chrome plating
- Complete with clamps and hardware
- Packaged in pairs

SUG. RETAIL.....\$30.95



MC-373



MC-375

DESCRIPTION	PART #
7/8"-1" clamp mount	MC-373
1 1/4" clamp mount	MC-375



FOOTPAD SET



- High-quality clamp-mount footpads
- Can be used on any 7/8" - 1" bar
- Complete with all hardware on a display card

SUG. RETAIL.....\$18.95

PART #	MC-568
--------	--------



SHIFTER TOE GUARD

- Put an end to worn-through and scuffed boot tops with this unique idea
- Soft, neoprene foam cover wraps around shift lever and secures with a hook-and-loop closure for a snug fit
- Acts as a pad to reduce wear to your boots and protects shift lever from scratches and scrapes
- Ideal for commuters; one size fits all

SUG. RETAIL.....\$14.95

PART #	T1001
--------	-------



MULTI-FIT HI-WAY BARS



- Feature custom-designed brackets that bolt onto the down tubes and space the bar in front of the radiator
- Fit pre-85 Honda 500/700/750/1100 Shadow; VF500/700/750/1100 Sabre/Magna; CB900F 81; 650/750 Nighthawk, K and Custom; Suzuki GV700/1200 Madura; Yamaha V-Max (all); XJ550/ 700/750 Maxim X and Maxim

DESCRIPTION	PART #	SUG. RETAIL
Holy	MC-358-A	\$189.95
O-ring	MC-2358	137.95
Alligator	1624-0159	151.95



CALIFORNIA HI-WAY BARS

- Triple-chrome brackets fit existing motor mounts
- M/C's "Holy" footpegs are an exact fit
- All hardware included; except motor mount bolts
- Packaged on a display card

SUG. RETAIL.....\$75.95



DESCRIPTION	PART #
For most twins	MC-380
For multi-cylinder engines	MC-381



CHROME CHAIN GUARD



- Chrome-plated chain guard is complete with bolt-on brackets
- Fits more than 50 different bikes and models

SUG. RETAIL.....\$100.95

PART #	MC-925
--------	--------



SHIFTERSKIN

- Protects shoes and provides more comfortable shifting
- Fits most street bikes, ATVs and minibikes

COLOR	PART #	SUG. RETAIL.....	PART #
(A) Black	1602-0240	\$9.95	(B) Gray
			1602-0241

All part numbers in **BOLD MAGENTA** are new this year.

- EXHAUST
- TIRES & ACCESSORIES
- LUGGAGE
- SPORTBIKE ACCESSORIES
- CRUISER ACCESSORIES
- TOURING ACCESSORIES
- SECURITY & AUDIO
- GENERAL ACCESSORIES
- FAIRINGS & BODY
- SEATS
- HANDLEBARS & CONTROLS
- LIGHTING
- ELECTRICAL
- SPROCKETS
- CHAINS
- BRAKES
- SUSPENSION
- ENGINE
- FUEL SYSTEMS
- LUBES
- TOOLS
- TRAILER
- MERCH.
- CROSS REFERENCE
- INDEX