

Personal Video Recorder

High Definition Personal Video Recorder

User Guide

The infinite power of cable

ILLICO DIGITAL TV



© QUEBECOR MEDIA

IMPORTANT RULES FOR SAFE OPERATION	4
AVAILABLE ILLICO TERMINALS	5
REMOTE CONTROLS	10
CONNECTIONS	18
CONNECTION NO. 1: PVR TERMINAL + STÉRÉO TV	18
CONNECTION NO. 2: PVR TERMINAL + STÉRÉO TV + VCR OR DVD RECORDER	20
CONNECTION NO. 3: HD PVR TERMINAL + HD TV	23
CONNECTION NO. 4: HD PVR + HD TV + VCR OR DVD RECORDER	25
ILLICO ON DEMAND	28
ORDERING A MOVIE	28
TO RESUME WATCHING	28
ACTIVATING PARENTAL CONTROL	28
INTERACTIVE PROGRAM GUIDE	29
PARENTAL CONTROL	31
TO BLOCK VIEWING TIMES	31
TO BLOCK CHANNELS	32
TO BLOCK TYPES OF PROGRAMS	32
ACTIVATING PARENTAL CONTROL	32
ADJUSTING THE VOLUME	32
AUDIO SIGNAL EMITTED BY YOUR TERMINAL	32
PROGRAMMING YOUR REMOTE CONTROL	32
SETTING ILLICO LEVELS FOR BETTER SOUND QUALITY	32
PAY-PER-VIEW	33
PARENTAL CONTROL	33
HOW TO CONTROL A LIVE PROGRAM YOU ARE WATCHING	34
PERSONAL VIDEO RECORDER	35
HOW TO RECORD AND STORE A PROGRAM	36
SAVE TIME	39
HOW TO DELETE A RECORDED PROGRAM OR A SCHEDULED RECORDING	40
PICTURE-IN-PICTURE (PIP) – HOW TO WATCH TWO PROGRAMS AT ONCE	40
STORAGE CAPABILITIES	41
SETTINGS	42
FREQUENTLY ASKED QUESTIONS	43
TERMINAL	44
FUNCTIONS	44
PERIPHERALS	44
REMOTE CONTROL	44
SOUND AND IMAGE	44
SURVEILLANCE CAMERAS	44
FRONT PANEL DISPLAY	45
PAY-PER-VIEW AND PIN	45
LIST OF CODES	46
CUSTOMER SERVICE	50
HIGH-DEFINITION SETUP	51
INTRODUCTION	52
SETUP	52
CONNECTORS	52
CONVERTING IMAGE FORMATS	52
SETUP WIZARD	53
INTRODUCING THE SETUP WIZARD	53
PICTURE FORMATS	53
SETTING UP YOUR HD TERMINAL WITH THE SETUP WIZARD	57
CHANGE THE SETTINGS WHILE WATCHING TV	64
CLOSED-CAPTIONING	66
FREQUENTLY ASKED QUESTIONS	70

IMPORTANT RULES FOR SAFE OPERATION

Carefully read through these rules for safe operation before hooking up the terminal.

PLACEMENT AND VENTILATION

The unit has openings for ventilation that protect it from overheating.

- Avoid obstructing these openings, and do not place other equipment, including televisions, lamps, books or any other object, on the unit. Do not place it in an enclosure such as a bookcase or equipment rack, unless the installation provides proper ventilation.
- Do not place the unit on a bed, sofa, rug or similar surface, or over a radiator or heat register.
- Place the unit on a stable surface able to support its size and weight.

ACCESSORIES AND CLEANING

Do not use accessories with this equipment unless recommended by your cable service provider. Do not open the cover of the unit. Unplug the unit and clean it with a damp cloth. Do not use a liquid or aerosol cleaner, or a magnetic/static cleaning device.

OBJECT AND LIQUID ENTRY

Do not expose the unit to moisture, or spill liquids on or near it. Do not place the unit on a wet surface. Never push objects of any kind into the unit's openings, as they may touch dangerous voltage points or cause short-circuits that could result in a fire or electric shock.

POWER SOURCES

A label on the unit indicates the correct power source for this equipment. Operate the unit only from an electrical outlet that has the voltage and frequency indicated on the label. Do not overload electrical outlets or extension cords, as this can result in a risk of fire or electric shock.

POWER CORD PROTECTION

Arrange all power cords so that people cannot walk on the cords or place objects on or against the cords, as this may damage them. Pay particular attention to cords that are at plugs, at electrical outlets, connected to accessories, and at the places where the cords exit the unit.

GROUNDING

The terminal has a two-prong plug. Properly ground the unit by inserting the plug into a grounded electrical, two-socket outlet. If the plug is polarized, it has one wide prong and one narrow prong. This plug fits only one way.

Caution! To prevent electric shock, match wide blade of plug to wide slot, then fully insert. If you are unable to insert this plug fully into the outlet, contact an electrician to replace your obsolete outlet.

SERVICING

This unit is covered by a one-year warranty. Opening the case will void your warranty. Refer all servicing to a qualified Vidéotron technician. Contact your cable service provider for instructions. Service should be referred to a Vidéotron technician when any of the following occurs:

- There is damage to the power cord or plug.
- Liquid enters the unit, or there is exposure to rain or water.
- A heavy object falls on the unit, or you drop the unit or damage the cabinet.
- Operation is not normal (the instructions in this guide describe the proper operation).
- The unit exhibits a distinct change in performance.

Extended Warranty

For greater peace of mind, Vidéotron offers you the possibility of extending the warranty for an additional two years. Customers who want this extended warranty must apply for it within 30 days of the service activation date. The unit purchased will then be covered for a total of three years following the activation date (one year under the basic warranty + two years under the extended warranty) under the same terms and conditions as in the basic warranty.

AVAILABLE ILLICO TERMINALS

THE ILLICO TERMINALS OFFER THE SAME HIGH-PERFORMANCE CAPABILITIES, INCLUDING:

- Dolby Digital™ surround sound, CD-quality audio, and DVD-quality video;
- a complete Interactive Program Guide providing an overview of the next days of programming;
- the ability to block access to specific times, channels or TV programs using the Parental Control feature;
- access to interactive TV, with its range of advanced features and services;
- access to video-on-demand, where available.



AVAILABLE ILICO TERMINALS

EXPLORER® 8000

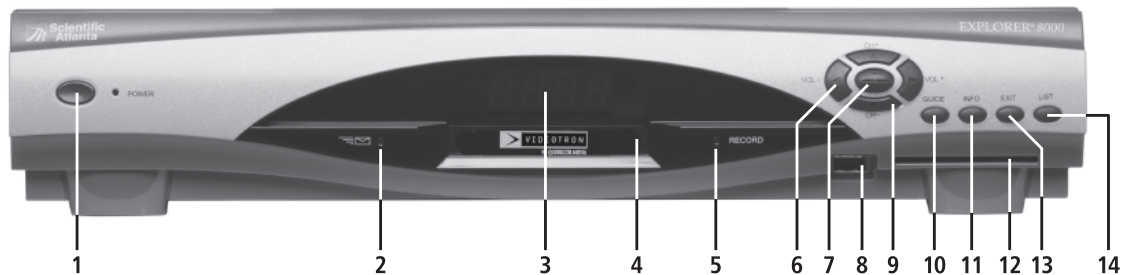

- | | |
|--|--|
| <ul style="list-style-type: none"> 1 Power 2 Message Indicator 3 LED display 4 IR Sensor 5 Recording Indicator 6 VOL+ and VOL- 7 SELECT 8 USB Port 9 CH+ and CH- 10 GUIDE 11 INFO 12 Smart Card Slot 13 EXIT 14 LIST | <ul style="list-style-type: none"> Provides power to the unit. The light to the right of the button illuminates when the power is on. Not yet operational. Displays the selected channel number and the time of the day. Receives the infrared signal from the remote. Indicates the PVR feature is active when illuminated. Increases and decreases volume. Accesses your on-screen selection. Connect to peripheral devices. There are no compatible devices yet. Scrolls up and down through the channels. Displays the on-screen Program Guide. Provides information on settings and programs. Will eventually allow for transactions. Not yet operational. Exits menus, the Program Guide, and program information. Displays the list of recorded programs. |
|--|--|



EXPLORER® 8000HD





- | | |
|--|--|
| <ul style="list-style-type: none"> 1 Power 2 Message Indicator 3 LED display 4 IR Sensor 5 Recording Indicator 6 VOL+ and VOL- 7 SELECT 8 USB Port 9 CH+ and CH- 10 GUIDE 11 INFO 12 Smart Card Slot 13 EXIT 14 LIST | <ul style="list-style-type: none"> Provides power to the unit. The light to the right of the button illuminates when the power is on. Not yet operational. Displays the selected channel number and the time of the day. Receives the infrared signal from the remote. Indicates the PVR feature is active when illuminated. Increases and decreases volume. Accesses your on-screen selection. Connect to peripheral devices. There are no compatible devices yet. Scrolls up and down through the channels. Displays the on-screen Program Guide. Provides information on settings and programs. Will eventually allow for transactions. Not yet operational. Exits menus, the Program Guide, and program information. Displays the list of recorded programs. |
|--|--|

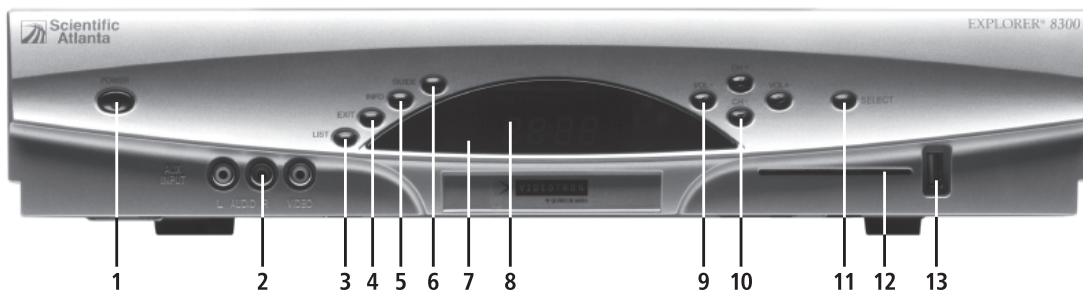

AVAILABLE ILICO TERMINALS

EXPLORER® 8300





- | | |
|---|---|
| <p>1 Power</p> <p>2 Audio/Video IN</p> <p>3 LIST</p> <p>4 EXIT</p> <p>5 INFO</p> <p>6 GUIDE</p> <p>7 IR Sensor</p> <p>8 LED Display</p> <p>9 VOL+ and VOL-</p> <p>10 CH+ and CH-</p> <p>11 SELECT</p> <p>12 Smart Card Slot</p> <p>13 USB Port</p> | <p>Provides power to the unit. The  symbol appears in the upper right portion of the display when power is on.</p> <p>Allows connection of an auxiliary A/V device. Not yet operational.</p> <p>Displays the list of recorded programs.</p> <p>Exits menus, the Program Guide, and program information.</p> <p>Provides information on settings and programs.</p> <p>Displays the on-screen Program Guide</p> <p>Receives the infrared signal from the remote.</p> <p>Displays the time, the current channel number and the following information: Message (✉) • HDTV • POWER (⏻) • Picture resolution (1080i, 720p, 480p, 480i) • RECORD • AUTO (Automatically selects the aspect ratio compatible with your TV.)</p> <p>Increases and decreases volume.</p> <p>Scrolls up and down through the channels.</p> <p>Accesses your on-screen selection.</p> <p>Will eventually allow for transactions. Not yet operational.</p> <p>Connects to peripheral devices. There are no compatible devices yet.</p> |
|---|---|

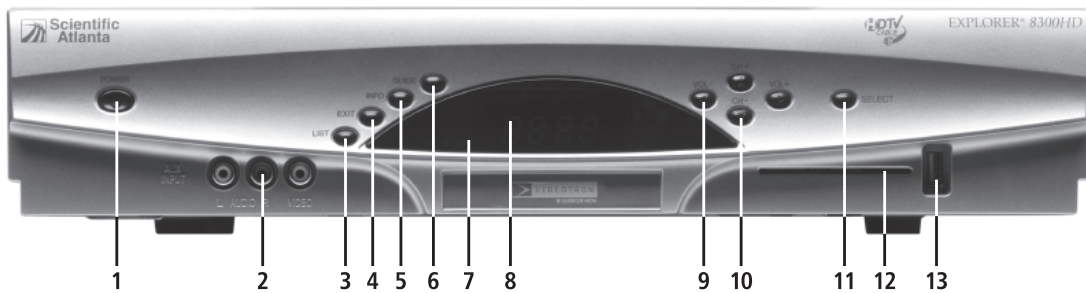

EXPLORER® 8300HD



- | | |
|---|---|
| <p>1 Power</p> <p>2 Audio/Video IN</p> <p>3 LIST</p> <p>4 EXIT</p> <p>5 INFO</p> <p>6 GUIDE</p> <p>7 IR Sensor</p> <p>8 LED Display</p> <p>9 VOL+ and VOL-</p> <p>10 CH+ and CH-</p> <p>11 SELECT</p> <p>12 Smart Card Slot</p> <p>13 USB Port</p> | <p>Provides power to the unit. The  symbol appears in the upper right portion of the display when power is on.</p> <p>Allows connection of an auxiliary A/V device. Not yet operational.</p> <p>Displays the list of recorded programs.</p> <p>Exits menus, the Program Guide, and program information.</p> <p>Provides information on settings and programs.</p> <p>Displays the on-screen Program Guide</p> <p>Receives the infrared signal from the remote.</p> <p>Displays the time, the current channel number and the following information: Message (✉) • HDTV • POWER () • Picture resolution (1080i, 720p, 480p, 480i) • RECORD • AUTO (Automatically selects the aspect ratio compatible with your TV.)</p> <p>Increases and decreases volume.</p> <p>Scrolls up and down through the channels.</p> <p>Accesses your on-screen selection.</p> <p>Will eventually allow for transactions. Not yet operational.</p> <p>Connects to peripheral devices. There are no compatible devices yet.</p> |
|---|---|



REMOTE CONTROLS

AT 8400

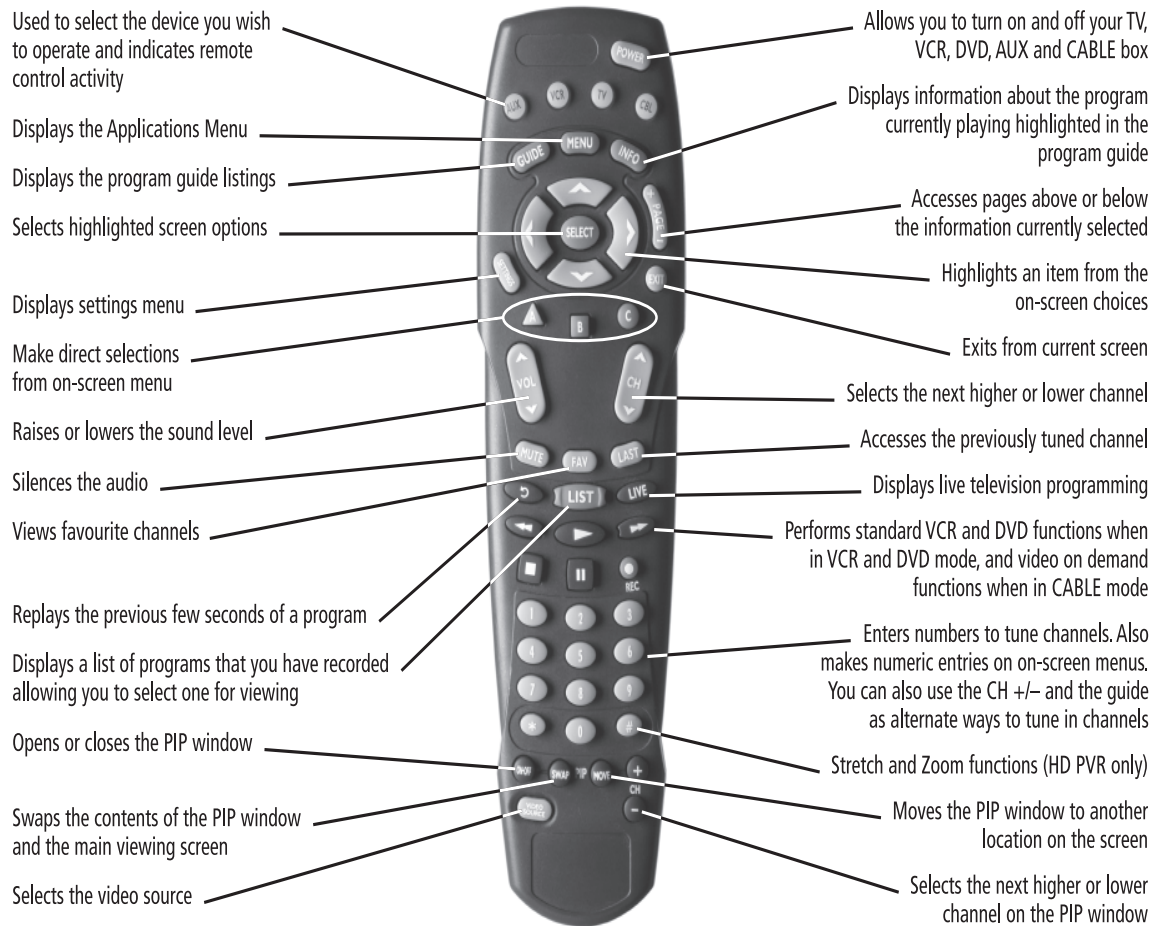

The remote control requires two alkaline AA batteries. A diagram inside the compartment of the remote control indicates proper battery placement. Replace as needed, when the indicator light becomes dim or no longer illuminates.

PROGRAMMING THE AT 8400 REMOTE CONTROL

The steps described below are the same for each mode button.
Repeat them for each device controlled by the remote, make sure you press the correct mode key for each device.

HOW TO PROGRAM THE TV MODE KEY

1. Turn on the TV set, then press and hold the **SELECT** and **TV** keys until the TV mode key blinks twice.
2. Using the remote control keypad, enter the setup code for your brand of device (the codes are listed in the appendix at the end of this guide); if the TV mode key blinks twice, you have entered the right code. If it does not blink twice, start again using a different code.
3. Once you have found the correct code, point the remote control towards the device and press **POWER**,  or **CH+**.
4. If the device works properly, write the code you used here: TV _____
5. Repeat these steps for other devices and write down the code for each.

VCR (magnétoscope) _____ AUX (CD et DVD) _____ CBL (ENP) _____

If none of the codes works, refer to How to Search for Codes, below.

HOW TO SEARCH FOR CODES

1. Turn the TV on, then press and hold the **SELECT** key and the appropriate mode key (AUX, VCR, TV or CBL) until it blinks twice.
2. Enter carefully the code **9 9 1**. After each digit the mode key will blink once. At the end of the operation it should blink twice.
3. Point the remote towards the device and press .
The remote automatically tests each code in its library, starting with the most common ones. The mode key blinks once each time the remote transmits a new code.

Each of the code libraries contains fewer than 100 codes.
The mode key blinks twice when it reaches the last code in the library.

4. As soon as the device powers down, press **SELECT** then the **POWER** key. If the device turns on, you have found the right code. Press **SELECT** to lock it.
5. You now need to find out which code you used.

REMOTE CONTROLS

HOW TO IDENTIFY PROGRAMMED CODES

1. Press and hold the **SELECT** key and the appropriate mode key (AUX, VCR, TV or CBL) until the mode key blinks twice.
2. Enter carefully the code **9 9 0**. After each digit the mode key will blink once. At the end of the operation it should blink twice.
3. Press **1**, then count the number of times the mode key blinks. That number indicates the first digit in the code. If the mode key does not blink, the digit is 0.
4. Press **2**, then count the number of blinks. That number indicates the second digit in the code.
5. Do the same for **3** and **4**, and the numbers of blinks. They indicate the third and fourth digits in the code.

HOW TO PROGRAM THE VOLUME CONTROL

This step is not essential, but it gives you better control of the volume on your devices.

1. Press the **SETTINGS** key twice to display the General Settings screen, and make sure that the Audio: Volume Control setting is set to Variable.
2. Turn on the device, then press and hold the **SELECT** and **CBL** keys until the CBL mode key blinks twice.
3. Enter carefully the code **9 9 3**. After each digit the CBL mode key will blink once. At the end of the operation it should blink twice.
4. On the PVR remote, press the mode key for the appropriate device volume you want to control.
5. Point the remote towards the device, and adjust the volume to confirm that the Volume and Mute keys function as expected.

REMOTE CONTROLS

UR5-8400A

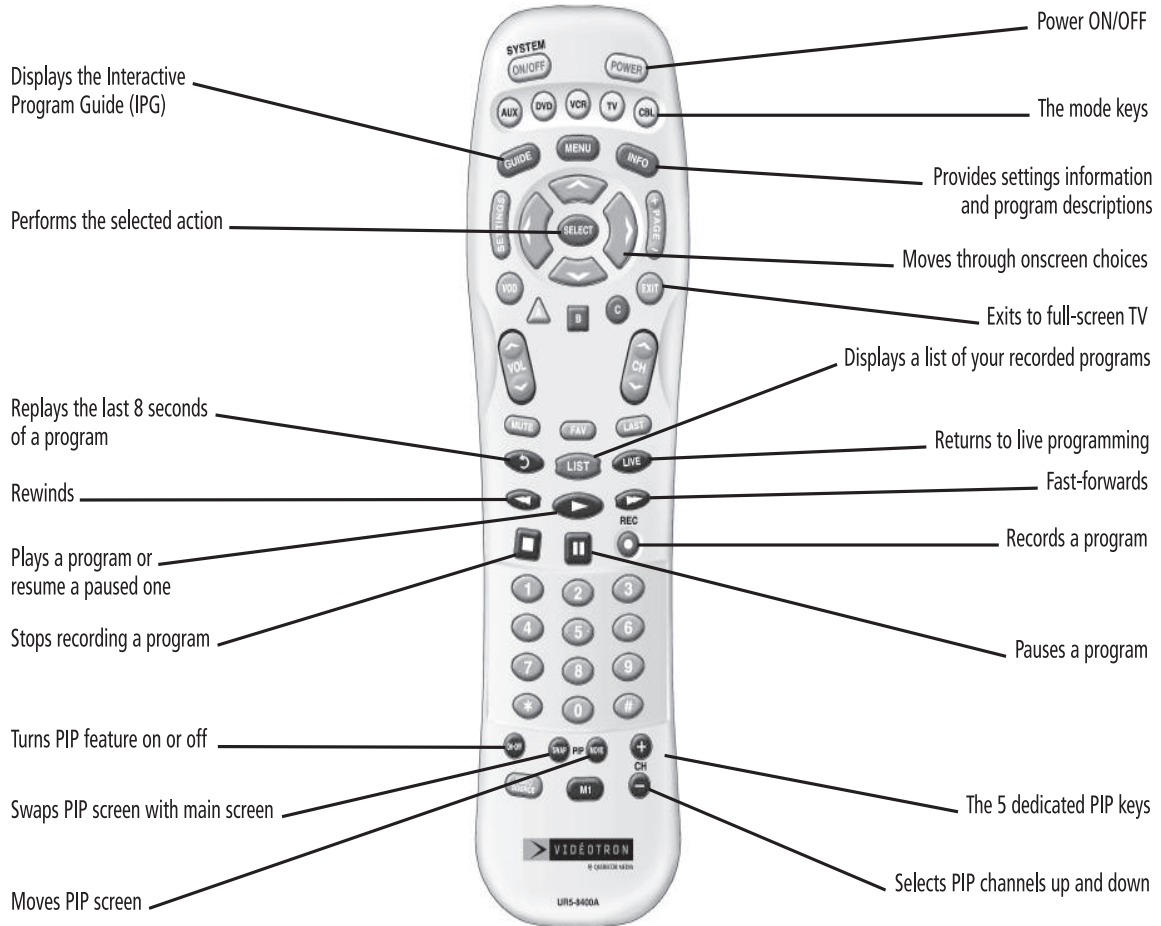

The remote control requires two alkaline AA batteries. A diagram inside the compartment of the remote control indicates proper battery placement. Replace as needed, when the indicator light becomes dim or no longer illuminates.

REMOTE CONTROLS

PROGRAMMING THE UR5-8400A REMOTE CONTROL

THREE-DIGIT CODE PROGRAMMING METHOD

The remote control can be programmed by pressing in a three-digit code number that corresponds to particular manufacturers and brands of Audio/Video equipment. The three-digit code numbers are listed in the code table of the instruction manual.

1. Turn on the equipment you wish to program (TV, VCR, DVD or AUX).
2. Press the device button (TV, VCR, DVD or AUX) to be programmed and **SELECT** button simultaneously for 3 seconds. The device LED will turn on indicating the unit is ready to be programmed.
Tip: The device LED will turn on for 20 seconds. The next step must be entered while the LED is on.
3. Point the remote control toward the equipment and enter the three-digit code number assigned to your brand from the code tables.
Tip: The equipment will turn off when the correct three-digit code number has been entered. You can verify you have selected the correct code by pressing the **POWER** button; the equipment should turn on or turn off.

Note: If there is more than one three-digit number listed for your brand, try one code number at a time until your equipment turns off.

4. Store the three-digit code number by pressing the same device button once again. The device LED will blink twice to confirm that the code has been stored.

Note: Try all the functions on the remote control. If any of the functions do not work as they should, repeat from Step 2 using the next three-digit code number from the same brand list.

AUTO SEARCH METHOD

If the three-digit code numbers assigned to your brand do not turn off your equipment or the code tables do not list your brand, you can use the Auto Search Method to find the correct three-digit code number for your equipment by the following steps:

1. Turn on the equipment you wish to operate.
2. Press the device button (TV, VCR, DVD or AUX) to be programmed and the **SELECT** button simultaneously for 3 seconds. The device LED will turn on.
Tip: The device LED will turn on for 20 seconds. The next step must be entered while LED is on.
3. Point the remote control toward the equipment and alternately press the **CH+** or **CH-** button and the **POWER** button. If the right code number is sent, the equipment will turn off.
Tip: You can verify that you selected the correct code by pressing the **POWER** button again. The equipment should either turn on or off.
4. Press the same device button to store the code. The device LED will blink twice to confirm that the code has been stored.

TO FIND THE THREE-DIGIT CODE NUMBER THAT WAS STORED IN THE DEVICE

1. Press the device button (TV, VCR , DVD or AUX) you wish to verify and the **SELECT** button simultaneously for 3 seconds. The device LED will turn on.

Tip: The device LED will turn on for 20 seconds. The next step must be entered while the LED is on.

2. Press the **INFO** button. The device LED will blink the number of times indicating the number of each digit of the code number. Each digit is separated by a 1-second interval of the LED being turned off.

Example: One blink, three blinks and eight blinks with an interval of 1 second of LED being turned off indicates the code number 138. Note: Ten blinks is equal to the number 0.

PROGRAMMING A SECOND TV TO AUX MODE

1. Press the **AUX** button to be programmed and the **SELECT** button simultaneously for 3 seconds. The **AUX** device LED will turn on.

Tip: The device LED will turn on for 20 seconds. The next step must be entered while the LED is on.

2. Press the **TV** device button to pick up the TV code table.
3. Point the remote control toward the equipment and enter the three-digit code number assigned to your TV brand from the code tables.
4. Store the three-digit code number by pressing the **AUX** button once again. The device LED will blink twice to confirm that the code has been stored.

PROGRAMMING THE SYSTEM ON/OFF BUTTON

This is designed to program the System On/Off button so that it can send out up to five power on/off commands with one button press.

1. Press the **CBL** button.
2. Press the **SYSTEM ON/OFF** button and the **SELECT** button simultaneously for 3 seconds. The **CBL** button will turn on for 20 seconds.
3. Press the device button and the **POWER** button you wish to store in the **SYSTEM ON/OFF** button and repeat this until you stored all the power commands into the **SYSTEM ON/OFF** button.
4. Press the **CH+** button to save the power commands you stored. The **CBL** button will blink twice to confirm the saving.

CANCELLING THE SYSTEM ON/OFF BUTTON PROGRAMMATION

1. Press the **CBL** button.
2. Press the **SYSTEM ON/OFF** button and the **SELECT** button simultaneously for 3 seconds. The **CBL** button will turn on for 20 seconds.
3. Press the **CH+** button. The **CBL** button will blink twice to confirm the change.

REMOTE CONTROLS

PROGRAMMING CHANNEL CONTROL

By following the steps below, the user can program the channel controls (Channel Up, Channel Down and Last) from one device to operate in another device mode. The default channel control settings on the remote control are as follows:

CBL: PVR **TV:** PVR **VCR:** PVR **DVD:** DVD **AUX:** AUX

If you wish to store the TV channel control in TV mode, use the following steps:

1. Press the **TV** button and the **SELECT** button simultaneously for 3 seconds. The **TV** device LED will turn on.
Tip: The device LED will light on for 20 seconds. The next step must be entered while the LED is on.
2. Press the **VOL-** button.
3. Press the **TV** button. The device LED will blink twice to confirm the programming.

To return to original state: if you wish to restore the PVR channel control in TV mode, repeat the above steps by pressing CBL in Step 3.

PROGRAMMING VOLUME CONTROL

By following the steps below, the user can program the volume controls (Volume Up, Volume Down and Mute) from one device to operate in another device mode. The default volume control settings on the remote control are as follows:

CBL: PVR **TV:** PVR **VCR:** PVR **DVD:** PVR **AUX:** AUX

If you wish to store the CBL volume control in CBL mode, use the following steps:

1. Press the **CBL** button and the **SELECT** button simultaneously for 3 seconds. The **CBL** device LED will turn on.
Tip: The device LED will turn on for 20 seconds. The next step must be entered while the LED is on.
2. Press the **VOL+** button.
3. Press the **CBL** button. The device LED will blink twice to confirm the programming.

To return to original state: If you wish to restore the TV volume control in CBL mode, repeat the above steps by pressing TV in Step 3.

PROGRAMMING FOR ADVANCED FUNCTION

In the **CBL** mode, the **M1** button can be programmed to act as a macro or favourite channel button. You can send out up to 10 commands with one button press.

1. Press the **CBL** button to select the CBL mode.
2. Press the **M1** button and **SELECT** button simultaneously for 3 seconds. The **CBL** device LED will turn on for 20 seconds.
3. Press up to 10 buttons you wish to store. The **CBL** device LED will blink once for each command entered.
4. Press the **CH+** button to store the functions that were selected. The **CBL** device LED will blink twice to confirm the storage of functions.

LOW BATTERY WARNING

When the batteries are low and need to be replaced, the remote control **LED** will blink 2 times in sequence whenever a **POWER** button is pressed to turn on equipment.

MEMORY LOCK SYSTEM

This remote control is designed to retain programmed memory for 10 years, even after batteries are removed from the remote control.

WRITE YOUR DEVICE SET-UP CODES

TV _____ VCR _____ DVD _____ AUX _____

CONNECTIONS

CONNECTION NO. 1: PERSONAL VIDEO RECORDER + STEREO TV

THIS CONNECTION WILL ALLOW YOU TO:

- A. Watch the channel or service of your choice;
- B. Record on the hard drive from the channel you are watching;
- C. Watch a program previously recorded on the hard drive;
- D. Record on the hard drive from one channel while watching another channel;
- E. Record on the hard drive from two different channels while watching a third, previously recorded channel;
- F. Program your PVR to record one program or two programs simultaneously in your absence.

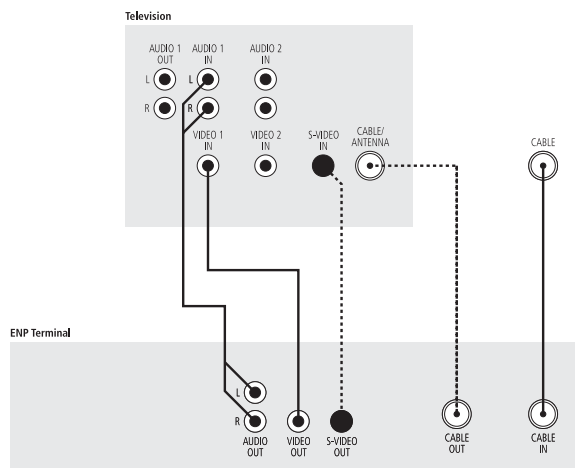

Notes:

- The best possible connection with the cables supplied is illustrated by the solid lines. The dotted lines represent viable options, however.
- Although the rear of the terminal depends on the model (sockets in different positions), the connection is done in the same way.
- You should turn the illico terminal volume all the way up and adjust the volume on the TV to your taste. For explanations, see the "Volume adjustment" section of this guide.

A. TO WATCH THE CHANNEL OR SERVICE OF YOUR CHOICE

1. Turn on the illico terminal by pressing **CBL** and then **POWER** on the remote control.
2. Turn the TV set on and select the **VIDEO/AUDIO** or **S-VIDEO** input by pressing **INPUT SELECT, INPUT, AUX, AVX** or **TV/VIDEO** on the **TV** remote control.
3. Use the illico terminal remote control to tune in to the channel or service of your choice. This will allow you to watch your programs in stereo.

B. TO RECORD ON THE HARD DRIVE FROM THE CHANNEL YOU ARE WATCHING

1. Follow the instructions above to view the channel.
2. Press the **"RECORD"** button on the remote control (red circle).

C. TO WATCH A PROGRAM PREVIOUSLY RECORDED ON THE HARD DRIVE

1. Follow the instructions above to view the channel.
2. Press the **"LIST"** button on the illico remote control to access the contents recorded on the hard drive.
3. Select the desired program by following the on-screen instructions.

D. TO RECORD ON THE HARD DRIVE FROM ONE CHANNEL WHILE WATCHING ANOTHER CHANNEL

1. Follow the instructions in section B to start the recording.
2. You can also program a recording from the interactive TV listings: simply select the program directly in the listings and follow the on-screen instructions.
3. Once recording is in progress or has been programmed, simply change the channel with your remote control to the one you want to watch.
4. The program set to record in step 1 will continue to record and will be accessible at all times, either by tuning into the channel broadcasting the program or by accessing the list of recorded programs (see section C).

E. TO RECORD ON THE HARD DRIVE FROM TWO DIFFERENT CHANNELS WHILE WATCHING A THIRD, PREVIOUSLY RECORDED CHANNEL

1. Follow the steps in section D, but go through the steps for programming a recording twice.
2. If you program two shows to record simultaneously, you will not be able to tune in to a third channel. The PVR will alert you to this.
3. Press the **"LIST"** button on the illico remote control to access the contents recorded, and follow the on-screen instructions to watch the desired program.

F. TO PROGRAM YOUR PVR TO RECORD ONE PROGRAM OR TWO PROGRAMS SIMULTANEOUSLY IN YOUR ABSENCE

1. Follow all the steps in section E.
2. Once these steps have been completed, you can turn your terminal and TV set off. The illico terminal will record the shows you programmed in your absence.

CONNECTIONS

CONNECTION NO. 2: PERSONAL VIDEO RECORDER + STEREO TV + VCR OR DVD RECORDER

THIS CONNECTION WILL ALLOW YOU TO:

- A. Watch the channel or service of your choice;
- B. Record on the hard drive from the channel you are watching;
- C. Watch a program previously recorded on the hard drive;
- D. Record on the hard drive from one channel while watching another channel;
- E. Record on the hard drive from two different channels while watching a third, previously recorded channel;
- F. Program your PVR to record one program or two programs simultaneously in your absence;
- G. Transfer the contents of your hard drive to videotape or DVD for archiving;
- H. View the contents of a videocassette or DVD.

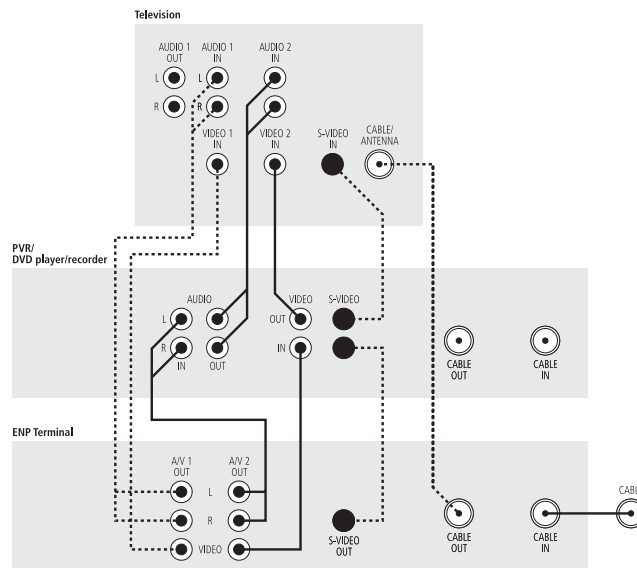

Notes:

- The best possible connection with the cables supplied is illustrated by the solid lines. The dotted lines represent viable options, however.
- Although the rear of the terminal depends on the model (sockets in different positions), the connection is done in the same way.
- You should turn the illico terminal volume all the way up and adjust the volume on the TV to your taste. For explanations, see the "Volume adjustment" section of this guide.

A. TO WATCH THE CHANNEL OR SERVICE OF YOUR CHOICE

1. Turn on the illico terminal by pressing **CBL** and then **POWER** on the remote control.
2. Turn the TV set on and select the **VIDEO/AUDIO** or **S-VIDEO** input by pressing **INPUT SELECT, INPUT, AUX, AVX** or **TV/VIDEO** on the TV remote control.
3. Use the illico terminal remote control to tune in to the channel or service of your choice. This will allow you to watch your programs in stereo.

B. TO RECORD TO THE HARD DRIVE FROM THE CHANNEL YOU ARE WATCHING

1. Follow the instructions above to view the channel.
2. Press the **"RECORD"** button on the remote control (red circle).

C. TO WATCH A PROGRAM PREVIOUSLY RECORDED ON THE HARD DRIVE

1. Follow the instructions above to view the channel.
2. Press the **"LIST"** button on the illico remote control to access the contents recorded on the hard drive.
3. Select the desired program by following the on-screen instructions.

D. TO RECORD ON THE HARD DRIVE FROM ONE CHANNEL WHILE WATCHING ANOTHER CHANNEL

1. Follow the instructions in section B to start the recording.
2. You can also program a recording from the interactive TV listings: simply select the program directly in the listings and follow the on-screen instructions.
3. Once recording is in progress or has been programmed, simply change the channel with your remote control to the one you want to watch.
4. The program set to record in step 1 will continue to record and will be accessible at all times, either by tuning in to the channel broadcasting the program or by accessing the list of recorded programs (see section C).

E. TO RECORD ON THE HARD DRIVE FROM TWO DIFFERENT CHANNELS WHILE WATCHING A THIRD, PREVIOUSLY RECORDED CHANNEL

1. Follow the steps in section D, but go through the steps for programming a recording twice.
2. If you program two shows to record simultaneously, you will not be able to tune in to a third channel. The PVR will alert you to this.
3. Press the **"LIST"** button on the illico remote control to access the contents recorded, and follow the on-screen instructions to watch the desired program.

CONNECTIONS

F. TO PROGRAM YOUR PVR TO RECORD ONE PROGRAM OR TWO PROGRAMS SIMULTANEOUSLY IN YOUR ABSENCE

1. Follow all the steps in section E.
2. Once these steps have been completed, you can turn your terminal and TV set off. The illico terminal will record the shows you programmed in your absence.

G. TO TRANSFER THE CONTENTS OF YOUR HARD DRIVE TO VIDEOTAPE OR DVD FOR ARCHIVING

1. Select the program you would like to transfer from the list of recorded programs (“**LIST**” button on the remote).
2. Select the “List” function and follow the instructions on the screen.
3. Once these steps have been completed, you can watch another program by tuning to it in the normal way on your terminal.

H. TO VIEW THE CONTENTS OF A VIDEOCASSETTE OR DVD

1. Turn the TV set on and select the appropriate input (**VIDEO/AUDIO** or **S-VIDEO**) on the TV by pressing **INPUT SELECT, INPUT, AUX, AVX** or **TV/VIDEO** on the TV remote control.
2. Start playback of the DVD or videocassette by pressing “**PLAY**” on the VCR or DVD player/recorder.

CONNECTION NO. 3: HIGH DEFINITION PERSONAL VIDEO RECORDER + HIGH DEFINITION TV

THIS CONNECTION WILL ALLOW YOU TO:

- Watch the channel or service of your choice (in HD, when available);
- Record on the hard drive from the channel you are watching (in HD, when available);
- Watch a program previously recorded on the hard drive (in HD, when available);
- Record on the hard drive from one channel while watching another channel (in HD, when available);
- Record on the hard drive from two different channels while watching a third, previously recorded channel (in HD, when available);
- Program your PVR to record one program or two programs simultaneously in your absence (in HD, when available).

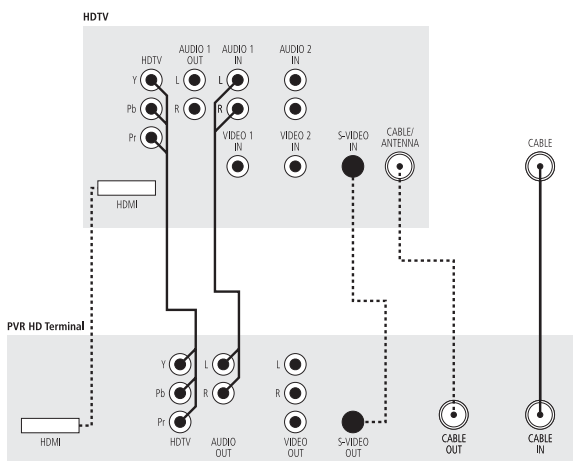

Notes:

- The best possible connection with the cables supplied is illustrated by the solid lines. The dotted lines represent viable options, however.
- Although the rear of the terminal depends on the model (sockets in different positions), the connection is done in the same way.
- You should turn the illico terminal volume all the way up and adjust the volume on the TV to your taste. For explanations, see the "Volume adjustment" section of this guide.
- On certain first-generation illico HD terminals, the HDMI outlet is non-existent or has been replaced by a DVI outlet.

CONNECTIONS

A. TO WATCH THE CHANNEL OR SERVICE OF YOUR CHOICE

1. Turn on the illico terminal by pressing **CBL** and then **POWER** on the remote control.
2. Turn the TV set on and select the **VIDEO/AUDIO, S-VIDEO** or **HD** input by pressing **INPUT SELECT, INPUT, AUX, AVX** or **TV/VIDEO** on the TV remote control.
3. Use the illico terminal remote control to tune in to the channel or service of your choice. This will allow you to watch your programs in stereo.

B. TO RECORD ON THE HARD DRIVE FROM THE CHANNEL YOU ARE WATCHING

1. Follow the instructions above to view the channel.
2. Press the **"RECORD"** button on the remote control (red circle).

C. TO WATCH A PROGRAM PREVIOUSLY RECORDED ON THE HARD DRIVE

1. Follow the instructions above to view the channel.
2. Press the **"LIST"** button on the illico remote control to access the contents recorded on the hard drive.
3. Select the desired program by following the on-screen instructions.

D. TO RECORD ON THE HARD DRIVE FROM ONE CHANNEL WHILE WATCHING ANOTHER CHANNEL

1. Follow the instructions in section B to start the recording.
2. You can also program a recording from the interactive TV listings: simply select the program directly in the listings and follow the on-screen instructions.
3. Once recording is in progress or has been programmed, simply change the channel with your remote control to the one you want to watch.
4. The program set to record in step 1 will continue to record and will be accessible at all times, either by tuning in to the channel broadcasting the program or by accessing the list of recorded programs (see section C).

E. TO RECORD ON THE HARD DRIVE FROM TWO DIFFERENT CHANNELS WHILE WATCHING A THIRD, PREVIOUSLY RECORDED CHANNEL

1. Follow the steps in section D, but go through the steps for programming a recording twice.
2. If you program two shows to record simultaneously, you will not be able to tune in to a third channel. The PVR will alert you to this.
3. Press the **"LIST"** button on the illico remote control to access the contents recorded, and follow the on-screen instructions to watch the desired program.

F. TO PROGRAM YOUR PVR TO RECORD ONE PROGRAM OR TWO PROGRAMS SIMULTANEOUSLY IN YOUR ABSENCE

1. Follow all the steps in section E.
2. Once these steps have been completed, you can turn your terminal and TV set off. The illico terminal will record the shows you programmed in your absence.

CONNECTION NO. 4: HIGH DEFINITION PERSONAL VIDEO RECORDER + HD TV + VCR OR DVD RECORDER

THIS CONNECTION WILL ALLOW YOU TO:

- Watch the channel or service of your choice;
- Record on the hard drive from the channel you are watching;
- Watch a program previously recorded on the hard drive;
- Record on the hard drive from one channel while watching another channel;
- Record on the hard drive from two different channels while watching a third, previously recorded channel;
- Program your PVR to record one program or two programs simultaneously in your absence;
- Transfer the contents of your hard drive to videotape or DVD for archiving;
- View the contents of a videocassette or DVD.

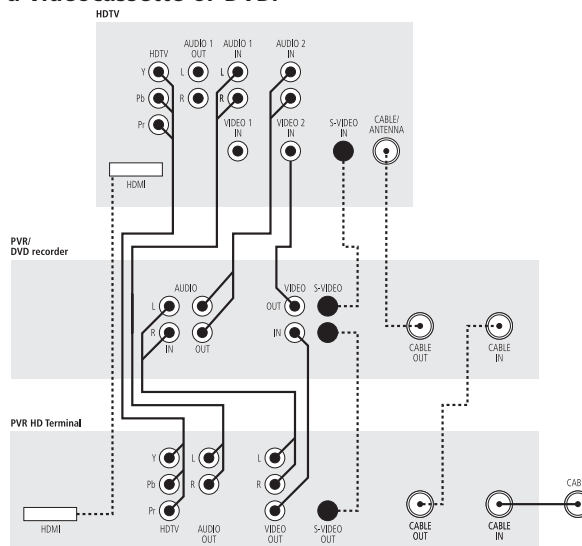

Notes:

- The best possible connection with the cables supplied is illustrated by the solid lines. The dotted lines represent viable options, however.
- Although the rear of the terminal depends on the model (sockets in different positions), the connection is done in the same way.
- You should turn the illico terminal volume all the way up and adjust the volume on the TV to your taste. For explanations, see the "Volume adjustment" section of this guide.
- On certain first-generation illico HD terminals, the HDMI outlet is non-existent or has been replaced by a DVI outlet.

CONNECTIONS

A. TO WATCH THE CHANNEL OR SERVICE OF YOUR CHOICE

1. Turn on the illico terminal by pressing **CBL** and then **POWER** on the remote control.
2. Turn the TV set on and select the **VIDEO/AUDIO, S-VIDEO** or **HD** input by pressing **INPUT SELECT, INPUT, AUX, AVX** or **TV/VIDEO** on the TV remote control.
3. Use the illico terminal remote control to tune in to the channel or service of your choice. This will allow you to watch your programs in stereo.

B. TO RECORD ON THE HARD DRIVE FROM THE CHANNEL YOU ARE WATCHING

1. Follow the instructions above to view the channel.
2. Press the **"RECORD"** button on the remote control (red circle).

C. TO WATCH A PROGRAM PREVIOUSLY RECORDED ON THE HARD DRIVE

1. Follow the instructions above to view the channel.
2. Press the **"LIST"** button on the illico remote control to access the contents recorded on the hard drive.
3. Select the desired program by following the on-screen instructions.

D. TO RECORD ON THE HARD DRIVE FROM ONE CHANNEL WHILE WATCHING ANOTHER CHANNEL

1. Follow the instructions in section B to start the recording.
2. You can also program a recording from the interactive TV listings: simply select the program directly in the listings and follow the on-screen instructions.
3. Once recording is in progress or has been programmed, simply change the channel with your remote control to the one you want to watch.
4. The program set to record in step 1 will continue to record and will be accessible at all times, either by tuning in to the channel broadcasting the program or by accessing the list of recorded programs (see section C).

E. TO RECORD ON THE HARD DRIVE FROM TWO DIFFERENT CHANNELS WHILE WATCHING A THIRD, PREVIOUSLY RECORDED CHANNEL

1. Follow the steps in section D, but go through the steps for programming a recording twice.
2. If you program two shows to record simultaneously, you will not be able to tune in to a third channel. The PVR will alert you to this.
3. Press the **"LIST"** button on the illico remote control to access the contents recorded, and follow the on-screen instructions to watch the desired program.

F. TO PROGRAM YOUR PVR TO RECORD ONE PROGRAM OR TWO PROGRAMS SIMULTANEOUSLY IN YOUR ABSENCE

1. Follow all the steps in section E.
2. Once these steps have been completed, you can turn your terminal and TV set off. The illico terminal will record the shows you programmed in your absence.

G. TO TRANSFER THE CONTENTS OF YOUR HARD DRIVE TO VIDEOTAPE OR DVD FOR ARCHIVING

1. Select the program you would like to transfer from the list of recorded programs (“**LIST**” button on the remote).
2. Select the “List” function and follow the instructions on the screen.
3. Once these steps have been completed, you can watch another program by tuning to it in the normal way on your terminal.

H. TO VIEW THE CONTENTS OF A VIDEOCASSETTE OR DVD

1. Turn the TV set on and select the appropriate input (**VIDEO/AUDIO, S-VIDEO** or **HD**) on the TV by pressing **INPUT SELECT, INPUT, AUX, AVX** or **TV/VIDEO** on the TV remote control.
2. Start playback of the DVD or videocassette by pressing “**PLAY**” on the VCR or DVD recorder.

ILICO ON DEMAND

The features available while watching a movie on illico on Demand are the same as for a VCR.

This means:

1. **Pause**
2. **Resume watching**
3. **Rewind**
4. **Fast forward**
5. **Stop**

ORDERING A MOVIE

1. Put the **VCR/VOD** illico terminal button in the **VOD** mode.
2. Press **▲**. Once the interactive menu comes on, select illico on Demand and push **SELECT**, or tune in to channel 900.
3. Choose a category or a subcategory and a title and push **SELECT** after each choice.
4. Push **SELECT** to order the movie, enter your PIN and push **SELECT**. The default PIN is 0000.
5. Press **PLAY** to confirm the order and start the movie. The movie ordered is available for 24 hours. **To cancel the order** at this point, press **C**. Once past this step, the movie rental cannot be cancelled.

TO RESUME WATCHING

1. In the **VOD** menu, select **Resume Viewing** and press **SELECT**.
2. Choose the title and press **SELECT**; the movie will start where you left off.
3. To watch the movie from the beginning, press **REWIND**.
4. To exit illico on Demand, press **EXIT**.

The time indicated next to a title shows the time remaining on your rental.

ACTIVATING PARENTAL CONTROL

TO BLOCK OUT MOVIES BASED ON THEIR TYPE

1. Push **SETTINGS** twice.
2. Select **BLOCK: RATING** and push **SELECT**.
3. Enter your parental PIN (the default PIN is 0000) and follow the instructions on the screen.
4. You can block one or more type of movie ratings to avoid unpleasant surprises.

INTERACTIVE PROGRAM GUIDE

Press the **GUIDE** button and the Interactive Program Guide (IPG) displays the list of upcoming programs for the next days. These programs can be sorted by **channel**, **theme** or **title**.

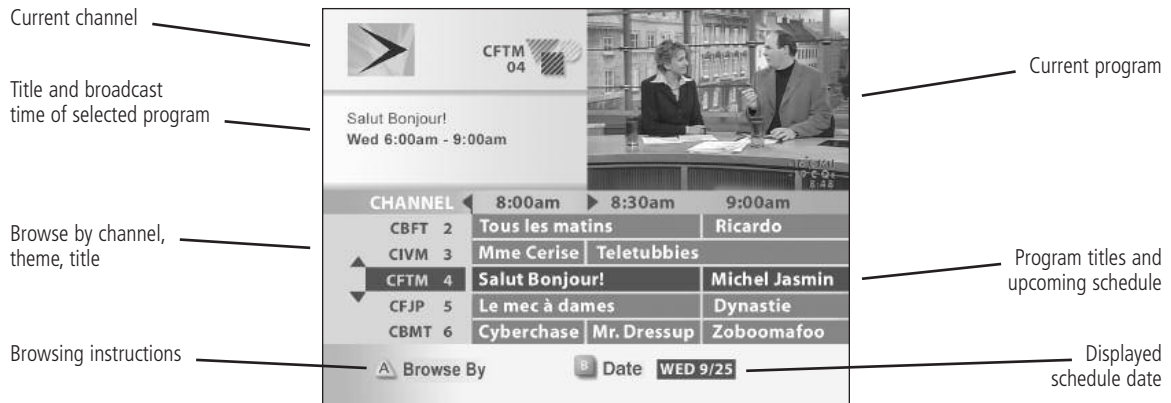

The digital terminal cannot display both a standard and a HD video at the same time. When watching a HD-formatted TV program and calling the **IPG**, the top right video will therefore be replaced by a black shape.

HOW TO BROWSE BY CHANNEL





1. Press **GUIDE**; the program you are watching is highlighted.
2. Use the **↑** and **↓** arrows to move through the channels, and the **←** and **→** arrows to move through the time slots.

HOW TO BROWSE BY THEME

1. When the guide is on screen, press **△**, choose **Theme**, then press **SELECT**.
2. Press the **←** arrow, choose a theme and press **SELECT**.
3. Use the **↑** and **↓** arrows to move through the titles.

INTERACTIVE PROGRAM GUIDE

HOW TO BROWSE BY TITLE

1. When the guide is on screen, press , choose **Title**, then press **SELECT**.
2. Press the , choose the first letter of the program in question and press **SELECT**.
3. Use the  and  arrows to move through the titles.
 - **To tune the selected program in the current time slot**, highlight it and press **SELECT**.
 - **To view the schedule for the next days**, press , highlight the date for the available day, then press **SELECT**.

At any time, you can press the **INFO** button twice for more information on the selected program. After browsing through the IPG, press  to go back to where you started.

HOW TO SCHEDULE A REMINDER

1. Press **GUIDE**, highlight a program and press **SELECT**.
2. Highlight **Set a Reminder** and press **SELECT**; the chosen title is now in green.

With the parental control feature, you can block:

1. **Certain viewing times**
2. **Specific channels**
3. **Some types of programs**

All you need is your PIN!

TO BLOCK VIEWING TIMES

1. Press **SETTINGS** twice, select BLOCK: TIME NEW and press **SELECT**.
2. Determine blocked times by following the instructions on screen.

TO BLOCK CHANNELS

1. Press **SETTINGS** twice, select BLOCK: CHANNELS and press **SELECT**.
2. Determine blocked channels by following the instructions on screen.

TO BLOCK TYPES OF PROGRAMS

1. Press **SETTINGS** twice, select BLOCK: RATINGS and press **SELECT**.
2. Determine blocked types of programs by following the instructions on screen.

ACTIVATING PARENTAL CONTROL

Once you have determined the channels, times and types of programs to be blocked, you need to activate the parental control feature by following the steps below:

1. Press **SETTINGS** twice, select BLOCK: PIN, choose the ENABLE feature and press **SELECT**.
2. Press **▲** and enter your PIN.

TO DEACTIVATE THIS FEATURE, FOLLOW THE INSTRUCTIONS BELOW:

1. Press **SETTINGS** twice, select BLOCK: PIN, choose DISABLE and press **SELECT**.
2. Press **▲** and enter your PIN to disable (or change) the feature.
3. At this step, you can also change your PIN by selecting CHANGE.

You can also unblock access to a blocked channel by tuning it in and following the instructions on the screen.

Note: Your default PIN is 0000.

ADJUSTING THE VOLUME

AUDIO SIGNAL EMITTED BY YOUR TERMINAL

By adjusting the volume on your TV, you determine the loudness of the sound coming from your speakers. With illico, however, the VOLUME feature adjusts the power of the audio signal coming from your terminal. This signal then enters your TV or audio system at the programmed level. This is why it is important to keep the power of the audio signal coming from your illico terminal at maximum level.



PROGRAMMING YOUR REMOTE CONTROL

You must program your illico remote control to control the sound from the TV speakers rather than the power of the audio signal coming from the terminal. To do so, you first need to program your remote control to turn the TV on/off. Then, depending on the model, follow the instructions for programming the remote control to control the TV volume (reference: remote control section of this guide).

SETTING ILLICO LEVELS FOR BETTER SOUND QUALITY

There are three main settings.

To access the general settings menu, press **SETTINGS** twice on your illico remote control. Once in the GENERAL SETTINGS menu, follow the instructions below:

- A. In the menu on the left, select AUDIO: DIGITAL OUT using the up/down arrows. Go to the right and, using the arrows again, select DOLBY DIGITAL. Press  to confirm your selection.
- B. In the menu on the left, select AUDIO: RANGE using the up/down arrows. Go to the right and, using the arrows again, select NARROW. Press  to confirm your selection.
- C. In the menu on the left, select AUDIO: VOLUME CTRL using the up/down arrows. Go to the right and, using the arrows again, select FIXED. Press  to confirm your selection.

Naturally, for impeccable sound quality, your TV or home theatre speakers have to be in good condition. Also, be sure to use top-quality speaker wires. In addition, if your home theatre has an AC-3 input, we recommend you use it because illico is AC-3 enabled. If you are watching a program in this format, you will get superior quality sound, provided your equipment has been set accordingly.

Indigo and **Viewer's Choice** feature uninterrupted films and special events that can be ordered at any time using the IPG. Charges for these programs will appear on your next month's bill.

- Channel 300 is the preview channel for **Indigo**, and 350, that for **Viewer's Choice**. Watch these channels for an overview of current and upcoming films.

HOW TO ORDER A FILM OR EVENT

- Press **GUIDE** and browse through the 300 series channels to see the featured titles. Highlight the title that interests you, press **SELECT** and follow the on-screen instructions.
or
- Tune in to the channel broadcasting the film and follow the on-screen instructions.

HOW TO CANCEL A FILM OR EVENT

- Press **SETTINGS** twice to call up the **General Settings** screen. Select PPV: Purchases. Press **SELECT** and enter your **PIN**. Choose the film or event you wish to cancel. Press **SELECT** to cancel, then **△** to confirm cancellation.

PPV PIN: To order a film or event, you must enter a PIN. The default PIN is 0000. We recommend that you change your PIN upon placing your first order. To do so, you need only enter a new 4-digit PIN when the PIN window appears on screen.

If you forgot your PIN, contact Customer Technical Support (see page 50).

PARENTAL CONTROL

Parental control is accessed through the Pay-per-View feature (TALC). Consult the relevant section on page 31 for further details.

Make sure the CBL mode key is activated, because it controls the PVR features.

To see whether the key is activated or not, press the INFO key: if the CBL key's LED lights up, that means the key is activated. If it doesn't, press the CBL key.

HOW TO CONTROL A LIVE PROGRAM YOU ARE WATCHING

The **PVR** stores the programming being broadcast on the channel you are watching in a memory buffer. This lets you pause and rewind the action (even with a live broadcast), and resume watching the program in real time.



Pauses the program you are watching for a maximum of one hour. After one hour, playback resumes from the point where you paused the program.



Resumes playback of a paused program.



Rewind: press once, twice, three or four times to slow down or speed up the rewind speed.



Fast-forward: press once, twice, three or four times to slow down or speed up the fast-forward speed.



Returns you to live programming.



Instantly replays the last 8 seconds of the program you are watching.

PERSONAL VIDEO RECORDER

When you press one of these keys, a status bar is momentarily displayed at the bottom of the screen to show you the progress of playback and broadcast of the program you are watching.



Note: The program stored in the memory buffer is erased as soon as you change channels or switch off the PVR. To save a program, you have to record it and save it on the hard drive.

PERSONAL VIDEO RECORDER

HOW TO RECORD AND STORE A PROGRAM

There are three ways to record a program:

- Record a program while you watch it
- Record a program from the Program Guide
- Manually record all programs in a single time slot

RECORD A PROGRAM WHILE WATCHING IT



If you have been tuned in to a program since it started, you can press the  key at any time during the broadcast and the entire program will be recorded.

1. Press .
2. When the **Confirm Recording** screen is displayed, press the  key to record and store the program. The **RECORD** indicator on the front panel lights up for a few seconds after you confirm the recording.

To record more than one episode of a program and modify the save time, press the  key rather than the **SELECT** key. **For more information on recording options, refer to the next page.**

RECORD A PROGRAM FROM THE PROGRAM GUIDE



With this type of recording, you decide in advance what programs to record, so you'll never miss them.

1. Press the **GUIDE** key; the title of the program in progress is highlighted.
2. Highlight a program title and press .
3. Press the  key to confirm recording. The title of the recorded program is highlighted in red in the program guide.
4. Press the **GUIDE** again to return to the program in progress.

You can record programs blocked by the Parental Control feature, but you will need to enter your PIN first to watch them.

MANUALLY RECORD ALL PROGRAMS IN A SINGLE TIME SLOT

To manually record all programs in a specific time slot:

1. Press the  key, then press  **Preferences**.
2. Highlight **Schedule a New Manual Recording**, then press **SELECT**.
3. Highlight the channel, the recording start and end times, and the save time, then press .
4. Press **EXIT** to return to the program in progress.

If you are watching television and recording two programs at the same time, you must be either tuned in to one of the programs you are recording, or watching a program you have already recorded.

RECORDING OPTIONS

The recording options let you:

- Schedule, in a single step, recording of all episodes of your favourite program.
- Change the default save time.
- Modify the recording start and end times.

PERSONAL VIDEO RECORDER

CHANGE START AND END TIMES

1. Select hour using **↑** or **↓**, then select minutes using **→**.
2. Do the same for each column.
3. To confirm your settings, press **△**.

If you would rather enter the time manually, you must enter the four digits requested, even if you are only changing the minutes value, otherwise the change will not be programmed.



You cannot schedule a VCR recording in advance. You can, however, tape a program in progress, or transfer the PVR recording you're watching onto a videocassette.

PLAY BACK A RECORDED PROGRAM

1. Press the **LIST** key, highlight a program title, and press **SELECT**.
2. Highlight an option and press **SELECT**.
3. To return to a program in progress without watching a recorded program in its entirety, press **□**, then **EXIT**, and tune in to the desired channel.
4. To return to a program in progress after watching a recorded program in its entirety, press **EXIT** and tune in to the desired channel.

If you stop watching a recorded program to watch a live program, when you return to the recorded program, it will resume playing where you left off. If you want to watch it again from the beginning, press **□**, select **Play from beginning** and press **SELECT**.

BLOCK A PROGRAM

If you have recorded a program that was not subject to Parental Control, but decide to block access to it later:

1. Press the **LIST** key, highlight a program title, and press **SELECT**.
2. Highlight **Block** and press **SELECT**.
3. Enter your parental PIN and press **▲**; a small red padlock appears in the upper left window of the screen, confirming that the title has been blocked.
4. To view the program, you must enter your parental PIN.

SORT PROGRAM TITLES

To make it easier to access recorded programs, you can sort them by alphabetical order or by date and time recorded. To change from one setting to the other:

1. Press the **LIST** key, then press **B Preferences**.
2. Choose the desired sorting method and press **SELECT**.

SAVE TIME

DEFAULT SAVE TIME

1. Press the **LIST** key, then press **B Preferences**. Highlight **Change Save Time** and press **SELECT**.

The save time is the period during which a recorded program will be stored on the terminal's hard drive. **The default save time** applies to all future recordings; it can be 1, 2, 7, 14 days, or indefinite. When that period has expired, the program will be erased automatically.

CHANGE THE SAVE TIME FOR A PROGRAM YOU HAVE ALREADY RECORDED

1. Press the **LIST** key, highlight a program title, and press **SELECT**.
2. Highlight **Change Save Time**, and press **▲**.
3. Highlight a time and press **SELECT**.
4. Press the **EXIT** key to return to the program in progress.



CHANGE THE SAVE TIME FOR A SCHEDULED RECORDING

1. Press the **LIST** key followed by **▲**, then highlight a program title, and press **SELECT**.
2. Highlight the **SAVE** column, select a period, and press **SELECT**.
3. Press the **EXIT** key to return to the program in progress.





PERSONAL VIDEO RECORDER

HOW TO DELETE A RECORDED PROGRAM OR A SCHEDULED RECORDING

DELETE A PROGRAM FROM THE LIST OF RECORDED PROGRAMS

1. Press the  key, highlight a program title, and press **SELECT**.
2. Highlight **Erase**, then press  to confirm.

DELETE OR MODIFY A SCHEDULED RECORDING





1. Press the  key, then press .
2. Highlight a program title and press **SELECT**.
3. Press  to delete the program, then press  to confirm.
or
Modify program, then press .

DELETE A RECORDING IN PROGRESS

1. Tune in to the channel broadcasting the program being recorded and press the  key.
2. Highlight **Stop and Erase**, then press **SELECT**.

PICTURE-IN-PICTURE (PIP) – HOW TO WATCH TWO PROGRAMS AT ONCE

The keys near the bottom of the remote control are used to control the PIP feature, which lets you view two programs at the same time.

- Press ; a second screen (the PIP screen) appears superimposed on the main screen.
- Press  to change the channel in the PIP screen.
- Press  to swap the program in the PIP screen to the main screen, and vice versa.
- Press  to move the PIP screen to a different corner of the main screen.

STORAGE CAPABILITIES

Digital TV channels broadcast variable amounts of data, depending on the type of program being aired. For instance, there may be times when a sports specialty channel broadcasts a larger quantity of data than channels whose lineups are primarily made up of talk shows or soap operas. Sports programs generally involve much more movement, and more data are therefore required to reproduce the images on your screen. The number of recording hours available to you therefore varies according to the types of programs you record.

Based on the average amount of data transmitted by an **SDTV** (Standard Definition Television) channel, a PVR terminal's 80-gigabyte hard drive can store up to 50 hours of recorded programs.

HDTV (High-Definition Television) channels need to transmit 2 to 2.5 times more data than standard channels to reproduce a higher quality image on your screen. Your PVR HD is equipped with a high-capacity hard drive (160 gigabytes) that lets you store up to 20 hours of high-definition programming, or up to 100 hours of standard-format content.

SETTINGS

QUICK SETTINGS

The **Quick Settings** screen displays the most frequently used functions and settings:

- Add a channel to (or remove it from) your Favourites list
- Turn Parental Control ON/OFF
- Start recording
- Set Sleep Timer
- Set SAP (Second Audio Program) language
- Switch Caption OFF/ON or ON with mute (Explorer® 8010HD and 8300HD)
- Block or unblock the current channel
- Set Picture Size (HD terminal only)

HOW TO DISPLAY QUICK SETTINGS

1. Press the **SETTINGS** key once to display the **Quick Settings** screen, highlight an option, and press **SELECT** to modify it.
2. Press the **EXIT** key to leave **Quick Settings** and return to the current channel.

For more information on the options available in Quick Settings, press the **SETTINGS** key twice to display the General Settings screen, highlight an option, and press the **INFO** key.

GENERAL SETTINGS

The General Settings screen lets you customize the terminal's display features and set the timers.

- Press the **SETTINGS** key twice, highlight an option, and press the **INFO** key to see what the option does.

Options
Audio: Digital Out
Audio: Range
Audio: Volume Ctrl
Block: Channels
Block: PIN
Block: Rating
Block: Time New
CC: Background*
CC: Characters*
CC: Options*
CC: Source*
Display: Power Off
Display: Power On
Language: Audio
Language: Keyboard

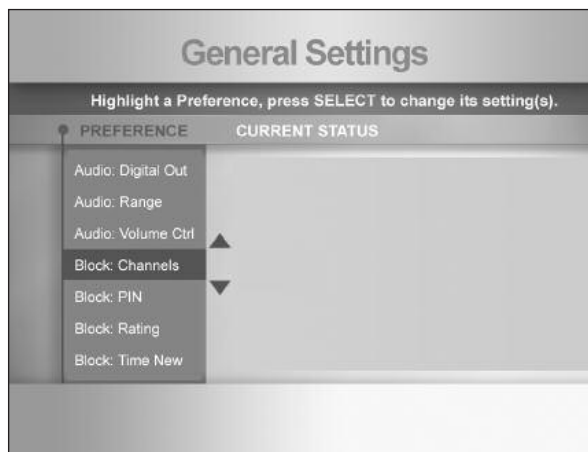

Options
Language: Screen
Purchase: PIN PPV: Purchases
Set: A-C Outlet
Set: Color Scheme
Set: Output Chan
Set: VCR Commander
Timer: All
Timer: Rewind New
Timer: Sleep
Timer: Turn Off
Timer: VCR New
Timer: Wake-Up
Viewer: Favourites
Viewer: Power On
* Explorer® HD only

TERMINAL

My terminal feels hot, is this normal?

Yes, because the electronic components inside generate a lot of heat. To prevent overheating, avoid blocking the air vents on the top and sides and do not place the terminal in enclosed furniture.

Can I leave my terminal on all the time?

Yes, but we recommend turning it off after use.

FUNCTIONS

The TV program guide no longer displays data

Change the terminal Display language and return to the initial language when the problem is solved. To change the Display language, press SETTINGS twice and select Language: Screen on the General Settings screen options menu.

Does the terminal support the Second Audio Program (SAP) function?

Yes. The terminal can convert SAP even though very few programs are designed to support this function.

Does the terminal show subtitles of programs encoded for the hearing impaired?

Standard PVR terminals allow passage of sub-title information so that it can be received by a suitable decoder (e.g. your television). However, HD PVR terminals first decode sub-title data and then send it to the television.

PERIPHERALS

Can I use a DVD player or DVD recorder with the terminal?

Yes. A DVD player should work independently from the terminal and be connected directly to the television. A DVD recorder, on the other hand, is connected to the terminal much like a VCR.

Is the VCR+ function on the VCR of any use with the terminal?

No, this function is only used to record the analog signal.

VCR Commander, IR Blaster and IR Receiver

VCR Commander and IR Blaster are infrared transmitters that make it easier to record programs.

- Explorer 2000: compatible with VCR Commander
- Other Explorer models: compatible with IR Blaster
- PACE terminals: IR Receiver

What connects to the USB port and what is it for?

USB is a computer standard. The port is used to connect peripheral devices: keyboard, mouse, scanner, printer, diskette storage drive. At this time, the USB port on the terminal is not operational but it will be in the near future.

FREQUENTLY ASKED QUESTIONS

REMOTE CONTROL

Can I turn on my TV and the terminal at the same time?

Yes, but if your TV is an older model and you turn it on by pulling a button, you will have to connect the TV to the CA output on the back of the terminal.

- Press the SETTINGS button twice on the terminal's keyboard or remote control.
- Select Settings: CA output and press SELECT. Select "Avec le terminal" (with the terminal), press SELECT and SETTINGS.

SOUND AND IMAGE

Poor picture reception

In most cases, simply re-initializing the terminal re-establishes the service. To re-initialize, you need to turn off the terminal, disconnect it from the wall outlet, and then reconnect it. Wait 5 minutes, restart the terminal and tune in to a channel. If the problem persists, please contact Technical Support.

What gets connected to the S-VIDEO output and what is it for?

It is used to connect a VCR or TV equipped with an S-VIDEO input. This connector separates colours and brightness, which enhances image quality. You need to purchase a cable in order to use it.

The sound does not match the program I'm watching

Make sure that the SAP (Second Audio Program) setting on the television set is disabled and that the SAP setting on your terminal corresponds to your chosen language.

Can I take advantage of AC-3 technology with the terminal?

Yes, but you need an AC-3 decoder. This decoder is usually built into newer, high-end sound systems or home theatre systems. The illico terminal relays the information (Digital Audio Out connector) but does not decode it.

SURVEILLANCE CAMERAS

Which channel do I select to view images sent by my surveillance camera? 950.

FRONT PANEL DISPLAY

Can I change the time shown on the front of the terminal?

No, the time shown reflects the terminal's internal clock. However, depending on the screen language setting, it can be displayed in the 24-hour system (French) or the 12-hour system (English).

Modifying the time format displayed on the front of the terminal

- Press the SETTINGS button twice on the remote control or wireless keyboard.
- Select Language: Screen and press SELECT.
- Select English or Spanish for the 12-hour format and French for the 24-hour format, and then press SELECT and SETTINGS.

The words NON AUTORISÉ or NOT AUTHORIZED are displayed on some of my service channels

If this problem occurs, please contact Technical Support.

PAY-PER-VIEW AND PIN

I ordered an Indigo movie and the terminal asked me to enter a 4-digit PIN. What is it for?

This PIN is a security feature. Only individuals who know the PIN can order a movie or an event. All subscribers have the default PIN 0000; it is a good idea to change the PIN regularly.

Ordering a movie with illico

1. Tune in to Channel 350 (VCC trailers) and press Guide on the keyboard or remote control.
2. Select a time slot and scroll the movies broadcast during this period.
3. Select a title and press SELECT twice.
4. Press B and enter your PIN. The default PIN is 0000.

Note: You can order movies up to 4 hours in advance and events up to 7 days in advance.

Forgot your illico PIN?

If you have never changed your PIN, enter 0000, which is the default PIN. If you have already changed it, you will have to contact Customer Service.

The telephone numbers for **Customer Service** and **Customer Technical Support** are listed on page 50.

LIST OF CODES

REMOTE CONTROL SETUP CODES FOR AT8400

TV (*HD equipment code)

Admiral – 1001, 1139, 1159	1045, 1046, 1053, 1072, 1132,	Montgomery Ward – 1001	Sanyo – 1004, 1041, 1042, 1062,
Aiko – 1014	1133, 1134, 1145, 1161	Motorola – 1003, 1139	1068, 1089, 1090, 1135, 1144
Akai – 1002	Goldstar – 1004, 1005, 1006, 1010,	MTC – 1004, 1005, 1006, 1087	Scott – 1004, 1006, 1010, 1020, 1031,
Amtron – 1034	1017, 1047, 1048, 1049, 1126,	Multitech – 1034	1034, 1040
Anam National – 1003, 1034	1127, 1137, 1138	Multivision – 1070	Sears – 1000, 1004, 1006, 1011,
AOC – 1004, 1005, 1006, 1007, 1140,	Hallmark – 1004, 1006	NAD – 1006, 1060, 1061, 1147, 1166	1012, 1017, 1040, 1041, 1042,
1141, 1153	Hitachi – 1004, 1006, 1010, 1011,	NEC – 1003, 1004, 1005, 1006, 1009	1043, 1053, 1055, 1060, 1061,
Apex – 1180	1012, 1050, 1051, 1052, 1109,	Nikko – 1006, 1014	1062, 1091, 1092, 1144, 1145,
Audiovox – 1034	1110, 1111, 1112, 1113, 1114,	Onwa – 1034	1150
Bell & Howell – 1001, 1042, 1062	1115, 1116, 1117, 1118, 1119,	Optimus – 1147, 1166	Sharp – 1004, 1066, 1010, 1022,
Broksonic – 1181	1120, 1121, 1143, 1154, 1166,	Optonica – 1079, 1139	1025, 1079, 1093, 1094, 1095,
Carver – 1000	1169	Orion – 1031, 1152	1100, 1137, 1139
Celebrity – 1002	Infinity – 1000	Panasonic – 1003, 1045, 1136, 1162,	Signature – 1001
Citizen – 1004, 1006, 1008, 1014,	JBL – 1000	1179*	Sony – 1002, 1157, 1164, 1165,
1034, 1032, 1087, 1137, 1160	JC Penney – 1004, 1005, 1006, 1008,	Philco – 1000, 1003, 1004, 1005,	1174*, 1176*, 1177*
ColorTyme – 1004, 1006, 1009	1011, 1018, 1044, 1045, 1048,	1006, 1008, 1010, 1017, 1057,	Soundesign – 1004, 1006, 1008, 1034,
Contec/Cony – 1010, 1011, 1012,	1049, 1053, 1061, 1072, 1086,	1058, 1063, 1065	1040
1034	1087, 1104, 1137, 1138, 1145	Philips – 1000, 1003, 1004, 1008,	Starlite – 1034
Craig – 1034	Jensen – 1004, 1006	1010, 1017, 1057, 1058, 1063,	Sylvania – 1000, 1004, 1006, 1008,
Crosley – 1000	JVC – 1010, 1011, 1012, 1045, 1051,	1071, 1072, 1073, 1074	1017, 1057, 1058, 1063, 1064,
Crown – 1034	1054, 1055, 1056, 1128, 1129,	Pioneer – 1004, 1006, 1075, 1076,	1065, 1073, 1096, 1131
Curtis Mathes – 1004, 1006, 1013,	1146, 1168, 1175*	1143, 1147, 1166	Symphonic – 1029, 1034, 1150
1042, 1053, 1062, 1087, 1137,	Kawasho – 1002, 1004, 1006	Portland – 1004, 1005, 1006, 1014,	Tandy – 1139
1160, 1167	Kenwood – 1004, 1006, 1017	1137	Tatung – 1003
Daewoo – 1004, 1005, 1006, 1014,	Kloss Novabeam – 1034, 1057, 1058	Price Club – 1087	Technics – 1045
1015, 1016, 1103, 1137, 1151	KTV – 1034, 1059, 1137, 1142	Prism – 1045	Techwood – 1004, 1006, 1045
Daytron – 1004, 1006, 1137	LG – 1005	Proscan – 1053, 1145	Teknika – 1000, 1001, 1004, 1005,
Dimensia – 1053	Logik – 1001	Proton – 1004, 1006, 1010, 1077	1006, 1008, 1010, 1011, 1012,
Dumont – 1004, 1122	Luxman – 1004, 1006	Quasar – 1003, 1045, 1059, 1078,	1014, 1034, 1040, 1064, 1087,
Electroband – 1002	LXI – 1000, 1006, 1042, 1053, 1060,	1162	1136, 1137, 1162
Electrohome – 1002, 1003, 1004,	1061, 1062, 1145	Radio Shack – 1042, 1062	Telecaption – 1097
1006, 1017, 1018	Magnavox – 1000, 1004, 1006, 1008,	Radio Shack/Realistic – 1004, 1006,	Thomson – 1171*
Emerson – 1004, 1006, 1010, 1019,	1017, 1057, 1058, 1063, 1064,	1010	Toshiba – 1042, 1060, 1061, 1062,
1020, 1021, 1022, 1023, 1024,	1065, 1073, 1106, 1107, 1108	RCA – 1003, 1004, 1005, 1006, 1007,	1087, 1091, 1097, 1098, 1130,
1025, 1026, 1027, 1028, 1029,	Majestic – 1001	1017, 1053, 1080, 1081, 1082,	1131, 1183, 1172*, 1173*
1030, 1031, 1032, 1033, 1034,	Marantz – 1000, 1004, 1006, 1050,	1083, 1084, 1085, 1105, 1143,	Totevision – 1137
1035, 1036, 1037, 1038, 1039,	1066	1145, 1148, 1149, 1151, 1155,	Universal – 1044, 1072
1040, 1042, 1062, 1101, 1137,	Megatron – 1006, 1050	1163, 1167, 1170, 1182	Vidikron – 1000
1142, 1143, 1152, 1168	Memorex – 1001, 1005, 1006, 1042,	Realistic – 1042, 1062	Wards – 1000, 1001, 1004, 1005,
Envision – 1004, 1006	1062	Runco – 1122	1006, 1017, 1020, 1029, 1040,
Fisher – 1041, 1042, 1043, 1062,	MGA – 1004, 1005, 1006, 1017,	Sampo – 1004, 1006, 1137, 1138	1044, 1053, 1057, 1058, 1063,
1144	1018, 1043, 1067, 1068	Samsung – 1004, 1005, 1006, 1010,	1064, 1072, 1073, 1079, 1099
Fijitsu – 1040	Mitsubishi – 1004, 1005, 1006, 1017,	1013, 1017, 1086, 1087, 1088,	Yamaha – 1004, 1005, 1006, 1017
Funai – 1034, 1040	1018, 1043, 1067, 1068, 1069,	1137, 1138, 1156, 1178*	Zenith – 1001, 1004, 1122, 1123,
GE – 1003, 1004, 1006, 1018, 1044,	1102	Sansui – 1152	1124, 1125, 1158

RECEIVERS (*Test this code with the CH+ or CH- buttons)

Aiwa – 3000, 3001, 3002, 3003, 3004,	Kenwood – 3006	Philips – 3000	Technics – 3016, 3017
3014, 3020	Linn – 3000	Pioneer – 3012*	Wards – 3000, 3012*
Carver – 3000	Magnavox – 3000	RCA – 3007	Yamaha – 3010, 3011, 3012*
Harman Kardon – 3000, 3013	Marantz – 3000	Sansui – 3000	
JBL – 3013	Onkyo – 3015	Sherwood – 3019	
JVC – 3005	Panasonic – 3016, 3017	Sony – 3008, 3009, 3018	

LIST OF CODES

VCR

Admiral – 2035
Aiko – 2018
Aiwa – 2017
Akai – 2002, 2003, 2004, 2031, 2032
Audiovox – 2010
Beaumarck – 2024
Bell & Howell – 2007
Broksonic – 2008
Calix – 2010
Canon – 2014, 2015
Capehart – 2030
Carver – 2000
CCE – 2018, 2024
Citizen – 2009, 2010, 2011, 2012, 2013, 2018, 2045
Colorlyme – 2005
Craig – 2009, 2010, 2016, 2024
Curtis Mathes – 2005, 2009, 2012, 2013, 2014, 2015, 2025, 2046
Daewoo – 2011, 2017, 2018, 2030, 2045
Daytron – 2030
Dimensia – 2025, 2046
Electrohome – 2010, 2019
Emerson – 2002, 2008, 2010, 2011, 2014, 2017, 2019, 2026, 2032
Fisher – 2007, 2016, 2020, 2021
Fuji – 2003, 2014
Funai – 2017
Garrard – 2017
GE – 2001, 2009, 2014, 2015, 2025, 2046
Go Video – 2038, 2044

Goldstar – 2005, 2010, 2013
Gradiente – 2017
Harman Kardon – 2000, 2005
Harwood – 2024
Hitachi – 2022, 2023, 2029, 2031
JC Penney – 2005, 2006, 2007, 2008, 2009, 2010, 2014, 2015, 2022, 2023, 2024, 2029
Jensen – 2022, 2023, 2031
JVC – 2005, 2006, 2007, 2013, 2031, 2033, 2039
Kenwood – 2005, 2006, 2007, 2012, 2013, 2031, 2033
KLH – 2024
Kodak – 2020, 2014
LG – 2010
Logik – 2024
LXI – 2010
Magnavox – 2000, 2014, 2015, 2028
Marantz – 2000, 2005, 2006, 2007, 2012, 2013, 2014
Matsushita – 2014
Memorex – 2007, 2009, 2010, 2014, 2016, 2017, 2028, 2035, 2047
MGA – 2019, 2026, 2032
Minolta – 2022, 2023, 2029
Mitsubishi – 2019, 2022, 2023, 2026, 2032, 2033
Montgomery Ward – 2035, 2047
Motorola – 2014, 2035, 2047
MTC – 2009
Multitech – 2009, 2012, 2017, 2024
NEC – 2005, 2006, 2007, 2012, 2013, 2031, 2033
Nikko – 2010
Noblex – 2009
Olympus – 2014
Optimus – 2010, 2035, 2047
Optonica – 2027
Panasonic – 2014, 2015
Pentax – 2012, 2022, 2023, 2029
Pentex Research – 2013
Philco – 2014, 2015
Philips – 2000, 2014, 2027
Pioneer – 2006, 2022, 2033
Portland – 2012, 2030, 2045
Proscan – 2001, 2025, 2046
Quasar – 2014, 2015
Radio Shack – 2010, 2027, 2047
Radio Shack/Realistic – 2007, 2009, 2010, 2014, 2015, 2016, 2017, 2019, 2020, 2021, 2027, 2035
Radix – 2010
RCA – 2001, 2002, 2009, 2014, 2022, 2023, 2025, 2029, 2040, 2046
Realistic – 2007, 2009, 2010, 2011, 2014, 2015, 2016, 2017, 2019, 2020, 2021, 2027, 2035, 2047
Ricoh – 2034
Runco – 2028
Samsung – 2004, 2009, 2011, 2041
Sansui – 2006, 2031, 2033
Sanyo – 2007, 2009, 2016, 2042
Scott – 2008, 2011, 2026
Sears – 2007, 2010, 2014, 2016, 2020, 2021, 2022, 2023, 2029

Sharp – 2019, 2027, 2035, 2045, 2047
Shintom – 2003, 2023, 2024
Signature – 2035, 2047
Singer – 2014, 2024, 2034
Sony – 2003
STS – 2014, 2029
Sylvania – 2000, 2014, 2015, 2017, 2026
Symphonic – 2017
Tandy – 2007
Tashiko – 2010
Tatung – 2031
Teac – 2017, 2031
Technics – 2014
Teknika – 2010, 2014, 2017
Toshiba – 2011, 2020, 2022, 2026, 2032
Totevision – 2009, 2010
Unitech – 2009
Vector Research – 2005, 2006, 2011, 2012
Video Concepts – 2005, 2006, 2011, 2012, 2032
Wards – 2000, 2009, 2010, 2011, 2014, 2016, 2017, 2019, 2022, 2023, 2024, 2027, 2029, 2035, 2047
XR-1000 – 2014, 2017, 2024
Yamaha – 2005, 2006, 2007, 2013, 2031
Zenith – 2003, 2028, 2034, 2043

CD

ADC – 2166
Aiwa – 2151
Akai – 2167
Emerson – 2152
Fisher – 2153
GE – 2169
Hitachi – 2154

JVC – 2155
Kenwood – 2156
Marantz – 2158
Mistubishi – 2170
Nakamichi – 2172
NEC – 2157
Onkyo – 2159

Panasonic – 2160
Pioneer – 2161
RCA – 2162
Sanyo – 2175
Sears – 2168
Sherwood – 2173
Sony – 2163

Teac – 2174
Technics – 2164
Toshiba – 2171
Yamaha – 2165

DVD (*Test this code with the PLAY button)

Aiwa – 2057, 2070
Alpine – 2071
Apex – 2068, 2069, 2072, 2073
BOSE – 2140
Broksonic – 2074, 2148
Clarion – 2075
Classic – 2076
Daewoo – 2077
Denon – 2078, 2079, 2080, 2081
Emerson – 2082, 2083
Fisher – 2084
Funai – 2083
GE – 2048, 2085*, 2086
Go Video – 2141, 2147

GPX – 2087
Hitachi – 2056, 2088, 2089, 2090, 2091
JVC – 2050, 2058, 2092, 2142
Kenwood – 2093
Konka – 2059, 2060
Magnavox – 2051, 2094
Memorex – 2095
Miitek – 2096
Mitsubishi – 2052
NAD – 2082
Nakamichi – 2097
Norcent – 2098, 2099
Onkyo – 2100

Oritron – 2114
Panasonic – 2061, 2101, 2102, 2103, 2104, 2105, 2106
Philips – 2051, 2067, 2107
Pioneer – 2053, 2108, 2109, 2110, 2111
Proscan – 2048, 2112
Qwestar – 2113, 2114
RCA – 2048, 2049*, 2115, 2143, 2149
Sampo – 2116
Samsung – 2117, 2118, 2119, 2144
Sansui – 2120
Sanyo – 2062, 2121, 2145
Sharp – 2122, 2123

Sherwood – 2124
Sony – 2154, 2063, 2064, 2125, 2126, 2127, 2128, 2129
Sylvania – 2083
Teac – 2130
Technics – 2131
Techwood – 2132
Toshiba – 2055, 2065, 2133, 2134, 2135, 2150
Yamaha – 2136, 2137, 2138
Zenith – 2066, 2139, 2146

LIST OF CODES

REMOTE CONTROL SETUP CODES FOR UR5-8400A

TV

ADMIRAL – 025, 053	GO VIDEO – 132, 155, 040, 136	MTC – 034, 040	SANYO – 003, 014, 040, 134
AIKO – 117	GOLDSTAR/LG – 101, 004, 012	MULTITECH – 024, 034	SCOTT – 017, 037, 129, 131
AIWA – 034, 161, 101	HARLEY DAVIDSON – 034	NEC – 012, 023, 043, 048	SEARS – 003, 004, 008, 014, 017, 081, 101, 010, 031, 034
AKAI – 043, 046, 124, 146	HARMAN KARDON – 012, 045	NIKKO – 101	SHARP – 053, 031, 054, 159
AMERICA ACTION – 117	HARWOOD – 024	NOBLEX – 040	SHINTOM – 024
AMERICAN HIGH – 031	HITACHI – 004, 026, 034, 043, 063, 137, 150	NORDMENDE – 043	SHOGUN – 040
AMPRO – 072	HQ – 034	OLYMPUS – 031	SINGER – 024
ANAM – 031, 103	HUGUES – 004	OPTIMUS – 053, 101	SONY – 001, 057, 058, 003, 052, 053, 031, 154, 171, 009, 034
ASHA – 040	INSTANTREPLAY – 031	OPTONICA – 053, 054	SOUNDESIGN – 034
AUDIO DYNAMICS – 012, 023, 043	JCL – 031	ORION – 025	STS – 004
AUDIOVOX – 101	JCPENNEY – 004, 012, 031, 040, 101	PANASONIC – 031, 070, 133, 140, 163	SYLVANIA – 031, 034, 059, 067
BEAUMARK – 040	JENSEN – 043	PENTAX – 004, 031, 063	SYMPHONIC – 034
BROKSONIC – 035, 037, 129, 025	JVC – 048, 043, 055, 060, 130, 150, 152, 012, 031	PHILCP – 031, 034, 067, 025	TANDY – 034, 010
CALIX – 101	KEC – 101, 117	PHILIPS – 031, 034, 054, 067, 101, 150	TATUNG – 043
CANON – 028, 031	KENWOOD – 034, 150, 014, 048	PILOT – 101	TEAC – 034, 043
CAPEHART – 108	KLH – 024	PIONEER – 021, 004, 048	TECHNICS – 031, 070
CCE – 024, 117	KODAK – 031, 101	PORTLAND – 108	TEKNIKA – 031, 034, 101
CINERAL – 117	LLOYD – 034	PROFITRONIC – 040	THOMAS – 034
CITIZEN – 101, 117	LOGIK – 024	PROTEC – 024	TMK – 006, 040
COLT – 024	LXI – 003, 009, 017, 034, 101, 004	PULSAR – 072	TOSHIBA – 017, 131, 004, 008, 059, 082, 150
CRAIG – 003, 040, 135, 024, 101	MAGIN – 040	QUARTZ – 014	TOTEVISION – 040, 101
CURTIS MATHES – 031, 041	MAGNASONIC – 117	QUASAR – 031, 070, 133, 140, 163, 014	UNITECH – 040
CYBERNEX – 040	MAGNAVOX – 067, 031, 034, 068, 041, 156, 170	RADIO SHACK – 123, 034	VECTOR RESEARCH – 012
DAEWOO – 005, 108, 111, 117, 017, 065, 007, 010	MARANTZ – 067, 069, 012, 031	RADIX – 101	VIDEO CONCEPTS – 012, 034, 046
DAYTRON – 108	MARTA – 101	RANDEX – 101	VIDEOSONIC – 040
DBX – 012, 023, 043	MATSUI – 027, 030	RCA – 107, 109, 144, 041, 031, 004, 034, 040, 140, 147, 158, 053	WARDS – 003, 004, 017, 024, 031, 034, 040, 053, 054, 131
DYNATECH – 034, 053	MATSUSHITA – 031	REALISTIC – 003, 008, 014, 031, 034, 040, 053, 054, 101, 010	WESTINGHOUSE – 024, 025
ELECTROHOME – 059, 101	MEI – 031	RICO – 058	XR-1000 – 024, 031, 034
ELECTROPHONIC – 101	MEMOREX – 040, 101, 003, 014, 031, 034, 053, 072, 134, 139, 025	RUNCO – 072	YAMAHA – 012, 034, 043
EMERSON – 006, 029, 035, 037, 129, 153, 017, 025, 027, 031, 034, 036, 046, 101, 131, 138, 117	MGA – 045, 046, 059	SALORA – 014	ZENITH – 072, 034, 001, 058, 080, 101, 153, 048, 025
FISHER – 003, 010, 008, 009	MGN TECHNOLOGY – 040	SAMSUNG – 040, 017, 107, 109, 113, 115, 124	
FUJI – 031	MINOLTA – 004	SANKY – 053	
FUNAI – 034	MINOSHITA – 059, 061, 051, 004, 046, 045, 053	SANSUI – 043, 135, 048, 025, 034	
GARRARD – 034	MOTOROLA – 031, 053		
GE – 031, 072, 144, 147, 063, 107, 109, 040, 053			

DVD

AIWA – 004, 008	HITEKER – 246	NAD – 247	SHARP – 252
ALPINE – 221	INTEGRA – 002, 238	NAKAMICHI – 225	SONY – 001, 218, 007
APEX DIGITAL – 251, 246	KENWOOD – 216	ONKYO – 240	SYLVANIA – 006
ARCAM – 215	KLH – 016	OPTIMUS – 229	SYMPHONIC – 006
CYBERHOME – 220	KRELL – 011	PANASONIC – 228, 012	TATUNG – 224
DAEWOO – 220	LEXICON – 010	PHILIPS – 253, 237, 214, 003	TECHNICS – 228
DENON – 226, 241	MAGNAVOX – 254, 237	PIONEER – 255, 222, 229	THETA DIGITAL – 229
FUNAI – 006, 230, 231	MARANTZ – 253, 242	PROCEED – 245	TOSHIBA – 233, 244, 219, 013
VIDEO – 014	MCINTOSH – 217	PROSCAN – 230, 231	VENTURER – 015
GOLDSTAR/LG – 235, 250	MINTEK – 251	RC – 230, 231	YAMAHA – 249, 234
HARMAN KARDON – 243	MITSUBISHI – 227	SAMSUNG – 236, 248, 014	ZENITH – 250, 234, 235, 239
HITACHI – 223	MYRYAD – 224, 005	SANYO – 009	

RECEIVERS

- ADC – 200
 ADCOM – 072, 082, 092, 161
 AIWA – 025, 071, 104, 114, 170, 171, 091, 100
 AKAI – 139, 093
 AMC – 125, 126, 127, 128
 ANGSTROM – 142
 ARCAM – 141
 AUDIO ACCESS – 147
 AUDIO ALCHEMY – 135
 AUDIO FILE – 203
 AUDIO MATRIX – 077
 AUDIO TECHNICA – 134
 B & K – 096, 097
 BOSE – 070, 170, 113
 BRYSTON – 015
 CARVER – 003, 008, 028, 099, 151, 203, 014, 016, 040, 090
 CASIO – 204
 CHIRO – 140
 CINEMA SOUND – 084, 134
 CITATION – 148
 CLARION – 026
 CURTIS MATHES – 204
 DENON – 084, 151, 155, 188, 056, 119
 ENLIGHTENED AUDIO – 049, 050
 FISHER – 151
 FOSGATE AUDIONICS – 062, 148
 GOLDSTAR/LG – 072, 006
 HARMAN KARDON – 153, 148, 162, 060, 066, 115 HITACHI – 020
 INKEL – 005
 JCPENNEY – 102, 204
 JENSEN – 058
 JVC – 013, 163, 176
 KENWOOD – 005, 026, 057, 166, 095
 KOSS – 102
 KRELL – 150
 KYOCERA – 200
 LEXICON – 120, 167, 171, 172
 LUXMAN – 035, 137, 139, 165, 004, 029
 LXI – 204
 MAGNAVOX – 152, 164, 191, 043
 MARANTZ – 028, 048, 063, 191, 090
 MCINTOSH – 173
 MCS – 204
 MERIDIAN – 009, 051
 MITSUBISHI – 180
 MONDIAL – 022, 023, 042, 073, 075
 NAD – 048
 NAKAMICHI – 111, 182, 183, 079, 087
 NEC – 080
 ONKYO – 084, 046, 012, 030, 041, 081, 103, 044
 OPTIMUS – 017, 036, 138, 026
 PANASONIC – 007, 088, 129, 130, 132, 195
 PARASOUND – 129, 130, 132
 PHILIPS – 063, 188, 189, 191
 PIONEER – 084, 039, 045, 054, 069, 078, 168, 128, 158
 PROCEED – 144
 QUASAR – 007, 088, 129, 130, 132, 195
 RCA – 010, 067, 117, 156
 REALISTIC – 019, 034, 037, 047
 ROTEL – 074, 083, 085
 SAMSUNG – 123
 SANSUI – 063, 110, 032, 116
 SANYO – 151
 SCOTT – 019
 SEARS – 204
 SHARP – 026, 057, 094, 175
 SHERWOOD – 024, 038
 SONY – 001, 011, 055, 187, 053, 112
 SOUNDESIGN – 036
 SSI – 068
 TEAC – 019, 059, 111, 109
 TECHNICS – 076, 088, 122, 193, 080, 098
 THETA DIGITAL – 065
 TOSHIBA – 033 112
 YAMAHA – 021, 026, 031, 067, 192, 002, 101, 118
 ZENITH – 143, 106

CUSTOMER SERVICE

CUSTOMER SERVICE

For more information on our packages or to change your subscription, please get in touch with Customer Service. Our agents are available between 7:30 a.m. and 9:30 p.m. Monday through Friday and between 8 a.m. and 6 p.m. on Saturday.

Montréal	514 281-1711
Québec City	418 847-4410
Saguenay	418 545-1114
Outaouais	819 771-7715
Elsewhere in Quebec	1 88-VIDEOTRON

CUSTOMER TECHNICAL SUPPORT

For problems of a technical nature, please contact Customer Technical Support. Our technicians are available 24 hours a day, seven days a week.

Montréal	514 841-2611
Québec City	418 842-2611
Saguenay	418 543-4611
Outaouais	819 771-2611
Elsewhere in Quebec	1 88-VIDEOTRON

Visit our Web site: videotron.com

CONTRACT

You can consult the subscription contract online by going to videotron.com/terms

High-Definition Setup

INTRODUCTION

SETUP

Refer to the appropriate section in order to configure your terminal. The settings you choose on your **HD** terminal will directly influence the picture quality you obtain. To configure them, follow the instructions in the Setup Wizard section on page 53 of this manual.

If you use **DVI** cables to connect your **HD** terminal to your TV, no further configuration is normally required. With this type of connector, the two devices automatically determine the optimal image resolution.

CONNECTORS

Three types of connector are available for **HDTV**: **HDMI**, **DVI cable** (on some models only) and **Component input**. You **must** use one of these two connector types to obtain an image when viewing channels broadcast in high definition. They are **recommended** for SD content as well, in order to minimize the number of motion artifacts.

CONVERTING IMAGE FORMATS

One of the golden rules for obtaining optimal image quality is to keep the number of signal conversions to a minimum. While programs can be broadcast in different formats, depending on the channel, your television displays them only in its native format. In other words, a program's format may vary, but your television's format always stays the same – which means your television will inevitably have to convert the format of programs broadcast outside its native format.

Nevertheless, the number of conversions can be kept to a minimum. The format adjustment option on HD terminals lets you avoid unnecessary conversions. This is why you should know your television's native format: you can then set these terminals to the same format as your TV, so it always receives signals without performing an extra conversion.

INTRODUCING THE SETUP WIZARD

WHAT IS THE SETUP WIZARD?

The HDTV Setup Wizard is an on-screen program that helps you set up your high-definition terminal to receive the best picture quality that the HDTV supports.

BEFORE YOU BEGIN

Before you begin to set up your HD terminal, you may want to have available the user's guide that came with your HDTV for reference.

IS IT NECESSARY TO USE THE SETUP WIZARD?

Yes. Whether you have used the component (**Y**, **Pb** and **Pr**), **DVI** or **HDMI** connectors to link your HDTV to the HD terminal, the Setup Wizard will provide your system with the necessary flexibility to ensure that you obtain the best picture quality you can get at all times.

Notes:

- The analog Y, Pb, Pr ports become inactive when the HDTV is connected to the DVI or HDMI port.
- If the HDTV is connected to the DVI or HDMI port on the back of the set-top and you see this alert message on the screen, it means that the HDTV and the set-top are not compatible. If this occurs, reconnect the set-top to the Y, Pb, Pr ports on the set-top.

DVI or HDMI Alert

Your HDTV does not support HDCP.
Please use the YPbPr component connection
to watch TV.

PICTURE FORMATS

WHAT IS THE DIFFERENCE BETWEEN A STANDARD SCREEN AND A WIDE SCREEN?

The type of screen your HDTV has (wide screen or standard screen) determines how the set-top displays programs on the screen. The picture format for an HDTV is a combination of aspect ratio and screen resolution and is different for standard-screen and wide-screen HDTVs.

WHAT IS AN ASPECT RATIO?

An aspect ratio is the ratio of the width to the height of the TV screen. The aspect ratios differ because the television industry manufactures both standard-screen and wide-screen HDTVs to appeal to consumer viewing preferences.

SETUP WIZARD

A standard-screen HDTV has a 4:3 aspect ratio. The screen is 4 units wide for every 3 units tall.

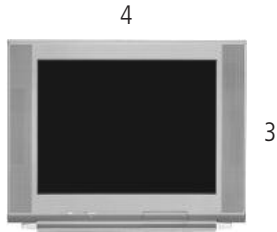

Aspect Ratio: 4:3
Screen Resolution:
480p or 480i fill the screen

A wide-screen HDTV is one-third wider than a standard-screen HDTV. The screen is 16 units wide for every 9 units tall.

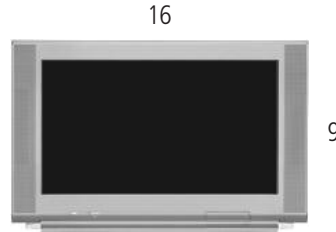

Aspect Ratio: 16:9
Screen Resolution:
720p or 1080i fill the screen

WHAT IS THE SCREEN RESOLUTION?

The screen resolution indicates the amount of detail that the picture displays. Resolution is identified by the number of display lines on the screen. The techniques that an HDTV uses to “paint” the picture on the screen are referred to as progressive and interlaced.

For example, a resolution of 1080i indicates that the screen shows 1080 lines in an interlaced display, and 480p means that the screen shows 480 lines in a progressive display.

Note: The screen resolution (1080i, 480p, etc.) is sometimes referred to as the scan rate. The terms are interchangeable.



With the **progressive method**, every pixel on the screen is refreshed simultaneously.



The **interlaced method** involves refreshing pixels in alternation – first the odd lines and then the even lines.

HOW DO I KNOW WHICH PICTURE FORMAT TO CHOOSE?

The type of screen your HDTV has determines how the set-top displays programs on the screen. The following examples show how programs will look when the picture format is set to **Normal** mode (not Stretch or Zoom modes).

Standard-screen HDTVs

**On a wide-screen HDTV,
these picture formats:**

480p or 480i standard



720p or 1080i wide



Automatically display in this manner:

Full-screen format



Letterbox format



SETUP WIZARD

Wide-Screen HDTVs

**On a wide-screen HDTV,
these picture formats:**

480p or 480i standard



720p or 1080i wide



Automatically display in this manner:

Pillarbox format



Full-screen format



SETTING UP YOUR HD TERMINAL WITH THE SETUP WIZARD

BEFORE YOU BEGIN TO SET UP YOUR HD TERMINAL USING THE SETUP WIZARD, THERE ARE TWO THINGS YOU NEED TO DO:

- Download the latest information to the set-top. (You only need to do this for the initial setup. After the initial set up, programming information is downloaded to the set-top automatically on a regular basis.)
- Prepare the set-top to send picture formats that your HDTV supports.

Download the latest programming information to the set-top

Assuming that you have linked your HDTV to the HD terminal using either the component (Y, Pb, Pr), DVI or HDMI connectors, complete the following steps to download latest software, programming, and service information to the set-top. (Be sure you have made a note of which video input port the set-top is connected to on the HDTV. For example: Video input port 6.)

Note: You only need to do this for the initial setup.

1. Plug the set-top and the TV into an AC power source.
2. Do not turn on the set-top or TV yet.
3. Wait until you see one of the following displays on the front of the set-top:
 - Current time
 - Four dashes (----)



Important: If the display shows activity on the set-top, it means that the operating system of the terminal is being updated: this process may take several minutes. When the update is complete, the front panel displays the current time or four dashes (----).

4. **STOP!** Before you turn on the TV or the set-top, you should have read the information in the Picture Formats section, earlier in this guide.

SETUP WIZARD

Prepare the set-top to send picture formats that your HDTV supports

If your HDTV displays a black screen when you turn it on, the set-top may be sending a picture format that your HDTV does not support. Prepare the set-top to send all picture formats that your HDTV supports. Later, while watching TV, you will be able to toggle among the different settings to select the format that provides the best picture quality for the program you are watching.

Complete these steps to prepare the set-top to deliver programming in the picture format settings that your HDTV supports.



Important: Before you start, read these instructions carefully. When you get to step 5, you have 20 seconds to begin selecting picture format settings. After 20 seconds, the set-top is no longer in the **Picture Format** mode. If this occurs, repeat this process, starting at step 2.

1. Refer to the user guide that came with your HDTV to find the picture formats that your HDTV supports.
2. If the set-top is turned off, press the **POWER** key to turn it on.
3. On the front of the set-top, press and hold the **SELECT** button until the message light blinks.
4. Then, press the **VOL-** key to indicate that you want to select a picture format setting. The LED display shows HdSr to indicate that the set-top is in the Picture Format mode for HDTV settings.
5. In the following table, find each of the picture formats that your HDTV supports. Then, press the corresponding buttons on the front panel of the set-top.

Note: If 1080i is one of the settings that your HDTV supports, we suggest you select it last. Then, when you turn on the TV to use the Setup Wizard, the picture format will be 1080i.

To select this picture format:	Press this button on the front panel:	The set-top briefly displays:	And then briefly displays:
480i	CH+	480i	SEt
720p	VOL-	720p	SEt
480p	CH-	480p	SEt
1080i	VOL+	1080	SEt

IS THERE MORE THAN ONE SETUP OPTION?

Yes. The Setup Wizard provides two options for selecting your screen type:

- If you choose the **Easy option**, the Setup Wizard automatically sets up the HDTV to receive programming in 1080i and 480i formats.
- If you choose the **Advanced option**, you can toggle through all the picture formats and select the formats that look best on the HDTV screen.

Note: Use the **▲**, **■** and **●** keys on the remote control to navigate through the Setup Wizard menus and options. You may want to have available the user guide that came with your HDTV for reference.

HOW DO I START THE SETUP WIZARD?

1. Make sure that the set-top is **off** and the HDTV is **on**.



2. Press the **GUIDE** and **INFO** keys at the same time.

SETUP WIZARD

1. Press **△** to start the setup.



2. Choose one of the following options:

- To choose the **Easy Setup** option, press **△**; then, go to the **Easy Setup Instructions** on page 61.
- To choose the **Advanced Setup** option, press **■**; then go to the **Advanced Setup Instructions**, on page 62.

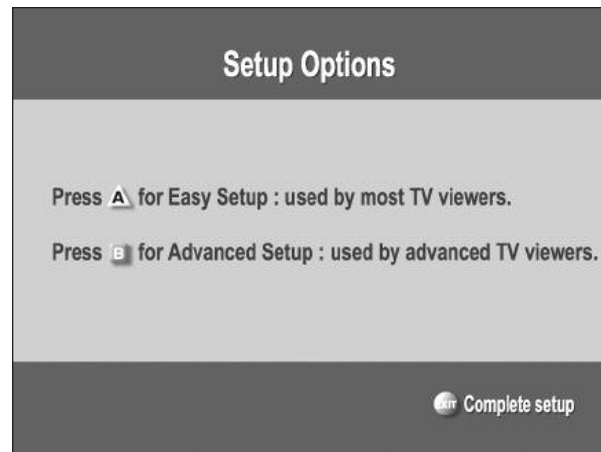

EASY SETUP INSTRUCTIONS

1. Press **▲** or **■** to select the type of TV screen you have.

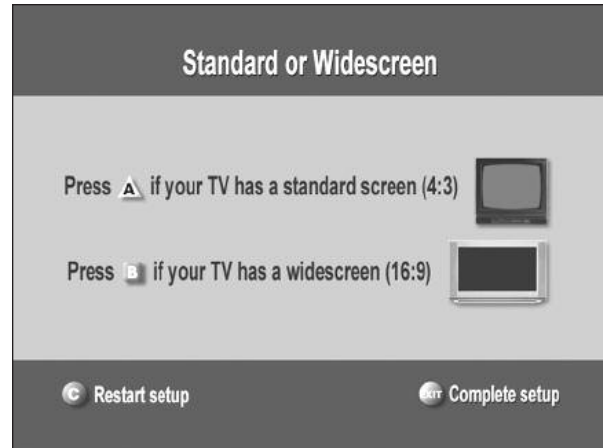

2. Press **POWER** to begin watching TV.

Notes:

- If you pressed **▲**, the setup is complete. The TV is set to receive programming in 1080i and 480i formats.
- If you pressed **■**, proceed to next page.

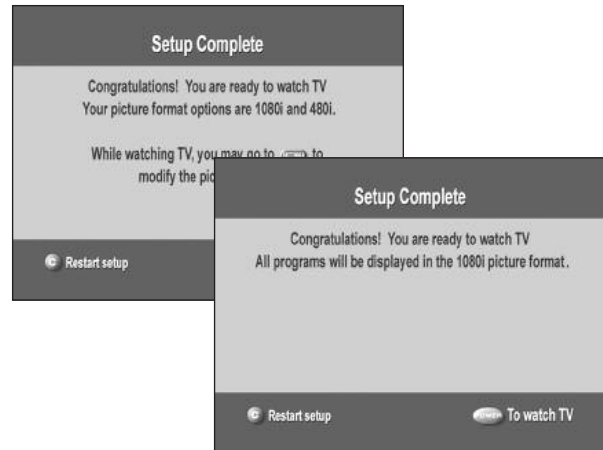

SETUP WIZARD

ADVANCED SETUP INSTRUCTIONS

1. Press **▲** or **■** to select the type of TV screen you have.

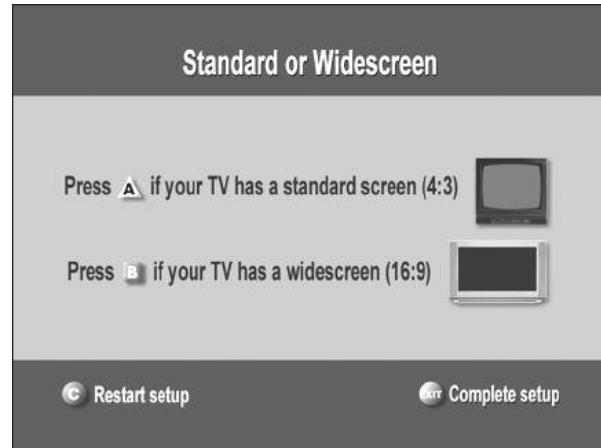

2. Press **▲** to see how various formats look on your TV screen.



3. Press **SELECT** to toggle between the Save and Remove options, or press **B** to see how the next format looks on your TV screen.

Important: If you see a black screen, press **B** again to view the next screen. Do not press **SELECT**. The black screen means that your TV does not support that particular format, so you do not want to select it.

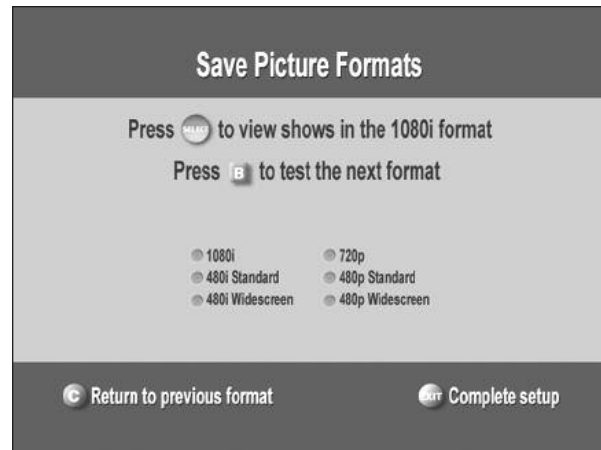

4. After saving the picture formats, press **EXIT**. The setup is complete.
5. Press **POWER** to begin watching TV.



SETUP WIZARD

CHANGING THE SETTINGS WHILE WATCHING TV

Some channels are high-definition (HD) and some are not. To maximize viewing of non-HD channels, you can toggle between an HD scan rate (either 1080i or 720p) and a standard-definition scan rate (either 480i or 480p).

HOW DO I CHANGE THE PICTURE SIZE?

Standard-screen HDTV:

maximize viewing on non-HD channels.



Note: HD-channel programs automatically fill the entire HDTV 16:9 screen.

Wide-screen HDTV:

maximize viewing of any channel



1. Press **SETTINGS** to access the **Quick Settings** menu.
2. Scroll to **Picture Format** or **Picture Size**. (You will see the Picture Format only if the Set Picture Format is set to **Fixed** in the **General Settings** menu.)
3. Press **◀** or **▶** to view the options.
4. As you scroll through the options, notice how the picture on the screen changes.
5. Select the picture size and/or format of your choice.

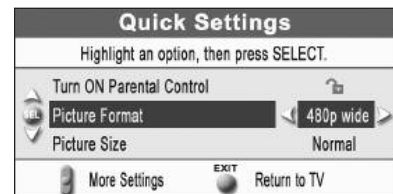

SETUP WIZARD

HOW CAN I CHANGE HOW THE PICTURE LOOKS ON MY TV?

Press **SETTINGS** twice to display the **General Settings** menu. Then, choose one of the following options:

Fixed — The screen resolution you selected from the Setup Wizard can be seen in the Quick Settings menu. The screen resolution remains the same (fixed) until you change it.

Pass-Through — This option provides a built-in convenience factor. The set-top attempts to convert the signal of an incoming program to the best picture format for your HDTV screen. However, if you have not selected all the screen resolutions that are available, the screen resolution defaults to the best selection available based on the selections you made in the HDTV Setup Wizard.

Upconvert 1 and Upconvert 2 — The operation of these two options is similar to that of the Pass-Through option. See the Display Formats For Digital Sources table below.

Auto DVI or HDMI — If your HDTV is connected through the DVI or HDMI output, you will see this option and not the Pass-Through option. Incoming programming is automatically formatted to the scan rate supported by your HDTV.

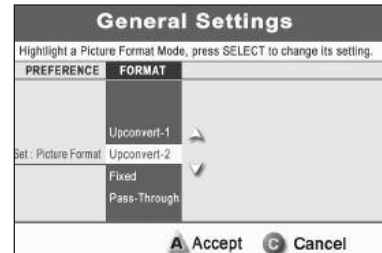

DISPLAY FORMATS FOR DIGITAL SOURCES

The following table illustrates the relationship between the format option you chose, the signal the set-top receives, and how the picture is displayed on the TV screen.

If you chose this picture format option:	When the set-top receives this type of signal:	The picture is displayed on the HDTV screen in this format:
Fixed	All formats	1080i, 720p, 480i, 480p (Depending on your selections made in the Setup Wizard and Quick Settings menu)
Pass-Through	480i 480p 720p 1080i	480i 480p 720p 1080i
Upconvert 1	480i/480p 720p/1080i	480p 1080i
Upconvert 2	480i/480p 720p/1080i	480p 720p

CLOSED-CAPTIONING

WHAT IS CLOSED-CAPTIONING?

Closed-captioning is text on the TV screen related to the programming being viewed. What you see is an abbreviated version of the actors' dialogue and indications of important background sounds. For sporting events, closed-captioning provides realtime play-by-play descriptions from the announcers. Closed-captioning is provided for those requiring assistance understanding and enjoying sound.

DOES MY TV SUPPORT CLOSED-CAPTIONING?

Many TVs support closed-captioning through the RF and baseband inputs. When your HDTV-to-set-top connection is through the YPrPb port or the DVI port, closed-captioning is decoded and displayed by the HD terminal.

WHO PROVIDES CLOSED-CAPTIONING?

Several companies (sources) provide closed-captioning service to television networks and production companies for standard (analog) and digital programming.

Closed-captioning sources for standard (analog) programming

- **Std CC1** is the primary caption service for non-digital programming.
- **Std CC2** through **Std CC4** are text services that may contain different information, including alternate languages.
- **T1** through **T4** are text services that may also provide additional information from the closed-caption provider.

Closed-captioning sources for digital programming

- **Digital 1** is the primary caption source.
- **Digital 2** is the suggested choice for alternate languages.
- **Digital 3** through **Digital 6** are undefined at this time.

CHOOSE A CLOSED-CAPTIONING SOURCE

1. Press **SETTINGS** twice to access the **General Settings** menu.
2. Scroll to **CC: Source**.
3. Press **▶** to access the STD (analog) and digital source options.
4. Scroll through the options and select the recommended sources: **Std CC1** and **Digital 1**.

CONTROL THE AUDIO VOLUME WHILE CLOSED-CAPTIONING IS TURNED ON OR OFF

1. Press **SETTINGS** twice to access the General Settings menu.
2. Scroll to **Audio:Volume Ctrl**. There are two setting options:
 - **Fixed** – The Fixed setting controls the audio volume through the TV and enables you to have closed-captioning turned on or off while listening to the programming audio.
 - **Variable** – The Variable setting controls the audio volume through the set-top and enables you to have closed-captioning turned on or off while listening to the programming audio, or you can have closed-captioning on while the set-top audio is muted.
3. **SELECT** either the **Fixed** or **Variable** setting.

TURN CLOSED-CAPTIONING ON AND OFF

You can turn closed-captioning on and off at any time through the Quick Settings menu.

1. Press **SETTINGS** to access the **Quick Settings** menu while watching TV.
2. Turn caption on or off.
3. If you chose the **Fixed** setting for the audio volume:
 - A. Scroll to **Caption Off/On**.
 - B. Press **▶** to access the options.
 - C. Scroll through the options and press **SELECT** to set your choice.
4. If you chose the **Variable** setting for the audio volume:
 - A. Scroll to **Caption Off/On/On with Mute**.
 - B. Press **▶** to access the options.
 - C. Scroll through the options and press **SELECT** to set your choice.

CHANGE THE LOOK OF CLOSED-CAPTIONING

Depending on the program or caption provider, you may or may not be able to change how the closed-captioning looks on the TV screen.

1. Press **SETTINGS** twice to access the **General Settings** menu.
2. Scroll to **CC: Options**.
3. Press **▶** to access the **CAPTION STYLE** column.
 - If you select the **Set by Program** option, the style is set by the caption provider for each program, and you cannot change the settings.
 - If you select the **Set by Viewer** option, you can use the instructions in the remainder of this section of the guide to change the caption styles.

Note: You may be able to change the appearance of closed-captioning on most HD channels and on some digital channels using the procedures in this section. Closed-captioning on analog channels and on most digital channels appears on the screen with white letters on a black background, and the format can not be changed.

SETUP WIZARD

CHANGE THE BACKGROUND SHADING AND COLOUR

The following instructions make the following assumptions:

- You have accessed the **General Settings** menu by pressing **SETTINGS** twice.
- The caption style setting in the **General Settings** menu is **Set by Viewer**.

Change the background shading

1. Scroll to **CC: Background**.
2. Press **▶** to access the **Shading** column.
3. Press **▲** and **▼** to scroll through the options. There are five background shading options:
 - **Clear** — allows video to be seen behind the captions
 - **Slight** — shows both the background and the video behind it
 - **Solid** — hides the video behind the captions
 - **Flashing** — a solid background turning on and off at a rate determined by the caption provider
 - **Default** — the background is determined by the caption provider
4. **SELECT** your choice.

Change the background colour

1. Scroll to **CC: Background**.
2. Press **▶** to access the **Colour** column.
3. Press **▲** and **▼** to scroll through the several colour options.
4. **SELECT** your choice.

CHANGE THE SHADING AND COLOUR OF THE CHARACTERS

The shading and colour options for the text (characters) is the same as for the background shading and colour.

Change the Character Shading

1. Scroll to **CC: Characters**.
2. Press **▶** to access the **Shading** column.
3. Press **▲** and **▼** to scroll through the options.
4. **SELECT** your choice.

Change the Character Colour

1. Scroll to **CC: Characters**.
2. Press **▶** to access the **Colour** column.
3. Press **▲** and **▼** to scroll through the options.
4. **SELECT** your choice.

CHANGE STYLE OF THE CHARACTERS

There are eight font styles to choose from, and they are numbered Style 1 through Style 8. The styles may not look the same on all TVs. Select the different fonts to see how they look on your TV.

Change the text style

1. Scroll to **CC: Characters**.
2. Press **▶** to access the **Style** column.
3. Press **▲** and **▼** to scroll through the options.
4. **SELECT** your choice.

Change the text size

1. Scroll to **CC: Options**.
2. Press **▶** to access the **Text Size** column.
3. Press **▲** and **▼** to scroll through the options (Small Text, Medium Text, Large Text, Default).
4. **SELECT** your choice.

RECORD HD PROGRAMS WITH CLOSED-CAPTIONING

If the program contains closed-caption information, it will be recorded by your VCR. When the tape is played back, turn on the closed-captioning feature on your TV to view the captions.

Note: An HD program records to your VCR in SD (standard definition) format.

FREQUENTLY ASKED QUESTIONS

WHAT IS HDTV? WHAT ADVANTAGES DOES IT HAVE OVER STANDARD DIGITAL TV ?

HDTV, or high-definition television, is a next-generation standard for digital television that gives you an image with superior resolution. Standard televisions display approximately 210,000 pixels, compared to over 2 million for top-end HDTV – a tenfold increase over traditional TV. Plus, HDTV enhances the home theatre experience by allowing for wider screens with aspect ratios of 16:9. Among other things, this can preserve a film’s original letterbox format.

IF I DON’T HAVE AN HDTV, WILL AN HD TERMINAL GIVE ME A SHARPER IMAGE?

No. Vidéotron’s HD terminals are perfectly backward compatible with traditional TV, but to take advantage of the higher resolution offered by HD broadcasts, your television must be physically capable of displaying the necessary number of pixels – and must be equipped with connectors that can carry this type of signal (Component/DVI/HDMI input).

TECHNICALLY, WHAT’S THE DIFFERENCE BETWEEN HDTV AND TRADITIONAL ANALOG SDTV?

There are several technical differences between standard, NTSC-format television and HDTV. (Technology varies widely even among HDTVs: CRT, LCD, Plasma, DLP, etc.)

TVs project programs onto their screens in the form of tiny picture elements, or pixels: 480 lines of pixels make up the picture on a standard analog TV. In comparison, HDTV images use 720 or 1080 lines, which results in much sharper detail and general picture resolution.

This also lets the image be “painted” in different ways. On an SDTV, the screen is painted using interlaced scanning, meaning that each of the 30 images appearing on screen each second is made up of two half-images: one each for the odd and even lines. HDTV can use either interlaced or progressive scanning (the latter changes the entire image from the first to last line up to 60 times a second).

The two HDTV formats:

720p	720 lines of horizontal resolution and progressive scan
1080i	1080 lines of horizontal resolution and interlaced scan

WHICH IS BETTER, 720P OR 1080I? HOW DO THESE COMPARE WITH DVDS OR THE TRADITIONAL DIGITAL TERMINAL FORMAT?

Progressive scan provides superior results compared to interlaced scan, the main difference being that interlaced scan’s alternating lines are more readily visible to the naked eye.

While a 720p image contains fewer pixels than a 1080i image, it also can be refreshed more quickly, making it the better choice for programs featuring a lot of movement, such as sports broadcasts.

To compare: both SDTV and DVD images use 480 horizontal lines with interlaced scan (480i). So-called progressive scan DVD players provide images in 480p format, resulting in better picture quality.

WHAT'S THE RESOLUTION ON VIDÉOTRON'S HD CHANNELS? CAN I CHOOSE THE RESOLUTION OF THE SIGNAL I RECEIVE?

Television stations decide which format a program will be broadcast in – although this doesn't mean all of a station's programs will necessarily be broadcast in the same format.

It's important to make the distinction between the image resolution you receive from a station, and the format your television displays it in. For example: if a station broadcasts a program at 480i and you have a 1080i TV, it will convert the image to a uniform 1080 on-screen lines by filling in the missing pixels. The program's "real" resolution, however, stays unchanged at 480i.

CAN I RECORD AN HD PROGRAM USING MY VCR?

Some Vidéotron HD terminals let you record HD programs on your VCR. Of course, the VCR will have to decrease the resolution in order to record it, so the recording will be in standard format. To preserve image resolution when recording an HD program, it is suggested you use Vidéotron's 8010 HD PVR.

I'VE NOTICED SEVERAL CAPTIONING OPTIONS IN MY HD TERMINAL'S GENERAL SETTINGS, SUCH AS FONT SIZE AND COLOUR. WHY ARE MY CAPTIONS ALWAYS IN BLACK AND WHITE?

Make sure the Captioning Options in your General Settings are set to Personalized. Custom font size and colour are only available for programs broadcast using the new digital captioning standard, EIA-708B. Programs broadcast using the old captioning standard, 608, do support captions, but only in black and white. A program's captioning standard is decided by the television station.

WHAT DOES AN HDTV'S "NATIVE FORMAT" REFER TO?

As you know, digital television programs can be broadcast in a variety of formats (480i, 480p, 720p, 1080i, etc.) – but TVs are designed and built to display images in only one of these formats. This format is the TV's native format. This is why HDTVs must be equipped to convert the formats of the programs they receive.

HDTVs are often classified according to their native formats. Today's models are designed to display images at either 720p or 1080i. If an LCD TV with a native format of 720p receives a signal from a television station at 480i, it converts it to its native format: 720p. To do this, it "fills in" the incoming image's missing pixels, bringing it up to its display capacity. The resulting image will always be in the same format: your TV's native format.

