

POWER ARCADE™ **COSMIC COMMANDER™**

GAME PLAY INFORMATION

With Cosmic Commander Control you are piloting a Class 1 Starfighter deep in a far-off solar system. You have entered a complex maze of subterranean tunnels with no way to turn back. Follow your onboard computerized map through a Survival Run. Conserve and restore your energy level and score points as you defend yourself against alien guards and their force fields. Your Cosmic Commander Control instantly responds to every move you make to deliver precision control and pinpoint firing accuracy. You're in total command of all the screen action as you take off on the ultimate space adventure.

A copyright protection is claimed on the program stored within the cartridge.

© 1983 by Milton Bradley Co. under Berne & Universal Copyright Conventions.
Made in U.S.A.

CONTENTS

- 1 controller console
- 1 video game cartridge
- 2 label sheets
- 4 rubber feet
- 1 instruction booklet
- 1 gunsight

HOW TO SET UP COSMIC COMMANDER

1. **Connection of Video Game System:** Connect your video game system to your television following the manufacturer's instructions. **Please Note:** Cosmic Commander is compatible with Atari® 2600™ ColecoVision™ with Expansion Module for Atari®, and Sears Tele-Games® Video Arcade™.

2. Preparation of Cosmic Commander:

A. BATTERY INSERTION: Four "D" size batteries are required to power the special effects (lights and vibrations) of Cosmic Commander. To insert batteries, carefully turn Cosmic Commander upside down. Open up the battery compartment door by gently lifting up the latch and sliding it over the stop. Then slide the door out from under the tabs as shown in Figure 1.

FIGURE 1

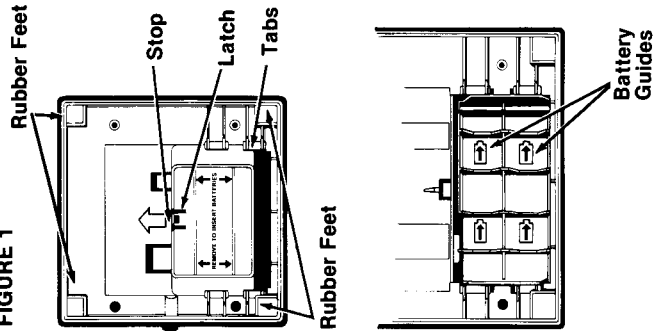

Lift off the door and insert the four batteries into the compartment using the arrangement of the four battery symbols molded into the bottom of the compartment as a guide. To replace the door, slide it under the tabs until the latch snaps into place.

FIGURE 2

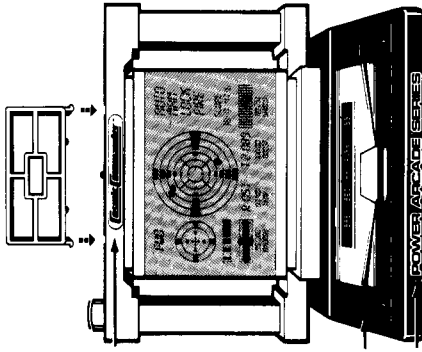

B. Insert the gunsight into the two holes on top of Cosmic Commander and gently press into place as shown in Figure 2.

2. **C. LABEL APPLICATION:** peel off the three Cosmic Commander Control labels from the label sheet and apply them to the unit as shown in Figure 2.

2. Remove the front lens as shown in Figure 3A. To do so, insert your fingers into the grooves on both sides of the lens and gently pull the lower tabs out of the lower slots. Then, remove the lens by sliding the upper tabs out of the upper slots.

FIGURE 3A

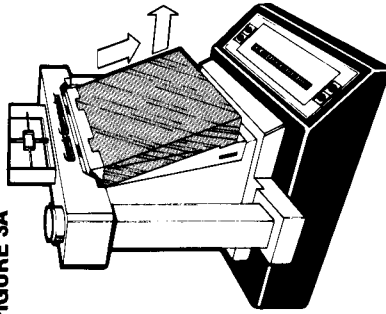

Attach the control panel label to the back of the lens so the dials and headings can be read through the front of the lens. This label has pressure sensitive adhesive along the outside edge. After the label is in position, press along the outside edge with your finger to secure firmly as shown in Figure 3B.

FIGURE 3B

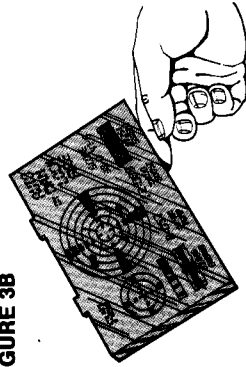

To replace the lens, slide the upper tabs into the upper slots and gently press the labeled lens into place until the lower tabs snap into the lower slots.

Also, peel off the Survival Run cartridge name label from the label sheet and apply it to the cartridge end panel with the top of the label toward the pre-labeled side as shown in Figure 4.

D. **RUBBER FEET:** peel off the four rubber feet from the strip and attach them to the bottom of the unit as shown in Figure 1 on the inside front cover.

FIGURE 4

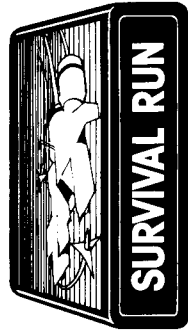

3. Carefully plug the Cosmic Commander cable into the LEFT joystick port as labeled on your video game system console. The cable is designed to fit only one way so do not try to force it into the port. Match the pattern of the holes in the plug to the pins in the receptacle.

4. Cosmic Commander Bulb Replacement:

- If the bulb burns out, here's how to change it: Carefully unplug the Cosmic Commander cable from the left joystick port of your video game system console.
- Remove the lens from the unit as shown in Figure 3A on page 3.
- Unscrew the old bulb by turning it counterclockwise then remove it from the socket. Replace the old bulb with a new G.E. #14, clear, 2.5 volt, screw base bulb. Screw the new bulb into the socket by turning it clockwise.
- To replace the lens, slide the upper tabs into the upper slots and gently press the lens into place until the lower tabs snap into the lower slots.
- Carefully plug the Cosmic Commander cable back into the left joystick port of your video game system console.

NOW YOUR COSMIC COMMANDER CONTROL IS READY FOR ACTION. ALL SYSTEMS ARE "GO"... YOU'RE READY TO MAKE YOUR SURVIVAL RUN!

SURVIVAL RUN™ INSTRUCTIONS

Powerful aliens have assembled an awesome strike force to destroy Earth. Grab the controls of your starfighter and attack the enemy fortress, lying deep inside a distant planet. Fly through the maze of subterranean caverns at hyperspeed, following your onboard computer map for navigation. Fire your photon torpedoes to zap enemy force fields and mauling alien guards as you race toward the ultimate showdown against the Alien Master in his command ship.

OBJECT OF THE GAME

Maneuver through the maze of tunnels, shooting alien guards, force fields, and the alien command ship to score the most points.

HOW TO SET UP THE GAME

- Cartridge Insertion:** make sure the Power Switch on your video game system is OFF. Hold the cartridge so the large Survival Run label on the top panel is towards you and reads right side up, then carefully insert the cartridge into the cartridge slot. Make sure the cartridge is fully inserted in the slot, but do not try to force it. **Please Note:** when removing the cartridge, turn the Power Switch OFF, then carefully pull the cartridge straight out of the slot.
- Turn your TV on and slide the Power Switch ON. You'll hear a short series of musical notes. Adjust the volume control on your television set to the desired level. Also, the entrance to the first tunnel appears on your TV screen.

3. **Skill Levels:** there are five different skill levels, numbered 1 through 5. When you slide the Power Switch on, the game is on skill level 1. This number is displayed at the top of the screen. Skill level 1 is the easiest because your starfighter is flying the slowest. Skill level 5 is the hardest because your starfighter is flying the fastest. To change the skill level, depress the Game Select Switch. Each time you depress it, the skill level increases by 1 until it reaches 5, then it returns to 1. **Please Note:** the skill level cannot be changed during a game.

NOW YOU BLAST OFF TO ADVENTURE!

HOW TO PLAY THE GAME

1. **Starting the Game:** press the fire button on your Control to start the game.
2. **Your Energy Level:** at the start of the game, the energy cells of your Starfighter are fully charged. Your energy level is displayed on the screen by the black dot on the green energy bar above your score. As you lose energy the dot moves across the bar to the left. If your energy level falls to 50%, the bar will turn yellow to caution you. If your energy level falls to 25%, the bar will turn red to warn you. You lose energy when your Starfighter is hit by a force field or shot by an alien guard or the alien command ship. Also you lose energy each time you shoot your laser cannon or your gunsight touches a side wall in a tunnel. You gain energy each time you successfully complete a tunnel in the maze. If you successfully navigate the entire maze and destroy the alien command ship, your energy cells will be fully recharged.

3. **The Computer Map:** the computer map at the top of the screen shows the interconnecting maze of underground tunnels within the alien planet. Refer to Figure 5 to see an example of a computer map. The blinking white dot is your position in the maze. You must travel from the left side of the maze to the right side. As you fly your starfighter through the tunnels, the dot moves to show your changing position in the maze. There is only one safe route through the maze so be very careful.

FIGURE 5

The blinking dot shows your position in the maze.

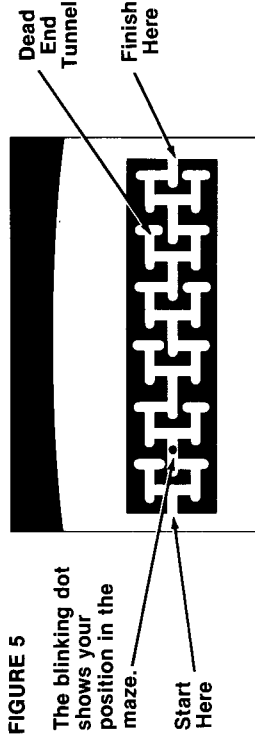

When you approach the intersection at the end of each tunnel as shown in Figure 6, you must decide whether to take the tunnel to the right or the tunnel to the left. If you hit the divider between the two tunnels or if you make the wrong choice and fly into a dead end tunnel, you will crash. Use this computerized map as your guide as you navigate through the maze. Check it before you reach an intersection so you'll know which way to turn.

FIGURE 6

Left Turn
Gunsight
Divider
Score

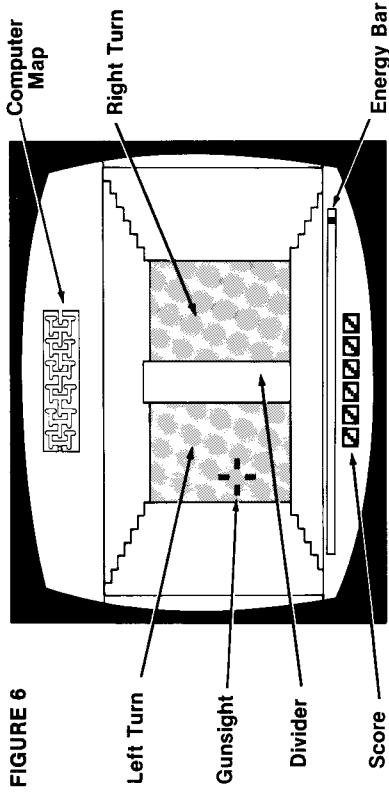

6. **Shooting Alien Force Fields:** alien force fields appear at the far end of the tunnel and move toward you, emitting a loud sound. The only way to destroy a force field is to shoot its source which is the small box that floats near the wall on either the right side or the left side of the force field as shown in Figure 8. When you shoot the source, the force field is instantly vaporized. If the force field hits the deflector shields of your starfighter, it drains energy from your energy cells.

FIGURE 8

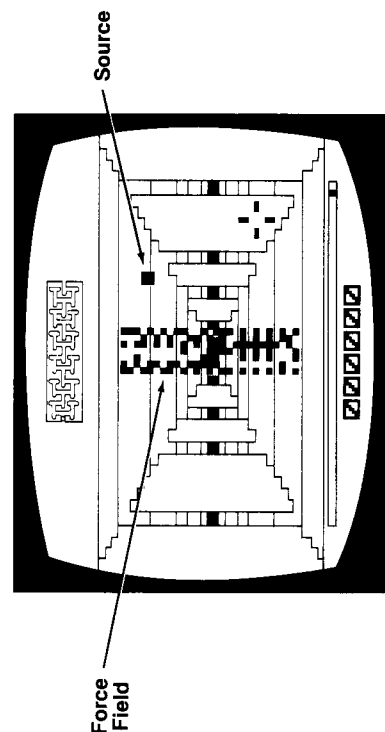

4. **Flying Your Starfighter:** the screen shows your view of the tunnels from the cockpit of your starfighter. You can sense your tremendous speed from the way the walls, ceiling and floor of the tunnel rush toward you. Your starfighter always flies through the center of a tunnel. The cross-shaped gunsight on the screen shows the direction in which your laser cannon is aimed. To move the sight to the left, turn your Control to the left. To move the sight to the right, turn your Control to the right. Pull your Control back to move the sight toward the floor of the tunnel. Push your Control forward to move the sight toward the ceiling of the tunnel. When you approach the intersection at the end of each tunnel, aim the sight in the direction that you want to fly. For example, if you check your computer map and see that you must make a right turn at the next intersection, aim the sight toward the entrance to the tunnel on the right side of the divider when you approach the intersection.

5. **Shooting Alien Guards:** your fire button is on top of the left handgrip of your Control. Press it to shoot photon torpedoes from your laser cannon. You can shoot single shot or rapid-fire. Each shot drains energy from your energy cells. Use the cross-shaped gunsight on the screen to aim your laser cannon. Alien guards appear at the far end of the tunnel and move toward you. Maneuver your gunsight so the alien guard is in the center of the sight, then fire. You'll see a photon torpedo shoot directly ahead of you into the center of the cross shape as shown in Figure 7. When you shoot an alien guard, he is instantly vaporized.

FIGURE 9

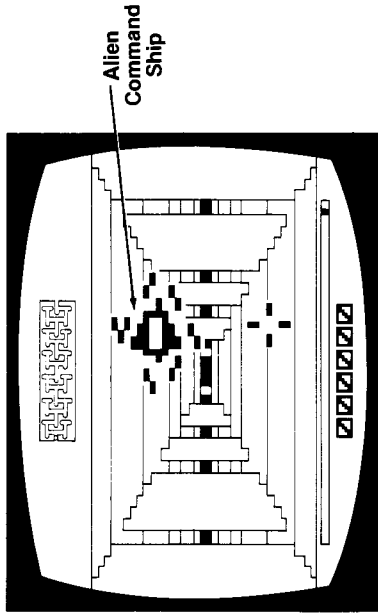
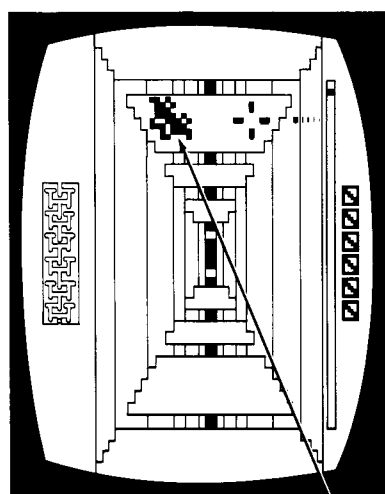

FIGURE 7



Alien guards have short-range laser guns so be careful. If you let them get too close, they'll shoot at you. Each shot that hits the deflector shields of your starfighter drains energy from your energy cells.

Alien Guard

IN CASE OF DIFFICULTY

In the event that you have difficulty with your Cosmic Commander Control or Survival Run cartridge, disconnect them from your video game system console. Replace them with another cartridge and joystick controller and operate your system. If the difficulty continues to appear, consult your video computer system owner's manual.

If the difficulty disappears, reconnect the Cosmic Commander Control and Survival Run cartridge, following carefully the directions for setup on the inside front cover of these instructions. If the difficulty persists, refer to warranty information on page 12.

IMPORTANT CAUTIONS

- Always turn the Power Switch on the console OFF before inserting or removing Survival Run or any other game cartridge.
- Don't try to force the cartridge into the console.
- Your Survival Run cartridge is protected from normal wear with a sturdy plastic cover. However, care should be taken not to spill liquids on the cartridge.
- Always check to see that the Cosmic Commander cable is firmly seated into the LEFT joystick controller port of your video game system console.

If you have questions or need assistance, call Milton Bradley Company, Customer Service Department, at the following toll-free number: dial: 1-800-628-8608 (not available in Hawaii or Alaska) and ask for Power Arcade assistance. In Massachusetts call collect 1-413-525-6411. These lines operate from 8:00 a.m. to 4:30 p.m., Eastern time, Monday to Friday.

7. Shooting the Alien Command Ship: if you successfully navigate the entire maze, you will confront the Alien Master in his Command Ship as shown in Figure 9. You must shoot the command ship many times to destroy it. The command ship has a powerful laser gun so watch out. If it shoots you, it drains large amounts of energy from your energy cells.

8. If you complete an entire maze and destroy the alien command ship, you'll be warped to the start of a new and tougher maze and your energy cells will be fully recharged.

9. Scoring: your score is displayed at the bottom of the screen. Every target you destroy and each tunnel you successfully navigate adds to your score. The chart below shows points awarded for destroying targets on each skill level.

	Tunnel Navigated	Alien Guard Destroyed	Force Field Destroyed	Command Ship Destroyed
Level 1	80	300	600	6000
Level 2	80	400	700	7000
Level 3	80	500	800	8000
Level 4	80	600	900	9000
Level 5	80	700	1000	10,000

10. End of Game: The game is over if you crash in a dead end tunnel OR run out of energy.

11. Depress the Game Reset Switch and press the Fire Button to start a new game at any time.

Atari® is a registered trademark of ATARI, INC.
Tele-Games® is a registered trademark of Sears, Roebuck & Co.

2600™ is a trademark of ATARI, INC.
VIDEO ARCADE™ is a trademark of Sears, Roebuck & Co.
ColecoVision™ is the trademark of Coleco Industries, Inc.

**90 DAY LIMITED WARRANTY ON
COSMIC COMMANDER/SURVIVAL RUN**

Cosmic Commander/Survival Run is warranted by Milton Bradley Company to the original purchaser for a period of 90 days from the original purchase date under normal use and service against defective workmanship and materials (batteries excluded).

This warranty is void if Cosmic Commander/Survival Run has been damaged by accident or unreasonable use, neglect, misuse, abuse, improper service or other causes not arising out of defects in workmanship or materials.

Milton Bradley shall not be liable for loss of use of Cosmic Commander/Survival Run or other incidental or consequential costs, expenses or damages incurred by the purchaser. Some states do not allow the exclusion or limitation of incidental or consequential damages, so the above limitation or exclusion may not apply to you.

During the warranty period, if found to be defective due to workmanship or materials, Cosmic Commander/Survival Run will either be repaired or replaced with a reconditioned product of an equivalent quality (at Milton Bradley's option) without charge to the purchaser when returned with proof of purchase date, shipping prepaid to the address listed below. In the event that Cosmic Commander/Survival Run is replaced, the warranty on the replacement will be continued for 90 days.

This warranty gives you specific legal rights and you may also have other rights which vary from state to state.

POST WARRANTY REPAIR POLICY—COSMIC COMMANDER

After the 90 day warranty period has expired, Milton Bradley shall, for a period of one year from the date of purchase, either repair your Cosmic Commander or replace it with a reconditioned product on the condition that you return your product, shipping prepaid, to the address listed below along with proof of purchase date and your check or money order in the amount of \$7.50. Milton Bradley shall not be obligated to perform this service if Cosmic Commander has been abused, misused, improperly serviced or damaged due to accident.

MAILING INSTRUCTIONS

If the original packaging is available, repack Cosmic Commander/Survival Run in its packing and box. If not available, wrap carefully, making sure to surround the product with adequate padding. Please include a brief description of the problem, your return address and mail postage prepaid and insured to the following address.

**Milton Bradley Company
Attn: Electronic Warranty Repair
108 Industrial Drive
East Longmeadow, MA 01028**

POST WARRANTY CARTRIDGE REPLACEMENT POLICY—SURVIVAL RUN

Replacement cartridges may be purchased from Milton Bradley. Tell us the name of the cartridge you wish to order and send a check or money order in the amount of \$20.00 for each cartridge to:

**Customer Service
Milton Bradley Company
443 Shaker Road
East Longmeadow, MA 01028**