

## TO PLAY

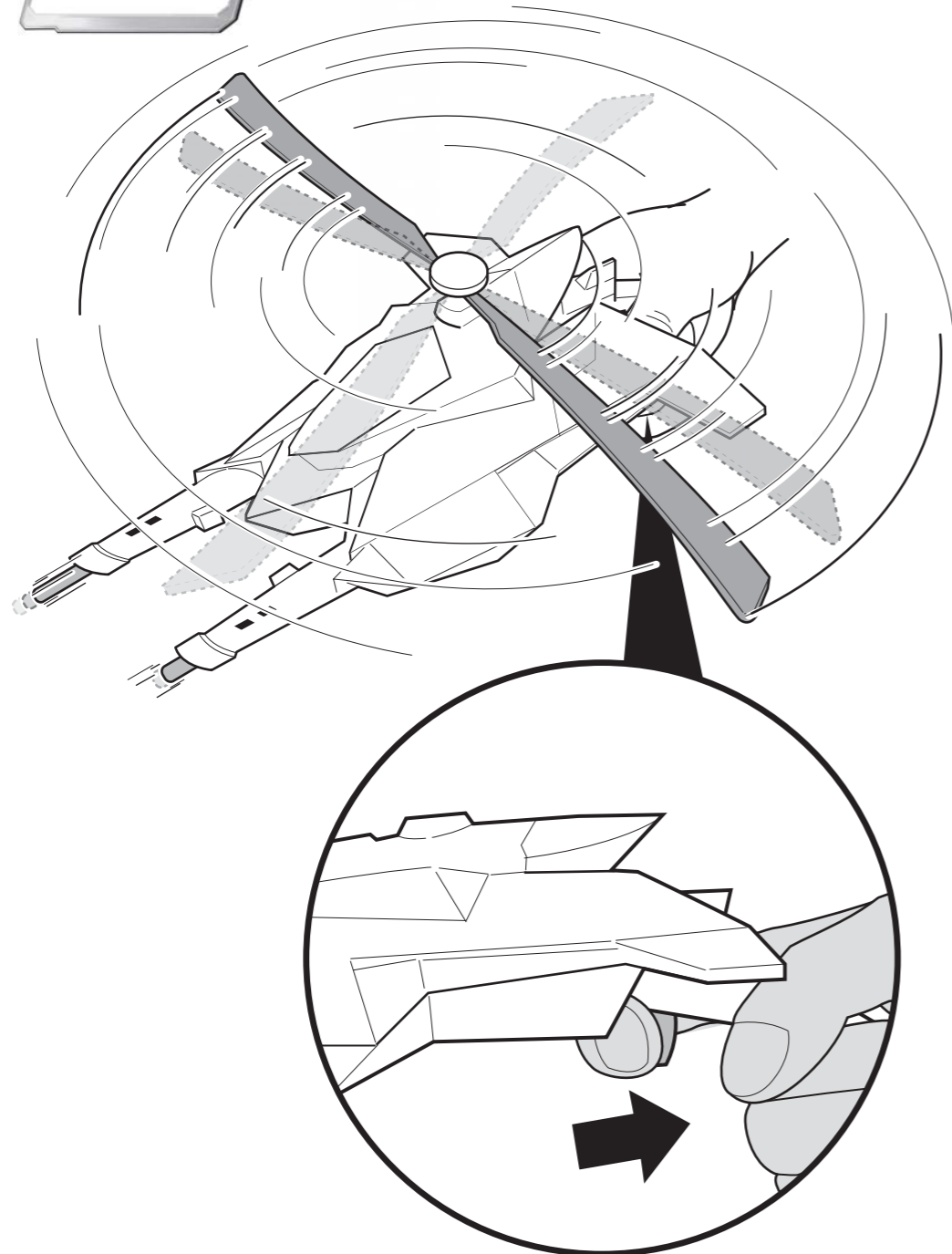

## INSTRUCTIONS

4+

Please keep these instructions for future reference as they contain important information.

## CONTENTS

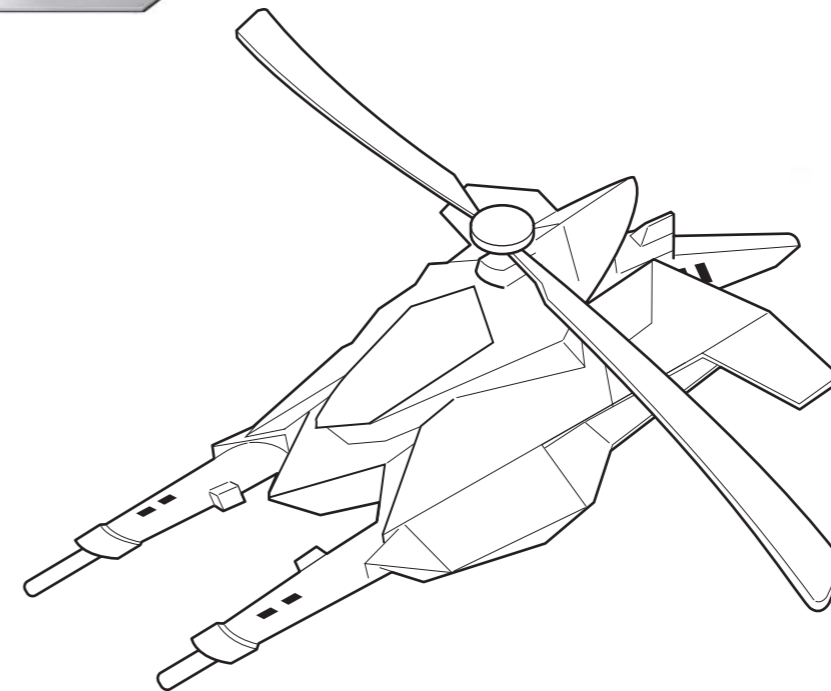

### INSTRUCTION SHEET SPECIFICATIONS

Toy: BM DK HELI JET  
Toy No.: M5071  
Part No.: 0920  
Trim Size: A5  
Folded Size: A6  
Type of Fold: 2  
# colors: One  
Colors: Black  
Paper Stock: White Offset  
Paper Weight: 70 lb.  
EDM No.: \_\_\_\_\_

Mattel, Inc. All Rights Reserved. Mattel, Inc. 333 Continental Blvd., El Segundo, CA 90245 U.S.A. Consumer Relations 1 (800) 524-8697. • Mattel Canada Inc., Mississauga, Ontario L5R 3W2. You may call us free at 1-800-524-8697. • Mattel U.K. Ltd., Vanwall Business Park, Maidenhead SL6 4UB. Helpline 01628500303. • Mattel Australia Pty Ltd., Richmond, Victoria. 3121. Consumer Advisory Service - 1300 135 312. • Mattel East Asia Ltd., Room 1106, South Tower, World Finance Centre, Harbour City, Tsimshatsui, HK, China. • Diimport & Diedarkan Oleh: Mattel SEA Ptd Ltd.(993532-P) Lot 13.5, Menara M5071-0920 Asst. M1110 Lien Hoe, Persiaran Tropicana Golf Country Resort, 47410 PJ. Tel:03-78803817, Fax:03-78803867.

 BATMAN and all related characters and elements are trademarks of and © DC Comics. (s08)

[service.mattel.com](http://service.mattel.com)



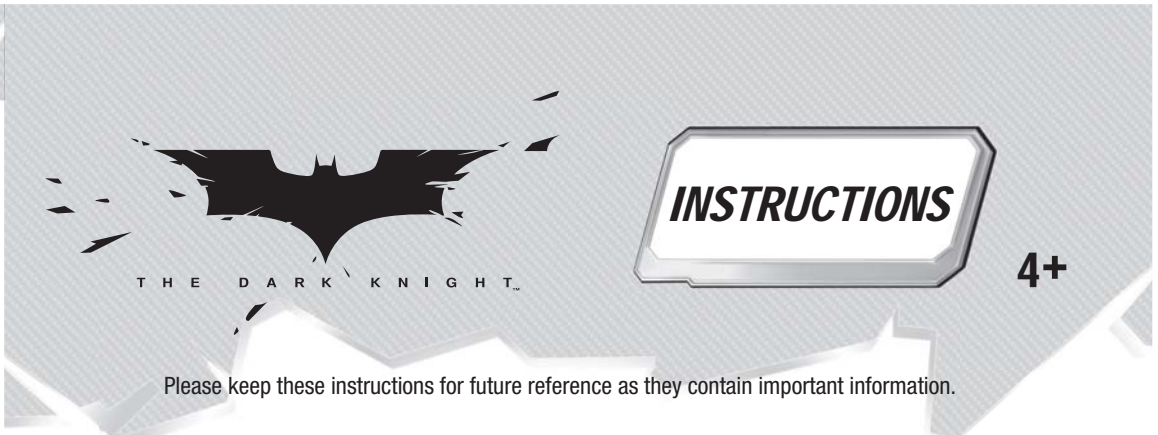

# INSTRUCTIONS

4+

Please keep these instructions for future reference as they contain important information.

## CONTENTS

INSTRUCTION SHEET SPECIFICATIONS	
Toy:	BM DK BAT TRACKER
Toy No.:	M5072
Part No.:	0920
Trim Size:	A4
Folded Size:	A5
Type of Fold:	
# colors:	One
Colors:	Black
Paper Stock:	White Offset
Paper Weight:	70 lb.
EDM No.:	

**3.**

Do not aim at eyes or face.  
Only use projectiles supplied with this toy.  
Do not fire at point blank range.

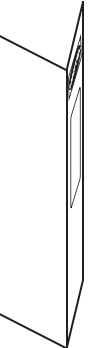
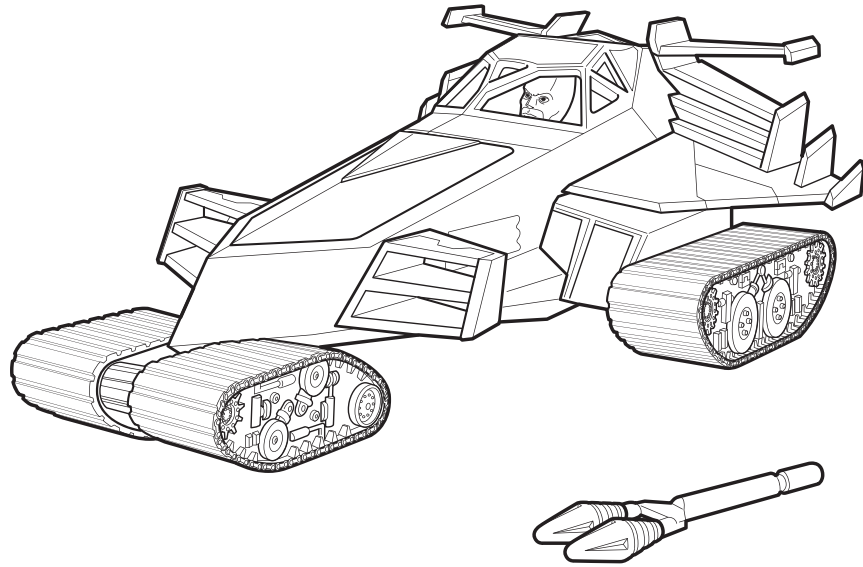
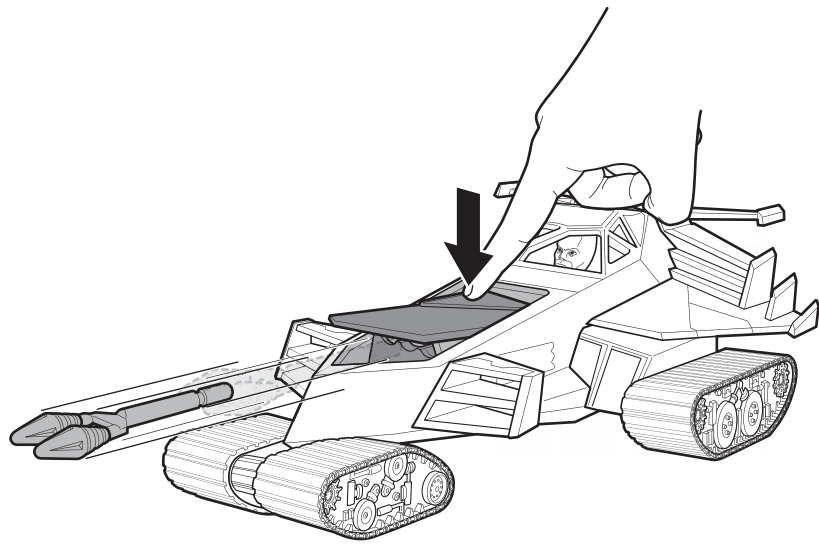

Mattel, Inc. All Rights Reserved. Mattel, Inc., 333 Continental Blvd., El Segundo, CA 90245 U.S.A. Consumer Relations 1 (800) 524-8697.  
 • Mattel Canada Inc., Mississauga, Ontario L5R 3W2. You may call us free at 1-800-524-8697. • Mattel U.K. Ltd., Vanwall Business Park, Maidenhead SL6 4UB, Helpline 01628500303. • Mattel Australia Pty Ltd., Richmond, Victoria, 3121. Consumer Advisory Service - 1300 135 312. • Mattel East Asia Ltd., Room 1106, South Tower, World Finance Centre, Harbour City, Tsimshatsui, HK. M5072 -0920 Asst.M1110  
 China. • Diimport & Diedarkan Oleh: Mattel SEA Ptd Ltd.(993532-P) Lot 13.5, Menara Lien Hoe, Persiaran Tropicana Golf Country Resort, 47410 PJ. Tel:03-78803817, Fax:03-78803867.

BATMAN and all related characters and elements are trademarks of and © DC Comics. (s08)



service.mattel.com

## TO PLAY 1

**1.**

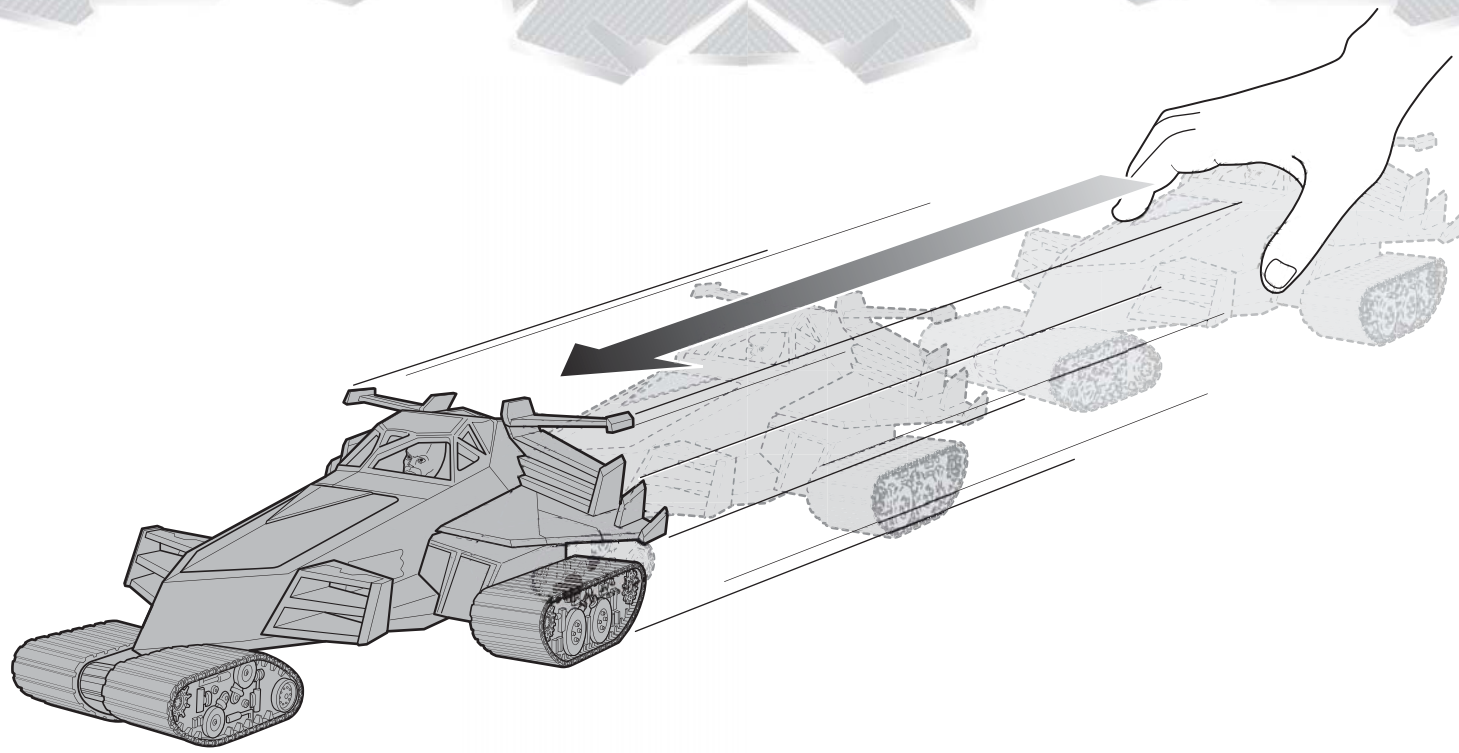

## TO PLAY 2

**1.**

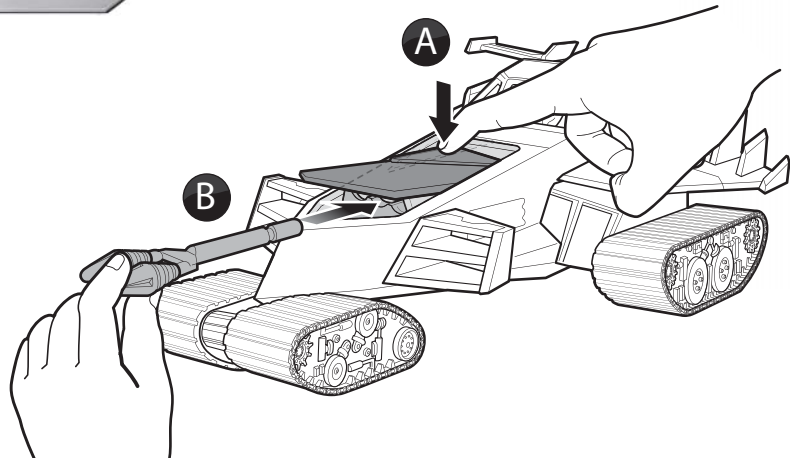

**2.**

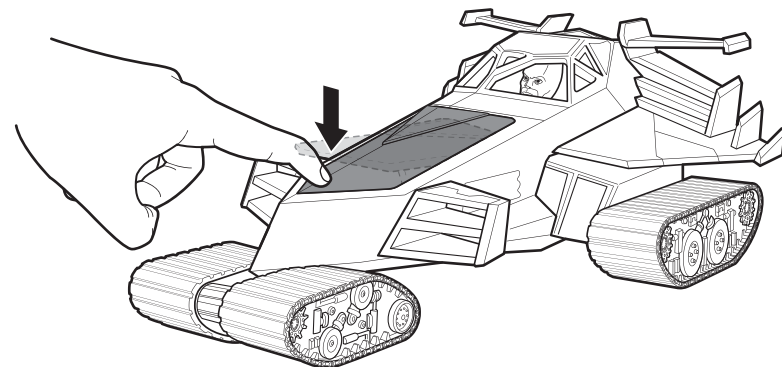

2.

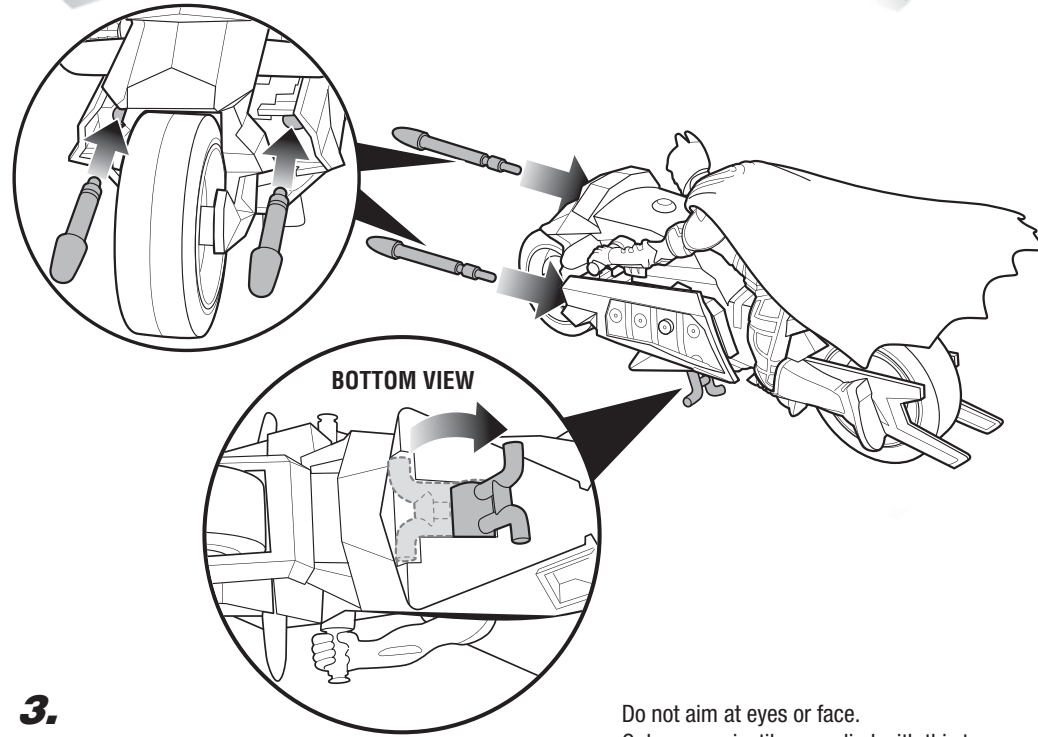

3.

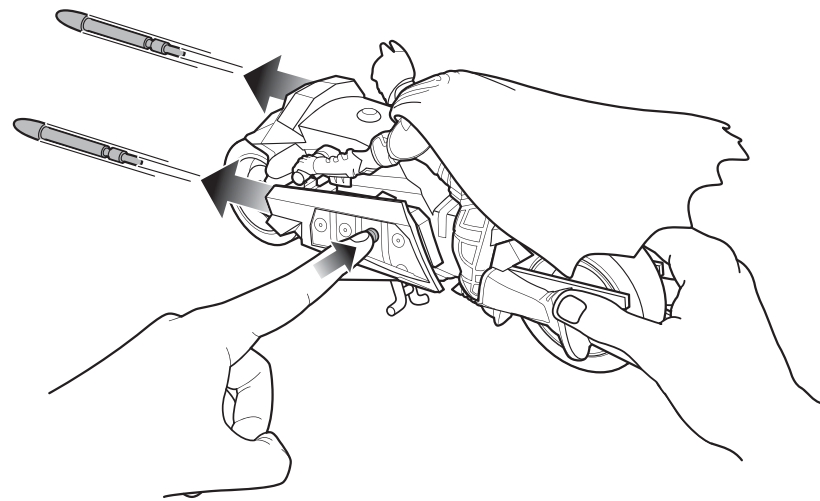

Do not aim at eyes or face.  
Only use projectiles supplied with this toy.  
Do not fire at point blank range.

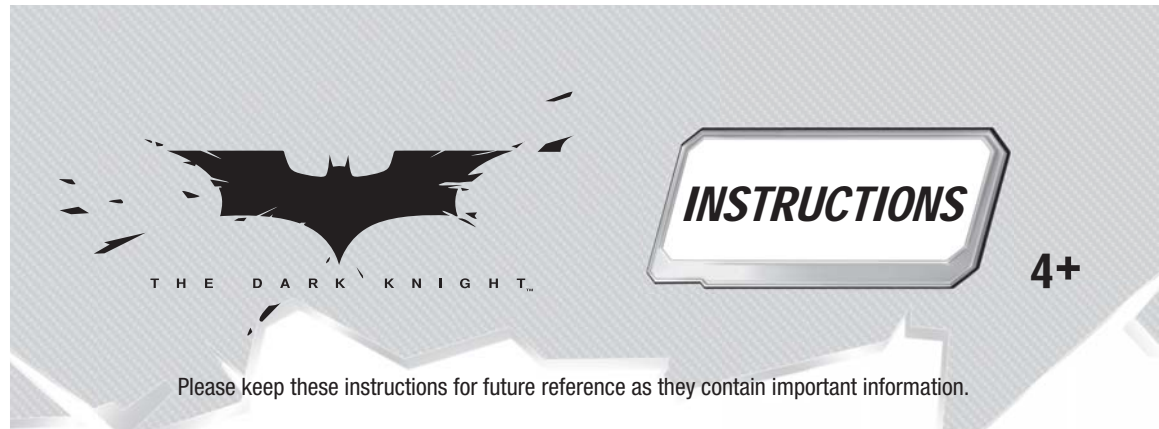

# INSTRUCTIONS

4+

Please keep these instructions for future reference as they contain important information.

## CONTENTS

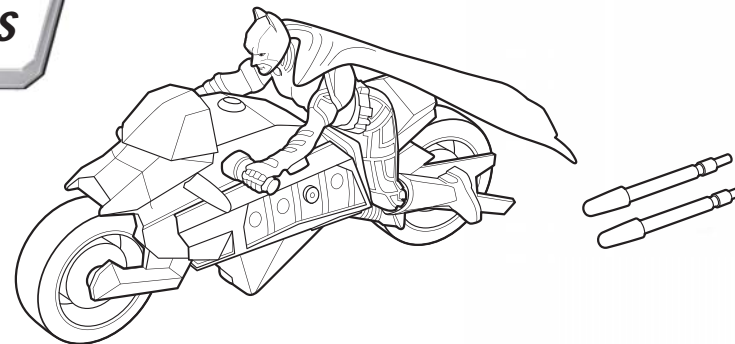

## TO PLAY

1.

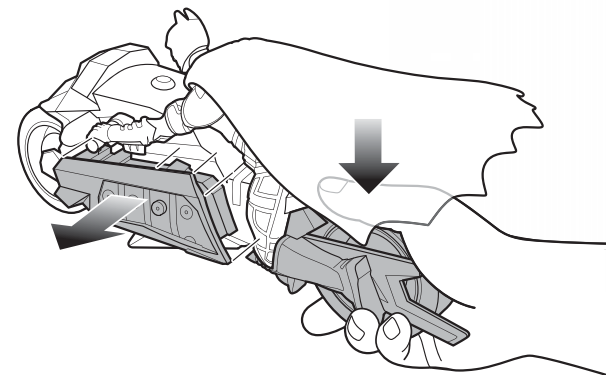

### INSTRUCTION SHEET SPECIFICATIONS

Toy:	BM DK PURSUIT CYCLE
Toy No.:	M5073
Part No.:	0920
Trim Size:	A5
Folded Size:	A6
Type of Fold:	
# colors:	One
Colors:	Black
Paper Stock:	White Offset
Paper Weight:	70 lb.
EDM No.:	

Mattel, Inc. All Rights Reserved. Mattel, Inc, 333 Continental Blvd., El Segundo, CA 90245 U.S.A. Consumer Relations 1 (800) 524-8697.  
 • Mattel Canada Inc., Mississauga, Ontario L5R 3W2. You may call us free at 1-800-524-8697. • Mattel U.K. Ltd., Vanwall Business Park, Maidenhead SL6 4UB, Helpline 01628500303. • Mattel Australia Pty Ltd., Richmond, Victoria. 3121. Consumer Advisory Service - 1300 135 312. • Mattel East Asia Ltd., Room 1106, South Tower, World Finance Centre, Harbour City, Tsimshatsui, HK, M5073-0920  
 China. • Diimport & Diedarkan Oleh: Mattel SEA Ptd Ltd.(993532-P) Lot 13.5, Menara Lien Hoe, Persiaran Tropicana Golf Country Resort, 47410 PJ. Tel:03-78803817, Fax:03-78803867. Asst. M1110

BATMAN and all related characters and elements are trademarks of and © DC Comics.  
(s08)

service.mattel.com



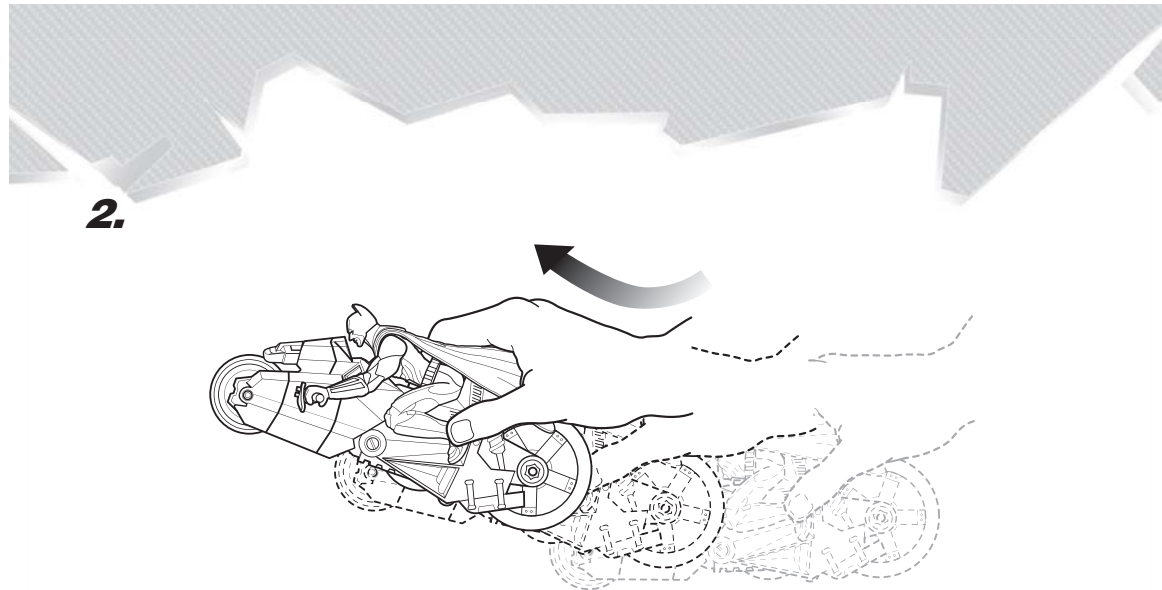

IMPORTANT: Keep fingers away from the rotating rear wheel.

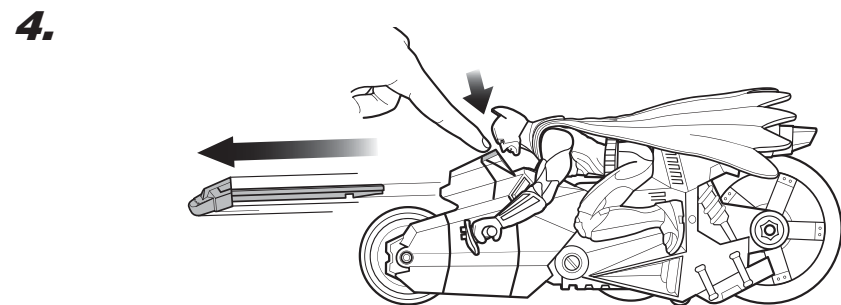
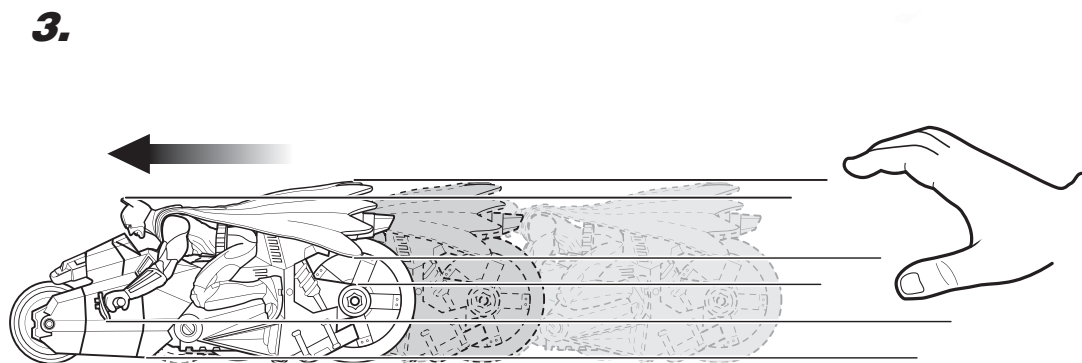

Do not aim at eyes or face.  
Only use projectiles supplied with this toy.  
Do not fire at point blank range.



## CONTENTS

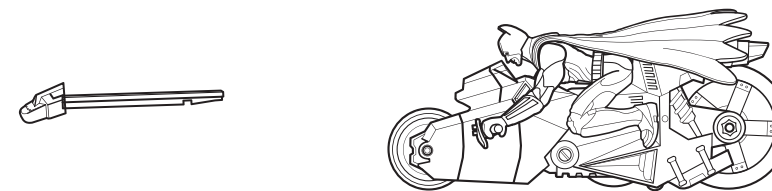

## TO PLAY

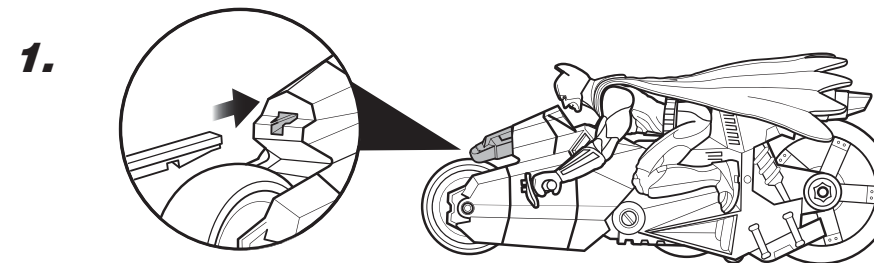

Mattel, Inc. All Rights Reserved. Mattel, Inc. 333 Continental Blvd., El Segundo, CA 90245 U.S.A. Consumer Relations 1 (800) 524-8697.  
 • Mattel Canada Inc., Mississauga, Ontario L5R 3W2. You may call us free at 1-800-524-8697. • Mattel U.K. Ltd., Vanwall Business Park, Maidenhead SL6 4UB, Helpline 01628500303. • Mattel Australia Pty Ltd., Richmond, Victoria. 3121. Consumer Advisory Service - 1300 135 312. • Mattel East Asia Ltd., Room 1106, South Tower, World Finance Centre, Harbour City, Tsimshatsui, HK, China. • Diimport & Diedarkan Oleh: Mattel SEA Ptd Ltd.(993532-P) Lot 13.5, Menara Lien Hoe, Persiaran Tropicana Golf Country Resort, 47410 PJ. Tel:03-78803817, Fax:03-78803867.

BATMAN and all related characters and elements are trademarks of and © DC Comics. (s08)

service.mattel.com



INSTRUCTION SHEET SPECIFICATIONS	
Toy:	BM DK CYCLE
Toy No.:	M9763
Part No.:	0920
Trim Size:	A5
Folded Size:	A6
Type of Fold:	
# colors:	One
Colors:	Black
Paper Stock:	White Offset
Paper Weight:	70 lb.
EDM No.:	