

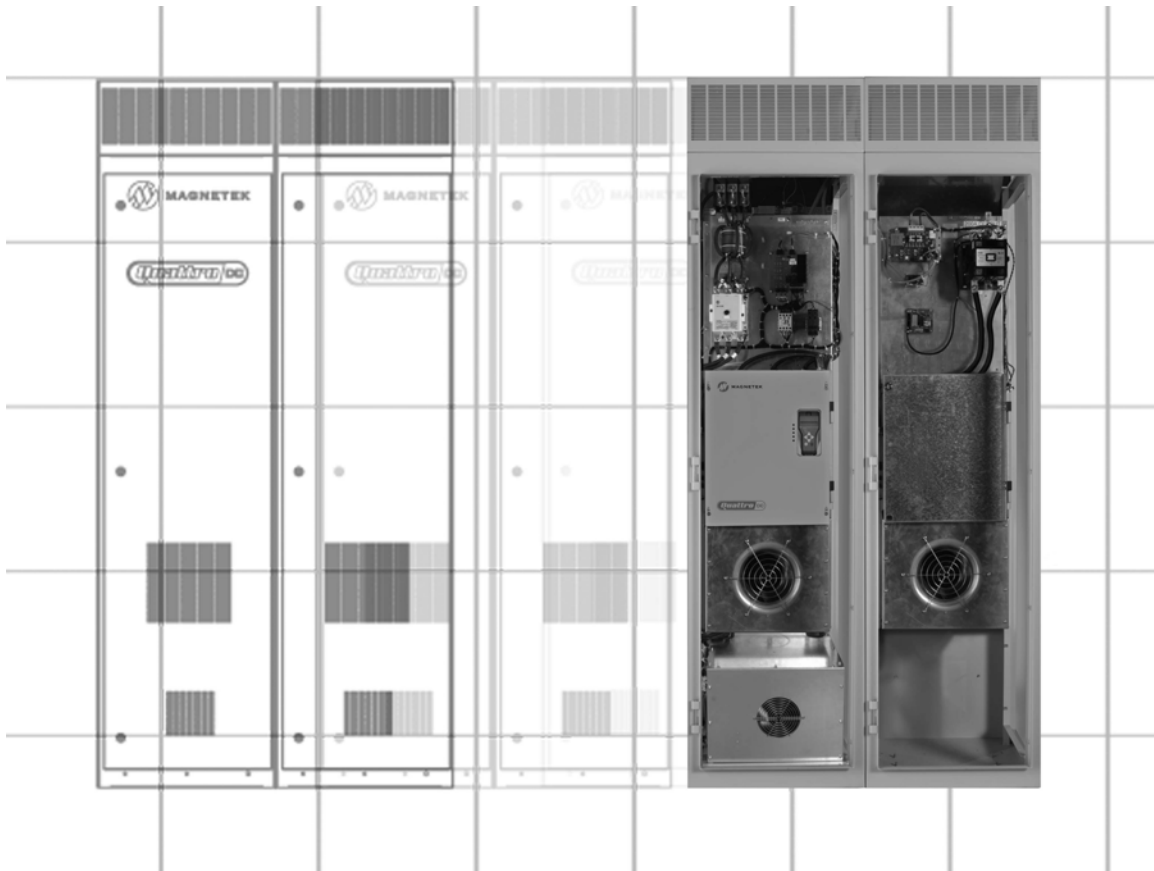

Quattro™ DC Elevator Drive

Technical Manual



TM7310 rev 01

© 2006 Magnetek Elevator

WARRANTY Standard products manufactured by the Company are warranted to be free from defects in workmanship and material for a period of one year from the date of shipment, and any products which are defective in workmanship or material will be repaired or replaced, at the Company's option, at no charge to the Buyer. Final determination as to whether a product is actually defective rests with the Company. The obligation of the Company hereunder shall be limited solely to repair or replace, at the Company's discretion, products that fall within the foregoing limitations, and shall be conditioned upon receipt by the Company of written notice of any alleged defects or deficiency promptly after discovery and within the warranty period, and in the case of components or units purchased by the Company, the obligation of the Company shall not exceed the settlement that the Company is able to obtain from the supplier thereof. No products shall be returned to the Company without its prior consent. Products which the company consents to have returned shall be shipped prepaid f.o.b. the Company factory. The Company cannot assume responsibility or accept invoices for unauthorized repairs to its components, even though defective. The life of the products the Company depends, to a large extent, upon type of usage thereof and THE COMPANY MAKES NO WARRANTY AS TO FITNESS OF ITS PRODUCTS FOR THE SPECIFIC APPLICATIONS BY THE BUYER NOR AS TO PERIOD OF SERVICE UNLESS THE COMPANY SPECIFICALLY AGREES OTHERWISE IN WRITING AFTER PROPOSED USAGE HAS BEEN MADE KNOWN TO IT. This warranty does not apply to experimental products for which no warranty is made or given and Buyer waives any claim thereto.

THE FOREGOING WARRANTY IS EXCLUSIVE AND IN LIEU OF ALL OTHER WARRANTIES, EXPRESSED OR IMPLIED, INCLUDING, BUT LIMITED TO, ANY WARRANTY OF MECHANICALITY OR OF FITNESS FOR A PARTICULAR PURPOSE AND BUYER HEREBY WAIVES ANY AND ALL CLAIMS THEREFORE.

LIMITATIONS OF LIABILITY IN NO EVENT SHALL MAGNETEK BE LIABLE FOR LOSS OF PROFIT, INDIRECT, CONSEQUENTIAL OR INCIDENTAL DAMAGES WHETHER ARISING OUT OF WARRANTY, BREACH OF CONTRACT OR TORT.

QUATTRO is a trademark of Magnetek, Inc.

All rights reserved. No part of this publication may be reproduced or used in any form or by any means - graphic, electronic, or mechanical including photocopying, recording, taping, or information storage and retrieval systems - without written permission of the publisher.

© 2007 Magnetek, Inc.

Table of Contents

Introduction	10
Drive Ratings and Specifications	10
Software Operating Features	10
Drive Model Numbers	11
Quattro startup guide	12
Initial Inspection	12
Grounding considerations	13
Initial adjustments after power up	13
Interconnections	15
Drive Sequencing	21
NORMAL operating sequence	21
ABNORMAL Operation Sequence	22
Quattro Pre-Charge	22
Drive Operation and Feature Overview	23
Analog Velocity Follower	23
Preset Speed & Profile Generator	23
Serial Link Follower	23
Pre-Torque	23
Torque Feed Forward	23
Torque/Current Ramp-Down	23
Motor Field Current Control and Field weakening	24
DSPR	24
Over-Speed Test	24
Fault & Alarm Reset	24
Electronic Motor Over-Load	24
Armature Voltage Feedback	24
Status Indicator Lights	25
MONITOR / Adjust / Set-up Parameters:	25
Parameters	26
Parameter Introduction	26
Menu Navigation	27
Parameter Tree	28
Adjust A0 menu	30
Drive A1 submenu	30
S-Curves A2 submenu	39
Multistep Ref A3 submenu	41
Motor Side Power Convert A4 submenu	43
Line Side Power Converter A5 submenu	46
Motor Parameters A6 submenu	47
Configure C0 menu	50
User Switches C1 submenu	50
Logic Inputs C2 submenu	61
Logic Outputs C3 submenu	63
Analog Outputs C4 submenu	65
Display D0 menu	66
Elevator Data D1 submenu	66
MS Power Data D2 submenu	68

LS Power Data D3 submenu	69
Utility U0 menu	70
Fault F0 menu	76
Maintenance	78
Maintenance Overview	78
Drive Servicing	78
Troubleshooting	79
Appendix	95
Auto Tune Procedure	95
Inertia Calculation	96
EMC Compliance	97
Re-Assembly Procedure for 200A / 250A drives	98
Control Power Consumption	102
Watts Loss	102
Input / Output Ratings	102
Wire Terminal Specs	103
Dimensions / Weights	104
Component Locations	109
Spare Parts Quattro DC Drive	116
Index	119

Quattro DC Quick Parameter Reference

Sub menu	Parameter	Units	Range	Default	Site Setting
A1	Drive A1 Submenu – See Drive A1 submenu on page 30.				
A1	CONTRACT CAR SPD	fpm	0.0 – 1500.0	400.0	
		m/s	0.000 – 8.000	2.000	
A1	CONTRACT MTR SPD	RPM	30.0 – 3000.0	1130.0	
A1	RESPONSE	rad/sec	1.0 – 20.0	10.0	
A1	INERTIA	sec	0.25 – 50.00	2.00	
A1	INNER LOOP XOVER	rad/sec	0.1 – 20.0	2.0	
A1	CURRENT LIMIT	%	0.0 – 275.0	200	
A1	GAIN REDUCE MULT	%	10 – 100	100	
A1	GAIN CHNG LEVEL	% of rated spd	0.0 – 100.0	100.0	
A1	TACH FILTER BW	rad/sec	1 – 100	100	
A1	TACH RATE GAIN	none	0.0 – 30.0	0.0	
A1	SPD PHASE MARGIN	degrees	45 – 90	80	
A1	RAMPED STOP TIME	sec	0.00 – 2.50	0.20	
A1	CONTACT FLT TIME	sec	0.10 – 5.00	0.50	
A1	BRAKE PICK TIME	sec	0.00 – 5.00	1.00	
A1	BRAKE HOLD TIME	sec	0.00 – 5.00	0.20	
A1	OVERSPEED LEVEL	% of contract spd	90.0 – 150.0	115.0	
A1	OVERSPEED TIME	sec	0.00 – 9.99	1.00	
A1	OVERSPEED MULT	%	100.0 – 150.0	125.0	
A1	ENCODER PULSES	PPR	600 – 10000	5000	
A1	SPD DEV LO LEVEL	% of contract spd	0.1 – 20.0	10.0	
A1	SPD DEV TIME	sec	0.00 – 9.99	0.50	
A1	SPD DEV HI LEVEL	% of contract spd	0.0 – 99.9	10.0	
A1	SPD COMMAND BIAS	volts	0.00 – 6.00	0.00	
A1	SPD COMMAND MULT	none	0.90 – 5.00	1.00	
A1	EXT TORQUE BIAS	volts	-6.00 – +6.00	0.00	
A1	EXT TORQUE MULT	none	-10.00 – +10.00	1.00	
A1	ZERO SPEED LEVEL	% of contract spd	0.00 – 99.99	1.00	
A1	ZERO SPEED TIME	sec	0.00 – 9.99	0.10	
A1	UP/DWN THRESHOLD	% of contract spd	0.00 – 9.99	1.00	
A1	ANA 1 OUT OFFSET	%	-99.9 – +99.9	0.0	
A1	ANA 2 OUT OFFSET	%	-99.9 – +99.9	0.0	
A1	ANA 1 OUT GAIN	none	0.0 – 10.0	1.0	
A1	ANA 2 OUT GAIN	none	0.0 – 10.0	1.0	
A1	FLT RESET DELAY	sec	0 – 120	5	
A1	FLT RESETS/HOUR	faults	0 – 10	3	
A1	UP TO SPD LEVEL	% of contract spd	0.00 – 110.00	80.00	
A1	RUN DELAY TIMER	sec	0.00 – 0.99	0.00	
A1	AB ZERO SPD LEV	%	0.00 – 2.00	0.00	
A1	AB OFF DELAY	sec	0.00 – 9.99	0.00	
A1	CONTACTOR DO DLY	sec	0.00 – 5.00	0.00	
A1	TRQ LIM MSG DLY	sec	0.00 – 10.00	0.50	
A1	ROLLBACK GAIN	none	1 – 99	1	
A1	NOTCH FILTER FRQ	Hz	5 – 60	20	
A1	NOTCH FILT DEPTH	%	0 – 100	0	
A1	STNDBY FLD TIME	sec	0 – 999	30	
A1	DSPR TIME	min	0 – 999	120	
A1	FULL FIELD TIME	min	0 – 99	5	

Quattro DC Quick Parameter Reference

Sub menu	Parameter	Units	Range	Default	Site Setting
A2	S-Curves A2 Submenu – See S-Curves A2 submenu on page 39.				
A2	ACCEL RATE 0	ft/s ²	0.00 – 7.99	7.99	
		m/s ²	0.000 – 3.999	2.435	
A2	DECEL RATE 0	ft/s ²	0.00 – 7.99	7.99	
		m/s ²	0.000 – 3.999	2.435	
A2	ACCEL JERK IN 0	ft/s ³	0.0 – 29.9	0.0	
		m/s ³	0.000 – 9.999	0.000	
A2	ACCEL JERK OUT 0	ft/s ³	0.0 – 29.9	0.0	
		m/s ³	0.000 – 9.999	0.000	
A2	DECEL JERK IN 0	ft/s ³	0.0 – 29.9	0.0	
		m/s ³	0.000 – 9.999	0.000	
A2	DECEL JERK OUT 0	ft/s ³	0.0 – 29.9	0.0	
		m/s ³	0.000 – 9.999	0.000	
A2	ACCEL RATE 1	ft/s ²	0.00 – 7.99	7.00	
		m/s ²	0.000 – 3.999	2.134	
A2	DECEL RATE 1	ft/s ²	0.00 – 7.99	3.00	
		m/s ²	0.000 – 3.999	0.090	
A2	ACCEL JERK IN 1	ft/s ³	0.0 – 29.9	8.0	
		m/s ³	0.000 – 9.999	2.400	
A2	ACCEL JERK OUT 1	ft/s ³	0.0 – 29.9	8.0	
		m/s ³	0.000 – 9.999	2.400	
A2	DECEL JERK IN 1	ft/s ³	0.0 – 29.9	8.0	
		m/s ³	0.000 – 9.999	2.400	
A2	DECEL JERK OUT 1	ft/s ³	0.0 – 29.9	8.0	
		m/s ³	0.000 – 9.999	2.400	
A2	ACCEL RATE 2	ft/s ²	0.00 – 7.99	3.00	
		m/s ²	0.000 – 3.999	0.090	
A2	DECEL RATE 2	ft/s ²	0.00 – 7.99	3.00	
		m/s ²	0.000 – 3.999	0.090	
A2	ACCEL JERK IN 2	ft/s ³	0.0 – 29.9	8.0	
		m/s ³	0.000 – 9.999	2.400	
A2	ACCEL JERK OUT 2	ft/s ³	0.0 – 29.9	8.0	
		m/s ³	0.000 – 9.999	2.400	
A2	DECEL JERK IN 2	ft/s ³	0.0 – 29.9	8.0	
		m/s ³	0.000 – 9.999	2.400	
A2	DECEL JERK OUT 2	ft/s ³	0.0 – 29.9	8.0	
		m/s ³	0.000 – 9.999	2.400	
A2	ACCEL RATE 3	ft/s ²	0.00 – 7.99	3.00	
		m/s ²	0.000 – 3.999	0.090	
A2	DECEL RATE 3	ft/s ²	0.00 – 7.99	3.00	
		m/s ²	0.000 – 3.999	0.090	
A2	ACCEL JERK IN 3	ft/s ³	0.0 – 29.9	8.0	
		m/s ³	0.000 – 9.999	2.400	
A2	ACCEL JERK OUT 3	ft/s ³	0.0 – 29.9	8.0	
		m/s ³	0.000 – 9.999	2.400	
A2	DECEL JERK IN 3	ft/s ³	0.0 – 29.9	8.0	
		m/s ³	0.000 – 9.999	2.400	
A2	DECEL JERK OUT 3	ft/s ³	0.0 – 29.9	8.0	
		m/s ³	0.000 – 9.999	2.400	

Quattro DC Quick Parameter Reference

Sub menu	Parameter	Units	Range	Default	Site Setting
A3	Multistep Ref A3 Submenu – See Multistep Ref A3 submenu on page 41.				
A3	SPEED COMMAND 1	ft/min	-3000.0 – +3000.0	0.0	
		m/sec	-16.000 – +16.000	0.000	
A3	SPEED COMMAND 2	ft/min	-3000.0 – +3000.0	0.0	
		m/sec	-16.000 – +16.000	0.000	
A3	SPEED COMMAND 3	ft/min	-3000.0 – +3000.0	0.0	
		m/sec	-16.000 – +16.000	0.000	
A3	SPEED COMMAND 4	ft/min	-3000.0 – +3000.0	0.0	
		m/sec	-16.000 – +16.000	0.000	
A3	SPEED COMMAND 5	ft/min	-3000.0 – +3000.0	0.0	
		m/sec	-16.000 – +16.000	0.000	
A3	SPEED COMMAND 6	ft/min	-3000.0 – +3000.0	0.0	
		m/sec	-16.000 – +16.000	0.000	
A3	SPEED COMMAND 7	ft/min	-3000.0 – +3000.0	0.0	
		m/sec	-16.000 – +16.000	0.000	
A3	SPEED COMMAND 8	ft/min	-3000.0 – +3000.0	0.0	
		m/sec	-16.000 – +16.000	0.000	
A3	SPEED COMMAND 9	ft/min	-3000.0 – +3000.0	0.0	
		m/sec	-16.000 – +16.000	0.000	
A3	SPEED COMMAND 10	ft/min	-3000.0 – +3000.0	0.0	
		m/sec	-16.000 – +16.000	0.000	
A3	SPEED COMMAND 11	ft/min	-3000.0 – +3000.0	0.0	
		m/sec	-16.000 – +16.000	0.000	
A3	SPEED COMMAND 12	ft/min	-3000.0 – +3000.0	0.0	
		m/sec	-16.000 – +16.000	0.000	
A3	SPEED COMMAND 13	ft/min	-3000.0 – +3000.0	0.0	
		m/sec	-16.000 – +16.000	0.000	
A3	SPEED COMMAND 14	ft/min	-3000.0 – +3000.0	0.0	
		m/sec	-16.000 – +16.000	0.000	
A3	SPEED COMMAND 15	ft/min	-3000.0 – +3000.0	0.0	
		m/sec	-16.000 – +16.000	0.000	
A4	Motor Side Power Convert A4 Submenu – See Motor Side Power Convert on page 43.				
A4	ARM RESISTANCE	ohm	0.0001 – 2.9999	0.5000	
A4	ARM INDUCTANCE	mH	0.01 – 327.67	15.00	
A4	MTR REV VLT LIM	%	0.01 – 30.00	4.80	
A4	If REG INT GAIN	none	0.00 – 30.00	0.90	
A4	If REG PROP GAIN	none	0.00 – 16.38	6.07	
A4	AUTO TUNE MOTOR	none	– Start Autotune?	-	
A4	GAIN SELECTION	none	– manual – autotune	MANUAL	
A4	GAIN BANDWIDTH A	rad/sec	100 – 2000	500	
A4	GAIN BANDWIDTH F	rad/sec	1 – 40	5	
A4	PWM FREQUENCY	kHz	2.5 – 16.0	6.0	
A4	FAN OFF DELAY	sec	0 – 999	180	
A4	MAIN FAN CONTROL	none	– auto – temp – off	– low – medium – high	TEMP
A4	UV-ALARM LEVEL	%	80 – 99	90	
A4	UV FAULT LEVEL	%	50 – 99	80	
A4	FLD CARRIER FRQ	kHz	3 – 10	3	

Quattro DC Quick Parameter Reference

Sub menu	Parameter	Units	Range	Default	Site Setting
A5	Line Side Power converter A5 Submenu – See Line Side Power Converter on page 46.				
A5	Id REG PROP GAIN	none	0.00 – 9.99	0.30	
A5	Id REG INTGRL GAIN	none	0 – 999	10	
A5	Iq REG PROP GAIN	none	0.00 – 9.99	0.30	
A5	Iq REG INTGRL GAIN	none	0 – 999	40	
A5	DC BUS REG P GAIN	none	0.00 – 9.99	3.00	
A5	DC BUS REG I GAIN	none	0 – 999	40	
A5	INPUT L-L VOLTS	volts	110 – 552	480	
A5	DC BUS V BOOST	volts	15 – 75	30	
A5	SW BUS OV LEVEL	volts	100 – 850	850	
A5	BUS VREF SOURCE	none	– track line v – trk vin param	TRK Vin PARAM	
A5	PLL FILTER FC	Hz	0.0 – 150.0	40.0	
A5	LS PWM FREQ	kHz	2.5 – 16.0	10.0	
A6	Motor A6 Submenu – See Motor Parameters A6 submenu on page 47.				
A6	MOTOR ID	none	-	-	
A6	RATED MOTOR CURR	amps	1.0 – 400.0	0.0	
A6	ARMATURE VOLTS	volts	55 – 600	0	
A6	FULL FLD CURRENT	amps	1.0 – 40.0	0.0	
A6	WEAK FLD CURRENT	amps	1.0 – 40.0	0.0	
A6	STANDBY FIELD	amps	0.0 – 40.0	0.0	
A6	FLUX CONFIRM LEV	%	25.0 – 99.0	0.0	
A6	ARMATURE IR DROP	%	0.0 – 25.0	0.0	
A6	OVLD START LEVEL	%	100 – 150	110	
A6	OVLD TIME OUT	sec	5.0 – 120.0	60.0	
C1	User Switches C1 Submenu – See User Switches C1 submenu on page 50.				
C1	SPD COMMAND SRC	none	– analog input – multi-step – ser mult step – serial	MULTI-STEP	
C1	RUN COMMAND SRC	none	– external tb – serial – serial+extrn	EXTERNAL TB	
C1	FIELD ENA SOURCE	none	– external tb – serial – 2-bit serial – enable on run	ENABLE ON RUN	
C1	HI/LO GAIN SRC	none	– external tb – serial – internal	INTERNAL	
C1	SPEED REG TYPE	none	– elev spd reg – pi speed reg – external reg – cemf reg	ELEV SPD REG	
C1	MOTOR ROTATION	none	– forward – reverse	FORWARD	
C1	ENCODER CONNECT	none	– forward – reverse	FORWARD	
C1	SPD REF RELEASE	none	– reg release – brake picked	REG RELEASE	
C1	CONT CONFIRM SRC	none	– none – external tb	NONE	
C1	TACH FILTER	none	– off – on	OFF	

Quattro DC Quick Parameter Reference

Sub menu	Parameter	Units	Range	Default	Site Setting
C1	<i>User Switches C1 Submenu continued ...</i>				
C1	PreTorque SOURCE	none	– none – analog Input – serial	NONE	
C1	PreTorque LATCH	none	– not latched – latched	NOT LATCHED	
C1	PTorq LATCH CLCK	none	– serial – external tb	EXTERNAL TB	
C1	FAULT RESET SRC	none	– external tb – serial – automatic	EXTERNAL TB	
C1	OVERSPD TEST SRC	none	– external tb – serial	EXTERNAL TB	
C1	BRAKE PICK SRC	none	– internal – serial	INTERNAL	
C1	BRAKE PICK CNFM	none	– none – internal time – external tb	NONE	
C1	BRAKE HOLD SRC	none	– internal – serial	INTERNAL	
C1	RAMPED STOP SEL	none	– none – ramp on stop	NONE	
C1	RAMP DOWN EN SRC	none	– external tb – run logic – serial	EXTERNAL TB	
C1	BRK PICK FLT ENA	none	– disable – enable	DISABLE	
C1	BRK HOLD FLT ENA	none	– disable – enable	DISABLE	
C1	EXT TORQ CMD SRC	none	– none – analog input – serial	NONE	
C1	DIR CONFIRM	none	– disable – enable	DISABLE	
C1	S-CURVE ABORT	none	– disable – enable	DISABLE	
C1	ENCODER FAULT	none	– disable – enable	ENABLE	
C1	PRIORITY MESSAGE	none	– disable – enable	ENABLE	
C1	STOPPING MODE	none	– immediate – ramp to stop	IMMEDIATE	
C1	AUTO STOP	none	– disable – enable	DISABLE	
C1	DSPR ENABLE	none	– disable – enable	DISABLE	

Quattro DC Quick Parameter Reference

Sub menu	Parameter	Units	Range	Default	Site Setting		
C2	Logic Inputs C2 Submenu – See Logic Inputs C2 submenu on page 61.						
C2	N.C. INPUTS	None	Hex Number	0x01			
C2	LOGIC INPUT 1 TB1(1)	<ul style="list-style-type: none"> – contact cfirm – ctr pwr sense – drive enable – extrn fault 1 – extrn fault 2 – extrn /flt 4 – fault reset – field enable – low gain sel – mech brk hold – mech brk pick – no function – ospd test src 	<ul style="list-style-type: none"> – pre-trq latch – run – run down – run up – s-curve sel 0 – s-curve sel 1 – ser2 insp ena – step ref b0 – step ref b1 – step ref b2 – step ref b3 – trq ramp down – up/dwn 	CONTACT CFIRM			
C2	LOGIC INPUT 2 TB1(2)			CTR PWR SENSE			
C2	LOGIC INPUT 3 TB1(3)			NO FUNCTION			
C2	LOGIC INPUT 4 TB1(4)			DRIVE ENABLE			
C2	LOGIC INPUT 5 TB1(5)			RUN			
C2	LOGIC INPUT 6 TB1(6)			UP/DWN			
C2	LOGIC INPUT 7 TB1(7)			STEP REF B0			
C2	LOGIC INPUT 8 TB1(8)			STEP REF B1			
C2	LOGIC INPUT 9 TB1(9)			FAULT RESET			
C3	Logic Outputs C3 Submenu – See Logic Outputs C3 submenu on page 63.						
C3	LOGIC OUTPUT 1 TB1(25)	<ul style="list-style-type: none"> – alarm – alarm+flt – auto brake – brake hold – brake pick – brk hold flt – brk pick flt – car going dwn – car going up – charge fault – close contact – contactor flt – curr reg flt – drv overload – encoder flt – fault – flux confirm – ground fault – in low gain – motor trq lim – mtr overload – no function 	<ul style="list-style-type: none"> – not alarm – over curr flt – overspeed flt – overtemp flt – overvolt flt – ovrtemp alarm – phase fault – ramp down ena – ready 2 start – ready to run – regen trq lim – run commanded – run confirm – speed dev – speed dev low – speed ref rls – speed reg rls – undervolt flt – up to speed – uv alarm – zero speed 	CLOSE CONTACT			
C3	LOGIC OUTPUT 2 TB1(26)			RUN COMMANDED			
C3	LOGIC OUTPUT 3 TB1(27)			MTR OVERLOAD			
C3	LOGIC OUTPUT 4 TB1(28)			ENCODER FLT			
C3	LOGIC OUTPUT 5 TB1(29)			FAULT			
C3	LOGIC OUTPUT 6 TB1(30)			SPEED REG RLS			
C3	LOGIC OUTPUT 7 TB1(31)			SPEED REG RLS			
C3	SSR1 TB1(21/22)			NO FUNCTION			
C3	SSR2 TB1(23/24)			NO FUNCTION			
C3	RELAY COIL 1 TB2 (1/3/5)			NO FUNCTION			
C3	RELAY COIL 2 TB2 (8/10/12)			NO FUNCTION			
C4	Analog Outputs C4 Submenu – See Analog Outputs C4 submenu on page 65.						
C4	ANALOG OUTPUT 1			<ul style="list-style-type: none"> – arm current – arm voltage – aux torq cmd – bus voltage – est motor spd – field current – iarm error – pretorque ref – motor mode 	<ul style="list-style-type: none"> – spd rg tq cmd – speed command – speed error – speed feedbk – speed ref – tach rate cmd – tach speed – torque ref 	SPEED REF	
C4	ANALOG OUTPUT 2	SPEED FEEDBK					

Quattro DC Quick Parameter Reference

Menu	Parameter	Unit
D1	Elevator Data Submenu	
D1	Speed Command	ft/min or m/sec
D1	Speed Reference	ft/min or m/sec
D1	Speed Feedback	ft/min or m/sec
D1	Speed Error	ft/min or m/sec
D1	Pre-Torque Ref	% of rated torque
D1	Ext-Torque Cmd	% of rated current
D1	Spd Reg Torq Cmd	% of rated torque
D1	Tach Rate Cmd	% of rated torque
D1	Aux Torque Cmd	% of rated torque
D1	Est Inertia	Seconds
D1	Rx Com Status	1 = true; 0 = false
D1	Logic Outputs	1 = true; 0 = false
D1	Logic Inputs	1 = true; 0 = false
D2	MS Power Data Submenu	
D2	Armature Current	Amps
D2	Field Current	Amps
D2	Armature Voltage	Volts
D2	MS Bus Voltage	Volts
D2	Motor Mode	None
D2	Torque Ref	%
D2	Est Spd Fdbk	ft/min or m/sec
D2	Encoder Spd	ft/min or m/sec
D2	DS Module Temp	°C
D2	LS Module Temp	°C
D2	Highest Temp	°C
D2	Field IGBT Temp	°C
D2	Armature Cur Err	Amps
D2	Auto Fld Int	none
D2	Auto Fld Prop	none
D2	Auto Meas Arm L	mH
D2	Auto Meas Arm R	Ohm
D2	Auto Field Res	Ohm
D2	Auto Field Tc	sec
D3	LS Power Data Submenu	
D3	LS Pwr Output	kW
D3	DC Bus Voltage	Volts
D3	DC Bus Volts Ref	Volts
D3	LS Overload	%
D3	LS Input Current	Amps
D3	LS D Axis I	%
D3	LS Q Axis I	%
D3	LS D Axis Volts	%
D3	LS Q Axis Volts	%
D3	Input Hz	Hz
D3	Input Vab	Volts
D3	Input Vca	Volts
D3	LS Module Temp	°C

Menu	Parameter	Unit
U1	Password U1 Submenu	
U1	Enter password	-
U1	New password	-
U1	Password Lockout	-
U2	Hidden Items U2 Submenu	
U2	Hidden Items Enable	-
U3	Units U3 Submenu	
U3	Units Selection	-
U4	Overspeed Test U4 Submenu	
U4	Overspeed Test	-
U5	Restore Dflts U5 Submenu	
U5	Restore Motor Dflts	-
U5	Restore Drive Dflts	-
U5	Restore Utility Dflts	-
U6	Motor Side Info U6 Submenu	
U6	MS Type	-
U6	MS Code Version	-
U6	MS S/W Date	-
U6	MS S/W Time	-
U6	MS FPGA Version	-
U6	MS Cube ID	-
U7	Line Side Info U7 Submenu	
U7	LS Type	-
U7	LS Code Version	-
U7	LS S/W Date	-
U7	LS S/W Time	-
U7	LS FPGA Version	-
U7	LS Cube ID	-
U8	Hex Monitor U8 Submenu	
U8	Hex Monitor	-
F1	Active Faults F1 Submenu	
F1	Display Active Faults	-
F1	Reset Active Faults	-
F2	Faults History F2 Submenu	
F2	Display Fault History	-
F2	Clear Fault History	-
F2	Display Fault Counters	-

Introduction

Drive Ratings and Specifications

The Quattro drive is designed for connection to a 4 wire grounded 3-phase input along with a single-phase 230 VAC control power input.

Basic Drive Specifications

- 125, 200, 250 amps DC armature output (Elevator Run Current) at up to 550VDC in 2 basic model sizes
- 150% overload for 60 seconds
- 250% overload for 6 seconds
- Up to 40 ADC motor field control
- <8% utility input current harmonics at full power (<5% on 125 amp unit)
- Unity Power Factor (1.0 Service Factor)
- 0–45°C (32–115°F) ambient temp range
- Fully regenerative operation
- Includes motor armature contactor w/ provision for armature DB resistors
- 4+ Million Start-Stop operating cycles
- (9) 24VDC Programmable Logic Inputs
- (11) Programmable Logic Outputs:
 - (7) 24VDC
 - (2) Solid-State Relays
 - (2) Relays
- 5V or 12V Isolated encoder power source w/ differential receivers

Service Conditions

- Required: 200-480 VAC, 3-phase, 50/60 Hz input power, Line Impedance $Z < 6\%$
- Required: 220-240 VAC, single-phase control power, 50/60 Hz, 3.5/5.5 amps maximum for 125/200-250 amp drives respectively

Software Operating Features

The General Purpose Quattro-DC elevator drive is a four-quadrant torque and speed regulated motor drive with low power line harmonic currents and unity power factor. It can be configured to operate geared and gearless elevators and lifts. Basic features include...

- User choice of operating speed reference (see pg 23)
 - External analog reference follower
 - Serial link reference follower
 - Internal reference generator with controlled S-Curve smoothing to one of 15 preset speeds
- User choice of ft/min or m/sec speed programming and display units (see pg 71)
- User choice of input control logic for Run-Up / Run-Down or Run / Direction relay control with internal preset speeds (see pg 23)

- User choice of P-I type or MagneTek exclusive E-Reg, elevator velocity regulators (see pages 59 and 60)
- Optional CEMF speed regulator for use during initial construction stage start-up
- Torque Feed-Forward when available from the car controller (see pg 23)
- Pre-Torque at drive start to reduce roll-back (see pg 23)
- Controlled torque Ramp-Down to prevent elevator brake thumping at stops (see pg 23)
- Internal frequency notch filter to reject rope resonance interference (see pg 38)
- Closed loop motor field current regulator with simplified motor field weakening and stand-by adjustments
- Quiet, variable speed cooling fan
- Drive Stand-by Power Reduction (see pg 24)
- User selectable choices for relay logic outputs, including (see Logic Outputs C3 submenu on pg 63):
 - Drive OK / No Faults relay
 - Alarms Relay
 - Drive operating, OK to release brake
 - Car above/below speed X threshold
 - Car above/below Zero speed threshold
 - Car Moving Up
 - Car Moving Down
 - Speed Error above/below X threshold for Y secs
 - Drive Standby Power Reduction (DSPR)
 - Elevator Brake actuation
- User selectable analog trace outputs for system diagnostics (see Analog Outputs C4 submenu on pg 65)
- Diagnostic indicator for verifying logic input and output conditions
- Programmable Alarm Relay to indicate important but non-critical conditions
 - Motor thermostat over-temperature
 - Motor Over-Load
 - Drive Over-Heating
 - Low Utility Line Input
- Safety related fault trapping with diagnostics, including:
 - Motor Over-Current
 - Motor field Malfunction
 - Contactor Failure
 - Severe Utility Line disturbances
 - Encoder Loss
 - Over-Speed Trip
- User selectable automatic or external commanded Fault Reset (see User Switches C1 submenu on pages 50-58)

Drive Model Numbers

The Quattro DC drive is currently available with three different output currents and a variety of options.

The enclosure options consist of a customer I/O panel and a side Dynamic Braking Resistor box. The Dynamic Braking Resistor box is an optional box that is attached to the right hand side of the cabinet. It is used to hold the dynamic braking resistors. The customer I/O panel is an optional larger width cabinet that allows for customer interfacing within the supplied cabinet. See Dimensions / Weights on page 104.

The next option consists of shipping, either domestically or internationally. Due to international standards, the shipping crate must be heat-treated.

The final option section determines the type of motor contactor and Magnetek Operator. The Magnetek Operator is not required to start running, but allows for easy access to parameters, overspeed test, and auto tuning.

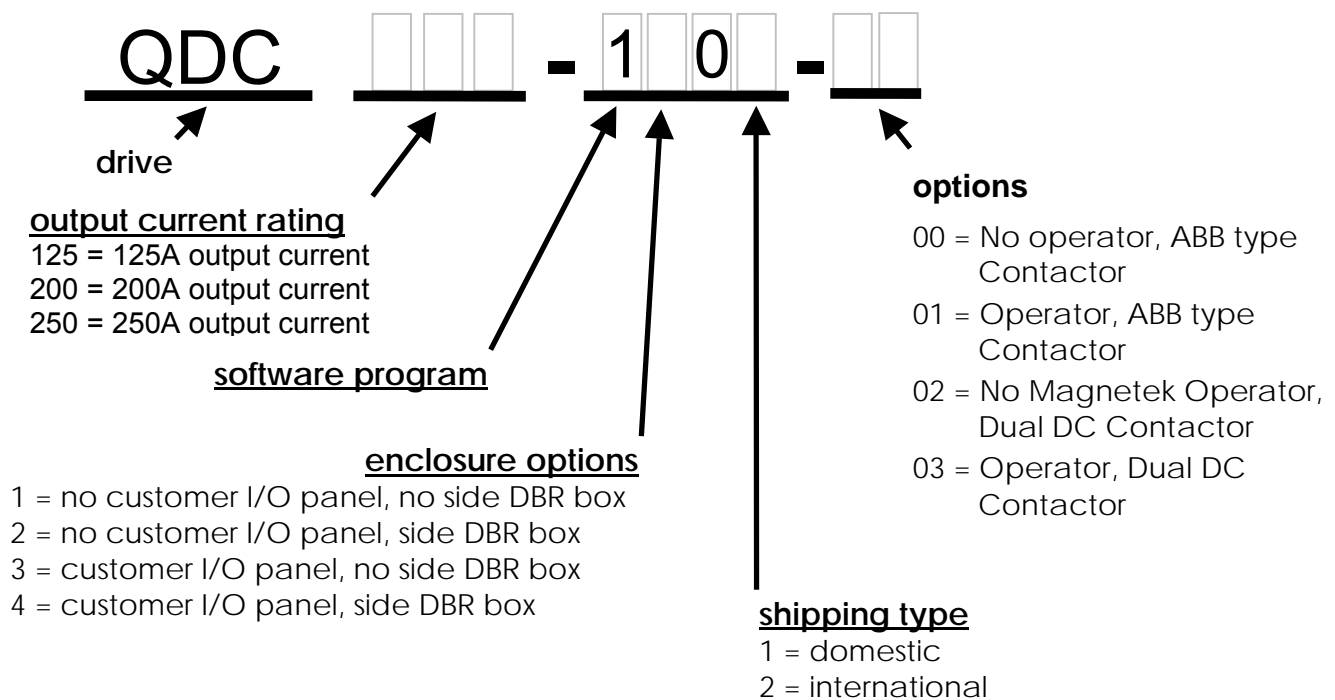

Quattro startup guide

Initial Inspection

Unpacking

1. When unpacking, check drive for any shipping damage.
2. The 200A and 250A versions of the Quattro arrive in separate shipping containers, which require connection in the field. Prior to connecting enclosures, check serial numbers on each cabinet section to insure mating compatible units. Proper mating of enclosures and wiring between is important. Refer to the re-connection instructions on page 98.
3. Review the technical manual, shipped with the drive.
4. Verify the proper drive model numbers and voltage ratings as specified on the purchase order.
5. Location of the Quattro is important for proper operation of the drive and normal life expectancy.

Installation

The installation should comply with the following:

- DO NOT mount in direct sunlight, rain or extreme (condensing) humidity.
- DO NOT mount where corrosive gases or liquids are present.
- AVOID exposure to vibration, airborne dust or metallic particles.
- DO NOT allow the ambient temperature around the control to exceed the ambient temperature listed in the specification.

Observe the following precautions:

1. Wiring guide lines
 - For Logic Input and Output I/O connections, use quality, multi-conductor cable or discrete stranded wire only.
 - For Encoder and Analog I/O connections, use quality, multi-conductor braided shield cable*.
 - For Communication I/O connections, use quality, multi-conductor braided shield* cable or twisted pair wire.

*Cable shields to be terminated with a 180/360 degree metal cable clamp attached to Control Tray panel flange. Refer to the EMC Compliance on page 97.

2. Never connect main AC power to the output terminals

3. Never allow wire leads to contact metal surfaces. Short circuit may result.
4. SIZE OF WIRE MUST BE SUITABLE FOR CLASS I CIRCUITS.
5. Motor lead length should not exceed 20m (60 ft). If lead length must exceed this distance, contact Magnetek for proper installation procedures.
6. The following are required to be contained in individual conduit runs: 3-phase incoming power, control power, DC armature wires, and DC shunt field.
7. Use UL/CSA certified connectors sized for the selected wire gauge. Install connectors using the crimping tools specified by the connector manufacturer.
8. Control wire lead length should not exceed 20m (60 ft). Signal leads and feedback leads should be run in separate conduits from power and motor wiring.
9. Verify that the input voltage matches the drive's rating.
10. Verify that the motor is wired for the application voltage and amperage.
11. Tighten all of the three-phase power and ground connections. See Table 1 for torque specs.

Wire References	Torque Specs
Power Terminals	56.6 N-m (500 in-lbs)
Plastic Cover Screws	0.23-0.28 N-m (2-2.5 in-lbs)
Ground Terminals	31.0 N-m (275 in-lbs)

Table 1: Input Power Torque Specs

12. Check that all control and signal terminations are also tight.

CAUTION: TO PREVENT DAMAGE TO THE DRIVE. THE FOLLOWING CHECKS MUST BE PERFORMED BEFORE APPLYING THE INPUT POWER.

- During shipping, connections may loosen; inspect all equipment for signs of damage, loose connections, or other defects.
- Ensure the three-phase line voltage is within $\pm 10\%$ of the nominal input voltage. Also verify the frequency (50 or 60 Hz) is correct for the elevator control system.
- Remove all shipping devices.
- Ensure all electrical connections are secure.
- Ensure all transformers are connected for proper voltage.

- Open F1 and F2 and ensure control power brought into fuse F1 and F2 is 230VAC!

IMPORTANT: Double-check all the power wires and motor wires to make sure that they are securely tightened down to their respective lugs (loose wire connections may cause problems at any time).

Grounding considerations

1. Encoder
 - a. Encoder isolation
 - The encoder must be electrically isolated from the motor frame and the motor shaft.
 - b. Encoder cable
 - The cable type should PVC braided shielded type with three 22ga twisted pairs. A and A/, B and B/, common and V should be the signals paired together.
 - The encoder shield is not to be connected at the encoder end. On the drive side of the cable a portion of PVC material 1inch [25mm] should be removed approximately 12inches [300mm] from the connection to the customer interface PCB (A6) to expose the shield material. This point is required to be secured under a clamp located under the control tray. Do not connect the shield to any other point. Refer to the EMC Compliance on page 97.
2. Motor frame
 - a. The motor frame is required to be grounded. The bond wire should be returned to the common ground point located in the Quattro enclosure (PE).
3. Three phase power
 - a. The three phase wires must be run with a ground wire. This ground wire, which is connected back to the utility ground, is required to be connected to the Quattro ground (PE).
4. Control power, 230VAC
 - a. The neutral side of the control power is required to be grounded at the Quattro ground (PE).

Initial adjustments after power up

Encoder Set-up

Electrical interference and mechanical speed modulations are common problems that can result in improper speed feedback getting to the drive. To help avoid these common

problems, the following electrical and mechanical considerations are suggested.

IMPORTANT

Proper encoder speed feedback is essential for a drive to provide proper motor control.

Electrical Requirements:

- Insulate both the encoder case and shaft from the motor
- Incremental encoder type
- Use twisted pair cable with shield tied to chassis ground at drive end
- Use limited slew rate differential line drivers
- Do not allow capacitors from internal encoder electronics to case
- Do not exceed the operating specification of the encoder/drive (300Khz @ rated motor speed maximum)
- Use the proper encoder supply voltage and use the highest possible voltage available. The Quattro DC provides both 5VDC and 12VDC. Magnetek recommends using the 12VDC for the encoder supply.

Mechanical Considerations:

- Use direct motor mounting without couplings
- Use hub or hollow shaft encoder with concentric motor stub shaft
- If possible, use a mechanical protective cover for exposed encoders
- It is not advisable to use friction wheels

Enter / Verify the encoder pulses entered in the ENCODER PULSES (A1) parameter matches the encoder's nameplate.

Motor Parameter Set-up

Enter / Verify the following from the motor's nameplate:

1. Motor Current (RATED MTR CURRENT (A6))
2. Motor Voltage (RATED ARM VOLTS (A6))
3. Motor field amps, forcing (FULL FLD AMPS (A6))
4. Motor field amps, running (WEAK FLD AMPS (A6))
5. Motor field amps, standing (STNDBY FIELD (A6))

Hoist way Parameter Set-up

Enter / Verify the hoist way parameters:

1. CONTRACT CAR SPD (A1) parameter programs the elevator contract speed in ft/min or m/s.

Quattro DC Startup Guide

2. CONTRACT MTR SPD (A1) parameter programs the motor speed at elevator contract speed in RPM.

Line voltage setup

Enter / Verify the line voltage parameter:

1. INPUT L-L VOLTS (A5) parameter programs the line voltage level

Auto tune Procedure

Refer to page 95 on how to implement Auto tune if desired. Auto tune will automatically measure the motor's armature inductance, armature resistance including cable resistance, field resistance, and field time constant. Auto tune will also calculate the armature resistance voltage drop at motor rated current and the armature and field regulation gains.

(C1, C2, C3, C4) configuration setup

It will be required to adjust the configuration menus to operate the Quattro as the elevator manufacturer has specified to interact with the car controller. Magnetek does not supply this data.

Low speed inspection mode

Run the drive in low speed inspection mode and...

1. Verify encoder polarity, the motor rotation should match the encoder phasing. The equivalent of swapping A and /A can be done with the ENCODER CONNECT (C1) parameter.
2. Verify proper hoist way direction. This can be reversed with the MOTOR ROTATION (C1) parameter.

WARNING

If using an external speed regulator, which produces an analog torque command to Quattro (SPEED REG TYPE (C1) = external reg and EXT TORQ CMD SRC (C1) = analog input), it is imperative that the encoder polarity matches the armature voltage. To verify polarity, insert a torque command into the analog input. Check ENCODER SPD (D2) against ARMATURE VOLTAGE (D2). Verify they are the same polarity. If not, swap A and /A or change the ENCODER CONNECT (C1) parameter.

Verify that the Safety Chain / Emergency Stop works.

Interconnections

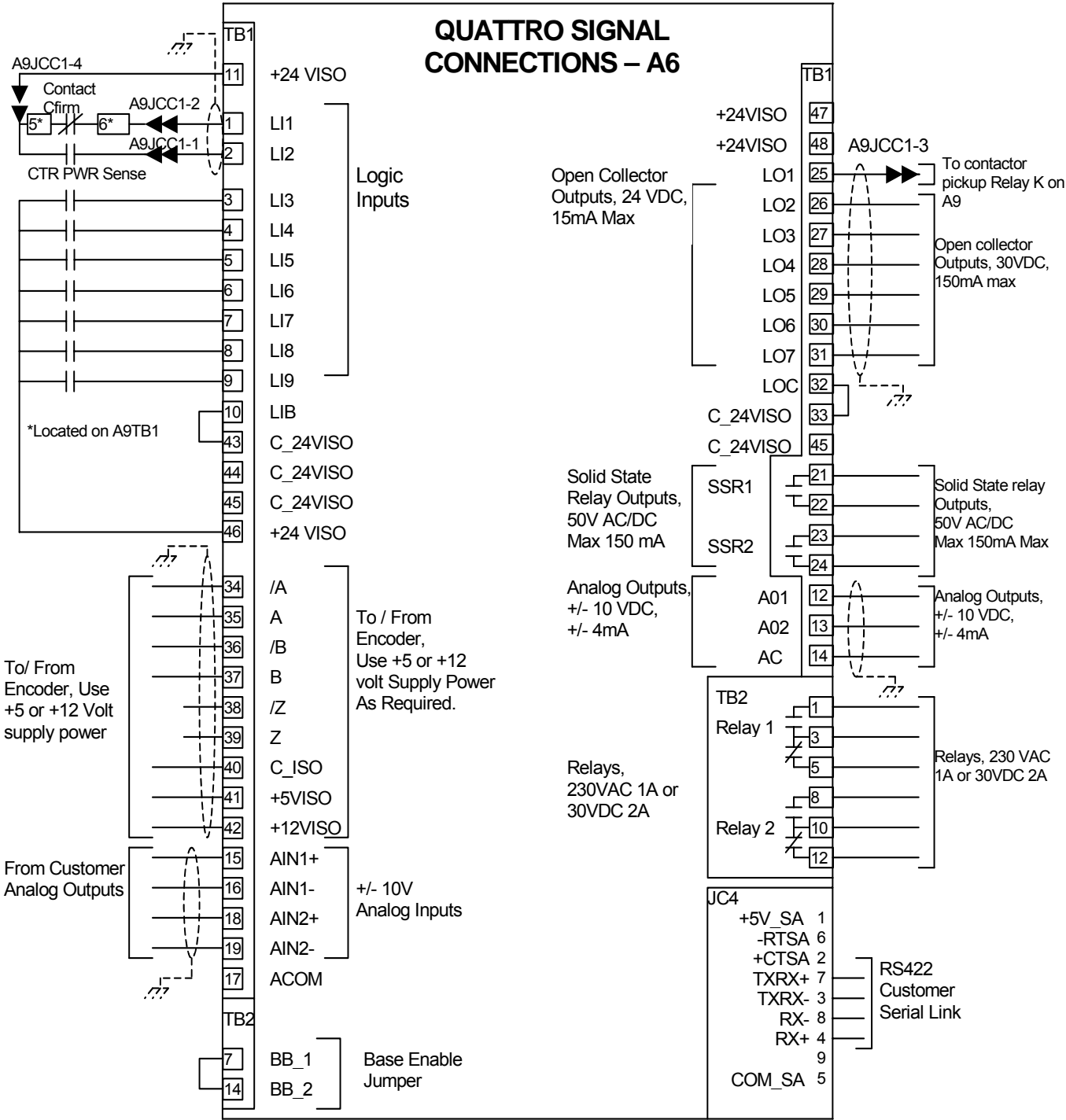

Figure 1: Interconnection Diagram

Encoder Connections

The Quattro DC has connections for an incremental two-channel quadrature encoder.

The Quattro DC requires the use of an encoder coupled to the motor shaft. The encoder power can be either a +5VDC or +12VDC.

The encoder pulses per revolution must be entered in the ENCODER PULSES parameter in the A1 submenu.

Figure 3 shows the encoder connection terminals for non-single ended applications.

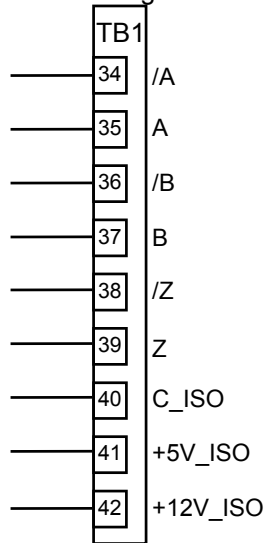

Figure 3: Encoder Connections

Below shows the connection for the encoder option card, if they are configured to be single ended. This configuration is not recommended, since, the Quattro DC encoder noise immunity circuitry is not in effect.

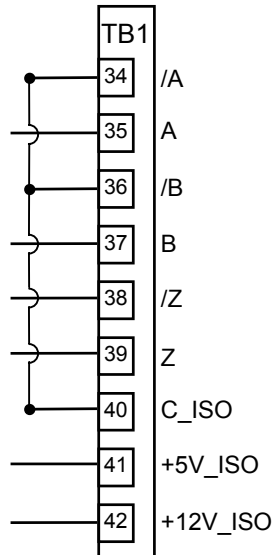

Figure 4: Encoder Connections (Single-Ended)

Logic Inputs

The Quattro DC’s nine programmable logic inputs are opto-isolated. *For more information on programming logic inputs, see Logic Inputs C2 submenu on page 61.* The inputs become “true” by closing contacts or switches between the logic input terminal and voltage source common (or voltage source). The inputs are sourcing inputs – nominally sitting at common and when the contacts or switches are closed, turning “true” at 24VDC. The voltage supply for the logic inputs is 24VDC.

IMPORTANT

Internal 24VDC power supply has a capacity of 100 mA

Note: Logic input 1 and 2 are reserved and pre-wired for CONTACT CFIRM and CTR PWR SENSE respectively.

The choices for the voltage source common (or voltage source) depend on if the user is using an external voltage supply or using the internal voltage supply. See Figure 5 for internal supply example and Figure 6 for external supply example.

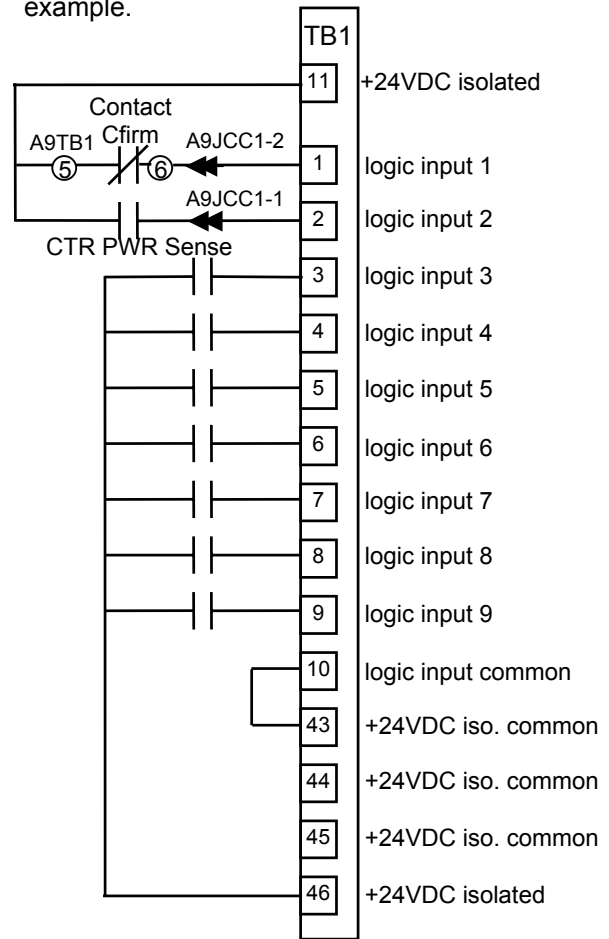

Figure 5: Logic Input Diagram (Internal Supply)

Quattro DC Interconnections

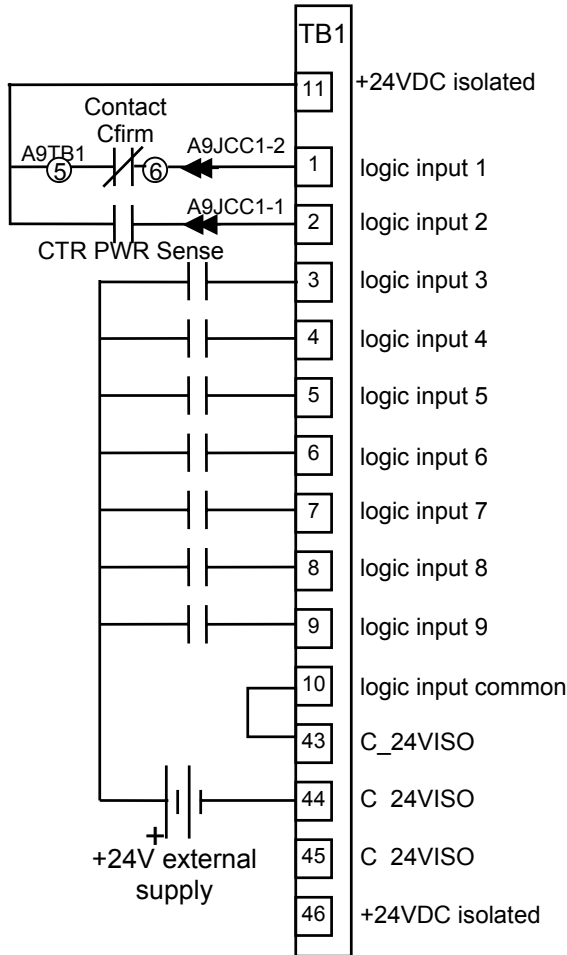

Figure 6: Logic Inputs (External Supply)

Analog Inputs

The Quattro DC has two non-programmable differential analog input channels.

- Analog input channel 1 is reserved for the speed command (if used).
- Analog input channel 2 is reserved for the pre-torque command (if used) or torque command source (if used).

The analog input channels are bipolar and have a voltage range of $\pm 10\text{VDC}$.

Available with the analog channels is multiplier gain parameters (SPD COMMAND MULT and EXT TORQUE MULT) and bias parameters (SPD COMMAND BIAS and EXT TORQUE BIAS). These parameters are used to scale the user's analog command to the proper range for the drive software. The formula below shows the scaling effects of these two parameters.

$$\left(\begin{array}{c} \text{analog} \\ \text{channel} \\ \text{input} \\ \text{voltage} \end{array} - \text{BIAS} \right) \times \text{MULT} = \begin{array}{c} \text{signal} \\ \text{drive} \\ \text{software} \\ \text{uses} \end{array}$$

For more on the multiplier gain or bias parameters, see Drive A1 submenu on page 30.

The scaling of the analog input signals, with BIAS set to 0.00 and MULT set to 1.0 follows:

- Speed Command
 - +10VDC = positive contract speed
 - 10VDC = negative contract speed
- Pre Torque Command
 - +10VDC = positive rated pre-torque of motor
 - 10VDC = negative rated pre-torque of motor
- Torque Command
 - +10VDC = positive rated torque of motor
 - 10VDC = negative rated torque of motor

NOTE: The drive cannot recognize voltages outside of the $\pm 10\text{VDC}$ on its analog input channels.

The Quattro DC provides common mode noise rejection with the differential analog inputs. The connection of these two differential inputs is shown in Figure 7.

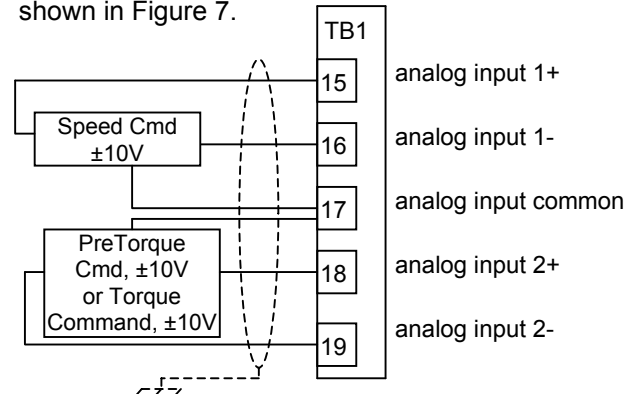

Figure 7: Analog Inputs (Differential)

Figure 8 shows the connection for the analog inputs if they are configured for single-ended connection. In this configuration, the Quattro DC noise immunity circuitry is not in effect.

Note: For prevention of ground noise interference, a twisted shielded pair must be run to the source and not connected at the board.

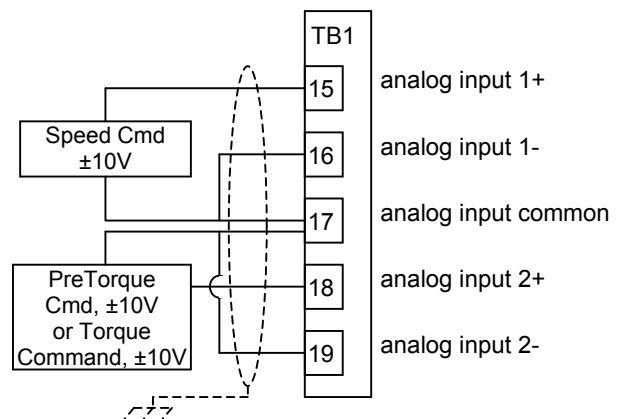

Figure 8: Analog Inputs (Single Ended)

Logic Outputs

The Quattro DC’s seven programmable logic outputs are opto-isolated, open collector. The outputs are normally open and can withstand an applied maximum voltage of 30VDC. When the outputs become “true”, the output closes and is capable of sinking up to 150mA between the logic output terminal and the logic output common (TB1-32). Figure 9: Logic Outputs shows the logic output terminals.

Note: Logic Output 1 is prewired for CLOSE CONTACT.

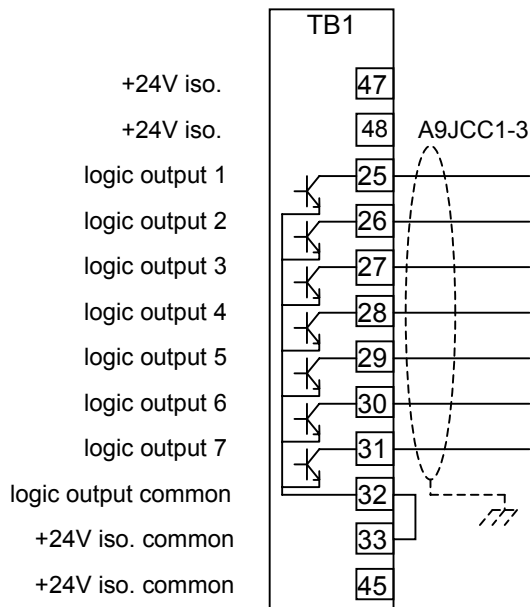

Figure 9: Logic Outputs

For more information on programming the logic outputs, see Logic Outputs C3 submenu on page 63.

Relay Outputs

The Quattro DC’s two programmable relay logic outputs are Form-C relays. They have both normally open and normally closed contacts.

The specifications for each relay are as follows:

Relay 1

- 2A at 30VDC or 1A at 230VAC

Relay 2

- 2A at 30VDC or 1A at 230VAC

Figure 10: Relay Outputs shows the logic output terminals.

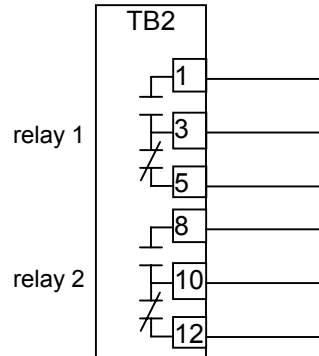

Figure 10: Relay Outputs

For more information on programming the relay outputs, see Logic Outputs C3 submenu on page 63.

Solid State Relay Outputs

The Quattro DC has two programmable solid-state relays. They have a 30 VDC max with 150mA load capability.

Figure 11: Solid State Relay Outputs shows the relay output connections.

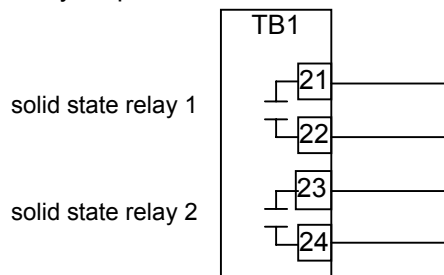

Figure 11: Solid State Relay Outputs

For more information on programming the solid-state relays, see Logic Outputs C3 submenu on page 63.

Quattro DC Interconnections

Analog Outputs

The Quattro DC has two programmable differential analog output channels. The two analog output channels were designed for diagnostic help. *For more information on programming the analog output channels, see Analog Outputs C4 submenu on page 65.*

The analog output channels are bipolar and have a voltage range of $\pm 10\text{VDC}$ and current draw of $\pm 4\text{mA}$.

Available with the analog channels is multiplier gain parameters (ANA 1 OUT GAIN and ANA 2 OUT GAIN) and a bias or offset parameters (ANA 1 OUT OFFSET and ANA 2 OUT OFFSET). These parameters are used to scale the user's analog outputs to the proper range for the drive software. The formula below shows the scaling effects of these two parameters.

$$\left(\begin{array}{l} \text{signal} \\ \text{drive} \\ \text{software} \\ \text{creates} \end{array} - \text{OFFSET} \right) \times \text{GAIN} = \begin{array}{l} \text{analog} \\ \text{channel} \\ \text{output} \\ \text{voltage} \end{array}$$

For more on the gain or offset parameters, see section Drive A1 submenu on page 30.

The connection of these two outputs is shown in Figure 12: Analog Outputs.

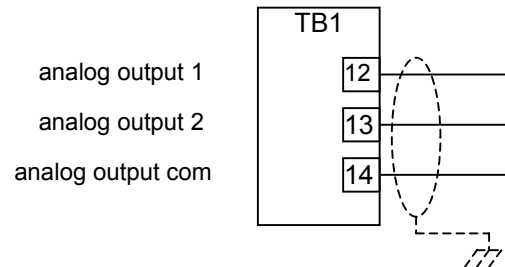

Figure 12: Analog Outputs

For more information on programming the Analog Outputs, see Analog Outputs C4 submenu on page 65.

Drive Sequencing

NORMAL operating sequence

1. Motor field current is at Stand-By during drive idle. The No Faults relay is active. Full-Field and Run command signals are OFF. Motor contactor Safety circuits may be open or closed. The DC bus will remain charged with regulated voltage as long as the drive is providing motor field current.
2. A Field Enable Command, programmable by FLD ENA SRC (C1), is sent to the drive. If the DC bus is not pre-charged, a pre-charge cycle will be completed before motor field current is restored. See Quattro Pre-Charge on page 22 for timing information of the Pre-Charge circuit. Motor field current will go to the Full-Field value in preparation to produce motor torque.

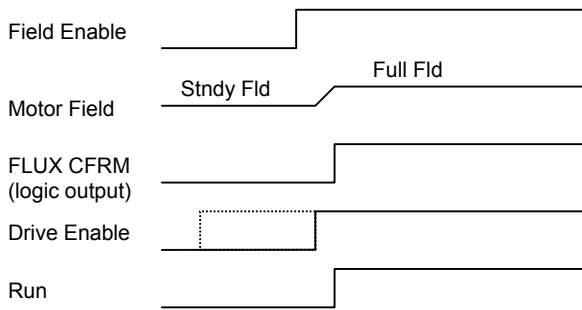

3. Pre-Torque command value is sent to the drive. It must be available before a run command is given. If the Pre-Torque Latch is used, see Pre-Torque Latch (C1), it can be placed inactive depending on the settings of Pre-Torque Latch Clk (C1). If latching is not used, it must remain active until the SPD REG RLS output is active. Safety circuit relays are closed making power available to the contactor coil circuit.

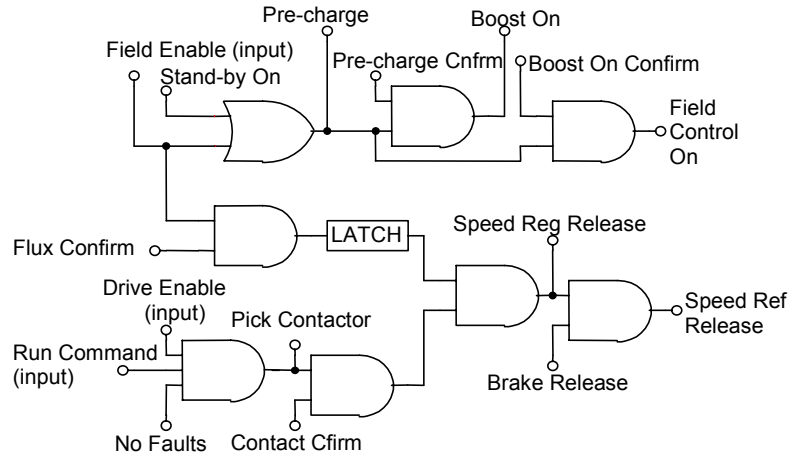
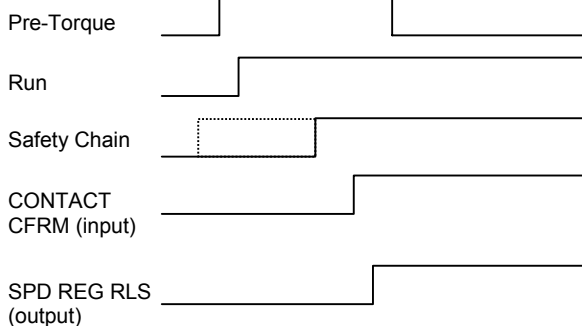

4. Once the regulators are released, motor current starts at pre-torque amperes. The velocity regulator starts at zero speed. (All conditions of 3. must be present and motor field current must be greater than the sensing threshold before the drive will start. This is noted by the output Flux Confirm (programmable by Flux Cnfrm Level (A6)).
5. Drive activates elevator Brake relays, if programmed to do so (or the car controller does it externally).
6. Drive follows the external or internal velocity profile via the programmed accel/decel rate as programmed during the remainder of the elevator run cycle.
7. When at the next landing...the Drive (or car controller) de-activates elevator Brake.
8. After the Brake has set, the Run command is removed causing...
9. Reference speed to be clamped to zero.
10. Motor torque ramps down to zero, then the Motor contactor is opened.

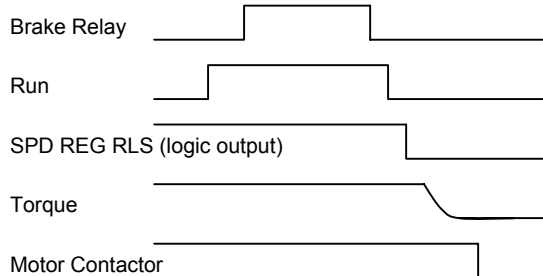

11. While idle, motor field current reference will drop to Stand-By, after the Full-Field timer expires. Safety circuit relays may (or may not) open to remove contactor-actuating power.
12. A DSPR time-out may occur while field current is at stand-by. In that case motor field current goes to zero and the AC main power contactor to the drive is opened. A pre-charge cycle and power on recovery will occur on the next command to re-establish motor field current.

Quattro DC Drive Sequencing

ABNORMAL Operation Sequence

1. If a Drive or Drive Sequence Fault occurs the Drive will immediately open the motor contactor, de-energize the Brake Pick, Brake Hold, and Drive OK Relays if so programmed. May be caused by:
 - a. "Fatal Error" drive Faults including loss of serial communications
 - b. Opening of the contactor power Safety circuit while the contactor is pulled in
 - c. Loss of correct motor contactor or Brake Relay feedback.
2. If an Alarm occurs, the drive will signal an Alarm but continue to run. May be caused by:
 - a. Drive Alarms including motor overload, drive over temp warning
 - b. Loss of correct feedback from Brake Hold relay or Brake Switches
 - c. Open motor thermostat circuit
 - d. Speed command is held at zero due to conflict with the analog speed command polarity and the run up/ run down logic
 - e. Encoder Fault (C1) set to disabled
 - f. The drive is or was being limited by the motor torque limit setting (Hit Torque Limit)
 - g. Speed feedback is failing to properly track the speed reference (Speed Dev)
 - h. DC bus voltage drops below user specified percent of the input line to line voltage
3. DC bus is Pre-Charged
 - a. With pre-charge contactor PCM closed, separate resistor and rectifier circuits limit capacitor charging inrush current.
 - b. Bus voltage is monitored during pre-charge to verify proper voltage build-up. (See 6.a. below)
 - c. Target bus voltage is nominal input VAC (INPUT L-L VOLTS (A5)) X $\sqrt{2}$.
4. Mains contactor is closed
 - a. As measured DC bus voltage nears target value main utility power contactor UTM closes.
 - b. Aux contact feedback from UTM indicates to controls that main utility contactor is closed.
 - c. Then Pre-charge contactor PCM is opened. (See 6.b. below)
5. Boost converter is turned ON.
 - a. DC bus voltage is boosted to a higher level as programmed by the Boost Level parameter setting in order to achieve near unity power factor and low harmonic content of the Quattro drive.
 - b. Motor field controls also turn ON to begin regulating motor field current and/or operate main motor armature circuits.
 - c. The boost converter will remain ON as long as any field or armature current is being provided to the motor. (See 6.c. below) Time-out of the DSPR (Drive Stand-by Power Reduction) feature or other command may turn the Boost converter OFF when drive is idle although standby field will still be present. In that case as new pre-charge cycle must occur before drive re-start.

Quattro Pre-Charge

When power is first applied to the Quattro drive, or after it has shut itself down via a DSPR time-out, the internal DC bus must be pre-charged before operation can resume.

The following sequence will occur:

1. Power is applied to the Quattro drive
 - a. Control power may be applied before or after 3-phase main power
 - b. Some OEM drive versions may have a built-in control transformer
 - c. Drive controls should become active but no contactors should operate
2. Quattro drive receives command to 'energize'
 - a. This command may be from serial link software or hardware logic command to deliver motor field current in preparation to start.
 - b. AC input voltage from mains is measured and verified to be adequate according to the setting of the VAC-input adjustment parameter.
 - c. Pre-charge contactor PCM is then pulled in. This provides resistor limited inrush current to DC bus capacitors from AC mains and separate rectifier.
3. DC bus is Pre-Charged
 - a. With pre-charge contactor PCM closed, separate resistor and rectifier circuits limit capacitor charging inrush current.
 - b. Bus voltage is monitored during pre-charge to verify proper voltage build-up. (See 6.a. below)
 - c. Target bus voltage is nominal input VAC (INPUT L-L VOLTS (A5)) X $\sqrt{2}$.
4. Mains contactor is closed
 - a. As measured DC bus voltage nears target value main utility power contactor UTM closes.
 - b. Aux contact feedback from UTM indicates to controls that main utility contactor is closed.
 - c. Then Pre-charge contactor PCM is opened. (See 6.b. below)
5. Boost converter is turned ON.
 - a. DC bus voltage is boosted to a higher level as programmed by the Boost Level parameter setting in order to achieve near unity power factor and low harmonic content of the Quattro drive.
 - b. Motor field controls also turn ON to begin regulating motor field current and/or operate main motor armature circuits.
 - c. The boost converter will remain ON as long as any field or armature current is being provided to the motor. (See 6.c. below) Time-out of the DSPR (Drive Stand-by Power Reduction) feature or other command may turn the Boost converter OFF when drive is idle although standby field will still be present. In that case as new pre-charge cycle must occur before drive re-start.
6. Problem prevention
 - a. If DC bus voltage does not rise at the expected rate to the expected voltage level during pre-charge a "Charge Fault" is declared.
 - b. UTM and PCM are interlocked with aux contacts such that UTM cannot be picked unless PCM is already closed. Once picked, an aux contact of UTM seals the same circuit allowing PCM to be dropped with UTM remaining ON.
 - c. In the event of a major drive Fault, UTM will be opened to disconnect utility lines from main power devices of Quattro.

Drive Operation and Feature Overview

The Quattro DC drive is a velocity and torque regulated motor drive designed specifically for operating elevators. Many of the features described below can be selectively programmed to customize an individual application.

Analog Velocity Follower

The elevator car controller provides an analog velocity reference to the drive at A6TB1-15 and A6TB1-16. The signal may be bi-polar +/- 10 VDC to indicate speed and travel direction, or a positive only unipolar signal with the direction of travel selected by logic commands. In most cases the signal profile will be adjusted by the car controller for precise landing positioning. The velocity reference passes directly to the closed loop velocity controller, except for an internal rate limiter to buffer any unexpected electrical noise. Start and Stop commands are via 24VDC logic inputs. Calibration of the analog velocity reference signal may be adjusted with separate gain and offset parameters. To set the Analog Velocity Follower, the user must set SPD COMMAND SRC (C1) to Analog Input.

Preset Speed & Profile Generator

An alternate method of speed control is that the elevator car controller provides 24VDC logic input commands to select one of 15 pre-determined running speeds. The drive generates a smooth S-Curve acceleration profile to transition between speed selections. Either of three separately adjustable ramp times may be selected. The direction of travel may be determined by either a Run command with an Up/Down command signal or by separate Run-Up / Run-Down logic commands. To set the Analog Velocity Follower, the user must set SPD COMMAND SRC (C1) to Multi-Step, then adjusting Multi-Step Speed Commands in the Multi-Step Submenu A3.

Serial Link Follower

The elevator car controller provides the equivalent of an analog reference command over a digital serial link. The drive returns operating status conditions and messages. Primary run command are 24VDC logic for redundant safety if wanted. The speed sensitivity of the serial velocity reference is adjustable. Enabling the serial link follower

requires SPD COMMAND SRC (C1) to be set to SERIAL.

Pre-Torque

When enabled, the speed error integrator will be pre-conditioned by the supplied pre-torque signal before starting the regulator. This will cause motor armature current to begin at a magnitude proportional to the pre-torque command to prevent elevator motion or rollback when the elevator brake is released. The pre-torque signal will be from either an analog (wired at A6TB1-18 and A6TB1-19) or serial link digital source as selected by programming PRETORQUE SOURCE (C1). If Pre-Torque is not used, leave PRETORQUE SOURCE (C1) at the defaulted value of none. An EXT TORQUE BIAS (A1) and an EXT TORQUE MULT (A1) are available to scale the pre-torque signal. Ten volts = rated motor current with a multiplier of 1 and a bias of zero.

Torque Feed Forward

Some car controllers may calculate an accurate demand for motor torque as required to accelerate the connected load as well as hold it against gravity. The torque demand signal can be programmed to directly drive the torque control part of Quattro from either an analog or serial link input. EXT TORQ CMD SRC (C1) must be set to either analog input or serial and SPEED REG TYPE (C1) must be set to either pi speed reg, elev spd reg, or external reg. The connections for an analog external torque command source are A6TB1-18 and A6TB1-19. With an accurate torque compensating signal, the gain of the PI regulator can be reduced, to better ignore and not amplify mechanical vibrations of the hoist way. Separate adjustments are provided for torque signal gain and offset. An EXT TORQUE BIAS (A1) and an EXT TORQUE MULT (A1) are available to scale the torque signal. Ten volts = rated motor current with a multiplier of 1 and a bias of zero.

Torque/Current Ramp-Down

When the drive is told to cease operation by removal of the Run logic command, (and after Brake Drop time if that function is engaged) the armature current reference ramps down to zero at a constant rate. This allows the mechanical Brake to gently assume elevator holding torque, reducing the tendency to 'thump' the brake. When armature current ramp-down is complete, the contactor will be opened. In the event that the contactor opens unexpectedly, as reported by the feedback contact or in the event of a severe drive fault,

Quattro DC Drive Operation and Feature Overview

there will be no timed delay for current ramp-down. This time may be adjusted by the function RAMPED STOP TIME (A1).

Motor Field Current Control and Field weakening

DC elevator motors have a separately excited shunt field. Adjustments include Stand-By Current, Full-Field Current and Weak-Field Current, all programmed in amperes, and a Flux Confirm Level, programmed as a % of Full-Field. With no active Full-Field or drive Run command motor field current would normally be at Stand-By amps. An active command to provide Full Field causes field current to increase to the Full Field setting. When Field current is greater than the Full-Field threshold setting (and there are no other faults) the DC motor contactor will be enabled to pull in when told to do so by an active drive Run command. When the motor contactor is acknowledged as being closed, the motor armature current regulator is released to follow the commanded torque reference current signal. Motor field current will remain at the Full-Field value as long as the per unit (pu) reference or measured speed (whichever is greater) is less than the pu ratio of WF/FF amps. Above that speed motor field current will automatically follow the constant CEMF profile of $WF/FF \times 1/spd$, where speed is again the greater active value of reference or measured speed. When motor speed reduces from high speed, motor field current automatically increases according to the constant CEMF calculated profile. However, field current will not increase to be more than the Full field ampere setting.

DSPR

While the drive is idle with Stand-By Current being applied to the motor field, a second timer for Drive Stand-by Power Reduction (DSPR) will be running. When/If the DSPR timer times-out, motor field current will turn completely Off and the main 3-phase power to the drive will be removed. This helps save electrical energy during long periods of non-use. Recovery of this condition will be automatic upon the receipt of the next "Full-Field" or "Run" command. At that time, recovery from a DSPR power OFF condition may take several seconds. DSPR TIME can be set in the Drive A1 Submenu.

Over-Speed Test

A reference speed multiplier is provided to help testing of the elevator governor over-speed trip. This feature will automatically return to normal at the completion of each elevator run. However, to ensure that the drive Over-Speed Trip does not interfere with the governor test, one must temporarily raise the value set for the Drive Over-Speed Trip point to a value higher than that of the governor.

Fault & Alarm Reset

An external Fault Reset command signal from the car controller may be applied to a logic input or from a serial command link. Or, an automatic Fault Reset will occur 5 seconds after a drive fault occurs, when enabled to do so. Either method may be used to enable the car controller to quickly recover from a re-settable fault. One Fault will be subtracted from a fault count accumulation every 20 minutes. The maximum number of Auto-Resets that can be accumulated is 5. The Auto-Reset function will then require a power Off/On cycle in order to recover. Faults & Alarms may also be cleared by use of the Magnetek Operator.

Electronic Motor Over-Load

An electronic motor over-load function is provided to take the place of heater type power components. Motor armature current is continuously monitored and the heating effect is calculated over time. A motor overload trip will not automatically stop the drive, but is an important alarm signal to elevator car controller to help prevent equipment damage.

Armature Voltage Feedback

This is a temporary 'construction' or trial mode for proving out direction orientation of the motor and operation of the encoder. Motor speed regulation is controlled by armature voltage feedback with IR compensation. Precise speed regulation is not possible. Operation above base speed of the motor is not possible since the field weakening is inhibited. However, it is still possible to monitor the feedback from the encoder although it will not be used for speed regulation. Successful operation in this mode may require reduced gain settings. This is selectable by setting SPD REG TYPE (C1) to CEMF REG.

Status Indicator Lights

Five status indicator lamps are provided on the front panel of the drive.

READY – (GRN) Power is applied to the drive, there are no drive Faults and drive is ready to Run when requested. The Run light will blink slowly when it is in DSPR (Drive Standby Power Reduction) Mode or not boosting, but three-phase power is applied.

RUN – (GRN) Indicates that the motor contactor is closed and the drive is following applied references operating to control torque and speed

PROGRAM INVALID – (RED) There is no valid program loaded.

FAULT – (Red) A drive Fault exists that is preventing the drive from operating

CURRENT LIMIT – (YEL) Motor current is being limited

MONITOR / Adjust / Set-up Parameters:

The values of all adjustments and set up parameters are stored locally in non-volatile drive memory. Monitoring of live data status and modification of parameter values can be accomplished by sequences over the serial link or the Magnetek Operator. They can both be attached at the same time to modify parameters or monitor drive operation. Detailed descriptions of all adjustments are located in later sections of this manual.

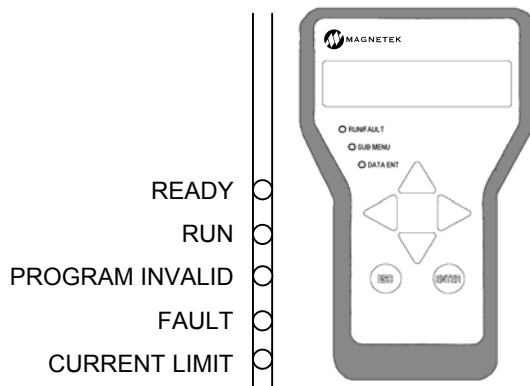

Parameters

Parameter Introduction

This section describes the parameter menu structure of the Magnetek Operator, how to navigate this menu structure, and a detailed description of each parameter.

Parameters are grouped under six major menus:

- ADJUST A0
- CONFIGURE C0
- UTILITY U0
- FAULTS F0
- DISPLAY 1 D0
- DISPLAY 2 D0

When the SUB-MENU LED is off, the currently selected menu is shown on the top line of the Digital Operator display and the currently selected sub-menu is shown on the bottom line of the Digital Operator display.

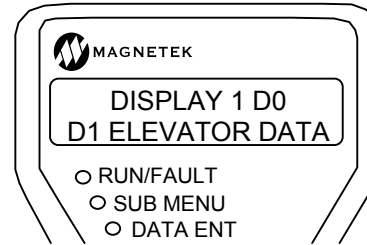

Menus

Each menu has a number of sub-menus. Following is a listing of the menus:

- ADJUST A0
- CONFIGURE C0
- UTILITY U0
- FAULTS F0
- DISPLAY 1 D0
- DISPLAY 2 D0

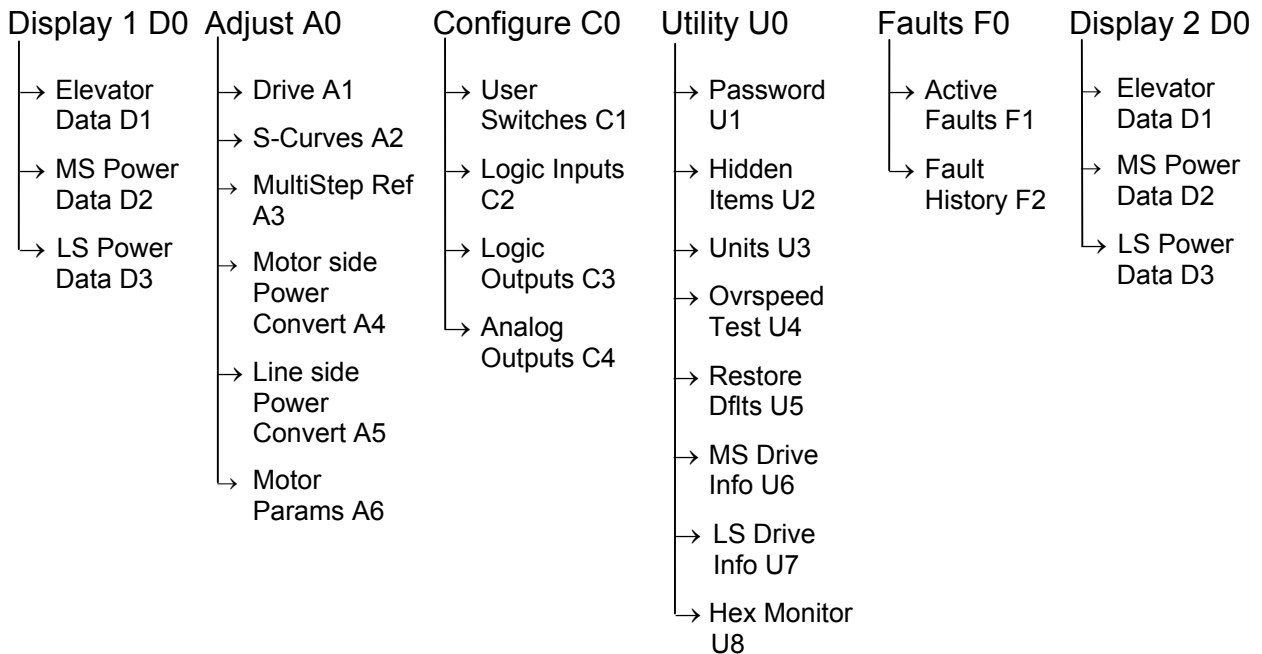

Menu/Sub-Menu Tree

Menu Navigation

The digital operator keys operate on three levels, the menu level, the sub-menu level and the entry level. At the menu level, they function to navigate between menus or sub-menus. At the sub-menu level, they navigate between sub-menus or menu items. At the entry level, they are used to adjust values or select options. Six (6) keys are used for this navigation; they are shown below:

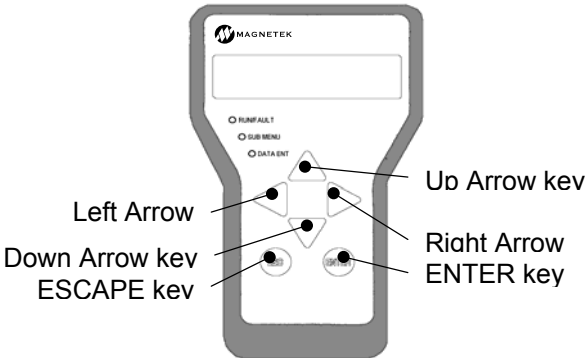

Digital Operator Keys

How these keys operate is dependent on the “level” (i.e. menu, sub-menu or entry level.) In general, the “ENTER” and “ESCAPE” keys control the level. That is the ENTER key is used to move to a lower level and the ESCAPE key is used to move to a higher level. The arrow keys control movement. The up and down arrow keys control vertical position and the left and right arrow keys control horizontal position.

Navigation at the Menu Level

At the menu level, the up and down arrow keys cause the display to show the sub-menus. The side arrow keys cause the display to select which menu is active. When the end is reached (either up, down, left or right), pressing the same key will cause a wrap around.

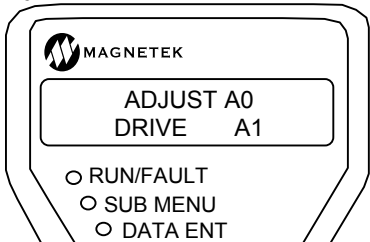

Each menu will remember the last accessed sub-menu. The left and right arrow keys will navigate between these last active sub-menus. This remembrance of last active sub-menu is volatile and will be lost at power down.

When any sub-menu is displayed, pressing the “ENTER” key will place the operator in the sub-menu level.

Navigation at the Sub-menu Level

When in the sub-menu level, the SUB-MENU LED on the digital operator is lit. At the sub-menu level, the positioning keys work slightly different than they did at the menu level. The up and down arrow keys now select separate items in the sub-menu.

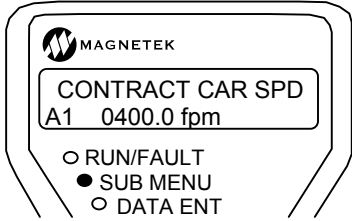

At any time pressing the “ESCAPE” key will return to the menu level. Upon exiting a sub-menu via the “ESCAPE” key, the last item number is “remembered”. The next time this sub-menu is entered, it is entered at the “remembered” item number.

This feature can be used to obtain quick access to two monitor values. Two menus one labeled Display 1 D0 and one labeled Display 2 D0 have the same display items. One item can be selected one under the Display 1 menu and another under the Display 2 menu. The left and right arrow keys can then be used to move back and forth between these two display items. Remember, that the “remembering” of sub-menus and sub-menu items is volatile and is lost at power-down.

Navigation at the Entry Level

When in the entry level, the DATA ENT LED on the digital operator is lit. At the entry level, the function of keys are redefined. The “ESCAPE” key remains as the key used to move back to the sub-menu level. The left and right arrow keys are used as cursor positioning keys and the up and down arrow keys are used as increment and decrement keys.

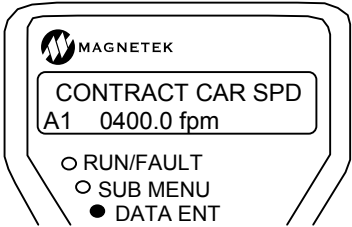

Hidden Parameters

There are two types of parameters: standard and hidden. Standard parameters are available at all times. Hidden parameters are for more advanced functions and are available only if activated. Activation of the hidden parameters is accomplished by setting of a utility parameter, HIDDEN ITEMS U2.

Parameter Tree

Display D0

→ Elevator Data D1

- Speed Command
- Speed Reference
- Speed Feedback
- Speed Error
- Pre-Torque Ref
- Ext-Torque Cmd
- Spd Reg Torq Cmd
- Tach Rate Cmd
- Aux Torque Cmd
- Est Inertia
- Rx Com Status
- Logic Outputs
- Logic Inputs

→ MS Power Data D2

- Arm Current
- Field Current
- Arm voltage
- MS Bus Voltage
- Motor Mode
- Torque Ref
- Est Spd Fdbk
- Encoder Spd
- DS Module Temp
- LS Module Temp
- Highest Temp
- Field IGBT Temp
- Armature Cur Err
- Auto Fld Int
- Auto Fld Prop
- Auto Meas Arm L
- Auto Meas Arm R
- Auto Field Res
- Auto Field TC

→ LS Power Data D2

- LS Pwr Output
- DC Bus Voltage
- DC Bus Volts Ref
- LS Overload
- LS Input Current
- LS D Axis I
- LS Q Axis I
- LS D Axis Volts
- LS Q Axis Volts
- Input Hz
- Input Vab
- Input Vbc
- LS Module Temp

Adjust A0

→ Drive A1

- | | | |
|--|---|--|
| <ul style="list-style-type: none"> • Contract Car Spd • Contract Mtr Spd • Response • Inertia • Inner Loop Xover • Current Limit • Gain Reduce Mult • Gain Chng Level • Tach Filter BW • Tach Rate Gain • Spd Phase Margin • Ramped Stop Time • Contact Flt Time • Brake Pick Time • Brake Hold Time • Overspeed Level | <ul style="list-style-type: none"> • Overspeed Time • Overspeed Mult • Encoder Pulses • Spd Dev Lo Level • Spd Dev Time • Spd Dev Hi Level • Spd Command Bias • Spd Command Mult • Ext Torque Bias • Ext Torque Mult • Zero Speed Level • Zero Speed Time • Up/Dwn Threshold • Ana Out 1 Offset • Ana Out 2 Offset • Ana Out 1 Gain | <ul style="list-style-type: none"> • Ana Out 2 Gain • Flt Reset Delay • Flt Resets/Hour • Up To Spd Level • Run Delay Timer • AB Zero Spd Level • AB Off Delay • Contactor DO Dly • Trq Lim Msg Dly • Rollback Gain • Notch Filter Frq • Notch Filt Depth • Stndby Fld Time • DSPR Time • Full Field Time |
|--|---|--|

→ S-Curves A2

- | | | |
|--|---|---|
| <ul style="list-style-type: none"> • Accel Rate 0 • Decel Rate 0 • Accel Jerk In 0 • Accel Jerk Out 0 • Decel Jerk In 0 • Decel Jerk Out 0 • Accel Rate 1 • Decel Rate 1 | <ul style="list-style-type: none"> • Accel Jerk In 1 • Accel Jerk Out 1 • Decel Jerk In 1 • Decel Jerk Out 1 • Accel Rate 2 • Decel Rate 2 • Accel Jerk In 2 • Accel Jerk Out 2 | <ul style="list-style-type: none"> • Decel Jerk In 2 • Decel Jerk Out 2 • Accel Rate 3 • Decel Rate 3 • Accel Jerk In 3 • Accel Jerk Out 3 • Decel Jerk In 3 • Decel Jerk Out 3 |
|--|---|---|

→ Multistep Ref A3

- | | | |
|---|--|--|
| <ul style="list-style-type: none"> • Speed Command 1 • Speed Command 2 • Speed Command 3 • Speed Command 4 • Speed Command 5 | <ul style="list-style-type: none"> • Speed Command 6 • Speed Command 7 • Speed Command 8 • Speed Command 9 • Speed Command 10 | <ul style="list-style-type: none"> • Speed Command 11 • Speed Command 12 • Speed Command 13 • Speed Command 14 • Speed Command 15 |
|---|--|--|

→ MS Pwr Convert A4

- | | | |
|--|--|--|
| <ul style="list-style-type: none"> • Arm Resistance • Arm Inductance • Mtr Rev Vlt Lim • If Reg Int Gain • If Reg Prop Gain | <ul style="list-style-type: none"> • Auto Tune Motor • Gain Selection • Gain Bandwidth A • Gain Bandwidth F • PWM Frequency | <ul style="list-style-type: none"> • Fan Off Delay • Main Fan Control • UV Alarm Level • UV Fault Level • Fld Carrier Frq |
|--|--|--|

→ LS Pwr Convert A5

- | | | |
|--|---|---|
| <ul style="list-style-type: none"> • Id Reg Prop Gain • Id Reg Intgrl Gn • Iq Reg Prop Gain • Iq Reg Intgrl Gn | <ul style="list-style-type: none"> • DC Bus Reg P Gn • DC Bus Reg I Gn • Input L-L Volts • DC Bus V Boost | <ul style="list-style-type: none"> • SW Bus OV Level • Bus Vref Source • PLL Filter Fc • LS PWM Frequency |
|--|---|---|

→ Motor A6

- | | | |
|---|---|---|
| <ul style="list-style-type: none"> • Motor ID • Rated Motor Curr • Armature Volts • Full Fld Amps | <ul style="list-style-type: none"> • Weak Fld Amps • Stndby Field • Flux Confirm Lev | <ul style="list-style-type: none"> • Armature IR Drop • Ovid Start Level • Ovid Time Out |
|---|---|---|

Configure C0

→ **User Switches C1**

- Spd Command Src
- Run Command Src
- Field Ena Src
- Hi/Lo Gain Src
- Speed Reg Type
- Motor Rotation
- Encoder Connect
- Spd Ref Release
- Cont Confirm Src
- Tach Filter Enable
- PreTorque Source
- PreTorque Latch
- Ptorq Latch Click
- Fault Reset Src
- Overspd Test Src
- Brake Pick Src
- Brake Pick Cnfm
- Brake Hold Src
- Ramped Stop Sel
- Ramped Down En Src
- Brk Pick Flt Ena
- Brk Hold Flt Ena
- Ext Torq Cmd Src
- Dir Confirm
- S-curve Abort
- Encoder Fault
- Priority Message
- Stopping Mode
- Auto Stop
- DSPR Enable

→ **Logic Inputs C2**

- N.C. Inputs
- Logic Input 1 TB1-1
- Logic Input 2 TB1-2
- Logic Input 3 TB1-3
- Logic Input 4 TB1-4
- Logic Input 5 TB1-5
- Logic Input 6 TB1-6
- Logic Input 7 TB1-7
- Logic Input 8 TB1-8
- Logic Input 9 TB1-9

→ **Logic Outputs C3**

- Logic Output 1 TB1-25
- Logic Output 2 TB1-26
- Logic Output 3 TB1-27
- Logic Output 4 TB1-28
- Logic Output 5 TB1-29
- Logic Output 6 TB1-30
- Logic Output 7 TB1-31
- SS Relay 1 TB1-21/22
- SS Relay 2 TB1-23/24
- Relay Coil 1 TB2-1/3/5
- Relay Coil 2 TB2-8/10/12

→ **Analog Outputs C4**

- Analog Output 1 TB1-12
- Analog Output 2 TB1-14

Utility U0

→ **Password U1**

- New Password
- Enter Password
- Password Lockout

→ **Hidden Items U2**

- Hidden Items Enable

→ **Units U3**

- Units Selection

→ **Ovrspeed Test U4**

- Overspeed Test?

→ **Restore Dflts U5**

- Restore Motor Defaults
- Restore Drive Defaults
- Restore Utility Defaults

→ **MS Drive Info U6**

- MS Drive Version
- MS Drive Type
- MS S/W Date
- MS S/W Time
- MS FPGA Version
- MS Cube ID

→ **LS Drive Info U7**

- LS Drive Version
- LS Drive Type
- LS S/W Date
- LS S/W Time
- LS FPGA Version
- LS Cube ID

→ **Hex Monitor U8**

- Address

Faults F0

→ **Active Faults F1**

- Display Active Faults
- Reset Active Faults

→ **Fault History F2**

- Display Fault History
- Clear Fault History
- Display Fault Counters

Adjust A0 menu

Drive A1 submenu

Parameter	Description	Units	Default	Range	Hidden Item	Run lock out
CONTRACT CAR SPD	(Contract Car Speed) Adjusts the elevator contract speed in feet per minute (fpm) or meters per second (m/s).	fpm	400.0	0.0 – 1500.0	N	Y
		m/s	2.000	0.00 – 8.00		
CONTRACT MTR SPD	(Contract Motor Speed) Sets motor rpm when commanded to run at elevator contract speed. The speed regulator actually regulates RPM x Encoder PPR pulses per second. Trim this value to fine tune actual elevator speed.	rpm	1130.0	30.0 – 3000.0	N	Y
RESPONSE	(Response) Sets the sensitivity of the drive's speed regulator in terms of the speed regulator bandwidth in radians. The responsiveness of the drive as it follows the speed reference will increase as this number increases. If the number is too large, the motor current and speed will be jittery. If this number is too small, the motor will be sluggish.	rad/sec	10.0	1.0 – 20.0	N	N
INERTIA	(Per Unit System Inertia) This parameter is the inertia/torque ratio as seen by the drive. It affects internal gain of the speed regulator. This time in seconds is the time it would take the motor to accelerate a load-balanced elevator to contract speed at rated torque.	sec	2.00	0.25 – 50.00	N	N
INNER LOOP XOVER	(Inner Loop Crossover) This parameter is used as a stiffness factor. Higher settings make the drive more responsive to load changes and can help minimize rollback. Because of the amount of responsiveness due to a high setting, the drive is more sensitive to speed disturbances and this parameter can affect ride quality. Note: this parameter is only used when SPEED REG TYPE (C1) = ELEV SPD REG. See SPD PHASE MARGIN (A1) if using PI REG.	rad/sec	2.0	0.1 – 20.0	N	N
CURRENT LIMIT	(Armature Current Limit) This parameter sets armature current limit for DC motor applications.	%	200.0	0.0 – 275.0	N	N
GAIN REDUCE MULT	(Gain Reduce Multiplier) This parameter is the percent of 'response' the speed regulator should use in the 'low gain' mode. This value reduces the RESPONSE value when the drive is in 'low gain' mode. (i.e. setting this parameter to 100% equals no reduction in gain in the 'low gain' mode)	%	100	10 – 100	Y	N
GAIN CHNG LEVEL	(Gain Change Level) When the HI/LO GAIN SRC in submenu C1 is set to internal, the drive will control the high/low gain switch. This parameter sets the speed reference level, above which, the drive is in 'low gain' mode. Units in percent of rated speed. <i>For more information, see GAIN CHNG LEVEL on page 36.</i>	%	100.0	0.0 – 100.0	Y	N

Quattro DC Drive Parameters A1

Parameter	Description	Units	Default	Range	Hidden Item	Run lock out
TACH FILTER BW	(Tach Filter Bandwidth) Breakpoint of tachometer / encoder feedback signal.	rad/sec	100	1 – 100	Y	N
TACH RATE GAIN	(Tach Rate Gain) Used to help reduce the effects of rope resonance. It should be adjusted only <i>after</i> the INERTIA and RESPONSE have been set correctly.	none	0.0	0.0 – 30.0	Y	N
SPD PHASE MARGIN	(Speed Phase Margin) This parameter sets the phase margin of the speed regulator assuming a pure inertial load. This parameter is only in affect if SPEED REG TYPE (C1) is set to PI REG. See INNER LOOP XOVER (A1) if using ELEV SPD REG.	degs	80	45 – 90	Y	N
RAMPED STOP TIME	(Ramped Stop Time) This parameter is used only by the torque ramp down function during a stop and sets the time to decrease motor torque from rated torque to zero. After the elevator comes to a halt at a landing the brake is applied and the drive is told to turn off. However, components of the mechanical brake must 'set' ever so slightly in order to generate enough torque to hold the car. This small movement can cause a significant 'bump' if the transfer of torque occurs too quickly. This effect is essentially eliminated by the Torque Ramp Down function. The Ramped Stop Select function is enabled at (RAMPED STOP SEL(C1)). The Ramped Stop Time Parameter determines the rate of motor torque decay with ramped stop enabled. RAMPED STOP TIME(A1) determines the amount of time it would take for the drive to ramp from rated torque to zero torque. The actual time for torque decay to occur on a typical stop will depend on the actual amount of torque required to hold the car.	sec	0.20	0.00 – 2.50	Y	N
CONTACT FLT TIME	(Contactor Fault Time) Determines allowable time for motor contactor feedback to be out of sync with commanded state before a CONTACTOR FLT occurs.	sec	0.50	0.10 – 5.00	Y	N
BRAKE PICK TIME	(Brake Pick Time) If BRAKE PICK CNFM is set to INTERNAL TIME this parameter sets the internal time the drive waits until it assumes the brake has been picked. If BRAKE PICK CNFM is set to EXTERNAL TB, this parameter sets the time the drive waits until it receives a brake pick confirmation or a BRK PICK FLT will be declared.	sec	1.00	0.00 – 5.00	Y	N
BRAKE HOLD TIME	(Brake Hold Time) Determines the time the drive will wait until a BRK HOLD FLT is declared if a logic input is set to MECH BRK HOLD	sec	0.20	0.00 – 5.00	Y	N

Quattro DC Drive Parameters A1

Parameter	Description	Units	Default	Range	Hidden Item	Run lock out
OVERSPEED LEVEL	(Over speed Level) Sets the percentage of rated speed the drive uses (in conjunction with OVERSPEED TIME, below) to determine when an OVERSPEED fault occurs. Units in percent of contract speed	%	115.0	90.0 – 150.0	Y	N
OVERSPEED TIME	(Over speed Time) Sets the time that the drive can be at or above the OVERSPEED LEVEL (A1), before the drive declares an OVERSPEED FLT.	sec	1.00	0.00 – 9.99	Y	N
OVERSPEED MULT	(Over Speed Multiplier) Sets the percentage of CONTRACT CAR SPD (A1) for the OVERSPEED TEST (U4).	%	125.0	100.0 – 150.0	Y	N
ENCODER PULSES	(Encoder Pulses per Revolution, PPR) This parameter sets the pulses per revolution (per channel) the drive receives from the encoder. Set this value to agree with the pulses per revolution on the encoder nameplate if the tachometer is directly coupled to the motor shaft. If tachometer connected to rider roll to measure linear velocity, then this should be a calculated value equal to the counts expected from the encoder when the motor makes exactly one revolution.	PPR	5000	600 – 10000	N	Y
SPD DEV LO LEVEL	(Speed Deviation Lo Level) Range around the speed reference for speed deviation low logic output. Units are in percent of contract speed. See SPD DEV LO LEVEL and SPD DEV HI LEVEL on page 37.	%	10.0	0.1 – 20.0	Y	N
SPD DEV TIME	(Speed Deviation Time) This parameter defines the time the speed feedback needs to be in the range around the speed reference defined by SPD DEV LO LEVEL (A1) before the Speed Deviation Low logic output is true.	sec	0.50	0.00 – 9.99	Y	N
SPD DEV HI LEVEL	(Speed Deviation High Level) Level for declaring speed deviation alarm. Units are in percent of contract speed. See SPD DEV LO LEVEL and SPD DEV HI LEVEL on page 37.	%	10.0	0.0 – 99.9	Y	N
SPD COMMAND BIAS	(Speed Command Bias) This parameter subtracts an effective voltage to the actual analog speed command voltage signal. $\left(\begin{matrix} \text{analog} \\ \text{channel\#1} \\ \text{input} \\ \text{voltage} \end{matrix} - \begin{matrix} \text{SPD} \\ \text{COMMAND} \\ \text{BIAS} \end{matrix} \right) \times \begin{matrix} \text{SPD} \\ \text{COMMAND} \\ \text{MULT} \end{matrix} = \begin{matrix} \text{signal} \\ \text{drive} \\ \text{software} \\ \text{uses} \end{matrix}$	volts	0.00	0.00 – 6.00	Y	Y
SPD COMMAND MULT	(Speed Command Multiplier) This parameter scales the analog speed command. $\left(\begin{matrix} \text{analog} \\ \text{channel\#1} \\ \text{input} \\ \text{voltage} \end{matrix} - \begin{matrix} \text{SPD} \\ \text{COMMAND} \\ \text{BIAS} \end{matrix} \right) \times \begin{matrix} \text{SPD} \\ \text{COMMAND} \\ \text{MULT} \end{matrix} = \begin{matrix} \text{signal} \\ \text{drive} \\ \text{software} \\ \text{uses} \end{matrix}$	none	1.00	0.90 – 5.00	Y	Y

Quattro DC Drive Parameters A1

Parameter	Description	Units	Default	Range	Hidden Item	Run lock out
EXT TORQUE BIAS	<p>(External Torque Bias) This parameter subtracts an effective voltage to the actual analog pre torque / torque command (channel 2) voltage signal. Note: Drive automatically limits current at 300% or the value in CURRENT LIMIT (A1). For more information, see Analog Inputs on page 18 and Pre-Torque / Torque Feed Forward on page 23.</p> $\left(\begin{array}{l} \text{analog} \\ \text{channel\#2} \\ \text{input} \\ \text{voltage} \end{array} - \begin{array}{l} \text{EXT} \\ \text{TORQUE} \\ \text{BIAS} \end{array} \right) \times \begin{array}{l} \text{EXT} \\ \text{TORQUE} \\ \text{MULT} \end{array} = \begin{array}{l} \text{signal} \\ \text{drive} \\ \text{software} \\ \text{uses} \end{array}$	volts	0.00	-6.00 – +6.00	Y	Y
EXT TORQUE MULT	<p>(External Torque Multiplier) This parameter scales the analog pretorque / torque command (channel 2). If this function is set to 1.00, a 10V signal will call for 100% torque. Note: Drive automatically limits current at 300% or the value in CURRENT LIMIT (A1). For more information, see Analog Inputs on page 18 and Pre-Torque / Torque Feed Forward on page 23.</p> $\left(\begin{array}{l} \text{analog} \\ \text{channel\#2} \\ \text{input} \\ \text{voltage} \end{array} - \begin{array}{l} \text{EXT} \\ \text{TORQUE} \\ \text{BIAS} \end{array} \right) \times \begin{array}{l} \text{EXT} \\ \text{TORQUE} \\ \text{MULT} \end{array} = \begin{array}{l} \text{signal} \\ \text{drive} \\ \text{software} \\ \text{uses} \end{array}$	none	1.00	-10.00 – +10.00	Y	Y
ZERO SPEED LEVEL	<p>(Zero Speed Level) This parameter sets the threshold for zero speed detection. This is only used to generate the zero speed logic output. Note: if DIR CONFIRM (C1) is enabled, this parameter also sets the threshold for the termination of the test to confirm the polarity of the analog speed command. Units in percent of contract speed</p>	%	1.00	0.00 – 99.99	Y	Y
ZERO SPEED TIME	<p>(Zero Speed Time) This parameter sets the time at which the drive is at the ZERO SPEED LEVEL (A1) before zero speed logic output is true.</p>	sec	0.10	0.00 – 9.99	Y	Y
UP/DWN THRESHOLD	<p>(Directional Threshold) This parameter sets the threshold for the direction sense logic outputs. If speed feedback does not reach this level, the drive will not detect a directional change. This is only used to generate the direction sense logic outputs (car going up and car going down). Units in percent of contract speed.</p>	%	1.00	0.00 – 9.99	Y	Y
ANA OUT 1 OFFSET	<p>(Digital to Analog #1 Output Offset) Offset for scaling Analog Output Channel #1.</p> $\left(\begin{array}{l} \text{signal} \\ \text{drive} \\ \text{software} \\ \text{creates} \end{array} - \begin{array}{l} \text{ANA} \\ \text{OUT} \\ \text{OFFSET} \end{array} \right) \times \begin{array}{l} \text{ANA} \\ \text{GAIN} \end{array} = \begin{array}{l} \text{analog} \\ \text{channel} \\ \text{output} \\ \text{voltage} \end{array}$	%	0.0	-99.9 – 99.9	Y	N
ANA OUT 2 OFFSET	<p>(Digital to Analog #2 Output Offset) Offset for scaling Analog Output Channel #2.</p> $\left(\begin{array}{l} \text{signal} \\ \text{drive} \\ \text{software} \\ \text{creates} \end{array} - \begin{array}{l} \text{ANA} \\ \text{OUT} \\ \text{OFFSET} \end{array} \right) \times \begin{array}{l} \text{ANA} \\ \text{GAIN} \end{array} = \begin{array}{l} \text{analog} \\ \text{channel} \\ \text{output} \\ \text{voltage} \end{array}$	%	0.0	-99.9 – 99.9	Y	N

Quattro DC Drive Parameters A1

Parameter	Description	Units	Default	Range	Hidden Item	Run lock out
ANA OUT 1 GAIN	(Digital to Analog #1 Output Gain) Adjusts the scaling for the Analog Output Channel #1. NOTE: value of 1.0 = 0 to 10VDC signal. $\left(\begin{array}{l} \text{signal} \\ \text{drive} \\ \text{software} \\ \text{creates} \end{array} \begin{array}{l} \text{ANA} \\ \text{OUT} \\ \text{OFFSET} \end{array} \right) \times \text{OUT} = \begin{array}{l} \text{ANA} \\ \text{channel} \\ \text{output} \\ \text{voltage} \end{array}$	none	1.0	0.0 – 10.0	Y	N
ANA OUT 2 GAIN	(Digital to Analog #2 Output Gain) Adjusts the scaling for the Analog Output Channel #2. NOTE: value of 1.0 = 0 to 10VDC signal. $\left(\begin{array}{l} \text{signal} \\ \text{drive} \\ \text{software} \\ \text{creates} \end{array} \begin{array}{l} \text{ANA} \\ \text{OUT} \\ \text{OFFSET} \end{array} \right) \times \text{OUT} = \begin{array}{l} \text{ANA} \\ \text{channel} \\ \text{output} \\ \text{voltage} \end{array}$	none	1.0	0.0 – 10.0	Y	N
FLT RESET DELAY	(Fault Reset Delay) When the drive is set for automatic fault reset, this is the time before a fault is automatically reset.	sec	5	0 – 120	Y	N
FLT RESETS / HOUR	(Fault Resets per Hour) When the drive is set for automatic fault reset, this is the number of faults allowed to be automatically reset per hour.	faults	3	0 – 10	Y	N
UP TO SPD. LEVEL	(Up to Speed Level) This parameter sets the threshold for the up to speed logic output. This is only used to generate the up to speed logic output. Units in percent of contract speed.	%	80.00	0.00 – 110.00	Y	N
RUN DELAY TIMER	(Run Recognition Delay Timer) Allows the user to delay the drive's recognition of the RUN signal therefore allow more time for the motor contactor to set. For more information, see RUN DELAY TIMER on page 37.	sec	0.00	0.00 – 0.99	Y	Y
AB ZERO SPD LEV	(Auto Brake Zero Speed Level) Sets the speed point that will be considered as zero speed for the auto brake function. The units are % of contract speed. In order to use the Auto Brake Function, a logic output needs to be configured for AUTO BRAKE (C3), the parameter SPD COMMAND SRC(C1) = MULTI-STEP, the parameter SPD REF RELEASE (C1) = BRAKE PICKED, and the parameter BRAKE PICK CFRM(C1) = EXTERNAL TB1.	%	0.00	0.00 – 2.00	Y	Y
AB OFF DELAY	(Auto Brake Off Delay) Determines the time after zero speed is reached (level determined by the AB ZERO SPD LEV (A1) parameter) that the Auto Brake logic output goes false.	sec	0.00	0.00 – 9.99	Y	Y
CONTACTOR DO DLY	(Contactor Drop-Out Delay) When the drive controls the motor contacts via CLOSE CONTACT logic output, this parameter allows the user to delay the drive's dropout of the motor contactor. The delay time starts when the speed regulator release signal goes false.	sec	0.00	0.00 – 5.00	Y	Y

Parameter	Description	Units	Default	Range	Hidden Item	Run lock out
TRQ LIM MSG DLY	(Torque Limit Message Delay) This parameter determines the amount of time the drive is in torque limit before the "HIT TORQUE LIMIT" alarm message is displayed.	sec	0.50	0.00 – 10.00	Y	Y
ROLLBACK GAIN	(Rollback Gain) This parameter increases the sensitivity (or gain) of the speed regulator during the start in the interval between "Speed Regulator Release" and "Reference Release". The parameter acts as a multiplier to the existing speed regulator gain. <i>For more information, see ROLLBACK GAIN on page 37.</i>	none	1	1 – 99	Y	Y
NOTCH FILTER FRQ	(Notch Filter Frequency) Determines the notch filter center frequency. <i>For more information, see NOTCH FILTER FRQ on page 37.</i>	Hz	20	5 – 60	Y	Y
NOTCH FILT DEPTH	(Notch Filter Depth) Determines notch filter maximum attenuation. Note: A filter depth setting of zero (NOTCH FILT DEPTH (A1) = 0) removes the filter.	%	0	0 – 100	Y	Y
STNDBY FLD TIME	(Standby Field Delay Time) Determines the time the drive will continue to supply Full Field current after stopping and turning motor armature current control OFF. Motor field current will drop to standby amps after this time delay.	sec	30	0 – 999	Y	Y
DSPR TIME	(Drive Standby Power Reduction Time) Determines how long the drive will remain energized with motor field current at Standby amps before progressing to complete drive shutdown and utility side disconnection. Only used when DPSR ENABLE (C1) is set to ENABLE	min	120	0 – 999	Y	Y
FULL FIELD TIME	(Full Field Time) Determines the maximum time the drive can remain at Full Field without actually running. If logically held in that condition for longer than the Full field Time, a Fault will be declared to prevent potential burnout of the motor field.	min	5	0 - 99	Y	Y

Table 2: Drive A1 Submenu

Detailed descriptions

GAIN CHNG LEVEL

(Gain Change Level)

Works in conjunction with HI/LO GAIN SRC in menu C0. When the gain control source is set to internal, this parameter sets the speed reference level that controls the Hi/Lo gain switch. The velocity regulator will use normal 'high gain' when the reference speed is below this value, or 'low gain' settings when the speed reference is above this value.

On some elevators when the speed response (gain) is set to high levels as required for good velocity tracking during acceleration, the resonant characteristics of the elevator ropes can cause car vibration while running at steady state speed. To reduce this problem, the response (gain) of the speed regulator is effectively reduced to a lower value so that the resonant characteristics of the ropes are not continuously excited. The High/Low gain switch modifies the sensitivity or response of the speed regulator via the gain reduce multiplier.

The Gain Reduce Multiplier adjusts how much gain reduction will occur at higher speeds.

The Gain Change Level (or external command) determines when the gain change will occur.

High / low gain switching may be controlled either externally or internally. The high / low gain source parameter (HI/LO GAIN SRC) in Configuration menu C0 allows for an external or automatic internal gain switch selection.

The high/low gain switch may be controlled by either:

- a logic input
- the serial channel
- the gain change level parameter (GAIN CHNG LEVEL), which defines a percentage of contract speed

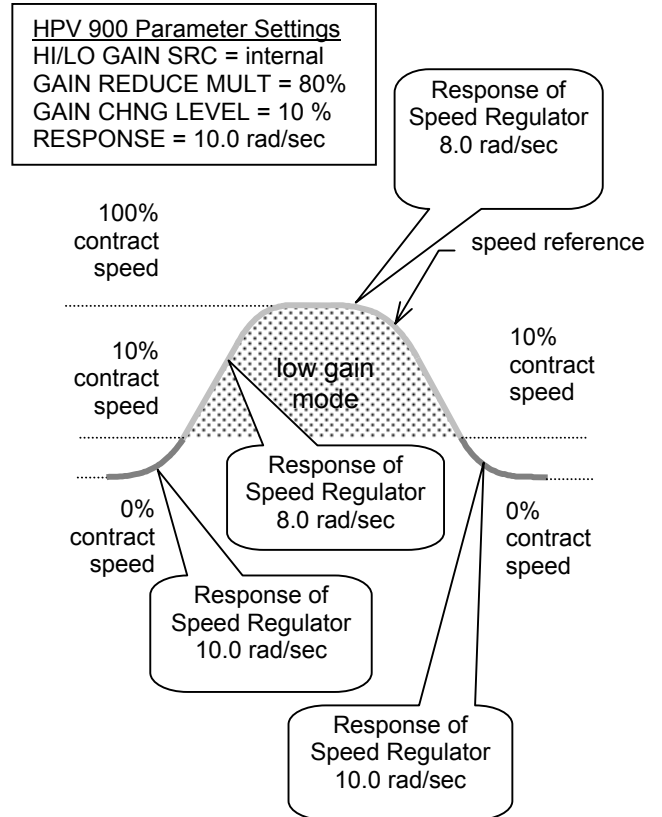

High / Low Gain Example

SPD DEV LO LEVEL and SPD DEV HI LEVEL

(Speed Deviation Low / High Level)

These two functions are available to indicate how the speed feedback is tracking the speed reference.

- Speed Deviation Low – indicates that the speed feedback is tracking the speed reference within a defined range.
- Speed Deviation High – indicates that the speed feedback is failing to properly track the speed reference.

The Speed Deviation Low function has the ability to set a configurable logic output. The logic output will be true, when the speed feedback is tracking the speed reference within a defined range around the speed reference for a defined period of time (see Figure 13). The defined range is determined by the Speed Deviation Low Level parameter (SPD DEV LO LEVEL) and the defined time is determined by the Speed Deviation Time parameter (SPD DEV TIME).

The Speed Deviation High function annunciates a Speed Deviation Alarm, and has the ability to set a configurable logic output. The alarm will be annunciated and the logic output will be true, when the speed feedback is not properly tracking the speed reference and is outside a defined range around the speed reference (see Figure 13). The defined range is determined by the Speed Deviation High Level parameter

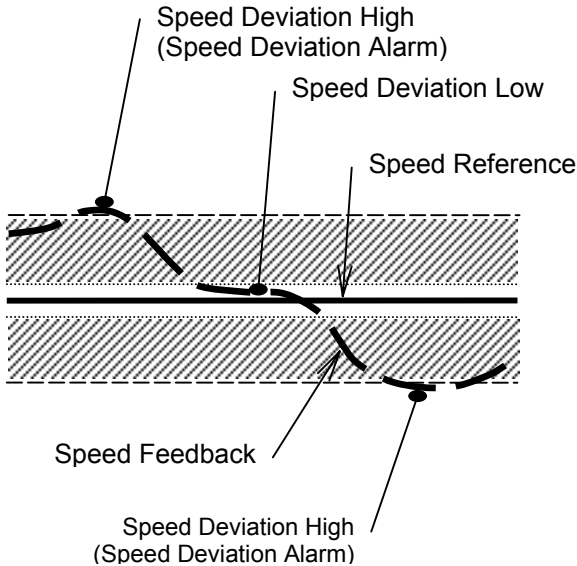
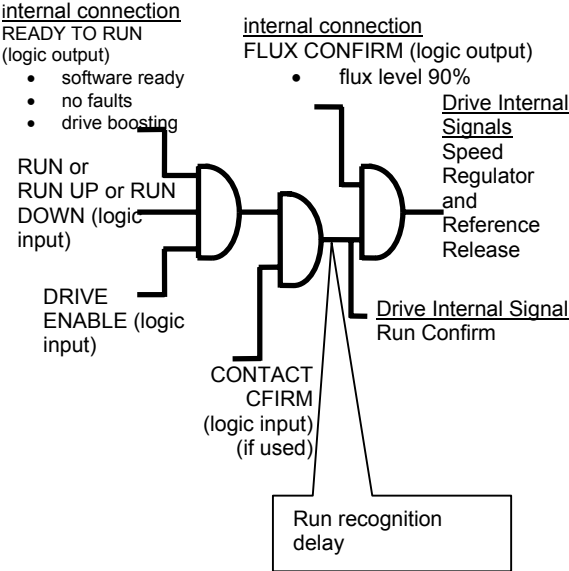

Figure 13: Speed Deviation Example

RUN DELAY TIMER

This parameter allows the user to delay the drive's recognition of the RUN signal



ROLLBACK GAIN

Note: this function is only for use with multi-step speed commands (SPD COMMAND SRC (C1) = MULTI-STEP). During the start, this function can help the drive re-establish the torque to help control rollback (or roll forward).

Set-up: In order to use the Anti-Rollback function, the following parameters must be set: SPD REF RELEASE(C1)=BRAKE PICKED and BRAKE PICK CFRM(C1)=INTERNAL TIME. With these settings for SPD REF RELEASE(C1) and BRAKE PICK CFRM(C1), the BRAKE PICK TIME (A1) parameter determines the amount of time the drive will command zero speed after the Run command is given and the amount of time the drive will command zero speed after the Run command is removed.

At the start, the ROLLBACK GAIN parameter will increase the speed regulator gain during the time determined by BRAKE PICK TIME parameter when the drive is commanding zero speed (i.e. the time between the speed regulator is released and the speed reference is released). During this BRAKE PICK TIME, the mechanical brake should be picked (either by the car controller or drive).

Adjustment: Start at ROLLBACK GAIN=1 and increase in increments of 1 to help control rollback.

IMPORTANT: too high a setting for this parameter can lead to drive instability.

Quattro DC Drive Parameters A1

NOTCH FILTER FRQ

(Notch Filter Center Frequency)

Although originally created for gearless applications where elevator rope resonance is sometimes an issue, this filter affects the torque command output of the speed regulator and will filter out specific frequencies. By filtering a specific frequency, the speed regulator will avoid exciting a mechanical resonance if one exists at that frequency.

There is attenuation across a range of frequencies, not just at the set frequency, but also to a lesser degree. The filter starts attenuation at frequencies lower than the notch frequency set point. When the notch frequency is set to low values (less than 10 Hz), the filter can interfere with the desired response of the drive. This can be exhibited by minor increase in the rollback of the drive at start and some deterioration in the ability of the drive to track an s-curve reference. Generally, this would not be an issue if the notch frequency were set at or above 10 Hz.

Notch Filter Example settings:

NOTCH FILTER FRQ (A1) = 20Hz

NOTCH FILT DEPTH (A1) = 50% and 100%

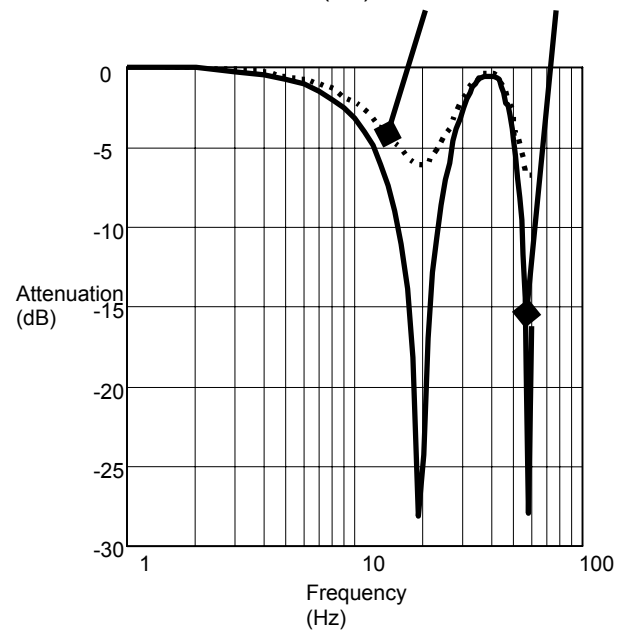

S-Curves A2 submenu

The drive speed command is passed through an internal S-curve in order to produce the speed reference. In general, the S curve function takes an arbitrary speed command and generates a speed reference subject to the conditions that the maximum accel, decel and jerk rates not be exceeded. The speed command is typically the target speed that the reference is headed to.

If the user gives the drive a speed dictation, either analog or serial, the S-Curve will act as a slew rate limiter on the externally generated speed dictation. For this purpose, set the jerk rates associated with the S-Curve (see Table 3 for determining which s-curve is used) to zero and the Accel Rate and Decel Rate to values faster than the maximum expected rated provided in the dictation signal.

Below shows the six parameters associated with an S-Curve data set:

- Accel - Maximum allowed acceleration rate (ft/s² or m/s²)
- Decel - Maximum allowed deceleration rate (ft/s² or m/s²)
- Accel Jerk In - Maximum allowed change in acceleration towards Accel (ft/s³ or m/s³)
- Accel Jerk Out - Maximum allowed change in acceleration from Accel (ft/s³ or m/s³)
- Decel Jerk In - Maximum allowed change in deceleration towards Decel (ft/s³ or m/s³)
- Decel Jerk Out - Maximum allowed change in deceleration from Decel (ft/s³ or m/s³)

The S-curves are specified by four parameters: acceleration rate (ft/s² or m/s²), deceleration rate (ft/s² or m/s²), leveling jerk rate (ft/s³ or m/s³), and jerk rate (ft/s³ or m/s³).

Since an adjustable jerk rate is helpful for smooth landings, the jerk rates are split for ease in elevator fine-tuning. The jerk rate parameters specify: acceleration from the floor (ACCEL JERK IN), jerk out of acceleration (ACCEL JERK OUT), jerk into deceleration (DECCEL JERK IN), and the leveling into the floor (DECCEL JERK OUT).

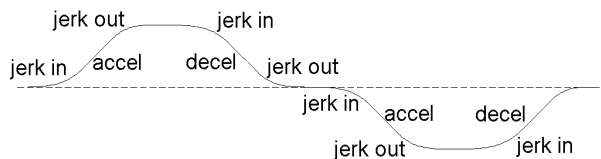

S-Curve

There are four S-curve patterns available in the drive and each S-curve is customized by six parameters:

Parameters for S-curve-0 (SC0):

- ACCEL RATE 0, DECEL RATE 0, ACCEL JERK IN 0, ACCEL JERK OUT 0, DECEL JERK IN 0, and DECEL JERK OUT 0

Parameters for S-curve-1 (SC1):

- ACCEL RATE 1, DECEL RATE 1, ACCEL JERK IN 1, ACCEL JERK OUT 1, DECEL JERK IN 1, and DECEL JERK OUT 1

Parameters for S-curve-2 (SC2):

- ACCEL RATE 2, DECEL RATE 2, ACCEL JERK IN 2, ACCEL JERK OUT 2, DECEL JERK IN 2, DECEL JERK OUT 2

Parameters for S-curve-3 (SC3):

- ACCEL RATE 3, DECEL RATE 3, ACCEL JERK IN 3, ACCEL JERK OUT 3, DECEL JERK IN 3, DECEL JERK OUT 3

S-Curve Pattern Selection

The default S-curve pattern is S-curve-0 (SC0). To make the other patterns available, the user must assign S-CURVE SEL 0 and/or S-CURVE SEL 1 as logic input(s). The logic input(s) can then be used to select one of the S-curve patterns, as follows:

Logic Inputs Assigned	S-curves Available
None	SC0 only
SEL 0 only	SC0 or SC1
SEL 1 only	SC0 or SC2
SEL 0 & SEL 1	SC0, SC1, SC2 or SC3

Table 3: S-Curve Availability

logic input S-CURVE		S-curve selected
SEL 1	SEL 0	
0	0	SC0
0	1	SC1
1	0	SC2
1	1	SC3

Table 4: Selecting S-Curves

Quattro DC Drive S-Curves A2

Parameter	Description	Units	Default	Range	Hidden Item	Run lock out
ACCEL RATE 0	Acceleration rate limit	ft/s ²	7.99	0.00 – 7.99	N	Y
		m/s ²	2.435	0.000 – 3.999		
DECEL RATE 0	Deceleration rate limit	ft/s ²	7.99	0.00 – 7.99	N	Y
		m/s ²	2.435	0.000 – 3.999		
ACCEL JERK IN 0	Rate of increase of acceleration, up to ACCEL RATE, when increasing elevator speed	ft/s ³	0.0	0.0 – 29.9	N	Y
		m/s ³	0.000	0.000 – 9.999		
ACCEL JERK OUT 0	Rate of decrease of acceleration to zero when approaching contract elevator speed	ft/s ³	0.0	0.0 – 29.9	N	Y
		m/s ³	0.000	0.000 – 9.999		
DECEL JERK IN 0	Rate of increase of deceleration, up to DECEL RATE, when decreasing elevator speed	ft/s ³	0.0	0.0 – 29.9	N	Y
		m/s ³	0.000	0.000 – 9.999		
DECEL JERK OUT 0	Rate of decrease of deceleration to zero when slowing the elevator to leveling speed	ft/s ³	0.0	0.0 – 29.9	N	Y
		m/s ³	0.000	0.000 – 9.999		
ACCEL RATE 1	Acceleration rate limit	ft/s ²	7.00	0.00 – 7.99	N	Y
		m/s ²	2.134	0.000 – 3.999		
DECEL RATE 1	Deceleration rate limit	ft/s ²	3.00	0.00 – 7.99	N	Y
		m/s ²	0.090	0.000 – 3.999		
ACCEL JERK IN 1	Rate of increase of acceleration, up to ACCEL RATE, when increasing elevator speed	ft/s ³	8.0	0.0 – 29.9	N	Y
		m/s ³	2.400	0.000 – 9.999		
ACCEL JERK OUT 1	Rate of decrease of acceleration to zero when approaching contract elevator speed	ft/s ³	8.0	0.0 – 29.9	N	Y
		m/s ³	2.400	0.000 – 9.999		
DECEL JERK IN 1	Rate of increase of deceleration, up to DECEL RATE, when decreasing elevator speed	ft/s ³	8.0	0.0 – 29.9	N	Y
		m/s ³	2.400	0.000 – 9.999		
DECEL JERK OUT 1	Rate of decrease of deceleration to zero when slowing the elevator to leveling speed	ft/s ³	8.0	0.0 – 29.9	N	Y
		m/s ³	2.400	0.000 – 9.999		
ACCEL RATE 2	Acceleration rate limit	ft/s ²	3.00	0.00 – 7.99	N	Y
		m/s ²	0.090	0.000 – 3.999		
DECEL RATE 2	Deceleration rate limit	ft/s ²	3.00	0.00 – 7.99	N	Y
		m/s ²	0.090	0.000 – 3.999		
ACCEL JERK IN 2	Rate of increase of acceleration, up to ACCEL RATE, when increasing elevator speed	ft/s ³	8.0	0.0 – 29.9	N	Y
		m/s ³	2.400	0.000 – 9.999		
ACCEL JERK OUT 2	Rate of decrease of acceleration to zero when approaching contract elevator speed	ft/s ³	8.0	0.0 – 29.9	N	Y
		m/s ³	2.400	0.000 – 9.999		
DECEL JERK IN 2	Rate of increase of deceleration, up to DECEL RATE, when decreasing elevator speed	ft/s ³	8.0	0.0 – 29.9	N	Y
		m/s ³	2.400	0.000 – 9.999		
DECEL JERK OUT 2	Rate of decrease of deceleration to zero when slowing the elevator to leveling speed	ft/s ³	8.0	0.0 – 29.9	N	Y
		m/s ³	2.400	0.000 – 9.999		
ACCEL RATE 3	Acceleration rate limit	ft/s ²	3.00	0.00 – 7.99	N	Y
		m/s ²	0.090	0.000 – 3.999		
DECEL RATE 3	Deceleration rate limit	ft/s ²	3.00	0.00 – 7.99	N	Y
		m/s ²	0.090	0.000 – 3.999		
ACCEL JERK IN 3	Rate of increase of acceleration, up to ACCEL RATE, when increasing elevator speed	ft/s ³	8.0	0.0 – 29.9	N	Y
		m/s ³	2.400	0.000 – 9.999		
ACCEL JERK OUT 3	Rate of decrease of acceleration to zero when approaching contract elevator speed	ft/s ³	8.0	0.0 – 29.9	N	Y
		m/s ³	2.400	0.000 – 9.999		
DECEL JERK IN 3	Rate of increase of deceleration, up to DECEL RATE, when decreasing elevator speed	ft/s ³	8.0	0.0 – 29.9	N	Y
		m/s ³	2.400	0.000 – 9.999		
DECEL JERK OUT 3	Rate of decrease of deceleration to zero when slowing the elevator to leveling speed	ft/s ³	8.0	0.0 – 29.9	N	Y
		m/s ³	2.400	0.000 – 9.999		

Table 5: S-Curves A2 Submenu

Multistep Ref A3 submenu

The multi-step speed reference function is one possible way for the drive to accept speed command. To use this function, the user can enter up to fifteen speed commands (CMD1 – CMD15) and assign four logic inputs as speed command selections.

Note: CMD0 is reserved for zero speed, therefore is not accessible to the user for programming.

During operation, the user will encode a binary signal on the four logic inputs that determines which speed command the software should use. The user need not use all four speed command selection bits; if no logic input is specified for one of the selection bits, that bit is always zero. For instance, if no logic input is specified for the most significant bit (B3), that bit will be zero and the user can select from CMD0 - CMD7.

IMPORTANT

Since these speed commands are selected with external contacts, a new command selection must be present for 50ms before it is recognized.

An example of the use of the multi-step command is as follows:

- All speed commands are positive.
- CMD0 specifies zero speed.
- CMD1 specifies leveling speed.
- CMD2 specifies inspection speed.
- CMD3 specifies an overspeed limit.
- CMD4 – CMD15 specify different top speeds depending on number of floors in the run.

For typical use, the user will have all speed commands to be positive, in which case logic inputs (UP/DWN or RUNUP & RUNDOWN) must also be specified to determine up or down direction. It is possible for the user to specify both positive and negative values for CMD1 - CMD15, in which case logic input bit(s) are not needed.

logic input STEP REF				multi-step speed
B3	B2	B1	B0	command
0	0	0	0	CMD0
0	0	0	1	CMD1
0	0	1	0	CMD2
0	0	1	1	CMD3
0	1	0	0	CMD4
0	1	0	1	CMD5
0	1	1	0	CMD6
0	1	1	1	CMD7
1	0	0	0	CMD8
1	0	0	1	CMD9
1	0	1	0	CMD10
1	0	1	1	CMD11
1	1	0	0	CMD12
1	1	0	1	CMD13
1	1	1	0	CMD14
1	1	1	1	CMD15

Multi-step Selection

Quattro DC Multistep Ref A3 Submenu

Parameter	Description	Units	Default	Range	Hidden Item	Run lockout
SPEED COMMAND 1	Multi-step speed command #1	ft/min	0.0	-3000.0 – +3000.0	N	Y
		m/sec	0.000	-16.000 – +16.000		
SPEED COMMAND 2	Multi-step speed command #2	ft/min	0.0	-3000.0 – +3000.0	N	Y
		m/sec	0.000	-16.000 – +16.000		
SPEED COMMAND 3	Multi-step speed command #3	ft/min	0.0	-3000.0 – +3000.0	N	Y
		m/sec	0.000	-16.000 – +16.000		
SPEED COMMAND 4	Multi-step speed command #4	ft/min	0.0	-3000.0 – +3000.0	N	Y
		m/sec	0.000	-16.000 – +16.000		
SPEED COMMAND 5	Multi-step speed command #5	ft/min	0.0	-3000.0 – +3000.0	N	Y
		m/sec	0.000	-16.000 – +16.000		
SPEED COMMAND 6	Multi-step speed command #6	ft/min	0.0	-3000.0 – +3000.0	N	Y
		m/sec	0.000	-16.000 – +16.000		
SPEED COMMAND 7	Multi-step speed command #7	ft/min	0.0	-3000.0 – +3000.0	N	Y
		m/sec	0.000	-16.000 – +16.000		
SPEED COMMAND 8	Multi-step speed command #8	ft/min	0.0	-3000.0 – +3000.0	N	Y
		m/sec	0.000	-16.000 – +16.000		
SPEED COMMAND 9	Multi-step speed command #9	ft/min	0.0	-3000.0 – +3000.0	N	Y
		m/sec	0.000	-16.000 – +16.000		
SPEED COMMAND 10	Multi-step speed command #10	ft/min	0.0	-3000.0 – +3000.0	N	Y
		m/sec	0.000	-16.000 – +16.000		
SPEED COMMAND 11	Multi-step speed command #11	ft/min	0.0	-3000.0 – +3000.0	N	Y
		m/sec	0.000	-16.000 – +16.000		
SPEED COMMAND 12	Multi-step speed command #12	ft/min	0.0	-3000.0 – +3000.0	N	Y
		m/sec	0.000	-16.000 – +16.000		
SPEED COMMAND 13	Multi-step speed command #13	ft/min	0.0	-3000.0 – +3000.0	N	Y
		m/sec	0.000	-16.000 – +16.000		
SPEED COMMAND 14	Multi-step speed command #14	ft/min	0.0	-3000.0 – +3000.0	N	Y
		m/sec	0.000	-16.000 – +16.000		
SPEED COMMAND 15	Multi-step speed command #15	ft/min	0.0	-3000.0 – +3000.0	N	Y
		m/sec	0.000	-16.000 – +16.000		

Table 6: Multi-Step Ref A3 Submenu

Motor Side Power Convert A4 submenu

Parameter	Description	Units	Default	Range	Hidden Item	Run lock out
ARM RESISTANCE	(Armature Circuit Resistance) Affects tuning of the armature current regulator. Load this parameter with known or measured value. Only used is GAIN SELECTION (A4) is set to Manual.	Ohm	0.5000	0.0001 – 2.9999	Y	N
ARM INDUCTANCE	(Armature Circuit Inductance) Affects tuning of the armature current regulator. Load this parameter with known or measured value. Only used is GAIN SELECTION (A4) is set to Manual.	mH	15.00	0.01 – 327.67	Y	N
MTR REV VLT LIM	(Motor Revolution Voltage Limit) Determines crossover point during regeneration at low speed from using CEMF to reverse plugging of motor. If set too high there will be a hesitation in torque. If set too low, there may be an oscillation squeal heard from the motor.	%	4.80	0.01 – 30.00	Y	N
IF REG INT GAIN	(Field Current Regulator integral Gain) The integral gain for the current regulation of the motor field. Rarely needs to be changed from the default.	none	0.90	0.00 – 30.00	Y	N
IF REG PROP GAIN	(Field Current Regulator Proportional) The proportional gain for the current regulation of the motor field. Rarely needs to be changed from the default.	none	6.07	0.00 – 16.38	Y	N
AUTO TUNE MOTOR	(Auto Tune Motor) Begins the procedure to calculate motor parameters. See Auto Tune Procedure on page 95.	none	-	Start Auto Tune?	N	Y
GAIN SELECTION	(Gain Selection) If set to MANUAL, values in ARM RESISTANCE (A4), ARM INDUCTANCE (A4), If REG INT GAIN (A4), and If REG PROP GAIN (A4) will be used. If set to AUTOTUNE, the armature regulator gains are set using AUTO MEAS ARM L(D2) and AUTO MEAS ARM R (D2). AUTO FLD INT (D2), and AUTO FLD PROP (D2) will be used to tune the respective regulators.	none	Manual	- Autotune - Manual	N	N

Quattro DC Motor Side Power Convert A4 Submenu

Parameter	Description	Units	Default	Range	Hidden Item	Run lock out
GAIN BANDWIDTH A	<p>(Gain Bandwidth Armature) If GAIN SELECTION (C1) is set to MANUAL, this parameter is used to convert ARM RESISTANCE (A4) and ARM INDUCTANCE (A4) into the integral and proportional gains used by the current regulator.</p> <p>If GAIN SELECTION is set to AUTO-TUNE, this parameter is used to convert AUTO MEAS ARM R (D2) and AUTO MEAS ARM L (D2) into the integral and proportional gains used by the current regulator. The higher the setting, the more faithfully the regulator will duplicate its input command, however, too high of a bandwidth can cause problems such as a rough ride as the drive is more responsive.</p>	rad/ sec	500	100 – 2000	N	N
GAIN BANDWIDTH F	<p>(Gain Bandwidth Field) If GAIN SELECTION is set to AUTO-TUNE, this parameter is used to calculate AUTO FLD INT (D2) and AUTO FLD PROP (D2) into the integral and proportional gains used by the field regulator. The higher the setting, the more faithfully the regulator will duplicate its input command, however, too high of a bandwidth can cause problems such as a rough ride as the drive is more responsive.</p>	rad/ sec	5	1 – 40	N	N
PWM FREQ	<p>(PWM Frequency) This parameter sets the PWM or 'carrier' frequency of the motor armature portion of the drive.</p>	kHz	6.0	2.5 – 16.0	N	N
FAN OFF DELAY	<p>(Cooling Fan OFF Delay) Adjusts OFF delay of all cooling fans after drive has stopped operating when Main Fan Control is set at "Automatic".</p>	Sec	180	0 – 999	N	N

Quattro DC Motor Side Power Convert A4 Submenu

Parameter	Description	Units	Default	Range	Hidden Item	Run lock out
MAIN FAN CONTROL	(Main Fan Control Select) Selects primary method of cooling fan control. <ul style="list-style-type: none"> - <i>AUTO</i> – All cooling fans turn OFF after Fan Off Delay time, after DSPR becomes active. - <i>TEMP</i> – Fan speed is responsive to highest measured temperature of IGBT modules. - <i>OFF</i> – Manual test mode, all fans off - <i>LOW</i> – Manual test mode, low speed - <i>MEDIUM</i> – Manual test mode, medium speed - <i>HIGH</i> – Manual test mode, high speed 	none	Temp	<ul style="list-style-type: none"> - Auto - Temp - Off - Low - Medium - High 	N	N
UV-ALARM LEVEL	(Undervoltage Alarm Level) This parameter sets the level at which an under voltage alarm will be declared. Units in percent of L-L voltage.	%	90	80 – 99	Y	N
UV FAULT LEVEL	(Undervoltage Fault Level) This parameter sets the level at which an under voltage fault will occur. Units in percent of L-L voltage.	%	80	50 – 99	Y	N
FLD CARRIER FRQ	(Field Carrier Frequency) Allows modification of PWM frequency to help eliminate acoustic noise.	kHz	3	3 – 10	Y	N

Table 7: Motor Side Power Convert A4 Submenu

Quattro DC Line Side Power Convert A5 Submenu

Line Side Power Converter A5 submenu

NOTE: The only parameter that should ever need to be adjusted is INPUT L-L VOLTS. Other parameters are for Magnetek Engineering use only.

Parameter	Description	Units	Default	Range	Hidden Item	Run lock out
Id REG PROP GAIN	Proportional gain for out-of-phase current regulator	none	0.30	0.00 – 9.99	N	N
Id REG INTEGRAL GAIN	Integral gain for out-of-phase current regulator	none	10	0 – 999	N	N
Iq REG PROP GAIN	Proportional gain for in-phase current regulator	none	0.30	0.00 – 9.99	N	N
Iq REG INTEGRAL GAIN	Integral gain for in-phase current regulator	none	40	0 – 999	N	N
DC BUS REG P GAIN	Proportional gain for bus voltage regulator	none	3.00	0 – 9.99	N	N
DC BUS REG I GAIN	Integral gain for bus voltage regulator	none	40	0 – 999	N	N
INPUT L-L VOLTS	(Input Line to Line Voltage - Input Voltage) This parameter sets the input voltage or AC line input voltage to the drive.	volts	480	110 – 552	N	Y
DC BUS V BOOST	(DC bus voltage reference) Adjusts the DC bus voltage boost above the peak of line voltage.	Vdc	30	15 – 75	N	N
SW BUS OV LEVEL	(Software Bus Overvoltage Level) DC bus software Overvoltage trip point.	Vdc	850	100 – 850	N	N
BUS VREF SOURCE	(Bus Voltage Reference Source) Selects the bus voltage boost reference. <ul style="list-style-type: none"> Track Line V uses the actual line voltage for the bus reference. Recommended for systems with a stiff line. Trk Vin Param uses INPUT L-L VOLTS (A5) for the bus reference. Recommended to systems with a soft line. 	none	Trk Vin Param	1=Track Line V 2=Trk Vin Param	N	N
PLL FILTER FC	(Phase Locked Loop Filter Frequency) Utility line Phase Locked Loop filter corner Frequency	Hz	40.0	0.0 – 150.0	N	N
LS PWM FREQ	(Line Side PWM Frequency) Converter PWM Freq	kHz	10.0	2.5 – 16.0	N	N

Table 8: Line Side Power Convert A5

Motor Parameters A6 submenu

Parameter	Description	Units	Default	Range	Hidden Item	Run lock out
MOTOR ID	(Motor Identification) This parameter allows for the selection of specific sets of motor parameters. This is yet to be determined for DC machines.	-	-	-	N	Y
RATED MOTOR CURR	(Rated Armature Amps) Motor armature amps. Note: value should be obtained from the motor nameplate.	amps	0.0	1.0 – 400.0	N	Y
ARMATURE VOLTS	(Rated Armature Voltage) Rated motor armature circuit voltage. Note: value should be obtained from the motor nameplate.	amps	0	55 – 600	N	N
FULL FLD AMPS	(Full field Amps) This parameter sets motor field amps at low speed. Note: value should be obtained from the motor nameplate.	amps	0.0	1.0 – 40.0	N	N
WEAK FLD AMPS	(Weak field Amps) This parameter sets the motor field amps at contract. Adjust as necessary to obtain rated armature volts at contract speed at full load up. May be the same as or lower than Full field Amps for motor field weakening. Motor field current will automatically begin to weaken when motor speed is Contract Speed x Weak Field/Full Field and follow a profile for constant CEMF.	amps	0.0	1.0 – 40.0	N	N
STNDBY FIELD	(Standby field Amps) Motor field current during drive standby conditions. Motor current will automatically drop to this level when idle after STNDBY FIELD TIME has expired.	amps	0.0	0.0 – 40.0	N	N
FLUX CNFRM LEVEL	(Flux Confirm Level) Determines the minimum motor field current necessary before drive is allowed to start. Arranged as a percent of Full Field ampere setting. This ensures that pre-torque current to motor will produce adequate torque when the elevator Brake is released. A lower setting will allow the drive to come alive earlier in the start cycle to help prevent unnecessary starting delays. Units in percent of full field.	%	0.0	25.0 – 99.0	N	N
ARMATURE IR DROP	(Armature IR Drop) Adjusts motor armature current regulator for expected current x resistance voltage drop of motor armature circuit at rated current. Includes motor armature, inter-poles and wiring resistance. Enter as a percent of rated armature volts. This parameter also affects the sensitivity of the fault, Encoder Fault. Note: This equation is only valid after an Auto Tune has been done. For information on auto tuning the motor, see page 95. $\frac{\left(\begin{matrix} \text{AUTO} \\ \text{MEAS} \\ \text{ARM} \\ \text{R(D2)} \end{matrix} \right) \times \left(\begin{matrix} \text{RATED} \\ \text{MOTOR} \\ \text{CURR(A6)} \end{matrix} \right)}{\left(\begin{matrix} \text{ARMATURE} \\ \text{VOLTS (A6)} \end{matrix} \right)} \times 100 = \left(\begin{matrix} \text{ARM} \\ \text{IR} \\ \text{DROP} \\ \text{(A6)} \end{matrix} \right)$	%	0.0	0.0 – 25.0	N	N

Quattro DC Motor A6 Submenu

Parameter	Description	Units	Default	Range	Hidden Item	Run lock out
OVLD START LEVEL	(Motor Overload Start Level) This parameter defines maximum current at which motor can run continuously without triggering the motor overload. One of the two parameters that define the motor overload curve. Set as a percent of Rated Motor Current.	%	110	100 – 150	N	Y
OVLD TIME OUT	(Motor Overload Time Out) This parameter defines the amount of time before a motor overload alarm occurs when the motor is running at the current level defined below: $\left(\begin{matrix} OVLD \\ START \\ LEVEL \end{matrix} \right) + \left(\begin{matrix} 40 \% \\ rated \\ motor \\ current \end{matrix} \right)$ This is the other parameter used to define the overload curve. For more information on the motor overload curve, see OVLD TIME OUT on page 48.	sec	60.0	5.0 – 120.0	N	Y

OVLD TIME OUT

This is the other parameter used to define the overload curve.

The user can adjust the motor overload parameters. Three overload curves are shown in the examples below. Curve #1 is the default motor overload curve.

	OVLD START LEVEL	OVLD TIME OUT
curve #1	110%	60 sec
curve #2	110%	40 sec
curve #3	120%	70 sec

Motor Overload Parameters

When the motor usage exceeds the user defined motor overload curve, the drive will declare a motor overload alarm.

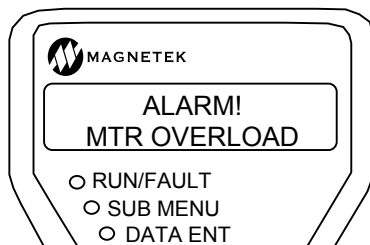

Under the POWER DATA display sub-menu, the MOTOR OVERLOAD (D2) value displays the accumulated percent of motor overload trip level reached. Once this value reaches 100% the motor overload will trip and a motor overload alarm is declared by the drive.

The drive will only declare a motor overload and the user is responsible for taking appropriate action to protect equipment. The motor overload alarm can also be assigned to a logic output. See configuration sub-menu items, C3.

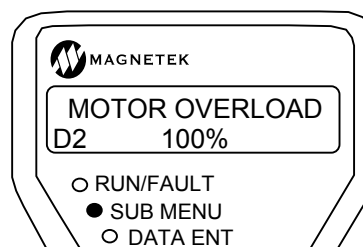

The drive can also be configured so that a motor overload event declares a Fault, which will automatically cause the drive to stop. If this is desirable, the following needs to be completed:

- logic output configured to MTR OVERLOAD
- logic input configured to EXT FAULT
- wire the EXT FAULT logic input terminal to the MTR OVERLOAD logic output terminal
- wire the logic input common terminal to the logic output common

With the above set-up, the drive will then declare an External Fault on a motor overload.

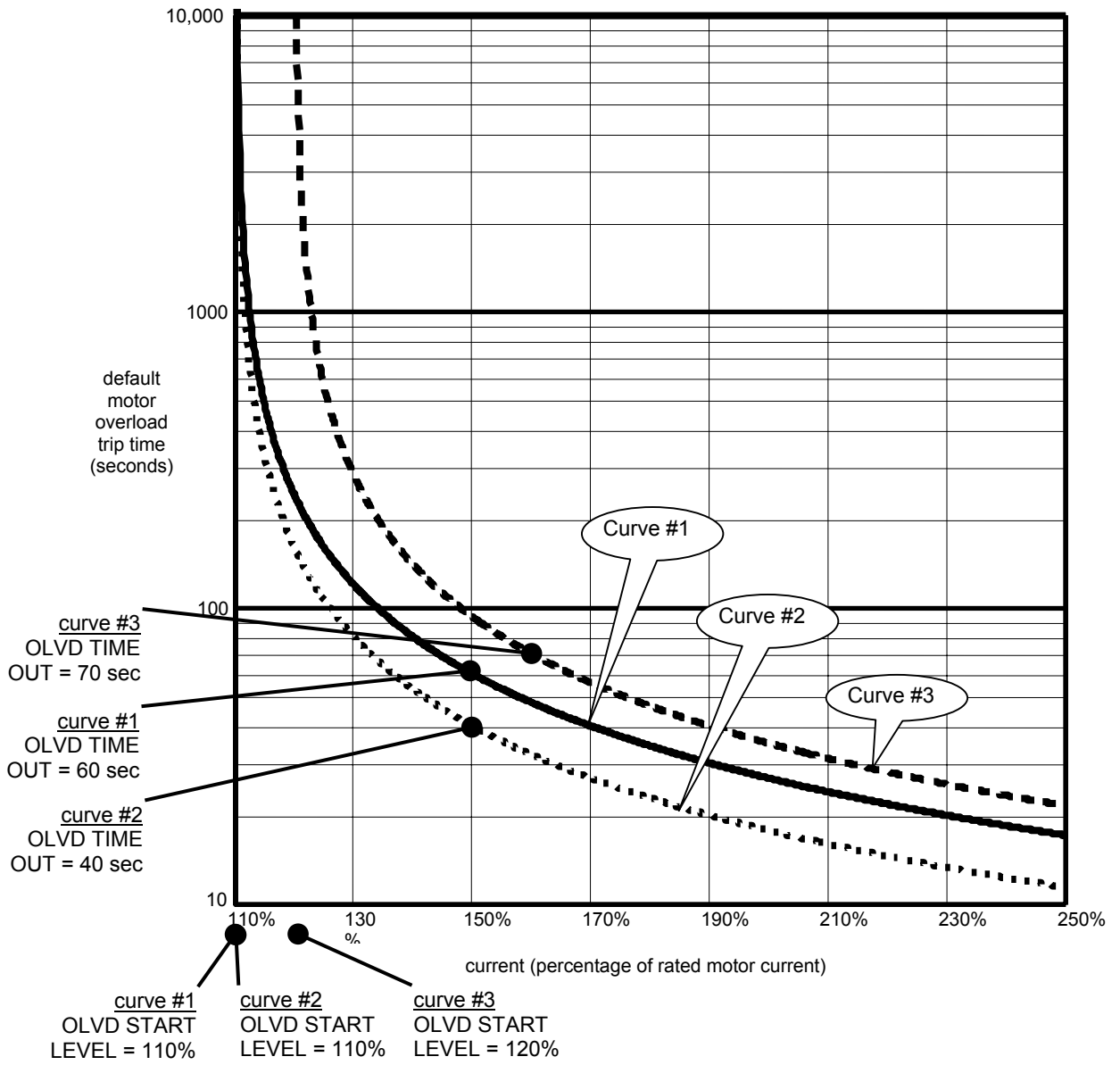

Figure 14: Motor Overload Curve

Configure C0 menu

User Switches C1 submenu

Parameter	Description	Default	Choices	Hidden Item	Run lock out																
SPD COMMAND SRC	<p>(Speed Command Source) This parameter designates the source of the drive's speed command. The four possible sources for the speed command are following:</p> <ul style="list-style-type: none"> Serial Channel - a RS-422 serial port located on the customer interface PCB. Analog Channel – a bipolar ($\pm 10V$) signal. Available with the analog channel is a Speed Command Multiplier (SPD COMMAND MULT(A1)) and Speed Command Bias (SPD COMMAND BIAS(A1)). These parameters are used to scale the user's analog speed command to the proper range for use by the drive software. Multi-Step Command - user defined fifteen discrete speed commands (CMD1 - CMD15 in A3 submenu). Four logic inputs are used as speed command selections. CMD0 is reserved for zero speed, but the user can specify CMD1 - CMD15 to be any speed command either positive or negative. See Multistep Ref A3 on page 41. Ser Mult Step Command - user defined fifteen discrete speed commands (CMD1 - CMD15 in A3 submenu). Four bits in the serial protocol are toggled to run multi-step serially. See Multistep Ref A3 on page 41. 	MULTI-STEP	<ul style="list-style-type: none"> – analog input – serial – multi-step – ser mult step 	Y	Y																
RUN COMMAND SRC	<p>(Run Command Source) This parameter allows the user to choose the source of the run command from one of the following sources: an external run signal from a logic input (external tb), a run signal transferred across a serial channel (serial), or a signal from both the serial channel and a logic input (serial+extrn). If a signal is required from a logic input (either externaltb or serial+extrn), the Run signal on TB1 must be selected.</p>	EXTERNAL TB	<ul style="list-style-type: none"> – external tb – serial – serial+extrn 	Y	Y																
FIELD ENA SOURCE	<p>(Field Enable Source) Enabling the Field Source initially turns on the Line Side Boost, than establishes a field. This may be done through a logic input (set FIELD ENA SOURCE to EXTERNAL TB), serially, (set FIELD ENA SOURCE to SERIAL), by the run command (set FIELD ENA SOURCE to ENABLE ON RUN), or by 2-bit serial. 2-bit serial uses two bits given to the drive serially to control the field. See the table below for the bit options. Bit 1 refers to Full Field bit while Bit 0 refers to Standby Field Bit. While the motor is running, both Boost and Field are on.</p> <table border="1"> <thead> <tr> <th>Bit 1</th> <th>Bit 0</th> <th>Boost</th> <th>Field</th> </tr> </thead> <tbody> <tr> <td>0</td> <td>0</td> <td>Off</td> <td>Off</td> </tr> <tr> <td>1</td> <td>~</td> <td>On</td> <td>Full Field or Weak Fld depending on speed</td> </tr> <tr> <td>0</td> <td>1</td> <td>On</td> <td>Standby</td> </tr> </tbody> </table>	Bit 1	Bit 0	Boost	Field	0	0	Off	Off	1	~	On	Full Field or Weak Fld depending on speed	0	1	On	Standby	ENABLE ON RUN	<ul style="list-style-type: none"> – external tb – serial – 2-bit serial – enable on run 	Y	Y
Bit 1	Bit 0	Boost	Field																		
0	0	Off	Off																		
1	~	On	Full Field or Weak Fld depending on speed																		
0	1	On	Standby																		

Parameter	Description	Default	Choices	Hidden Item	Run lock out
HI/LO GAIN SRC	<p>(High / low gain change switch source) This parameter determines the source of the high / low gain switch.</p> <p>The speed regulator high / low gain function was developed in response to high performance elevator requirements where the resonant nature of the elevator system interferes with the speed response of the drive. For more information, see HI/LO GAIN SRC on page 59.</p>	INTERNAL	<ul style="list-style-type: none"> - internal - external tb - serial 	Y	Y
SPEED REG TYPE	<p>(Speed Regulator Type) This switch toggles between the Elevator Speed Regulator (Ereg), the PI Speed Regulator, external reg, and cemf reg. Magnetek recommends the use of the Elevator Speed Regulator for better elevator performance with multi-step speed applications or when an active torque Feed Forward signal is not available.</p> <p>If set to CEMF REG, the drive will not use the encoder as feedback, but rather the armature voltage. Note: this is only meant for maintenance. For more information, see Armature Voltage Feedback on page 24.</p> <p>If set to External Regulator, the drive will be configured as a torque controller. The source of the external torque command is determined by the EXT TORQ CMD SRC (C1) parameter.</p> <div style="border: 1px solid black; padding: 5px; margin: 10px 0;"> <p style="text-align: center;">WARNING</p> <p>If using an external speed regulator, which produces an analog torque command to Quattro (SPEED REG TYPE (C1) = external reg and EXT TORQ CMD SRC (C1) = analog input), it is imperative that the encoder polarity matches the armature voltage. To verify polarity, insert a torque command into the analog input. Check ENCODER SPD (D2) against ARMATURE VOLTAGE (D2). Verify they are the same polarity. If not, swap A and /A or change the ENCODER CONNECT (C1) parameter.</p> </div> <p>IMPORTANT: This assumes the car controller is doing its own closed-loop speed regulation. (i.e. a completely closed outer speed loop with the car controller having its own encoder feedback).</p> <p>The drive has the following three closed loop speed regulation options and an option for turning off the internal speed regulator:</p> <ul style="list-style-type: none"> • Elevator Speed Regulator (Ereg) (see page 59) • PI Speed Regulator (see page 60) • External Speed Regulator 	ELEV SPD REG	<ul style="list-style-type: none"> - elev spd reg - pi speed reg - external reg - cemf reg 	Y	Y

Quattro DC User Switches C1

Parameter	Description	Default	Choices	Hidden Item	Run lock out
MOTOR ROTATION	(Motor Rotation) This parameter allows the user to change the direction of the motor rotation. As an example, if the car controller is commanding the up direction and the car is actually going in a down direction, this parameter can be changed to allow the motor rotation to match the car controller command.	FORWARD	– forward – reverse	Y	Y
ENCODER CONNECT	(Encoder Connection) This parameter allows the user to electronically switch A and /A signals from the encoder without moving any wiring.	FORWARD	– forward – reverse	Y	Y
SPD REF RELEASE	(Speed Reference Release) The user can select when the Speed Reference Release signal is asserted: <ul style="list-style-type: none"> • If the user does not want the drive to wait for the mechanical brake to be picked then SPD REF RELEASE can be made equal to REG RELEASE; • If the user does want the drive to wait for the brake to be picked then SPD REF RELEASE is not asserted until an internal BRAKE PICKED signal becomes true. The user must have one logic input set to Mech Brk Pick – see page 61. 	REG RELEASE	– reg release – brake picked	Y	Y
CONT CONFIRM SRC	(Contactor Confirm Source) This switch selects if hardware confirmation of motor contactor closure is necessary before drive attempts to pass current through motor. If hardware confirmation is available set to EXTERNAL TB and select the Contact Cfirm signal on a logic input terminal – see page 61.	NONE	– external tb – none	Y	Y
TACH FILTER	(Tach Filter) Determines if encoder feedback is filtered	OFF	– off – on	Y	Y
PreTorque SOURCE	(Pre-Torque Source) This switch determines the source of a pre torque command and how it is used. Pre-torque is the value of torque that the drive should produce as soon as the speed regulator is released to prevent rollback due to unbalanced elevator loads. This ‘priming’ of the speed regulator is done with the pre-torque command, which is used when the speed regulator release is asserted. The two possible sources for the pre-torque command are following: <ul style="list-style-type: none"> • serial channel • analog channel The serial channel is the RS-422 serial port on the Customer Interface PCB. The analog pre-torque signal is bipolar ($\pm 10V$). Available with the analog channel is a Pre-Torque Command Multiplier (PRE TORQUE MULT (A1)) and Pre-Torque Bias (PRE TORQUE BIAS(A1)). These parameters are used to scale the user’s analog pre-torque command to the proper range for use by the drive software.	NONE	– none – analog input – serial	Y	Y

Parameter	Description	Default	Choices	Hidden Item	Run lock out
PreTorque LATCH	<p>(PreTorque Latch) If Pre-Torque latching is NOT selected, the Pre-Torque signal must be valid when the speed regulator is commanded to run. For verification on timing, see NORMAL operating sequence on page 21.</p> <p>Some car controllers send both analog pre-torque and speed commands . To facilitate this, the Drive has the option of latching the pre-torque command.</p> <p>If pre-torque latching is selected using the Pre-Torque Latch parameter, a FALSE to TRUE transition on the pre-torque latch clock latches the value on the pre-torque channel into the drive. This channel is allowed to change any time except during this transition without affecting the value of the latched pre-torque command.</p> <p>The Pre-Torque Latch Clock controls when the pre-torque command is latched. The Pre-Torque Latch clock parameter (Ptorq LATCH CLCK) determines the source of this latch control. The two choices for latch control are the serial channel or a logic input (EXTERNAL TB).</p> <p>The speed regulator uses the latched pre-torque command when the internal Speed Regulator Release signal is asserted. Once the pre-torque command is used, the latch and the pre-torque command are cleared.</p>	NOT LATCHED	<ul style="list-style-type: none"> - latched - not latched 	Y	Y
Ptorq LATCH CLCK	<p>(Pre-Torque Latch Clock) If the PRE-TORQUE LATCH has been set to LATCHED, then this parameter chooses the source for latch control. If set to EXTERNAL TB1, the Pre-Torq Latch signal on TB1 must be selected.</p>	EXTERNAL TB	<ul style="list-style-type: none"> - external tb - serial 	Y	Y
FAULT RESET SRC	<p>(Fault Reset Source)</p> <p>This parameter determines the source of the drive's external fault reset from one of the following sources: an external fault reset signal from a logic input (external tb), a fault reset signal transferred across a serial channel (serial), or the drive automatically resets the faults (automatic). The user also has the option to reset faults directly through the operator.</p> <p><u>Automatic Fault Reset:</u> If the fault reset source is set to automatic, the faults will be reset according to the setting of the FLT RESET DELAY (A1) and FLT RESETS/HOUR (A1) parameters. When a logic input is defined as "fault reset" and this logic input signal is transitioned from false to true: an active fault will be reset and automatic fault reset counter (defined by FLT RESETS/HOUR(A1)) will be reset to zero.</p> <p>CAUTION: If the run signal is asserted at the time of a fault reset, the drive will immediately go into a run state. Unless using the auto-fault reset function (FAULT RESET SRC (C1) = automatic), then the run command needs to be cycled to be reset automatically, but will reset if initiated by a logic input without cycling the run command.</p>	EXTERNAL TB	<ul style="list-style-type: none"> - external tb - serial - automatic 	Y	Y

Quattro DC User Switches C1

Parameter	Description	Default	Choices	Hidden Item	Run lock out
OVERSPD TEST SRC	(Overspeed Test Source) This switch determines the source of the overspeed test. Operation of the overspeed test function is specified by the OVRSPD MULT (A1) parameter. Regardless of the setting of this parameter, the user can call for the overspeed test via the Digital Operator.	EXTERNAL TB	– external tb – serial	Y	Y
BRAKE PICK SRC	(Brake Pick Source) If the BRAKE PICK SRC (C1) is set to INTERNAL, the Drive will attempt to pick (lift) the brake when magnetizing current has been developed in the motor.	INTERNAL	– internal – serial	Y	Y
BRAKE PICK CNFM	(Brake Pick Confirm) If this switch is set to EXTERNAL TB, the Drive will wait for brake pick confirmation before releasing the speed reference. When set to EXTERNAL TB, the MECH BRK PICK signal on TB1 must also be selected.	NONE	– none – external tb – internal time	Y	Y
BRAKE HOLD SRC	(Brake Hold Source) If set to internal, the drive will command the mechanical brake to hold mode after confirmation of brake picked exists.	INTERNAL	– internal – serial	Y	Y
RAMPED STOP SEL	(Ramp Stop Select) This parameter allows the selection of the Torque Ramp Down Stop function. This function is used to gradually remove the torque command after the elevator has stopped and the mechanical brake has been set. This prevents a shock and possible 'bump' felt in the elevator from the torque signal going to zero too quickly. For more information, see Ramp Stop Select on page 60.	NONE	– none – ramp on stop	Y	Y
RAMP DOWN EN SRC	(Ramp Down Enable Source) If RUN LOGIC is selected, the user can remove the run command and the drive will delay in dropping the run command until torque ramp down stop function is complete. If EXTERNAL TB or SERIAL is selected, the user must keep the run command while allowing the Torque Ramp Down Stop function to be completed.	EXTERNAL TB	– external tb – run logic – serial	Y	Y
BRK PICK FLT ENA	(Brake Pick Fault Enable) When this parameter is set to ENABLE, the brake pick command and confirmation must match within the specified time determined by the BRK PICK TIME (A1) parameter or a brake pick fault is declared.	DISABLE	– disable – enable	Y	Y
BRK HOLD FLT ENA	(Brake Hold Fault Enable) When this parameter is set to ENABLE, the brake hold command and confirmation must match within the specified time determined by the BRK HOLD TIME (A1) parameter or a brake hold fault is declared.	DISABLE	– disable – enable	Y	Y

Parameter	Description	Default	Choices	Hidden Item	Run lock out
EXT TORQ CMD SRC	<p>(Torque Command Source) Sets the source of an external torque command, if any. Selections are:</p> <ul style="list-style-type: none"> - NONE: no external torque command used - SERIAL: supplied via the serial link - ANALOG: supplied via an analog input channel <div style="border: 1px solid black; padding: 5px; margin: 10px 0;"> <p style="text-align: center;">WARNING</p> <p>If using an external torque command (SPEED REG TYPE (C1) = external reg and EXT TORQ CMD SRC (C1) = analog input), it is imperative that the encoder polarity matches incoming torque command polarity. To verify polarity, insert a positive torque command into the analog input. Check ENCODER FEEDBACK (D1) to verify it is also a positive value. If not, swap A and /A or change the ENCODER CONNECT (C1) parameter.</p> </div> <p>NOTE:</p> <ul style="list-style-type: none"> • if SPEED REG TYPE (C1) is set to external reg and EXT TORQ CMD SRC (C1) is set to serial or analog, the drive is a torque controller • if SPEED REG TYPE (C1) is set for a speed regulator (either pi speed reg or elev spd reg) and EX TORQ CMD SRC (C1) is set to either analog or serial, the torque command will be used as an auxiliary torque command (torque feedforward command) 	NONE	<ul style="list-style-type: none"> - none - serial - analog input 	Y	Y
DIR CONFIRM	<p>(Direction Confirm) When enabled, the function allows confirmation of the polarity of the initial analog speed command via the Run Up or Run Down logic input commands.</p> <ul style="list-style-type: none"> • If the Run Up logic input is selected and true with the polarity of the analog signal positive, then the analog speed command is accepted unchanged. • If the logic input Run Down logic input is selected and true with the polarity of the analog speed command negative, the analog speed command is accepted unchanged. • If however, the logic input Run Up is true and the polarity is negative or the logic input Run Down is true and the polarity is positive, then the speed command is held at zero. 	DISABLED	<ul style="list-style-type: none"> - disabled - enabled 	Y	Y

Quattro DC User Switches C1

Parameter	Description	Default	Choices	Hidden Item	Run lock out
S-CURVE ABORT	<p>(S-Curve Abort) This parameter, S-CURVE ABORT (C1), addresses how the S-Curve Speed Reference Generator handles a reduction in the speed command before the S-Curve Generator has reached its target speed.</p> <p><u>Disabled:</u> With a normal S-curve function, a change in the speed command is never allowed to violate the defined acceleration or jerk rates. If a reduction in the speed command is issued before the S-Curve generator has reached its target speed, then the jerk rate dictates what speed is reached before the speed may be reduced.</p> <p><u>Enabled:</u> The optional S-Curve abort has been selected. In this case when the speed command is reduced, the speed reference immediately starts to reduce violating the jerk limit (thus no jerk out phase), which could be felt in the elevator.</p> <p>For optional S-Curve abort to be active requires that:</p> <ul style="list-style-type: none"> • The speed command source must be selected as Multi-step (SPD COMMAND SRC=multi-step). • The S-curve Abort function must be ENABLED (S-CURVE ABORT = enabled). 	DISABLED	<ul style="list-style-type: none"> - disabled - enabled 	Y	Y
ENCODER FAULT	<p>(Encoder Fault Enable) This parameter allows the user to temporarily disable the Encoder Fault. Adding this feature allows the user to temporarily disable the Encoder Fault during the initial start-up process, when the motor model (defined by the A6 Motor Parameters) is not clearly defined.</p> <p>When the Encoder Fault is disabled (ENCODER FAULT (C1) = disabled), the drive will display the warning message "EncoderFault OFF", every time the RUN command is removed.</p> <p>IMPORTANT: After the motor parameters in A6 have been established, the Encoder Fault should be enabled (ENCODER FAULT (C1) = enabled).</p> <p>Note: the default for the ENCODER FAULT (C1) parameter is enabled.</p>	ENABLE	<ul style="list-style-type: none"> - disable - enable 	Y	Y
PRIORITY MESSAGE	<p>(Priority Message Enabling) With Priority Message disabled the user will not see priority messages meaning faults and alarms will not be displayed on the operator, but the faults will be placed into the fault history and active fault lists with the Fault LED on. Leave Priority Message enabled when drive is not being worked on.</p>	ENABLE	<ul style="list-style-type: none"> - enable - disable 	Y	Y

Parameter	Description	Default	Choices	Hidden Item	Run lock out
<p>STOPPING MODE</p>	<p>(Multi-step Stopping Mode Selection) When the speed command source is set to multi-step (SPD COMMAND SRC (C1)=multi-step), the parameter, STOPPING MODE (C1), determines the stopping mode of the Drive. The two selectable methods for the Stopping Mode parameter are "Immediate" and "Ramp to stop". Note: If the SPD COMMAND SRC (C1) parameter is set to any other definition other than "multi-step", the drive will behave to the "immediate" stopping mode (independent of the setting of the STOPPING MODE (C1) parameter). The "Immediate" stopping mode requires the drive to be at zero speed prior to removing the "Run" command. The "Immediate" selection is how the drive has traditionally behaved prior to the addition of this parameter. The "Ramp to stop" stopping mode is intended for use when removing the "Run" command prior to the drive reaching zero speed (as defined by the AB ZERO SPD LEV (A1) parameter). When the "Run" command is removed and the speed reference is above zero speed, the speed reference will ramp to zero speed following the selected s-curve.</p>	<p>IMMEDIATE</p>	<ul style="list-style-type: none"> - immediate - ramp to stop 	<p>Y</p>	<p>Y</p>

Quattro DC User Switches C1

Parameter	Description	Default	Choices	Hidden Item	Run lock out
AUTO STOP	<p>(Auto Stop Function Enable) When the speed command source is set to multi-step or serial (SPD COMMAND SRC (C1)=multi-step or serial), the parameter determines the stopping mode of the drive. The two selectable methods for the STOPPING MODE (C1)* parameter are "Immediate" and "Ramp to stop".</p> <p>The Auto Stop function determines how the drive logic will respond to a zero or non-zero speed command. The function will only work when the speed command source is either multi-step or serial (SPD COMMAND SRC (C1)=multi-step or serial).</p> <p><u>Disabled:</u> When the Auto Stop function is disabled, the magnitude of the speed command plays no part in the logical starting or stopping of the drive.</p> <p><u>Enabled:</u> When the Auto Stop function is enabled and the speed command source is either multi-step or serial, the following changes occurs to the start and stop sequence:</p> <ul style="list-style-type: none"> • Both a Run command and a non-zero speed command are required to start the drive • Either the removal of the Run command or the setting the speed command to zero will initiate a stop. <p>Remember, when the auto stop function is enabled (AUTO STOP (C1)=enabled) both a non-zero multi-step/serial speed command AND the run command are required to start the drive. It makes no difference which signal is enabled first, the drive does not start until both are present. When initiating a stop, which signal is removed first does make a difference.</p>	DISABLE	<ul style="list-style-type: none"> - disable - enable 	Y	Y
DSPR ENABLE	<p>(DSPR Enable) Turns Drive Standby Power Reduction (DSPR) feature ON or OFF. The choices are:</p> <p>ON – Drive will turn motor field current off, shut down the input rectifier and open AC line input contactor after being in a Standby condition for longer than [DSPR Time] minutes.</p> <p>OFF – DSPR function not active. Drive will remain in Standby condition with utility input contactor closed until commanded to re-start.</p> <p>If DSPR is active, the drive will close the utility input contactor and re-start when a valid run or field enable command is received. A delay of several seconds may elapse while power control sections of the drive are re-started.</p>	DISABLE	<ul style="list-style-type: none"> - disable - enable 	Y	Y

Table 9: User Switches C1 Submenu

Detailed descriptions

HI/LO GAIN SRC

(High / Low Gain Source)

This parameter determines the source of the high / low gain switch.

The speed regulator high / low gain function was developed in response to high performance elevator requirements where the resonant nature of the elevator system interferes with the speed response of the drive.

When the speed response (gain) is set to high levels, the resonant characteristics created by the spring action of the elevator ropes can cause car vibration. To solve this problem, the speed regulator is set to a low enough response (gain) so that the resonant characteristics of the ropes are not excited.

This is accomplished by controlling the sensitivity or response of the speed regulator via the high / low gain switch and gain reduce multiplier.

By using the gain reduce multiplier, the user can specify a lower response (gain) for the speed regulator when the drive is at higher speeds. The gain reduce multiplier (GAIN REDUCE MULT(A1)) tells the software how much lower, as a percentage, the speed regulator response (gain) should be.

The high / low gain switch determines when the drive is in 'low gain' mode. In the 'low gain' mode, the gain reduce multiplier has an effect on the speed regulator's response (gain).

The drive allows for the high / low gain switch to be controlled either externally or internally. The high / low gain source parameter (HI/LO GAIN SRC) allows for this external or internal selection.

The high / low gain switch can be controlled externally by either:

- a logic input
- the serial channel.

The high / low gain switch can also be controlled internal by:

- the gain change level parameter (GAIN CHNG LEVEL), which defines a percentage of contract speed.

With the drive set to internal control, the speed regulator will go into 'low gain' mode when the drive senses the motor is above a defined speed level. The defined speed level is determined by the gain change level parameter.

An example of internal high / low gain control is shown below.

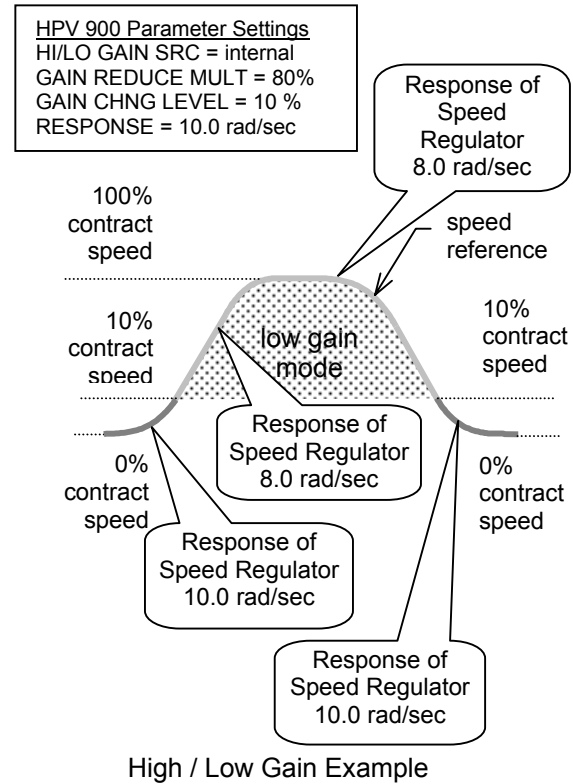

Elevator Speed Regulator (Ereg)

The use of the Elevator Speed Regulator allows the overall closed loop response between speed reference and speed to be ideal for elevator applications. The desirable features of the Elevator Speed Regulator are:

- no overshoot at the end of accel period
- no overshoot at the end of decel period

One characteristic of the Elevator Speed Regulator is that during the accel / decel period the speed feedback does not match the speed reference creating a speed error or tracking delay. As an example, the Elevator Speed Regulator's speed response is shown for a ramped speed reference below.

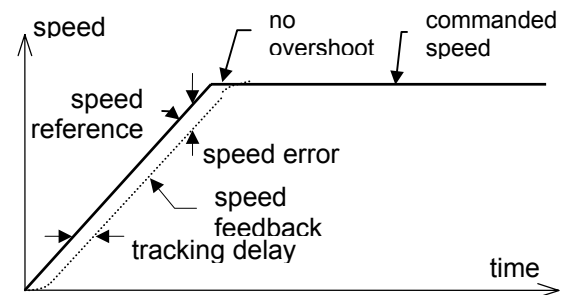

Ereg Example

The Elevator Speed Regulator is tuned by:

- System Inertia parameter (INERTIA(A1)), which is easy to obtain by using the drive software to estimate the system inertia.

Quattro DC User Switches C1

- Response parameter (RESPONSE(A1)), which is the overall regulator bandwidth in radians per sec. This parameter defines the responsiveness of the speed regulator.

The tracking delay shown is defined as (1/RESPONSE) seconds. The tracking delay is not effected by the gain reduce multiplier.

The inner loop crossover parameter (INNER LOOP XOVER(A1)) should not need to be changed. But if the number is changed, it must satisfy the following formula:

$$\text{inner loop crossover} < \text{response} \times \text{gain reduce multiplier}$$

PI Speed Regulator

When the Proportional plus Integral (PI) speed regulator is used, the response to a speed reference is different. As an example, the PI Speed Regulator's speed response is shown below for a ramped speed reference. With the PI speed regulator, the end of each accel and decel period, there will be an overshoot. The amount of overshoot will be a function of the defined phase margin and response parameters.

Because of this overshoot, the PI regulator is not recommended for elevator control by itself. However, the PI regulator is the proper choice when a live torque demand signal is available from the car controller as an always-active Feed-Forward compensating signal. See EXTERNAL TORQ SRC (C1).

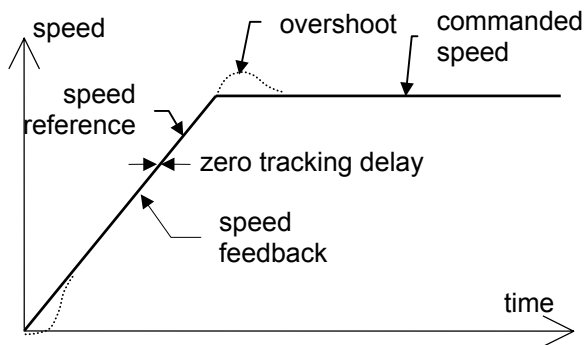

The PI Speed Regulator is tuned by:

- System Inertia parameter (INERTIA(A1)), which is easy to obtain by using the drive software to estimate the system inertia.
- Response parameter (RESPONSE(A1)), which is the overall regulator bandwidth in radians per sec. This parameter defines the responsiveness of the speed regulator.
- Speed Phase Margin parameter (SPD PHASE MARGIN(A1)) is used only by the

PI Speed Regulator to define the phase margin of the speed regulator.

Ramp Stop Select

This parameter allows the selection of the Torque Ramp Down Stop function. This function is used to gradually remove the torque command after the elevator has stopped and the mechanical brake has been set. This prevents a shock and possible 'bump' felt in the elevator from the torque signal going to zero too quickly.

A function unique to elevators involves the interaction between the motor torque and the mechanical brake that holds the elevator. Under full load conditions at the end of a run, if the brake is set and the motor torque is removed quickly, some brake slippage may occur. Therefore, the option of gradually reducing the motor torque is provided by the Torque Ramp Down Stop function.

Upon being enabled by the Ramped Stop Select Parameter (RAMPED STOP SEL(C1)), the torque command is linearly ramped to zero from the value that was present when the 'Ramp Down Enable' was selected.

The Ramp Down Enable has the following three possible sources:

- An input logic bit (EXTERNAL TB)
- The run logic – initiated by the removal of the run command
- The serial channel

The Ramp Down Enable Source parameter (RAMP DOWN EN SRC(C1)) is used to select one of the above options.

A method of providing the Ramp Down Enable would be with a logic signal (EXTERNAL TB) that is dedicated to that function. The Ramp Down Enable would be asserted while the Run command is still present and remain there until the ramp is completed, after which the Run command would be removed.

The RUN LOGIC option to trigger the Ramp Down Enable from the Run command is provided. In this case, removal of the Run command enables the Ramp Down Stop Function.

The time it takes for the Drive to perform its ramped stop is determined by the Ramped Stop Time Parameter. The Ramped Stop Time parameter (RAMPED STOP TIME(A1)) selects the amount of time it would take for the drive to ramp from the rated torque to zero torque.

Logic Inputs C2 submenu

(Logic Inputs 1-9)

This parameter defines the function of the logic inputs.

NOTE: The user can assign particular functions to each input terminal. Only one function per terminal is allowed and multiple terminals cannot have the same function (except "No Function"). When a function is assigned to an input terminal, it is removed from the list of possible selections for

subsequent terminals. **To re-assign a function to a different terminal one must first assign "No Function" to the original terminal so that the desired function is returned to the list of selections and can be assigned to a different new terminal.**

NOTE: The *current* setting of each parameter is displayed in all caps; all other choices in the list are displayed in lower case.

Parameter	Description	Default	Hidden Item	Run lock out																																																																																					
N.C. INPUTS	<p>(Normally Closed Inputs) All Logic Inputs may be configured for use with Normally Open or Normally Closed external contacts. The numeric entry is a hexadecimal representation of a binary control bit for each channel. A binary 0 means Normally Open. A binary 1 indicates a Normally Closed external switch. Logic Input #1 is the least significant bit. The defaulted value of 0001 indicates logic input 1 is normally closed.</p> <p>Binary 0000, 0000, 0000, 0000</p> <p>See table below for converting binary to hex:</p> <table border="1"> <thead> <tr> <th>Bit 3</th> <th>Bit 2</th> <th>Bit 1</th> <th>Bit 0</th> <th>Hex</th> </tr> </thead> <tbody> <tr><td>0</td><td>0</td><td>0</td><td>0</td><td>0</td></tr> <tr><td>0</td><td>0</td><td>0</td><td>1</td><td>1</td></tr> <tr><td>0</td><td>0</td><td>1</td><td>0</td><td>2</td></tr> <tr><td>0</td><td>0</td><td>1</td><td>1</td><td>3</td></tr> <tr><td>0</td><td>1</td><td>0</td><td>0</td><td>4</td></tr> <tr><td>0</td><td>1</td><td>0</td><td>1</td><td>5</td></tr> <tr><td>0</td><td>1</td><td>1</td><td>0</td><td>6</td></tr> <tr><td>0</td><td>1</td><td>1</td><td>1</td><td>7</td></tr> <tr><td>1</td><td>0</td><td>0</td><td>0</td><td>8</td></tr> <tr><td>1</td><td>0</td><td>0</td><td>1</td><td>9</td></tr> <tr><td>1</td><td>0</td><td>1</td><td>0</td><td>A</td></tr> <tr><td>1</td><td>0</td><td>1</td><td>1</td><td>B</td></tr> <tr><td>1</td><td>1</td><td>0</td><td>0</td><td>C</td></tr> <tr><td>1</td><td>1</td><td>0</td><td>1</td><td>D</td></tr> <tr><td>1</td><td>1</td><td>1</td><td>0</td><td>E</td></tr> <tr><td>1</td><td>1</td><td>1</td><td>1</td><td>F</td></tr> </tbody> </table>	Bit 3	Bit 2	Bit 1	Bit 0	Hex	0	0	0	0	0	0	0	0	1	1	0	0	1	0	2	0	0	1	1	3	0	1	0	0	4	0	1	0	1	5	0	1	1	0	6	0	1	1	1	7	1	0	0	0	8	1	0	0	1	9	1	0	1	0	A	1	0	1	1	B	1	1	0	0	C	1	1	0	1	D	1	1	1	0	E	1	1	1	1	F	0001	Y	Y
Bit 3	Bit 2	Bit 1	Bit 0	Hex																																																																																					
0	0	0	0	0																																																																																					
0	0	0	1	1																																																																																					
0	0	1	0	2																																																																																					
0	0	1	1	3																																																																																					
0	1	0	0	4																																																																																					
0	1	0	1	5																																																																																					
0	1	1	0	6																																																																																					
0	1	1	1	7																																																																																					
1	0	0	0	8																																																																																					
1	0	0	1	9																																																																																					
1	0	1	0	A																																																																																					
1	0	1	1	B																																																																																					
1	1	0	0	C																																																																																					
1	1	0	1	D																																																																																					
1	1	1	0	E																																																																																					
1	1	1	1	F																																																																																					
LOGIC INPUT 1 TB1(1)	logic input #1 note: drive comes pre-wired for logic input #1 to be CONTACT CFIRM	CONTACT CFIRM	Y	Y																																																																																					
LOGIC INPUT 2 TB1(2)	logic input #2 note: drive comes pre-wired for logic input #2 to be CTR PWR SENSE	CTR PWR SENSE	Y	Y																																																																																					
LOGIC INPUT 3 TB1(3)	logic input #3	NO FUNCTION	Y	Y																																																																																					
LOGIC INPUT 4 TB1(4)	logic input #4	DRIVE ENABLE	Y	Y																																																																																					
LOGIC INPUT 5 TB1(5)	logic input #5	RUN	Y	Y																																																																																					
LOGIC INPUT 6 TB1(6)	logic input #6	UP/DWN	Y	Y																																																																																					
LOGIC INPUT 7 TB1(7)	logic input #7	STEP REF B0	Y	Y																																																																																					
LOGIC INPUT 8 TB1(8)	logic input #8	STEP REF B1	Y	Y																																																																																					
LOGIC INPUT 9 TB1(9)	logic input #9	FAULT RESET	Y	Y																																																																																					

Quattro DC Logic Inputs C2 Submenu

choices	
contact cfirm	(Contactor closed) Feedback from an auxiliary contact on the motor contactor. Default is that the drive expects a normally closed contact to energize the input when the contactor is not pulled in.
ctr pwr sense	(Contactor Power Sensing) Energized when AC power is available to energize the motor contactor. Power to this circuit is control by elevator relay logic. This circuit must be energized before the drive will be allowed to start. If power is not available when told to start, or while running, a Fault will occur for diagnostic purposes.
drive enable	(Drive Enable) Enables drive to run. This signal must be asserted to permit drive to run. This does not initiate run, just permits initiation.
extrn fault 1	(External Fault 1) User input fault #1.
extrn fault 2	(External Fault 2) User input fault #2.
extrn fault 3	(External Fault 3) User input fault #3.
extrn /flt 4	(External Fault 4) User input fault #4. Opening of this contact will cause the drive to declare a fault and perform a fault shutdown.
fault reset	(Fault Reset) Asserting this input attempts to reset faults. If the FAULT RESET SRC (C1) switch is set to EXTERNAL TB, the drive's fault circuit will be reset when this signal is true. If the FAULT RESET SRC (C1) switch is set to AUTOMATIC, the drive's fault circuit will be reset when this signal is true and the automatic fault reset counter (defined by FLT RESETS/HOUR) will be reset to zero. *This input is edge sensitive and the fault is reset on the transition from false to true.
field enable	(Field Enable) If FIELD ENA SOURCE (C1) switch is set to EXTERNAL TB, the field is enabled when this signal is true.
low gain sel	(Low Gain Select) If the HI/LO GAIN SRC (C1) switch is set to EXTERNAL TB, the low gain mode is chosen for the speed regulator when this signal is true.
mech brk hold	(Mechanical Brake Hold) Auxiliary contact closures confirming when the mechanical brake is in the hold mode (engaged).
mech brk pick	(Mechanical Brake Pick) Closure of auxiliary contacts confirming the mechanical brake has been picked (lifted).
no function	(No Function) When this setting is selected for one of the TB1 input terminals, any logic input connected to that terminal will have no effect on drive operation.
ospd test src	(Overspeed Test Source) This function works only if the OVSPEED TEST SRC (C1) switch is set to EXTERNAL TB. A true signal on this input applies the OVSPEED MULT to the speed command for the next run. After the run command has dropped, the drive returns to 'normal' mode and must be re-configured to perform the overspeed function again. The OVSPEED FLT level is also increased by the OVSPEED MULT, allowing the elevator to overspeed without tripping out on an overspeed fault. NOTE: This input must be taken false then true each time that an overspeed test is run. If the input is left in the true, it is ignored after the first overspeed test.
pre-trq latch	(Pre-Torque Latch) Closing a contact between this input and ground latches the pre torque command present on the analog channel #2.
run	(Run) If drive is enabled through the DRIVE ENABLE logic input, this function will start drive operation.
run down	(Run Down) If drive is enabled through the DRIVE ENABLE logic input, this function will start drive operation with negative speed commands. Note: if both RUN UP and RUN DOWN are true then the run is not recognized. Note: if DIR CONFIRM (C1) is enabled, this input will not change the polarity of the speed command and will be used to confirm the polarity of the analog speed command as well as starting the operation of the drive.
run up	(Run Up) If drive is enabled through the DRIVE ENABLE logic input, this function will start drive operation with positive speed commands. Note: if both RUN UP and RUN DOWN are true then the run is not recognized. Note: if DIR CONFIRM (C1) is enabled, this input is also used to confirm the polarity of the analog speed command as well as starting the operation of the drive.
s-curve sel 0	Bit 0 of S-curve selection
s-curve sel 1	Bit 1 of S-curve selection
	These two bits are used to select one of four s-curve selections. For more information, see S-Curves A2 submenu on page 39.
ser2 insp ena	(Serial Mode 2 Inspection Enable) Used only with custom serial protocol (mode 2) Defines the logic input to be used as one of the two sources of inspection run command when using serial mode 2. This input must be true as well as a comparable inspection run command sent serially for the drive to run in inspection mode.
step ref b0	Bit 0 of multi-step speed command selection
step ref b1	Bit 1 of multi-step speed command selection
step ref b2	Bit 2 of multi-step speed command selection
step ref b3	Bit 3 of multi-step speed command selection
	Four inputs, which must be used together as a 4-bit command for multi-step speed selection. For more information, see Multistep Ref A3 submenu on page 41.
trq ramp down	(Torque Ramp Down Signal) This function works only if the RAMP STOP SEL (C1) switch is set to RAMP TO STOP and RAMP DOWN EN SRC (C1) is set to EXTERNAL TB.
up/dwn	(Up/Down Signal) This signal is used to change the sign of the speed command. Default is FALSE; therefore, positive commands are for the up direction and negative speed command are for the down direction. Making this input true reverses the car's direction.

Table 10: Logic Inputs C2 Submenu

Logic Outputs C3 submenu

LOGIC OUTPUT x

(Logic Outputs 1-4)

This parameter defines the function of the logic outputs.

NOTE: The *current* setting of each parameter is displayed in all caps; all other choices in the list are displayed in lower case.

RELAY COIL x

(Relay Logic Outputs 1-2)

This parameter defines the function of the relay logic outputs.

NOTE: The *current* setting of each parameter is displayed in all caps; all other choices in the list are displayed in lower case.

Parameter	Description	Defaults	Hidden Item	Run lock out
LOGIC OUTPUT 1 (TB1-25)	logic output #1 note: drive comes pre-wired for logic output #1 to be CLOSE CONTACT	CLOSE CONTACT	Y	Y
LOGIC OUTPUT 2 (TB1-26)	logic output #2	RUN COMMANDED	Y	Y
LOGIC OUTPUT 3 (TB1-27)	logic output #3	MTR OVERLOAD	Y	Y
LOGIC OUTPUT 4 (TB1-28)	logic output #4	ENCODER FLT	Y	Y
LOGIC OUTPUT 5 (TB1-29)	logic output #5	FAULT	Y	Y
LOGIC OUTPUT 6 (TB1-30)	logic output #6	SPEED REG RLS	Y	Y
LOGIC OUTPUT 7 (TB1-31)	logic output #7	SPEED REG RLS	Y	Y
RELAY COIL 1 (TB1-21/22)	relay output #1	NO FUNCTION	Y	Y
RELAY COIL 2 (TB1-23/24)	relay output #2	NO FUNCTION	Y	Y
SSR1 (TB1-1/3/5)	solid State Relay 1	NO FUNCTION	Y	Y
SSR2 (TB1-8/10/12)	solid State Relay 2	NO FUNCTION	Y	Y

choices

alarm	(Alarm) The output is true when an alarm is declared by the drive.
alarm+flt	(Alarm and/or Fault) The output is true when a fault and/or an alarm is declared by the drive.
auto brake	(Auto Brake) The output is controlled by the Auto Brake function and is used to open the mechanical brake. (only multi-step speed commands)
brake hold	(Brake Hold) The output is true when the brake pick confirmation is received. It is used to show the mechanical brake is remaining open. This function is used with brakes that need to have less than 100% voltage to hold the brake open.
brake pick	(Brake Pick) The output is true when the speed regulator is released and is used to open the mechanical brake.
brk hold flt	(Brake Hold Fault) The output is true when the brake hold command and the brake feedback do not match for the user specified time.
brk pick flt	(Brake Pick Fault) The output is true when the brake pick command and the brake feedback do not match for the user specified time.
car going dwn	(Car Going Down) The output is true when the motor moves in negative direction faster than the user specified speed.
car going up	(Car Going Up) The output is true when motor moves in positive direction faster than user specified speed.
charge fault	(Charging Fault) The output is true when the DC bus voltage has not stabilized above the voltage fault level or the charge contactor has not closed after charging.
close contact	(Close Motor Contactor) The output is true when the run command is given, the drive is enabled, the software has initialized, and no faults are present.
contactor flt	(Contactor Fault) The output is true when the command to close the contactor and the contactor feedback do not match before the user specified time.
curr reg flt	(Current Regulator Fault) The output is true when the actual current measurement does not match commanded current.
drv overload	(Drive Overload) The output is true when the drive has exceeded the drive overload curve.
encoder flt	(Encoder Fault) The output is true when the encoder is disconnected or not functioning, while attempting to run
fault	(Fault) The output is true when a fault is declared by the drive.
flux confirm	(Motor Flux Confirmation) The output is true when the drive has confirmed there is enough motor field current (flux) to issue a speed regulator release. Threshold is set by measured motor field current being greater than that set at Motor parameter A6, Flux Confirm Level.

Quattro DC Logic Outputs C3 Submenu

choices continued	
ground fault	(Ground Fault) The output is true when the sum of all phase current exceeds 50% of rated current of the drive.
in low gain	(In Low Gain) The output is true when the speed regulator is in "low gain" or response mode.
motor trq lim	(Motor Torque Limit) The output is true when the torque limit has been reached while the drive is in the motoring mode. The motoring mode is defined as the drive delivering energy to the motor.
mtr overload	(Motor Overload) The output is true when the motor has exceeded the user defined motor overload curve.
no function	(No Function) This setting indicates that the terminal or relay will not change state for any operating condition; i.e. the output signal will be constantly false.
not alarm	(Not Alarm) The output is true when an alarm is NOT present.
over curr flt	(Motor overload current fault) The output is true when the phase current has exceeded 300% of rated current.
overspeed flt	(Overspeed Fault) The output is true when the motor has gone beyond the user defined percentage contract speed for a specified amount of time.
overtemp flt	(Heatsink Over Temperature Fault) The output is true when the drive's heatsink has exceeded 90°C (194°F).
overvolt flt	(Over Voltage Fault) The output is true when the DC bus voltage exceeds 825VDC.
ovrtemp alarm	(Over Temperature Alarm) The output is true when the drive's heatsink temperature has exceeded 80°C (176°F).
phase fault	(Phase Loss) The output is true when the drive senses an open motor phase.
ramp down ena	(Ramp Down Enable) The output is true after a torque ramp down stop has been initiated by either a logic input, the serial channel, or internally by the drive. When this output is true the torque is being ramped to zero.
ready 2 start	(Ready to Start) The output is true when the drive's software has been initialized, no faults are present and the drive is <i>not</i> boosting.
ready to run	(Ready to Run) The output is true when the drive's software has been initialized, no faults are present and the drive is boosting.
regen trq lim	(Regeneration Torque Limit) The output is true when the torque limit has been reached while the drive is in the regenerative mode. The regenerative mode is defined as when the motor is returning energy to the drive. When the drive is in regenerative mode, the energy is dissipated via the dynamic brake circuitry (internal brake IGBT and external brake resistor).
run commanded	(Run Commanded) The output is true when the drive is being commanded to run.
run confirm	(Run Command Confirm) The output is true after the software has initialized, no faults are present, the drive has been commanded to run, the contactor has closed and the IGBTs are firing.
speed dev	(Speed Deviation) The output is true when the speed feedback is failing to properly track the speed reference. The speed deviation needs to be above a user defined level. (Speed Dev. = reference - feedback)
speed dev low	(Speed Deviation Low Level) The output is true when the speed feedback is properly tracking the speed reference. The speed deviation needs to be within a user-defined range for a user-defined period of time. (Speed Dev. = reference - feedback)
speed ref rls	(Speed Reference Release) The output is true when the flux is confirmed and drive is NOT in DC injection.
speed reg rls	(Speed Regulator Release) The output is true when the flux is confirmed at 75% and brake is commanded to be picked (if used)
undervolt flt	(Low Voltage Fault) The output is true when the DC bus voltage drops below the user specified percent of the input line-to-line voltage.
up to speed	(Up to Speed) The output is true when the motor speed is above the user specified speed
uv alarm	(Under Voltage Alarm) The output is true when the DC bus voltage drops below the user specified percent of the input line-to-line voltage.
zero speed	(Zero Speed) The output is true when the motor speed is below the user specified speed for the user specified time.

Table 11: Logic Outputs C3 Submenu

Analog Outputs C4 submenu

With a gain of 1.0 and an offset of 0.0, 10V will indicate 100% or full value based on programmed values. For example, with the above scenario of a gain of 1.0 and an offset of 0.0, a 10V signal an Analog Output set to arm current would indicate 100% of rated current.

Whereas a 0V signal on the same Analog Output would indicate 0% of rated current.

Any value over 100% will cause the analog channel to saturate.

Parameter	Description	Default	Hidden Item	Run lock out
ANALOG OUTPUT 1	analog output #1	SPEED REF	Y	Y
ANALOG OUTPUT 2	analog output #2	SPEED FEEDBK	Y	Y

<i>choices</i>	<i>description</i>	<i>D/A units</i>
arm current	(Motor Armature Current) Measured motor armature current	% rated current
arm voltage	(Motor Armature Voltage) Measured motor armature voltage	% of rated volts
aux torq cmd	(Auxiliary Torque Command) Additional torque command from auxiliary source	% rated torque
bus voltage	(DC Bus Voltage Output) Measured DC bus voltage	% of peak in
est motor spd	(Estimated Motor Speed) Estimated speed of the motor	RPM
field current	(Motor Field Current) Measured motor field current	% of rated (Full Field)
iarm error	(Armature Current Error) Measures the difference between the reference current and the measured current	Amps
pretorque ref	(PreTorque Reference) Pre-torque reference	% base torque
motor mode	(Motor Mode) Voltage level switches to indicate the mode the current regulator is operating in. 1) Forward motoring (~ 9.7V) 2) Forward regeneration (high CEMF) (~ 4.4V) 3) Forward plugging (regeneration at low CEMF) (~ 1.3V) 4) Reverse plugging (regeneration at low CEMF) (~ -1.3V) 5) Reverse regeneration (high CEMF) (~ -4.4V) 6) Reverse motoring (~ -9.7V)	-
spd rg tq cmd	(Speed Regulator Torque Command) Torque command from speed regulator	% base torque
speed command	(Speed Command) Speed command before S-Curve	% rated speed
speed error	(Speed Error) Speed reference minus speed feedback	% rated speed
speed feedbk	(Speed Feedback) Speed feedback used by speed regulator	% rated speed
speed ref	(Speed Reference) Speed reference after S-Curve	% rated speed
tach rate cmd	(Tachometer Rate Command) Torque command from tach rate gain function	% base torque
tach speed	(Tachometer / Encoder Speed) Bi-directional signal representing velocity measured by the encoder.	ft/min or m/sec
torque ref	(Torque Reference) Torque reference used by vector control	% base torque

Table 12: Analog Outputs C4 Submenu

Display D0 menu

Elevator Data D1 submenu

Parameter	Description	Units	Hidden Item		
SPEED COMMAND	(Speed Command) Monitors the speed command before the speed reference generator (input to the S-Curve). This command comes from either multi-step references, speed command from analog channel, or the serial channel.	ft/min or m/s	N		
SPEED REFERENCE	(Speed Reference) Monitors the speed reference being used by the drive. This is the speed command after passing through the speed reference generator (which uses a S-Curve).	ft/min or m/s	N		
SPEED FEEDBACK	(Speed Feedback) Monitors the speed feedback coming from the encoder. It is based on contract speed, motor rpm and encoder pulses per revolution. The drive converts from motor RPM to linear speed using the relationship between the CONTRACT CAR SPD (A1) and CONTRACT MTR SPD (A1) parameters.	ft/min or m/s	N		
SPEED ERROR	(Speed Error) Monitors the speed error between the speed reference and the speed feedback. It is equal to the following equation: $\left(\begin{matrix} speed \\ reference \end{matrix} \right) - \left(\begin{matrix} speed \\ feedback \end{matrix} \right) = \begin{matrix} speed \\ error \end{matrix}$	ft/min or m/s	N		
PRE-TORQUE REF	(Pre-Torque Reference) Monitors the pre torque reference, coming from either analog channel #2 or the serial channel.	% rated torque	N		
EXT-TORQUE CMD	(External Torque Command) Monitors the Torque Feed Forward Command when used.	% of rated current	N		
SPD REG TORQ CMD	(Speed Regulator Torque Command) Monitors the speed regulator's torque command. This is the torque command before it passes through the tach rate gain function or the auxiliary torque command. It is the torque required for the motor to follow the speed reference.	% rated torque	Y		
TACH RATE CMD	(Tachometer Rate Command) Monitors the torque command from the tach rate gain function, (if used).	% rated torque	Y		
AUX TORQUE CMD	(Auxiliary Torque Command) Monitors the feedforward torque command from auxiliary source, when used.	% rated torque	Y		
EST INERTIA	(Estimated Inertia) Estimated elevator system inertia.	seconds	N		
RX COM STATUS (continued on next page)	(Serial Communications Status)	1=true 0=false	N		
	Bit			Severity	Name Description/Reason
	0			Info	RX_INVALID_SETUP_ID Invalid setup id on setup message
	1			Info	RX_SETUP_IN_RUN A setup message to write was received while the serial run bit was set.
	2			Fatal	RX_TIMEOUT A COMM Fault was declared because of a communication time-out.
	3			Info / Fatal	RX_INVALID_CHECKSUM If COMM FAULT was declared because of bad message checksums.
	4			Info	RX_INVALID_MESSAGE Invalid header character in message.
5	Info	RX_FIFO_OVERRUN Overflow has occurred.			
6	Info	RX_INVALID_RUN_ID Set if the Cmd_Id sent in the RUN MESSAGE is not in range.			

Parameter	Description	Units	Hidden Item
RX COM STATUS (continued)	Bit	Severity	Name Description/Reason
	7	Info	<i>RX_INVALID_MONITOR_ID</i> (Not available in Mode 2) Set if the Monitor_Id received in the run message is not in range.
	8	Info	<i>RX_INVALID_FAULT_ID</i> Set if the Fault_Id sent in the setup message is not in range.
	9	Info	<i>RX_FAULT_DETECTED</i> COMM FAULT has been detected
	10	Info	<i>Fault_Mode_1</i> (Not available in Mode 1) Immediate Shutdown Mode
	11	Info	<i>Fault_Mode_2</i> (Not available in Mode 1) Run Removal Shutdown Mode
	12	Info	<i>Fault_Mode_3</i> (Not available in Mode 1) Rescue Shutdown Mode
	13		N/a
	14		N/a
15	Fatal	<i>RX_COMM_FAULT</i> COMM FAULT has been declared by the drive	
		1=true 0=false	N
LOGIC OUTPUTS	(Logic Outputs Status) This display shows the condition of the logic outputs. (1=true 0=false) 	1=true 0=false	N
LOGIC INPUTS	(Logic Inputs Status) This display shows the condition of the logic inputs. (1=true 0=false) 	1=true 0=false	N

Table 13: Elevator Display Data D1 Submenu

MS Power Data D2 submenu

Parameter	Description	Units	Hidden Item
ARM CURRENT	(Armature Current) Measured motor armature current	amps	N
FIELD CURRENT	(Field Current) Measured motor field current	volts	N
ARM VOLTAGE	(Armature Voltage) Measured motor armature voltage	volts	N
MS BUS VOLTAGE	(Motor Side Bus Voltage) Measured Motor Side DC bus voltage	volts	N
MOTOR MODE	(Motor Mode) Tells the user is the motor is motoring, regening, CEMF braking, or idle.	none	Y
TORQUE REF	(Torque Reference) This is the output of the speed regulator plus any torque feed forwards from the car controller	%	N
EST SPD FDBK	(Estimated Speed Feedback) Estimated speed based on voltage readings. When running the CEMF regulator, the ES SPD FDBK will equal the speed reference. When running in tach feedback mode, EST SPD FDBK will estimate the speed based on voltages.	m/sec	N
ENCODER SPD	(Encoder Speed) Give the speed of the encoder in meters / second.	m/sec	N
DS MODULE TEMP	(Drive Side Module Temperature) Indicates the hottest of the drive side IGBT module and the line side IGBT module and the Field IGBT.	°C	N
LS MODULE TEMP	(Line Side Module Temperature) Indicates the hottest of the line side converter IGBT module temperature.	°C	N
HIGHEST TEMP	(Highest Measured Temperature) Declares the highest temperature measured on the drive.	°C	N
FIELD IGBT TEMP	(Field IGBT Temperature) Monitors temperature of IGBT module that controls motor field current as indicated by an internal thermistor. Reported in degrees C.	°C	N
ARMATURE CUR ERR	(Armature Current Error) Measured Motor Armature Current in amperes.	amps	N
AUTO FLD INT	(Auto-tune Field Integral Gain) Measured field regulator integral gain as calculated by the auto-tune (in GAIN SELECTION (C1)) after an auto-tune has been done.	none	N
AUTO FLD PROP	(Auto-tune Field Proportional Gain) Measured field regulator proportional gain as calculated by the auto-tune (in GAIN SELECTION (C1)) after an auto-tune has been done.	none	N
AUTO MEAS ARM L	(Auto-tune Measured Armature Inductance) Measured Motor Armature Inductance as calculated by the auto-tune (in GAIN SELECTION (C1)) after an auto-tune has been done.	mH	N
AUTO MEAS ARM R	(Auto-tune Measured Armature Resistance) Measured Motor Armature Resistance as calculated by the auto-tune (in GAIN SELECTION (C1)) after an auto-tune has been done.	ohm	N
AUTO FIELD RES	(Auto-tune Measured Field Resistance) Measured Field Resistance as calculated by the auto-tune (in GAIN SELECTION (C1)) after an auto-tune has been done.	ohm	N
AUTO FIELD TC	(Auto-tune Measured Field Time Constant) Measured Field Time Constant as calculated by the auto-tune (in GAIN SELECTION (C1)) after an auto-tune has been done.	sec	N

Table 14: Power Data D2 Submenu

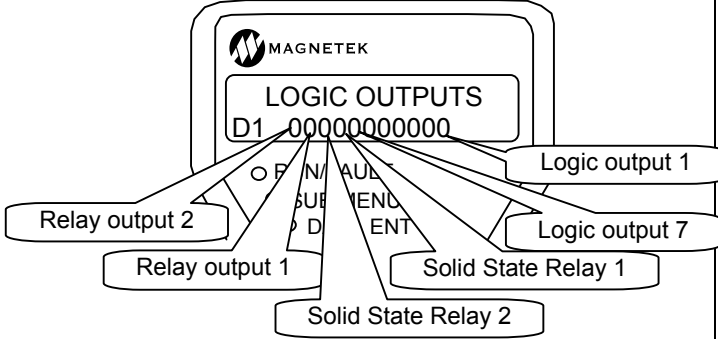
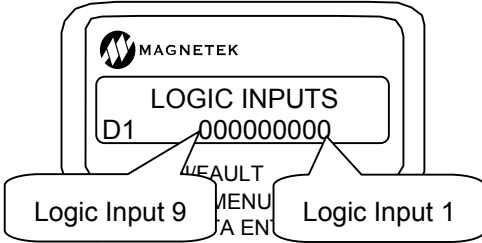
LS Power Data D3 submenu

Parameter	Description	Units	Hidden Item
LS PWR OUTPUT	(Line Side Power Output) Estimated power transfer to and from the AC Line. Value is positive when drive is pulling power from the line, and negative when drive is delivering power back to the line.	kW	N
DC BUS VOLTAGE	(DC Bus Voltage) Measured DC Bus voltage as seen by the line side controller.	Volts	N
DC BUS VOLTS REF	(DC Bus Voltage Reference) Calculated applied DC Bus Voltage reference as the peak of the AC line voltage plus the amount to boost. For more information, see Line Side Power Convert A5 Submenu on page 46.	Volts	N
LS OVERLOAD	(Line Side Overload)	%	N
LS INPUT CURRENT	(Line Side Input Current) Measured input line current as the average of the three phases.	Amps	N
LS D AXIS I	(Line Side D Axis Current) Percent of rated current in the D axis. Note: This is reactive power producing current.	%	N
LS Q AXIS I	(Line Side Q Axis Current) Percent of rated current in the Q axis. Note: This is power producing current.	%	N
LS D AXIS VOLTS	(Line Side D Axis Voltage) Percent of rated voltage in the Q axis. Note: This is reactive power producing voltage.	%	N
LS Q AXIS VOLTS	(Line Side Q Axis Voltage) Percent of rated voltage in the Q axis. Note: This is power-producing voltage.	%	N
INPUT HZ	(Input Frequency) Measured input line frequency.	Hz	N
INPUT Vab	(Input Voltage A-B Phase) Measured input line-to-line voltage phase A-B.	Volts	N
INPUT Vca	(Input Voltage C-A Phase) Measured input line-to-line voltage phase C-A.	Volts	N
LS MODULE TEMP	(Line Side Module Temp) Indicates the hottest of the line side converters IGBT modules.	°C	N

Table 15: LS Power Data D2 Submenu

Utility U0 menu

U0	Parameter	Description	Default	Choices	Hidden Item	Run lock out
U1	PASSWORD	For more information, see PASSWORD on page 71.				
	ENTER PASSWORD	Allows the user to enter in a password	012345		N	N
	NEW PASSWORD	Used to change the established password			N	N
	PASSWORD LOCKOUT	Used to enable and disable password lockout	DISABLED	disabled enabled	N	N
U2	HIDDEN ITEMS	For more information, see HIDDEN ITEMS on page 71.				
	HIDDEN ITEMS	Selects if the "hidden" parameters will be displayed on the Digital Operator.	ENABLED	enabled disabled	N	N
U3	UNITS	For more information, see UNITS on page 71.				
	UNITS SELECTION	Choose either Metric units or standard English measurements units	ENGLISH	english metric	N	Y
U4	OVSPEED TEST	For more information, see OVSPEED TEST on page 71.				
	OVSPEED TEST?	Allows for Overspeed Test to be enabled via the digital operator	NO	no yes	N	Y
U5	RESTORE DFLTS	For more information, see RESTORE DFLTS on page 72.				
	RESTORE DRIVE DEFAULTS?	Resets all parameters in the A menu to default values except parameters in MOTOR A6			N	Y
	RESTORE MOTOR DEFAULTS?	Resets the parameters in the MOTOR A6			N	Y
	RESTORE UTILITY DEFAULTS	Resets the parameters in the U menu			N	Y
U6	MS DRIVE INFO	For more information, see MS DRIVE INFO on page 73.				
	MS TYPE			Read Only Data	N	N
	MS CODE VERSION			Read Only Data	N	N
	MS S/W DATE			Read Only Data	N	N
	MS S/W TIME			Read Only Data	N	N
	MS FPGA VERSION			Read Only Data	N	N
	MS CUBE ID			Read Only Data	N	N
U7	LS DRIVE INFO	For more information, see LS DRIVE INFO on page 74.				
	LS TYPE			Read Only Data	N	N
	LS CODE VERSION			Read Only Data	N	N
	LS S/W DATE			Read Only Data	N	N
	LS S/W TIME			Read Only Data	N	N
	LS FPGA VERSION			Read Only Data	N	N
	LS CUBE ID			Read Only Data	N	N
U8	HEX MONITOR	For more information see HEX MONITOR on page 75.				
					N	N

Detailed Description

PASSWORD

(Password Function)

The following three different screens are used by the password function:

- ENTER PASSWORD
- NEW PASSWORD
- PASSWORD LOCKOUT

Password Function

The password function allows the user to select a six-digit number for a password. The password function allows the user to lockout changes to the parameters until a valid password is entered.

And with the password lockout enabled, all parameters and display values will be able to be viewed but no changes to the parameters will be allowed until a correct password is entered.

Parameter Protection

If the password lockout is enabled, the following message will appear on the display when attempting to change a parameter.

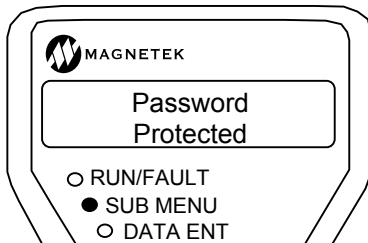

In order to change a parameter after password lockout has been enabled, the following two steps must be followed in the PASSWORD sub-menu:

- 1) A valid password must be entered in the ENTER PASSWORD screen.
- 2) The password lockout must be DISABLED in the PASSWORD LOCKOUT screen.

PASSWORD Sub-menu Protection

The following message will appear when in the PASSWORD sub-menu, if you are trying to:

- Enable or disable the password lockout without a valid password being entered.
- Enter a new password without a valid password being entered.

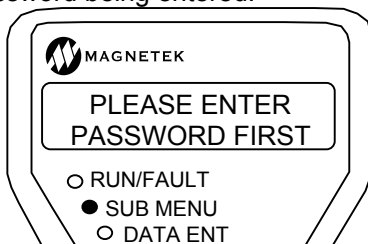

ENTER PASSWORD Screen

This screen allows the user to enter in a password. A valid password must be entered before enabling or disabling the password lockout or changing to a new password.

NEW PASSWORD Screen

This screen is used to change the established password.

NOTE: Remember that a valid password must be entered at the ENTER PASSWORD screen before the established password can be changed.

PASSWORD LOCKOUT Screen

This screen is used to enable and disable password lockout. The factory default for password lockout is DISABLED.

NOTE: Remember that a valid password must be entered at the ENTER PASSWORD screen before the password lockout condition can be changed.

HIDDEN ITEMS

(Hidden Items Function)

The HIDDEN ITEMS sub-menu allows the user to select whether or not "hidden" parameters will be displayed on the Digital Operator. There are two types of parameters, standard and hidden. Standard parameters are available at all times. Hidden parameters are available only if activated. The default for this function is ENABLED (meaning the hidden parameters are visible).

UNITS

(Units Selection Function)

When the UNITS SELECTION sub-menu is displayed, the user can choose either Metric units or Standard English measurements units for use by the drive's parameters.

IMPORTANT

The unit's selection must be made before entering any setting values into the parameters. The user cannot toggle between units after drive has been programmed.

OVERSPEED TEST

(Overspeed Test Function)

The speed command is normally limited by Overspeed Level parameter (OVERSPEED LEVEL(A1)), which is set as a percentage of the contract speed (100% to 150%). But in order to allow overspeed tests during elevator inspections, a means is provided to multiply the speed command by the Overspeed Multiplier parameter (OVERSPEED MULT(A1)).

Quattro DC Utility U0 Menu

An overspeed test can be initiated by:

- an external logic input
- the serial channel
- directly from the digital operator

Overspeed Test via Logic Input

The external logic input can be used by:

- setting the Overspeed Test Source parameter to external tb1.
- defining a logic input terminal to ospd test src

NOTE: This logic input requires a transition from false to true to be recognized - this prevents the overspeed function from being permanently enabled if left in the true state.

Overspeed Test via Serial Channel

The serial channel can be used by setting Overspeed Test Source (C1) parameter to serial.

Overspeed Test via Operator

The Digital Operator can also initiate the overspeed test by performing the following:

- While the Digital Operator display shows

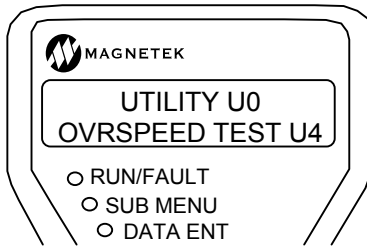

Press the ENTER key. The sub-menu LED will turn on, and the Digital Operator will display:

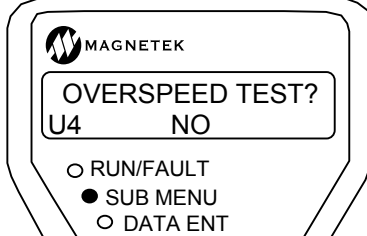

- Press the ENTER key again. The sub menu LED will go out and data ent LED will turn on.
- Press the up arrow or down arrow key and the display will change to:

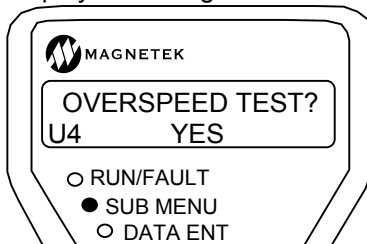

- Press the ENTER key to begin the overspeed test.

The value in the Overspeed Mult (A1) parameter is applied to the speed reference and the overspeed level, so that the elevator can be operated at greater than contract speed and not trip on an Overspeed Fault.

When the Run command is remove after the overspeed test, overspeed test reverts back to its default of NO. In order to run another overspeed test via the Digital Operator, the above steps must be repeated again.

RESTORE DFLT

(Restore Parameter Defaults)

Three different functions are included in this sub-menu.

Restore Drive Defaults

This function resets all parameters to their default values except the parameters in the MOTOR A6 sub-menu.

The following shows how to restore the drive defaults:

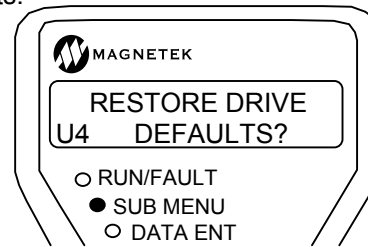

Press the enter key

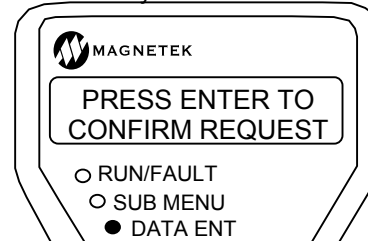

Press the enter key again

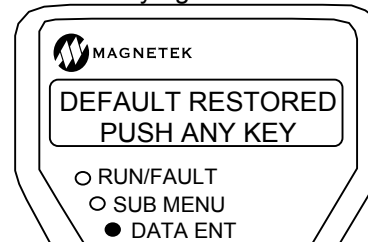

If the esc key is pressed, instead the reset action will be aborted

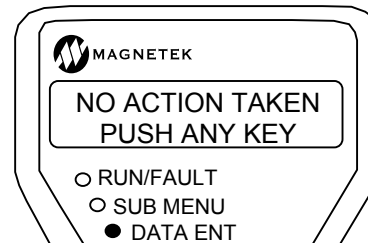

Restore Motor Defaults

This function resets the parameters in the MOTOR A6 sub-menu to the defaults. The following shows how to restore the motor defaults:

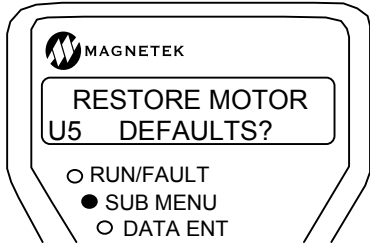

Press the enter key

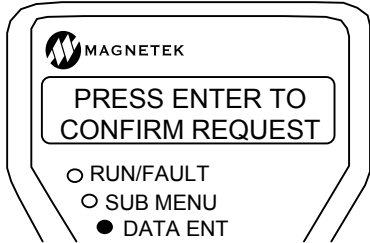

Press the enter key again

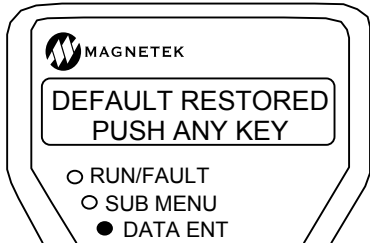

If the esc key is pressed, instead the reset action will be aborted

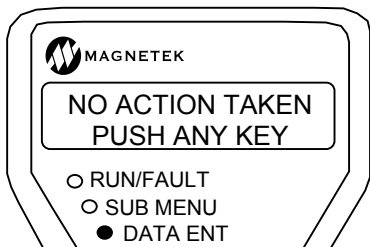

Restore Utility Defaults

This function resets the parameters in the Utility U0 menu to the defaults. The following shows how to restore the utility defaults:

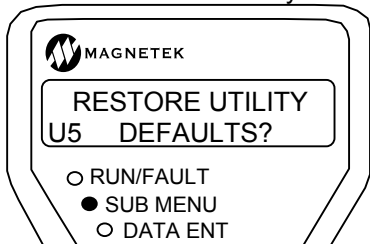

Press the enter key

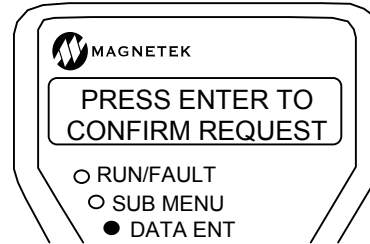

Press the enter key again

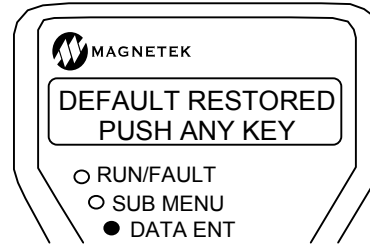

If the esc key is pressed, instead the reset action will be aborted

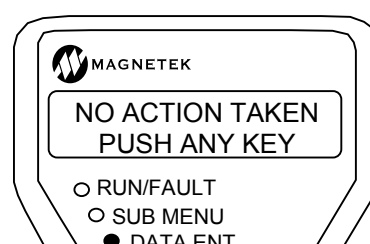

MS DRIVE INFO

(Motor Side Drive Information)

Six different screens are included in this sub-menu, each display an identification number.

MS TYPE Screen

Shows the type of drive the software is installed in:

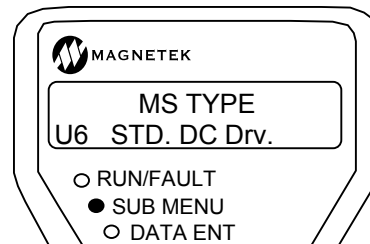

MS CODE VERSION

Shows the version of code located in the Motor Side portion of the drive.

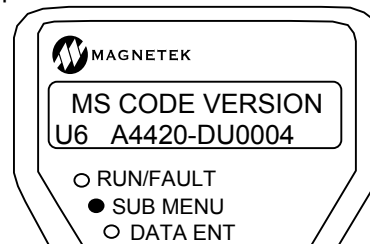

Quattro DC Utility U0 Menu

MS S/W DATE Screen

Gives the date of the released motor side code version.

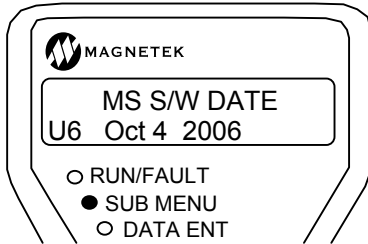

MS S/W TIME Screen

Displays the time of the released motor side code version.

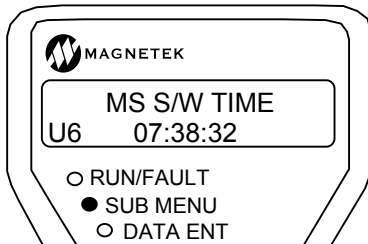

MS FPGA REV Screen

Gives the revision number for the motor side FPGA.

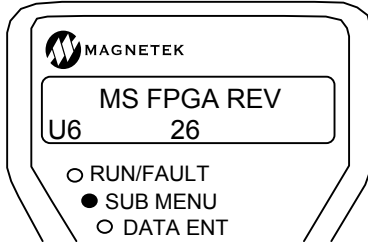

MS CUBE ID Screen

Displays the cube identification number of the drive. This number identifies specific drive ratings related to detected equipment hardware.

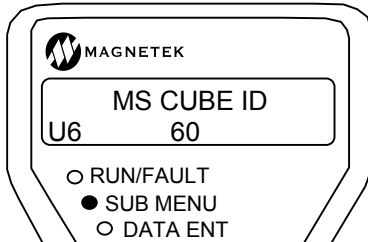

LS DRIVE INFO

(Drive Information)

Six different screens are included in this sub-menu, each display an identification number.

LS TYPE Screen

Shows the type of drive the software is installed in:

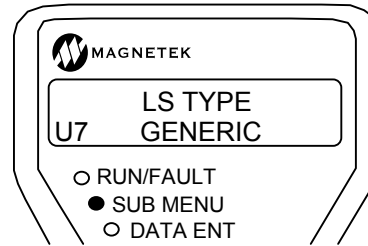

LS CODE VERSION

Shows the version of code located in the Line Side portion of the drive.

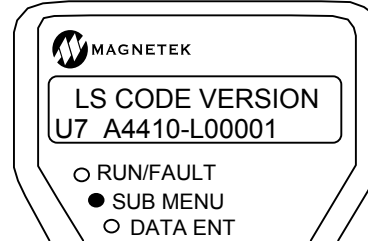

LS S/W DATE Screen

Gives the date of the released Line side code version.

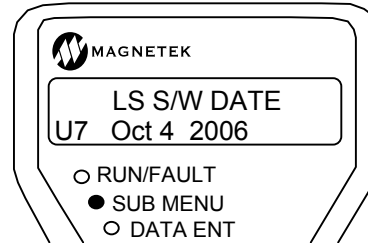

LS S/W TIME Screen

Displays the time of the released Line side code version.

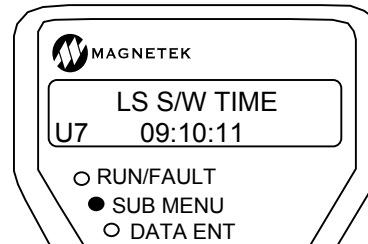

LS FPGA REV Screen

Gives the revision number for the Line side FPGA.

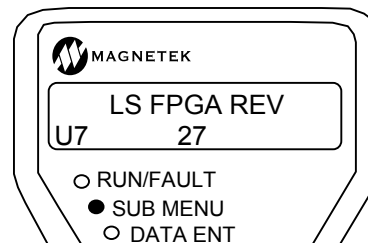

LS CUBE ID Screen

Displays the cube identification number of the drive. This number identifies specific drive ratings related to detected equipment hardware.

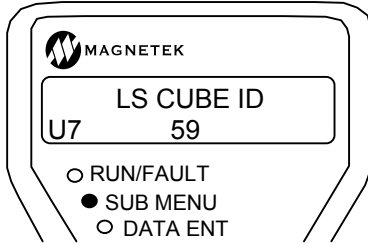

HEX MONITOR

(Hex Monitor)

The hex monitor was designed for fault and parameter diagnostics. It is intended for use by Magnetek personnel only.

Fault F0 menu

The FAULTS F0 menu does not access settable parameters; instead, it provides a means of examining the drive's active faults and the fault history.

This menu also allows for clearing of active faults in order to get the drive ready to return to operation after a fault shutdown.

F0	Parameter	Description	Hidden Item	Run lock out
F1	ACTIVE FAULTS			
	DISPLAY ACTIVE FAULTS?	Contains a list of the active faults	N	N
	RESET ACTIVE FAULTS?	Allows for reset of active faults	N	N
F2	FAULT HISTORY			
	DISPLAY FAULT HISTORY?	Contains a list of up to the last sixteen faults	N	N
	CLEAR FAULT HISTORY?	Allows for the clearing of the fault history and fault counters	N	N
	DISPLAY FAULT COUNTERS?	Contains list of faults and the number of times they occurred	N	N

Detailed Descriptions

ACTIVE FAULTS

(Active Faults)

This sub-menu contains a list of the active faults. This sub-menu also allows the user to reset the active faults.

Active Faults List

The active fault list displays and records the active faults. The faults will remain on the fault list until a fault reset is initiated.

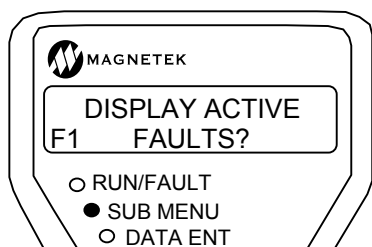

Press the enter key to enter the active fault list. Use the up and down arrow keys to scroll through the active faults.

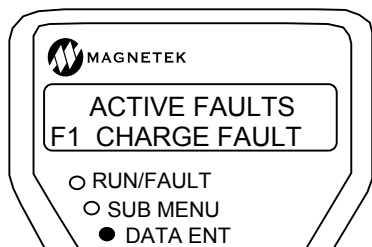

Resetting Active Faults

The Reset Active Faults function allows the user to initiate a fault reset via the digital

operator, regardless of the setting of the Fault Reset Source parameter (see *User Switches C1 submenu on page 50*)

While the Digital Operator display shows:

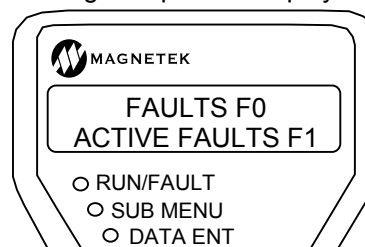

Press the ENTER key. The sub-menu LED will turn ON, and the Digital Operator will display:

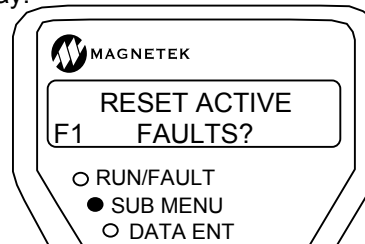

Press the ENTER key again to begin the fault reset procedure. The sub-menu LED will go out and the data ent LED will turn on.

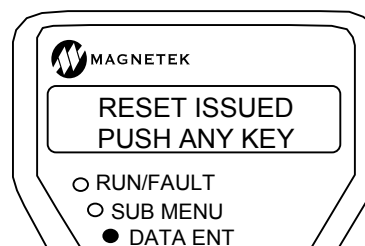

FAULT HISTORY

(Fault History)

This sub-menu contains a list of up to the last sixteen faults.

NOTE: The fault history is not affected by the fault reset or a power loss. The fault history can only be cleared by a function in this sub-menu.

Fault History

All faults are placed in the fault history. The fault history displays the last 16 faults that have occurred and a time stamp indicating when each happened.

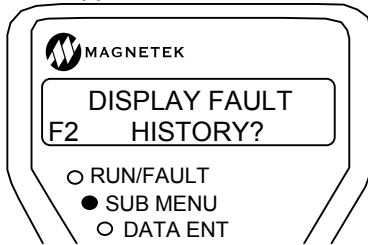

Press the enter key to enter the fault history. Use the up and down arrow keys to scroll through the faults.

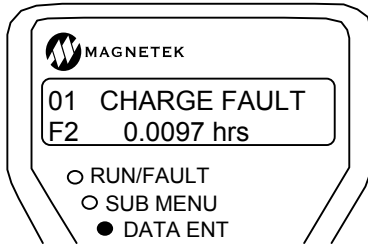

FAULT COUNTERS

(Fault Counters)

This sub-menu contains a list of all the faults and the numbers of times they occurred.

NOTE: The fault counters list is not affected by the fault reset or a power loss. The fault counters can only be cleared by a clear fault history

Fault Counter

All faults possible are located in the Fault Counter. The fault counter shows each fault and the number of times it occurred until cleared by the Clear Fault History function.

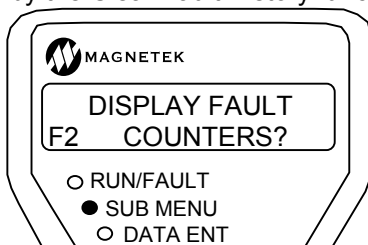

Press the enter key to enter the fault history. Use the up and down arrow keys to scroll through the faults.

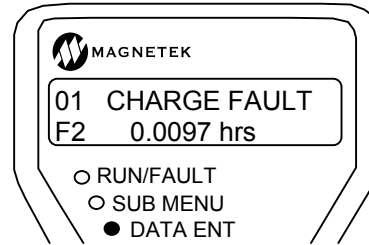

Clearing Fault History

The fault history is not affected by the fault reset or a power loss. The fault history can only be cleared via the user function described below. Clearing the Fault History will also clear the Fault Counters.

Enter the submenu in F2 by pressing the ENTER key. The sub-menu LED will turn ON, and the Digital Operator will display:

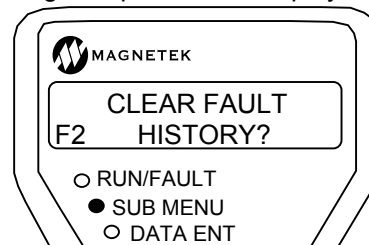

- Press the ENTER key again to begin the fault reset procedure.

The active faults must be cleared in order to clear the fault history. If not the following message will appear when trying to clear the fault history.

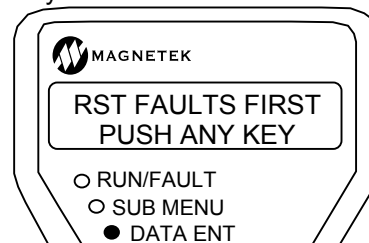

The sub-menu LED will go out and the data ent LED will turn on.

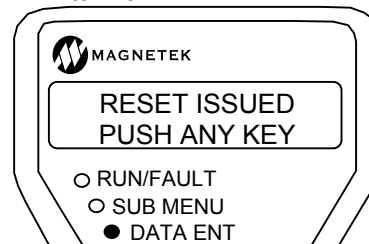

Maintenance

Maintenance Overview

Preventive maintenance is primarily a matter of routine inspection and cleaning. The most important maintenance factors are the following:

Is there sufficient airflow to cool the drive?

Has vibration loosened any connections?

The Drive needs to have sufficient air flow for long, reliable operation. Accumulated dust and dirt accumulation can reduce airflow and cause the heat sinks to overheat. The heat sinks can be kept clean by brushing, while using a vacuum cleaner.

Periodically, check air filters on enclosure doors, clean if dirty and replace as necessary.

Periodically, clean the cooling fans to prevent dirt buildup. At the same time, check that the impellers are free and not binding in the housing.

Periodically, check all mounting and electrical connections. Any loose hardware should be tightened.

WARNING

Hazardous voltages may exist in the drive circuits even with drive circuit breaker in off position. NEVER attempt preventive maintenance unless incoming power and control power is disconnected and locked out. Also, ensure the DC Bus charge light is out.

Drive Servicing

Remember when servicing the Drive: Hazardous voltages may exist in the drive circuits even with drive circuit breaker in off position.

IMPORTANT

Use extreme caution: Do not touch any circuit board, the drive, or motor electrical connections without making sure that the unit is properly grounded and that no high voltage is present.

NEVER attempt maintenance unless the incoming three phase power and control power is disconnected and locked out.

Also, ensure the DC Bus charge light is out, verify with a voltmeter that no voltage exists between the (+) and (-) terminals.

Troubleshooting

Faults and Alarms

Two classes of warnings are reported by the Drive; these are identified as Faults and Alarms.

An **Alarm** is a drive condition worth noting that may or may not require immediate attention, but the condition is not severe enough to stop operating the drive. In many cases, Alarms will automatically clear when the condition returns to normal or when the drive is stopped and restarted.

Faults and Fault Annunciation

A **Fault** is a severe failure condition that will stop a drive if it has been running and prevent the drive from starting as long as it is present. All faults require some type of action by the user to clear.

There are four means of fault annunciation:

1. A priority message will be seen on the Digital Operator:

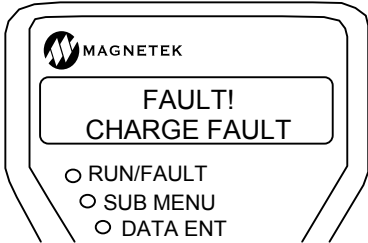

A priority message will overwrite what ever is currently displayed. The user can clear this message by pressing any key on the Digital Operator keypad. If another fault is present, the next fault will appear as a priority message.

NOTE: Clearing the fault priority message from the display DOES NOT clear the fault from the active fault list. The faults must be cleared by a fault reset before the drive will run. Setting PRIORITY MESSAGE (C1) to DISABLE can disable priority Messages.

2. The fault will be placed on the active fault list which will record and display currently active faults. The faults will remain on the fault list until an active fault reset is initiated. The drive will

not be able to run until all active faults are cleared.

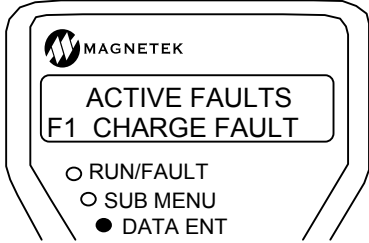

3. The fault will be placed on the fault history. The fault history displays the last 16 faults and a time stamp indicating when each happened. The fault history IS NOT affected by an active fault reset or a power loss. The fault history can be cleared via a user-initiated function.

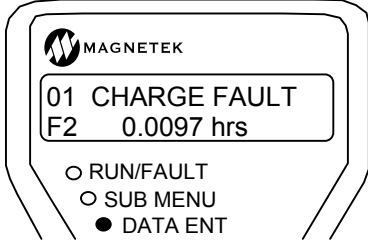

4. The user can assign a fault to an external logic output. Refer to configuration submenu item C3.

Fault Clearing

Performing a fault reset can clear most faults. The fault reset can be initiated by:

- an external logic input
- the serial channel
- automatically by the drive

CAUTION

If the run signal is asserted at the time of a fault reset, the drive could immediately go into a run state. However, if the auto-fault reset function is enabled (FAULT RESET SRC(C1)=automatic) then the run command needs to be cycled.

A fault reset can also be performed manually via the Digital Operator.

Quattro DC Troubleshooting

Drive Faults, Alarms, and operator messages along with possible causes and corrective actions are listed below.

Note:

- **fault** - a severe failure that will stop a drive if it has been running and prevent the drive from starting as long as it is present. All faults require some type of action by the user to clear.
- **alarm** - only meant for annunciation. It will NOT stop the operation of the drive or prevent the drive from operating.
- **operator message** - operator communications message. It will NOT stop the operation of the drive or prevent the drive from operating.

Name	Description	Possible Causes & Corrective Action
A to D Fault	The Analog to Digital conversion on the drive control board is not working properly.	Drive Control PCB Failure ↓ Replace Drive Control board
BAD SRL CHKSM (alarm)	More than two messages with bad checksums have been received over the serial channel.	↓ Electronic noise interference ↓ Verify there is no electronic noise interference Baud rate mismatch ↓ Baud rate mismatch is between drive and car controller. Verify baud rate settings.
Bridge Ground	A ground fault has been detected by the hardware on the motor side. The current going to A1 armature motor lead does not match the current returning from the motor armature lead A2.	Check Motor Wiring ↓ Check motor wiring and motor for insulation breakdown or unintentional contact to other objects ↓ Ensure proper connection of shield drain wires to chassis Bad Current Sensor
Brk Hold Flt	The brake hold command and the brake feedback did not match for the time specified with Brake Hold Time parameter.	Check Parameter Settings ↓ Check the correct logic input is configured for the correct TB1 terminal and set to MECH BRK HOLD (C2) ↓ Check BRAKE HOLD SRC (C1) parameter for the correct source of brake pick feedback ↓ Check BRAKE HOLD TIME (A1) parameter for the correct brake hold time ↓ Wrong assignment of Normally Closed contact mask (C2) ↓ Increase BRAKE HOLD TIME (A1) ↓ Check BRK HOLD FLT ENA (C1) Verify Brake Settings ↓ If drive is controlling brake, verify a logic output is set to BRAKE HOLD (C3) ↓ Check for an open circuit between the brake pick pilot relay and the logic output assigned to brake pick control Mechanical Brake Hold Signal Wiring ↓ Defective Brake Hold Coil ↓ Defective Brake Hold Auxiliary contactor used for sensing the brake state If nuisance fault, the fault can be disabled by BRK HOLD FLT ENA (C1) parameter.

Name	Description	Possible Causes & Corrective Action
Brk Pick Flt	The brake pick command and the brake feedback did not match for the time specified with Brake Pick Time parameter.	<p>Check Parameter Settings</p> <ul style="list-style-type: none"> ⇓ Check the correct logic input is configured for the correct TB1 terminal and set to MECH BRK PICK (C2) ⇓ Check BRAKE PICK SRC (C1) parameter for the correct source of brake pick feedback ⇓ Check BRAKE PICK TIME (A1) parameter for the correct brake hold time ⇓ Wrong assignment of Normally Closed contact mask (C2) ⇓ Increase BRAKE PICK TIME (A1) <p>Verify Brake Settings</p> <ul style="list-style-type: none"> ⇓ If drive is controlling brake, verify a logic output is set to BRAKE PICK (C3) ⇓ Check for an open circuit between the brake pick pilot relay and the logic output assigned to brake pick control <p>Mechanical Brake Pick Signal Wiring</p> <ul style="list-style-type: none"> ⇓ Defective Brake Pick Coil ⇓ Defective Brake Pick Auxiliary contactor used for sensing the brake state <p>If nuisance fault, the fault can be disabled by BRK PICK FLT ENA (C1) parameter.</p>
Check Setup	This fault is logged when a new program is loaded to the motor side processor, and the default data is loaded for the parameter values.	<p>Invalid Parameter Setup</p> <ul style="list-style-type: none"> ⇓ This is an advisory fault indicating that the user should verify the drive's parameters ⇓ Or upload a valid parameter set using Magnetek Explorer
Comm Fault	The drive is being operated by serial communications and one of the following has occurred: Communication time-out – The drive did not receive a valid run-time message in the allowed time while running Bad message checksum – Drive has detected too many consecutive bad message checksums	<p>Bad Serial Connection</p> <ul style="list-style-type: none"> ⇓ Remove and re-seat the RS-422 serial cable ⇓ Check car controller serial driver board ⇓ Check the serial cable connected to the drive's RS-422 port ⇓ The Customer I/O PCB on the drive may need to be replaced.
Comm Fault Invalid Checksum (operator)	The operator received four consecutive invalid messages	<p>Noise or Bad Connector Connection</p> <ul style="list-style-type: none"> ⇓ Remove and re-seat the operator in its cradle ⇓ If re-seating the operator did not work, the operator or the drive's control board may need to be replaced
Comm Fault No Drv Handshake (operator)	The operator lost communications with the drive's control board.	<p>Bad Connector Connection</p> <ul style="list-style-type: none"> ⇓ Remove and re-seat the operator in its cradle ⇓ If re-seating the operator did not work, the operator or the drive's control board may need to be replaced
Connector Off	The power interface board has detected a missing or loose connector on the motor side.	<p>Missing Connector</p> <ul style="list-style-type: none"> ⇓ Verify connectors are connected ⇓ Verify connectors are properly seated

Quattro DC Troubleshooting

Name	Description	Possible Causes & Corrective Action
Cont Pwr Lost	Motor contactor power was removed while the drive was commanding it to be energized.	Improper drive On-Run-Stop sequencing ↓ Verify Safety Chain operation ↓ Verify Safety Chain timing
Contactor Flt	The command to close the contactor and the contactor feedback do not match for the time specified by the Contact Fit Time parameter	Check parameter settings and contactor ↓ Check CONTACT FLT TIME (A1) parameter for the correct contactor fault time. ↓ Verify wiring to logic input 1 (CONTACT CFIRM (C2) is correct ↓ Contactor hardware problem
Cube data Flt	The cube data for the motor side processor is invalid.	Parameters Corrupted ↓ Re-enter parameters and power-cycle ↓ If re-occurs, replace Drive Control board
Cube ID Fault	<i>The cube identification number for the motor side is invalid.</i>	Hardware Problem ↓ Power cycle the drive. ↓ Verify the Cube I.D. is properly connected and fully seated ↓ If re-occurs, replace Drive Control board
Curr Reg Flt	Measured current does not match the command current.	Problem with Motor Contactor ↓ Verify that motor contactor is closing ↓ Verify motor contactor is not opening unexpectedly Faulty current feedback signals ↓ Verify that reported drive current is zero when drive is not operating ↓ Verify connections to current transducers Loss of gate power supply ↓ Verify base block jumper is in place Incorrect DC Bus Voltage reading ↓ Measure the dc bus with a meter ↓ Compare that with the value on the digital operator, DC BUS VOLTAGE (D2) Inaccurate Motor Parameters ↓ Verify motor nameplate values (A6) are entered correctly
DCU Data Flt	The DCU parameters checksum is invalid on the motor side.	Parameters Corrupted ↓ Check & re-enter parameters and power cycle the drive ↓ If re-occurs, replace Drive Control board
Dir Conflict (alarm)	Declared when the speed command is held at zero due conflict with the analog speed command polarity and the run up / run down logic DIR CONFIRM (C1) must be enabled.	Check Parameter Settings ↓ Sensitivity determined by the ZERO SPEED LEVEL (A1) Confirm Speed Command Polarity ↓ Check polarity of the analog speed command on analog channel #1 ↓ Compare that with the RUN UP (positive) and RUN DOWN (negative) logic input status If nuisance, the function can be disabled by DIR CONFIRM (C1) parameter.

Name	Description	Possible Causes & Corrective Action
Drive Ovrload	The drive has exceeded the drive overload curve.	<p>Excessive Field Weakening ↓ Verify Weak Field motor parameter (A5)</p> <p>Accurate Motor Parameters ↓ Verify motor nameplate values are entered correctly</p> <p>Excessive Current Draw ↓ Decrease accel/decel rate ↓ Mechanical brake not releasing properly</p> <p>Motor Problem ↓ Check for motor failure</p> <p>Drive Sizing ↓ Verify drive sizing with motor ampere requirements. May need a larger capacity drive</p>
Encoder Flt	The drive is in a run condition and the encoder is: not functioning or not connected. or phasing direction is not proper with motor rotation.	<p>Encoder Phasing Should Match Motor Rotation ↓ If Reversed Tach Fault is indicated the encoder rotation is backwards ↓ Swap two encoder wires (A and /A)</p> <p>Encoder Power Supply Loss ↓ Check 12 or 5 volt supply on terminal strip</p> <p>Accurate Parameters ↓ Verify motor nameplate values are entered correctly ↓ Verify encoder PPR value is correct ↓ Verify ARMATURE IR DROP (A6) is entered correctly according to the equation found on page 47 ↓ If problem still occurs, increase the value of ARMATURE IR DROP (A6)</p> <p>Response of Speed Regulator ↓ Enter accurate INERTIA (A1) parameter ↓ Increase RESPONSE (A1) parameter</p> <p>Encoder Coupling Sloppy or Broken ↓ Check encoder to motor coupling</p> <p>Excessive Noise on Encoder Lines ↓ Check encoder connections. Separate encoder leads from power wiring (cross power lead at 90°) ↓ Ensure that encoder shaft and frame are electrically isolated from the motor</p> <p>Hardware Problem ↓ Replace customer Interface PCB.</p>
EncoderFault OFF (alarm)	<i>When the Encoder Fault is disabled (ENCODER FAULT (C1) = disabled), the drive will display the warning message "EncoderFault OFF", every time the RUN command is removed.</i>	<p>Check Parameter Settings ↓ Check the setting of parameter ENCODER FAULT (C1)</p>
Extrn Fault 1	User defined external logic fault input <i>...Closure of this contact will cause the drive to declare the fault</i>	<p>Check Parameter Settings and External Fault Signal Wiring ↓ Check the correct logic input is configured for the correct TB1 terminal and set to EXTRN FAULT 1 (C2) ↓ Verify the source of the external fault signal.</p>

Quattro DC Troubleshooting

Name	Description	Possible Causes & Corrective Action
Extrn Fault 2	User defined external logic fault input <i>...Closure of this contact will cause the drive to declare the fault</i>	Check Parameter Settings and External Fault Signal Wiring ⇓ Check the correct logic input is configured for the correct TB1 terminal and set to EXTRN FAULT 2 (C2) ⇓ Verify the source of the external fault signal.
Extrn Fault 3	User defined external logic fault input <i>...Closure of this contact will cause the drive to declare the fault</i>	Check Parameter Settings and External Fault Signal Wiring ⇓ Check the correct logic input is configured for the correct TB1 terminal and set to EXTRN FAULT 3 (C2) ⇓ Verify the source of the external fault signal.
Extrn / Fault 4	User defined external logic fault input <i>...Opening of this contact will cause the drive to declare the fault</i>	Check Parameter Settings and External Fault Signal Wiring ⇓ Check the correct logic input is configured for the correct TB1 terminal and set to EXTRN /FLT 4 (C2) ⇓ Verify the source of the external fault signal.
Field Ground	The hardware has detected a ground fault in the field circuit. The current going into the field coil F1 does not match the current returning from the field coil F2.	Check Motor Field wiring ⇓ Check motor field wiring and motor field for insulation breakdown, unintentional contact to other objects, or shorts ⇓ Ensure proper connection of shield drain wires to chassis Possible bad current sensor
Field I REG	Measured field current does not match commanded field current. OR no data update between processor PCBs.	Check Parameter Settings ⇓ Verify parameter settings for motor field control Check Motor Field Current Sensing ⇓ Verify accuracy of motor field current sensing with a separate DC current ammeter ⇓ Replace Field Control Module if there are significant differences ⇓ If re-occurs or there are not significant differences increase stand-by field current setting to reduce current decay time ⇓ Replace main processor PCBs if data updates to operator do not occur External Relay Timing ⇓ Check for improper external relay timing Check Wiring ⇓ Missing jumper wire at Customer Interface Board PCB, TB2
Field IGBT	A de-saturation condition has been detected on a field power bridge IGBT.	Check motor field and wiring ⇓ Verify motor field and motor wirings are not shorted ⇓ If re-occurs and the motor field and wirings are okay, suspect a defective field module IGBT
Field LOSS	The field voltage has been above 25% of rated and the field current below 2% of rated for 1.5 seconds	Check motor field and wiring ⇓ Verify motor field and motor wirings are not open

Name	Description	Possible Causes & Corrective Action
Field Overcurrent	An over current condition has been detected in the field circuit by the hardware.	Check Parameter Settings ↓ Verify parameter settings for motor field control Check motor field and wiring ↓ Check motor field and wiring for short circuits
Full Fld Time	Drive was commanded to provide Full Field current but not told to Start for longer than the time set in FULL FIELD TIME (A1)	Incorrect Start Timing ↓ Check for proper drive Start sequencing signals ↓ Verify FULL FIELD TIME (A1)
Hit Current Limit (alarm)	The drive is or was being limited by the motor current limit setting. This can limit acceleration rates and cause subsequent velocity tracking errors.	Incorrect Wiring ↓ Verify motor armature circuit wiring ↓ Verify motor field current is correct Drive and/or Motor is Undersized ↓ Verify drive and/or motor sizing. May need a larger capacity Drive and / or motor. Check Parameter Settings ↓ Check the torque limit parameter MTR TORQUE LIMIT (A1) ↓ Check speed regulator parameters RESPONSE and INERTIA (A1) ↓ Alarm sensitivity - TRQ LIM MSG DELAY (A1) parameter determines the amount of time the drive is in torque limit before the alarm message is displayed.
HW/SW Mismatch	Line side software is installed in the motor side control board.	Incorrect Software in Motor Side Board ↓ Replace A2 board with correct software for board location or program correct software into Motor Side Board
Invalid Checksum (operator serial link error)	The operator received four consecutive invalid messages.	Noise or Bad Connector Connection ↓ Remove and re-seat the operator in its cradle. ↓ If re-occurs, the operator or the drive's control board may need to be replaced.
IP Comm	A fault has occurred in the communications channel between the Line side and Motor side processors. This was detected on the motor side.	Communication problem ↓ Reset drive ↓ Verify Line Side software and Motor Side software is compatible. ↓ If re-occurs, replace Main Processor PCBs
Line HI Volts	Line voltage is greater than 552 VAC. (480 x 115%) Monitored via the DC Bus.	Line Voltage is too High ↓ Verify DC Bus is reading voltage correctly ↓ Verify Line voltage is set correctly
LS A to D	The Analog to Digital conversion on the line side control board is not working properly.	Line Side Analog to Digital Conversion incorrect ↓ Replace Line Side Main and Power Interface PCBs
LS AC CNTCR	The main AC power contactor is not following the commanded state within 1 second.	AC Power Contactor Problem ↓ Check for faulty UTM contactor coil or interlocking aux contact blocks on PCM or UTM ↓ Verify that pilot relay K2 on PCB A8 is working properly CAUTION: Do not manually engage the UTM contactor with power applied.

Quattro DC Troubleshooting

Name	Description	Possible Causes & Corrective Action
LS BRDG GND	The hardware has detected a ground fault on the line side power bridge.	IGBT Breakdown ↓ Inspect and measure for physical voltage breakdown damage on IGBTs and DC bus
LS Charge	The DC bus did not charge up within the expected time.	DC Bus did not charge within expected time ↓ Verify that the setting for INPUT L-L VOLTS (A5) is correct ↓ Verify that the PCM contactor is activated during a pre-charge attempt ↓ Verify that pilot relay K1 on PCB A8 is functioning CAUTION: There may be a short circuit on the DC bus. Inspect for physical damage.
LS CHK Setup	This fault is logged when a new program is loaded to the line side processor, and the default data is loaded for the parameter values.	Inconsistent Parameter Settings ↓ Verify Parameters settings in menu A1, A2, A3, A4, and A6 are correct
LS Conn Off	The power interface board has detected a missing or loose connector on the line side.	Missing Connector ↓ Verify connectors are connected ↓ Verify connectors are properly seated
LS Cube Data	The cube data for the line side processor is invalid.	Invalid Cube ID ↓ Verify LS Cube ID is seated correctly and not damaged
LS Cube ID	The generation of this fault is indicative of a bad processor board.	Invalid Cube ID ↓ Indicates a bad processor board
LS Curr Reg	Measured current does not match the command current.	Problem with Motor Contactor ↓ Verify that motor contactor is closing ↓ Verify motor contactor is not opening unexpectedly Faulty current feedback signals ↓ Verify that reported drive current is zero when drive is not operating ↓ Verify connections to current transducers Loss of gate power supply ↓ Check gate power supply Incorrect DC Bus Voltage reading ↓ Measure the dc bus with a meter ↓ Compare that with the value on the digital operator, DC BUS VOLTAGE (D2) Inaccurate Motor Parameters ↓ Verify motor nameplate values (A6) are entered correctly External Relay Timing ↓ Check for improper external relay timing Check Wiring ↓ Missing jumper wire at Customer Interface Board PCB, TB2
LS DCU Data	The DCU parameters checksum is invalid on the line side.	Parameters Corrupted ↓ Check & re-enter Line Side parameters and power cycle the drive

Name	Description	Possible Causes & Corrective Action
LS Hit Current LMT (alarm)	The line side is or was being limited by the motoring current limit or regenerative current limit setting. This can limit current into the dc bus leading to an under-voltage condition, or limit current into the line leading to a bus over-voltage condition.	<p>Improper Line Side Menu Parameters (A5)</p> <ul style="list-style-type: none"> ⇓ Verify and correct all Line side (A5) parameter data <p>Low Line Voltage</p> <ul style="list-style-type: none"> ⇓ Input line voltage is too low causing current to be too high for the operating power level ⇓ Verify INPUT L-L VOLTAGE (A5)
LS HW/SW	Motor side software is installed in the line side control board.	<p>Improper software</p> <ul style="list-style-type: none"> ⇓ Replace Line Side A1 Board with correct software or reprogram Line Side A1 board with correct program
LS IGBT 1,2,3	A de-saturation condition has been detected on the specified line side IGBT module.	<p>Faulty IGBT or momentary short</p> <ul style="list-style-type: none"> ⇓ Recycle Power on Drive
LS IP Comm	A fault has occurred in the communications channel between the Line side and Motor side processors. This was detected on the line side.	<p>Miscommunication problem</p> <ul style="list-style-type: none"> ⇓ Verify proper software installed in Line Side and Motor Side processors ⇓ If re-occurs, replace PCB A2
LS Overcurr	The hardware has detected an over-current condition on the line side power converter.	<p>Overcurrent Problem</p> <ul style="list-style-type: none"> ⇓ Check for a possible short circuit in motor or external power wiring. <p>Poor Regulator Tuning</p> <ul style="list-style-type: none"> ⇓ Check parameters ⇓ Lower value in PLL FILTER Fc (A5) <p>Noise Glitch</p> <ul style="list-style-type: none"> ⇓ Power Cycle drive ⇓ If re-occurs, check wiring for EMC Compliance
LS Overload	An overload condition has been detected on the line side power bridge.	<p>Excessive Field Weakening</p> <ul style="list-style-type: none"> ⇓ Verify Weak Field motor parameter (A5) <p>Accurate Motor Parameters</p> <ul style="list-style-type: none"> ⇓ Verify motor nameplate values are entered correctly <p>Excessive Current Draw</p> <ul style="list-style-type: none"> ⇓ Decrease accel/decel rate ⇓ Mechanical brake not releasing properly <p>Motor Problem</p> <ul style="list-style-type: none"> ⇓ Check for motor failure <p>Drive Sizing</p> <ul style="list-style-type: none"> ⇓ Verify drive sizing with motor ampere requirements. May need a larger capacity drive

Quattro DC Troubleshooting

Name	Description	Possible Causes & Corrective Action
LS Overtemp (fault)	One or more of the IGBT modules on the line side power bridge has exceeded 105°C (221°F).	<p>Overtemperature Problems</p> <ul style="list-style-type: none"> ⇓ Manually verify 3-speed blower has correct operation ⇓ Inspect and clean air intake filters ⇓ Verify ambient temperature is less than 45°C ⇓ Inspect IGBT modules for proper mounting ⇓ Verify drive is sized correctly ⇓ Possible defective temperature sensor <p>Excessive Current Draw</p> <ul style="list-style-type: none"> ⇓ Decrease Accel / Decel rates ⇓ Mechanical brake not releasing properly <p>Excessive Field Weakening</p> <ul style="list-style-type: none"> ⇓ Verify Weak Field Motor Parameters (A5)
LS Over Temp (alarm)	One or more of the IGBT modules on the line side power bridge has exceeded 95°C (203°F).	<p>Overtemperature Problems</p> <ul style="list-style-type: none"> ⇓ Manually verify 3-speed blower has correct operation ⇓ Inspect and clean air intake filters ⇓ Verify ambient temperature is less than 45°C
LS Overvolt	The line side power converter has detected an over-voltage condition.	<p>Low Input Voltage</p> <ul style="list-style-type: none"> ⇓ Check INPUT L-L VOLTS (A5) and UV FAULT LEVEL (A4) ⇓ Verify proper input voltage and increase, if necessary, the input AC voltage within the proper range ⇓ Check for missing input phase ⇓ Check power line disturbances due to starting of other equipment <p>Line Converter Problem</p> <ul style="list-style-type: none"> ⇓ Verify the line converter did not shutdown while the motor controller was in process of regeneration <p>Check Parameter Settings</p> <ul style="list-style-type: none"> ⇓ Bad tuning of either the line side regulators <p>Contactors Problem</p> <ul style="list-style-type: none"> ⇓ Verify motor contactor did not open while motoring

Name	Description	Possible Causes & Corrective Action
LS PCU Data	PCU parameters checksum is invalid on the line side.	Parameters Corrupted ↓ Check & re-enter Line Side parameters and power cycle the drive
LS Phase	The line side converter has detected the loss of one or more phases of the AC line.	Input Line to Line Phase Loss ↓ Verify all 3 AC line phases are correct ↓ Verify wiring to / from contactor UTM ↓ Verify 3 phase signal wiring to PCB A8 ↓ If re-occurs, replace A8
LS Size	The line side power converter has detected that the power bridge and current sensors, do not match.	Hardware Mismatch ↓ Size of the power bridge does not match the rating as defined on the cube ID board. ↓ Check for correct Cube ID board located on A3 board
LS Undr Voltg (alarm)	The DC Bus has fallen below the under voltage alarm level. The alarm level is set by UV Alarm Level parameter.	Low Input Voltage ↓ Check INPUT L-L VOLTS (A5) and UV ALARM LEVEL (A4) ↓ Verify proper input voltage and increase, if necessary, the input AC voltage within the proper range ↓ Check for missing input phase ↓ Check power line disturbances due to starting of other equipment Drive Accurately Reading the DC Bus ↓ Measure the DC bus with a meter ↓ Compare that with the value on the digital operator, BUS VOLTAGE (D2) Poor Tuning of Line Side Parameters ↓ Verify Parameters Line Converter Problem ↓ Verify the line converter did not shutdown while the motor controller was in process of regeneration
LS Undrvolt (fault)	The DC Bus has fallen below the under voltage fault level. The fault level is set by UV FAULT Level parameter.	Low Input Voltage ↓ Check INPUT L-L VOLTS (A5) and UV FAULT LEVEL (A4) ↓ Verify proper input voltage and increase, if necessary, the input AC voltage within the proper range ↓ Check for missing input phase ↓ Check power line disturbances due to starting of other equipment Drive Accurately Reading the DC Bus ↓ Measure the DC bus with a meter ↓ Compare that with the value on the digital operator, BUS VOLTAGE (D2) Poor Tuning of Line Side Parameters ↓ Verify Parameters Line Converter Problem ↓ Verify the line converter did not shutdown while the motor controller was in process of regeneration

Quattro DC Troubleshooting

Name	Description	Possible Causes & Corrective Action
ME Cont Pwr	Motor contactor power was removed while the drive was commanding it to be energized.	Contactors Problem ↓ Check motor contactor power
ME Pwr Avail	Motor contactor power was not available when the drive was commanded to start.	Contactors Problem ↓ Check motor contactor power
Module x IGBT	A de-saturation condition has been detected on the specified motor side IGBT module.	Incorrect Parameter Settings ↓ Check RATED MOTOR CURR (A6), ARMATURE VOLTS (A6), FULL FLD AMPS (A6), WEAK FLD AMPS (A6), and FLUX CONFIRM LEVEL Motor Problem ↓ Check motor armature and wiring for short circuits
Monitor Rev	The revision level of the monitor data structure shared between the line and motor side processors does not match.	Software Problem ↓ Re-load proper software into both processors
MS Size	The motor side power converter has detected that the power bridge and current sensors, do not match.	Hardware Mismatch ↓ Size of the power bridge does not match the rating as defined on the cube ID board. ↓ Check for correct Cube ID board located on A4 board
MTR Data Fit	Motor parameters checksum is invalid.	Parameters Corrupted ↓ Check & re-enter Motor Side (A4) parameters and power cycle the drive ↓ If re-occurs, replace Drive Control board A2
Mtr Overload (alarm)	The motor had exceeded the user defined motor overload curve.	Verify Overload Curve Parameters ↓ Check both OVLD START LEVEL (A5) and OVLD TIME OUT (A5) parameters. Excessive Field Weakening ↓ Verify that FULL FLD AMPS (A5) and WAEK FLD AMPS (A5) are set correctly so that motor can produce rated torque ↓ Verify that motor armature voltage is correct for applied speed and load Accurate Motor Parameters ↓ Verify motor nameplate values are entered correctly Excessive Current Draw ↓ Decrease accel/decel rate ↓ Verify elevator counterweights ↓ Verify mechanical release of elevator brake Motor Problem ↓ Check for motor failure ↓ Check for faulty motor wiring
No Drv Handshake (operator serial link error)	The operator lost communications with the drive's control board.	Bad Connector Connection ↓ Remove and re-seat the operator in its cradle. ↓ If re-occurs, the operator or the drive's control board may need to be replaced.

Name	Description	Possible Causes & Corrective Action
No Field Cable	A disconnected field cable has been detected.	Missing Cable ↓ Check for defective or missing field cable
Open Armature	Armature current reference has remained above 10% of rated, but the armature current has remained below 2% of rated for 1 second.	Contactors Problem ↓ Verify correct operation of power poles on motor armature contactor Motor Problem ↓ Verify motor is wired correctly ↓ This fault could indicate an open armature in motor ↓ This fault could also indicate a brush problem in the motor
Overcurr Flt	An IGBT power module is sensing an over-current or over-temperature condition	Overcurrent Problem ↓ Check for a possible short circuit in motor or external power wiring. Poor Regulator Tuning ↓ Check parameters Noise Glitch
Overspeed Flt	Generated when the motor has gone beyond the user defined percentage contract speed for a specified amount of time.	Check Parameter Settings ↓ Check OVERSPEED LEVEL (A1) parameter for the correct level. ↓ Check OVERSPEED TIME (A1) parameter for the correct time. Poor Regulator Tuning ↓ Check Parameters for speed regulator tuning Speed Request ↓ Excessive speed dictation signal from car controller ↓ Improper feed forward signal ↓ Note: This fault is defined by Overspeed Level parameter and Overspeed Time parameter.
Overtemp Flt	One or more of the IGBT modules on the drive side power bridge has exceeded 105°C (221°F).	Overtemperature Problems ↓ Manually verify 3-speed blower has correct operation ↓ Inspect and clean air intake filters ↓ Verify ambient temperature is less than 45°C ↓ Inspect IGBT modules for proper mounting ↓ Verify drive is sized correctly ↓ Possible defective temperature sensor Excessive Current Draw ↓ Decrease Accel / Decel rates ↓ Mechanical brake not releasing properly Excessive Field Weakening ↓ Verify Weak Field Motor Parameters (A5)

Quattro DC Troubleshooting

Name	Description	Possible Causes & Corrective Action
Overvolt Flt	The DC bus voltage has exceeded the maximum allowed value.	<p>Low Input Voltage</p> <ul style="list-style-type: none"> ⇓ Check INPUT L-L VOLTS (A5) and UV FAULT LEVEL (A4) ⇓ Verify proper input voltage and increase, if necessary, the input AC voltage within the proper range ⇓ Check for missing input phase ⇓ Check power line disturbances due to starting of other equipment <p>Line Converter Problem</p> <ul style="list-style-type: none"> ⇓ Verify the line converter did not shutdown while the motor controller was in process of regeneration <p>Check Parameter Settings</p> <ul style="list-style-type: none"> ⇓ Bad tuning of either the motor side regulators <p>Contactors Problem</p> <ul style="list-style-type: none"> ⇓ Verify motor contactor did not open while motoring
Ovrtemp Alarm (alarm)	One or more of the IGBT modules on the drive side power bridge has exceeded 95°C (203°F).	<p>Excessive Heat</p> <ul style="list-style-type: none"> ⇓ Reduce Ambient Temperature ⇓ Clean heat sink ⇓ Check for cooling fan failure
Param rev	The revision level for parameter data shared between the line side and motor side processors does not match.	<p>Software Incompatibility</p> <ul style="list-style-type: none"> ⇓ Contact Factory
PCU data Flt	PCU parameters checksum is invalid on the motor side.	<p>Parameters Corrupted</p> <ul style="list-style-type: none"> ⇓ Check parameters and power cycle ⇓ If re-occurs, replace Main Control PCB A2
Ready, Waiting For Drive (operator)	The operator is waiting to establish communications with the drive's control board.	<p>Normal, if displayed momentarily</p> <ul style="list-style-type: none"> ⇓ No action is required, if the message disappears shortly after power-up of the operator <p>Bad Connector Connection</p> <ul style="list-style-type: none"> ⇓ Remove and re-seat the operator in its cradle ⇓ If re-seating of the operator does not work, the operator may need to be replaced
Reverse Tach	See ENCODER FLT	See ENCODER FLT
S-Chain Event (alarm)	Elevator Safety Chain opened while the drive was running.	<p>Safety Chain Problem</p> <ul style="list-style-type: none"> ⇓ Safety Chain was opened during a run ⇓ Verify correct Safety-Chain operation and timing
Setup Fault 4	<p>This fault is declared if the contract motor speed (in rpm) and encoder pulses/revolution do not satisfy:</p> $300,000 \left(\begin{matrix} \text{contract} \\ \text{motor} \\ \text{speed} \end{matrix} \right) \left(\begin{matrix} \text{encoder} \\ \text{pulses} \end{matrix} \right) < 18,000,000$	<p>Check Parameters Settings:</p> <ul style="list-style-type: none"> ⇓ Check ENCODER PULSES (A1) parameter for correct setting ⇓ Check CONTRACT MTR SPD (A1) parameter for correct setting

Name	Description	Possible Causes & Corrective Action
Setup Fault 6	This fault is declared if the multi-step speed references have exceeded a defined limit, which is defined in terms of a percentage of contract speed (CONTRACT CAR SPD parameter).	Check Parameters Settings ↓ Check SPEED COMMAND1-16 (A3) parameters, if greater than 110% of CONTRACT CAR SPD (A1) parameter
Setup Fault 7	This fault is declared if the run logic inputs are defined incorrectly. You can either choose group #1 (RUN and UP/DWN) or group #2 (RUN UP and RUN DOWN). But you cannot mix and match or this fault will be declared.	Check Parameters Settings ↓ Check configurations of logic inputs (C2) – either RUN & UP/DWN or RUN UP & RUN DOWN
Setup Fault 8	This fault is declared if the DIR CONFIRM (C1) parameter is enabled and any of the following conditions are not met: A logic input (C2) must be assigned to RUN UP. A logic input (C2) must be assigned to RUN DOWN. The SPD COMMAND SRC (C1) parameter must be set to ANALOG INPUT <i>... Confirms proper set-up of Analog Speed Command direction confirm function</i>	Check Parameters Settings: ↓ Check configurations of logic inputs (C2) for two logic input defined as RUN UP & RUN DOWN ↓ Verify SPD COMMAND SRC (C1) is set to ANALOG INPUT ↓ If nuisance fault and not using Up-Down Confirm, function disabled by setting the DIR CONFIRM (C1) parameter to DISABLED
Speed Dev (alarm)	The speed feedback is failing to properly track the speed reference. Sensitivity determined by SPD DEV HI LEVEL (A1) parameter.	Any active faults? ↓ Check if any active faults in F1 sub-menu Check Parameters Settings: ↓ Verify SPD DEV HI LEVEL (A1) is set to the proper level. Does “Hit CURRENT Limit” message appear? ↓ If message appears during running, verify a fault has not occurred. ↓ Then, increase the torque limit parameters MTR TORQUE LIMIT and REGEN TORQ LIMIT (A1) – maximum 250%
SRL TIMEOUT (alarm)	A timeout condition has occurred on the serial communications channel between the car controller and the drive.	Serial Timeout ↓ Verify serial cable connections ↓ Verify proper operation of car controller communications

Quattro DC Troubleshooting

Name	Description	Possible Causes & Corrective Action
Undervolt Flt	Generated during a run condition when the DC bus voltage drops below the user specified percent of the DC link voltage. The fault level is specified by the UV Fault Level parameter.	<p>Low Input Voltage</p> <ul style="list-style-type: none"> ⇓ Check INPUT L-L VOLTS (A5) and UV FAULT LEVEL (A4) ⇓ Verify proper input voltage and increase, if necessary, the input AC voltage within the proper range ⇓ Check for missing input phase ⇓ Check power line disturbances due to starting of other equipment <p>Drive Accurately Reading the DC Bus</p> <ul style="list-style-type: none"> ⇓ Measure the DC bus with a meter ⇓ Compare that with the value on the digital operator, BUS VOLTAGE (D2) <p>Poor Tuning of Line Side Parameters</p> <ul style="list-style-type: none"> ⇓ Check DC BUS REG P GN (A5), DC BUS REG I GN (A5), DC BUS V BOOST (A5), and BUS VREF SOURCE (A5) <p>Line Converter Problem</p> <ul style="list-style-type: none"> ⇓ Verify the line converter did not shutdown while the motor controller was in process of regeneration
UV Alarm (alarm)	Generated during a run condition when the DC bus voltage drops below the user specified percent of the dc link voltage. The fault level is specified by the UV Alarm Level parameter.	<p>Low Input Voltage</p> <ul style="list-style-type: none"> ⇓ Check INPUT L-L VOLTS (A5) and UV ALARM LEVEL (A4) ⇓ Verify proper input voltage and increase, if necessary, the input AC voltage within the proper range ⇓ Check for missing input phase ⇓ Check power line disturbances due to starting of other equipment <p>Drive Accurately Reading the DC Bus</p> <ul style="list-style-type: none"> ⇓ Measure the DC bus with a meter ⇓ Compare that with the value on the digital operator, BUS VOLTAGE (D2) <p>Poor Tuning of Line Side Parameters</p> <ul style="list-style-type: none"> ⇓ Check DC BUS REG P GN (A5), DC BUS REG I GN (A5), DC BUS V BOOST (A5), and BUS VREF SOURCE (A5)

Table 16: Troubleshooting Guide

Appendix

Auto Tune Procedure

The following details the procedure on how to run auto tune on a Quattro DC drive. The purpose of auto tune allows the drive to calculate the following motor parameters:

- Armature Inductance
- Armature Resistance
- Field Resistance
- Field Time Constant
- Armature Resistance Voltage Drop at Motor Rated Current
- Armature Regulation Gains
- Field Regulation Gains

IMPORTANT: Brake must be set while auto tune is running for valid data.

To run Auto tune by use of the operator, use the AUTO TUNE MOTOR in the A4 menu. The Operator will display:

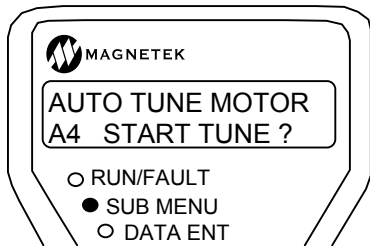

Press the “enter” key. If there are any active faults on the drive, “Not Available at This Time” will display and Auto Tune will not run:

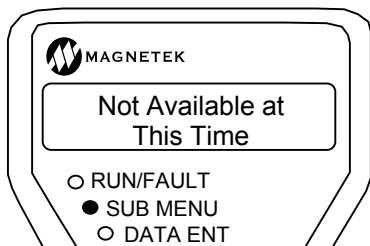

If there are no faults present, the drive will display:

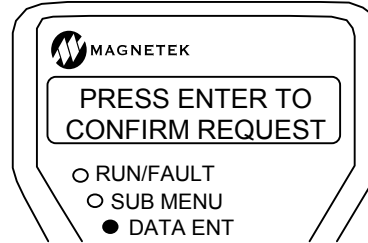

Press “enter” to start. Operator will display:

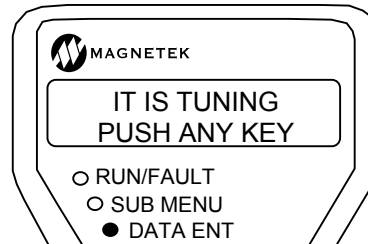

The run light will turn on while current is flowing into the motor. After Auto tune is finished, the operator will display:

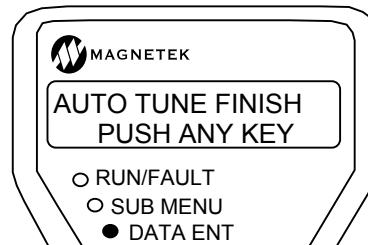

Quattro DC will not use the values measured or calculated by auto tune unless GAIN SELECTION (A4) is set to Auto tune. There are two parameters located in A4 that set the bandwidth for the Armature Regulation gain and the Field Regulation gain. GAIN BANDWIDTH A (A4) determines the bandwidth used in the calculation of the Armature Regulation Gains. Similarly, GAIN BANDWIDTH F (A4) determines the bandwidth used in the calculation of the Field Regulation Gains.

Appendix

Inertia Calculation

The Quattro DC software can be used to calculate the inertia of the entire elevator, which is used for accurate tuning of the speed regulator.

The following is a step-by-step procedure for using the Quattro DC to estimate the elevator system inertia.

Using the Software to Estimate the System's Inertia

With a balanced car, run the car at 100% contract speed from top floor to the bottom floor then back to the top floor.

Observe the EST INERTIA under DISPLAY MENU - ELEVATOR DATA D1 for both the down and up direction.

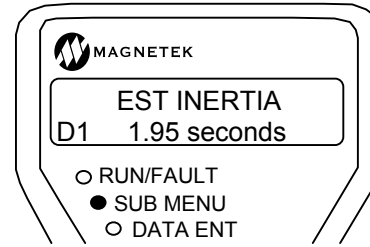

- Average the two values and enter the DRIVE A1 parameter.

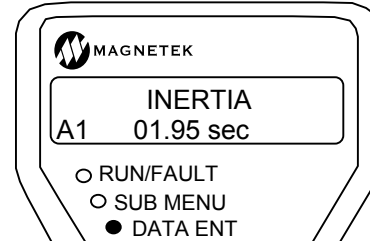

Appendix

EMC Compliance

The Quattro DC drive requires EMC Compliance (EN12015 and EN12016) to function at the highest performance level possible. The following pages will provide the user with an installation guideline for field personnel regarding proper metallic bonding for EMC compliance. All necessary metallic bonding within the Quattro cabinet will be performed at the factory.

In order to be compliant with conducted and radiated emissions standards, it is critical that the motor leads are coupled correctly to the chassis of the Quattro product. Ensuring proper connections through the conduit plate does this. The conduit plate is located on the upper right hand corner of the cabinet.

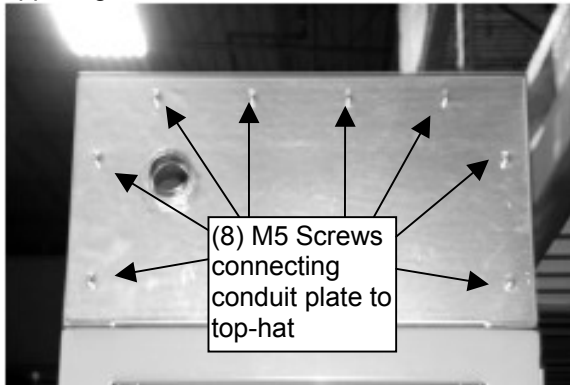

Figure 15: External view of Conduit Plate

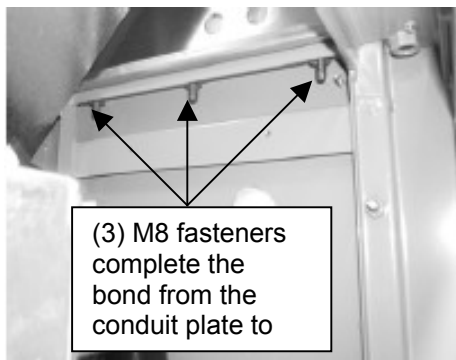

Figure 16: Internal view of Conduit Plate

Proper bonding on motor wiring can be achieved by using one of the following two methods:

Method 1:

1. Use rigid conduit combined with appropriate conduit couplings for an acceptable metallic bond to the conduit plate. Note: The conduit can only contain the armature and field lines. No communication or encoder feedback wires can be run through this conduit.
2. Verify the M5 screws, as seen in Figure 15, are tight and securing the conduit plate to the top-hat
3. Verify the M8 screws, as seen in Figure 16 are properly connected and secure.

Method 2:

1. Use braided, shielded leads for the DC armature and for the motor field connections. Note: When shielded multi-conductor wire is used, it is very important to use termination couplings that are designed for this type of installation. These couplings are designed to make a bond to the braid, which will complete the metallic connection to the chassis.
2. Verify the M5 screws, as seen in Figure 15, are tight and securing the conduit plate to the top hat.
3. Verify the M8 screws, as seen in Figure 16 are properly connected and secure.

Proper bonding on encoder cables and communication wiring may be seen in Figure 17. All shielded multi-conductor cables used for communications or for the encoder feedback must be the braided type.

There are several places along the edge of the lower part on the card cage near the customer I/O board to mount a braided clamp.

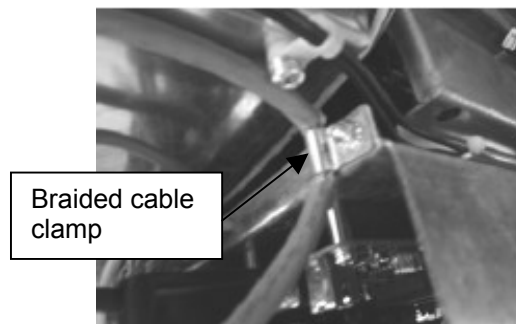

Figure 17: Clamp Connectors for Encoder Shielding

Appendix

Re-Assembly Procedure for 200A / 250A drives

The followings tools are required to properly reconnect the two cabinets:

- Socket wrench and ratchet with 150mm (6.0") extension
- 10mm hex socket
- #2 Phillips screwdriver, 50mm (2.0") shaft
- #2 Phillips screwdriver, 180mm (7.0") shaft
- Flat screwdriver, 3mm x 100mm (1/8" x 4")
- 8mm (5/16") Allen hex key, any length
- 1/2" Allen hex key, any length
- 13mm open / box end wrench

The following details the connection procedure:

1. The U-Channels, as seen in Figure 18, are factory bolted onto the Line Side Converter. Verify the U-Channels are torqued between 1.81-2.26 N-m (16-20 in-lbs) on the Line Side Enclosure

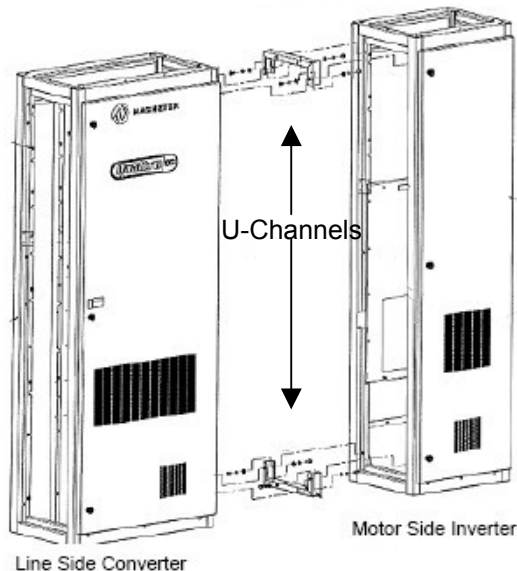

Figure 18: Enclosure Connections

Push cabinets tightly together as seen in Figure 9. The U-channels will lock into place on the Motor Side Enclosure. Once the cabinets are tightly together and placed correctly, secure the U-channel onto the Motor Side Enclosure using the provided four (4) M8 bolts with split lock washers. Use an open or box end 13mm wrench to torque the four (4) hex cap screws to 1.81-2.26 N-m (16-20 in-lbs).

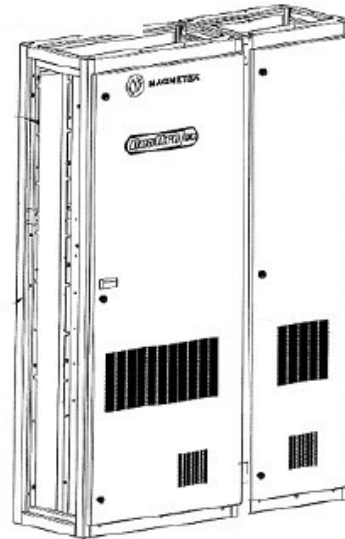

Figure 19: Enclosures Together

2. Next, install the braided electrical ground plate between the two cabinets. The Line Side Converter comes pre-wired with the ground plate pre-attached. See Figure 20 for details on where the ground plates are located. Attach the ground plate to the Motor Side Inverter using the provided four (4) M5 x 9.5mm screws. Use a 8mm hex socket with extension, or #2 Phillips screwdriver with 50-180mm (2-7") shaft. Torque these connections to 4.75-5.20 N-m (42-46 in-lbs).

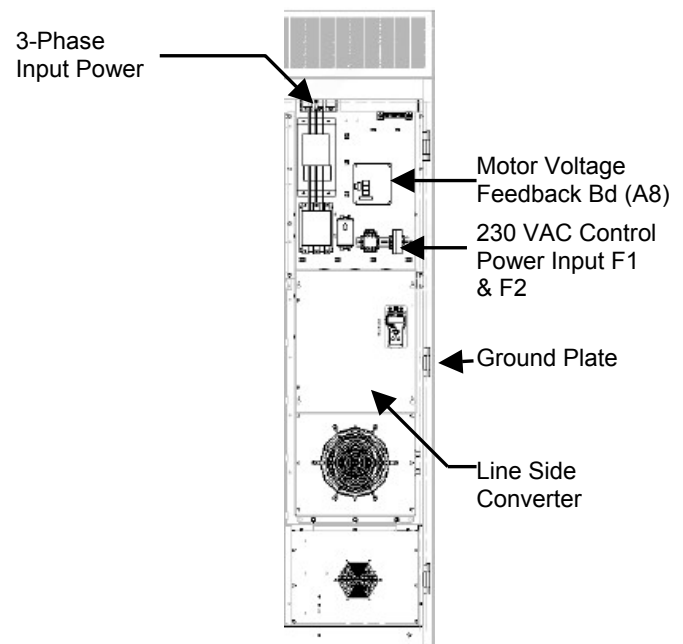

Figure 20: Line Side Module Position

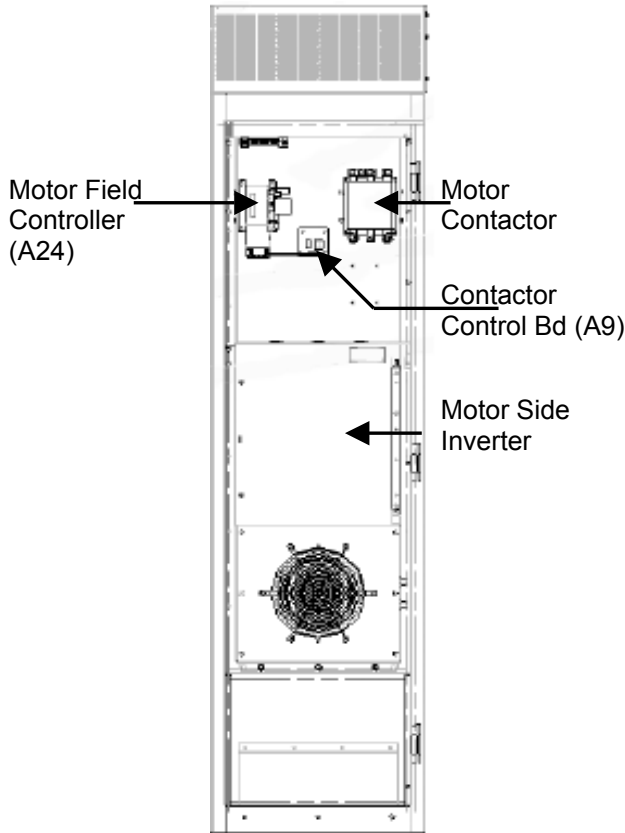

Figure 21: Motor Side Module Position

3. Make the following electrical connections from the DC Bus Board in the Line Side Converter enclosure flowing straight across to the PWM DC Bus Board in the Motor Side Inverter enclosure. See Figure 22 for more information.

Use a 10mm hex socket with extension to connect a M6 nut, lock washer, and flat washer torqued to 7.9 N-m (70 in-lbs).

The connections are as follows:

Wire Number	From DC Bus Board	To PWM DC Bus Board	Reference Name
80	A17-E16	A18-E22	+Bus
80A	A17-E15	A18-E21	+Bus
81	A17-E18	A18-E24	-Bus
81A	A17-E17	A18-E23	-Bus
82	A17-E13	A18-E19	Neutral

Table 17: DC Bus Connections



Figure 22: DC Bus Connections

4. Next, connect the wire harness JCC1 coiled up on the right side of the Line Side Converter to the Contactor Control Board (A9). Dress and secure all cables.

Connect wire A9/TB1/1 to A9-TB1 pin 1 and A9/TB1/4 to A9-TB1 pin 4 of the Contactor Control Board (A9) in the Motor Side Inverter. Use a 1/8" x 4" flat screwdriver for the TB1 terminals. Torque to 0.23-0.28 N-m (2-2.5 in-lbs).

See Figure 23 for reference.

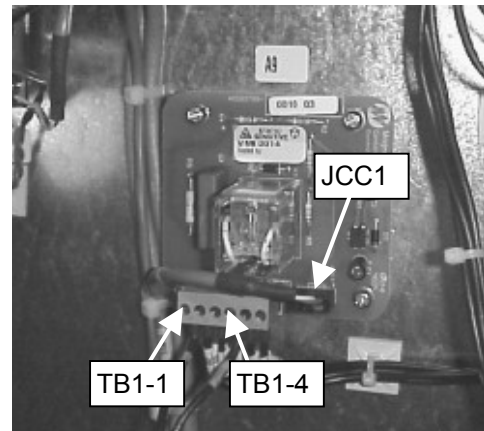

Figure 23: Contactor Control Board (A9)

5. Next, connect the wire harness A24J1 coiled up on the right side of the Line Side Converter to J1 on the Field Control Module (A24) and A24J3 coiled up on the right side of the Line Side Converter to J3 on the Field Control Module (A24). J1 and J3 are located on the bottom right hand corner of the Field Supply Board. Dress and secure all cables.

Connect appropriately sized wires for the intended motor field current directly to the

Appendix – Re-Assembly Procedure

PCB power terminals at the Field Control Module (A24).

The positive voltage for F1 is located on A24-TB1-2 (labeled SW OUT). The negative voltage for F2 is located on A24-TB1-3 (labeled DC- OUT). Use a #2 Phillips screwdriver with 50mm (2") shaft to tighten connections to 2.0 N-m (17.5 in-lbs).

See Figure 24 for reference.

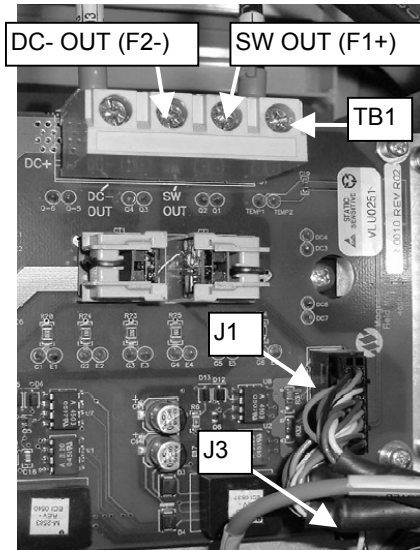

Figure 24: Motor Field Supply (A24)

- Next, connect the Gate Driver Interface Cables to the Dual Gate Driver PCB on the Motor Side Inverter enclosure.

Connect the cable labeled JG1 to the plug labeled JG1 on the Dual Gate Driver PCB.

Connect the cable labeled JG2 to the plug labeled JG2 on the Dual Gate Driver PCB.

Connect the cable labeled JG3 to the plug labeled JG3 on the Dual Gate Driver PCB.

Connect the cable labeled JG4 to the plug labeled JG4 on the Dual Gate Driver PCB.

Connect the cable labeled CT5 to the respective plug labeled CT5 located above the Dual Gate Driver PCB.

In Addition, connect the cable labeled CT6 to the respective plug labeled CT6 located above the Dual Gate Driver PCB.

See Figure 25 for reference.

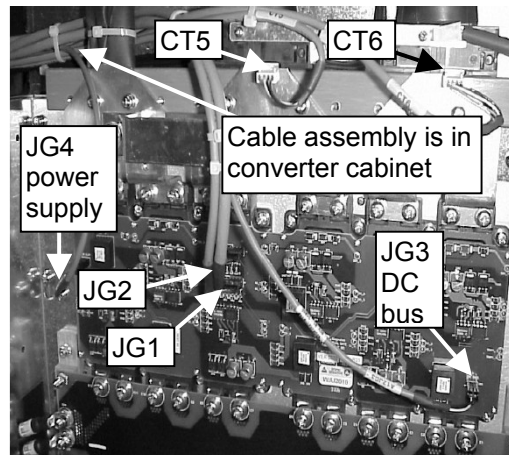

Figure 25: Dual Gate Drive PCB

- Connect the interface cable labeled J5A coiled-up on the Line Side Converter to the corresponding connector J5 in the Motor Side Inverter enclosure. Figure 26 indicates proximity to the cabinet blower.

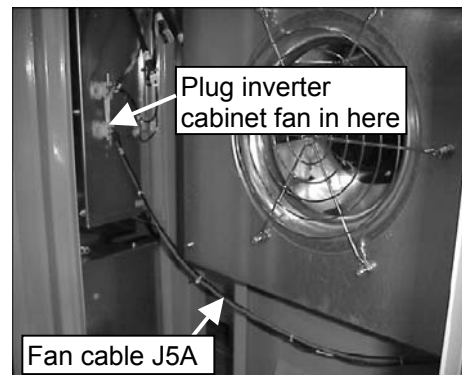

Figure 26: Cooling Blower Control

- Next, connect the wires for the Motor Voltage Feedback. The cables wires are coiled-up in the Motor Side Inverter enclosure. Dress and secure the cable from the Motor Side Inverter to the Line Control and Voltage Feedback PCB (A8) in the Line Side Converter enclosure. See Figure 20 for location of PCB A8. Connect the wires by the following table torqued to 0.23-0.28 N-m (2-2.5 in-lbs). For location of connections, refer to Figure 27.

Wire Number	A8 connections
19	TB2-1
16	TB2-2
25	TB2-3
26	TB2-4

Appendix – Re-Assembly Procedure

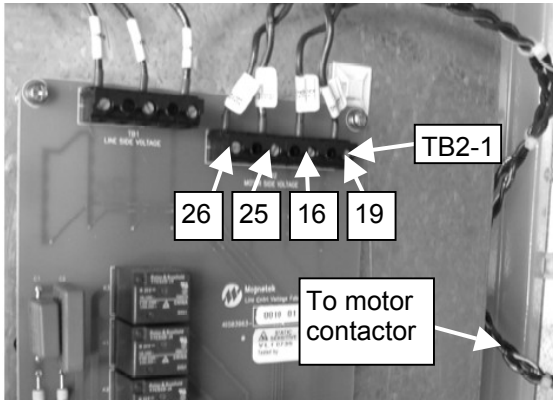

Figure 27: Motor Contactor Connections

- Using a flat screwdriver, 3mmx100mm (1/8"x4"), torque the following auxiliary terminals to 2.0 N-m (17.5 in-lbs) on the right side of the motor contactor. See Figure 28 for location of auxiliaries.

Wire Number	Auxiliary Connection
AJ9CC1-2	31
AJ9CC1-4	32

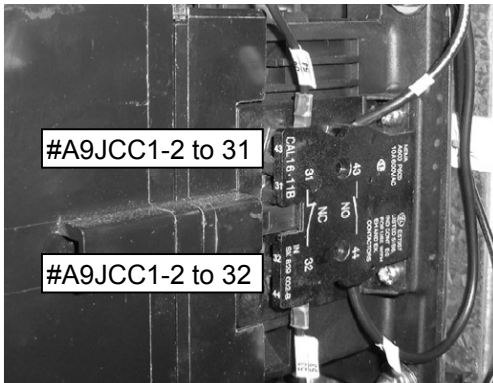

Figure 28: Right side of Motor Contactor

- For Motor Armature Connections, place rubber boots over wires first, then connect those appropriately sized wires from the motor armature directly to the motor contactor (ME) compression lug terminals (1) and (3). Also connect a properly sized frame to t ground continuity wire from the motor he PE grounding terminal on the

Motor Side drive panel. See EMC Compliance on page 97.

Torque the motor terminals and ground terminals to 31.0 N-m (275 in-lbs) using a 8mm (5/16") Allen hex key.

Tie wrap the two rubber boots to the output terminal blocks A1 and A2 after wiring the motor armature.

- Finally, connect the incoming 3-phase power wires and PE building ground to the main power terminals at the top of the Line Side Converter enclosure. View Figure 29 for locations of terminals.

Use the following torque specs when tighten the screws and lugs down:

Wire References	Torque Specs
Power Terminals	56.6 N-m (500 in-lbs)
Plastic Cover Screws	0.23-0.28 N-m (2-2.5 in-lbs)
Ground Terminals	31.0 N-m (275 in-lbs)

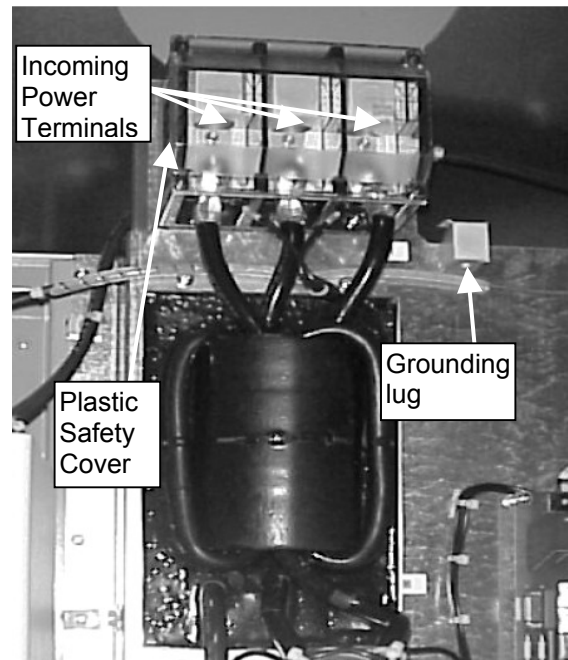

Figure 29: Power Terminals

Appendix

Control Power Consumption

Drive Model Number	Control Power (230VAC) consumption (max)*		
	kVA	Watts	Current (Amps)
QDC125-xxxx-xxx	0.800	700	3.5
QDC200-xxxx-xxx	1.250	1100	5.4
QDC250-xxxx-xxx	1.250	1100	5.4

*Note: Does not include the Elevator Brake

Watts Loss

Drive Model Number	Total System Power Loss (max)**	
	Watts	BTU
QDC125-xxxx-xxx	2150	7342
QDC200-xxxx-xxx	3350	11440
QDC250-xxxx-xxx	3550	12123

**Note: Includes both Control Power and 3-Phase Input Power Consumption

Input / Output Ratings

Drive Model Number	Input		Output (rated max)		
	Voltage (V)	Current (A)	Voltage (V)	Current (A)	Power (HP)
QDC125-xxxx-xxx	200 – 480	80	50 – 550	125	92
QDC200-xxxx-xxx	200 – 480	130	50 – 550	200	147
QDC250-xxxx-xxx	200 – 480	180	50 – 550	250	184

Appendix

Wire Terminal Specs

English / Imperial Units

Drive Model Number	Power Terminals		Ground Terminals		Control Power Terminals (F1 & F2) 230VAC		Control Wiring Terminals TB1		Control Wiring Terminals TB2	
	Wire Size range (AWG)	Torque Spec (in-lb)	Wire Size range (AWG)	Torque Spec (in-lb)	Wire Size range (AWG)	Torque Spec (in-lb)	Wire Size range (AWG)	Torque Spec (in-lb)	Wire Size range (AWG)	Torque Spec (in-lb)
QDC125-xxxx-xxx	#6-350 MCM	500	#8-310 MCM	2-2.5	#10-#18	3 - 7	#16-#24	1.8-2.2	#14-#24	3.6-4.4
QDC200-xxxx-xxx	#6-500 MCM	500	#8-310 MCM	2-2.5	#10-#18	3 - 7	#16-#24	1.8-2.2	#14-#24	3.6-4.4
QDC250-xxxx-xxx	#6-500 MCM	500	#8-310 MCM	2-2.5	#10-#18	3 - 7	#16-#24	1.8-2.2	#14-#24	3.6-4.4

Metric Units

Drive Model Number	Power Terminals		Ground Terminals		Control Power Terminals (F1 & F2) 230VAC		Control Wiring Terminals TB1		Control Wiring Terminals TB2	
	Wire Size range (mm ²)	Torque Spec (N-m)	Wire Size range (mm ²)	Torque Spec (N-m)	Wire Size range (mm ²)	Torque Spec (N-m)	Wire Size range (mm ²)	Torque Spec (N-m)	Wire Size range (mm ²)	Torque Spec (N-m)
QDC125-xxxx-xxx	16-180	56.6	10-160	0.23-0.28	6-0.75	0.3-0.8	0.2-1.5	0.2-0.25	0.2-2.5	0.4-0.5
QDC200-xxxx-xxx	16-250	56.6	10-160	0.23-0.28	6-0.75	0.3-0.8	0.2-1.5	0.2-0.25	0.2-2.5	0.4-0.5
QDC250-xxxx-xxx	16-250	56.6	10-160	0.23-0.28	6-0.75	0.3-0.8	0.2-1.5	0.2-0.25	0.2-2.5	0.4-0.5

Appendix

Dimensions / Weights

Excluding customer I/O panel

Drive Model Number	Dimensions*						Weight	
	Height		Width		Depth		lbs	kg
	inches	mm	inches	mm	inches	mm		
QDC125-xxxx-xxx	88	2244	22	565	18	459	600	272
QDC200-xxxx-xxx	88	2244	44	1130	18	459	1000	453
QDC250-xxxx-xxx	88	2244	44	1130	18	459	1000	453

With Optional Customer I/O panel

Drive Model Number	Dimensions**						Weight	
	Height		Width		Depth		lbs	kg
	inches	mm	inches	mm	inches	mm		
QDC125-xxxx-xxx	88	2244	32	816.6	19	187	700	320
QDC200-xxxx-xxx	88	2244	54	1372.8	19	187	1100	501
QDC250-xxxx-xxx	88	2244	54	1372.8	19	187	1100	501

*Note: Dimensions reflected are without the optional Dynamic Braking Resistor Cage or optional Customer I/O panel.

**Note: Dimensions reflected are without the optional Dynamic Braking Resistor Cage but including the optional Customer I/O panel.

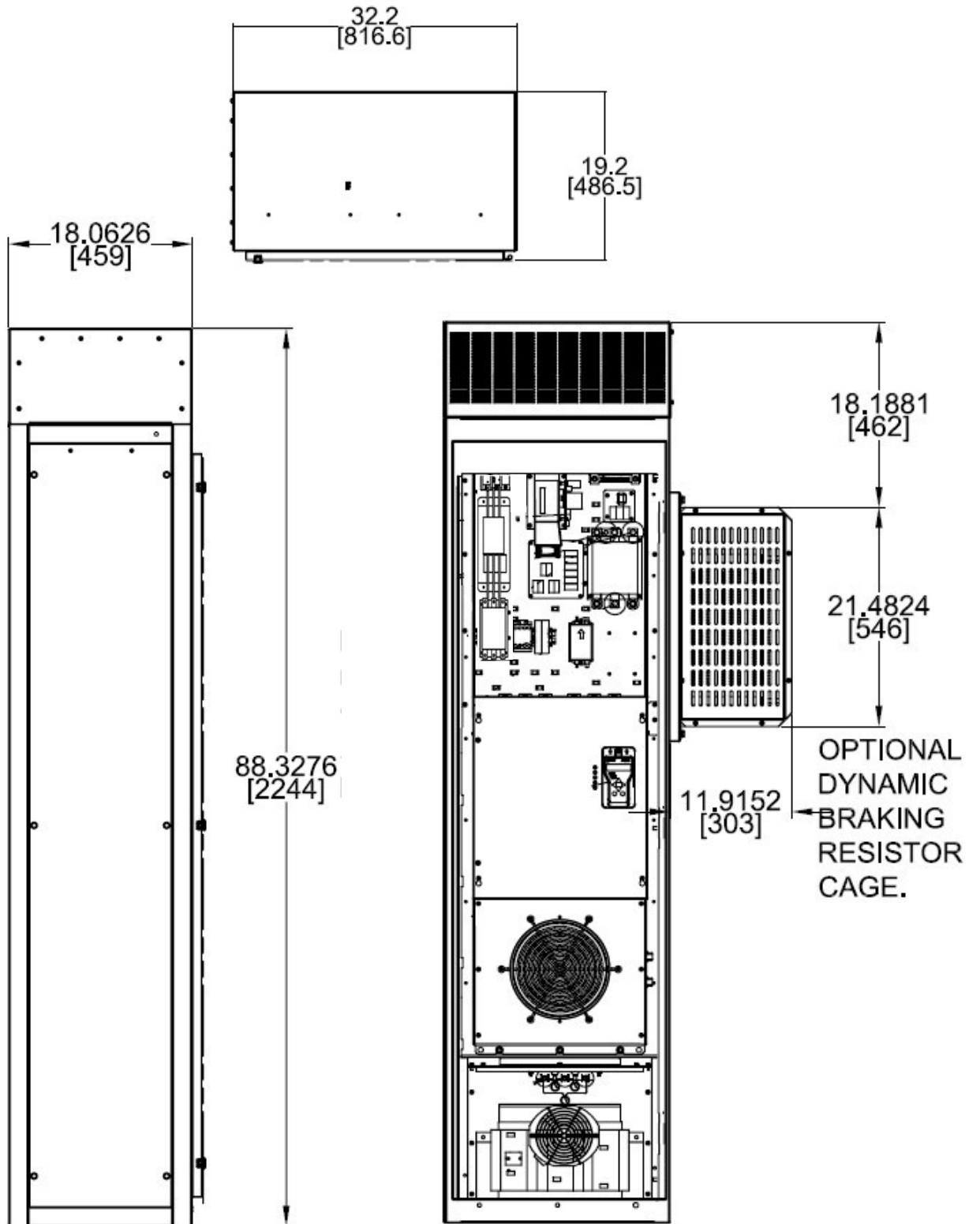

Figure 30: 125A unit Dimensions without optional Customer I/O Panel

Appendix – Dimensions and Weights

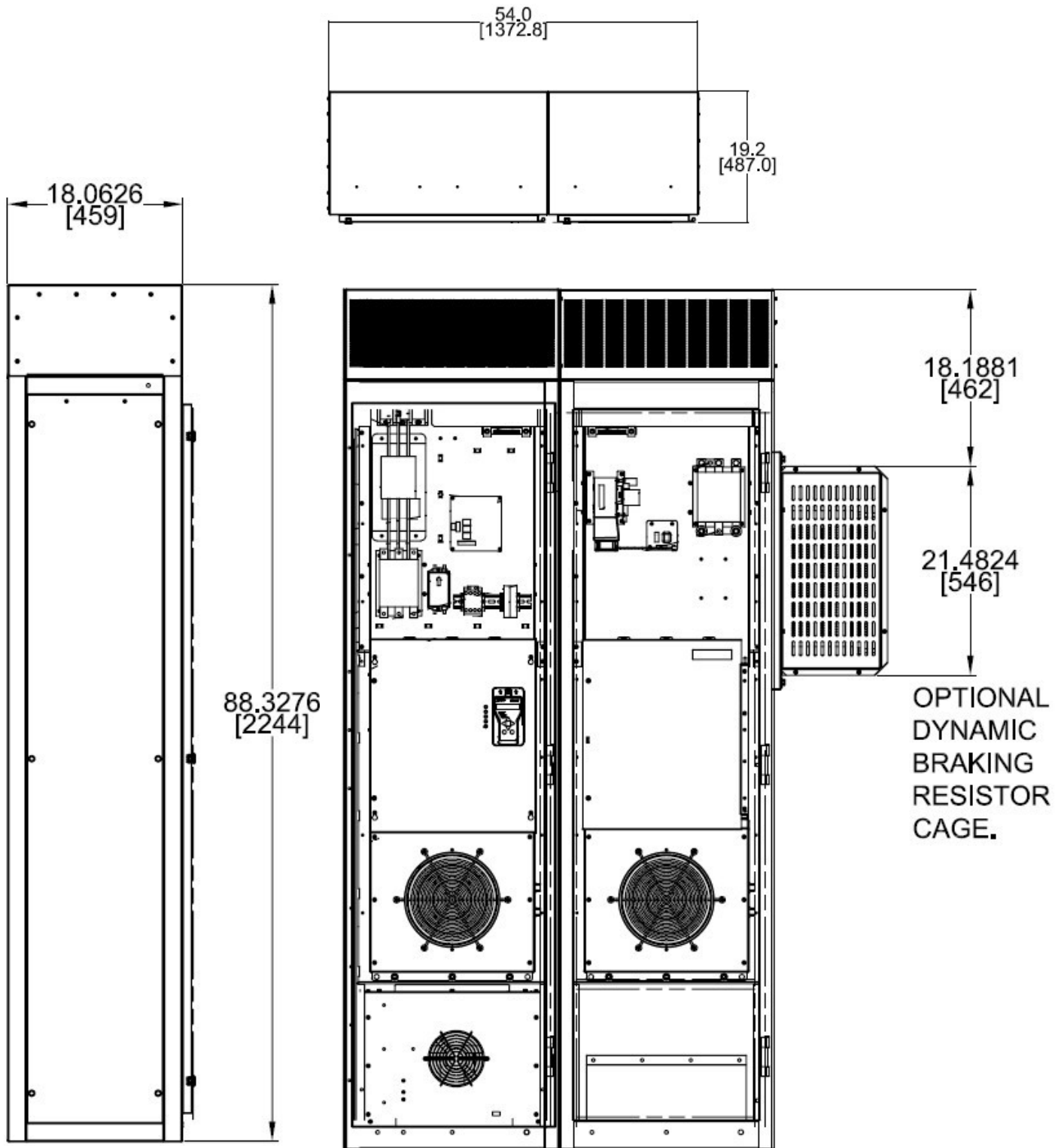

Figure 31: 200A and 250A unit dimensions without optional Customer I/O Panel

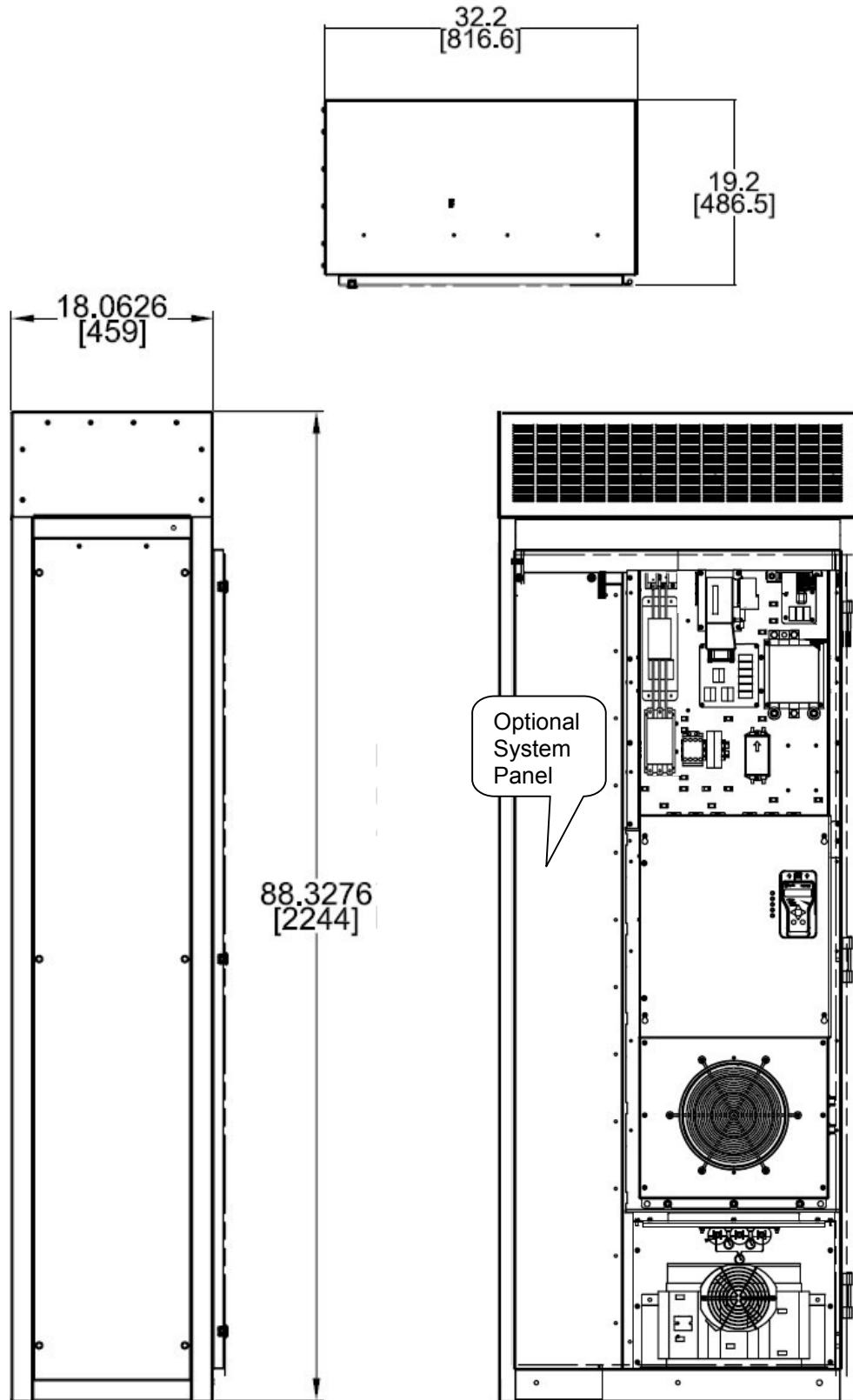

Figure 32: 125A unit Dimensions with Optional System Panel

Appendix – Dimensions and Weights

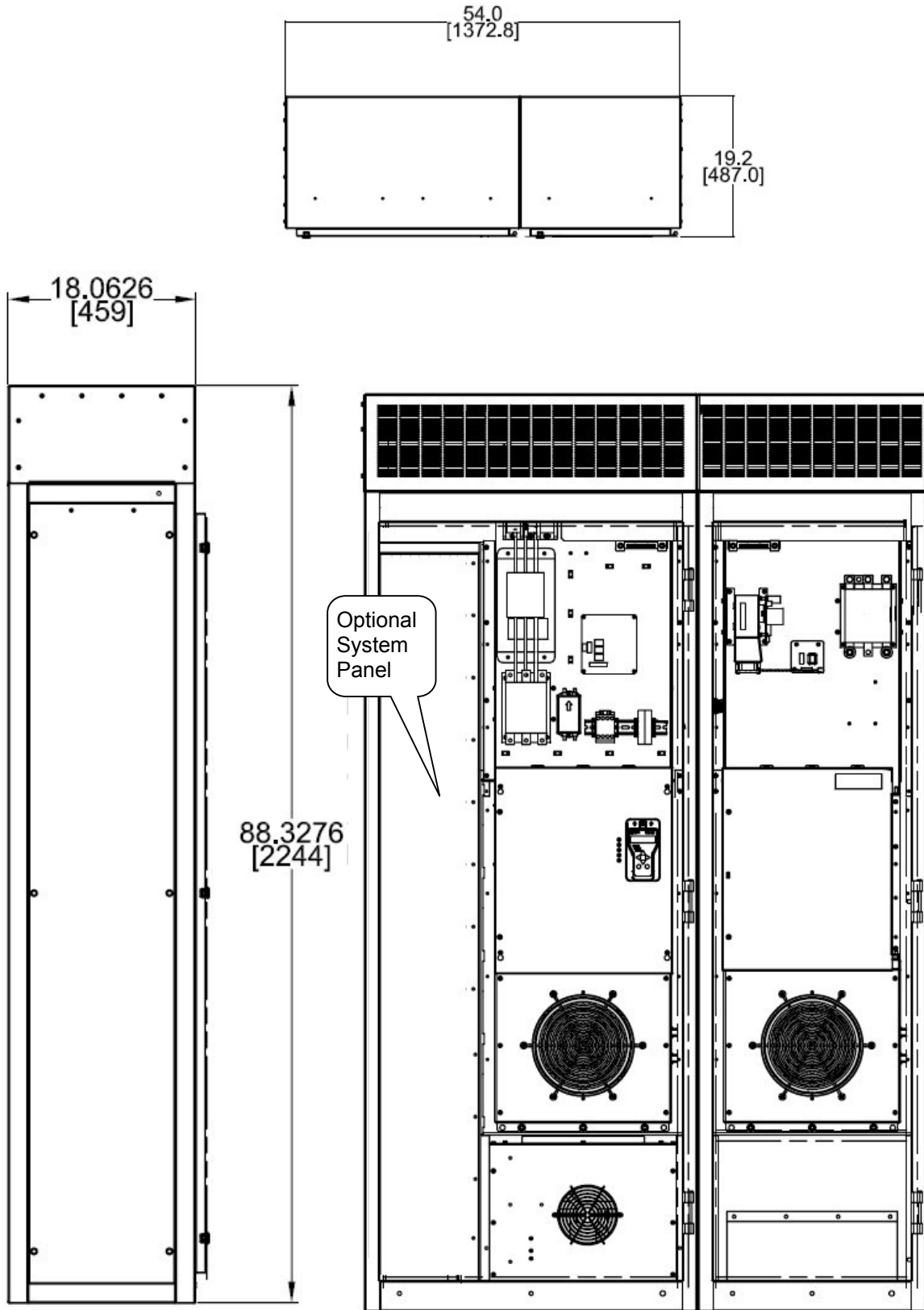

Figure 33: 200 / 250 A unit Dimensions with Optional System Panel

Appendix

Component Locations

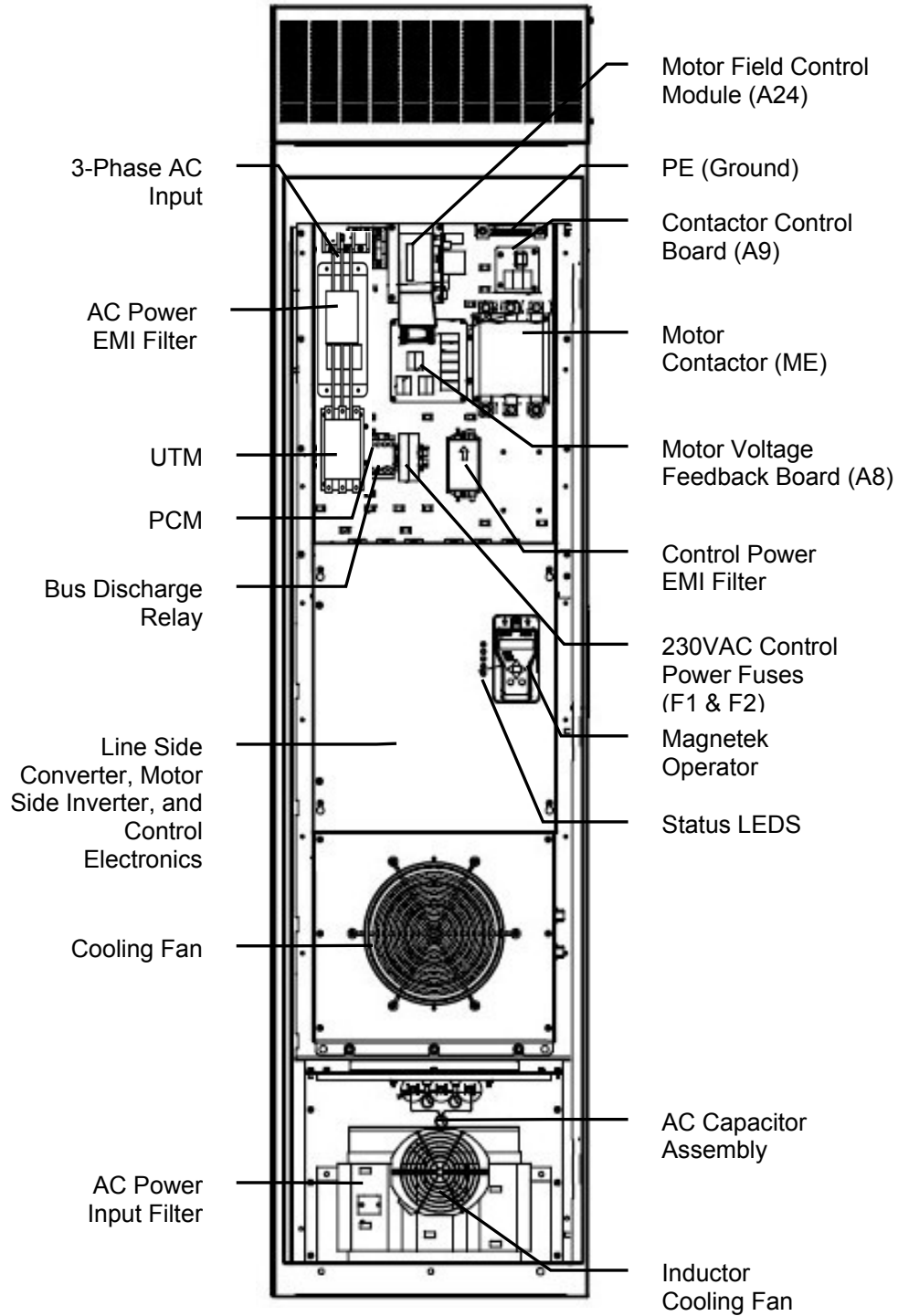

Figure 34: 125A Component Locations

Appendix – Component Locations

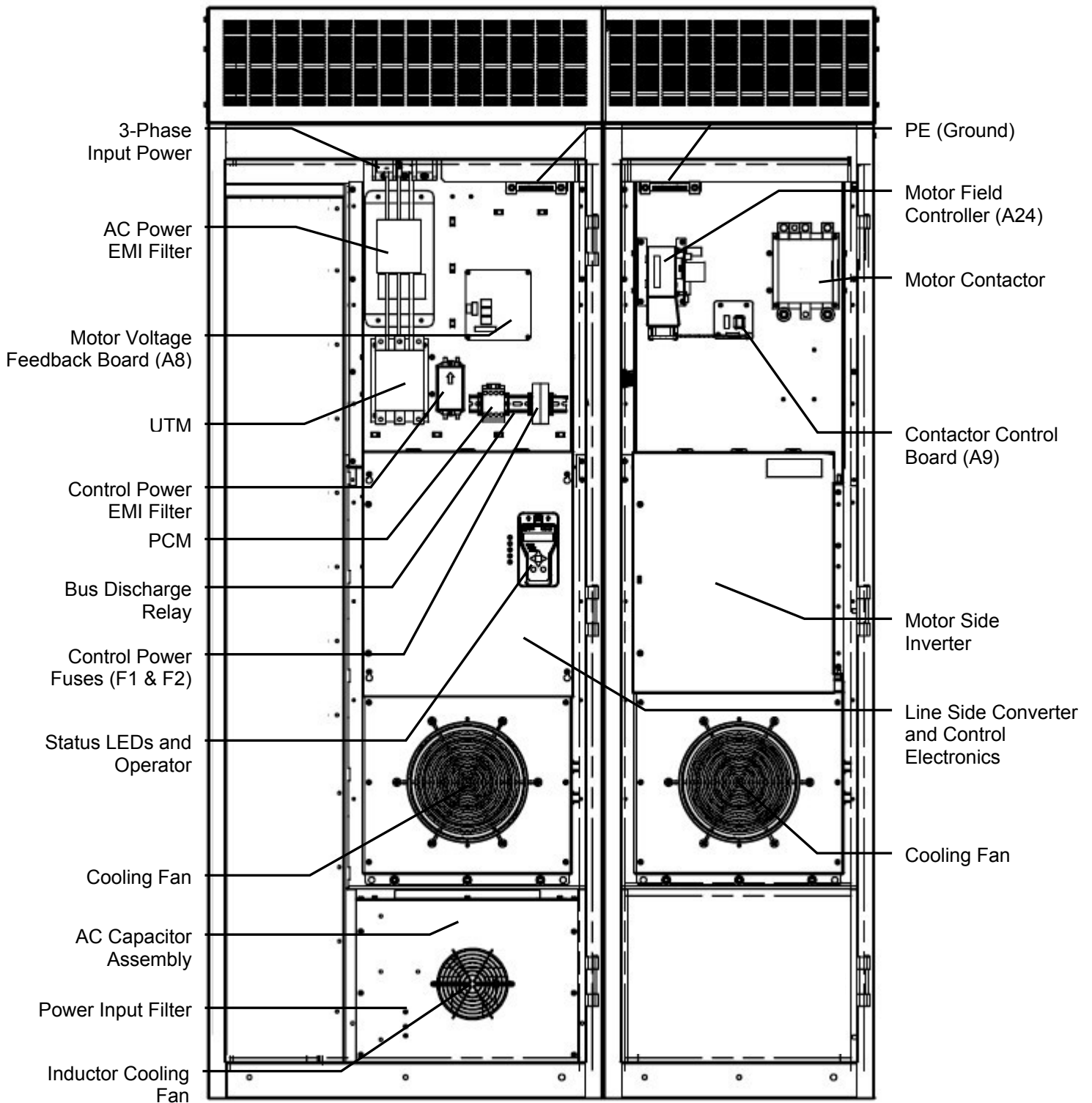

Figure 35: 200 / 250 A Component Locations

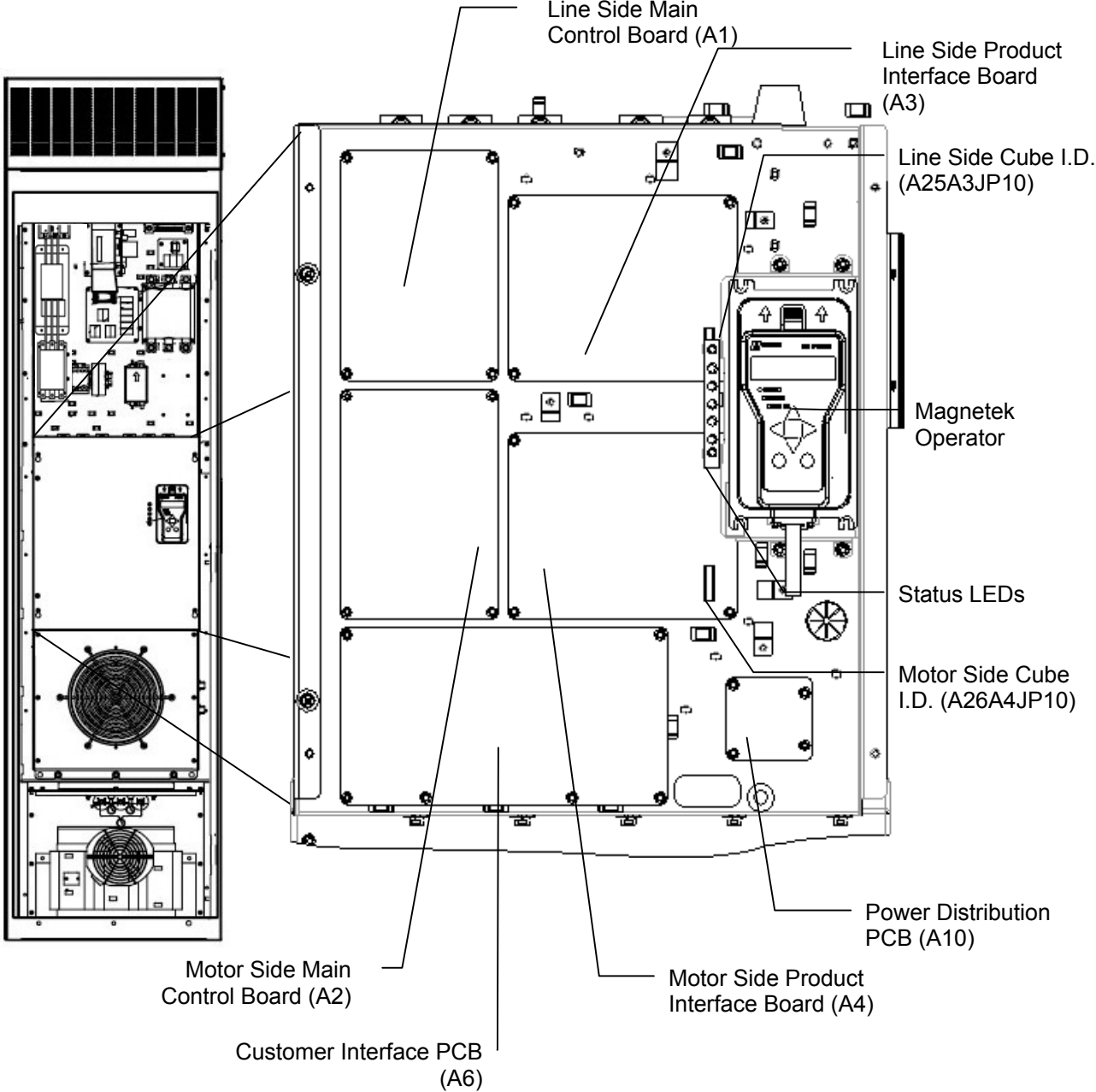

Figure 36: 125A Circuit Board Locations

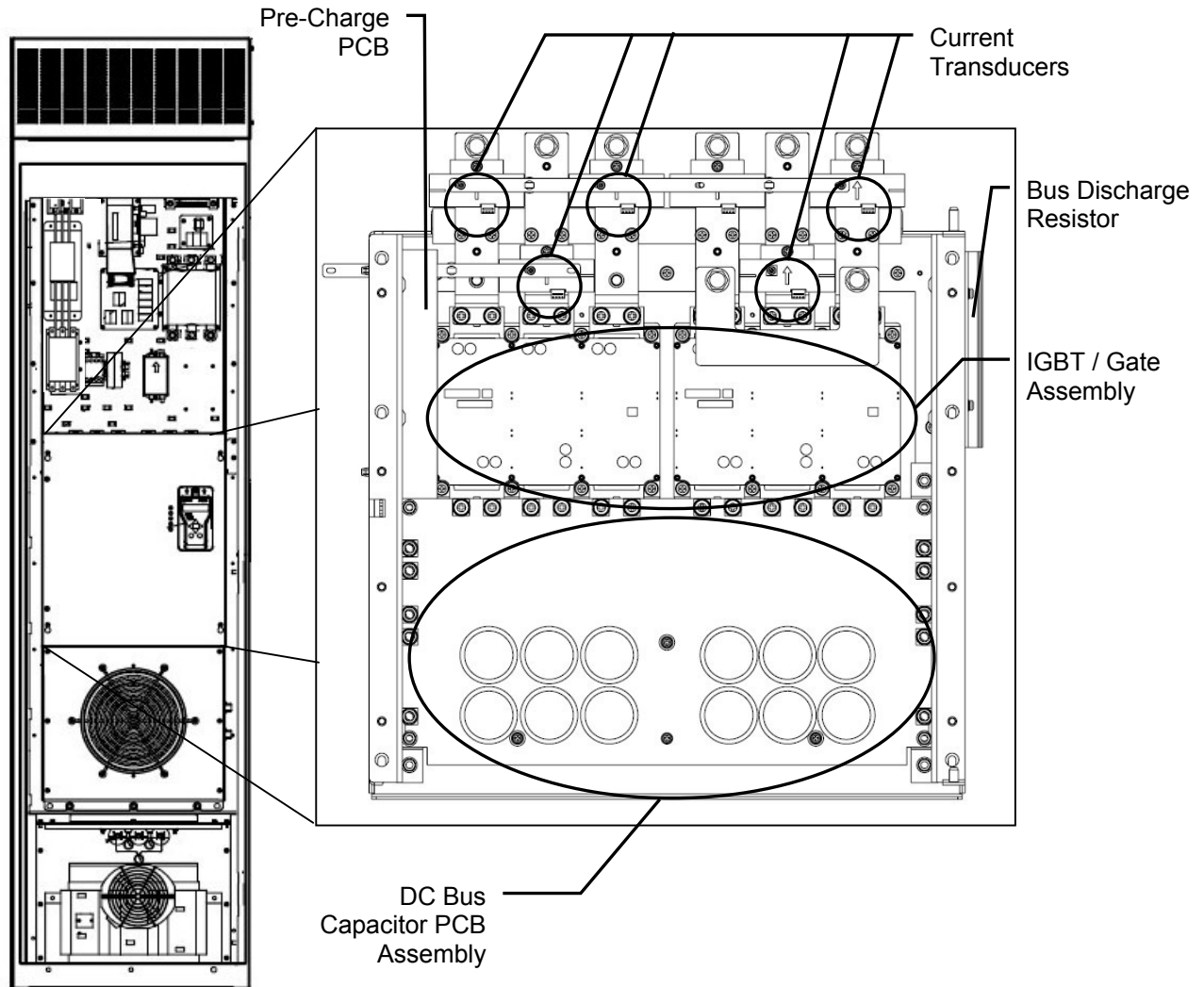

Figure 37: 125A IGBT Heatsink Assembly

Note: The Power Section sits under the Main Control Board Assembly

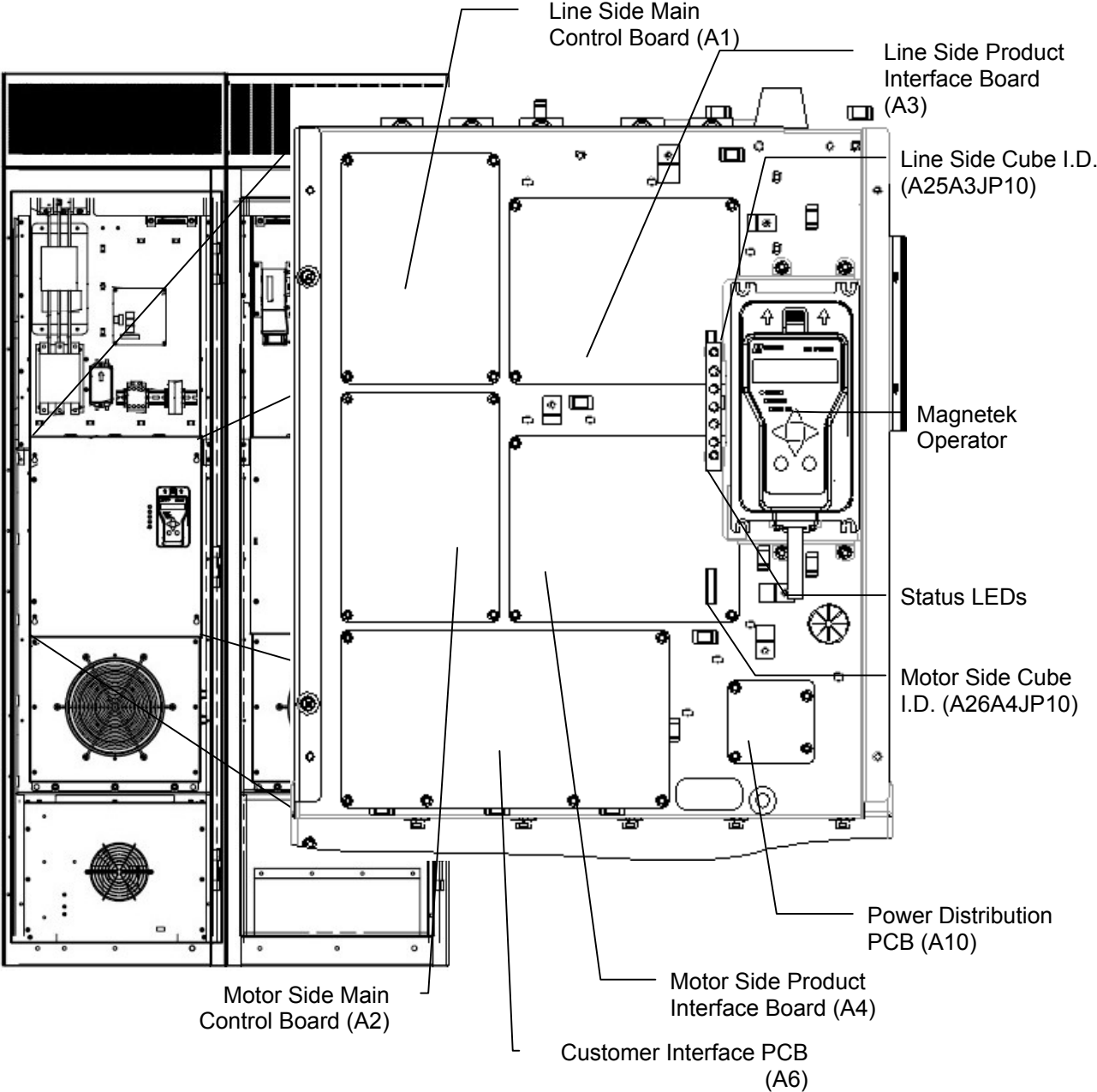

Figure 38: 200 / 250 A Circuit Board Locations

Appendix – Component Locations

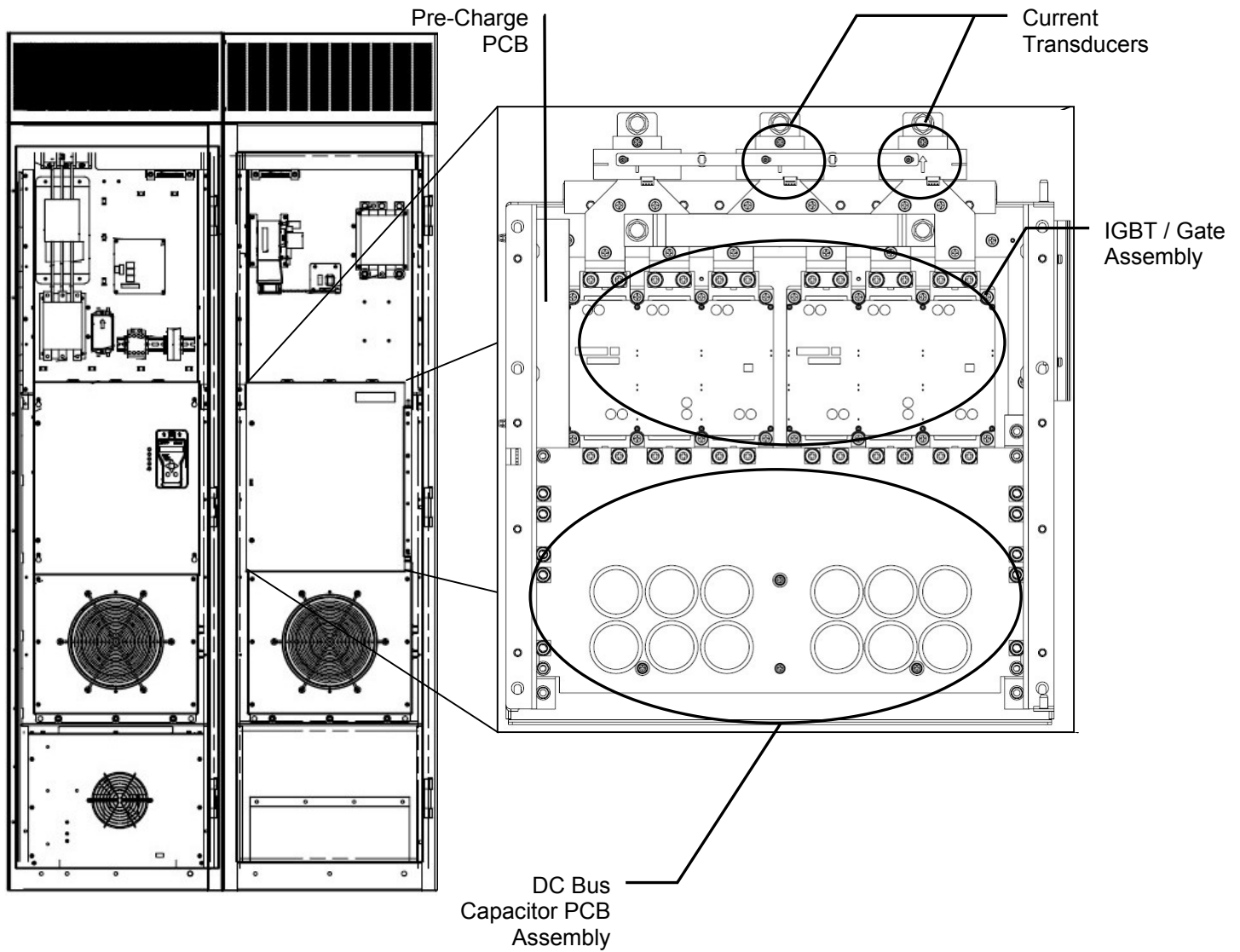

Figure 39: 200 / 250 A Motor Side Power Section

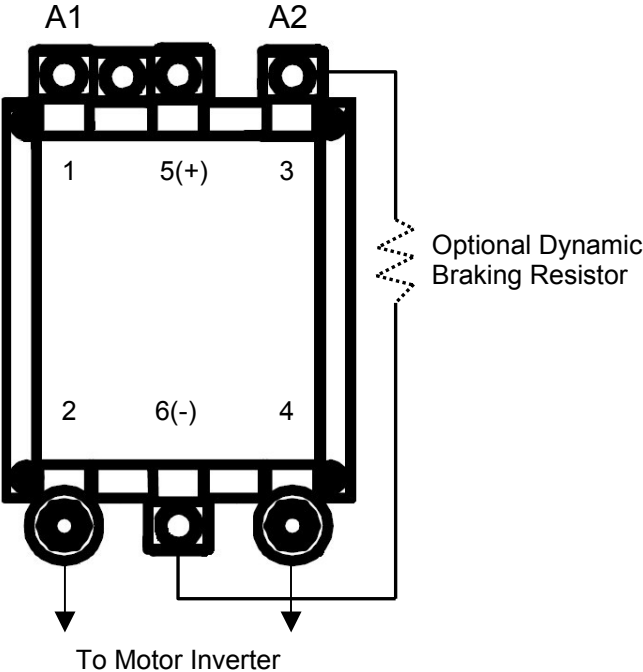

Figure 40: Motor Contactor Connections

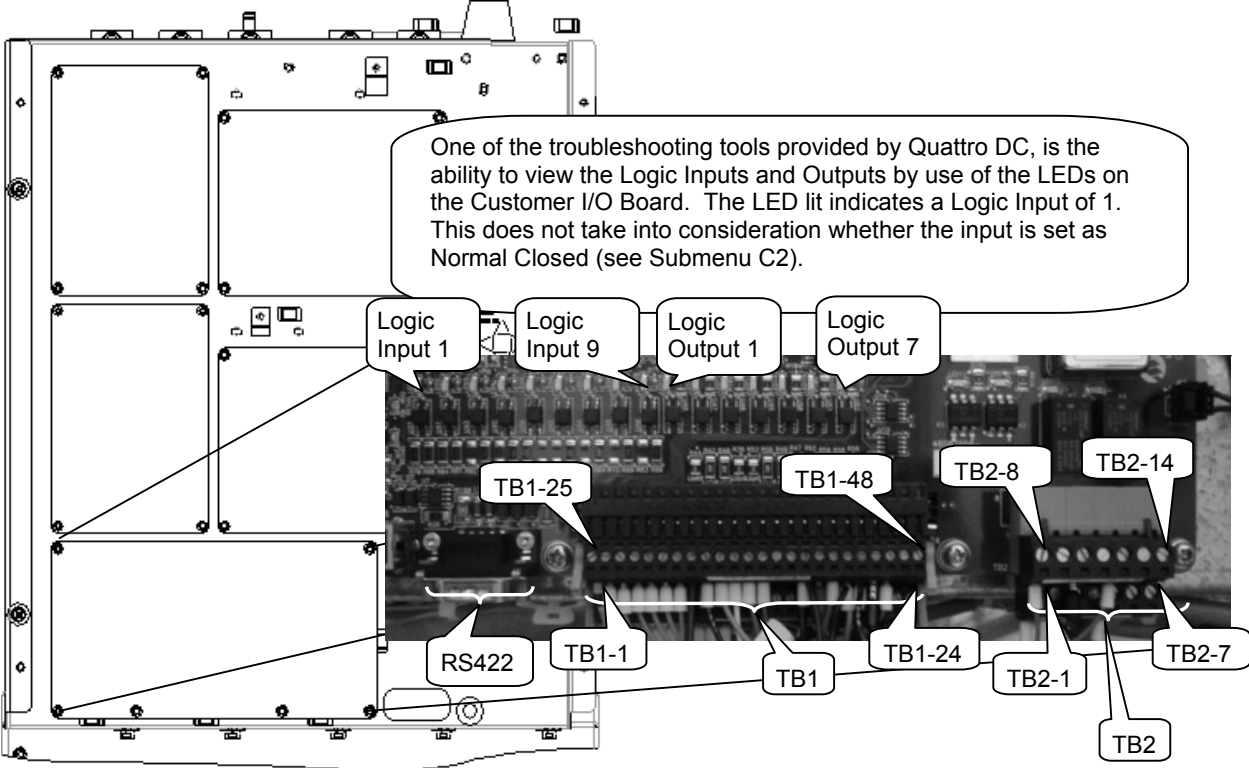

Figure 41: Customer Input / Output Connections

Appendix

Spare Parts Quattro DC Drive

Description	Description	Drive Rating	Reference Designator	Magnetek kit Number	Quantity Per Drive
Main Control PCB (Line Side)	Controls line side power conversion	ALL	A1	LA46S03776-2110	1
Main Control PCB (Motor Side)	Controls Motor Side Conversion	ALL	A2	LA46S03776-0110	1
Product Interface PCB 1. Kit contains 1.0 PCB 2. These PCB's are interchangeable except for the cube I.D's	Converts signals from the respective main control boards to drive hardware	ALL	A3, A4	LA46S03954-0010	2
Power Supply	Provides low voltage control power	ALL	A5	LA05P00090-0668	1
Customer Interface PCB	Contains customer inputs and outputs	ALL	A6	LA46S03950-0010	1
Voltage Feedback PCB	Contains line and motor sense and Pre-charge control relay logic	ALL	A8	LA46S03963-0010	1
Contactor Control PCB	Controls the Motor Contactor (ME)	ALL	A9	LA46S03799-0010	1
Power Distribution PCB	Distributes voltage from the Power Supply (A5)	ALL	A10	LA46S03862-0010	1
DC Bus Cap Board	Bus Filter Capacitors	125A	A17	LA46S03766-0010	1
		200A	A17, A18	LA46S03766-0010	2
		250A	A17, A18	LA46S03766-0010	2
Precharge PCB	Contains circuitry for the Pre-charge	ALL	A23	LA46S03802-0010	1
Field Control Module	Motor Shunt Field Regulator	ALL	A24	LA46S03829-0010	1
Cube ID PCB (Line Side)	Defines size of drive and gives the Product Interface Board (A3) its identification	125A	A25A3JP10	LA46S03842-2590	1
		200A	A25A3JP10	LA46S03842-2610	1
		250A	A25A3JP10	LA46S03842-2630	1

Appendix – Spare Parts List

Description	Description	Drive Rating	Reference Designator	Magnetek kit Number	Quantity Per Drive
Cube ID PCB (Motor Side)	Defines size of drive and gives the Product Interface Board (A4) its identification	125A	A26A4JP10	LA46S03842-0600	1
		200A	A26A4JP10	LA46S03842-0620	1
		250A	A26A4JP10	LA46S03842-0640	1
AC Capacitor Assembly	Along with the L1 Inductor, creates a filter to minimize harmonics and better the power factor	125A	A29	LA46S03948-0010	1
		200A	A29	LA46S03948-0020	1
		250A	A29	LA46S03948-0030	1
Control Fuses (Kit will contain 2.0 fuses)	230VAC Control Power Fuses	ALL	F1, F2	LA05P00017-0565	2
Control Fuse Fuse Blocks (Kit will contain 2.0 blocks)	230VAC Control Fuse Fuse Blocks	ALL	F1, F2	LA05P00019-0163	2
Inductor	Along with the AC Capacitor Assembly, creates a filter to minimize harmonics and better the power factor	125A	L1	LA05P00010-0567	1
		200A	L1	LA05P00010-0566	1
		250A	L1	LA05P00010-0566	1
AC Input EMI Filter	Filter for reduction of RFI/EMI to and from the drive and the line utility	125A	L2	LA46S03855-0010	1
		200A	L2	LA46S03855-0020	1
		250A	L2	LA46S03855-0020	1
Control Power EMI Filter	Filter for reduction of RFI/EMI to and from the drive and the 230VAC Control Power	ALL	L3	LA05P00010-0586	1
DC bus discharge contactor	Contacting used to discharge the bus when the drive is no longer boosting	ALL	DCHG	LA05P00032-0176	1
DC Output Contactor	Motor Armature Contactor (ME)	125A	ME	LA05P00032-0154	1
		200A	ME	LA05P00032-0154	1
		250A	ME	LA05P00032-0155	1
Precharge Contactor	Pre-charge Contactor	ALL	PCM	LA05P00032-0163	1
Line Contactor	230VAC Control Power Line Contactor	125A	UTM	LA05P00032-0158	1
		200A	UTM	LA05P00032-0159	1
		250A	UTM	LA05P00032-0159	1

Appendix – Spare Parts List

Description	Description	Drive Rating	Reference Designator	Magnetek kit Number	Quantity Per Drive
Control Tray Includes: 1. Fully tested door assembly with cables.	Prewired control tray with power supply and interfacing cables. Consists of: A1, A2, A3, A4, A5, A6, A10, A25, and A26.	125A	Control Tray	LA46S03828-1110	1
		200A		LA46S03828-1150	
		250A		LA46S03828-1130	
IGBT Heatsink Assembly Includes: 1. Power section without door section.	Includes power section without the Control Tray. Included are: heatsink, IGBT's with Gate Drive Boards, Current Transducers with rubber boots, and DC Bus Capacitor board (A17, A18)	125A	Line/Motor Side	LA46S03848-1010	1
		200A	Line Side	LA46S03848-2050	1
		200A	Motor Side	LA46S03848-0050	1
		250A	Line Side	LA46S03848-2030	1
		250A	Motor Side	LA46S03848-0030	1
Complete Power Section Includes: 1. Control tray 2. IGBT Heatsink Assembly 3. Fan Module	Includes power section, the Control Tray, Heatsink Assembly, and Fan Module.	125A	Line/Motor Side	LA46S03825-1110	1
		200A	Line Side	LA46S03825-2150	1
		200A	Motor Side	LA46S03825-0150	1
		250A	Line Side	LA46S03825-2130	1
		250A	Motor Side	LA46S03825-0130	1
Blower Module	3-Speed Cooling Fan	125A	FAN1	LA46S03826-0010	1
		200A		LA46S03826-0010	2
		250A		LA46S03826-0010	2
Door Filter, 12 x 24	Disposable air filter located in the door	125A	FLTR1	LA05P00089-0197	1
		200A		LA05P00089-0197	2
		250A		LA05P00089-0197	2
Door Filter, 8 x 8	Disposable air filter located in the door	125A	FLTR2	LA05P00089-0199	1
		200A		LA05P00089-0199	2
		250A		LA05P00089-0199	2
Door Filter, 12 x 12 Used in the 22in load side	Disposable air filter located in the door	200A	FLTR3	LA05P00089-0198	1
		250A		LA05P00089-0198	1
Field module fan	Cools heatsink of the Field Supply	ALL	FAN3	LA05P00016-0086	1
Inductor fan	Inductor Fan	ALL	FAN2	LA05P00016-0088	1
Operator Keypad	Drive Programming Tool	ALL		ELEV-ELOP	1

Index

A

A to D Fault.....	80
A0 - Adjust Menu	30–49
A1 - Drive Submenu	30–38
A3 - Multistep Ref Submenu	41–42
A5 - Line Side Power Convert Submenu.....	46
A6 - Motor Parameters Submenu.....	47–49
AB OFF DELAY parameter	34
AB ZERO SPD LEV parameter	34
ACCEL JERK IN parameters	40
ACCEL JERK OUT parameters	40
ACCEL RATE parameters.....	40
ALARM logic output.....	63
ALARM+FLT logic output	63
ANA OUT x GAIN parameter.....	33
ANA OUT x OFFSET parameter	33
Analog Velocity Follower	23
ARM CURRENT analog output	65
ARM CURRENT display value	68
ARM INDUCTANCE parameter	43
ARM RESISTANCE parameter	43
ARM VOLTAGE analog output.....	65
ARM VOLTAGE display value.....	68
ARMATURE IR DROP parameter	47
Armature Voltage Feedback.....	24
ARMATURE VOLTS parameter	47
ARMAUTRE CUR ERR display value	68
ATUO STOP user switch.....	58
AUTO BRAKE logic output.....	63
AUTO FIELD RES display value	68
AUTO FIELD TC display value.....	68
AUTO FLD INT display value	68
AUTO FLD PROP display value.....	68
AUTO MEAS ARM L display value	68
AUTO MEAS ARM R display value	68
Auto Tune Procedure	95
Automatic Fault Reset	53
AUX TORQ CMD analog output.....	65
AUX TORQUE CMD display value.....	66

B

Bad Srl Chksm Alarm	80
BRAKE.....	54
BRAKE HOLD logic output.....	63
BRAKE HOLD TIME parameter	31
BRAKE PICK CNFM user switch	54
BRAKE PICK logic output.....	63
BRAKE PICK SRC user switch	54
BRAKE PICK TIME parameter	31
Bridge Ground Fault	80
Brk Hold Flt.....	80
BRK HOLD FLT ENA user switch	54
BRK HOLD FLT logic output	63
Brk Pick Flt	81

C

BRK PICK FLT ENA user switch	54
BRK PICK FLT logic output	63
BUS VOLTAGE analog output.....	65
BUS VOLTAGE display value.....	68
BUS VREF SOURCE parameter.....	46

C2 – Logic Inputs Submenu	61–62
C3 - Logic Outputs Submenu	63–64
CAR GOING DWN logic output	63
CAR GOING UP logic output.....	63
Center Frequency - Notch Filter	38
Changing Carrier Frequency	44
CHARGE FAULT logic output.....	63
Check Setup Flt	81
Circuit Board Locations - 125A.....	111
Circuit Board Locations - 200 / 250 A.....	113
CLOSE CONTACT logic output.....	63
Comm Fault	81
Component Locations - 125A	109
Component Locations - 200 / 250 A	110
Configure C0 Menu.....	50–65
Connector Off Flt.....	81
CONT CONFIRM SRC user switch	52
Cont Pwr Lost Flt	82
CONTACT CFIRM logic input.....	62
CONTACT FLT TIME parameter	31
CONTACTOR D0 DLY parameter	34
CONTACTOR FLT logic output	63
CONTRACT CAR SPD parameter	30
CONTRACT MTR SPD parameter	30
Control Power Consumption.....	102
CTR PWR SENSE logic input.....	62
Cube Data Flt.....	82
Cube ID Fault.....	82
Curr Reg Flt	82
CURR REG FLT logic output.....	63
CURRENT LIMIT parameter.....	30
Customer I/O Board.....	115
Customer Input/Output Connections	115

D

D0 - Display D0 Menu.....	66–69
D1 - Elevator Data Submenu	66–67
DC BUS REG I GAIN parameter	46
DC BUS REG P GAIN parameter.....	46
DC BUS V BOOST parameter.....	46
DC BUS VOLTAGE display value	69
DC BUS VOLTS REF display value	69
DCU Data Flt.....	82
DECEL JERK IN parameters.....	40
DECEL JERK OUT parameters.....	40
DECEL RATE parameters	40
Dimensions	102–6
DIR CONFIRM user switch.....	55

Dir Conflict	82
DRIVE ENABLE logic input	62
Drive Ovrload.....	83
DRV OVERLOAD logic output	63
DS MODULE TEMP display value	68
DSPR ENABLE user switch	58
DSPR TIME parameter.....	35

E

Elevator Speed Regulator	59
EMC Compliance.....	97
ENCODER CONNECT user switch.....	52
Encoder Fault OFF	83
ENCODER FAULT user switch	56
Encoder Flt	83
ENCODER FLT logic output.....	63
ENCODER PULSES parameter	32
ENCODER SPD display value	68
EReg..... See Elevator Speed Regulator	
EST INERTIA display value.....	66
EST MOTOR SPD analog output.....	65
EST SPD FDBK display value.....	68
EX TORQ CMD SRC user switch	55
EXT TORQUE BIAS	32
EXT TORQUE MULT parameter.....	33
Extern Fault 2	84
Extrn Fault 1	83
Extrn Fault 3	84
Extrn Fault 4	84
EXTRN FAULT logic input.....	62

F

F0 - Fault Menu	76–77
F1 - Active Faults Submenu	76
F2 - Fault History	77
FAN OFF DELAY parameter.....	44
FAULT logic output.....	63
Fault Reset	53
FAULT RESET logic input.....	62
FAULT RESET SRC user switch	53
Faults, Troubleshooting Guide	80–94
FIELD CURRENT analog output.....	65
FIELD CURRENT display value.....	68
FIELD ENA SOURCE user switch	50
FIELD ENABLE logic input.....	62
Field Ground Fault.....	84
Field I Reg Fault	84
Field IGBT Fault	84
Field Loss Fault	84
Field Overcurrent Fault.....	85
FLD CARRIER FRQ parameter	45
FLT RESET / HOUR parameter	34
FLT RESET DELAY parameter	34
FLUX CNFRM LEVEL parameter.....	47
FLUX CONFIRM logic output	63
FULL FIELD TIME parameter.....	35

FULL FLD AMPS parameter.....	47
Full Fld Time Fault.....	85

G

GAIN BANDWIDTH A parameter	44
GAIN BANDWIDTH F parameter.....	44
Gain Change Level	36
GAIN CHNG LEVEL parameter.....	30
GAIN REDUCE MULT parameter.....	30
GAIN SELECTION parameter	43
GROUND FAULT logic output.....	64

H

HI/LO GAIN SRC user switch	51
High / Low Gain Source.....	59
Hit Torque Limit.....	85
HW/SW Mismatch Fault.....	85

I

ID REG INTEGRAL GAIN parameter	46
ID REG PROP GAIN parameter	46
IF REG INT GAIN parameter	43
IF REG PROP GAIN parameter	43
IN LOW GAIN logic output.....	64
Inertia Calculation	96
INERTIA parameter	30
INNER LOOP XOVER parameter.....	30
INPUT HZ display value	69
INPUT L-L VOLTS parameter.....	46
INPUT Vab display value.....	69
INPUT Vca display value	69
Internal Preset Speed & Profile Generator ...	23
Invalid Checksum.....	85
IP Comm Fault	85
IQ REG INTEGRAL GAIN parameter	46
IQ REG PROP GAIN parameter.....	46

L

LEDs - Front Cover	25
Line Hi Volts Fault.....	85
LOGIC INPUT parameters.....	61
Logic Input Wiring	17
LOGIC INPUTS display	67
Logic Output Wiring	19
LOGIC OUTPUTS display	67
LOW GAIN SEL logic input.....	62
LS A to D Fault.....	85
LS AC Cntcr Fault.....	85
LS Bridge Gnd Fault	86
LS Charge Fault.....	86
LS Chk Setup Fault.....	86
LS Conn Off Fault	86
LS Cube Data Fault	86
LS Cube ID Fault	86
LS Curr Reg Fault.....	86

LS DCU Data Fault.....	86
LS Hit Current Lmt Alarm	87
LS HW/SW Fault	87
LS IGBT Fault.....	87
LS IP Comm Fault	87
LS MODULE TEMP display value	68
LS Overcurr Fault	87
LS Overload Fault.....	87
LS Overtemp	88
LS Overvolt Fault.....	88
LS PCU Data Flt.....	89
LS Phase Fault	89
LS Power Data D3 submenu	69
LS PWM FREQ parameter	46
LS PWR OUTPUT display value	69
LS Size Fault	89
LS Undr Voltg Alarm.....	89
LS Undrvolt Fault.....	89

M

MAIN FAN CONTROL parameter	45
Maintenance, General	78
ME Cont Pwr Fault	90
ME Pwr Avail Fault	90
MECH BRK HOLD logic input	62
MECH BRK PICK logic input.....	62
Menus.....	26
Module x IGBT.....	90
Monitor Rev	90
Motor Contactor Connections.....	115
MOTOR ID parameter	47
MOTOR MODE analog output	65
MOTOR MODE display value.....	68
MOTOR OVERLOAD display.....	48
MOTOR ROTATION user switch	52
Motor Side Power Data D2 Submenu	68
MOTOR TRQ LIM logic output	64
MS Size Fault	90
Mtr Data Fault.....	90
Mtr Overload.....	90
MTR OVERLOAD logic output	64
MTR REV VLT LIMparameter	43
Multi-Step Speed Command Debounce	41
Multi-Step Speed Command Selection	41

N

No Drv Handshake	90
NO FUNCTION logic input	62
NO FUNCTION logic output.....	64
NOT ALARM logic output	64
NOTCH FILT DEPTH parameter.....	35
Notch Filter	38
NOTCH FILTER FRQ parameter	35

O

Open Armature Flt.....	91
OSPD TEST SRC logic input	62

OVER CURR FLT logic output	64
Overcurr Flt.....	91
OVERSPD TEST SRC user switch	54
Overspeed Flt	91
OVERSPEED FLT logic output.....	64
OVERSPEED LEVEL parameter.....	31
OVERSPEED MULT parameter	32
OVERSPEED TIME parameter	32
Overtemp Flt	91
OVERTEMP FLT logic output.....	64
Overvolt Flt.....	92
OVERVOLT FLT logic output	64
OVLD START LEVEL parameter.....	48
OVLD TIME OUT parameter	48
Ovrtemp Alarm.....	92
OVRTMP ALARM logic output	64

P

Param Rev Flt.....	92
Parameter Reference	3–8
Parameter Tree.....	26, 28–29
PCU Data Flt.....	92
PHASE FAULT logic output.....	64
PI Speed Regulator	60
PLL FILTER FC parameter.....	46
Power Section - 125 A	112
Power Section - 200 / 250A	114
PRETORQUE LATCH user switch	53
PRETORQUE REF analog output.....	65
PRE-TORQUE REF display value.....	66
PRETORQUE SOURCE user switch.....	52
PRE-TRQ LATCH logic input.....	62
PRIORITY MESSAGE user switch	56
PTROQ LATCH CLCK user switch.....	53
PWM FREQ parameter.....	44

R

RAMP DOWN EN SRC user switch	54
RAMP DOWN ENA logic output	64
RAMPED STOP SEL user switch.....	54
RAMPED STOP TIME parameter.....	31
RATED MOTOR CURR parameter	47
READY TO RUN logic output	64
Ready, Waiting for Drive	92
REGEN TRQ LIM logic output.....	64
Relay Coils.....	63
RESPONSE parameter	30
Reversed Tach Fault	83
Rollback Gain.....	37
ROLLBACK GAIN parameter	35
RUN COMMAND SRC user switch	50
RUN COMMANDED logic output.....	64
RUN CONFIRM logic output.....	64
Run Delay Timer	37
RUN DELAY TIMER parameter.....	34
RUN DOWN logic input	62
RUN logic input	62

RUN UP logic input.....62

S

S-Chain Event92
S-CURVE ABORT user switch56
S-CURVE SEL logic input62
Selecting Logic Input Definitions61
SER2 INSP ENA logic input62
Serial Link Follower23
Setup Flt92
Solid State Relays63
SPD COMMAND BIAS parameter32
SPD COMMAND MULT parameter32
SPD DEV HI LEVEL parameter32
SPD DEV LO LEVEL parameter32
SPD DEV TIME parameter32
SPD PHASE MARGIN parameter31
SPD REF RELEASE user switch52
SPD REG TORQ CMD display value66
SPD REG TYPE user switch51
SPD RG TQ CMD analog output65
SPEED COMMAND analog output65
SPEED COMMAND parameters42
SPEED DEV logic output64
SPEED DEV LOW logic output64
Speed Dev Low/High Level37
SPEED ERROR analog output65
SPEED ERROR display value66
SPEED FEEDBACK display value66
SPEED FEEDBK analog output65
SPEED REF analog output65
SPEED REF RLS logic output64
SPEED REFERENCE display value66
SPEED REG RLS logic output64
Srl Timeout93
Startup Guide12
Status LEDs25
STEP REF Bx logic input62
STNDBY FIELD parameter47
STNDBY FLD TIME parameter35
STOPPING MODE user switch57
SW BUS OV LEVEL parameter46

T

TACH FILTER BW parameter30

TACH FILTER ENABLE user switch 52
TACH RATE CMD analog output 65
TACH RATE CMD display value 66
TACH RATE GAIN parameter 31
TACH SPEED analog output 65
TORQUE REF analog output 65
TORQUE REF display value 68
Torque Specs..... 103
Troubleshooting 79–94
TRQ LIM MSG DLY parameter..... 34
TRQ RAMP DOWN logic input 62

U

U0 - Utility Menu 70–76
U1 - Password Submenu 71
U2 - Hidden Items Submenu 71
U3 - Units Submenu 71
U4 - Overspeed Test Submenu 71
U5 - Restore Parameter Defaults Submenu. 72
U6 - Drive Info Submenu 73, 74
U7 - Hex Monitor Submenu 75
Undervolt Flt..... 94
UNDERVOLT FLT logic output 64
UP TO SPD LEVEL parameter 34
UP TO SPEED logic output 64
UP/DWN logic input 62
UP/DWN THRESHOLD parameter..... 33
User Switches C1 Submenu..... 50–60
Utility U0 Menu..... See U0 - Utility Menu
UV Alarm..... 94
UV ALARM LEVEL parameter 45
UV ALARM logic output 64
UV FAULT LEVEL parameter 45

W

Watts Loss 102
WEAK FLD AMPS parameter 47
Weights 104
Wire Terminal Specs 103

Z

ZERO SPEED LEVEL parameter 33
ZERO SPEED logic output 64
ZERO SPEED TIME parameter..... 33

QUATTRO DC

Data subject to change without notice. Quattro is a trademark of Magnetek, Inc.

Magnetek Elevator Products
N50 W13775 Overview Drive
Menomonee Falls, Wisconsin 53051
(800) 236-1705, (262) 252-6999, FAX (262) 790-4142
<http://www.elevatordrives.com>

Magnetek Elevator Products - Europe
20 Drake Mews, Crownhill
Milton Keynes, Bucks MK8 0ER UK
+44(0) 1908 261427, FAX +44(0) 1908 261674



MAGNETEK
E L E V A T O R

TM7310 © 2007 Magnetek, Inc. 5/07 rev 01