

MRV660

DVD RECORDER



Thank you for choosing
Magnavox.

Need help fast?

Read your Quick Use Guide and/or
Owner's Manual first for quick tips
that make using your Magnavox product
more enjoyable.

If you have read your instructions
and still need assistance,
you may access our online help at

www.magnavox.com

or call

1-800-705-2000

while with your product.



Magnavox vous remercie de
votre confiance.

Besoin d'une aide rapide?

Le Guide d'utilisation rapide et Manuel de
l'utilisateur regorgent d'astuces destinées à
simplifier l'utilisation de votre produit Magnavox.

Toutefois, si vous ne parvenez pas à résoudre
votre problème, vous pouvez accéder à
notre aide en ligne à l'adresse

www.magnavox.com

ou formez le

1-800-661-6162 (Francophone)

1-800-705-2000 (English speaking)

Veillez à avoir votre produit à
portée de main.



Gracias por escoger
Magnavox

Necesita ayuda inmediata?

Lea primero la Guía de uso rápido o el
Manual del usuario, en donde encontrará
consejos que le ayudarán a disfrutar
plenamente de su producto Magnavox.

Si después de leerlo aún necesita ayuda,
consulte nuestro servicio de
asistencia en línea en

www.magnavox.com

o llame al teléfono

1-800-705-2000

y tenga a mano el producto.



Return your Product Registration Card today to get the very most from your purchase.

Registering your model with MAGNAVOX makes you eligible for all of the valuable benefits listed below, so don't miss out. Complete and return your Product Registration Card at once to ensure:

*Proof of Purchase

Returning the enclosed card guarantees that your date of purchase will be on file, so no additional paperwork will be required from you to obtain warranty service.

*Product Safety Notification

By registering your product, you'll receive notification - directly from the manufacturer - in the rare case of a product recall or safety defect.

*Additional Benefits of Product Ownership

Registering your product guarantees that you'll receive all of the privileges to which you're entitled, including special money-saving offers.

MAGNAVOX

Congratulations on your purchase, and welcome to the "family!"

Dear MAGNAVOX product owner:

Thank you for your confidence in MAGNAVOX. You've selected one of the best-built, best-backed products available today. We'll do everything in our power to keep you happy with your purchase for many years to come.

As a member of the MAGNAVOX "family," you're entitled to protection by one of the most comprehensive warranties and outstanding service networks in the industry. What's more, your purchase guarantees you'll receive all the information and special offers for which you qualify, plus easy access to accessories from our convenient home shopping network.

Most importantly, you can count on our uncompromising commitment to your total satisfaction.

All of this is our way of saying welcome - and thanks for investing in a MAGNAVOX product.

P.S. To get the most from your MAGNAVOX purchase, be sure to complete and return your Product Registration Card at once.

Know these safety symbols



This "bolt of lightning" indicates uninsulated material within your unit may cause an electrical shock. For the safety of everyone in your household, please do not remove product covering.

The "exclamation point" calls attention to features for which you should read the enclosed literature closely to prevent operating and maintenance problems.

WARNING: To reduce the risk of fire or electric shock, this apparatus should not be exposed to rain or moisture, and objects filled with liquids, such as vases, should not be placed on this apparatus.

CAUTION: To prevent electric shock, match wide blade of plug to wide slot, fully insert.

ATTENTION: Pour éviter les choc électriques, introduire la lame la plus large de la fiche dans la borne correspondante de la prise et pousser jusqu'au fond.

For Customer Use

Enter below the Serial No. which is located on the rear of the cabinet. Retain this information for future reference.

Model No. _____
Serial No. _____

MAGNAVOX

Visit our World Wide Web Site at <http://www.magnavox.com>

IMPORTANT SAFETY INSTRUCTIONS

1. Read these instructions.
2. Keep these instructions.
3. Heed all warnings.
4. Follow all instructions.
5. Do not use this apparatus near water.
6. Clean only with dry cloth.
7. Do not block any ventilation openings. Install in accordance with the manufacturer's instructions.
8. Do not install near any heat sources such as radiators, heat registers, stoves, or other apparatus (including amplifiers) that produce heat.
9. Do not defeat the safety purpose of the polarized or grounding-type plug. A polarized plug has two blades with one wider than the other. A grounding type plug has two blades and a third grounding prong. The wide blade or the third prong are provided for your safety. If the provided plug does not fit into your outlet, consult an electrician for replacement of the obsolete outlet.
10. Protect the power cord from being walked on or pinched, particularly at plugs, convenience receptacles, and the point where they exit from the apparatus.
11. Only use attachments/accessories specified by the manufacturer.

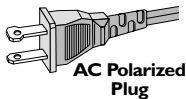

12.  Use only with the cart, stand, tripod, bracket, or table specified by the manufacturer or sold with the apparatus. When a cart is used, use caution when moving the cart/apparatus combination to avoid injury from tip-over.
13. Unplug this apparatus during lightning storms or when unused for long periods of time.
14. Refer all servicing to qualified service personnel. Servicing is required when the apparatus has been damaged in any way, such as power-supply cord or plug is damaged, liquid has been spilled or objects have fallen into the apparatus, the apparatus has been exposed to rain or moisture, does not operate normally, or has been dropped.
15. Battery usage **CAUTION** – To prevent battery leakage which may result in bodily injury, property damage, or damage to the unit:
 - Install **all** batteries correctly, **+** and **-** as marked on the unit.
 - Do not mix batteries (**old** and **new** or **carbon** and **alkaline**, etc.).
 - Remove batteries when the unit is not used for a long time.
16. Apparatus shall not be exposed to dripping or splashing.
17. Do not place any sources of danger on the apparatus (e.g. liquid filled objects, lighted candles).
18. This product may contain lead and mercury. Disposal of these materials may be regulated due to environmental considerations. **For disposal or recycling information, please contact your local authorities or the Electronic Industries Alliance : www.eiae.org.**

EL 6475-E005: 04/01

Canada

English:

This digital apparatus does not exceed the Class B limits for radio noise emissions from digital apparatus as set out in the Radio Interference Regulations of the Canadian Department of Communications.

Français:

Cet appareil numérique n'émet pas de bruits radioélectriques dépassant les limites applicables aux appareils numériques de Class B prescrites dans le Règlement sur le Brouillage Radioélectrique édicté par le Ministère des Communications du Canada.

This warning label is located on the rearside and inside this laser product.

CAUTION INVISIBLE LASER RADIATION WHEN OPEN. DO NOT STARE INTO BEAM.
DANGER INVISIBLE LASER RADIATION WHEN OPEN. AVOID DIRECT EXPOSURE TO BEAM.
VARO! AVATTAESSA JA SUOJALLUKITUS OHITETTAESSA OLET ALTTIINANÄKYMÄTTÖMÄLLE LASERSÄTEILYLLE. ÄLÄ KATSO SÄTEESEEN.
WARNING! OSYNYLIG LASERSTRÅLNING NÄR DENNA DEL ÄR ÖPPNAD. OCH SPÄRREN ÄR URKÖPPLAD. BETRÄKTA EJ STRÅLEN.

or

DANGER - Invisible laser radiation when open. AVOID DIRECT EXPOSURE TO BEAM.

For Customer Use:

Read carefully the information located at the bottom or rear of your DVD Recorder and enter below the Serial No. Retain this information for future reference.

Model No. MRV 660

Serial No. _____

Class II equipment symbol



This symbol indicates that the unit has a double insulation system



Manufactured under license from Dolby Laboratories. "Dolby" and the double-D symbol are trademarks of Dolby Laboratories.

CAUTION

Use of controls or adjustments or performance of procedures other than herein may result in hazardous radiation exposure or other unsafe operation.

'CONSUMERS SHOULD NOTE THAT NOT ALL HIGH DEFINITION TELEVISION SETS ARE FULLY COMPATIBLE WITH THIS PRODUCT AND MAY CAUSE ARTIFACTS TO BE DISPLAYED IN THE PICTURE. IN CASE OF 525 OR 625 PROGRESSIVE SCAN PICTURE PROBLEMS, IT IS RECOMMENDED THAT THE USER SWITCH THE CONNECTION TO THE 'STANDARD DEFINITION' OUTPUT. IF THERE ARE QUESTIONS REGARDING OUR TV SET COMPATIBILITY WITH THIS MODEL 525p AND 625p DVD PLAYER, PLEASE CONTACT OUR CUSTOMER SERVICE CENTER.'

LASER

Type	Semiconductor laser InGaAlP (DVD) AlGaAs (CD)
Wave length	658 nm (DVD) 790 nm (CD)
Output Power	30 mW (DVD+RW write) 1.0 mW (DVD read) 1.0 mW (CD read)
Beam divergence	84 degrees (DVD) 61 degrees (CD)

Declaration of Conformity

Model MRV 660
Trade Name Magnavox
Responsible Party Philips Consumer Electronics North America
P.O. Box 671539
Marietta, GA 30006-0026
1-800-705-2000

Special Functions

Your DVD recorder has a number of special functions that will make day-to-day use of your new DVD recorder easier for you.



Using the 'Digital Photo Manager', you can view and modify JPEG pictures from a Picture CD, DVD, or a CD ROM. You can create slide shows and play them on a DVD player.



This product incorporates copyright protection technology that is protected by method claims of certain US patent and other intellectual property rights owned by Macrovision Corporation and other rights owners. Use of this copyright protection technology must be authorized by Macrovision Corporation, and is intended for home and other limited viewing uses only unless otherwise authorized by Macrovision Corporation. Reverse engineering or disassembly is prohibited.
(U.S. Patent Number 4,631,603, 4,577,216, 4,819,098 and 4,907,093, 5,315,448 and 6,516,132.)

Safe Record

This feature is only available for DVD+RW only. By holding down the REC button, the recording will be made at the end of all other recordings. This helps to avoid overwriting previous recordings.



This connection is also known as 'FireWire' and 'IEEE 1394.' This connection is used for the transfer of high bandwidth digital signals as used by digital video (DV) camcorders. Audio and video signals are transmitted using a cable.

Table of Contents

Special Functions	5	Front Panel	23
Care and Safety Information		Jacks behind the flap	23
Setup	8	Installing the DVD Recorder	
Cleaning discs	8	First Installation	24-25
About recycling	8	TV channel programming	26
General Information		Automatic TV channel search	26
Introduction	9	Setting favorite TV channels	26
Accessories supplied	9	Selecting the channel input signal	27
Region codes	9	Setting the time and date	28
Connecting to TV		Manual time/date settings	28
General	10	Automatic time/date settings	28
Selecting a suitable connection		Setting the language	29
to your TV	10	Playback	
Setting the TV to the correct video in		Playable discs	30
channel	10	Inserting a disc	30
Option 1 : Using Y Pb Pr jacks	11-12	Starting disc playback	31
Option 2 : Using S-Video (Y/C) jack	13	Playing a DVD video disc	31
Option 3 : Using Video (CVBS) jack	14	Playing (Super) Video CDs	31
Option 4 : Using Antenna jack only	15	Playing an audio CD	31
Connecting to Additional		Playing a DVD+R(W) disc	32
Devices		Playing an MP3 CD	32
Using the input jacks (IN-EXT 1		Playing a picture disc (slide show)	32
or IN-EXT2)	16	Playable JPEG picture disc	32
Connecting a Satellite Receiver/		Additional Playback Features	
Cable Box	16	Using Toolbar options	33
Connecting a VCR/DVD player	17	Time search	33
Connecting a camcorder to the		Changing subtitle language	33
front jacks	18	Changing audio soundtrack language	34
Option 1: Using DV In jack	18	Switching camera angles	34
Option 2: Using S-VIDEO In or		Zooming in	34
VIDEO In jack	18	Changing to another title/chapter/	
Using analog audio output jacks	19	track	35
Using digital audio output jacks	19	Searching forwards/backwards	35
Remote Control	20-21	Pausing playback / slow motion play	35
Inserting batteries	22	Selecting various play mode	36
Using the remote control to operate		Repeat play	36
the system	22	Repeating a specific segment (A-B)	36
Using the alphanumeric keypad to		Shuffle play	36
enter the characters	22	Scan disc	36

Table of Contents

Recording

Discs for recording	37
Recording settings	37
Recording mode	38
Recording language	38
Inserting chapter markers	38
Filter mode	39
Manual recording	39-40
Manual recording with automatic turn-off (one touch recording)	40
Deleting a recording	40

Timer Recording

Introduction	41
Programming recordings	41-42
Programming recording from a Satellite Receiver/Cable Box	42
Changing a programmed recording	43
Deleting a programmed recording	43

Editing/Finalizing Recording

About editing	44
Color coded buttons functions	44
Index Picture screen	44
Changing the disc/title name	45
Making the editing compatible (DVD+RW)	45
Playing your recording on other DVD player (DVD+R)	45
Video editing	46
Hiding unwanted chapter	46
Editing chapter (merge/split/hide)	47
Editing title (divide/append/ index picture)	47-48
Deleting chapter markers	48
Photo editing	48

Using the Browser

Browsing the disc	49
Color coded buttons functions	49
Browsing the picture disc	50
Adding pictures to an album	50
Changing the picture order within an album	51
Deleting an album	51
Deleting picture in an album	51
Changing the slide show settings	52

System Menu - Preferences

Accessing the Preferences options	53
Recording	53
Sound	53
Disc	54
Access	54
Features	54

System Menu - Setup

Accessing the Setup options	55
System	55-56
Time-date	56
Analog channels	56
Video output	56-57
Audio output	57
Language	57

Setting Access Control

About Access Control	58
Setting or changing the pin code	58
Setting the country of origin	58
Activating/Deactivating the child lock ..	59
Authorizing discs	59
Restricting playback by Parental Control	60

Specifications

.....	61
-------	----

Troubleshooting

.....	62-65
-------	-------

Display panel symbols/ messages

.....	66-67
-------	-------

Glossary

.....	68
-------	----

Care and Safety Information

CAUTION!

High voltage! Do not open.
You run the risk of getting an electric shock.

The machine does not contain any user-serviceable parts. Please leave all maintenance work to qualified personnel.

Setup

Finding a suitable location

- Place the set on a flat, hard and stable surface. Do not place the set on a carpet.
- Do not position the set on top of other equipment that might heat it up (e.g., receiver or amplifier).
- Do not put anything under the set (e.g., CDs, magazines).

Space for ventilation

- Place the apparatus in a location with adequate ventilation to prevent internal heat build up. Allow at least 10 cm (4.5") clearance from the rear and the top of the set and 5 cm (2.3") from the left and right to prevent overheating.

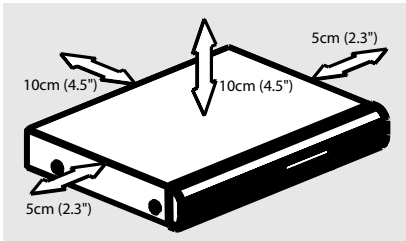

Avoid high temperatures, moisture, water and dust

- Apparatus shall not be exposed to dripping or splashing.
- Do not place any sources of danger on the apparatus (e.g., liquid filled objects, lighted candles).

Cleaning discs

Some problems occur because the disc inside the recorder is dirty (frozen picture, sound disruptions, picture distortions). To avoid these problems, discs should be cleaned on a regular basis.

To clean a disc, use a micro fibre cleaning cloth and wipe the disc from the center to the edge in a straight line.

CAUTION!

Do not use solvents such as benzene, thinner, commercially available cleaners, or anti-static sprays intended for discs.

Since the optical unit (laser) of the DVD recorder operates at a higher power than regular DVD or CD players, cleaning CDs intended for DVD or CD players may damage the optical unit (laser). Therefore, refrain from using a cleaning CD.

About recycling

These operating instructions have been printed on non-polluting paper. This electronic equipment contains a large number of materials that can be recycled. If you are disposing of an old machine, please take it to a recycling center. Please observe the local regulations regarding disposal of packaging materials, exhausted batteries, and old equipment.

General Information

Introduction

Your DVD recorder allows you to record the TV programs or duplicate camcorder recordings to a DVD+RW or DVD+R and play pre-recorded DVDs. The recordings you make on the Recorder will play on some DVD players and DVD-ROM drives. The DVD+R discs have to be finalized before they can be played on other DVD players.

Please take the time to read this user manual before using your DVD recorder. It contains important information and notes regarding operation.

Helpful Hints:

- *If you have questions or if problems come up during operation, please see the chapter 'Troubleshooting'.*
- *If you need further assistance, please call the customer support service for your country. The corresponding telephone numbers and e-mail addresses are given in the guarantee booklet.*

Accessories supplied

- Remote control and batteries
- Audio/Video (AV) cables
- Antenna cable
- Quick Use Guide

Region codes

DVD films are usually not released at the same time in all regions of the world, thus all DVD players are keyed to a specific region code.

This device will only play **Region 1** DVDs or DVDs manufactured to be played in all regions ('ALL'). DVDs from other regions cannot be played on this DVD recorder.



Connecting to TV

General

The necessary cable connections must be made before you can record or playback TV programs using your DVD recorder.

Selecting a suitable connection to your TV

When you install your DVD recorder for the first time, select **one** of the following options to connect the DVD recorder and your TV.

- **Option 1: Using Y Pb Pr jacks**
Select this if your TV is equipped with component video jacks. It provides the best picture quality (see pages 11~12.)
- **Option 2: Using S-Video (Y/C) jack**
Select this if your TV is equipped with a S-Video (SVHS) jack. It provides excellent picture quality (see page 13.)
- **Option 3: Using Video (CVBS) jack**
Select this if your TV is equipped with a Video (CVBS) jack. It provides good picture quality (see page 14.)
- **Option 4: Using Antenna In jack**
Select this if your TV is equipped with an Antenna In jack only (see page 15.)

Setting the TV to the correct video in channel

- ① Press **STANDBY-ON**  on the DVD recorder to turn it on.
- ② Turn on the TV and set it to the correct video-in channel. You should see the blue DVD background screen or the first installation screen on the TV.
 - Usually this channel is between the lowest and highest channels and may be called FRONT,A/V IN,VIDEO. See your TV's manual for more details.
 - Or, you may go to channel 1 on your TV, then press the Channel down button repeatedly until you see the Video In channel.
 - Or, the TV remote control may have a button or switch that chooses different video modes.
 - Or, set the TV to channel 3 or 4 if you are using an RF modulator.

If the TV shows a blank screen or distorted picture,

it may be due to the DVD recorder's video output setting does not match with the video connection. You can reset the system as below :

- ① Disconnect the DVD recorder's ~**MAINS** from the power supply.
- ② Press and hold  while you reconnect it's ~ **MAINS** to the power supply.

IMPORTANT!

When you complete the connections and turn on the DVD recorder for the first time, you must complete the First Installation. This set up TV channels, menu languages and other features (see pages 24~25.)

Option 1: Using Y Pb Pr jacks

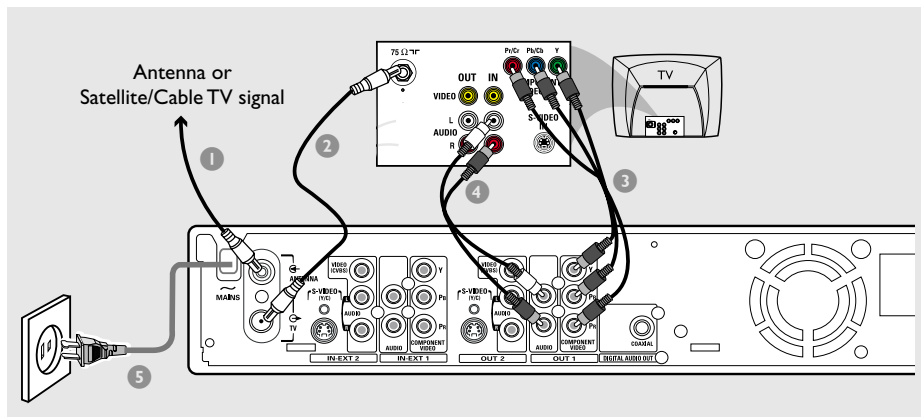

The Component Video (Y Pb Pr) method of transmitting pictures produces the highest quality as the video signal is split into its Y (brightness), Pb and Pr (blue minus brightness, red minus brightness) components. The signals are transmitted via separate cables. The cables and the associated jacks are mostly colored red, green and blue.

Have the following cables ready:

- 1) Antenna cable
 - 2) Component video cable (red/green/blue, not supplied)
 - 3) Audio cables (red/white)
- 1 Turn off your TV and remove the antenna cable from your TV (or Satellite Receiver/Cable Box.) Insert it to the **ANTENNA** input jack at the back of the DVD recorder.
 - 2 Use the supplied antenna cable to connect the DVD recorder's **TV** output jack to the antenna input jack at the back of your TV set.

- 3 Use the component video cable to connect the DVD recorder's **COMPONENT VIDEO (OUT 1)** jacks to the corresponding component video input jacks (or labeled as YUV or Y Pb/Cb Pr/Cr) at the back of your TV set.
- 4 Use an audio cable (red/white) to connect the DVD recorder's **AUDIO L/R (OUT 1)** jack to the audio input jack at the back of your TV set (or labeled as AV In or Audio In.)
- 5 Connect the power cable from the DVD recorder's **~ MAINS** to the power supply.
- 6 Press **STANDBY-ON**  on the DVD recorder to turn it on.
→ The message 'IS THE TV ON?' appears on the display panel.
- 7 Turn on the TV power. Select the correct Video In channel at the TV (see page 10.)
→ The first installation menu { **Language and Country** } will appear on the TV.
- 8 Proceed to **page 24** to continue the first installation.

Connecting to TV (cont'd)

IMPORTANT!

- The progressive scan video quality is only available through Y Pb Pr connection and a progressive TV is required. Turn on the progressive scan feature after complete the first installation (see page 24.)
- Before enabling the progressive scan function, you must ensure that your TV progressive scan function is turned on (refer to your TV owner's manual.)

Helpful Hint:

- To switch between interlaced and progressive scan output, press and hold ◀◀ while reconnect its ~ MAINS to the power supply. The display panel will show "Progressive Scan" if the progressive scan function is enabled.

Option 2 : Using S-Video (Y/C) jack

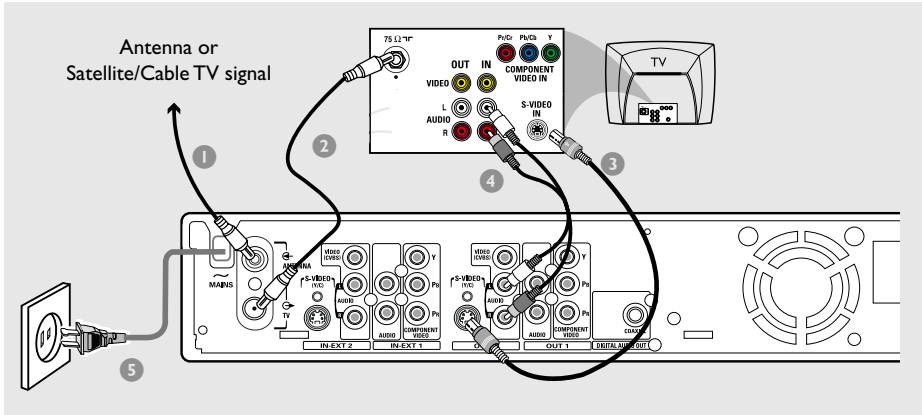

This connecting cable, also known as the SVHS cable, is used to transmit the brightness signal (Y signal) and color signal (C signal) separately. This mini DIN jack is also called a Hosiden jack.

Have the following cables ready:

- 1) Antenna cable
 - 2) S-Video (SVHS) cable (not supplied)
 - 3) Audio cables (red/white)
- 1 Turn off your TV and remove the antenna cable from your TV (or Satellite Receiver/ Cable Box.) Insert it to the **ANTENNA** input jack at the back of the DVD recorder.
 - 2 Use the supplied antenna cable to connect the DVD recorder's **TV** input jack to the antenna input jack at the back of your TV set.
 - 3 Use an S-Video (SVHS) cable to connect the DVD recorder's **S-VIDEO (Y/C) (OUT 2)** jack to the S-Video In jack at the back of your TV set (or labeled as S-Video In or SVHS.)

- 4 Use an audio cable (red/white) to connect the DVD recorder's **AUDIO L/R (OUT 2)** jack to the audio input jack at the back of your TV set (or labeled as AV In or Audio In.)
- 5 Connect the power cable from the DVD recorder's **~ MAINS** to the power supply.
- 6 Press **STANDBY-ON**  on the DVD recorder to turn it on.
→ The message 'IS THE TV ON?' appears on the display panel.
- 7 Turn on the TV power. Select the correct Video In channel at the TV (see page 10.)
→ The first installation menu { **Language and Country** } will appear on the TV.
- 8 Proceed to **page 24** to continue the first installation.

Connecting to TV (cont'd)

Option 3 : Using Video (CVBS) jack

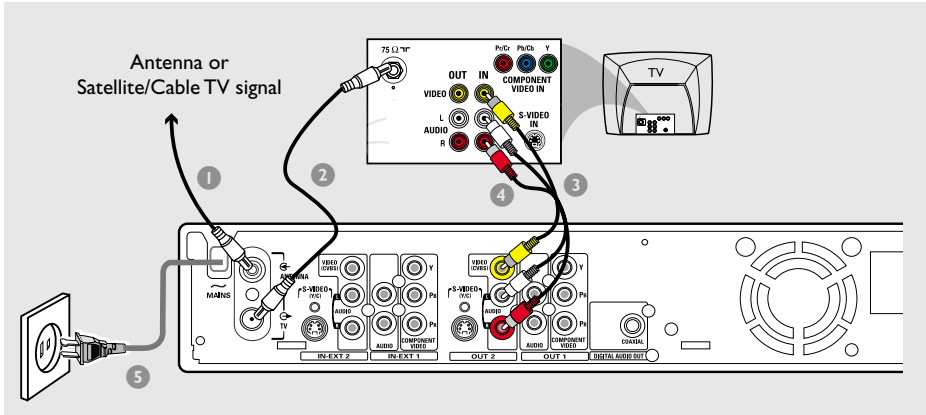

This cable, usually featuring yellow cinch plugs, is used for transmitting the Composite Video signal (FBAS, CVBS.) In this method of transmission, the color signal and the brightness signal are transmitted on the same cable.

Have the following cables ready:

- 1) Antenna cable
 - 2) AV cables (yellow/red/white)
- 1 Turn off your TV and remove the antenna cable from your TV (or Satellite Receiver/Cable Box.) Insert it to the **ANTENNA** input jack at the back of the DVD recorder.
 - 2 Use the supplied antenna cable to connect the DVD recorder's **TV** output jack to the antenna input jack at the back of your TV set.
 - 3 Use the supplied AV cables (yellow plug) to connect the DVD recorder's **VIDEO (CVBS) (OUT 2)** jack to the Video In jack at the back of your TV set (or labeled as Video In, AV In or Composite.)

- 4 Use the supplied AV cables (red/white plugs) to connect the DVD recorder's **AUDIO L/R (OUT 2)** jack to the audio input jack at the back of your TV set (or labeled as AV In or Audio In.)
- 5 Connect the power cable from the DVD recorder's ~ **MAINS** to the power supply.
- 6 Press **STANDBY-ON**  on the DVD recorder to turn it on.
→ The message 'IS THE TV ON?' appears on the display panel.
- 7 Turn on the TV power. Select the correct Video In channel at the TV (see page 10.)
→ The first installation menu { **Language and Country** } will appear on the TV.
- 8 Proceed to **page 24** to continue the first installation.

Option 4 : Using Antenna jacks only

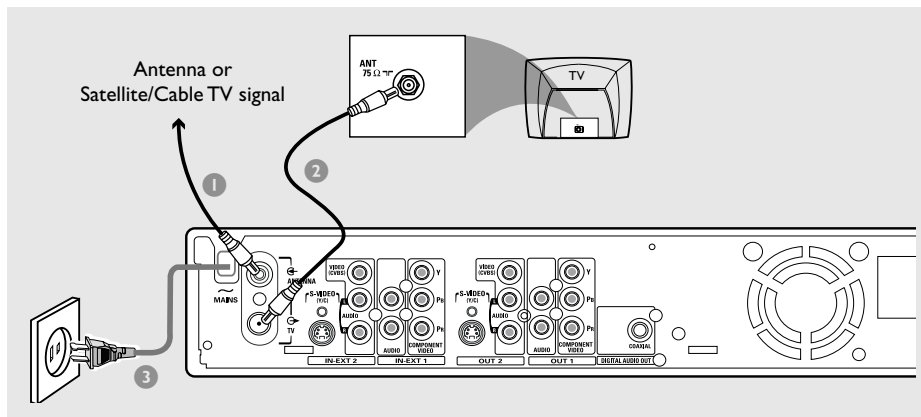

Use this connection only if your TV set has a single **Antenna In** jack and does not have any audio/video jacks. For this type of connection, you need to set the channel of the TV set to follow that of the DVD recorder.

Have the following cable ready:

- 1) Antenna cable

- 1 Turn off your TV and remove the antenna cable from your TV (or Satellite Receiver/Cable Box.) Insert it to the **ANTENNA** input jack at the back of the DVD recorder.
- 2 Use the supplied antenna cable to connect the DVD recorder's **TV** output jack to the antenna input jack at the back of your TV set.
- 3 Connect the power cable from the DVD recorder's ~ **MAINS** to the power supply.

- 4 Press **STANDBY-ON**  on the DVD recorder to turn it on.
→ The message 'IS THE TV ON?' appears on the display panel.
- 5 Turn on the TV power. Select the correct Video In channel at the TV (see page 10.)
→ To switch between channel 3 and 4, hold down button {3} or {4} on the remote control to select the respective channel.
→ The first installation menu { **Language and Country** } will appear on the TV.
- 6 Proceed to **page 24** to continue the first installation.

Helpful Hints:

- If the {LANGUAGE AND COUNTRY} menu does not appear, check the cable connections.
- To toggle between channel 3 and channel 4, you can press **▶▶** button at the DVD recorder front panel while plug in the main cord of the DVD recorder to the power supply.

Connecting to Additional Devices

English

Using the input sockets (IN-EXT 1 or IN-EXT2)

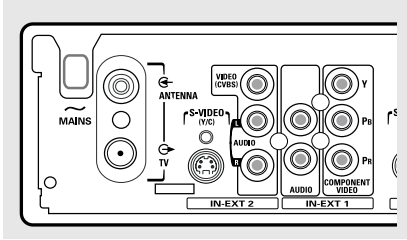

You can connect a video cassette recorder (VCR,) DVD player, decoder, satellite receiver or cable box to the input jacks at the back of the DVD recorder (**IN-EXT 1** or **IN-EXT 2**.) The possible connection is depending on the capabilities of the additional devices.

Switching between S-Video input and Video (CVBS) input takes place automatically. If both are used for connecting to external devices, the signal from S-Video socket has priority.

The **COMPONENT VIDEO (IN-EXT1)** jacks are designed only for 'interlaced' signals. Progressive Scan input signals cannot be processed by the DVD recorder.

Connecting a Satellite Receiver/ Cable Box

- 1 If your Satellite Receiver/Cable Box has only a single antenna output (RF OUT or TO TV,) use the antenna cable to connect it with the **ANTENNA** input jack at the back of the DVD recorder.

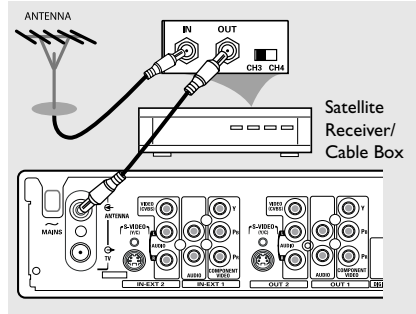

- 2 For complete connection to your TV set, see pages 11~15 for details.
- Alternatively, you can connect it to the **VIDEO (CVBS)** (or S-VIDEO (Y/C)) and **AUDIO L/R** input jacks at the back of the DVD recorder if your Satellite Receiver/Cable Box has the same output jacks.
 - To watch/record the programs, press **TUNER** on the remote control, then press **▲ ▼** to select '**EXT 1**' as the input channel.

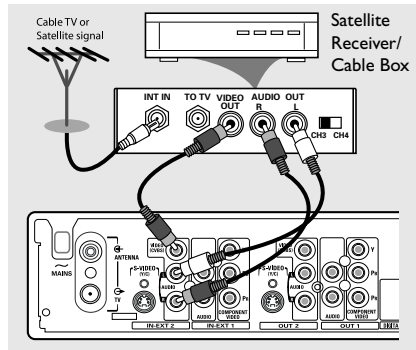

Connecting Additional Devices (cont'd)

Connecting a VCR/DVD player

You will need this connection if you want to record the video tapes or discs to a DVD+R(W)s.

Option 1

- 1 Use a component video cable (red/green/blue) to connect the DVD recorder's **COMPONENT VIDEO (IN-EXT1)** input jacks to the corresponding component video output jacks on the VCR/DVD player.
- 2 Use an audio cable (red/white) to connect the DVD recorder's **AUDIO L/R (IN-EXT1)** input jacks to the audio output jack on the VCR/DVD player.

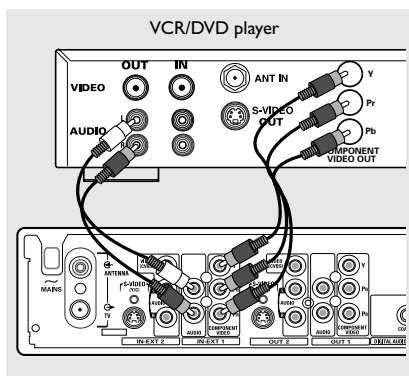

Before you start operating, press **TUNER** on the remote control, then press **▲ ▼** to select 'EXT 1' as the input channel. For recording, see pages 39~40.

Option 2

- 1 Use a S-video cable to connect the DVD recorder's **S-VIDEO (Y/C) (IN-EXT2)** input jack to the corresponding S-VHS output jack on the VCR/DVD player (as shown on the below illustration.)
OR
Use a video (CVBS) cable to connect the DVD recorder's **VIDEO (CVBS) (IN-EXT2)** input jack to the corresponding video output jack on the VCR/DVD player.
- 2 Use an audio cable (red/white) to connect the DVD recorder's **AUDIO L/R (IN-EXT2)** input jacks to the audio output jack on the VCR/DVD player.

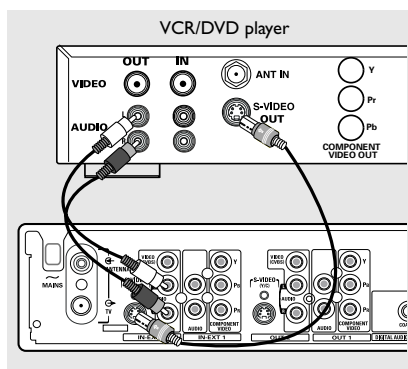

Before you start operating, press **TUNER** on the remote control, then press **▲ ▼** to select 'EXT 2' as the input channel. For recording, see pages 39~40.

Helpful Hints:

- Most prerecorded video cassettes and DVDs are copy-protected. If you try to copy them, the message 'COPY PRO' appears on the display panel.
- Connect the DVD recorder directly to the TV set. If there is a video recorder or an additional device in between, the picture quality may be poor because of the copy protection system built into the DVD recorder.

Connecting Additional Devices (cont'd)

Connecting a camcorder to the front jacks

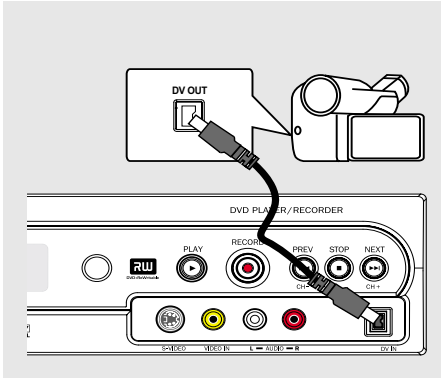

You can use the front jacks to copy camcorder recordings.

Option 1: Using DV IN jack

Use this connection if you have a Digital Video or Digital 8 camcorder. The DV jack will conform to the i.LINK standard. It provides the best picture quality.

- Use an i.LINK 4-pin cable to connect the DVD recorder's **DV IN** jack to the appropriate DV output jack on the camcorder.

Before you start operating, select 'CAM 2' as the input channel.
For recording, see pages 39~40.

Helpful Hints:

- The DV IN jack does not support connection to a Personal Computer.
- The DV jack on this recorder can only receive input signals, it cannot output signals.

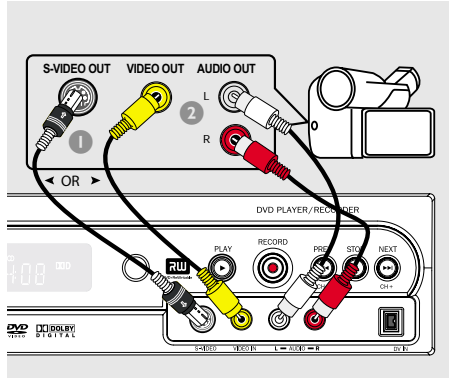

Option 2: Using S-VIDEO In or VIDEO In jack

Use S-VIDEO connection if you have a Hi8 or S-VHS(C) camcorder. It provides very good picture quality.

Alternatively, you can use VIDEO connection if your camcorder has only a single video output (Composite Video, CVBS.) It provides good picture quality.

- 1 Use a S-video cable to connect the DVD recorder's **S-VIDEO** input jack to the appropriate S-VHS output jack on the camcorder.

OR

Use a video cable (yellow plug) to connect the DVD recorder's **VIDEO** input jack to the appropriate video output jack on the camcorder.

- 2 Use an audio cable (red/white) to connect the DVD recorder's **AUDIO L/R** input jack to the audio output jack on the camcorder.

Before you start operating, select 'CAM 1' as the input channel.
For recording, see pages 39~40.

Connecting to Additional Devices (cont'd)

Using analog audio output jacks

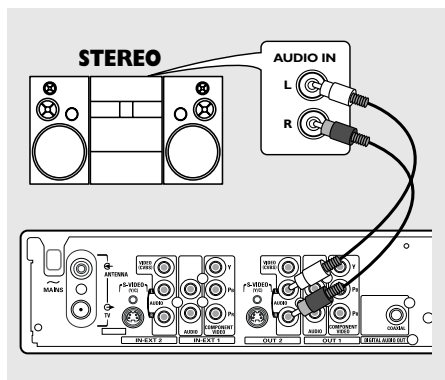

You can connect the DVD recorder to a two channel stereo system or receiver in order to enjoy the stereo sound system.

- Use an audio cable to connect **AUDIO L/R (OUT 2)** (red/white) jacks to one of the following devices with the same input jacks :
 - a stereo system (for example, mini system or TV)
 - a receiver with Dolby Surround Pro Logic
 - a receiver with two channel analog stereo

Before you start operating, set the Analog Output accordingly (see page 53.)

Choose a sound mode setting that is most compatible with the connected devices.

CAUTION!

Do not use the 'Phono' input on an amplifier to connect to the DVD recorder. This input jack is designed only for record players without preamplifiers. The DVD recorder or the amplifier may be damaged as a result.

Using digital audio output jacks

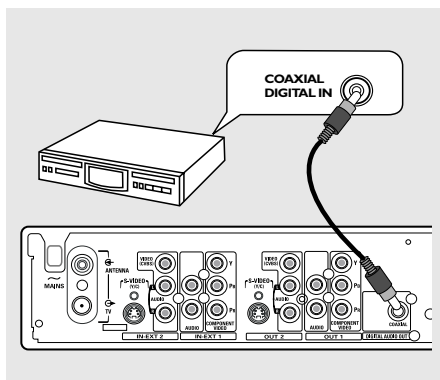

You can connect the DVD recorder to an A/V receiver or amplifier in order to enjoy the home theater system's surround sound capabilities.

- Use a coaxial cable to connect **COAXIAL** jack to one of the following devices with the same input jack:
 - an A/V receiver or an A/V amplifier with a digital multi-channel sound decoder
 - a receiver with two channel digital stereo (PCM)

Before you start operating, set the Digital Output accordingly (see page 57.) If the Digital Output setting does not match your stereo's capabilities, the stereo may produce a strong, distorted sound or no sound at all.

Helpful Hints:

- Digital multi-channel sound offers the best possible sound quality. You will need a multi-channel A/V receiver or amplifier that supports at least one of the audio formats of the DVD recorder (MPEG2, Dolby Digital.) See your receiver's manual for details.
- Playback in six-channel digital surround sound is only possible if the receiver has a digital multi-channel sound decoder.

Remote Control

English

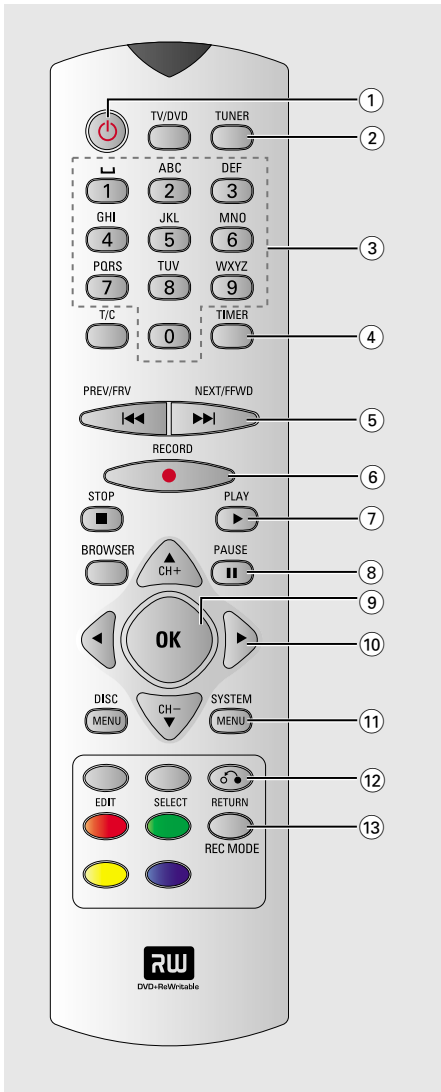

- ① **STANDBY-ON**
- Turn on or off the DVD recorder.
- ② **TUNER**
- Switch to TUNER mode.

- ③ **Alphanumeric keypad**
 - Enter numbers or letters in appropriate entry fields.
 - Select a chapter/track number to play.
 - Select a TV channel while in internal tuner mode.
- ④ **TIMER**
 - Access or exit the timer recording menu.
- ⑤ **◀▶**
 - Skip to previous or next Chapter/Track.
 - Holding down the button for fast reverse or fast forward function.
- ⑥ **RECORD ●**
 - Start recording the current TV channel or the current video input source.
- ⑦ **PLAY ▶**
 - Play a disc.
- ⑧ **PAUSE II**
 - Pause the playback or recording.
 - Press repeatedly to advance a paused picture one frame at a time.
- ⑨ **OK**
 - Store or confirm an entry.
- ⑩ **◀▶**: Cursor buttons for moving to the left or right.
▲▼: Cursor buttons for moving up/down or change TV channel at the recorder in Tuner mode.
- ⑪ **SYSTEM-MENU**
 - Access or exit the system menu.
- ⑫ **RETURN**
 - Return to the previous menu on a video CD (VCD) or some DVDs.
- ⑬ **REC MODE**
 - Select a recording speed : M2, M2x, M3, M4, M6 or M8. This determines the quality of the recording and the amount/ length of time you can record on a DVD+R(W).

Remote Control (cont'd)

14 TV/DVD

- Switch between the DVD recorder and the antenna signal. This function operates when the DVD recorder is connected to the TV with only an antenna cable.

15 T/C (Title/Chapter)

- Select a 'T'(title)'/ 'C'(chapter) directly on the menu bar.

16 STOP ■

- Stop playback/recording.
- Holding down the button will open and close the disc tray.

17 BROWSER

- Display the on-screen Media Browser that allows you to browse through and manage the contents stored in the current disc.

18 DISC-MENU

- Access to DVD's disc menu or Index Picture screen of a DVD+R(W.)

19 SELECT

- Select a function.
- Toggle between upper and lower case characters while using the alphanumeric keypad.

20 EDIT

- Access or exit the edit menu.

21 Color coded buttons

- A number of functions are available via the color coded button. These functions are displayed in the bottom of the on-screen menu wherever applicable.

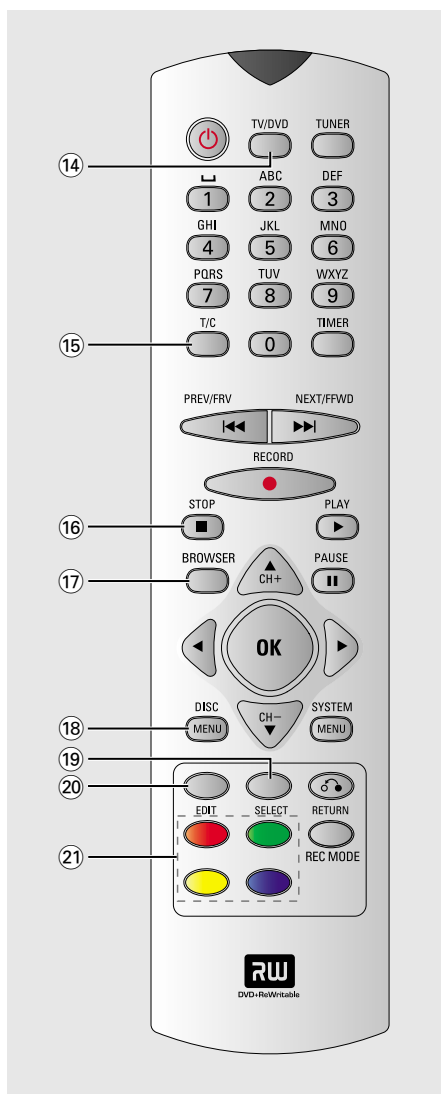

Remote Control (cont'd)

English

Inserting Batteries

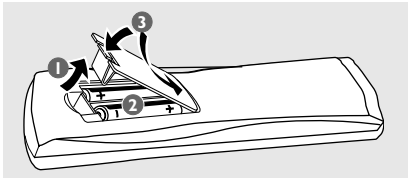

- 1 Open the battery compartment.
- 2 Insert two batteries type R03 or AAA, following the indications (+ -) inside the compartment.
- 3 Close the cover.

Caution!

- Remove batteries if they are exhausted or if the remote is not to be used for a long time.
- Do not use old and new or different types of batteries in combination.
- Batteries contain chemical substances, so they should be disposed of properly.

Using the remote control to operate the system

- 1 Aim the remote control directly at the remote sensor (iR) on the front panel.
- 2 Select the source you wish to control by pressing one of the source select buttons on the remote control (for example TV, TUNER.)
- 3 Then select the desired function (for example ◀◀, ▶▶!).

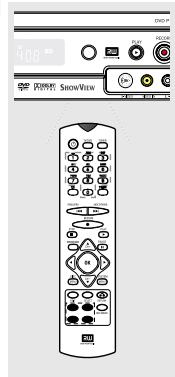

Using the alphanumeric keypad to enter the characters

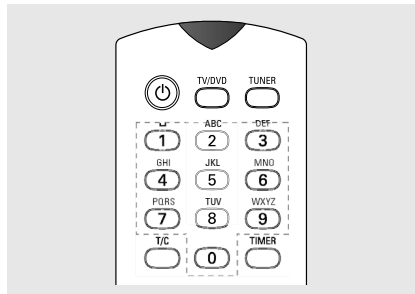

- Press a number button as often as the required character or the number appears.
- To enter language-dependent characters, press ◀◀ or ▶▶ on the corresponding character.
- To enter a space, press button {1.}

Front Panel

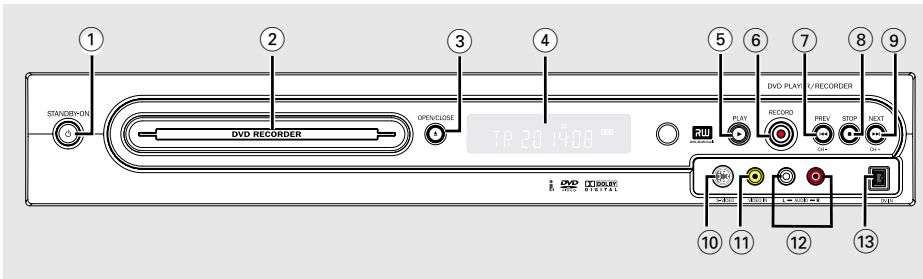

English

- ① **STANDBY-ON**
- Turn on or off the DVD recorder.
- ② **Disc tray**
- ③ **OPEN/CLOSE**
- Open or close the disc tray.
- ④ **Display panel**
- Show information about the current status of the DVD recorder.
- ⑤ **PLAY**
- Play a disc.
- ⑥ **RECORD**
- Start recording the current TV channel or the current video input source.
- ⑦ **PREV/CH-**
- Go to the previous chapter track, do a reverse search, or go to the previous channel.
- ⑧ **STOP**
- Stop playback/recording.
- ⑨ **NEXT/CH+**
- Go to the next chapter track, do a forward search, or go to the next channel.

- ⑩ **S-VIDEO**
- S-video input for SVHS/Hi8 camcorders or SVHS/Hi8 video recorders (input channel number 'CAM 1'.)
- ⑪ **VIDEO**
- Video input for camcorders or video recorders (input channel number 'CAM 1'.)
- ⑫ **L/R AUDIO**
- Audio input for camcorders or video recorders (input channel number 'CAM 1'.)
- ⑬ **DV IN**
- Input for digital camcorders or other suitable devices using this connector (input channel number 'CAM 2'.)

Installing the DVD Recorder

First Installation

The First Installation menu will appear the very first time you turn on the DVD recorder. These settings will help you set up the basic DVD recorder features easily, including TV channels and language options.

IMPORTANT!

- You have to turn on your TV and select the correct Video In channel to see the First Installation menu.
- You have to complete the First Installation before you start operating the DVD recorder.

- 1 Press **STANDBY-ON**  to turn on the DVD recorder.
→ The { **Language and Country** } menu appears on the TV.

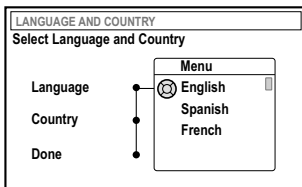

- 2 Select { **Language** } and press **▶**.
- 3 Press **▲▼** to select the desired language for the on-screen display (OSD) menu, then press **◀** to confirm.
- 4 Press **▼** to select { **Country** } and press **▶** to enter the selection field.
- 5 Press **▲▼** to select the country of your residence, then press **◀** to confirm.

- 6 Press **▼** to select { **Done** } and press **OK** to continue.
→ The { **TV Shape** } menu appears on the TV.

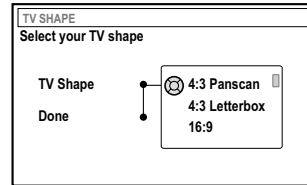

- 7 Select { **TV Shape** } and press **▶**.



16:9



4:3 Letterbox

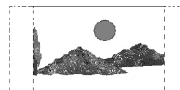

4:3 Panscan

- 8 Press **▲▼** to select the desired TV screen format, then press **◀** to confirm.
→ The format you selected will only be used if you insert a DVD that contains the same format.
- 9 Press **▼** to select { **Done** } and press **OK** to continue.
→ The { **Channel Search** } menu appears on the TV.

TIPS: Press **OK** to exit the initial installation menu.
Press **RETURN** to go back to previous menu item.

Installing the DVD Recorder (cont'd)

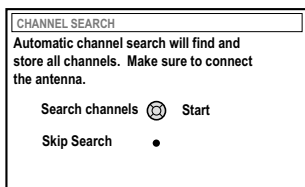

Note: Make sure you have successfully made all the required connections to the DVD recorder, the TV and Satellite Receiver/Cable Box (if any) and switched them on. The automatic channel search will detect the signals and save all the available program channels.

- 10 Press **OK** again to start automatic TV channel search.
- 11 When TV channel search is complete, press **OK** to continue.
→ The { **Time and Date** } menu appears on the TV.

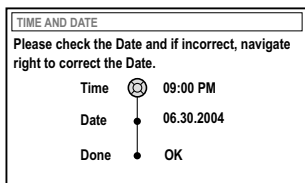

- 12 Check if the information on the menu is correct.
→ If required changes, follow steps 4~8 of “Setting the time and date” on page 28.
- 13 Press **▼** to select { **Done** } and press **OK** to save the changes.

The DVD recorder is ready for use!

Helpful Hints:

- If the DVD recorder cannot find any TV stations, select program number {1} on the TV set or check the cable connection from the antenna jack to the DVD recorder and TV set.
- If the sound or picture is distorted on any of the stored TV channels, see pages 26~27 “TV channel programming” for manual TV search.

TIPS: Press **OK** to exit the initial installation menu.
Press **RETURN** to go back to previous menu item.

Installing the DVD Recorder (cont'd)

TV channel programming

Although the DVD recorder selects available TV channels during first installation, you may want to repeat the process later if more channels become available in your area or if you are reinstalling the DVD recorder.

Automatic TV channel search

This will erase and replace all previously stored TV channels.

- 1 Press **SYSTEM-MENU** on the remote control.
→ The system menu appears on the TV.
- 2 Press ▼ repeatedly to select { **Set-up .** }
- 3 Press ► repeatedly to select { **Analog Ch.** }

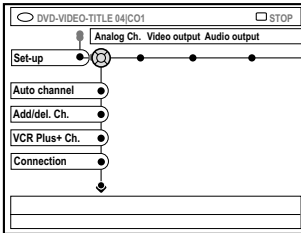

- 4 Press ▼ to select { **Auto channel** } and press ► to confirm.
→ The automatic TV channel search starts. This allows the DVD recorder to save all available TV channels.
→ This process may take several minutes. Once complete, the total number of channels found appears on the TV.

Setting favorite TV channels

You can set your favorite TV channels for quick access by using the channel up/down button on the remote control.

- 1 Press **SYSTEM-MENU**.
→ The system menu appears on the TV.
- 2 Press ▼ repeatedly to select { **Set-up .** }
- 3 Press ► repeatedly to select { **Analog Ch.** }
- 4 Press ▼ repeatedly to select { **Add/del. Ch.** } and press ► to confirm.
→ A list of TV channel programs appears.

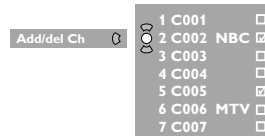

- 5 Press ▲ ▼ to select the TV channel, then press **OK** to choose delete from or add to the list.
→ The 'add' channels are 'marked,' you can access these channels by pressing ▲ ▼ on the remote control.
→ The 'delete' channels are 'unmarked,' you can only access these channels by pressing the corresponding number button on the remote control.

TIPS: Press ◀ to go back to previous menu item. Press **SYSTEM-MENU** to exit the menu.

Installing the DVD Recorder (cont'd)

Selecting the channel input signal

The DVD recorder will detect whether you connected an Antenna or Cable TV signal. If you are not receiving the correct channels, you can use this function to select the type of connection you are using and allow the DVD recorder to reset the channels.

- 1 Press **SYSTEM-MENU**.
→ The system menu appears on the TV.
- 2 Press ▼ repeatedly to select { **Set-up** }.
- 3 Press ► repeatedly to select { **Analog Ch.** }.
- 4 Press ▼ repeatedly to select { **Connection** } and press ► to confirm.
- 5 Press ▲ ▼ to select the connection the TV is using.
→ { **Auto** } : Select this to enable the DVD recorder to detect the input signal automatically.
→ { **Cable** } : Select this if you have connected a cable signal.
→ { **Antenna** } : Select this if you have connected an antenna signal.
- 6 Press **OK** to confirm.
→ The TV channel search starts.

TIPS: Press ◀ to go back to previous menu item. Press **SYSTEM-MENU** to exit the menu.

Installing the DVD Recorder (cont'd)

Setting the time and date

Manual time/date settings

If the DVD recorder has not set the time and date correctly, set the clock manually by following the steps below. Manual clock setting overrides automatic clock setting.

- 1 Press **SYSTEM-MENU** on the remote control.
→ The system menu appears on the TV.
- 2 Press **▼** repeatedly to select { **Set-up** }.
- 3 Press **▶** repeatedly to select { **Time-date** }.

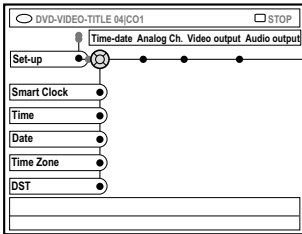

- 4 Press **▼** to select { **Time** } and press **▶** to enter the time field.
→ { **00 : 00 AM/PM** } (hours : minutes.)
- 5 Press **▲▼** to change the first digit and press **▶** to go to the next digit field.
- 6 Repeat step 5 until the time is entered correctly, then press **OK** to confirm.
- 7 Press **▼** to select { **Date** } and press **▶** to enter the date field.
→ { **00-00-0000** } (month : day : year.)
- 8 Repeat step 5 until the date is entered correctly, then press **OK** to confirm.

Automatic time/date settings

The DVD recorder can set the time and date automatically by referring to a PBS station, using the information transmitted by the selected PBS channel.

- 1 Select { **Smart Clock** } and press **▶** to confirm.
- 2 Press **▲▼** to select a PBS channel for transferring the time/date information, then press **◀** to confirm.
→ If you do not know your PBS channel number, select { **Auto** } to allow the DVD recorder to detect the channel automatically.
- 3 Press **▼** to select { **Time Zone** } and press **▶** to enter its options.
- 4 Press **▲▼** to choose your time zone and press **◀** to confirm.
→ Select { **Auto** } if you want the DVD recorder to detect the time zone automatically.
→ If the PBS channel broadcasts from a different time zone than the one in which you live, be sure to select your time zone.
- 5 Press **▼** to select { **DST** } (Daylight Saving Time) and press **▶** to enter its options.
- 6 Press **▲▼** to select an option and press **◀** to confirm.
→ The factory default setting of Daylight Saving Time is on.
→ Select { **Auto** } if you want the DVD recorder to set according to the PBS station's daylight saving time schedule.

Helpful Hint:

– If you store a TV channel that transmits PBS on program channel 'P01', the date and time will automatically be transmitted and constantly updated when in standby.

TIPS: Press **◀** to go back to previous menu item. Press **SYSTEM-MENU** to exit the menu.

Installing the DVD Recorder (cont'd)

Setting the language

You can select the language for subtitles and audio for DVD playback. For some DVDs, the subtitle/audio language can only be changed via the DVD disc menu. If the selected language is not available on the disc, the disc's default setting language will be used instead.

The menu language (on-screen display) for the system will remain as you set it.

Helpful Hint:

– For bilingual TV programs, you can switch between stereo (original) and additional language (SAP) for recording. See page 38 “Recording - Recording language.”

- 1 Press **SYSTEM-MENU** on the remote control.
→ The system menu appears on the TV.
- 2 Press ▼ repeatedly to select { **Set-up** .}
- 3 Press ► repeatedly to select { **Language** .}

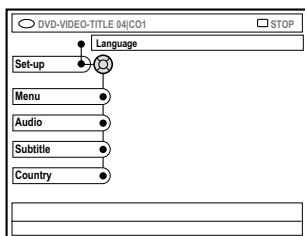

- 4 Press ▲ ▼ to select one of the options below at a time, then press ►.
 - { **Menu** }: language of the OSD menu
 - { **Audio** }: playback language
 - { **Subtitle** }: subtitle language
 - { **Country** }: location
- 5 Press ▲ ▼ to select a desired language and press ◀ to confirm.
- 6 Repeat steps 4~5 for other settings.

TIPS: Press ◀ to go back to previous menu item. Press **SYSTEM-MENU** to exit the menu.

Playback

Playable discs

Using this DVD Recorder, you can play and record on the following discs:

Recording and Playback

DVD+RW (DVD 'plus' Rewritable;) can be recorded on over and over.



DVD+R (DVD 'plus' Recordable;) can be recorded only once.



Playback only:

DVD Video (Digital Versatile Disc)



DVD-R (DVD 'minus' Recordable); can only be played back when the recording was made in 'video mode' and the recording was finalized.



DVD-RW (DVD 'minus' Rewritable); can only be played back when the recording was made in 'video mode' and the recording was finalized.



Audio CD (Compact Disc Digital Audio)



MP3-CD



Video CD (Formats 1.0, 1.1, 2.0)



Super Video CD



CD-R (CD-Recordable) Audio/MP3 contents



CD-RW (CD-Rewritable) Audio/MP3 contents



IMPORTANT!

– If the inhibit icon (error) appears on the TV screen when a button is pressed, it means the function is not available on the current disc or at the current time.

– DVD discs and players are designed with regional restrictions. Before playing a disc, make sure the disc is for the same zone as your player.

– Do not push on the disc tray or put any objects other than discs on the disc tray. It may cause the disc player to malfunction.

Inserting a disc

- 1 Press **STANDBY-ON** to turn on the DVD recorder.
- 2 Press **OPEN CLOSE** on the front of the DVD recorder.
→ The disc tray opens.
- You can also hold down the **STOP** button on the remote control to open and close the disc tray.
- 3 Carefully place the disc into the tray with the label facing up, then press **OPEN CLOSE** .
→ Make sure the disc label is facing up. For double-sided discs, load the side which you want to play facing up.
- 4 Turn on the TV power. Select the correct Video In channel at the TV.
- 5 Playback will start automatically or a dialog will appear on the TV (see next page.)

TIPS: Some discs can not be played on this DVD recorder due to the configuration and characteristics of the disc, or due to the condition of recording and authoring software.

Starting disc playback

- If a dialog appears on the TV showing :
{ Do you want to access the disc content? }
 → Select **{ Yes }** to show the disc content menu (see page 49' "Browsing the discs").
 → Select **{ No }** to switch to the last active mode.
 → If you want to remove this dialog for the next playback, you have to enable the **{ Auto play }** function (see page 54.)
- If the pin code entry dialog appears on the TV, this means that the child lock/ parental control was activated for the inserted disc (see pages 58~60.)
 → Use the alphanumeric keypad 0-9 on the remote control to enter your pin code (password.)
- For more playback features, see pages 33~36 "Additional Playback Features."

Playing a DVD video disc

Normally the DVD disc is formatted with a disc menu. You may have to make your selection (e.g., subtitle or audio language) within the disc menu.

- 1 Insert a DVD.
To access the disc menu
- Press **DISC-MENU** on the remote control. Use **alphanumeric keypad 0-9** to input your selection or use **▲ ▼** to select a play option and press **OK** to confirm.
To select the previous or next chapter/title marker
- During playback, press **T/C** on the remote to select 'Title' or 'Chapter,' then press **◀▶ / ▶▶**.
- 2 To stop playback, press **STOP ■**.

Playing a (Super) Video CDs

(Super) Video CDs may feature 'PBC' (Play Back Control). This allows you to play the video CDs interactively, following the menu on the display.

- 1 Insert a (Super) Video CD.
If the 'PBC' is on, the disc index menu will appear on the TV
- 2 Use **alphanumeric keypad 0-9** to input your selection or use **▲ ▼** to select a play option and press **OK** to confirm.
- Press **RETURN** on the remote control will return to the previous menu.
- 3 To stop playback, press **STOP ■**.

Helpful Hint:

– 'PBC' mode is turned off by default. If you want to view the disc index menu, you have to turn on the 'PBC' mode (see page 56.)

Playing an audio CD

- 1 Insert an audio CD.
 → Playback may start automatically. If not, press **PLAY ▶** to start playback.
- 2 To stop playback, press **STOP ■**.
 → The track number and total play time appear on the display panel.

Helpful Hint:

– If the TV is turned on, the Audio CD display will appear on the screen. During playback, the number of the current track will be shown on the TV screen and display panel.

TIPS: Some discs can not be played on this DVD recorder due to the configuration and characteristics of the disc, or due to the condition of recording and authoring software.

Playback (cont'd)

Playing a DVD+R(W) disc

- 1 Insert a DVD+RW or DVD+R disc.
If the disc content menu appears on the TV
- 2 Use ◀▶ ▲▼ to navigate within the menu and select a title to play, then press **PLAY ▶**.
- 3 To stop playback, press **STOP ■**.

Helpful Hint:

– If the message 'EMPTY DISC' appears on the display panel, this means that there are no recordings on this disc.

Playing an MP3 CD

- 1 Insert an MP3 CD.
If the disc content menu appears on the TV
- 2 Use ◀▶ ▲▼ to navigate within the menu and select the album and track to play, then press **PLAY ▶**.
- 3 During playback, you can press ◀◀ / ▶▶ to select the next/previous track.
- 4 To stop playback, press **STOP ■**.
→ The number of albums or tracks appears on the display.

Helpful Hints:

– Only the first session of a multi-session CD will play back.
– Further information on the album, track and artist will also be displayed on the TV if included in the ID tag.

Playing a picture disc (slide show)

You can display JPEG pictures in the selected roll automatically one after the other at adjustable intervals.

- 1 Insert a JPEG picture disc (CD, DVD+RW, DVD+R.)
If the picture overview appears on the TV
- 2 Use ◀▶ ▲▼ to navigate within the menu and select a photo roll folder to play.
- 3 Press **PLAY ▶** to start the slide show playback.
OR
- Press **OK** to show 12 thumbnail pictures. You can use ◀▶ ▲▼ to select a picture file, then press **PLAY ▶** to begin playback.
- 4 During playback, you can select to zoom, flip or rotate the picture. Press **EDIT** and followed by the matching color coded button on the remote control.
- 5 To stop playback, press **STOP ■**.
→ The picture overview appears.

Playable JPEG picture disc

This DVD recorder can read JPEG pictures stored on a CD-ROM, Picture CD, or DVD.

File format:

- The file extension has to be '*.JPG' and not '*.JPEG.'
- It can only display DCF-standard still pictures or JPEG pictures e.g. TIFF. It cannot play back moving pictures, Motion JPEG, progressive JPEG and other formats, or pictures in formats other than JPEG, or pictures associated with sound e.g. AVI-files.
- It may require longer time for the DVD recorder to display the disc content on the TV due to the large number of songs/pictures compiled into one disc.

TIPS: Some discs can not be played on this DVD recorder due to the configuration and characteristics of the disc, or due to the condition of recording and authoring software.

Additional Playback Features

Using Toolbar options

- 1 Press **SYSTEM-MENU** on the remote control.
→ The system menu appears on the TV.
- 2 At { Toolbar }, press ► to select { **Options** }.

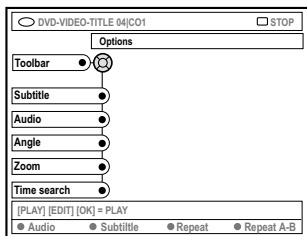

- 3 Press ▲▼ to select the setting you want to adjust.
→ If the selection in the menu is grayed out, that means the feature is not available or not possible to change at the current state.
→ Instructions for adjusting the settings are provided in the following pages.
- 4 To exit, press **SYSTEM-MENU**.

Time search

This option allows you to skip to a specific point in the current disc.

- 1 Press ▼ to select { **Time search** } and press ► to enter the time field.
→ The time shows the elapsed playing time of the current disc (hours : minutes.)
- 2 Press ▲▼ to change the digit and press ► to go to the next digit field.
- You may also use the **alphanumeric keypad 0-9** to enter the correct digit directly.
- 3 Press **OK** to confirm.
→ Playback skips to the selected time.

Changing subtitle language

This operation works only on DVDs with multiple subtitle languages, you can change the language you want while playing DVD.

This function can also be accessed via the **Green** button on the remote control.

- 1 Press ▼ to select { **Subtitle** } and press ► to enter its options.
- 2 Press ▼ repeatedly until the language you want is selected, then press ◀ to confirm.
→ The languages may be numbered or abbreviated, such as “En” for English.
→ If the language selected is not available on the disc, the disc’s default setting language will be used instead.

Helpful Hint:

– Some DVDs discs allow subtitle language changes only via the DVD disc menu. To access the disc menu, press **DISC-MENU**

TIPS: The operating features described here might not be possible for certain discs. Always refer to the instructions supplied with the discs.

Additional Playback Features (cont'd)

Changing audio soundtrack language

This operation works only on DVDs with multiple soundtrack language or VCDs with multiple audio channel.

This function can also be accessed via the **Red** button on the remote control.

- 1 Press **▼** to select { **Audio** } and press **▶** to enter its options.
- 2 For DVD, press **▼** repeatedly until the audio language you want is selected, then press **◀** to confirm.
→ The languages may be numbered or abbreviated, such as “En” for English.
→ If the language selected is not available on the disc, the disc’s default setting language will be used instead.

Helpful Hint:

– Some DVDs allow soundtrack language changes only via the DVD disc menu. To access the Disc Menu, press **DISC-MENU**.

In TV programming mode:

- It can be used for changing the audio language setting temporarily - { **SAP** } or { **Off** }, if the additional language is available in the TV programs. Once the DVD recorder is turned off and on again, it will return to the default settings (see page 38.)

Switching camera angles

This option is only available with DVDs that contain sequences recorded from different camera angles. This allows you to view the picture from different angles.

- 1 Press **▼** to select { **Angle** } and press **▶** to enter its options.
→ The camera angles available for selection appears.
- 2 Press **▲▼** to select the camera angle you want to switch to, then press **◀** to confirm.

Zooming in

This option allows you to enlarge the picture on the screen and to pan through the enlarged picture.

- 1 Press **▼** to select { **Zoom** } and press **▶** to enter zoom in mode.
→ The zoom status bar appears and displays the zoom factor.

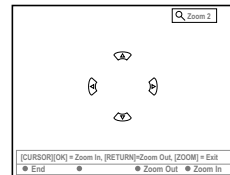

- 2 Press **OK** on the remote to zoom in or **RETURN** to zoom out.
- 3 Use **◀▶▲▼** to pan through the zoomed picture.
- 4 To exit zoom mode, press **SYSTEM-MENU**.

TIPS: The operating features described here might not be possible for certain discs. Always refer to the instructions supplied with the discs.

Additional Playback Features (cont'd)

Changing to another title/ chapter/track

When a disc contains more than one track, title or chapter, you can change to a different track, title or chapter as follows.

During playback,

- Press **▶▶** to go to the next title/chapter/track.
- Press **◀◀** to return to the start of the current title/chapter/track. Pressing **◀◀** twice can return to the start of the previous title/chapter/track.

OR

- Use the **alphanumeric keypad 0-9** to input the title/chapter/track number.

OR

- Press **T/C** on the remote control to select “**T**” (title) or “**C**” (chapter).

OR

- Press **BROWSER** on the remote control to display the titles list. Then press **▲ ▼** to select a title and press **OK** to confirm.

Searching forwards/ backwards

You can fast forward or fast reverse a disc at four, eight or thirty two times normal playback speed.

- 1 During playback, hold down **◀◀** (reverse) or **▶▶** (forward) to switch to the search function.
→ The Search status bar appears. It displays the Search speed (-32x, -8x, -4x, 4x, 8x or 32x.)
→ The sound will be mute.
- 2 Press the **◀◀** (reverse) or **▶▶** (forward) button to cycle through the search speeds.
- 3 To resume normal playback, press **PLAY ▶**.

Pausing playback / slow motion play

- 1 During playback, press **PAUSE II** to pause playback and display a still picture.
- 2 Hold down **◀◀** (reverse) or **▶▶** (forward) to start reverse or forward slow motion playback.
→ Pressing **◀◀** or **▶▶** repeatedly to switch between different slow motion speed (-1/2, -1/4, -1/8, 1/2, 1/4 or 1/8.)
- 3 To resume normal playback, press **PLAY ▶**.

TIPS: The operating features described here might not be possible for certain discs. Always refer to the instructions supplied with the discs.

Additional Playback Features (cont'd)

Selecting various play mode

Repeat play

You can select a Chapter, Track, Title or the entire disc for repeat playback.

- 1 Press **Yellow** button { REPEAT } repeatedly on the remote control to select one of the repeat options.
 - Repeat chapter (DVD, DVD+R[W] only)
 - Repeat track/title
 - Repeat album/playlist (if applicable)
 - Repeat entire disc (video CD, audio CD, DVD+R[W] only)
 - Repeat off
- 2 To cancel repeat playback, select Repeat off or press **STOP** ■.

Repeating a specific segment (A-B)

You can repeat the playback of a specific segment within a title/chapter/track. To do this, you must mark the start and end of the segment you want.

- 1 During playback, press **Blue** button { REPEAT A-B } on the remote control.
 - This indicates that the start point has been marked.
- 2 Press **Blue** button (REPEAT A-B) on the remote control again to mark the end of the segment.
 - A visual marker is placed on the program bar.
 - Playback skips to the start of the marked segment.
- 3 To cancel repeat playback, press **Blue** button again.

Shuffle play

Select shuffle play mode to allow the DVD recorder to randomly select and play tracks on the disc (MP3 and audio CDs only.)

- 1 Press **Green** button { SHUFFLE } on the remote control.
 - It will start playback of all the chapters within the title in a random order.
- 2 To cancel shuffle playback, press **Green** button again.

Scan disc

This function allows you to preview the first 10 seconds of each track (CD, VCD DVD+RW only) on the disc.

- 1 During playback, press **Red** button { SCAN } on the remote control.
 - The DVD recorder skips to the next track after 10 seconds of playback.
- 2 To exit Scan disc mode, press **Red** button again.
 - Normal playback resumes at the current track.

TIPS: The operating features described here might not be possible for certain discs. Always refer to the instructions supplied with the discs.

Discs for recording

Two different formats of DVD recordable discs can be used with this DVD recorder:



DVD+RW (DVD 'plus' Rewritable)

- Discs are re-writable can be used for multiple recordings once existing data is erased.
- To prevent accidental loss of recordings, when you starting recording, hold down the RECORD button until 'SAFE RECORD' message appears.



DVD+R (DVD 'plus' Recordable)

- Discs can only be used for a single recording. Each new recording is always added at the end of all previous recordings as existing recordings cannot be overwritten.
- Editing can be made on DVD+R discs as long as they have not been finalized. It is also possible to create additional chapter markings.
- You can also delete unwanted recordings. However, the disc space occupied by the deleted recordings cannot be recovered for further recording.
- To play a DVD+R disc on other DVD player, it must be finalized (see page 45 "Playing your recording on other DVD player (DVD+R)".) After this is done, no more data can be added to the disc.

IMPORTANT!

Unrecordable pictures

Television programs, films, video tapes, discs, and other materials may be copyrighted and therefore they cannot be recorded on this recorder.

Recording settings

Before recording, you may have to set up the recording mode or select the settings that best suit your needs and requirements.

- 1 Press **SYSTEM-MENU** on the remote control.
→ The system menu appears on TV.
- 2 Press ▼ to select { **Preferences** }.
- 3 Press ► to select { **Recording** }.

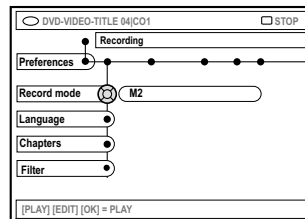

- 4 Press ▲▼ to select the setting for recording.
→ Instructions for adjusting the settings are provided in the following pages.
- 5 To exit, press **SYSTEM-MENU**.

TIPS: Press ◀ to go back to previous menu item. Press **SYSTEM-MENU** to exit the menu.

Recording (cont'd)

Recording mode

The recording mode defines the picture quality of recordings and the maximum recording time for a disc. During playback, the correct picture quality will automatically be selected.

This function can also be accessed via the **REC MODE** button on the remote control.

- 1 Press ▼ to select { **Record mode** } and press ► to enter its options.
- 2 Press ▲ ▼ to select one of the following record modes.

Record Mode	Picture Quality	Maximum Recording Time per Disc
M2	DVD quality-Standard Play (SP)	2 hours
M2x	DVD quality-Standard Play Plus (SP+)	2.5 hours
M3	S-VHS quality-Long Play (LP)	3 hours
M4	VHS quality-Extended Play (EP)	4 hours
M6	VHS quality-Super Long Play (SLP)	6 hours
M8	VHS quality-Super Extended Play (SEP)	8 hours

- 3 Press ◀ to confirm.

Recording language

Some TV programs broadcast additional audio language (SAP - second audio program.) Usually, second audio means the program has a second language available. For example, if a program is available in English and Spanish, with being the SAP option.

When you play the recording, you can play only in the audio you recorded.

- 1 Press ▼ to select { **Language** } and press ► to enter its options.
- 2 Press ► to select one of the options.
 - { **SAP** } : Select second language (SAP) for recording. This setting is only available if the TV program is available in stereo or SAP.
 - { **Off** } : Select stereo for recording.
- 3 Press ◀ to confirm.

Inserting chapter markers

You can insert a chapter markers within a title during recording. This lets you access specific points on the recorded disc as you would choose a chapter on a DVD.

- 1 Press ▼ to select { **Chapters** } and press ► to enter its options.
- 2 Press ▲ ▼ to select one of the options.
 - { **Off** } : Disable this feature.
 - { **Standard** } : A chapter marker will be automatically inserted during recording, the interval will depend on the recording mode selected.
 - { **Smart** } : Automatic chapter marker generation.
- 3 Press ◀ to confirm.

TIPS: Underlined option is the factory default setting.
Press ◀ to go back to previous menu item. Press **SYSTEM-MENU** to exit the menu.

Filter mode

For long play or extended play recording, you can select a suitable filter mode to optimize the video recording. The setting does not influence high quality or standard play recording mode.

- 1 Press **▼** to select { **Filter** } and press **▶** to enter its options.
- 2 Press **▶** to select one of the options.
→ { **Standard** } : Recording quality is as the recording mode selected.
→ { **Sport** } : Improve recording of images that move quickly. Optimize the picture quality in record mode M3~M8.
- 3 Press **◀** to confirm.

Manual recording

Use the 'Manual recording' function to start recording immediately (e.g., to record a TV show already in progress.)

- 1 Turn on the TV power. Select the correct Video In channel at the TV.
- 2 Insert a DVD+R(W).
→ The contents of this disc is checked.
→ If a DVD+RW was inserted that already contains recordings, press **▲▼** to select the location where the recording should be started.
- 3 Press **TUNER** on the remote control to see the TV programs, then press **▲▼** to select the program number you wish to record.
 - To record from external device, press button { **0** } on the remote control and followed by **▼** to select the correct input channel that matches the socket to which you connected to the DVD recorder.
 - { **CAM 2** } : DV IN socket at the front
 - { **CAM 1** } : S-VIDEO or VIDEO with AUDIO L/R sockets at the front
 - { **EXT 2** } : IN-EXT2, S-VIDEO (Y/C) or VIDEO (CVBS) sockets at the back
 - { **EXT 1** } : IN-EXT1, COMPONENT VIDEO sockets at the back
- 4 Press **RECORD ●** to start recording.
 - For DVD+RW disc, to prevent accidental loss of recordings, hold down the **RECORD ●** until the message 'SAFE RECORD' appears on the display panel.

TIPS: Underlined option is the factory default setting.
Press **◀** to go back to previous menu item. Press **SYSTEM-MENU** to exit the menu.

Recording (cont'd)

- 5 For recording from external device, you have to first start play on the external device.
- 6 While recording in progress, you can press **OK** to insert a chapter marker wherever necessary.
- 6 To stop the recording, press **STOP ■**.
→ 'MENU UPDATE' or 'CREATE MENU' appears on the display panel to indicate that the DVD recorder is writing the list of contents. Wait until the message disappears before removing the DVD+R(W).
- If the end of a disc is reached during recording, recording will stop and the DVD recorder will turn off automatically.

Pausing a recording

- 1 During recording, press **PAUSE II**.
→ You can use this function to avoid recording commercials.
- 2 To continue recording, press **RECORD ●**.

Helpful Hints:

- If you insert recordings between existing recordings, check the lengths of the old and new recordings. If the new recording is too long the subsequent recording (title/chapter) will be overwritten.
- The length of recording available depends on the current recording mode and the amount of time available on the disc.

Manual recording with automatic turn-off (One Touch Recording)

- 1 Follow the steps 1~3 of "Manual Recording" on pages 39~40.
- 2 Press **RECORD ●** on the remote control twice to start 30 minutes recording.
Each time you press **RECORD ●** you will add 30 minutes to the recording time.
→ The recorder will stop recording at the designated end time and turn off automatically.
- If you wish to delete the recording, press **STOP ■** while the display showing the recording time.
- To check the remaining recording time while recording in progress, press **SYSTEM-MENU**.

Deleting a recording

You can delete a specific recording from the DVD+R(W).

- 1 Insert a recorded DVD+RW or an unfinalized DVD+R.
→ The Index Picture screen or disc content menu appears on the TV.
- 2 Use **◀▶ ▲ ▼** to select an entry in the menu.
- 3 Press the matching color coded button on the remote control to select { **Delete** }
→ The current recording will be deleted.
→ For DVD+RW only, a new recording can now be made here.
- To delete all the recordings, see pages 53~54 "Accessing to the Preferences options - Disc" and select { **Delete all** }

TIPS: To play a DVD+R on other DVD players, see "Playing your recording on other DVD player (DVD+R)."

Timer Recording

Introduction

Use 'Timer Recording' to automatically start and stop a recording at a later date/time. The DVD recorder will tune to the right program number and begin recording at the specified time.

With this DVD recorder, you can pre-program up to **six recordings** within a period of 15 days.

To make a programmed recording, your DVD recorder needs to know:

- The date you want to make the recording.
- The program number of the TV channel.
- The start and end time of the recording.
- The recording mode (M2/M2x/M3/ M4/ M6/M8,) see page 38.

Programming recordings

- 1 Turn on the TV power. Select the correct Video In channel at the TV.
- 2 Press **TIMER** on the remote control.
→ The timer overview appears.
- 3 If the time has not set yet, the { **Time and Date** } menu will appear on the screen, see page 28.
- 3 Press the matching color coded button on the remote control to select { **NEW TIMER** }.
→ The timer entry screen appears.

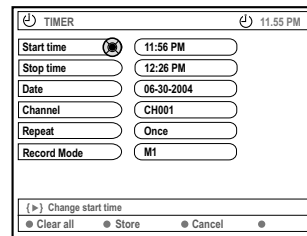

- 4 Press **▲ ▼** to select an entry in the menu and press **▶** to confirm.
- 5 Press **▲ ▼** to select an option or make an entry (character/number).
→ Press **◀ ▶** to move to the previous or next entry field if necessary.

{ **Start time** }

- Enter the start time of recording and press **OK** to confirm.

{ **Stop time** }

- Enter the end time of recording and press **OK** to confirm.

{ **Date** }

- Enter the date for recording (Month/Day/Year) and press **OK** to confirm.

{ **Channel** }

- Select the channel and press **OK** to confirm.

TIPS: To play a DVD+R on other DVD players, see page 45.

During timer recording, press **STANDBY-ON** will stop recording.

Timer Recording (cont'd)

{ Repeat }

– Select { Weekly }, { Once } or { Mo.-Fr. } (Monday to Friday) recordings and press **OK** to confirm.

{ Record mode }

– Select a record mode and press **OK** to confirm. See pages 37~38 “Recording settings - Recording mode”.)

- To clear the timer entries, press the matching color coded button on the remote control to select { **Clear all** }
→ All the settings in the timer menu are cleared.
- To cancel the timer programming, press the matching color coded button on the remote control to select { **Cancel** }
→ The timer overview appears.
- ⑥ Press the matching color coded button on the remote control to select { **Store** }
→ The system will store the timer entry and return to the timer overview screen.
- ⑦ To exit, press **TIMER**.
- ⑧ Insert a DVD+R(W).
- ⑨ Press **STANDBY-ON** to switch off the DVD recorder.
→ The DVD recorder must be in standby mode in order for the timer recording to occur. If not, a warning message will appear ten minutes before the recording starts.
→ If you ignore the warning message, the DVD recorder will switch to standby mode automatically before the programmed recording begin.
→ The '**TIMER**' icon will light up on the display panel if a timer recording is set.

Helpful Hints:

- Set the timer recording one minute ahead of the program's start time. This helps ensure the entire program is recorded as the disc requires about 30 seconds to prepare for recording.
- Program timer recording from { CAM2 } external input source is not possible.

Programming recording from a Satellite Receiver/Cable Box

If you have a Satellite Receiver/Cable Box connected to the DVD recorder's via the 'IN-EXT 2' connection, S-VIDEO (Y/C) or VIDEO (CVBS) (see page 16,) follow the steps described below to program the recordings.

- ① Select the channel you want to record at the Satellite Receiver/Cable Box.
- ② Program the recording with the required information. Follow the steps ①~⑨ of “Programming Recording” on pages 41~42.
{ Channel }
– Select { EXT2 } as the input channel and press **OK** to confirm.
- ③ Leave the Satellite Receiver/Cable Box on for the recording.

TIPS: To play a DVD+R on other DVD players, see page 45.
During timer recording, press **STANDBY-ON** will stop recording.

Timer Recording (cont'd)

Changing a programmed recording

- 1 Turn on the TV power. Select the correct Video In channel at the TV.
- 2 Press **TIMER** on the remote control.
→ The timer overview appears.

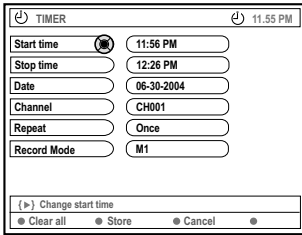

- 3 Press **▲ ▼** to select a timer program which you want to change.
- 4 Press the matching color coded button on the remote control to select { **Change** }
→ The timer entry screen of the current selected timer program appears.
- 5 Follow the steps 4~9 of "Programming recordings" on pages 41~42 to make the necessary changes.

Deleting a programmed recording

- 1 Turn on the TV power. Select the correct Video In channel at the TV.
- 2 Press **TIMER** on the remote control.
→ The timer overview appears.
- 3 Press **▲ ▼** to select a timer program which you want to delete.
- 4 Press the matching color coded button on the remote control to select { **Delete** }
→ The current selected timer program is deleted from the list.

TIPS: To play a DVD+R on other DVD players, see page 45.
During timer recording, press **STANDBY-ON** will stop recording.

Editing/Finalizing Recording

About editing

You can change disc contents and settings for a recorded DVD+RW or unfinalized DVD+R from the edit menu screen. Photo editing is limited to edit the information on a roll or album. These editing changes are available for the DVD recorder, but may not be accessible when you play the disc on other DVD player.

The edit menu contains the following editable items :

- Disc name of a DVD+R(W)
- Make DVD compatible (DVD+RW only)
- Finalize disc (DVD+R only)
- Title name of a title on a DVD+R(W)
- Video editing

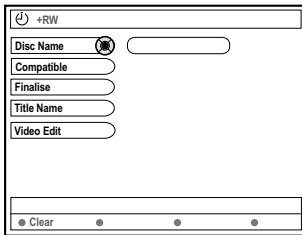

Color coded buttons functions

In the edit mode, a number of functions are available via the color coded buttons on the remote control.

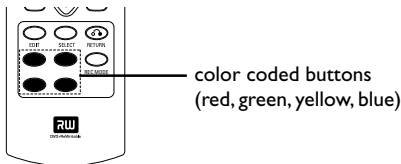

These functions are displayed in the bottom of the menu wherever applicable.

{ Clear }

- Press this button to clear the entry on the currently selected menu item.

Index Picture screen

The Index Picture screen shows your recordings on a DVD+RW or DVD+R.

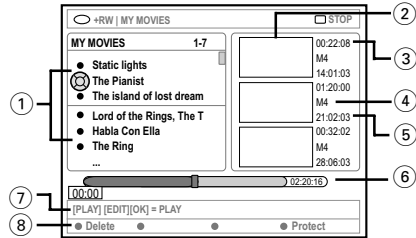

An Index Picture screen represents each recording information saved :

- ① Name of recording (or channel number and time).
- ② Title's index picture
- ③ Length of recording
- ④ Recording mode
- ⑤ Date of the recording
- ⑥ Disc bar (represents the recordings, erased titles, protected title and blank space at the end of the disc)
- ⑦ Support function guidance
- ⑧ Four color coded buttons supported functions.

TIPS: No further recording and editing can be carried out on a finalized DVD+R. Press **RETURN** to go back to previous menu item. Press **EDIT** to exit the menu.

Editing/Finalizing Recording (cont'd)

Changing the disc/title name

- 1 Insert a recorded DVD+RW or an unfinalized DVD+R.
→ The Index Picture screen or disc content menu appears on the TV.
- 2 Press **EDIT** on the remote control.
→ The edit menu appears.
- 3 Press ▲ ▼ to select { **Disc name** } or { **Title name** } in the menu.
- 4 Press ▲ ▼ to change the character/number or make an entry by using the **alphanumeric keypad 0-9**.
→ Press ◀▶ to move to the previous or next field.
- 5 Press **OK** to confirm the changes.
→ The info panel is now updated.

Making the editing compatible (DVD+RW)

This function allows you to make an edited version DVD+RW compatible. This is required to enable the edited information to be seen on other DVD players.

- 1 Insert a recorded DVD+RW.
→ The Index Picture screen or disc content menu appears on the TV.
- 2 Press **EDIT** on the remote control.
→ The edit menu appears.
- 3 Press ▲ ▼ to select { **Compatible** } in the menu and press **OK** to confirm.

Helpful Hint:

– If the {Compatible} not available for selection, it means that the disc is already compatible.

Playing your recording on other DVD player (DVD+R)

This function is necessary for a DVD+R in order to be played back on a DVD player. Otherwise, the DVD+R will play only on this DVD recorder.

After finalized, no further recording or editing can be made to the disc. Make sure that you have complete all the recordings and editing before finalizing it. Unfinalize a DVD+R is not possible.

- 1 Insert an unfinalized DVD+R.
→ The Index Picture screen or disc content menu appears on the TV.
- 2 Press **EDIT** on the remote control.
→ The edit menu appears.
- 3 Press ▲ ▼ to select { **Finalize** } in the menu and press **OK** to confirm.
→ A dialog will appear showing the required process time.
→ Once complete, the Index Picture screen appears.

TIPS: No further recording and editing can be carried out on a finalized DVD+R. Press **RETURN** to go back to previous menu item. Press **EDIT** to exit the menu.

Editing/Finalizing Recording (cont'd)

Video editing

In the edit video mode, the entire recording will be played back regardless of whether they are hidden or not.

- 1 Insert a recorded DVD+RW or an unfinalized DVD+R.
→ The Index Picture screen appears on the TV.
- 2 Press ▲ ▼ to select a recording.
- 3 Press **EDIT** on the remote control.
→ The edit menu appears.
- 4 Press ▲ ▼ to select { **Video edit** } in the menu and press **OK** to confirm.
→ The video edit menu appears.
OR
- While playing the recorded DVD+R(W), you can press **EDIT** to direct access to the video edit menu.



Disc bar

About edit bar

In the disc bar, the record playback head represents the actual position of the playback on the disc.

Hiding unwanted chapter

You can choose to hide certain scene for playback (e.g. commercial skipping) or make them visible again.

- 1 Follow the steps ①~④ of “Video editing” on page 46.
- 2 Press **PLAY** ► or ◀◀ / ▶▶ to search for the beginning of the chapter you want to hide.
→ The selection of chapters can only be done within a title, make sure that you do not jump into the next title.
- 3 Press the matching color coded button on the remote control to select { **Hide** }
→ It will set the chapter for hide.
→ The hiding chapters will only reflect after exit video editing mode.

To cancel the hidden chapters

- 4 Press ◀◀ or ▶▶ to search for the beginning of the chapter you want to unhide.
- 5 Press the matching color coded button on the remote control to select { **Show** }.
→ It will set the chapter for unhide.

TIPS: No further recording and editing can be carried out on a finalized DVD+R.
Press **RETURN** to go back to previous menu item. Press **EDIT** to exit the menu.

Editing/Finalising Recording (cont'd)

Editing chapter (merge/split/hide)

- 1 Start playback a recorded DVD+RW or an unfinalized DVD+R.
- 2 Press **EDIT** on the remote control.
- 3 Press the matching color coded button on the remote control to select { **Chapter** }
→ The chapter editing menu appears.

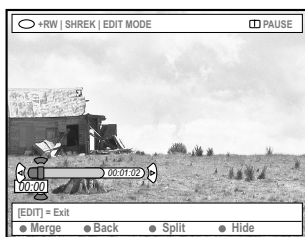

- 4 Press the matching color coded button on the remote control to make your editing.

{ **Merge** }

- Select this to merge the current chapter with the chapter before it.

If the two chapters were hidden, then the joined chapter will also be hidden. If only one of the chapters is hidden, then the joined chapter will not be hidden.

{ **Back** }

- Select this will return to the previous screen.

{ **Split** }

- Select this to insert a chapter marker, it will cut the current chapter to two. When the playback is in a chapter which is marked for hiding, then both new chapters will be hidden.

{ **Hide** }

- Select this to hide the current chapter.

Editing title (divide/append/Index picture)

- 1 Start playback a recorded DVD+RW or an unfinalized DVD+R.
- 2 Press **EDIT** on the remote control.
- 3 Press the matching color coded button on the remote control to select { **Title** }.
→ The title editing menu appears.



- 4 Once you have found the scene that you want to use for title editing, press the matching color coded button on the remote control to make your editing.

{ **Divide** }

- Select this to divide the current title into two new titles (for DVD+RW only). Each of these titles is characterized by its own index picture.

Warning! Once a title is divided, it cannot be reversed.

{ **Back** }

- Select this will return to the previous screen.

{ **Index Pic.** }

- Select this to use the current scene as the title's index picture.

Note: In the Index Picture screen, normally the first frame of a recording is shown as the title's index picture.

TIPS: No further recording and editing can be carried out on a finalized DVD+R. Press **RETURN** to go back to previous menu item. Press **EDIT** to exit the menu.

Editing/Finalising Recording (cont'd)

{ **Append** } - for DVD+RW only
 – Select this to append record to the existing recording from the position of the playback. Continue steps 5~7.

For append recording only:

- 5 Press **▲▼** to select the input channel to append : { preset program number }, { EXT1 }, { EXT 2 } or { CAM1 }.
- 6 Press **RECORD ●** to start append recording.
Warning! Once the recording started, any prior recording from the point of the playback onwards will be overwritten.
- 7 To stop append recording, press **STOP ■**.

Deleting chapter markers

You can choose to delete all the chapter markers in the current recording.

- 1 Follow the steps 1~3 of “Video editing” on page 46.
- 2 Press the matching color coded button on the remote control to select { **No Chapters** }.

Photo editing

The Photo (JPEG picture) recordings on a DVD+R(W) are limited to edit the information.

The editable information items are :

- Title of the currently selected item
- Album edit name
- Photo edit date

- 1 Insert a recorded DVD+RW or an unfinalized DVD+R.
- 2 Use **◀▶▲▼** to select an entry in the menu.
- 3 Press **EDIT** on the remote control.
 → The relevant edit menu appears.
- 4 Press **▲▼** to change the character/number or make an entry by using the **alphanumeric keypad 0-9**.
 → Press **◀▶** to move to the previous or next entry field.
- 5 Press **OK** to confirm the changes.
 → The info panel is now updated.

During photo (JPEG picture) playback, you can modify the photo display.

However, the changes cannot be stored in the disc.

- 1 During playback, press **EDIT**.
- 2 Press **▶** to select { **Photo options** } on the screen, then press **▼** to select { **Filter** } or { **Color Adjust** }.
- 3 Press **▶** to access to the menu, then press **▲▼** to select the available setting.

Helpful Hint:

- *Editing of the audio content is not possible.*

For information on organizing the JPEG pictures, see pages 50~52 “Browsing the picture disc.”

TIPS: No further recording and editing can be carried out on a finalized DVD+R.
 Press **RETURN** to go back to previous menu item. Press **EDIT** to exit the menu.

Using the Browser

Browsing the disc

You can view and manage possible contents within your discs by using an on-screen console called the Media Browser.

- 1 Insert a disc into the DVD recorder.
→ The Index Picture screen or disc content menu appears on the TV.

(example of an DVD) (example of an DVD+RW)

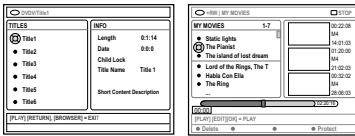

- 2 Alternatively, you can press **BROWSER** on the remote control to access the disc content menu.
- 3 Press **▶** to move to the previous/next level of information in the menu (e.g. SOURCE, ALBUM, TRACK.)

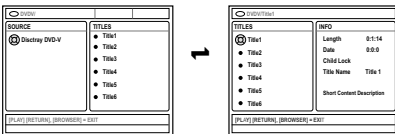

- 3 Press **▲ ▼** to view the detailed overview of the selected title/chapter.
→ The content is displayed within two panels, left panel displays the titles of the media and right panel displays the information of the current title.
- 4 To start playback of the current title, press **PLAY ▶**.
- 5 To change the disc content information, press **EDIT** (see page 45 “Changing the disc/title name”).

Helpful Hints:

– The information showed on the display panel varies for different types of media.

Color coded buttons functions

In the Media Browser mode, a number of functions are available via the color coded buttons on the remote control.

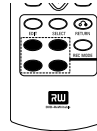

color coded buttons
(red, green, yellow, blue)

These functions are displayed in the bottom of the menu wherever applicable.

- { **DELETE** }
- Delete the currently selected menu item.
- { **PROTECT** } / { **UNPROTECT** }
- Protect/unprotect the disc. Overwrite or edit on the disc is not possible if protected.
- { **TO ALBUM** }
- Add photo(s) to album.
- { **SELECT** }
- Add to the selection.
- { **SELECT ALL** }
- Add all items to the selection.
- { **MOVE** }
- Move photos within photo album.
- { **REMOVE** }
- Remove the selected item in the list.
- { **ROTATE** }
- Rotate the selected photo in 90 degree clockwise increments.
- { **ZOOM** }
- Activate zoom mode.
- { **CANCEL** }
- Cancel the operation.

TIPS: Press **RETURN** to go back to previous menu item. Press **BROWSER** to exit the menu.

Using the Browser (cont'd)

Browsing the picture disc

The Media Browser allows you to view the JPEG pictures discs or playback as a slide show or store them in an album.

JPEG Photo can handle up to 100 photos in one album on a DVD+RW or DVD+R from this DVD recorder, depends on the JPEG file parameters.

The supported functions are shown at the bottom of the disc content menu via the color coded buttons on the remote control.

Adding pictures to an album

Photo roll is a folder for storing original JPEG pictures and they are protected. It is comparable with a conventional 35mm film for cameras. Rolls will be created automatically from the digital cameras.

Photo album contains different pictures on the rolls. You can delete an album without deleting the pictures of the rolls.

- 1 Press **BROWSER** on the remote control.
→ The disc content menu appears.
- 2 Press ◀▶ to select photo roll menu and press ▲▼ to select a desired photo roll folder.

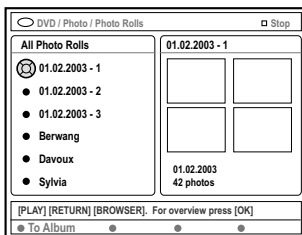

- 3 Press **OK** to display the picture overview.
→ The 12 roll thumbnails picture screen appears.

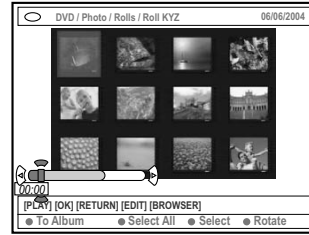

- 4 Use ◀▶▲▼ to select the photo which you wish to add to the album.
→ To make a multiple selection, press the matching color button on the remote control to select { **Select** } to confirm each selected photo.
→ Select { **Select All** } to add all photos to the selection.
→ Select { **Rotate** } to rotate the selected photo in 90 degree clockwise increments.
- 5 Press the matching color button on the remote control to select { **to Album** }.
→ The 'Add to Photo Album' menu appears.
- 6 Press ▲▼ to select an album or create a new album folder which you want to add photo(s) to it, then press **OK** to confirm.
→ The selected photo(s) is/are now stored in the album.

Helpful Hint:

– Do not pay attention to the order of the pictures. You can change it later in the album.

TIPS: Press **RETURN** to go back to previous menu item. Press **BROWSER** to exit the menu.

Using the Browser (cont'd)

Changing the picture order within an album

You can re-arrange the picture position in the album in order to create the desired order of the slide show. The order of the pictures in the photo roll remains unchanged.

- 1 Press **BROWSER** on the remote control.
→ The disc content menu appears.
- 2 Press ◀▶ to select photo album menu and press ▲▼ to select a desired photo album folder.

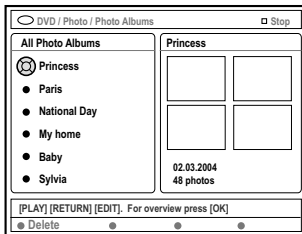

- 3 Press **OK** to display the picture overview.
→ The 12 roll thumbnails picture screen appears.

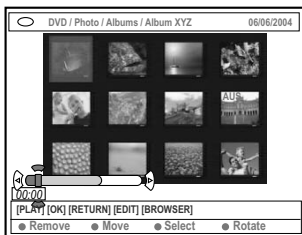

- 4 Use ◀▶▲▼ to select the photo which you wish to move to a different position.
→ To make a multiple selection, press the matching color button on the remote control to select { **Select** } to confirm each selected photo.
→ Select { **Rotate** } to rotate the selected photo in 90 degree clockwise increments.

- 5 Press the matching color button on the remote control to select { **Move** }.
→ A 'navigator' will appear on the menu enable you to select the position between the photos.
- 6 Use ◀▶▲▼ to move the 'navigator' around the menu and press **OK** to confirm the position where you want to insert the photo(s).
→ To cancel the move operation and return to the original entry point, press the matching color button on the remote control to select { **Cancel** }.

Deleting an album

- 1 Press **BROWSER** on the remote control.
→ The disc content menu appears.
- 2 Press ◀▶ to select photo album menu and press ▲▼ to select the photo album folder to delete.
- 3 Press the matching color button on the remote control to select { **Delete** }.

Deleting picture in an album

- 1 Follow steps ①~③ of "Changing the picture order within an album" on page 51 .
- 2 Use ◀▶▲▼ to select the photo which you wish to delete.
→ To make a multiple selection, press the matching color button on the remote control to select { **Select** } to confirm each selected photo.
- 3 Press the matching color button on the remote control to select { **Remove** }.

TIPS: Press **RETURN** to go back to previous menu item. Press **BROWSER** to exit the menu.

Using the Browser (cont'd)

Changing the slide show settings

You can adjust the various slide show settings to your individual needs.

- 1 Press **BROWSER** on the remote control.
→ The disc content menu appears.
- 2 Press ◀▶ to select photo roll/album menu and press ▲▼ to select a desired photo roll/album folder.
- 3 Press **PLAY** ▶ to start slide show play.

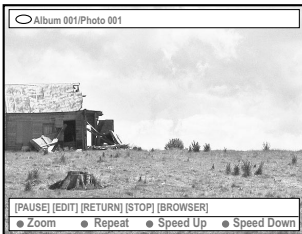

{ Zoom }

- Select this to activate zoom mode.

In zoom mode,

- Use ◀▶▲▼ to pan through the zoomed image.
- Press the matching color buttons { **ZOOM OUT** } or { **ZOOM IN** } repeatedly to select the desired zoom ratio (2x, 4x, 8x)
- Select { **End** } to exit zoom mode.

{ Repeat }

- Select this to toggle between repeat on and off.

{ Speed Down } / { Speed Up }

- Select this to change the slide show speed :

- { **SLOW** } – 10 seconds interval,
- { **MEDIUM** } – 5 seconds interval,
- { **FAST** } – 3 seconds interval.

TIPS: Press **RETURN** to go back to previous menu item. Press **BROWSER** to exit the menu.

System Menu - Preferences

Accessing the Preferences options

- 1 Switch on the TV set. Select the correct Video In channel at the TV.
- 2 Press **SYSTEM-MENU** on the remote control.
→ The system menu appears on TV.
- 3 Press **▼** to select { **Preferences** }.

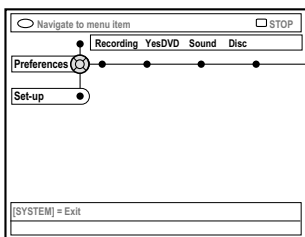

- 4 Press **▶** repeatedly to select one of the options from { Preferences } and press **▼** to select a setting you want to adjust.
→ Instructions for adjusting the settings are provided in the following pages.
- 5 Press **▶** to enter its options and use **◀▶▲▼** to make your selection.
→ If the selection in the menu is grayed out, that means the feature is not available or not possible to change at the current state.
- 6 Press **◀** to confirm.
- 7 To exit, press **SYSTEM-MENU**.

Recording

For more information on this menu, please see pages 37~39 "Recording settings."

Sound

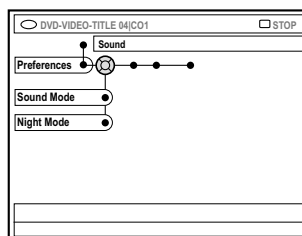

{ Sound mode }

You can select from the following settings how sound will be played back by devices connected to the analog outputs (L/R AUDIO OUT.)

- { **Stereo** } : To hear sound from the left and right audio channels. Use this setting when the DVD recorder is connected to a stereo TV.
- { **Surround** } : For audio device that is compatible with Dolby Surround. Dolby Digital and MPEG-2 multi-channel are mixed to a Dolby Surround-compatible two-channel output signal.

{ Night mode }

Allows you to optimize the sound dynamics at low volume. This causes less disturbance in quiet environments. This setting only functions with Dolby Digital Audio on DVDs.

- { **On** } : Select this to level out the volume. High volume outputs will be softened and low volume outputs are brought upward to an audible level.
- { **Off** } : Select this when you want to enjoy the surround sound with its full dynamic range.

TIPS: Underlined option is the factory default setting.
Press **◀** to go back to previous menu item. Press **SYSTEM-MENU** to exit the menu.

System Menu - Preferences (cont'd)

Disc

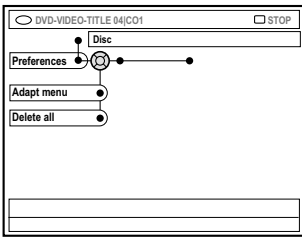

{ Adapt menu }

If a DVD+RW has been recorded in a computer drive or in another DVD recorder, the Picture Index screen may not be displayed correctly. This feature allows you to change the format supported by this DVD recorder.

- Select { Adapt menu } and press **OK**.
A message to confirm your action will appear on the TV, press **OK** again to proceed. Otherwise, press **◀** to exit.

{ Delete all }

Allows you to delete all the recordings from the current DVD+RW or DVD+R.

- Select { Delete all } and press **OK**.
A message to confirm your action will appear on the TV, press **OK** again to proceed. Otherwise, press **◀** to exit.

Access

For more information on this menu, please see pages 58~60 "Setting Access Control."

Features

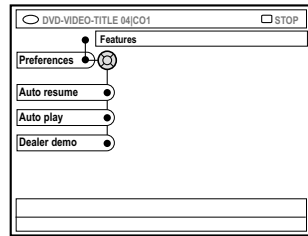

{ Auto resume }

Auto resume affects the last 20 DVDs and Video CDs you played.

- { **On** } : Play resumes where you last stopped playing the disc.
- { **Off** } : Play starts at the beginning of the disc.

{ Auto play }

When auto play is active, the system will directly initial auto play of the disc.

- { **On** } : Play starts automatically once you inserted the disc.
- { **Off** } : A dialog appears on the TV once you insert in the disc.

{ Dealer demo }

Allows you to display your demo according to the following options:

- { **Off** } : Turn off dealer mode.
- { **On** } : The DVD recorder's display panel will show various features offered by the system while in standby mode.

TIPS: Underlined option is the factory default setting.
Press **◀** to go back to previous menu item. Press **SYSTEM-MENU** to exit the menu.

System Menu - Setup

Accessing the Setup options

- 1 Turn on the TV set. Select the correct Video In channel at the TV.
- 2 Press **SYSTEM-MENU** on the remote control.
→ The system menu appears on TV.
- 3 Press **▼** repeatedly to select { **Set-up** }.
→ Playback will pause.

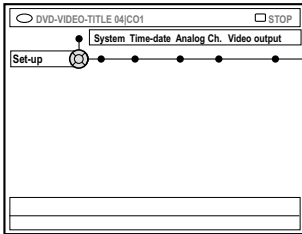

- 4 Press **▶** repeatedly to select one of the options from { **Set-up** } and press **▼** to select a setting you want to adjust.
→ Instructions for adjusting the settings are provided in the following pages.
- 5 Press **▶** to enter its options and use **◀▶▲▼** to make your selection.
→ If the selection in the menu is grayed out, that means the feature is not available or not possible to change at the current state.
- 6 Press **◀** to confirm.
- 7 To exit, press **SYSTEM-MENU**.

System

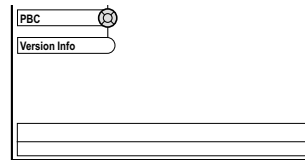
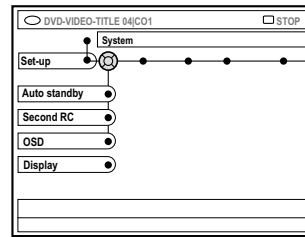

{ **Auto standby** }

The system will automatically turn on to standby mode if you do not press any buttons within 15 minutes after a disc has stopped playing or in Browser mode.

This is a power-saving feature,

- { **On** } : Turn on Auto standby mode.
- { **Off** } : Turn off Auto standby mode.

{ **Second RC** }

Allows you to control the DVD recorder with a second remote control (not supplied.)

- { **On** } : Enable second RC control.
- { **Off** } : Disable second RC control.

{ **OSD** }

Select the level of On-screen display information.

- { **Full** } : Complete information always display during use.
- { **Reduced** } : The help text and button bar will remove from the display.
- { **Normal** } : The help text will remove from the display.

TIPS: Underlined option is the factory default setting.
Press **◀** to go back to previous menu item. Press **SYSTEM-MENU** to exit the menu.

System Menu - Setup (cont'd)

English

{ Display }

Allows you to change the brightness of the DVD recorder display panel.

- { **Bright** } : Normal brightness.
- { **Dimmed** } : Medium brightness.
- { **Off** } : Turn off the display.

{ PBC } - for Video CDs only

Play Back Control allows you to play Video CDs (2.0) interactively, following the menu on the display.

- { **On** } : The index menu (if available) will appear on the TV once you insert a VCD.
- { **Off** } : The VCD will skip the index menu and playback directly from the beginning.

Time-date

For more information on this menu, please see page 28 "Setting the Time and Date."

Analog channels

For more information on this menu, please see pages 26~27 "TV Channel Programming."

Video output

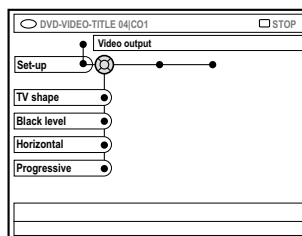

{ TV shape }

The picture shape can be adjusted to fit your TV.

- { **4:3 Letterbox** } :

For a 'wide-screen' display with black bars on the top and bottom.



- { **4:3 Panscan** } :

For a full-height picture with the sides trimmed.

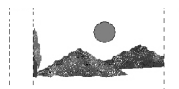

- { **16:9** } : For wide-screen TV (frame ratio 16:9.)

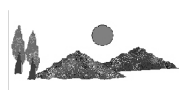

{ Black level }

Adapts the color dynamic for NTSC disc.

- { **Normal** } : Normal color contrast.
- { **Enhance** } : Improve the color contrast and brighten the picture of NTSC-compatible DVD.

{ Horizontal }

Allows you to adjust the horizontal position of the picture on your TV screen.

- Press ◀▶ to scroll the slider to the left or right. When you are satisfied with the position of the picture, press ▼ to exit.

TIPS: Underlined option is the factory default setting.
Press ◀ to go back to previous menu item. To exit, press **SYSTEM-MENU**.

System Menu - Setup (cont'd)

{ **Progressive** }

Allow you to turn on the progressive scan function if the DVD recorder is connected to a TV with progressive scan.

- { **On** } : Select this to enable progressive scan function.
- { **Off** } : Select this to disable the progressive scan function.

Audio output

After connecting the DVD recorder to your TV and other devices, you may need to change the digital output setting. Adjust the Digital Output only if you use the DVD recorder's COAXIAL jack.

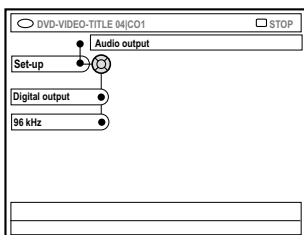

{ **96 kHz** }

- { **96 kHz** } : Select this if the optional audio device is capable of processing digital signal input with sampling rates of 96 kHz.
- { **48 kHz** } : Select this if the optional audio device is incapable of processing 96 kHz digital signal input. The signal will then be converted to a standard signal with sampling rates of 48 kHz.

Language

For more information on this menu, please see page 29 "Setting the language."

{ **Digital output** }

- { **All** } : Select this if you use the COAXIAL socket to connect the DVD recorder to a stereo receiver that has a built-in Multi-Channel decoder.
- { **PCM** } : Select this if the connected audio equipment is not capable of decoding multichannel audio. Dolby Digital and MPEG-2 multi-channel signals are converted to PCM (Pulse Code Modulation.)
- { **Off** } : Select this to deactivate the digital audio output. For example, if you use the AUDIO OUT sockets to connect the DVD recorder to a TV or Stereo system.

TIPS: Underlined option is the factory default setting.
Press ◀ to go back to previous menu item. Press **SYSTEM-MENU** to exit the menu.

Setting Access Control

About Access Control

Access Control limits viewing of discs that exceed the limits you set. We cannot guarantee the availability of Access Control with all discs, and therefore denies any liability associated with unintended watching of discs.

Setting or changing the pin code

The same pin code (password) is used for both Parental Control and Child Lock. Enter your four-digit password to play a prohibited disc or if prompted for a pin code.

- 1 Press **SYSTEM-MENU** on the remote control.
→ The system menu appears on the TV.
- 2 Press ▼ to select { **Preferences** }.
- 3 Press ► repeatedly to select { **Access** } and press ▼ to confirm.
- 4 Use the **alphanumeric keypad 0-9** to enter your four-digit pin code.
→ When doing this for the first time, enter any four-digit you prefer. You must enter the same pin code a second time to confirm it.
→ If you forgot your four-digit pin code, use the **alphanumeric keypad 0-9** on the remote control to key in '1504' and followed by **OK** button. Then, enter any four-digit you prefer.
- 5 Press ▼ repeatedly to select { **Change pin** } and press ► to confirm.

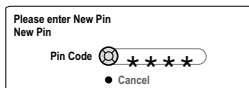

- 6 Use the **alphanumeric keypad 0-9** to enter your new four-digit pin code. You must enter the same pin code a second time to confirm it.
→ To cancel your change, press ▼ to select { **Cancel** } and press **OK** to confirm.

Setting the country of origin

The Parental control levels depend on the country in which the DVD was manufactured. Therefore, it is necessary that you enter the country for which these filter values apply.

- 1 Press **SYSTEM-MENU** on the remote control.
→ The system menu appears on the TV.
- 2 Press ▼ to select { **Preferences** }.
- 3 Press ► repeatedly to select { **Access** } and press ▼ to confirm.
- 4 Use the **alphanumeric keypad 0-9** to enter your four-digit pin code (see page 58 "Setting and changing the pin code").
- 5 Press ▼ to select { **DVD country** } and press ► to enter its options.

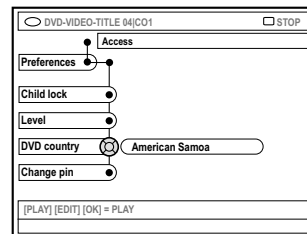

- 6 Press ▲▼ to select the country for which the disc is coded and press ◀ to confirm.

TIPS: Press ◀ to go back to previous menu item. Press **SYSTEM-MENU** to exit the menu.

Setting Access Control (cont'd)

Activating/Deactivating the child lock

This function can prevent children from viewing discs. This DVD recorder can memorize settings for 50 discs. When in use, a four-digit pin code must be entered in order to play a disc.

- 1 Press **SYSTEM-MENU** on the remote control.
→ The system menu appears on the TV.
- 2 Press ▼ to select { **Preferences** }.
- 3 Press ► repeatedly to select { **Access** } and press ▼ to confirm.
- 4 Use the **alphanumeric keypad 0-9** to enter your four-digit pin code (see page 58 “Setting and changing the pin code”).
- 5 Press ▼ to select { **Child lock** }.

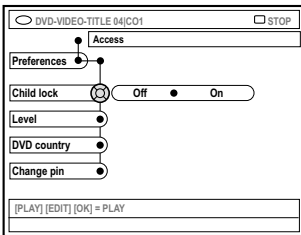

- 6 Press ► to select { **On** } or { **Off** } setting and press ◀ to confirm.
→ If you turn on the child lock feature, you will need to enter the four-digit pin code in order to play locked discs.

Alternatively, we can lock the disc while in browser mode;

- 1 Press the **BROWSER** on the remote control.
→ The disc content menu appears.
- 2 Press the matching color coded button on the remote control to select { **ChildLock** }.
→ The disc is now locked. You must enter the four-digit pin code the next time when you insert the disc.

Helpful Hint:

– Two-sided DVDs and multi-volume discs may have a different ID for each side/volume. To completely unlock these discs, you must authorize each side/volume separately.

Authorizing discs

You can enable playback of a locked disc by entering the four-digit pin code, however, it will only allow play once.

- 1 Insert the disc.
→ If the disc has been locked (child lock on,) the pin code entry menu will appear on the TV.
- 2 Use the **alphanumeric keypad 0-9** to enter your four-digit pin code (see page 58 “Setting and changing the pin code”).
→ Playback will begin.

If you later decide to unlock the disc and allow play always;

- Follow the steps described in ‘Activating/Deactivating the child lock’ and select { **Off** } in the menu.

TIPS: Press ◀ to go back to previous menu item. Press **SYSTEM-MENU** to exit the menu.

Setting Access Control (cont'd)

Restricting playback by Parental Control

Some DVDs may have a parental level assigned to the complete disc or to certain scenes on the disc. This feature lets you set a playback limitation level. The rating levels are from 1 to 8 and are country dependent. You can prohibit the playing of certain discs that are not suitable for your children, or have certain discs played with alternative scenes.

- 1 Press **SYSTEM-MENU** on the remote control.
→ The system menu appears on the TV.
- 2 Press ▼ to select { **Preferences** }.
- 3 Press ► repeatedly to select { **Access** } and press ▼ to confirm.
- 4 Use the **alphanumeric keypad 0-9** to enter your four-digit pin code (see page 58 “Setting and changing the pin code”).
- 5 Press ▼ to select { **Level** } and press ► to enter its options.

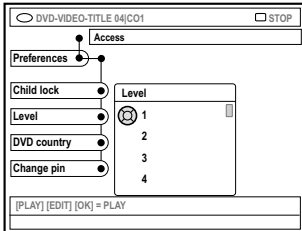

- 6 Press ▲ ▼ to select the desired parental level and press ◀ to confirm.
→ To disable Parental controls and allow all discs to play, select { - }.

Rating explanations

- { - } – Parental Control is not active.
 - { 1 } – Childsafe; acceptable for viewers of all ages.
 - { 3 } – Parental Guidance suggested.
 - { 4 } – Unsuitable for children under age 13.
 - { 6 } – Restricted; recommended that parents restrict children under 17 from viewing or allow to view only when supervised by a parent or adult guardian.
 - { 7 } – No children under age 17; not recommended viewing for children under age 17.
 - { 8 } – Mature material; should be viewed only by adults due to graphic sexual material, violence or language.
- DVDs that are rated higher than the level you selected will not play unless you enter your four-digit pin code.

Helpful hints:

- This feature will not limit viewing if the disc manufacturer did not code the disc.
- VCD, SVCD, CD have no level indication, so parental control has no effect on these type of discs. This also applies to most illegal DVDs.
- Some DVDs are not coded with a rating though the movie rating may be printed on the Disc cover. The rating level feature does not prohibit play of such Discs.

TIPS: Press ◀ to go back to previous menu item. Press **SYSTEM-MENU** to exit the menu.

Specifications

Disc types

Recording : DVD+RW/+R
Playing : DVD-Video, Video CD,
SuperVCD, Audio CD, MP3 CD, Picture CD,
CD-R/RW, DVD-R, DVD-RW

Record modes

recording time / picture quality

M2: 120 minutes / DVD quality
M2x: 150 minutes / DVD quality
M3: 180 minutes / S-VHS quality
M4: 240 minutes / VHS quality
M6: 360 minutes / VHS quality
M8: 480 minutes / VHS quality

TV systems

Playback: NTSC
Recording: NTSC
Internal tuner: NTSC

Video Performance

AD Converter 10 bit, 54 MHz
DA Converter 10 bit, 54 MHz

Audio

Recording Dolby Digital
2-channel
Playback Dolby Digital, DTS,
MPEG2 Multichannel,
MPEG1 layer 3 (MP3), PCM

Audio Performance

DA Converter 24 bit, 192 kHz
AD Converter 24 bit, 96 kHz
Signal / Noise (1kHz) 105 dB
Dynamic range (1kHz) 90 dB
Cross-talk (1kHz) 105 dB
Distortion / Noise (1kHz) 90 dB

Rear Connections

- Component Video Out/In
- S-video Out/In
- Video (CVBS) Out/In
- Audio left/right out
- Digital audio out (coaxial)
- RF antenna in
- RF TV out
- Mains

Front Connections

- i.LINK DV in (IEEE 1394 4-pin)
- S-video in
- Video in
- Audio left/right in

Timer Recording

- 1-month timer programming, 6 events
- weekly repeat recording

Video Editing Functions

- Automatic/Manual Chapter Marker insertion
- Append
- Divide

Digital Photo Manager

- Create albums
- Zoom, Rotate, Flip

Power Supply

- 110 - 130VAC ~60 Hz
- 27W power consumption (operation)
- 4W power consumption (eco standby)

Cabinet

Dimensions (wxhxd) : 435 x 65 x 285 mm
Net Weight : 3.5 kg

Troubleshooting

WARNING

Under no circumstances should you try to repair the system yourself, as this will invalidate the warranty. Do not open the system as there is a risk of electric shock.

If a fault occurs, first check the points listed below before taking the system for repair. If you are unable to remedy a problem by following these hints, consult your dealer for help.

Problem	Solution
No power.	<ul style="list-style-type: none">– Press STANDBY-ON button on the front of the DVD recorder to turn on the system.– Make sure the AC outlet has power.
The message “IS THE TV ON?” appears on the display panel.	<ul style="list-style-type: none">– The DVD recorder will not operate until you complete the first installation. Read chapter “Installing the DVD Recorder - First Installation” for details.
The buttons on the DVD recorder do not work.	<ul style="list-style-type: none">– The DVD recorder may be in Dealer mode, all buttons on the front of the DVD recorder are locked. To deactivate the dealer mode :<ol style="list-style-type: none">1) Disconnect the power cord from the power outlet.2) Press and hold STOP button and OPEN CLOSE ▲ on the front of the recorder while you reconnect the power cord to the power supply.3) As soon as the time or '00:00' appears on the display (within 6-10 seconds), release the buttons.– There is a technical problem. Disconnect the DVD recorder from the power outlet for 30 seconds, then connect again. If the DVD recorder still will not operate, then reset it to the default factory settings :<ol style="list-style-type: none">1) Disconnect the DVD recorder from the power outlet.2) Press and hold down STANDBY-ON button on the front of the recorder while reconnecting to the power outlet.3) Release STANDBY-ON button when “IS THE TV ON?” appears on the display. All the information stored in the memory (programs, time) will be cleared. Complete the first installation again and reset any items you have adjusted during your use of the recorder.
Remote control does not work.	<ul style="list-style-type: none">– Aim the remote control directly at the sensor on the front of the DVD recorder (not towards TV). If the DVD recorder receives a signal from the remote control, icon  will appear on the display.– Remove any obstacles between DVD recorder and the remote control.– Batteries are weak, replace the batteries.– Press TUNER on the remote control.

Troubleshooting (cont'd)

Problem	Solution
Disc will not play.	<ul style="list-style-type: none">– Insert the disc with the label facing up.– The child lock is on. Read chapter “Setting Access Control - Activating/Deactivating the child lock” for details.– Wrong region code. The DVD must be coded for ALL regions or Region 1 in order to play on this DVD recorder.– There is no recording on the disc or wrong disc type. Read chapter “Playback - Playable discs” for details.– Make sure the disc is not scratched or warped. Clean the disc or replace a new one.– Check if the disc is defective by trying another disc.
No picture.	<ul style="list-style-type: none">– Turn on your TV and set to the correct Video In channel. Change the TV channel until you see the DVD screen. Read chapter “Connecting to TV - General” for details.– Check the video connection between the DVD recorder and the TV.– PAL input signal received from external device is not supported.
The picture is distorted or black and white during playback.	<ul style="list-style-type: none">– The disc does not match with the TV color system standard (PAL/NTSC).– The disc is dirty, clean the disc.– Sometimes a small amount of picture distortion may appear. This is not a malfunction.– If you set the Record Mode to a low-quality speed, change to a higher-quality speed after you finish recording. Leaving the DVD recorder set to a low-quality speed may affect the picture quality when playing DVDs later. Read chapter “Recording - Recording settings” for details.– The recording can be made in color only when the TV channels or the connected additional device sends a color signal. In some situations, programs that are broadcast in black and white cannot be recorded.
Distorted sound coming from a connected hi-fi amplifier.	<ul style="list-style-type: none">– Do not connect any cables from the DVD recorder to the 'Phono' input of your amplifier.– Do not connect the DVD recorder's Coaxial DIGITAL AUDIO OUT jack to an analog jack (red/white) on the connecting devices.
No sound.	<ul style="list-style-type: none">– Check the audio connections, the red and white jacks. Read chapters “Connecting to TV” or “Connecting to Additional Devices” for details.– You cannot hear MP3 playback if you are using the Coaxial DIGITAL AUDIO OUT jack for sound from the DVD recorder.– Set the Analog output or Digital output correctly, based on the equipment you connected to the DVD recorder. Read chapter “System Menu - Setup” for details.– PAL input signal received from external device is not supported.

Troubleshooting (cont'd)

Problem	Solution
<p>Recordings are not occurring as scheduled. New recordings cannot be made.</p>	<ul style="list-style-type: none">- The TV channel you want to record is not stored or you selected the wrong program number. Check TV channels stored.- If you adjust the clock after you set a timer recording, reset the timer recording.- If the DVD recorder cannot read the disc, you cannot record.- You cannot use the DVD recorder to duplicate copyrighted materials (DVDs or videotapes) onto a DVD+RW/+R, "COPY PROTECT" will be displayed.- A finalized DVD+R has been inserted. Change disc.
<p>A DVD+RW or DVD+R recorded on this DVD recorder will not play on a DVD player.</p>	<ul style="list-style-type: none">- If a recording is too short, it is possible that a DVD player cannot detect it. Please observe the following 'minimum recording times'. Recording mode : {M2} – 10 minutes, {M2x} – 13 minutes, {M3} – 15 minutes, {M4} – 20 minutes, {M6} – 30 minutes, {M8} - 30 minutes.- Some DVD players cannot playback DVD+RW recordings. You can solve this problem by using a special function :<ol style="list-style-type: none">1) Press OPEN CLOSE ▲ on the DVD recorder to open the disc tray.2) Insert the disc but do not close the tray.3) Hold down the number button {2} on the remote control until the tray closes. The disc is modified.4) If this fails to produce the desired result, repeat the procedure using the number button {3} on the remote control.5) You can restore the disc to its original condition by pressing and holding number button {1}.Warning! There is a risk that you can no longer play the disc on other DVD players after the following procedure. Therefore, apply this function with particular care.
<p>The index screen flickers when a DVD+R is inserted.</p>	<ul style="list-style-type: none">- You can finalize the disc using the following function:<ol style="list-style-type: none">1) Press OPEN CLOSE ▲ on the DVD recorder to open the disc tray.2) Insert the disc but do not close the tray.3) Hold down button number {4} on the remote control until the tray closes. 'FINALISING' appears on the display panel.4) If finalizing has been successful, the Picture Index screen will appear.
<p>Picture is fuzzy and brightness varies when copying DVD Video discs or prerecorded video cassettes.</p>	<ul style="list-style-type: none">- This happens if you try to copy DVDs or video cassettes that have been copy-protected. Even though the picture on the TV is fine, but the recording on a DVD+R(W) is faulty. This interference is unavoidable with copy-protected DVDs or video cassettes.- The DVD+R(W) has recording lifetime, please change a new disc for recording.

Troubleshooting (cont'd)

Problem	Solution
The message 'NO SIGNAL' appears.	<ul style="list-style-type: none">- Check that the cable is plugged in firmly.- If a recording is made from a video recorder, change the tracking on the video recorder.- The DVD recorder may not be able to recognize the video input signal if this signal is poor or does not comply with relevant standards.
The message 'Recording of <XX> will start within 1 minute' appears.	<ul style="list-style-type: none">- Select { Switch now } to switch the DVD recorder to standby mode. A programmed timer recording will only start recording if the DVD recorder is in standby mode.- Select { Suspend } will suspend the timer recording.- Select { Cancel recording } will cancel the timer recording.
The message 'Insert recordable disc' appears.	<ul style="list-style-type: none">- Either no disc was inserted or a disc was inserted that cannot be used for recordings. Insert a disc that can be recorded upon. Locate on the disc the right position for the recording. Press STOP button. Turn off the DVD recorder by pressing STANDBY-ON button.
The message 'Maximum number of timers reached' appears.	<ul style="list-style-type: none">- It has reached the maximum programmed, no more recordings are allowed. Press TIMER button, select the programmed recording (TIMER block) you want to check or clear using ▲ ▼ button.
The message 'Collision' appears.	<ul style="list-style-type: none">- The timer recording overlaps with another timer recording.- If you ignore this warning, the programmed recording with the early start time will start first. The second recording will then lack the beginning.- Change the information for one of the two recordings.- Delete one of the two recordings.

Display panel symbols/messages

English

The following symbols/messages may appear on your DVD recorder display:



- **00:00**
Multifunction display/text line
 - Title/track number
 - Total/elapsed/remaining title/track time
 - Disc/title name
 - Error or warning messages
 - Additional information regarding the disc
 - TV channel number or source of video
 - Clock (This is displayed in Standby mode).
 - TV program title
- **|||||**
 - **Disc bar:** Displays the current position on the disc.
 - **Play/Record:** The single flashing segment represents the current position of the disc pointer.
 - **Pause:** Indicated by the flashing segment on both sides of the current position.
 - **Stop:** Indicated by the flashing segment at the current position.
- **Y**
Tuner is selected as visible source.
- 
Disc is the current active source.
- **TV**
Modulator is turned off. The antenna signal (RF signal) is only connected to the TV when the modulator is turned off.
- **O(l)**
Remote control command for the DVD recorder has been received.
- **⌚ TIMER**
A timer recording has been programmed or is active.
- **BLOCKED**
The disc tray cannot be opened or closed due to some mechanical obstruction.

- **COMPATIBLE**
The DVD Recorder is busy making changes to make the disc DVD-compatible.
- **CLOSING**
Disc tray is closing.
- **COPY PRO**
The DVD/video cassette you are trying to copy is copy-protected.
- **DISC ERR**
An error occurred when writing the title. If this happens often, please clean the disc or use a new one.
- **DISC FULL**
Disc is full. There is no room for new recordings.
- **DISC UPDATE**
 - Updating of disc is done after the editing is complete.
 - Entire disc is being erased.
- **DISC WARN**
An error occurred when writing the title. The recording will continue, but the error will be skipped.
- **EMPTY DISC**
Inserted disc is new or has been completely erased (no recordings present).
- **FINALIZE**
The DVD+R disc is being finalized. The progress bar on the LED shows the status of the finalization process.
- **EMPTY TITLE**
An empty title was selected.
- **INFO DVD**
Information on the inserted DVD is displayed on the screen.
- **CREATE MENU**
After the first recording has been successfully complete on a new disc, the menu structure is created.

Display panel symbols/messages (cont'd)

- **IS THE TV ON?**
The DVD Recorder is currently in the first installation mode. Turn on your TV and read the section, 'First installation', in the chapter 'Installing the DVD Recorder'.
- **MAX TITLE**
The maximum number of titles has been reached for the disc. Each disc can have a maximum of 49 titles.
- **MAX CHAP**
The maximum number of chapters per title/disc has been reached. The maximum number of chapters per title is 99, and 255 per disc.
- **SYS MENU**
The on-screen menu display is on.
- **MENU UPDATE**
After a successful recording, the list of disc contents is updated.
- **NO DISC**
No disc has been inserted. If a disc has been inserted, then it is possible that the disc cannot be read.
- **NO SIGNAL**
No signal or poor signal strength.
- **NTSC DISC**
A disc with NTSC recordings has been inserted and an attempt was made to record a PAL signal. Insert a new disc or use a disc containing PAL recordings.
- **OPENING**
Disc tray is opening.
- **PAL DISC**
A disc with PAL recordings has been inserted and an attempt was made to record an NTSC signal. Insert a new disc or use a disc containing NTSC recordings.
- **PHOTO MMM/NNN**
Number of the current photo (for Photo mode). MMM represents the order of the current photo, NNN represents the total number of photos in the album. If the number exceeds 999, '999' will be displayed instead.
- **POST FORMAT**
The disc is being prepared after the menu structure has been created.
- **PROTECTED**
Disc is copy-protected and cannot be recorded.
- **READING**
Disc is being recognized by the DVD recorder.
- **RECORDING**
A recording is currently in progress.
- **SAFE RECORD**
The new recording will be added to the end of all recordings.
- **INSTALL**
After the automatic channel search, the menu for setting the time/date appears on the screen.
- **STANDBY**
The DVD recorder has been turned off.
- **TRAY OPEN**
Disc tray is open.
- **VCD**
AVCD has been loaded into the DVD recorder.
- **WAIT**
Please wait until this message disappears. The DVD Recorder is busy processing an operation.
- **TV DIRECT**
Modulator is turned off. The antenna (RF) signal is now fed to the TV.

Glossary

Analog: Sound that has not been turned into numbers. Analog sound varies, while digital sound has specific numerical values. These jacks send audio through two channels, the left and right.

Aspect ratio: The ratio of vertical and horizontal sizes of a displayed image. The horizontal vs. vertical ratio of conventional TVs. is 4:3, and that of wide-screens is 16:9.

AUDIO OUT Jacks: Red and white jacks on the back of the system that send audio to another system (TV, Stereo, etc.).

Chapter: Sections of a picture or a music piece on a DVD that are smaller than titles. A title is composed of several chapters. Each chapter is assigned a chapter number enabling you to locate the chapter you want.

Component Video Out Jacks: Jacks on the back of the DVD System that send high-quality video to a TV that has Component Video In jacks (R/G/B, Y/Pb/Pr, etc.).

Digital: Sound that has been converted into numerical values. Digital sound is available when you use the DIGITAL AUDIO OUT COAXIAL. These jacks send audio through multiple channels, instead of just two channels as analog does.

Disc menu: A screen display prepared for allowing selection of images, sounds, subtitles, multi-angles, etc recorded on a DVD.

Dolby Digital: A surround sound system developed by Dolby Laboratories containing up to six channels of digital audio (front left and right, surround left and right, center and subwoofer).

Index Picture Screen: A screen that gives an overview of a DVD+RW or DVD+R. An Index Picture represents each recording.

JPEG: A very common digital still picture format. A still-picture data compression system proposed by the Joint Photographic Expert Group, which features small decrease in image quality in spite of its high compression ratio.

MP3: A file format with a sound data compression system. "MP3" is the abbreviation of Motion Picture Experts Group 1 (or MPEG-1) Audio Layer 3. By using the MP3 format, one CD-R or CD-RW can contain about 10 times more data than a regular CD.

MPEG: Motion Picture Experts Group. A collection of compression systems for digital audio and video.

Multichannel: DVDs are formatted to have each sound track constitute one sound field. Multichannel refers to a structure of sound tracks having three or more channels.

PBC: Playback Control. Refers to the signal recorded on video CDs or SVCDs for controlling playback. By using menu screens recorded on a Video CD or SVCD that supports PBC, you can enjoy interactive playback and searching.

PCM: Pulse Code Modulation. A digital audio encoding system.

Parental control: Limits Disc play according to the age of the users or the limitation level in each country. The limitation varies from disc to disc; when it is activated, playback will be prohibited if the software's level is higher than the user-set level.

Region code: A system allowing discs to be played only in the region designated. This unit will only play discs that have compatible region codes. You can find the region code of your unit by looking on the product label. Some discs are compatible with more than one region (or ALL regions).

S-Video: Produces a clear picture by sending separate signals for the luminance and the color. You can use S-Video only if your TV has an S-Video In jack.

Surround: A system for creating realistic three-dimensional sound fields full of realism by arranging multiple speakers around the listener.

Title: The longest section of a movie or music feature on DVD. Each title is assigned a title number, enabling you to locate the title you want.

VIDEO OUT jack: Yellow jack on the back of the DVD system that sends the DVD picture video to a TV.

MAGNAVOX LIMITED WARRANTY

One (1) Year Labor and Parts Repair (Facility)

MAGNAVOX warrants this product against defect in material or workmanship, subject to any conditions set forth as follows:

PROOF OF PURCHASE:

You must have proof of the date of purchase to receive warranted repair on the product. A sales receipt or other document showing the product and the date that you purchased the product as well as the authorized retailer included, is considered such proof.

COVERAGE:

(If this product is determined to be defective)

LABOR: For a period of one (1) year from the date of purchase, Magnavox will repair or replace the product, at its option, at no charge, or pay the labor charges to the Magnavox authorized repair facility (see warranty service phone numbers in next column). After the period of one (1) year, Magnavox will no longer be responsible for charges incurred.

PARTS: For a period of one (1) year from the date of purchase, Magnavox will supply, at no charge, new or rebuilt replacement parts in exchange for defective parts. Magnavox authorized service facility will provide removal and installation of the parts for one (1) year.

EXCLUDED FROM WARRANTY COVERAGE

Your warranty does not cover:

- Labor charges for installation or setup of the product, adjustment of customer controls on the product, and installation or repair of antenna systems outside of the product.
- Product repair and/or part replacement because of improper installation, connections to improper voltage supply, abuse, neglect, misuse, accident, unauthorized repair or other cause not within the control of Magnavox.
- A product that requires modification or adaptation to enable it to operate in any country other than the country for which it was designed, manufactured, approved and/or authorized, or repair of products damaged by these modifications.
- Damage occurring to product during shipping when improperly packaged or costs associated with packaging.
- Product lost in shipment and no signature verification of receipt can be obtained.
- A product used for commercial or institutional purposes (including but not limited to rental purposes).
- Products sold AS IS or RENEWED.

SHIP-IN WARRANTY:

For Ship-In warranty repair, ship the product to a Magnavox authorized repair facility for repair in its original carton and packing material. If you do not have the original carton or packing material, have your product professionally packed for shipping. Ship product via a traceable carrier. When it is necessary for you to ship the product to Magnavox for repair, you will pay the shipping cost for shipment to Magnavox. Magnavox will pay the shipping costs when returning the product to you.

TO OBTAIN WARRANTY SERVICE IN THE U.S.A., PUERTO RICO, OR U.S. VIRGIN ISLANDS...

Contact Magnavox Customer Care Center at:

1-800-705-2000

TO OBTAIN WARRANTY SERVICE IN CANADA...

1-800-661-6162 (French Speaking)

1-800-705-2000 (English or Spanish Speaking)

REPAIR OR REPLACEMENT AS PROVIDED UNDER THIS WARRANTY IS THE EXCLUSIVE REMEDY FOR THE CONSUMER. MAGNAVOX SHALL NOT BE LIABLE FOR ANY INCIDENTAL OR CONSEQUENTIAL DAMAGES FOR BREACH OF ANY EXPRESS OR IMPLIED WARRANTY ON THIS PRODUCT. EXCEPT TO THE EXTENT PROHIBITED BY APPLICABLE LAW, ANY IMPLIED WARRANTY OF MERCHANTABILITY OR FITNESS FOR A PARTICULAR PURPOSE ON THIS PRODUCT IS LIMITED IN DURATION TO THE DURATION OF THIS WARRANTY.

Some states do not allow the exclusions or limitation of incidental or consequential damages, or allow limitations on how long an implied warranty lasts, so the above limitations or exclusions may not apply to you. In addition, if you enter into a service contract agreement with the MAGNAVOX partnership within ninety (90) days of the date of sale, the limitation on how long an implied warranty lasts does not apply.

This warranty gives you specific legal rights. You may have other rights which vary from state/province to state/province.

Magnavox, P.O. Box 671539, Marietta, GA. 30006-0026

(Warranty: 4835 710 27900)

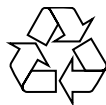

DVD RECORDER 660



3139 246 14762

Printed in China
SgpJP-0511-17-1