

OPT-24 Installation Guide

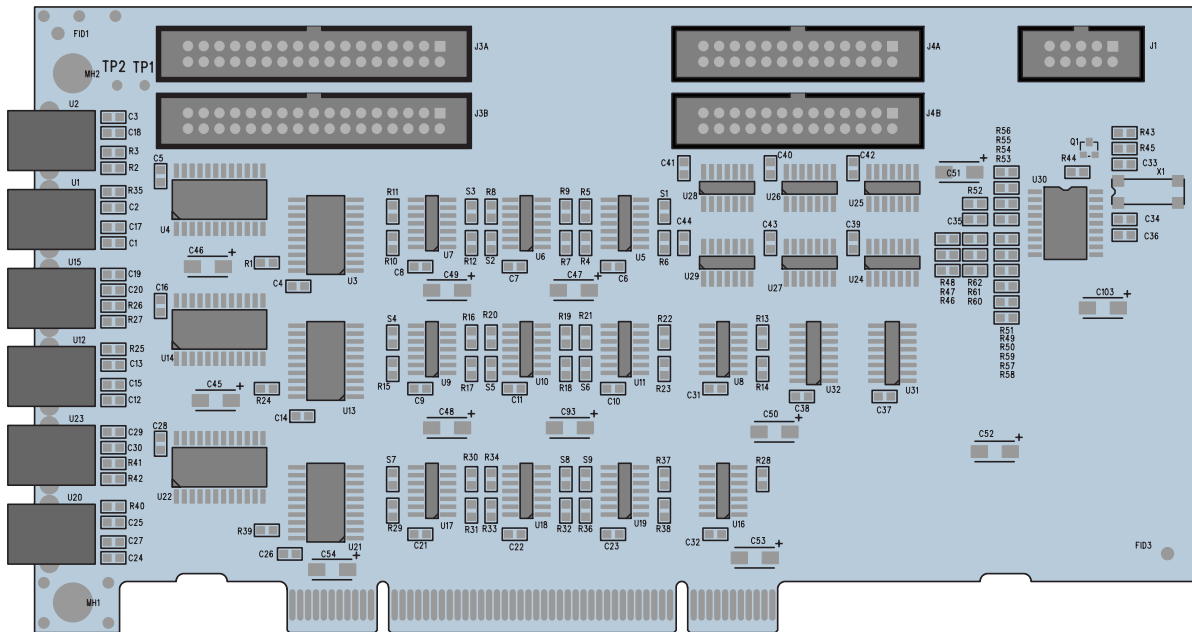

24-Channel 24-bit ADAT Optical I/O Card for the HDR24/96 and MDR24/96

MACKIE®

Important Safety Instructions Introduction

1. Read instructions — Read, understand and follow all safety and operating instructions before using this Mackie product.
2. Retain Instructions — Keep these safety and operating instructions for future reference.
3. Heed Warnings — Follow all warnings on this Mackie product and in these operating instructions.
4. Disconnect the power source to the HDR24/96 before installing the OPT•24 I/O Card.
5. Servicing — Do not attempt to service this Mackie product. All servicing should be referred to the Mackie Service Department.

ATTENTION: The installation of this option requires opening the HDR24/96 and handling sensitive electronic components. Anti-static precautions *must* be taken in order to prevent potential damage to the unit. Damage caused to the unit due to improper installation or handling of these components *will not be covered under warranty*. If you do not feel capable of performing this installation, please call Mackie Tech Support at 800-898-3211 to obtain a referral to a service center that can perform the installation.



Important: You must have version 1.3 or higher of the HDR24/96 or MDR24/96 OS in order to use the OPT•24. Follow the installation instructions with the software upgrade to install the new software.

Introduction

Thank you for choosing Mackie Designs for your hard disk recording solution. The OPT•24 is a major step forward in our continued support of the HDR24/96 and MDR24/96 Hard Disk Recorders.

The OPT•24 provides 24 channels (8x3) of 24-bit ADAT optical I/O. But what makes it especially unique and valuable is that it doesn't use any of the three I/O slots provided for the analog and digital I/O cards. Instead, it is installed in a PCI slot next to the Sync card. Once installed, you have the added flexibility of choosing between at least two different input and output formats for your recorded audio. For example, you can use three analog AIO•8 cards to bring the audio into the HDR, and use the OPT•24 to output the audio in 24-bit digital format.

Installing the OPT•24



Important: The OPT•24 contains static-sensitive components. Anti-static precautions *must* be taken before opening the anti-static bag and handling the OPT•24. Use an *anti-static wrist strap when performing this installation*. These are available at most computer supply stores. The use of an anti-static mat is also recommended.

- 1) Turn off the Hard Disk Recorder and remove the AC linecord from the socket on the rear panel. We don't want this to be a shocking experience for you!
- 2) Remove 22 screws from the HDR24/96 cover using a #2 Phillips screwdriver (4 screws from the top panel, 4 screws from each side, and 10 screws from the rear panel). These screws are all one size.

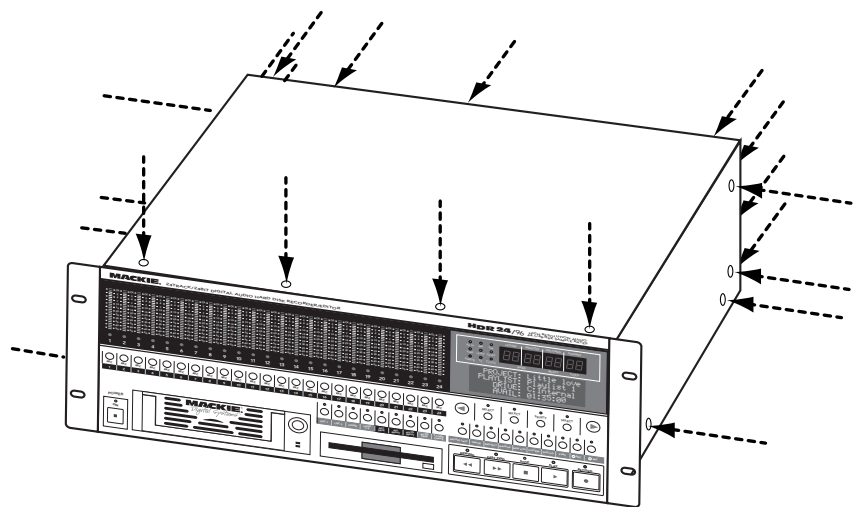

- 3) Remove the cover by lifting it up at the back and pulling up and away from the front of the unit.



- 4) Remove the blank cover plate for the ACC1 slot (next to the SYNC card) by removing 1 Phillips-head screw. Save the screw for installing the OPT•24.

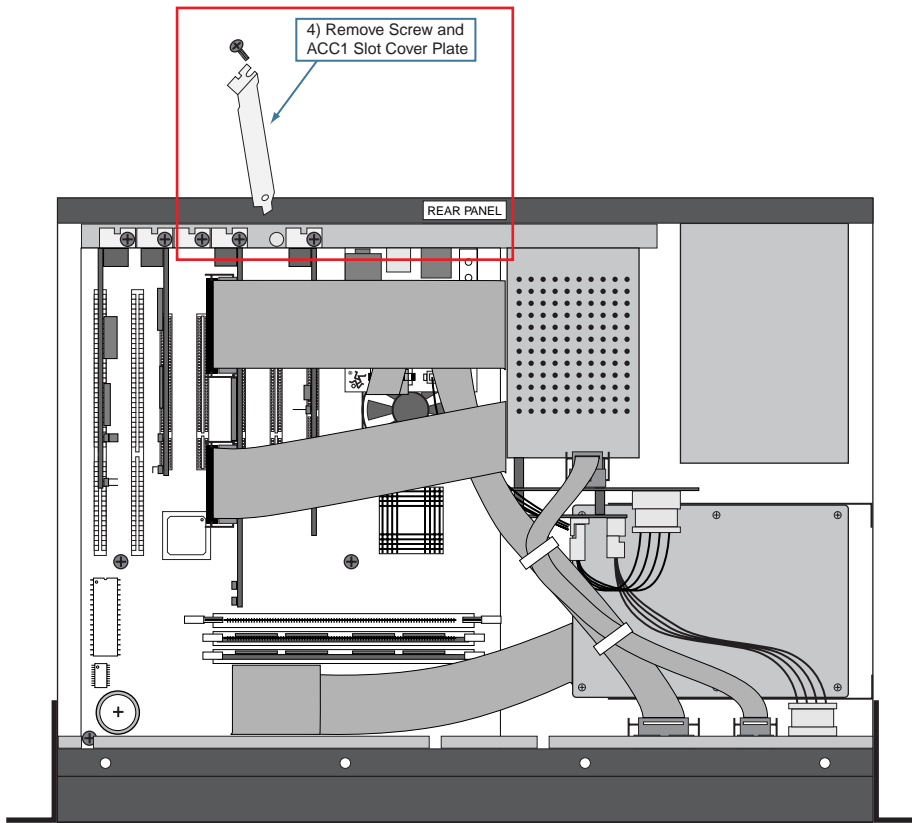

- 5) Unplug the 2 ribbon cables from the Sync card. Squeeze the tabs on the sides of the connectors and gently wiggle from side to side to release them from their sockets.

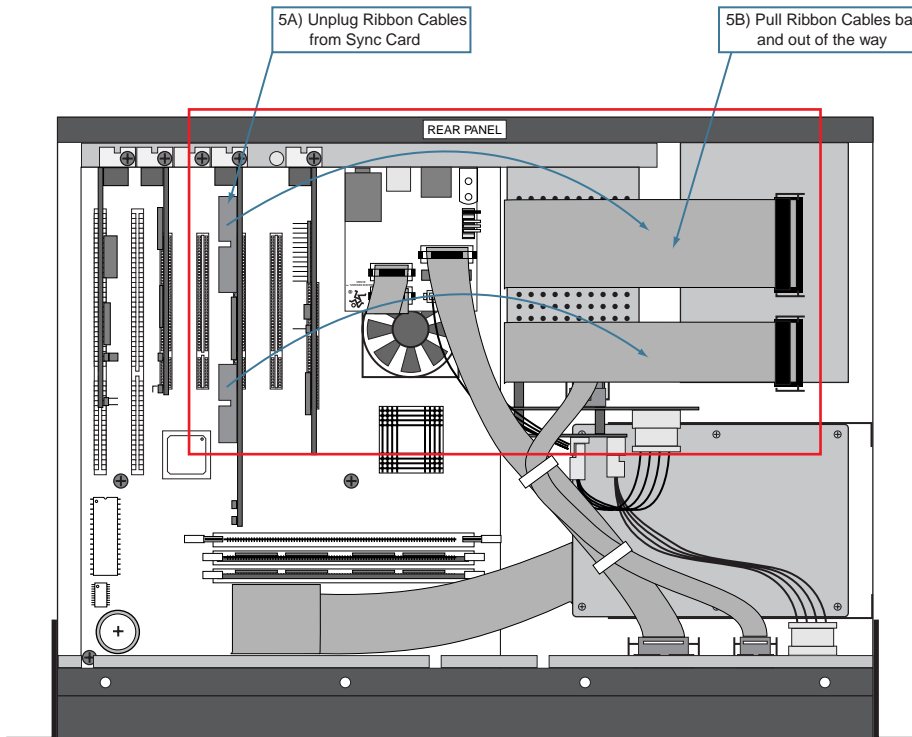

- 6) Unplug both ends of the COM cable (040-383-00), located between the front panel Display board (A) and the Card Cage board (B). Cable ties hold the COM cable in place. Leave the cable inside the HDR24/96 in case the OPT•24 is ever removed and the COM cable needs to be reconnected.

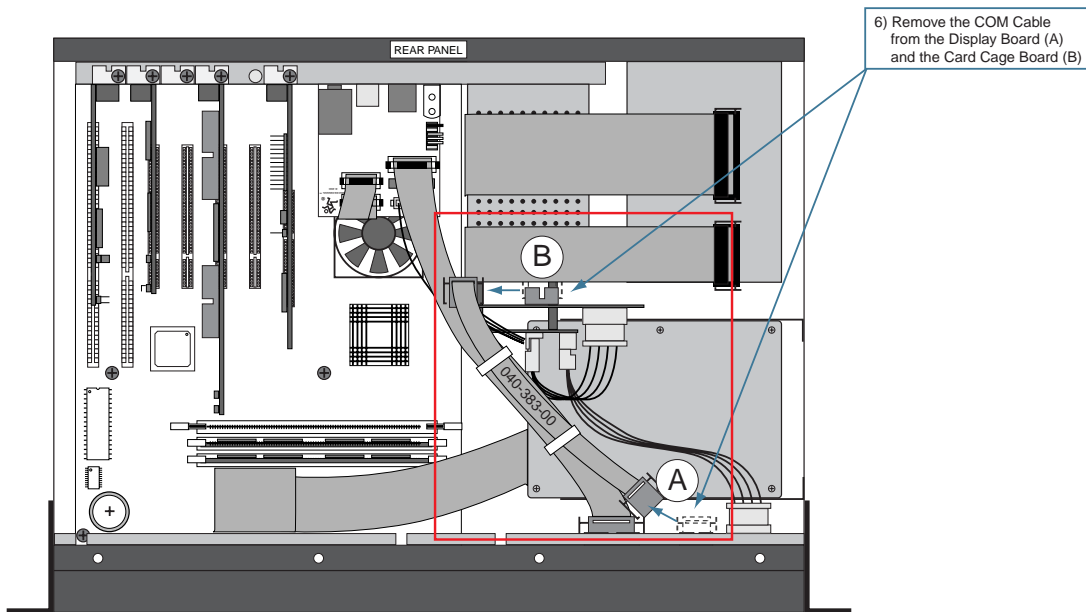

- 7) Connect the 2 short/fat ribbon cables (supplied) to the 2 bottom connectors (J3B and J4B, furthest from the edge) on the OPT•24. The connectors have a keying tab in the center so they can't be plugged in wrong. It doesn't matter which end of the ribbon cables you connect to the OPT•24.

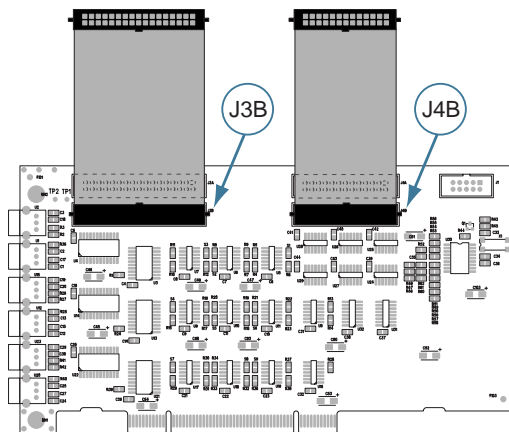

- 8) Connect the 2 ribbon cables that you removed from the Sync card to the 2 top connectors (J3A and J4A, closest to the edge) on the OPT•24. They will click in place when properly inserted.

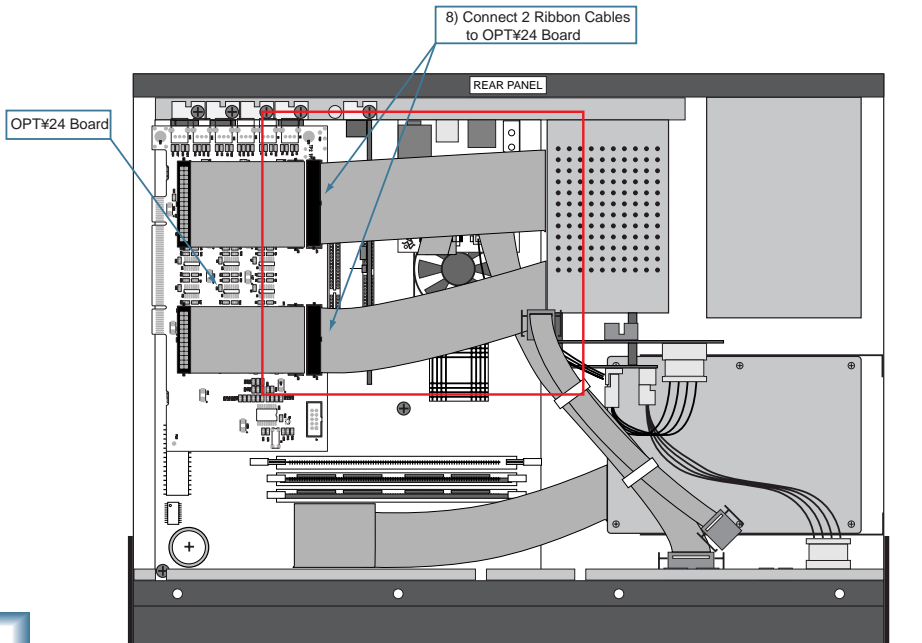

- 9) Install the OPT•24 into the ACC1 PCI slot by carefully aligning the card's gold-plated connector edge to the PCI slot on the motherboard and pushing down gently but firmly until the card is fully seated into the slot. It may help to gently rock the board front to back until the board is completely seated.

Note: Make sure the loose connector ends are pointing up so they can be accessed for step 11.

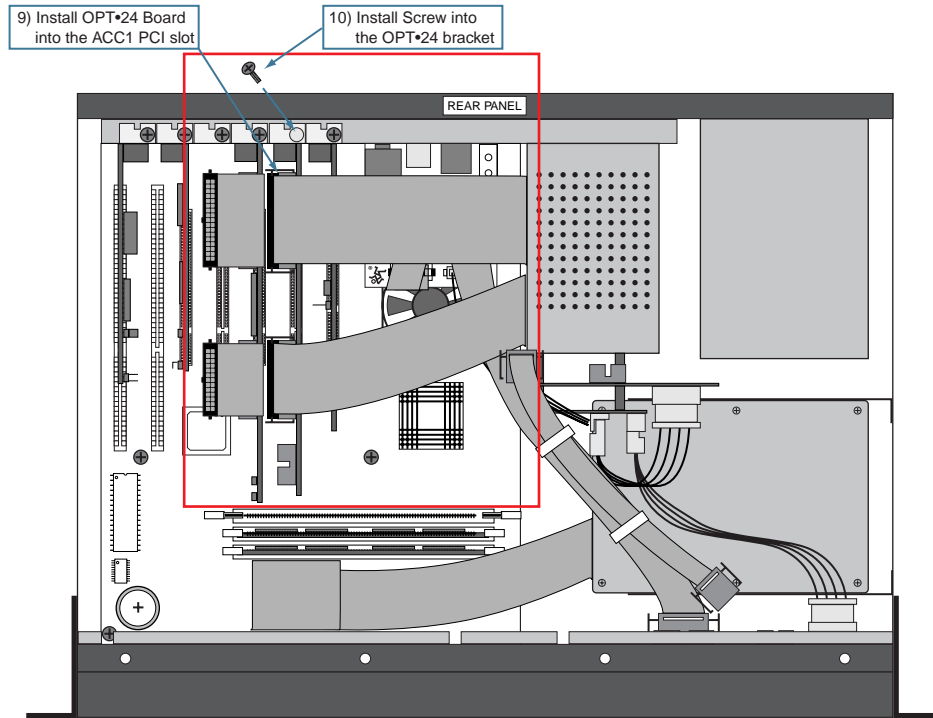

- 10) Install the screw that you removed from the blank cover plate to secure the OPT•24 to the HDR chassis.

- 11) Connect the short ribbon cables from the OPT•24 card to the adjacent Sync card by folding them over the top of the Sync card (see illustration below and on next page).

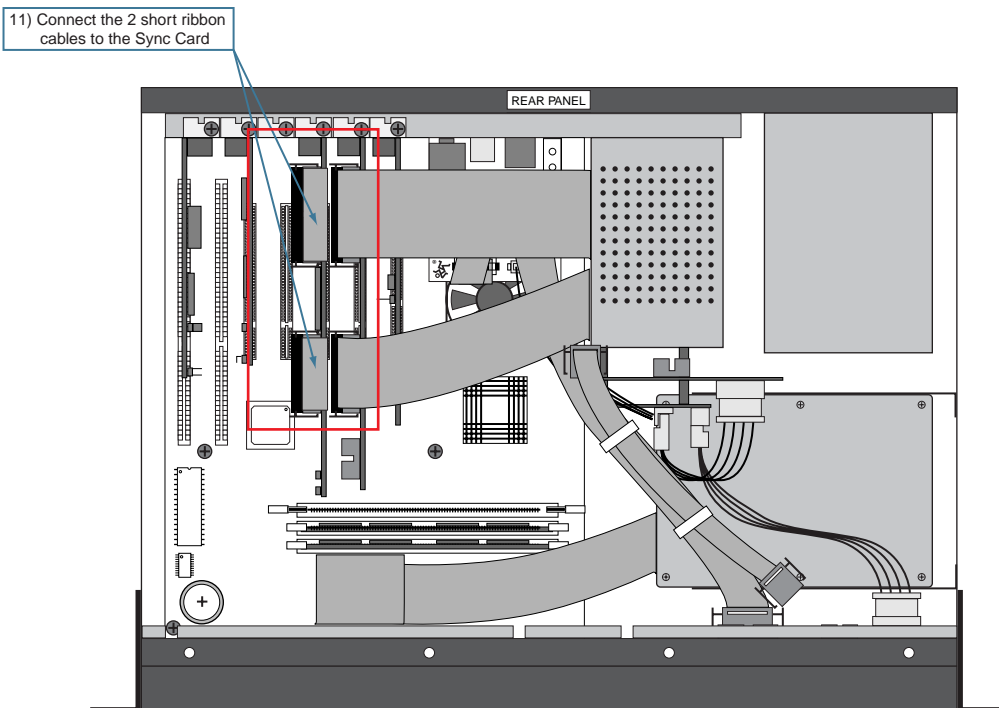

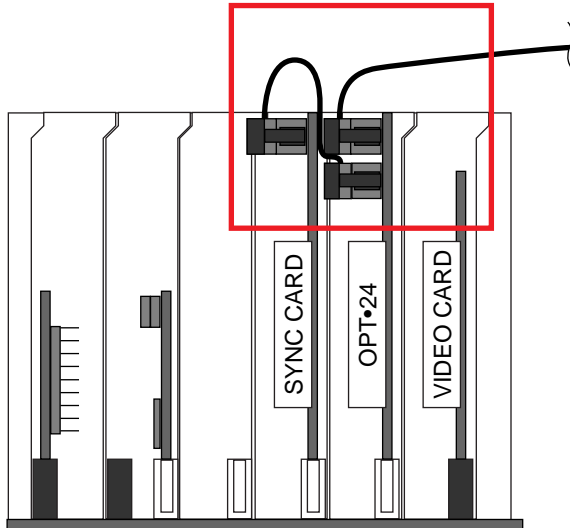

Front view of ribbon cable connections between the Sync Card and the OPT•24

- 12) Install the supplied replacement COM cable.
 - a. Install the center connector to the Card Cage board.
 - b. Install the shorter end to the front panel Display board.
 - c. Install the longer end to the OPT•24 board.

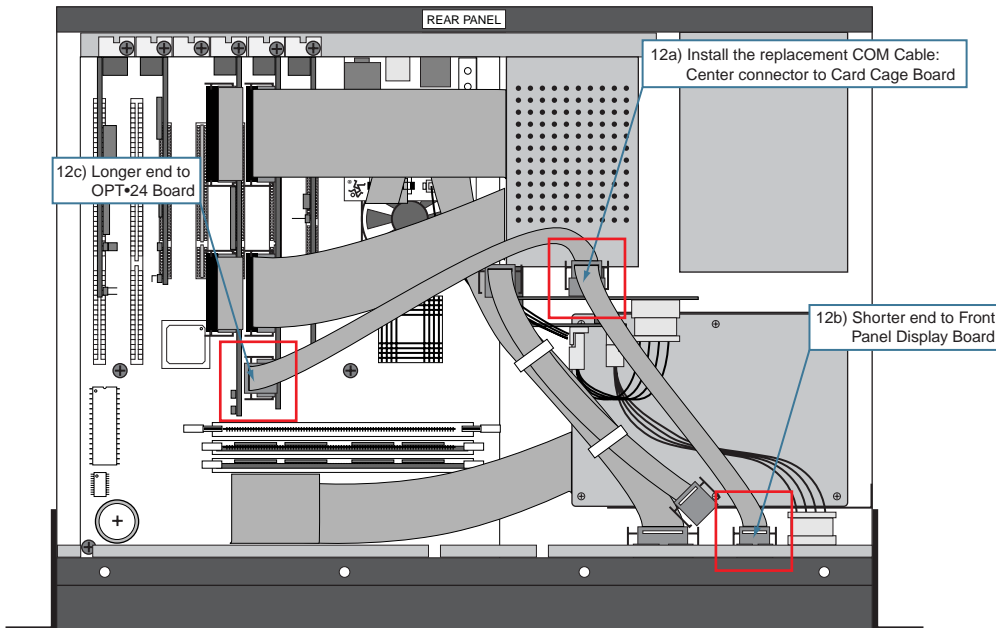

- 13) Replace the cover, reinstall the screws, and you're ready to go!

Selecting the OPT•24 I/O

This is done in the same way that you setup and configure the other I/O cards—in the Digital I/O Setup window (or by pressing the Digi-I/O button on the front panel).

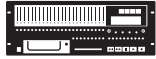

To select the OPT•24 from the front panel:

1. Press Digi-I/O to enter the Digital I/O Card Setup screen.

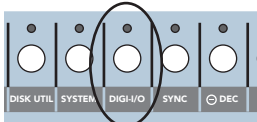

2. Select In. The Setup Tape Inputs screen shows you the current settings for each of the three I/O cards.

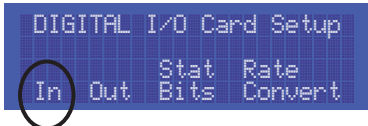

3. Press the Select button corresponding to each I/O card and toggle the selection to the desired input source.
4. The OPT•24 outputs are always active, so no configuration is necessary for the outputs.
5. When done, press the Digi-I/O button to exit the menu.

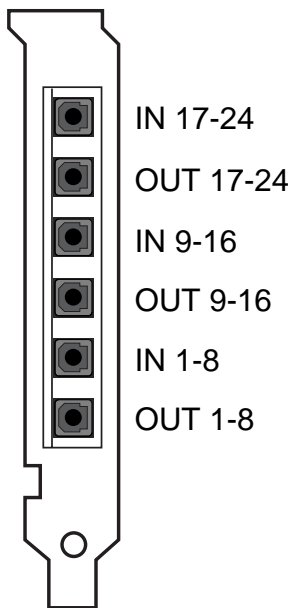

OPT•24 Inputs and Outputs

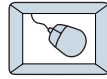

To select the OPT•24 from the screen (HDR24/96 only):

1. Select Setup from the Windows menu and click the Digital I/O icon. The Digital I/O Setup dialog box shows you the current settings for each of the three I/O cards.

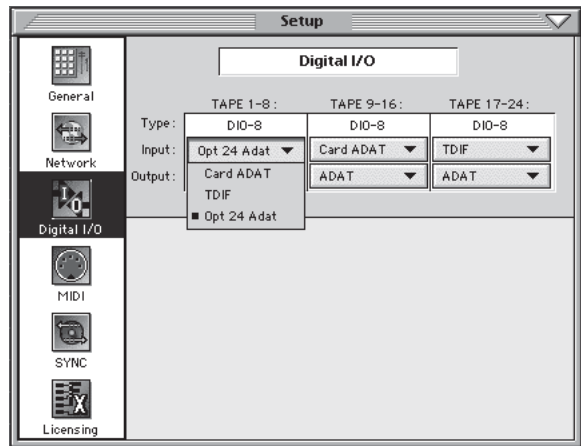

2. Click the Input pulldown menu and select the input source you want to use for each I/O card.
3. The OPT•24 outputs are always active, so no configuration is necessary for the outputs.

“Mackie,” the “Running Man” figure, and “OPT•24” are trademarks or registered trademarks of Mackie Designs Inc. All other brand names mentioned are trademarks or registered trademarks of their respective holders, and are hereby acknowledged.

© 2002 Mackie Designs Inc.
All Rights Reserved.
Printed in the U.S.A.

MACKIE®.

16220 Wood-Red Rd. NE • Woodinville, WA 98072 • USA
US & Canada: 800/898-3211
Europe, Asia, Central & South America: 425/487-4333
Middle East & Africa: 31-20-654-4000
Fax: 425/487-4337 • www.mackie.com
E-mail: sales@mackie.com