

AIR VANTAGE[®] 500 (AU)

For use with machine having Code Number: **11656**

Safety Depends on You

Lincoln arc welding and cutting equipment is designed and built with safety in mind. However, your overall safety can be increased by proper installation ... and thoughtful operation on your part. **DO NOT INSTALL, OPERATE OR REPAIR THIS EQUIPMENT WITHOUT READING THIS MANUAL AND THE SAFETY PRECAUTIONS CONTAINED THROUGHOUT.** And, most importantly, think before you act and be careful.

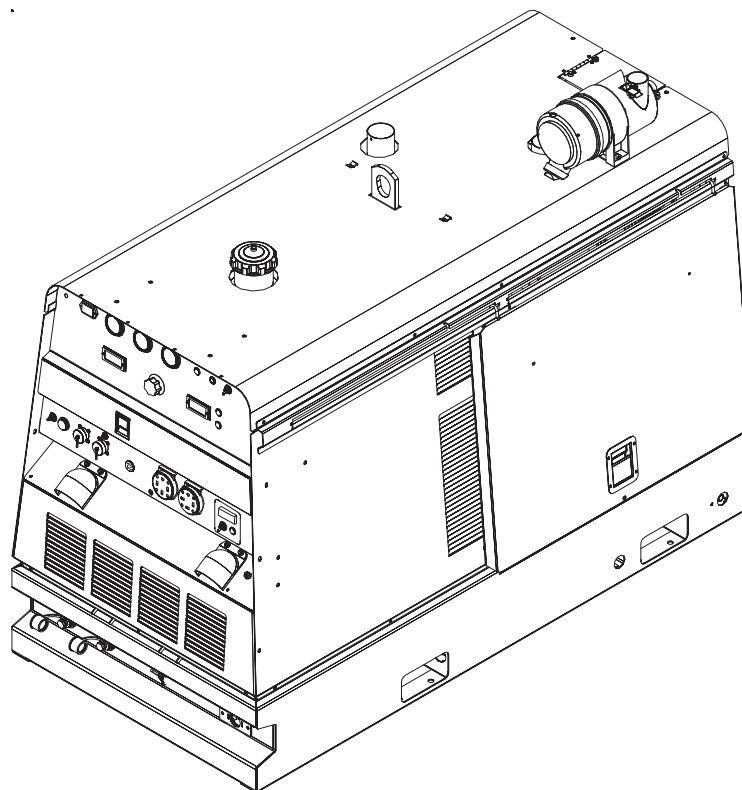

OPERATOR'S MANUAL



LINCOLN[®]
ELECTRIC

Copyright © Lincoln Global Inc.

• World's Leader in Welding and Cutting Products •

• Sales and Service through Subsidiaries and Distributors Worldwide •

Cleveland, Ohio 44117-1199 U.S.A. TEL: 216.481.8100 FAX: 216.486.1751 WEB SITE: www.lincolnelectric.com

⚠ WARNING

⚠ CALIFORNIA PROPOSITION 65 WARNINGS ⚠

Diesel engine exhaust and some of its constituents are known to the State of California to cause cancer, birth defects, and other reproductive harm.

The Above For Diesel Engines

The engine exhaust from this product contains chemicals known to the State of California to cause cancer, birth defects, or other reproductive harm.

The Above For Gasoline Engines

ARC WELDING CAN BE HAZARDOUS. PROTECT YOURSELF AND OTHERS FROM POSSIBLE SERIOUS INJURY OR DEATH. KEEP CHILDREN AWAY. PACEMAKER WEARERS SHOULD CONSULT WITH THEIR DOCTOR BEFORE OPERATING.

Read and understand the following safety highlights. For additional safety information, it is strongly recommended that you purchase a copy of "Safety in Welding & Cutting - ANSI Standard Z49.1" from the American Welding Society, P.O. Box 351040, Miami, Florida 33135 or CSA Standard W117.2-1974. A Free copy of "Arc Welding Safety" booklet E205 is available from the Lincoln Electric Company, 22801 St. Clair Avenue, Cleveland, Ohio 44117-1199.

BE SURE THAT ALL INSTALLATION, OPERATION, MAINTENANCE AND REPAIR PROCEDURES ARE PERFORMED ONLY BY QUALIFIED INDIVIDUALS.



FOR ENGINE powered equipment.

1.a. Turn the engine off before troubleshooting and maintenance work unless the maintenance work requires it to be running.



1.b. Operate engines in open, well-ventilated areas or vent the engine exhaust fumes outdoors.



1.c. Do not add the fuel near an open flame welding arc or when the engine is running. Stop the engine and allow it to cool before refueling to prevent spilled fuel from vaporizing on contact with hot engine parts and igniting. Do not spill fuel when filling tank. If fuel is spilled, wipe it up and do not start engine until fumes have been eliminated.

1.d. Keep all equipment safety guards, covers and devices in position and in good repair. Keep hands, hair, clothing and tools away from V-belts, gears, fans and all other moving parts when starting, operating or repairing equipment.

1.e. In some cases it may be necessary to remove safety guards to perform required maintenance. Remove guards only when necessary and replace them when the maintenance requiring their removal is complete. Always use the greatest care when working near moving parts.



1.f. Do not put your hands near the engine fan. Do not attempt to override the governor or idler by pushing on the throttle control rods while the engine is running.

1.g. To prevent accidentally starting gasoline engines while turning the engine or welding generator during maintenance work, disconnect the spark plug wires, distributor cap or magneto wire as appropriate.



1.h. To avoid scalding, do not remove the radiator pressure cap when the engine is hot.



ELECTRIC AND MAGNETIC FIELDS may be dangerous

2.a. Electric current flowing through any conductor causes localized Electric and Magnetic Fields (EMF). Welding current creates EMF fields around welding cables and welding machines

2.b. EMF fields may interfere with some pacemakers, and welders having a pacemaker should consult their physician before welding.

2.c. Exposure to EMF fields in welding may have other health effects which are now not known.

2.d. All welders should use the following procedures in order to minimize exposure to EMF fields from the welding circuit:

2.d.1. Route the electrode and work cables together - Secure them with tape when possible.

2.d.2. Never coil the electrode lead around your body.

2.d.3. Do not place your body between the electrode and work cables. If the electrode cable is on your right side, the work cable should also be on your right side.

2.d.4. Connect the work cable to the workpiece as close as possible to the area being welded.

2.d.5. Do not work next to welding power source.



ELECTRIC SHOCK can kill.

- 3.a. The electrode and work (or ground) circuits are electrically “hot” when the welder is on. Do not touch these “hot” parts with your bare skin or wet clothing. Wear dry, hole-free gloves to insulate hands.
- 3.b. Insulate yourself from work and ground using dry insulation. Make certain the insulation is large enough to cover your full area of physical contact with work and ground.
- In addition to the normal safety precautions, if welding must be performed under electrically hazardous conditions (in damp locations or while wearing wet clothing; on metal structures such as floors, gratings or scaffolds; when in cramped positions such as sitting, kneeling or lying, if there is a high risk of unavoidable or accidental contact with the workpiece or ground) use the following equipment:**
- Semiautomatic DC Constant Voltage (Wire) Welder.
 - DC Manual (Stick) Welder.
 - AC Welder with Reduced Voltage Control.
- 3.c. In semiautomatic or automatic wire welding, the electrode, electrode reel, welding head, nozzle or semiautomatic welding gun are also electrically “hot”.
- 3.d. Always be sure the work cable makes a good electrical connection with the metal being welded. The connection should be as close as possible to the area being welded.
- 3.e. Ground the work or metal to be welded to a good electrical (earth) ground.
- 3.f. Maintain the electrode holder, work clamp, welding cable and welding machine in good, safe operating condition. Replace damaged insulation.
- 3.g. Never dip the electrode in water for cooling.
- 3.h. Never simultaneously touch electrically “hot” parts of electrode holders connected to two welders because voltage between the two can be the total of the open circuit voltage of both welders.
- 3.i. When working above floor level, use a safety belt to protect yourself from a fall should you get a shock.
- 3.j. Also see Items 6.c. and 8.



ARC RAYS can burn.

- 4.a. Use a shield with the proper filter and cover plates to protect your eyes from sparks and the rays of the arc when welding or observing open arc welding. Headshield and filter lens should conform to ANSI Z87. 1 standards.
- 4.b. Use suitable clothing made from durable flame-resistant material to protect your skin and that of your helpers from the arc rays.
- 4.c. Protect other nearby personnel with suitable, non-flammable screening and/or warn them not to watch the arc nor expose themselves to the arc rays or to hot spatter or metal.



FUMES AND GASES can be dangerous.

- 5.a. Welding may produce fumes and gases hazardous to health. Avoid breathing these fumes and gases. When welding, keep your head out of the fume. Use enough ventilation and/or exhaust at the arc to keep fumes and gases away from the breathing zone. **When welding with electrodes which require special ventilation such as stainless or hard facing (see instructions on container or MSDS) or on lead or cadmium plated steel and other metals or coatings which produce highly toxic fumes, keep exposure as low as possible and within applicable OSHA PEL and ACGIH TLV limits using local exhaust or mechanical ventilation. In confined spaces or in some circumstances, outdoors, a respirator may be required. Additional precautions are also required when welding on galvanized steel.**
5. b. The operation of welding fume control equipment is affected by various factors including proper use and positioning of the equipment, maintenance of the equipment and the specific welding procedure and application involved. Worker exposure level should be checked upon installation and periodically thereafter to be certain it is within applicable OSHA PEL and ACGIH TLV limits.
- 5.c. Do not weld in locations near chlorinated hydrocarbon vapors coming from degreasing, cleaning or spraying operations. The heat and rays of the arc can react with solvent vapors to form phosgene, a highly toxic gas, and other irritating products.
- 5.d. Shielding gases used for arc welding can displace air and cause injury or death. Always use enough ventilation, especially in confined areas, to insure breathing air is safe.
- 5.e. Read and understand the manufacturer's instructions for this equipment and the consumables to be used, including the material safety data sheet (MSDS) and follow your employer's safety practices. MSDS forms are available from your welding distributor or from the manufacturer.
- 5.f. Also see item 1.b.

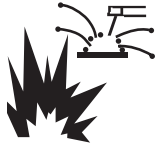

WELDING and CUTTING SPARKS can cause fire or explosion.

6.a. Remove fire hazards from the welding area. If this is not possible, cover them to prevent the welding sparks from starting a fire.

Remember that welding sparks and hot materials from welding can easily go through small cracks and openings to adjacent areas. Avoid welding near hydraulic lines. Have a fire extinguisher readily available.

- 6.b. Where compressed gases are to be used at the job site, special precautions should be used to prevent hazardous situations. Refer to "Safety in Welding and Cutting" (ANSI Standard Z49.1) and the operating information for the equipment being used.
- 6.c. When not welding, make certain no part of the electrode circuit is touching the work or ground. Accidental contact can cause overheating and create a fire hazard.
- 6.d. Do not heat, cut or weld tanks, drums or containers until the proper steps have been taken to insure that such procedures will not cause flammable or toxic vapors from substances inside. They can cause an explosion even though they have been "cleaned". For information, purchase "Recommended Safe Practices for the Preparation for Welding and Cutting of Containers and Piping That Have Held Hazardous Substances", AWS F4.1 from the American Welding Society (see address above).
- 6.e. Vent hollow castings or containers before heating, cutting or welding. They may explode.
- 6.f. Sparks and spatter are thrown from the welding arc. Wear oil free protective garments such as leather gloves, heavy shirt, cuffless trousers, high shoes and a cap over your hair. Wear ear plugs when welding out of position or in confined places. Always wear safety glasses with side shields when in a welding area.
- 6.g. Connect the work cable to the work as close to the welding area as practical. Work cables connected to the building framework or other locations away from the welding area increase the possibility of the welding current passing through lifting chains, crane cables or other alternate circuits. This can create fire hazards or overheat lifting chains or cables until they fail.
- 6.h. Also see item 1.c.
- 6.i. Read and follow NFPA 51B "Standard for Fire Prevention During Welding, Cutting and Other Hot Work", available from NFPA, 1 Batterymarch Park, PO box 9101, Quincy, Ma 02269-9101.
- 6.j. Do not use a welding power source for pipe thawing.



CYLINDER may explode if damaged.

- 7.a. Use only compressed gas cylinders containing the correct shielding gas for the process used and properly operating regulators designed for the gas and pressure used. All hoses, fittings, etc. should be suitable for the application and maintained in good condition.
- 7.b. Always keep cylinders in an upright position securely chained to an undercarriage or fixed support.
- 7.c. Cylinders should be located:
 - Away from areas where they may be struck or subjected to physical damage.
 - A safe distance from arc welding or cutting operations and any other source of heat, sparks, or flame.
- 7.d. Never allow the electrode, electrode holder or any other electrically "hot" parts to touch a cylinder.
- 7.e. Keep your head and face away from the cylinder valve outlet when opening the cylinder valve.
- 7.f. Valve protection caps should always be in place and hand tight except when the cylinder is in use or connected for use.
- 7.g. Read and follow the instructions on compressed gas cylinders, associated equipment, and CGA publication P-1, "Precautions for Safe Handling of Compressed Gases in Cylinders," available from the Compressed Gas Association 1235 Jefferson Davis Highway, Arlington, VA 22202.



FOR ELECTRICALLY powered equipment.

- 8.a. Turn off input power using the disconnect switch at the fuse box before working on the equipment.
- 8.b. Install equipment in accordance with the U.S. National Electrical Code, all local codes and the manufacturer's recommendations.
- 8.c. Ground the equipment in accordance with the U.S. National Electrical Code and the manufacturer's recommendations.

Refer to <http://www.lincolnelectric.com/safety> for additional safety information.

PRÉCAUTIONS DE SÛRETÉ

Pour votre propre protection lire et observer toutes les instructions et les précautions de sûreté spécifiques qui paraissent dans ce manuel aussi bien que les précautions de sûreté générales suivantes:

Sûreté Pour Soudage A L'Arc

1. Protégez-vous contre la secousse électrique:
 - a. Les circuits à l'électrode et à la pièce sont sous tension quand la machine à souder est en marche. Eviter toujours tout contact entre les parties sous tension et la peau nue ou les vêtements mouillés. Porter des gants secs et sans trous pour isoler les mains.
 - b. Faire très attention de bien s'isoler de la masse quand on soude dans des endroits humides, ou sur un plancher métallique ou des grilles métalliques, principalement dans les positions assis ou couché pour lesquelles une grande partie du corps peut être en contact avec la masse.
 - c. Maintenir le porte-électrode, la pince de masse, le câble de soudage et la machine à souder en bon et sûr état de fonctionnement.
 - d. Ne jamais plonger le porte-électrode dans l'eau pour le refroidir.
 - e. Ne jamais toucher simultanément les parties sous tension des porte-électrodes connectés à deux machines à souder parce que la tension entre les deux pinces peut être le total de la tension à vide des deux machines.
 - f. Si on utilise la machine à souder comme une source de courant pour soudage semi-automatique, ces précautions pour le porte-électrode s'appliquent aussi au pistolet de soudage.
2. Dans le cas de travail au dessus du niveau du sol, se protéger contre les chutes dans le cas où on recoit un choc. Ne jamais enrouler le câble-électrode autour de n'importe quelle partie du corps.
3. Un coup d'arc peut être plus sévère qu'un coup de soliel, donc:
 - a. Utiliser un bon masque avec un verre filtrant approprié ainsi qu'un verre blanc afin de se protéger les yeux du rayonnement de l'arc et des projections quand on soude ou quand on regarde l'arc.
 - b. Porter des vêtements convenables afin de protéger la peau de soudeur et des aides contre le rayonnement de l'arc.
 - c. Protéger l'autre personnel travaillant à proximité au soudage à l'aide d'écrans appropriés et non-inflammables.
4. Des gouttes de laitier en fusion sont émises de l'arc de soudage. Se protéger avec des vêtements de protection libres de l'huile, tels que les gants en cuir, chemise épaisse, pantalons sans revers, et chaussures montantes.
5. Toujours porter des lunettes de sécurité dans la zone de soudage. Utiliser des lunettes avec écrans latéraux dans les zones où l'on pique le laitier.

6. Eloigner les matériaux inflammables ou les recouvrir afin de prévenir tout risque d'incendie dû aux étincelles.
7. Quand on ne soude pas, poser la pince à un endroit isolé de la masse. Un court-circuit accidentel peut provoquer un échauffement et un risque d'incendie.
8. S'assurer que la masse est connectée le plus près possible de la zone de travail qu'il est pratique de le faire. Si on place la masse sur la charpente de la construction ou d'autres endroits éloignés de la zone de travail, on augmente le risque de voir passer le courant de soudage par les chaînes de levage, câbles de grue, ou autres circuits. Cela peut provoquer des risques d'incendie ou d'échauffement des chaînes et des câbles jusqu'à ce qu'ils se rompent.
9. Assurer une ventilation suffisante dans la zone de soudage. Ceci est particulièrement important pour le soudage de tôles galvanisées plombées, ou cadmiées ou tout autre métal qui produit des fumeés toxiques.
10. Ne pas souder en présence de vapeurs de chlore provenant d'opérations de dégraissage, nettoyage ou pistolage. La chaleur ou les rayons de l'arc peuvent réagir avec les vapeurs du solvant pour produire du phosgène (gas fortement toxique) ou autres produits irritants.
11. Pour obtenir de plus amples renseignements sur la sûreté, voir le code "Code for safety in welding and cutting" CSA Standard W 117.2-1974.

PRÉCAUTIONS DE SÛRETÉ POUR LES MACHINES À SOUDER À TRANSFORMATEUR ET À REDRESSEUR

1. Relier à la terre le chassis du poste conformément au code de l'électricité et aux recommandations du fabricant. Le dispositif de montage ou la pièce à souder doit être branché à une bonne mise à la terre.
2. Autant que possible, l'installation et l'entretien du poste seront effectués par un électricien qualifié.
3. Avant de faire des travaux à l'intérieur de poste, la débrancher à l'interrupteur à la boîte de fusibles.
4. Garder tous les couvercles et dispositifs de sûreté à leur place.

Electromagnetic Compatibility (EMC)

Conformance

Products displaying the CE mark are in conformity with European Community Council Directive of 15 Dec 2004 on the approximation of the laws of the Member States relating to electromagnetic compatibility, 2004/108/EC. It was manufactured in conformity with a national standard that implements a harmonized standard: EN 60974-10 Electromagnetic Compatibility (EMC) Product Standard for Arc Welding Equipment. It is for use with other Lincoln Electric equipment. It is designed for industrial and professional use.

Introduction

All electrical equipment generates small amounts of electromagnetic emission. Electrical emission may be transmitted through power lines or radiated through space, similar to a radio transmitter. When emissions are received by other equipment, electrical interference may result. Electrical emissions may affect many kinds of electrical equipment; other nearby welding equipment, radio and TV reception, numerical controlled machines, telephone systems, computers, etc. Be aware that interference may result and extra precautions may be required when a welding power source is used in a domestic establishment.

Installation and Use

The user is responsible for installing and using the welding equipment according to the manufacturer's instructions. If electromagnetic disturbances are detected then it shall be the responsibility of the user of the welding equipment to resolve the situation with the technical assistance of the manufacturer. In some cases this remedial action may be as simple as earthing (grounding) the welding circuit, see Note. In other cases it could involve construction of an electromagnetic screen enclosing the power source and the work complete with associated input filters. In all cases electromagnetic disturbances must be reduced to the point where they are no longer troublesome.

Note: The welding circuit may or may not be earthed for safety reasons according to national codes. Changing the earthing arrangements should only be authorized by a person who is competent to assess whether the changes will increase the risk of injury, e.g., by allowing parallel welding current return paths which may damage the earth circuits of other equipment.

Assessment of Area

Before installing welding equipment the user shall make an assessment of potential electromagnetic problems in the surrounding area. The following shall be taken into account:

- a) other supply cables, control cables, signaling and telephone cables; above, below and adjacent to the welding equipment;
- b) radio and television transmitters and receivers;
- c) computer and other control equipment;
- d) safety critical equipment, e.g., guarding of industrial equipment;
- e) the health of the people around, e.g., the use of pacemakers and hearing aids;
- f) equipment used for calibration or measurement
- g) the immunity of other equipment in the environment. The user shall ensure that other equipment being used in the environment is compatible. This may require additional protection measures;
- h) the time of day that welding or other activities are to be carried out.

Electromagnetic Compatibility (EMC)

The size of the surrounding area to be considered will depend on the structure of the building and other activities that are taking place. The surrounding area may extend beyond the boundaries of the premises.

Methods of Reducing Emissions

Mains Supply

Welding equipment should be connected to the mains supply according to the manufacturer's recommendations. If interference occurs, it may be necessary to take additional precautions such as filtering of the mains supply. Consideration should be given to shielding the supply cable of permanently installed welding equipment, in metallic conduit or equivalent. Shielding should be electrically continuous throughout its length. The shielding should be connected to the welding power source so that good electrical contact is maintained between the conduit and the welding power source enclosure.

Maintenance of the Welding Equipment

The welding equipment should be routinely maintained according to the manufacturer's recommendations. All access and service doors and covers should be closed and properly fastened when the welding equipment is in operation. The welding equipment should not be modified in any way except for those changes and adjustments covered in the manufacturer's instructions. In particular, the spark gaps of arc striking and stabilizing devices should be adjusted and maintained according to the manufacturer's recommendations.

Welding Cables

The welding cables should be kept as short as possible and should be positioned close together, running at or close to floor level.

Equipotential Bonding

Bonding of all metallic components in the welding installation and adjacent to it should be considered. However, metallic components bonded to the work piece will increase the risk that the operator could receive a shock by touching these metallic components and the electrode at the same time. The operator should be insulated from all such bonded metallic components.

Earthing of the Workpiece

Where the workpiece is not bonded to earth for electrical safety, not connected to earth because of its size and position, e.g., ships hull or building steelwork, a connection bonding the workpiece to earth may reduce emissions in some, but not all instances. Care should be taken to prevent the earthing of the workpiece increasing the risk of injury to users, or damage to other electrical equipment. Where necessary, the connection of the workpiece to earth should be made by a direct connection to the workpiece, but in some countries where direct connection is not permitted, the bonding should be achieved by suitable capacitance, selected according to national regulations.

Screening and Shielding

Selective screening and shielding of other cables and equipment in the surrounding area may alleviate problems of interference. Screening of the entire welding installation may be considered for special applications¹.

¹ Portions of the preceding text are contained in EN 60974-10: "Electromagnetic Compatibility (EMC) product standard for arc welding equipment."

Thank You

for selecting a **QUALITY** product by Lincoln Electric. We want you to take pride in operating this Lincoln Electric Company product ... as much pride as we have in bringing this product to you!

CUSTOMER ASSISTANCE POLICY

The business of The Lincoln Electric Company is manufacturing and selling high quality welding equipment, consumables, and cutting equipment. Our challenge is to meet the needs of our customers and to exceed their expectations. On occasion, purchasers may ask Lincoln Electric for advice or information about their use of our products. We respond to our customers based on the best information in our possession at that time. Lincoln Electric is not in a position to warrant or guarantee such advice, and assumes no liability, with respect to such information or advice. We expressly disclaim any warranty of any kind, including any warranty of fitness for any customer's particular purpose, with respect to such information or advice. As a matter of practical consideration, we also cannot assume any responsibility for updating or correcting any such information or advice once it has been given, nor does the provision of information or advice create, expand or alter any warranty with respect to the sale of our products.

Lincoln Electric is a responsive manufacturer, but the selection and use of specific products sold by Lincoln Electric is solely within the control of, and remains the sole responsibility of the customer. Many variables beyond the control of Lincoln Electric affect the results obtained in applying these types of fabrication methods and service requirements.

Subject to Change – This information is accurate to the best of our knowledge at the time of printing. Please refer to www.lincolnelectric.com for any updated information.

Please Examine Carton and Equipment For Damage Immediately

When this equipment is shipped, title passes to the purchaser upon receipt by the carrier. Consequently, Claims for material damaged in shipment must be made by the purchaser against the transportation company at the time the shipment is received.

Please record your equipment identification information below for future reference. This information can be found on your machine nameplate.

Product _____

Model Number _____

Code Number or Date Code _____

Serial Number _____

Date Purchased _____

Where Purchased _____

Whenever you request replacement parts or information on this equipment, always supply the information you have recorded above. The code number is especially important when identifying the correct replacement parts.

On-Line Product Registration

- Register your machine with Lincoln Electric either via fax or over the Internet.
- For faxing: Complete the form on the back of the warranty statement included in the literature packet accompanying this machine and fax the form per the instructions printed on it.
- For On-Line Registration: Go to our **WEB SITE at www.lincolnelectric.com**. Choose "Quick Links" and then "Product Registration". Please complete the form and submit your registration.

Read this Operators Manual completely before attempting to use this equipment. Save this manual and keep it handy for quick reference. Pay particular attention to the safety instructions we have provided for your protection. The level of seriousness to be applied to each is explained below:

⚠ WARNING

This statement appears where the information **must** be followed **exactly** to avoid **serious personal injury** or **loss of life**.

⚠ CAUTION

This statement appears where the information **must** be followed to avoid **minor personal injury** or **damage to this equipment**.

Installation.....	Section A
Technical Specifications	A-1
Safety Precautions	A-2
Location and Ventilation	A-2
Storing	A-2
Stacking	A-2
Angle of Operation	A-2
Lifting	A-3
High Altitude Operation	A-3
High Temperature Operation	A-3
Towing	A-3
Vehicle Mounting	A-3
Pre-Operation Engine and Compressor Service	A-4
Oil	A-4
Fuel and Fuel Cap	A-4
Engine Coolant System	A-4
Battery Connections	A-4
Muffler Outlet Pipe	A-5
Spark Arrestor	A-5
Air Cleaner Inlet Hood	A-5
Welding Terminals	A-5
Welding Output Cables	A-5
Machine Grounding	A-5
Remote Control	A-6
Auxiliary Power Receptacles and Standby Power Connections	A-6
Connection of Lincoln Electric Wire Feeders	A-7, A-8

Operation.....	Section B
Safety Precautions	B-1
General Description	B-1
Recommended Application - Welder, Air Compressor and Generator	B-1
Controls and Settings	B-2
Engine Controls	B-2, B-3
Welder Controls	B-4
Auxiliary Power Controls	B-4
Air Compressor Controls	B-5
Battery Jump Start Terminals	B-5
What are VRD and ROCV Devices	B-6
Welding Power Sources	B-6
Safety	B-6
VRD Operation Indicators	B-6
Operation	B-6
Starting Technique	B-7
Break-In Period	B-7
Typical Fuel Consumption	B-7
Welding Operation	B-8
Duty Cycle	B-8
Stick Welding Mode	B-8
CC-Stick Mode	B-8
Touch Start TIG Mode	B-8
AIR VANTAGE® Settings when using K930-2 TIG Module	B-8
Wire Welding-CV	B-9
Arc Gouging	B-9
Typical Current Ranges for Tungsten Electrodes	B-9
Paralleling	B-10
Auxiliary Power Operation	B-10
Simultaneous Welding and Auxiliary Power Loads	B-10
Simultaneous Welding and Power Loads, Extension Cord Length Recommendations	B-10

Accessories	Section c
Optional Field Installed Accessories.....	C-1
<hr/>	
Maintenance.....	Section D
Safety Precautions	D-1
Routine and Periodic Maintenance	D-1
Engine Maintenance.....	D-1
Air Filter	D-1, D-2
Fuel Filters	D-3
Cooling System.....	D-3
Battery Handling	D-3
Charging the Battery	D-4
Nameplate / Warning Decal Maintenance	D-4
Welder / Generator Maintenance	D-4
Engine Maintenance Components	D-4
<hr/>	
Troubleshooting	Section E
<hr/>	
Connection Diagrams, Wiring Diagrams and Dimension Print.....	Section F
<hr/>	
Parts List.....	P-661 Series
<hr/>	

TECHNICAL SPECIFICATIONS - AIR VANTAGE® 500 (AU) (K32012-1)

INPUT - DIESEL ENGINE					
Make/Model	Description	Speed (RPM)	Displacement cu. in. (ltrs.)	Starting System	Capacities
Cummins B3.3	4 cylinder 56 HP (42kw) 1800 RPM Diesel Engine	High Idle 1900	199(3.3)	12VDC Battery & starter	Fuel: 25 gal. (94.6 L) Oil: 2 gal. (7.5L) Radiator Coolant: 2.6gal. (9.8L)
		Full Load 1800	Bore x Stroke inch (mm)		
		Low Idle 1425	3.74 X 4.53 (95 x 115mm)		
RATED OUTPUT @ 104°F(40°C) - WELDER					
Duty Cycle	Welding Output		Volts at Rated Amps		
100%	500 Amps (DC multi-purpose)		40 Volts		
60%	550 Amps (DC multi-purpose)		36 volts		
50%	575 Amps (DC multi-purpose)		35 volts		
OUTPUT @ 104°F(40°C) - WELDER AND GENERATOR					
Welding Range					
30 - 575 Amps CC/CV 20 - 250 Amps TIG					
Open Circuit Voltage					
60 Max OCV @ 1900 RPM					
Auxiliary Power ⁽¹⁾					
2 x 240 VAC Receptacles 2 x 3600 Watts 60Hz Single Phase					
COMPRESSOR SPECIFICATIONS					
Compressor Model	Description	Delivary	Maximum System Pressure	Compressor Protection	Capacities
VMAC™ S700157	Belt-Drive Rotary Screw Air Compressor	High Idle Mode: 60 CFM @ 100PSI (28.3 Ltr/sec. @ 7.0 kg/cm) Low Idle Mode: 40 CFM @ 100PSI (18.9 Ltr/sec. @ 7.0 kg/cm)	150 PSI (10.5 kg/cm ²)	Safety Relief Valve 200 PSI (10.5 kg/cm ²) High Temperature Automatic Shutdown 290° F (143°C)	1.3 gal.(5.0 ltrs)
PHYSICAL DIMENSIONS					
Height ⁽²⁾	Width	Depth	Weight		
42.0 in (1066.8 mm)	32.7 in. (830.1mm)	63.1 in. (1603mm)	1690 lbs. (766kg) (Approx)		

- Output rating in watts is equivalent to volt-amperes at unity power factor.
Output voltage is within +/- 10% at all loads up to rated capacity. When welding, available auxiliary power will be reduced.
- Top of Enclosure, add 7.0" (177.8mm) for exhaust pipe.

AIR VANTAGE® 500 (AU)



SAFETY PRECAUTIONS

⚠ WARNING

Do not attempt to use this equipment until you have thoroughly read the engine manufacturer's manual supplied with your welder. It includes important safety precautions, detailed engine starting, operating and maintenance instructions, and parts lists.



ELECTRIC SHOCK can kill.

- Do not touch electrically live parts or electrode with skin or wet clothing.
- Insulate yourself from work and ground
- Always wear dry insulating gloves.



ENGINE EXHAUST can kill.

- Use in open, well ventilated areas or vent exhaust outside.



MOVING PARTS can injure.

- Do not operate with doors open or guards off.
- Stop engine before servicing.
- Keep away from moving parts.

See additional warning information at front of this operator's manual.

Only qualified personnel should install, use, or service this equipment.

LOCATION AND VENTILATION

The welder should be located to provide an unrestricted flow of clean, cool air to the cooling air inlets and to avoid restricting the cooling air outlets. Also, locate the welder so that the engine exhaust fumes are properly vented to an outside area.

⚠ CAUTION

DO NOT MOUNT OVER COMBUSTIBLE SURFACES

Where there is a combustible surface directly under stationary or fixed electrical equipment, that surface should be covered with a steel plate at least .06”(1.6mm) thick, which should extend not less than 5.90”(150mm) beyond the equipment on all sides.

STORING

1. Store the machine in a cool, dry place when it is not in use. Protect it from dust and dirt. Keep it where it can't be accidentally damaged from construction activities, moving vehicles, and other hazards.
2. Drain the engine oil and refill with fresh 10W30 oil. Run the engine for about five minutes to circulate oil to all the parts. See the MAINTENANCE section of this manual for details on changing oil.
3. Remove the battery, recharge it, and adjust the electrolyte level. Store the battery in a dry, dark place.

STACKING

AIR VANTAGE® 500 (AU) machines cannot be stacked.

ANGLE OF OPERATION

To achieve optimum engine performance the Air Vantage 500 (AU) should be run in a level position. The maximum angle of operation for the VMAC Compressor and CUMMINS engine is 20 degrees continues in all directions and 30 degrees intermittent (less than 10 minutes). When operating the welder at an angle, provisions must be made for checking and maintaining the oil level at the normal (FULL) oil capacity. Also the effective fuel capacity will be slightly less than the specified 25 gal.(94.6 ltrs.).

LIFTING

The AIR VANTAGE® 500 (AU) lift bale should be used to lift the machine. The Air Vantage 500 is shipped with the lift bale retracted. Before attempting to lift the AIR VANTAGE® 500 (AU) the lift bale must be secured in a raised position. Secure the lift bale as follows:

- Open the engine compartment door.
- Locate the 2 access holes on the upper middle region of compartment wall just below the lift bale.
- Use the lifting strap to raise the lift bale to the full upright position. This will align the mounting holes on the lift bale with the access holes.
- Secure the lift bale with 2 thread forming screws. The screws are provided in the shipped loose parts bag.

⚠ WARNING



- Lift only with equipment of adequate lifting capacity.
- Be sure machine is stable when lifting.
- Do not lift this machine using lift bail if it is equipped with a heavy accessory such as trailer or gas cylinder.
- Do not lift machine if lift bail is damaged.
- Do not operate machine while suspended from lift bail.

FALLING EQUIPMENT can cause injury.

HIGH ALTITUDE OPERATION

At higher altitudes, output derating may be necessary. For maximum rating, derate the welder output 4% for every 300 meters (984 ft.) above 1500 meters (4920 ft.). For output of 500A and below, derate the welder output 4% for every 300 meters (984 ft.) above 2100 meters (6888 ft.).

Contact a Cummins Service Representative for any engine adjustments that may be required.

HIGH TEMPERATURE OPERATION

At temperatures above 40°C (104°F), output voltage derating may be necessary. For maximum output current ratings, derate welder voltage rating 2 volts for every 10°C (21°F) above 40°C (104°F).

TOWING

The recommended trailer for use with this equipment for road, in-plant and yard towing by a vehicle ⁽¹⁾ is Lincoln's K2636-1. If the user adapts a non-Lincoln trailer, he must assume responsibility that the method of attachment and usage does not result in a safety hazard nor damage the welding equipment. Some of the factors to be considered are as follows:

- Design capacity of trailer vs. weight of Lincoln equipment and likely additional attachments.
- Proper support of, and attachment to, the base of the welding equipment so that there will be no undue stress to the trailer's framework.
- Proper placement of the equipment on the trailer to insure stability side to side and front to back when being moved and when standing by itself.
- Typical conditions of use, such as travel speed, roughness of surface on which the trailer will be operated, and environmental conditions.
- Proper preventative maintenance of trailer.
- Conformance with federal, state and local laws⁽¹⁾.

⁽¹⁾Consult applicable federal, state and local laws regarding specific requirements for use on public highways.

VEHICLE MOUNTING

⚠ WARNING

Improperly mounted concentrated loads may cause unstable vehicle handling and tires or other components to fail.

- Only transport this Equipment on serviceable vehicles which are rated and designed for such loads.
- Distribute, balance and secure loads so vehicle is stable under conditions of use.
- Do not exceed maximum rated loads for components such as suspension, axles and tires.
- Mount equipment base to metal bed or frame of vehicle.
- Follow vehicle manufacture's instructions.

PRE-OPERATION ENGINE AND COMPRESSOR SERVICE

READ the engine and compressor operating and maintenance instructions supplied with this machine.

WARNING



- Keep hands away from the engine muffler or HOT engine parts.
- Stop engine and allow to cool before fuelling.
- Do not smoke when fuelling.
- Fill fuel tank at a moderate rate and do not over-fill.
- Wipe up spilled fuel and allow fumes to clear before starting engine.
- Keep sparks and flame away from tank.

OIL



The AIR VANTAGE® 500 (AU) is shipped with the engine crankcase filled with high quality SAE 10W-30 oil (API class CD or better). Check the engine and compressor oil levels before starting the engine. If it is not up to the full mark on the dip stick, add oil as required. Check the oil level every four hours of running time during the first 35 running hours. Refer to the engine and compressor Operator's Manuals for specific oil recommendations and break-in information. The oil change interval is dependent on the quality of the oil and the operating environment. Refer to the engine and compressor Operator's Manuals for the proper service and maintenance intervals.

FUEL USE DIESEL FUEL ONLY



- Fill the fuel tank with clean, fresh diesel fuel. The capacity of the fuel tank is approximately 25 gallons (95 liters). See engine Operator's Manual for specific fuel recommendations. **Running out of fuel may require bleeding the fuel injection pump.**

NOTE: Before starting the engine, open the fuel shut-off valve (pointer to be in line with hose).

FUEL CAP

Remove the plastic cap covering from the Fuel Tank Filler neck and install the Fuel Cap.

ENGINE COOLANT

WARNING



HOT COOLANT can burn skin.

- Do not remove cap if radiator is hot.

The welder is shipped with the engine and radiator filled with a 50% mixture of ethylene glycol and water. See the MAINTENANCE section and the engine Operator's Manual for more information on coolant.

BATTERY CONNECTION

WARNING



GASES FROM BATTERY can explode.

- Keep sparks, flame and cigarettes away from battery.

To prevent **EXPLOSION** when:

- **INSTALLING A NEW BATTERY** — disconnect negative cable from old battery first and connect to new battery last.
- **CONNECTING A BATTERY CHARGER** — remove battery from welder by disconnecting negative cable first, then positive cable and battery clamp. When reinstalling, connect negative cable last. Keep well ventilated.
- **USING A BOOSTER** — connect positive lead to battery first then connect negative lead to negative battery lead at engine foot.

BATTERY ACID can burn eyes and skin.



- Wear gloves and eye protection and be careful when working near battery.
- Follow instructions printed on battery.

IMPORTANT: To prevent **ELECTRICAL DAMAGE** WHEN:

- Installing new batteries.
- Using a booster.

Use correct polarity — **Negative Ground**.

The AIR VANTAGE® 500 (AU) is shipped with the negative battery cable disconnected. Before you operate the machine, make sure the Engine Switch is in the **OFF** position and attach the disconnected cable securely to the negative (-) battery terminal.

Remove the insulating cap from the negative battery terminal. Replace and tighten negative battery cable terminal. **NOTE:** This machine is furnished with a wet charged battery; if unused for several months, the battery may require a booster charge. Be sure to use the correct polarity when charging the battery.

MUFFLER OUTLET PIPE

Remove the plastic plug covering the muffler outlet tube. Using the clamp provided secure the outlet pipe to the outlet tube with the pipe positioned such that it will direct the exhaust in the desired position.

SPARK ARRESTOR

Some federal, state or local laws may require that petrol or diesel engines be equipped with exhaust spark arrestors when they are operated in certain locations where unarrested sparks may present a fire hazard. The standard muffler included with this welder has an internal spark arrestor. When required by local regulations, a suitable spark arrestor, must be installed and properly maintained.

⚠ CAUTION

An incorrect arrestor may lead to damage to the engine or adversely affect performance.

AIR CLEANER INLET HOOD

Remove the plastic plug covering the air cleaner inlet. Install the air cleaner inlet hood to the air cleaner.

WELDING TERMINALS

The AIR VANTAGE® 500 (AU) is equipped with a toggle switch for selecting "hot" welding terminals when in the "WELD TERMINALS ON" position or "cold" welding terminals when in the "REMOTELY CONTROLLED" position.

WELDING OUTPUT CABLES

With the engine off, route the electrode and work cables thru the strain relief bracket provided on the front of the base and connect to the terminals provided. These connections should be checked periodically and tightened if necessary.

Listed in Table A.1 are copper cable sizes recommended for the rated current and duty cycle. Lengths stipulated are the distance from the welder to work and back to the welder again. Cable sizes are increased for greater lengths primarily for the purpose of minimizing cable voltage drop.

Table A.1 Combined Length of Electrode and Work Cables.

TOTAL COMBINED LENGTH OF ELECTRODE AND WORK CABLES	
Cable Length	Cable Size for 500 Amps <u>100% Duty Cycle</u>
0-150 Ft. (0-46 meters)	3/0 AWG (95mm ²)
150-200 Ft. (46-61 meters)	3/0 AWG (95mm ²)
200-250 Ft. (61-76 meters)	4/0 AWG(120mm ²)

MACHINE GROUNDING

Because this portable engine driven welder creates its own power, it is not necessary to connect its frame to an earth ground, unless the machine is connected to premises wiring (home, shop, etc.).

To prevent dangerous electric shock, other equipment to which this engine driven welder supplies power must:

⚠ WARNING

- Be grounded to the frame of the welder using a grounded type plug or be double insulated.
- Do not ground the machine to a pipe that carries explosive or combustible material.

When this welder is mounted on a truck or trailer, its frame must be securely connected to the metal frame of the vehicle. When this engine driven welder is connected to premises wiring such as that in a home or shop, its frame must be connected to the system earth ground. See further connection instructions in the section entitled "Standby Power Connections" as well as the article on grounding in the latest National Electrical Code and the local codes.

In general, if the machine is to be grounded, it should be connected with a #8 or larger copper wire to a solid earth ground such as a metal ground stake going into the ground for at least 10 Feet or to the metal framework of a building which has been effectively grounded.

The National Electric Code lists a number of alternate means of grounding electrical equipment. A machine grounding stud marked with the symbol  is provided on the front of the welder.

REMOTE CONTROL

The AIR VANTAGE® 500 (AU) is equipped with a 6-pin and a 14-pin connector. The 6-pin connector is for connecting the K857 or K857-1 Remote Control or for TIG welding, the K870 foot Amptrol or the K963-3 hand Amptrol. When in the CC-STICK or CV-WIRE modes and when a remote control is connected to the 6-pin Connector, the auto-sensing circuit automatically switches the OUTPUT control from control at the welder to remote control.

When in TOUCH START TIG mode and when a Amptrol is connected to the 6-Pin Connector, the OUTPUT dial is used to set the maximum current range of the CURRENT CONTROL of the Amptrol.

In the CV-WIRE mode, if the feeder being used has a voltage control when the wire feeder control cable is connected to the 14-Pin Connector, the auto-sensing circuit automatically makes OUTPUT CONTROL inactive and the wire feeder voltage control active. Otherwise, the OUTPUT CONTROL is used to preset the voltage.

The 14-pin connector is used to directly connect a wire feeder control cable. In the CV-WIRE mode, when the control cable is connected to the 14-pin connector, the auto-sensing circuit automatically makes the Output Control inactive and the wire feeder voltage control active.

WARNING

NOTE: When a wire feeder with a built in welding voltage control is connected to the 14-pin connector, do not connect anything to the 6-pin connector.

AUXILIARY POWER RECEPTACLES

The auxiliary power capacity of the AIR VANTAGE® 500 (AU) is 7.2KW of 60Hz single phase power protected by an RCD (Residual Current Device) and 2 single phase 15 amp circuit breakers. The auxiliary power capacity in watts equivalent to volt-amperes at unity power factor.

This model has:

- 1 Residual Current Device (RCD) protection (30mA).
- 2 x 1 phase 15 amp Circuit Breakers.
- 2 x 1 phase 240 volt 15 amp per outlet.

Note: The single-phase outlets are from different phases and cannot be paralleled.

The auxiliary power receptacles should only be used with three grounded type plugs or approved double insulated tools. The current rating of any plug used with the system must be at least equal to the current capacity of the associated receptacle.

STANDBY POWER CONNECTIONS

The AIR VANTAGE® 500 (AU) is suitable for temporary, standby or emergency power using the engine manufacturer's recommended maintenance schedule.

The AIR VANTAGE® 500 (AU) can be permanently installed as a standby power unit for 240 volt (60Hz). Connections must be made by a licensed electrician who can determine how the 240 VAC power can be adapted to the particular installation and comply with all applicable electrical codes. The following information can be used as a guide by the electrician for most applications.

- 1 Install an isolation switch between the power company meter and the premises disconnect. (The AIR VANTAGE® 500 (AU) and the power company supplies must not be connected together).

Switch rating must be the same or greater than the customer's premises disconnect and service over current protection.

2. Take necessary steps to assure load is limited to the capacity of the AIR VANTAGE® 500 (AU). Loading above the rated output will reduce output voltage below the allowable -10% of rated voltage which may damage appliances or other motor-driven equipment and may result in overheating of the AIR VANTAGE® 500 (AU) engine.

CONNECTION OF LINCOLN ELECTRIC WIRE FEEDERS

WARNING

Shut off welder before making any electrical connections.

Connection of LN-7, LN-8 OR LN-742 to the AIR VANTAGE® 500 (AU)

1. Shut the welder off.
2. Connect the LN-7, LN-8 OR LN-742 per instructions on the appropriate connection diagram in Section F.
3. Set the "WIRE FEEDER VOLTMETER" switch to either "+" or "-" as required by the electrode being used.
4. Set the "MODE" switch to the "CV WIRE " position.
5. Set the "ARC CONTROL" knob to "0" initially and adjust to suit.
6. Set the "WELD TERMINALS" switch to the "REMOTELY CONTROLLED" position.
7. Set the "IDLE" switch to the "HIGH" position.

Connection of LN-15 to the AIR VANTAGE® 500 (AU)

These connections instructions apply to both the LN-15 Across-The-Arc and Control Cable models. The LN-15 has an internal contactor and the electrode is not energized until the gun trigger is closed. When the gun trigger is closed the wire will begin to feed and the welding process is started.

1. Shut the welder off.
2. For electrode Positive, connect the electrode cable to the "+" terminal of the welder and work cable to the "-" terminal of the welder. For electrode Negative, connect the electrode cable to the "-" terminal of the welder and work cable to the "+" terminal of the welder.

3. Across The-Arc Model:

- Attach the single lead from the front of the LN-15 to work using the spring clip at the end of the lead. This is a control lead to supply current to the wire feeder motor; it does not carry welding current.

- Set the "WELD TERMINALS" switch to "WELD TERMINALS ON".
- When the gun trigger is closed, the current sensing circuit will cause the AIR VANTAGE® 500 (AU) engine to go to the high idle speed, the wire will begin to feed and the welding process started. When welding is stopped, the engine will revert to low idle speed after approximately 12 seconds unless welding is resumed.

4. Control Cable Model:

- Connect Control Cable between Engine Welder and Feeder.
- Set the "WELD TERMINALS" switch to "REMOTELY CONTROLLED"
- Set the MODE switch to the "CV-WIRE " position.
- Set the "WIRE FEEDER VOLTMETER" switch to either "+" or "-" as required by the electrode polarity being used.
- Set the "ARC CONTROL" knob to "0" initially and adjust to suit.
- Set the "IDLE" switch to the "AUTO" position.
- When the gun trigger is closed, the current sensing circuit will cause the AIR VANTAGE® 500 (AU) engine to go to the high idle speed, the wire will begin to feed and the welding process started. When welding is stopped, the engine will revert to low idle speed after approximately 12 seconds unless welding is resumed.

CONNECTION OF THE LN-25 TO THE AIR VANTAGE® 500 (AU).

WARNING

Shut off welder before making any electrical connections.

The LN-25 with or without an internal contactor may be used with the AIR VANTAGE® 500 (AU). See the appropriate connection diagram in Section F.

NOTE: The LN-25 (K431) Remote Control Module and (K432) Remote Cable are not recommended for use with the AIR VANTAGE® 500 (AU).

1. **Shut the welder off.**
2. For electrode Positive, connect the electrode cable from the LN-25 to the "+" terminal of the welder and work cable to the "-" terminal of the welder. For electrode Negative, connect the electrode cable from the LN-25 to the "-" terminal of the welder and work cable to the "+" terminal of the welder.
3. Attach the single lead from the front of the LN-25 to work using the spring clip at the end of the lead. This is a control lead to supply current to the wire feeder motor; it does not carry welding current.
4. Set the MODE switch to the "CV-WIRE " position.
5. Set the "WELD TERMINALS" switch to "WELD TERMINALS ON"
6. Set the "ARC CONTROL" knob to "0" initially and adjust to suit.
7. Set the "IDLE" switch to the "AUTO" position. When not welding, the AIR VANTAGE® 500 (AU) engine will be at the low idle speed. If you are using an LN-25 with an internal contactor, the electrode is not energized until the gun trigger is closed.
8. When the gun trigger is closed, the current sensing circuit will cause the AIR VANTAGE® 500 (AU) engine to go to the high idle speed, the wire will begin to feed and the welding process started. When welding is stopped, the engine will revert to low idle speed after approximately 12 seconds unless welding is resumed.

CAUTION

If you are using an LN-25 without an internal contactor, the electrode will be energized when the AIR VANTAGE® 500 (AU) is started.

CONNECTION OF AN NA-3 AUTOMATIC WELDING SYSTEM TO THE AIR VANTAGE® 500 (AU)

For connection diagrams and instructions for connecting an NA-3 Welding System to the AIR VANTAGE® 500 (AU), refer to the NA-3 Welding System instruction manual. The connection diagram for the LN-8 can be used for connecting the NA-3.

- Set the Wire Feeder Voltage Switch to 115V.

CONNECTION OF MAGNUM SC SPOOL GUN TO THE AIR VANTAGE® 500 (AU) (SEE SECTION F)

Spool Gun (K487-25) and Cobramatic to AIR VANTAGE® 500 (AU)

- **Shut the welder off.**
- Connect per instructions on the appropriate connection diagram in Section F.

SAFETY PRECAUTIONS

Read and understand this entire section before operating your AIR VANTAGE® 500 (AU).

WARNING

Do not attempt to use this equipment until you have thoroughly read the engine manufacturer's manual supplied with your welder. It includes important safety precautions, detailed engine starting, operating and maintenance instructions, and parts lists.



ELECTRIC SHOCK can kill.

- Do not touch electrically live parts or electrode with skin or wet clothing.
- Insulate yourself from work and ground
- Always wear dry insulating gloves.



ENGINE EXHAUST can kill.

- Use in open, well ventilated areas or vent exhaust outside
- Do not stack anything near the engine.



MOVING PARTS can injure.

- Do not operate with doors open or guards off.
- Stop engine before servicing.
- Keep away from moving parts

- Only qualified personnel should operate this equipment.
- Always operate the welder with the sliding door closed and the side panels in place as these provide maximum protection from moving parts and insure proper cooling air flow.

GENERAL DESCRIPTION

The AIR VANTAGE® 500 (AU) is a diesel engine-driven welding power source. The machine uses a brush type alternating current generator for DC multi-purpose welding, for 240 VAC single phase. The AIR VANTAGE® 500 (AU) also has a rotary screw 60 cfm air compressor built in. The DC welding control system uses state of the art Chopper Technology  for superior welding performance.

RECOMMENDED APPLICATIONS

The AIR VANTAGE® 500 (AU) provides excellent constant current DC welding output for stick (SMAW) and TIG welding. The AIR VANTAGE® 500 (AU) also provides excellent constant voltage DC welding output for MIG (GMAW), Innershield (FCAW), Outershield (FCAW-G) and Metal Core welding. In addition the AIR VANTAGE® 500 (AU) can be used for Arc Gouging with carbons up to 3/8"(10mm) in diameter.

The AIR VANTAGE® 500 (AU) is **not recommended** for pipe thawing.

AIR COMPRESSOR

The AIR VANTAGE® 500 (AU) provides 60 cfm at 100 psi. compressed air for Arc Gouging and Air powered tools.

GENERATOR

The AIR VANTAGE® 500 (AU) provides smooth 240 VAC single phase output for auxiliary power and emergency standby power.

CONTROLS AND SETTINGS

All welder and engine controls are located on the case front panel. Refer to Figure B.1 and the explanations that follow.

FIGURE B.1

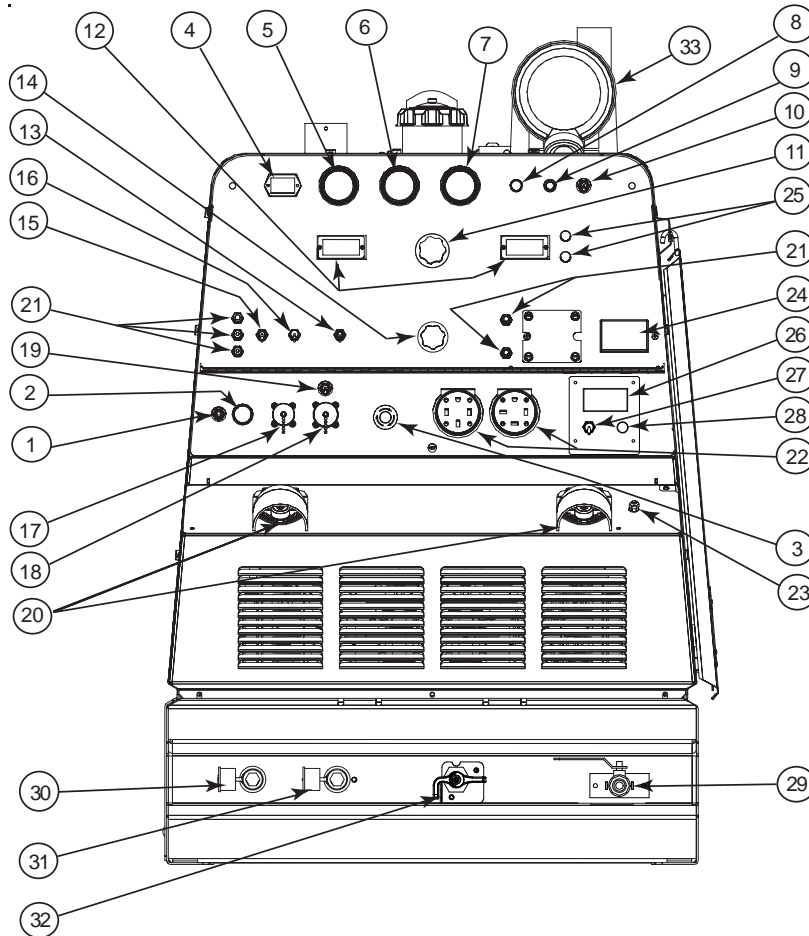

ENGINE CONTROLS (Items 1 through 9)

1. RUN STOP SWITCH

Toggling the switch to the RUN position energizes the fuel solenoid for approximately 30 seconds. The engine must be started within that time or the fuel solenoid will deenergize, and the switch must be toggled to reset the timer.

2. START PUSHBUTTON

Energizes the starter motor to crank the engine. With the engine "Run / Stop" switch in the "Run" position, push and hold the Start button to crank the engine; release as the engine starts. Do not press while engine is running since this can cause damage to the ring gear and/or starter motor.

3. ENGINE STOP SWITCH

Shut's down engine.

4. HOUR METER

The hour meter displays the total time that the engine has been running. This meter is a useful indicator for scheduling preventive maintenance.

5. FUEL LEVEL GAUGE

Displays the level of diesel fuel in the fuel tank.

The operator must watch the fuel level closely to prevent running out of fuel and possibly having to bleed the system.

6. ENGINE TEMPERATURE GAUGE

The gauge displays the engine coolant temperature.

7. OIL PRESSURE GAUGE



The gauge displays the engine oil pressure when the engine is running.

8. ENGINE PROTECTION

The yellow engine protection light remains off with proper oil pressure and under normal operating temperatures. If the light turns on, the engine protection system will stop the engine. Check for proper oil level and add oil if necessary. Check for loose or disconnected leads at the oil pressure sender located on the engine. The light will remain on when the engine has been shut down due to low oil pressure or over-temperature condition.



9. BATTERY CHARGING LIGHT



The yellow engine alternator light is off when battery charging system is functioning normally. If light turns on the alternator or the voltage regulator may not be operating correctly. The light will remain on when the engine is stopped and the run/stop switch is in the run position.

10. IDLER SWITCH

Has two positions as follows:

- A) In the "High" position , the engine runs at the high idle speed controlled by the governor.
- B) In the "Auto"  /  position, the idler operates as follows:
 - a. When switched from "High" to "Auto" or after starting the engine, the engine will operate at full speed for approximately 12 seconds and then go to low idle speed.
 - b. When the electrode touches the work or power is drawn for lights or tools (approximately 100 Watts minimum) the engine accelerates and operates at full speed.
 - c. When welding ceases and the AC power load is turned off, a fixed time delay of approximately 12 seconds starts.
 - d. If the welding or AC power load is not restarted before the end of the time delay, the idler reduces the engine speed to low idle speed.
 - e. The engine will automatically return to high idle speed when the welding load or AC power load is reapplied.

Idler Operational exceptions

When the WELDING TERMINALS switch is in the "Remotely Controlled" position the idler will operate as follows:

- a. When the triggering device (Amptrol, Arc Start Switch, etc.) is pressed the engine will accelerate and operate at full speed provided a welding load is applied within approximately 12 seconds.
 - If the triggering device remains pressed but no welding load is applied within approximately 12 seconds the engine may return to low idle speed.
 - If the triggering device is released or welding ceases the engine will return to low idle speed after approximately 12 seconds.

WELDING CONTROLS (Items 11 through 20)

11. OUTPUT CONTROL:

The OUTPUT dial is used to preset the output voltage or current as displayed on the digital meters for the four welding modes. When in the CC-STICK or CV-WIRE modes and when a remote control is connected to the 6-Pin or 14-Pin Connector, the auto-sensing circuit automatically switches the OUTPUT CONTROL from control at the welder to the remote control. In the CV-WIRE mode, when the wire feeder control cable is connected to the 14-Pin Connector, the auto-sensing circuit automatically makes OUTPUT CONTROL inactive and the wire feeder voltage control active.

When in the TOUCH START TIG mode and when a Amptrol is connected to the 6-Pin Connector, the OUTPUT dial is used to set the maximum current range of the CURRENT CONTROL of the Amptrol.

12. DIGITAL OUTPUT METERS:

The digital meters allow the output voltage (CV-WIRE mode) or current (CC-STICK and TIG modes) to be set prior to welding using the OUTPUT control knob. During welding, the meters display the actual output voltage (VOLTS) and current (AMPS). A memory feature holds the display of both meters on the seven seconds after welding is stopped. This allows the operator to read the actual current and voltage just prior to when welding was ceased. While the display is being held the left-most decimal point in each display will be flashing. The accuracy of the meters is $\pm 3\%$.

13. WELD MODE SELECTOR SWITCH:

(Provides 3 selectable welding modes)

- CV-WIRE
- CC-STICK
- TOUCH START TIG

14. ARC CONTROL:

The ARC CONTROL WIRE/STICK knob is active in the WIRE and STICK modes, and has different functions in these modes. This control is not active in the TIG mode.

CC-STICK mode: In this mode, the ARC CONTROL knob sets the short circuit current (arc-force) during stick welding. Increasing the number from -10(Soft) to +10(Crisp) increases the short circuit current and prevents sticking of the electrode to the plate while welding. This can also increase spatter. It is recommended that the ARC CONTROL be set to the minimum number without electrode sticking. Start with a setting at 0.

CV-WIRE mode: In this mode, turning the ARC CONTROL knob from -10(soft) to +10(crisp) changes the arc from soft and washed-in to crisp and narrow. It acts as an inductance/pinch control. The proper setting depends on the procedure and operator preference. Start with a setting of 0.

15. WELDING TERMINALS SWITCH:

In the WELD TERMINALS ON position, the output is electrically hot all the time. In the REMOTELY CONTROLLED position, the output is controlled by a wire feeder or amptrol device, and is electrically off until a remote switch is depressed.

 **WARNING**

- There is no VRD protection in the CV Mode.
- When the Toggle switch is in the “WELD TERMINAL ON” position the voltage at the output terminal maybe up to 60V.

16. WIRE FEEDER VOLTMETER SWITCH:

Matches the polarity of the wire feeder voltmeter to the polarity of the electrode.

17. 6 - PIN CONNECTOR:

For attaching optional remote control equipment. When in the CC-STICK and CV-WIRE modes and when a remote control is connected to the Connector, the auto-sensing circuit automatically switches the OUTPUT control from control at the welder to remote control.

18. 14-PIN CONNECTOR:

For attaching wire feeder control cable. Includes contactor closure circuit, auto-sensing remote control circuit, and 42VAC or 115VAC power. The remote control circuit operates the same as the 6-Pin Connector.

19. 42V / 115V WIRE FEEDER VOLTAGE SWITCH:

Toggles output of 14-pin connector to voltage requirement of Wire Feeder. (Located above 14-pin connector.)

20. WELD OUTPUT TERMINALS + AND -

These 1/2” - 13 studs with flange nuts provide welding connection points for the electrode and work cables. For positive polarity welding the electrode cable connects to the “+” terminal and the work cable connects to this “-” terminal. For negative polarity welding the work cable connects to the “+” terminal and the electrode cable connects to this “-” terminal.

AUXILIARY POWER CONTROLS

(Items 21-24)

21. CIRCUIT BREAKERS

These circuit breakers provide separate overload current protection for each 240V receptacles, the 42VAC and 115VAC in the 14-Pin connector and battery circuit overload protection.

22. 240 VAC RECEPTACLES

These two 240VAC receptacles provide up to 15 amp total rating each and are IP66 rated. Refer to the AUXILIARY POWER RECEPTACLES section in the installation chapter for further information about these receptacles. Also refer to the AUXILIARY POWER OPERATION section later in this chapter.

23. GROUND STUD:

Provides a connection point for connecting the machine case to earth ground. Refer to "MACHINE GROUNDING" in the Installation chapter for proper machine grounding information.

24. RCD:

"Residual Current Device" provides protection from active to ground contact.

RCD will not protect against electrical shock resulting from contact with active and neutral wires.

25. VRD INDICATOR LIGHTS:

Indicates OCV voltage across the output terminals. Also indicates operation of VRD in CC mode. A Green light indicates OCV below 30V and a red light indicates OCV above 30V.

During welding both lights will flash, depending on the type of Consumable being used.

AIR COMPRESSOR CONTROLS (26 THRU 29)**26. COMPRESSOR HOUR METER**

The compressor hour meter displays the total time that the compressor has been running (compressor switch must be on).

27. COMPRESSOR ON/OFF SWITCH

Turns compressor on and off activating or deactivating the electromagnetic compressor clutch.

28. COMPRESSOR PROTECTION LIGHT

The yellow compressor protection light remains off with proper compressor oil temperatures. If the lights turn on, the compressor protection system will deactivate the compressor clutch and put the system in standby mode until the temperature reaches allowable limits. Check for proper compressor oil level.

29. AIR DISCHARGE VALVE

Controls flow of compressed air. A 3/4" NPT (National Pipe Thread) fitting is provided.

BATTERY JUMP START TERMINAL (30-31)**30. POSITIVE BATTERY JUMP START TERMINAL.****31. NEGATIVE BATTERY JUMP START TERMINAL.**

12V battery jump start feature is standard. Covered output studs for convenient access, and protection against accidental impact. can be used to jump-start a utility truck with up to 800 cold cranking amps. Can also be used to jump-start the AIR VANTAGE® 500 (AU) Cummins.

32. BATTERY DISCONNECT SWITCH

Battery disconnect switch provides lockout/tagout capability. Switch is conveniently located on the front bottom of the machine.

33. AIR CLEANER AND SERVICE INDICATOR

Air cleaner service indicator provides a Go/No-Go visual indication of useful filter service life. Also located inside the engine compartment. (SEE FIGURE B.2)

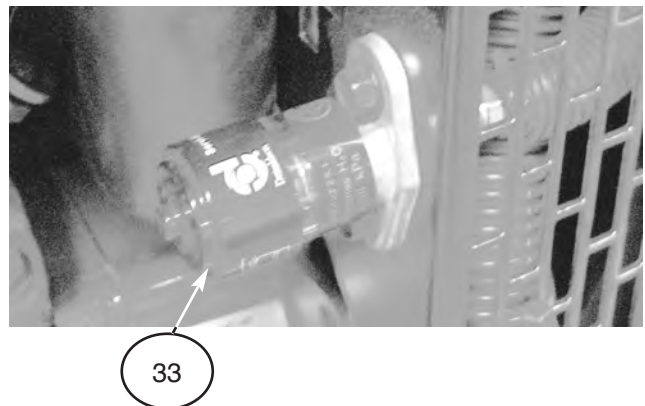
FIGURE B.2

WHAT ARE VRD AND ROCV DEVICES?

VRD's are gaining popularity as a "must have" safety accessory especially where welding applications are being carried out in an environment with a high-risk of electric shock such as wet areas and hot humid sweaty conditions.

VRD and **ROCV** are abbreviations for two different safety devices used in a welding power source to help protect the operator from electric shocks.

VRD stands for "**Voltage Reduction Device**" and **ROCV** stands for "**Reduced Open Circuit Voltage**". Both devices are used as an after market addition or part of the integral design of a machine. **VRD** and **ROCV** reduce the voltage at the welding output terminals when not welding to a no load voltage of less than 35V for DC welding and for AC welding 35V peak 25VAC RMS, when the resistance of the output circuit is in the range of 20-200 (ohms). The lower reactivation resistance of the device, the higher the safety level and also requires that the welding cable connections be kept in good electrical condition.

Having good electrical connections also limits the possibility of other safety issues such as heat-generated damage, burns and fires.

WELDING POWER SOURCES

Welding power sources generally have an Open Circuit Voltage (i.e. the voltage at the welding output terminals when not welding) in the range of 35-115VDC. Welding machines for stick welding (MMAW) and similar constant current (CC mode) processes supply a higher open circuit voltage between the electrode and the work when the welding machine is switched on and ready to commence welding. These welding machines have high open circuit voltage (typically 60-80V) then when the arc is established and welding current is drawn the voltage drops to 20-35V.

Consequently, the greatest danger occurs when handling the electrode and the electrode holder between welding operations, such as when changing electrodes.

Welding machines for MIG (GMAW & FCAW) have a flat constant voltage (CV) characteristic, generally with a lower open circuit voltage (30-50V). Also, the current is turned On and Off by a gun trigger, which also controls the wire feed. Therefore, the welder is not exposed to open circuit voltage unless the trigger is turned on and the wire is feeding. Also, electrodes are not changed as frequently as for stick welding (MMAW).

VRD/ROCV's are more commonly incorporated into the stick welding mode (CC) of the welding machines being used in environments with high-risk of electric shock.

SAFETY

The reduction of the voltage supplies a safer level of voltage when an arc is not being struck or when an electrical resistance less than the welder's body resistance have been detected. All **VRD's** are only an aid to safety, personal protective equipment and safe working practices must be observed at all times. The risk of electric shock during welding from a correctly installed and maintained welding machine is negligible, provided that sensible precautions are taken by the user and correct safe working procedures are followed. All of the welding output circuit should be considered electrically active (hot) and the welder should make sure that they do not become a part of that circuit to ground or they could receive a severe electric shock that could kill. Safe working procedures should always be followed whether a **VRD** is fitted or not.

VRD OPERATION INDICATOR

On the front panel of the Air Vantage 500 (AU) are two indicator lights. A **red** light when lit indicates voltage greater than >30V and a **green** light when lit indicates voltage less than <30V.

These lights monitor the OCV at all times. In the CC mode when the welding arc has stopped the **green** light will illuminate indicating that the VRD has reduced the OCV to less than 30V. During welding the **red** light will illuminate indicating that the OCV is greater than 30V. During welding the **red** and **green** light will flash on and off. This is normal operation as the welding voltage will produce less than 30V, depending on the process and type of electrode being used.

If the red light remains illuminated after welding in the CC mode, please refer to your local field service shop for service.

OPERATION

The low voltage safety features of the **VRD's** is to reduce the possibility of electric shock to the operator, a very slight delay during striking of the electrode may be experienced.

The high voltage that is available on units without **VRD's** allows them to penetrate and burn through dirty, painted and heavily mill scale plate. Units fitted with **VRD's** cannot penetrate and are required to register the correct resistance, which switches the safety device into weld mode.

AIR VANTAGE® 500 (AU)



Unlike other VRD's Lincoln uses micro processor control to monitor and establish the arc without the sticking and shorting of the electrode to the job as seen in many other VRD installations. Due to the requirement of the resistance in the circuit to be low, for a VRD to operate, a good metal-to-metal contact must be made between the metal core of the electrode and the job.

Any damaged connection anywhere in the output circuit may limit the operation of the VRD. This includes a good connection of the work return clamp and the job. The work return clamp should be connected close as practical to where the welding will be performed.

Some electrodes form a cone at the end of the electrode after the welding arc has been broken, particularly iron powder and low hydrogen electrodes.

This cone will need to be broken off in order to have the metal core of the electrode to make contact.

STARTING TECHNIQUE

The starting technique that has successfully overcome the problem is the push, twist, and peel technique. This technique requires the operator to push the electrode into the joint and twist.

The Push and Twist breaks off the cone and allows the metal electrode to make contact.

The peel and lift of the electrode establishes a controlled start to the welding arc. Normal welding technique for the application is then used.

BREAK-IN PERIOD

The engine used to supply power for your welder is a heavy duty, industrial engine. It is designed and built for rugged use. It is very normal for any engine to use small quantities of oil until the break-in is accomplished. Check the oil level twice a day during the break-in period. In general this takes 50 to 100 hours of operation.

IMPORTANT

IN ORDER TO ACCOMPLISH THIS BREAK-IN, THE UNIT SHOULD BE SUBJECTED TO HEAVY LOADS, WITHIN THE RATING OF THE MACHINE. AVOID LONG IDLE RUNNING PERIODS.

TYPICAL FUEL CONSUMPTION

Refer to Table B.1 for typical fuel consumption of the AIR VANTAGE® 500 (AU) Engine for various operating settings.

**Table B.1
Cummins B3.3 Engine Fuel Consumption**

	Cummins B3.3 56HP(42Kw) @1800 RPM	Running Time for 25GAL.(94.6L) (Hours)
Low Idle - no load 1425 RPM	.59 Gal./hour (2.2 L/hour)	42.4
High Idle - no load 1900 RPM	.87 Gal./hour (3.3 L/hour)	28.7
DC CC Weld Output 500 Amps @ 40 Volts	2.10 Gal./hour (7.9 L/hour)	11.9
Auxiliary Power 12,000 VA	1.44 Gal./hour (5.5 L/hour)	17.4
Air Compressor 60 CFM @ 100 PSI	1.29 Gal./hour (4.9 L/hour)	19.4
Air Compressor 60 CFM @ 100 PSI and DC, CC Weld Output 500 Amps @40 Volts	2.46 Gal./hour (9.3 L/hour)	10.2
Air Compressor 60 CFM @ 100 PSI and Auxiliary Power 12,000 VA	1.94 Gal./hour (7.3 L/hour)	12.9

NOTE: This data is for reference only. Fuel consumption is approximate and can be influenced by many factors, including engine maintenance, environmental conditions and fuel quality.

WELDER OPERATION

DUTY CYCLE

Duty Cycle is the percentage of time the load is being applied in a 10 minute period. For example a 60% duty cycle, represents 6 minutes of load and 4 minutes of no load in a 10 minute period.

STICK WELDING MODE

The AIR VANTAGE® 500 (AU) can be used with a broad range of DC stick electrodes. The MODE switch provides two stick welding settings as follows:

CC-STICK MODE

The CC-STICK position of the MODE switch is designed for horizontal, vertical-up and over head welding with all types of electrodes, especially low hydrogen. The OUTPUT CONTROL knob adjusts the full output range for stick welding.

The ARC CONTROL knob sets the short circuit (arc-force) current during stick welding. Increasing the number from -10(Soft) to +10(Crisp) increases the short circuit current and prevents sticking of the electrode to the plate while welding. This can also increase spatter. It is recommended that the ARC CONTROL be set to the minimum number without electrode sticking. Start with the knob set at 0.

TOUCH START TIG MODE

The AIR VANTAGE® 500 (AU) can be used in a wide variety of DC TIG welding applications.

The TOUCH START TIG setting of the MODE switch is for DC TIG (Tungsten Inert Gas) welding. To initiate a weld, the OUTPUT CONTROL knob is first set to the desired current and the tungsten is touched to the work. During the time the tungsten is touching the work there is very little voltage or current and, in general, avoids tungsten contamination. Then, the tungsten is gently lifted off the work in a rocking motion, which establishes the arc.

To stop the arc, simply lift the TIG torch away from the work piece. When the arc voltage reaches approximately 30 volts, the arc will go out and the machine will automatically reset to the touch start current level. The tungsten may then be retouched to the work piece to restrike the arc. The arc may also be started and stopped with an Amptrol or Arc Start Switch.

The ARC CONTROL is not active in the TIG mode.

In general the 'Touch Start' feature avoids tungsten contamination without the use of a Hi-frequency unit. If the use of a high frequency generator is desired, the K930-2 TIG Module can be used with the AIR VANTAGE® 500 (AU). The settings are for reference.

The AIR VANTAGE® 500 (AU) is equipped with the required R.F. bypass circuitry for the connection of high frequency generating equipment.

The AIR VANTAGE® 500 (AU) and any high frequency generating equipment must be properly grounded. See the K930-2 TIG Module operating manuals for complete instructions on installation, operation, and maintenance.

When using the TIG Module, the OUTPUT control on the AIR VANTAGE® 500 (AU) is used to set the maximum range of the CURRENT CONTROL on the TIG Module or an Amptrol if connected to the TIG Module.

AIR VANTAGE® 500 (AU) SETTINGS WHEN USING THE K930-2 TIG MODULE

- Set the WELD MODE switch to the "Touch Start Tig 20-250 Setting".
- Set the IDLER switch to the "AUTO" position.
- Set the WELDING TERMINALS switch to the "Remotely Controlled" position. This will keep the solid state contactor open and provide a "cold" electrode until the triggering device (Amptrol or Arc Start Switch) is pressed.

WIRE WELDING-CV

Connect a wire feeder to the AIR VANTAGE® 500 (AU) (AU) according to the instructions in INSTALLATION INSTRUCTIONS Section.

The AIR VANTAGE® 500 (AU) in the "CV-WIRE" position, permits it to be used with a broad range of flux cored wire (Innershield and Outershield) electrodes and solid wires for MIG welding (gas metal arc welding). Welding can be finely tuned using the "ARC CONTROL". Turning the ARC CONTROL clockwise from -10(soft) to +10(crisp) changes the arc from soft and washed-in to crisp and narrow. It acts as an inductance/pinch control.

The proper setting depends on the procedure and operator preference. Start with the knob set at 0.

For any electrodes, including the above recommendations, the procedures should be kept within the rating of the machine. For additional electrode information, See www.lincolnelectric.com or the appropriate Lincoln publication.

ARC GOUGING

For optimal performance when arc gouging, set the AIR VANTAGE® 500 (AU) "WELD MODE" switch to the "CC - STICK" position, and the "ARC CONTROL" to 10.

Set the "OUTPUT" knob to adjust output current to the desired level for the gouging electrode being used according to the ratings in the following Table B.2

TABLE B.2

Carbon Diameter	Current Range (DC, electrode positive)
1/8"(3.2mm)	30-60 Amps
5/32"(4.0mm)	90-150 Amps
3/16"(4.8mm)	200-250 Amps
1/4"(6.4mm)	300-400 Amps
5/16"(8.0mm)	350-450 Amps
3/8"(10.0mm)	450-575 Amps*

NOTE: If desired the CV mode can be used for Arc Gouging.

* Maximum current setting is limited to the AIR VANTAGE® 500 (AU) maximum of 575 Amps.

Table B.3 TYPICAL CURRENT RANGES ⁽¹⁾ FOR TUNGSTEN ELECTRODES ⁽²⁾

Tungsten Electrode Diameter mm (in)	DCEN (-)	DCEP (+)	Approximate Argon Gas Flow Rate l/min (c.f.m.)		TIG TORCH Nozzle Size (4), (5)
	1%, 2% Thoriated Tungsten	1%, 2% Thoriated Tungsten	Aluminium	Stainless Steel	
.25 (0.010)	2-15	(3)	2-4 (3-8)	2-4 (3-8)	#4, #5, #6
.50 (0.020)	5-20	(3)	3-5 (5-10)	3-5 (5-10)	
1.0 (0.040)	15-80	(3)	3-5 (5-10)	3-5 (5-10)	
1.6 (1/16)	70-150	10-20	3-5 (5-10)	4-6 (9-13)	#5, #6
2.4 (3/32)	150-250	15-30	6-8 (13-17)	5-7 (11-15)	#6, #7, #8
3.2 (1/8)	250-400	25-40	7-11 (15-23)	5-7 (11-15)	
4.0 (5/32)	400-500	40-55	10-12 (21-25)	6-8 (13-17)	#8, #10
4.8 (3/16)	500-750	55-80	11-13 (23-27)	8-10 (18-22)	
6.4 (1/4)	750-1000	80-125	13-15 (28-32)	11-13 (23-27)	

(1) When used with argon gas. The current ranges shown must be reduced when using argon/helium or pure helium shielding gases.

(2) Tungsten electrodes are classified as follows by the American Welding Society (AWS):

Pure	EWP
1% Thoriated	EWTh-1
2% Thoriated	EWTh-2

Though not yet recognized by the AWS, Ceriated Tungsten is now widely accepted as a substitute for 2% Thoriated Tungsten in AC and DC applications.

(3) DCEP is not commonly used in these sizes.

(4) TIG torch nozzle "sizes" are in multiples of 1/16ths of an inch:

# 4 =	1/4 in.	6 mm
# 5 =	5/16 in.	8 mm
# 6 =	3/8 in.	10 mm
# 7 =	7/16 in.	11 mm
# 8 =	1/2 in.	12.5 mm
#10 =	5/8 in.	16 mm

(5) TIG torch nozzles are typically made from alumina ceramic. Special applications may require lava nozzles, which are less prone to breakage, but cannot withstand high temperatures and high duty cycles.

AIR VANTAGE® 500 (AU)



PARALLELING

When paralleling machines in order to combine their outputs, all units must be operated in the CC-STICK mode only at the same output settings. To achieve this, turn the WELD MODE switch to the CC-STICK position. Operation in other modes may produce erratic outputs, and large output imbalances between the units.

AUXILIARY POWER OPERATION

Start the engine and set the IDLER control switch to the desired operating mode. Full power is available regardless of the welding control settings, if no welding current is being drawn.

The auxiliary power of the AIR VANTAGE® 500 consists of two 15Amp 240VAC single phase receptacles.

The auxiliary power receptacles should only be used with three wire grounded type plugs or approved double insulated tools with two wire plugs.

The current rating of any plug used with the system must be at least equal to the current capacity of the associated receptacle.

SIMULTANEOUS WELDING AND AUXILIARY POWER LOADS

It must be noted that the above auxiliary power ratings are with no welding load.

Simultaneous welding and power loads are specified in table B.4.

TABLE B.4 AIR VANTAGE® 500 SIMULTANEOUS WELDING AND POWER LOADS

<u>WELD</u> <u>AMPS</u>		<u>1 PHASE</u>	
		<u>WATTS</u>	<u>AMPS</u>
0	PLUS	7,200	30
100		7,200	30
200		7,200	30
250		7,200	30
300		7,200	30
400		5,600	23
500		0	0

TABLE B.5

AIR VANTAGE® 500 (AU) Extension Cord Length Recommendations
(Use the shortest length extension cord possible sized per the following table.)

Current (Amps)	Voltage (Volts)	Load (Watts)	Maximum Allowable Cord Length in ft. (m) for Conductor Size											
			14AWG 2.5²mm		12AWG 4.0²mm		10AWG 6.0²mm		8AWG 10.0²mm		6AWG 16.0²mm		4AWG 25.0²mm	
15	240	3600	60	(18)	75	(23)	150	46	225	(69)	350	107	600	(183)

Conductor size is based on maximum 2.0% voltage drop.

OPTIONAL FIELD INSTALLED ACCESSORIES

K857 25 ft. (7.5 m) or K857-1 100 ft. (30.4 m) REMOTE CONTROL - Portable control provides same dial range as the output control on the welder from a location up to the specified length from the welder. Has convenient plug for easy connection to the welder. The AIR VANTAGE® 500 (AU) is equipped with a 6-pin connector for connecting the remote control.

K704 ACCESSORY SET - Includes 35 feet (10 m) of electrode cable and 30 feet (9 m) of work cable, headshield, filter plate, work clamp and electrode holder. Cable is rated at 500 amps, 60% duty cycle.

K2641-2 FOUR WHEELED STEERABLE YARD TRAILER

For in plant and yard towing. Comes standard with a Duo-Hitch™, a 2" Ball and Lunette Eye combination Hitch.

K2636-1 TRAILER - Two-wheeled trailer with optional fender and light package. For highway use, consult applicable federal, state, and local laws regarding possible additional requirements. Comes standard with a Duo-Hitch™, a 2" Ball and Lunette Eye combination hitch. A fender & a light package. **Order:**

K2636-1 Trailer

K2639-1 Fender & Light Kit

K2640-1 Cable Storage Rack

K887-1 ETHER START KIT - Provides maximum cold weather starting assistance for frequent starting below 10° (-12°C). Required Ether tank is not provided with kit.

K1847-1 SPARK ARRESTOR KIT - Easily mounts to standard muffler.

WARNING

Pipe Thawing with an arc welder can cause fire, explosion, damage to electric wiring or to the arc welder if done improperly. The use of an arc welder for pipe thawing is not approved by the CSA, nor is it recommended or supported by Lincoln Electric.

K2354-1 Air Dryer Kit-Minimizes water content in supply air. Avoids cold weather air hose ice up.

K2356-1 Control Panel Cover Kit-Clear plexiglass cover to protect control panel from dirt and debris, and to visually monitor machine operation. Lockable to deter vandalism.

K2340-1 Lockable Fuel Cap / Flash Arrester Kit-For use in locations where flash arrester safety is required. Lockable fuel cap prevents tampering with fuel. Green cap color provides a visual reminder to use diesel when refueling.

K2359-1 Cold Weather Heater and Tarp Kit-For extreme cold conditions where normal engine starting is not sufficient. Includes oil pan heater, engine water heater and radiator grill tarp.

TIG OPTIONS

K870 Foot Amptrol®-Varies current while welding for making critical TIG welds and crater filling. Depress pedal to increase current. Depressing pedal fully achieves maximum set current. Fully raising the pedal finishes the weld and starts the afterflow cycle on systems so equipped. Includes 25 ft. (7.6m) control cable.

K963-3 Hand Amptrol®-Varies current for making critical TIG welds. Fastens to the torch for convenient thumb control. Comes with a 25 ft. (7.6m) cable. (for larger handle 18 or 26 series torches)

SAFETY PRECAUTIONS

WARNING

- Have qualified personnel do all maintenance and troubleshooting work.
- Turn the engine off before working inside the machine or servicing the engine.
- Remove guards only when necessary to perform maintenance and replace them when the maintenance requiring their removal is complete. If guards are missing from the machine, obtain replacements from a Lincoln Distributor. (See Operating Manual Parts List.)

Read the Safety Precautions in the front of this manual and in the Engine Owner's Manual before working on this machine.

Keep all equipment safety guards, covers, and devices in position and in good repair. Keep hands, hair, clothing, and tools away from the gears, fans, and all other moving parts when starting, operating, or repairing the equipment.

ROUTINE AND PERIODIC MAINTENANCE

DAILY

- Check the Engine and Compressor oil levels .
- Refill the fuel tank to minimize moisture condensation in the tank.
- Check water separator for water and drain if necessary.
- Check coolant level.

WARNING

- Only VMAC certified and approved synthetic oil **MUST** be used. Shut down the Welder/Compressor for 3 minutes, open the pressure supply valve to ensure the system is depressurized prior to removing the compressor oil level dipstick.

WEEKLY

Blow out the machine with low pressure air periodically. In particularly dirty locations, this may be required once a week.

COMPRESSOR MAINTENANCE

Refer to the "Routine Maintenance" section of the compressor owner's manual for the recommended maintenance schedule of the following:

- Compressor oil and filter.
- Compressor air filter.
- Compressor coalescing filter.

VMAC™

(VEHICLE MOUNTED AIR COMPRESSORS)

WWW.VMAC.CA

1333 Kipp Road
Nanaimo
British Columbia
Canada, V9X1R3

Telephone: (250) 740-3200

Facsimile: (250) 740-3201

Toll Free: 800-738-8622

ENGINE MAINTENANCE

Refer to the "Periodic Checks" section of the Engine Operator's Manual for the recommended maintenance schedule of the following:

- Engine Oil and Filter
- Air Cleaner
- Fuel Filter - and Delivery System
- Alternator Belt
- Battery
- Cooling System

Refer to Table D.1 at the end of this section for various engine maintenance components.

AIR FILTER

CAUTION

- Excessive air filter restriction will result in reduced engine life.

WARNING

- Never use gasoline or low flash point solvents for cleaning the air cleaner element. A fire or explosion could result.

CAUTION

- Never run the engine without the air cleaner. Rapid engine wear will result from contaminants, such as dust and dirt being drawn into the engine.

The diesel engine is equipped with a dry type air filter. Never apply oil to it. Service the air cleaner as follows:

Replace the element as indicated by the service indicator. (See Service Instructions and Installation Tips for Engine Air Filter.)

Service Instructions

Single- and Two-Stage Engine Air Cleaners

1 Remove the Filter



Rotate the filter while pulling straight out.

Unfasten or unlatch the service cover. Because the filter fits tightly over the outlet tube to create the critical seal, there will be some initial resistance, similar to breaking the seal on a jar. Gently move the end of the filter back and forth to break the seal then rotate while pulling straight out. Avoid knocking the filter against the housing.

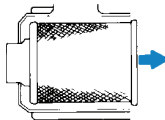

If your air cleaner has a safety filter, replace it every third primary filter change. Remove the safety filter as you would the primary filter. Make sure you cover the air cleaner outlet tube to avoid any unfiltered contaminant dropping into the engine.

2 Clean Both Surfaces of the Outlet Tube and Check the Vacuator™ Valve

Use a clean cloth to wipe the filter sealing surface and the inside of the outlet tube. Contaminant on the sealing surface could hinder an effective seal and cause leakage. Make sure that all contaminant is removed before the new filter is inserted. Dirt accidentally transferred to the inside of the outlet tube will reach the engine and cause wear. Engine manufacturers say that it takes only a few grams of dirt to "dust" an engine! Be careful not to damage the sealing area on the tube.

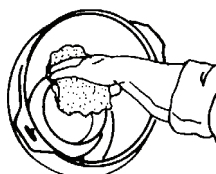

Outer edge of the outlet tube

Wipe both sides of the outlet tube clean.

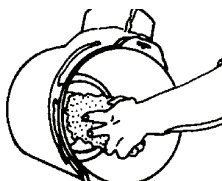

Inner edge of the outlet tube

If your air cleaner is equipped with a Vacuator Valve

Visually check and physically squeeze to make sure the valve is flexible and not inverted, damaged or plugged.



3 Inspect the Old Filter for Leak Clues

Visually inspect the old filter for any signs of leaks. A streak of dust on the clean side of the filter is a telltale sign. Remove any cause of leaks before installing new filter.

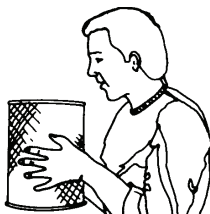

4 Inspect the New Filter for Damage

Inspect the new filter carefully, paying attention to the inside of the open end, which is the sealing area. NEVER install a damaged filter. A new Donaldson radial seal filter may have a dry lubricant on the seal to aid installation.



5 Insert the New Radial Seal Filter Properly

If you're servicing the safety filter, this should be seated into position before installing the primary filter.

Insert the new filter carefully. Seat the filter by hand, making certain it is completely into the air cleaner housing before securing the cover in place.

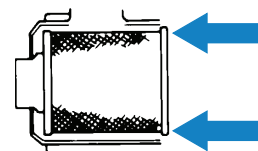

The critical sealing area will stretch slightly, adjust itself and distribute the sealing pressure evenly. To complete a tight seal, apply pressure by hand at the outer rim of the filter, not the flexible center. (Avoid pushing on the center of the urethane end cap.) No cover pressure is required to hold the seal. NEVER use the service cover to push the filter into place! Using the cover to push the filter in could cause damage to the housing, cover fasteners and will void the warranty.

If the service cover hits the filter before it is fully in place, remove the cover and push the filter (by hand) further into the air cleaner and try again. The cover should go on with no extra force.

Once the filter is in place, secure the service cover.



Caution

NEVER use the service cover to push the filter into place! Using the cover to push the filter in could cause damage to the housing, cover fasteners and will void the warranty.



6 Check Connectors for Tight Fit

Make sure that all mounting bands, clamps, bolts, and connections in the entire air cleaner system are tight. Check for holes in piping and repair if needed. Any leaks in your intake piping will send dust directly to the engine!

FUEL FILTERS

⚠ WARNING



When working on the fuel system:

- Keep naked lights away, do not smoke !
- Do not spill fuel !

The AIR VANTAGE® 500 (AU) is equipped with a **Fuel Filter** located after the lift pump and before fuel injectors. The procedure for changing the filter is as follows.

1. Close the fuel shutoff valve.
2. Clean the area around the fuel filter head. Remove the filter. Clean the gasket surface of the filter head and replace the o-ring.
3. Fill the clean filter with clean fuel, and lubricate the o-ring seal with clean lubricating oil.
4. Install the filter as specified by the filter manufacturer.

⚠ WARNING

Mechanical overtightening will distort the threads, filter element seal or filter can.

COOLING SYSTEM

The AIR VANTAGE® 500 (AU) is equipped with a pressure radiator. Keep the radiator cap tight to prevent loss of coolant. Clean and flush the coolant system periodically to prevent clogging the passage and over-heating the engine. When antifreeze is needed, always use the permanent type.

BATTERY HANDLING



GASES FROM BATTERY can explode.

- Keep sparks, flame and cigarettes away from battery.

To prevent **EXPLOSION** when:

- **INSTALLING A NEW BATTERY** - disconnect negative cable from old battery first and connect to new battery last.



- **CONNECTING A BATTERY CHARGER** - Remove battery from welder by disconnecting negative cable first, then positive cable and battery clamp. When reinstalling, connect negative cable last. Keep well ventilated.

- **USING A BOOSTER** - connect positive lead to battery first then connect negative lead to engine foot.



BATTERY ACID CAN BURN EYES AND SKIN.

- Wear gloves and eye protection and be careful when working near battery. Follow instructions printed on battery.

PREVENTING ELECTRICAL DAMAGE

1. When replacing, jumping, or otherwise connecting the battery to the battery cables, the proper polarity must be observed. Failure to observe the proper polarity could result in damage to the charging circuit. The positive (+) battery cable has a red terminal cover.
2. If the battery requires charging from an external charger, disconnect the negative battery cable first and then the positive battery cable before attaching the charger leads. Failure to do so can result in damage to the internal charger components. When reconnecting the cables, connect the positive cable first and the negative cable last.

PREVENTING BATTERY DISCHARGE

Turn the RUN/STOP switch to stop when engine is not running.

PREVENTING BATTERY BUCKLING

Tighten nuts on battery clamp until snug.

AIR VANTAGE® 500 (AU)



CHARGING THE BATTERY

When you charge, jump, replace, or otherwise connect battery cables to the battery, be sure the polarity is correct. Improper polarity can damage the charging circuit. The AIR VANTAGE® 500 (AU) positive (+) battery terminal has a red terminal cover.

If you need to charge the battery with an external charger, disconnect the negative cable first, then the positive cable before you attach the charger leads. After the battery is charged, reconnect the positive battery cable first and the negative cable last. Failure to do so can result in damage to the internal charger components.

Follow the instructions of the battery charger manufacturer for proper charger settings and charging time.

NAMEPLATES / WARNING DECALS MAINTENANCE

Whenever routine maintenance is performed on this machine - or at least yearly - inspect all nameplates and labels for legibility. Replace those which are no longer clear. Refer to the parts list for the replacement item number.

WELDER / GENERATOR MAINTENANCE

STORAGE

Store the AIR VANTAGE® 500 (AU) in a clean, dry protected areas.

CLEANING

Blow out the generator and controls periodically with low pressure air. Do this at least once a week in particularly dirty areas.

BRUSH REMOVAL AND REPLACEMENT

It is normal for the brushes and slip rings to wear and darken slightly. Inspect the brushes when a generator overhaul is necessary.

WARNING

Do not attempt to polish slip rings while the engine is running.

Table D.1 Engine Maintenance Components

ITEM	MAKE	PART NUMBER	SERVICE INTERVAL
Air Cleaner Element	Donaldson	P822768	Replace as indicated by Service Indicator
	Fleetguard	AF25436	
Oil Filer	Cummins Fleetguard	C6002112110 LF16011	Replace every 750 hours or 3 months, whichever is less.
Fan Belt	Cummins	C0412021749	Inspect every 1000 hours or 12 months, whichever is less.
Fuel Strainer	Cummins Fleetguard	3826094 FF5079	Inspect and replace monthly as required. Replace annually.
Fuel Filter / Water Separator	Fleetguard	FS19594	Replace every 500 hours or 6 months, whichever is less.
Battery	-----	BCI GROUP 34	Inspect every 500 hours
Engine Oil Change	See Manual	-----	Change every 750 hours or 3 months, whichever is less. Check daily.

HOW TO USE TROUBLESHOOTING GUIDE

WARNING

Service and Repair should only be performed by Lincoln Electric Factory Trained Personnel. Unauthorized repairs performed on this equipment may result in danger to the technician and machine operator and will invalidate your factory warranty. For your safety and to avoid Electrical Shock, please observe all safety notes and precautions detailed throughout this manual.

This Troubleshooting Guide is provided to help you locate and repair possible machine malfunctions. Simply follow the three-step procedure listed below.

Step 1. LOCATE PROBLEM (SYMPTOM).

Look under the column labeled “PROBLEM (SYMPTOMS)”. This column describes possible symptoms that the machine may exhibit. Find the listing that best describes the symptom that the machine is exhibiting.

Step 2. POSSIBLE CAUSE.

The second column labeled “POSSIBLE CAUSE” lists the obvious external possibilities that may contribute to the machine symptom.

Step 3. RECOMMENDED COURSE OF ACTION

This column provides a course of action for the Possible Cause, generally it states to contact your local Lincoln Authorized Field Service Facility.

If you do not understand or are unable to perform the Recommended Course of Action safely, contact your local Lincoln Authorized Field Service Facility.

NOTE: See VMAC owner’s manual for compressor trouble shooting.

VMAC™
VEHICLE MOUNTED AIR COMPRESSORS
 WWW.VMAC.CA

1333 Kipp Road
 Nanamino
 British Columbia
 Canada, V9X1R3

Telephone: (250) 740-3200
 Facsimile: (250) 740-3201
 Toll Free: 800-738-8622

CAUTION

If for any reason you do not understand the test procedures or are unable to perform the tests/repairs safely, contact your **Local Lincoln Authorized Field Service Facility** for technical troubleshooting assistance before you proceed.

AIR VANTAGE® 500 (AU)



Observe all Safety Guidelines detailed throughout this manual

PROBLEMS (SYMPTOMS)	POSSIBLE CAUSE	RECOMMENDED COURSE OF ACTION
Major Physical or Electrical Damage is Evident.	1. Contact your local Lincoln Authorized Field Service Facility.	If all recommended possible areas of misadjustment have been checked and the problem persists, Contact your local Lincoln Authorized Field Service Facility.
Engine will not crank	<ol style="list-style-type: none"> 1. Battery low. 2. Loose battery cable connections which may need Inspected, cleaned or tighten. 3. Faulty wiring in engine starting circuit. 4. Faulty engine starter. Contact authorized local Engine Service Shop. 5. Battery disconnect switch is in the off position. 	
Engine will crank but not start.	<ol style="list-style-type: none"> 1. Out of fuel. 2. Fuel shut off valve is in the off position make sure the valve lever is in a vertical direction. 3. Engine shut down solenoid not pulling in. 4. On/Off switch on for more than 30 sec. before starting, the On/Off switch will need to be switch off and turned back on. 5. Fuel Filters dirty/clogged, main filter element and/or In-line Fuel Filter may need to be replaced. 6. High water temperature or low oil pressure. (engine protection light lit) 	
Engine shuts down shortly after starting.	<ol style="list-style-type: none"> 1. Low oil pressure (engine protection light lit). Check oil level (Consult engine service dealer). 2. High water temperature. Check engine cooling system. (engine protection light lit). 3. Faulty oil pressure switch. 4. Faulty water temperature switch. Contact authorized local Engine Service Shop. 	
Engine shuts down while under a load.	1. High water temperature.	
Engine runs rough.	<ol style="list-style-type: none"> 1. Dirty fuel or air filters may need cleaned/replaced. 2. Water in fuel. 	
Engine will not shut off.	1. Fuel Shutdown solenoid not functioning properly / linkage binding.	

⚠ CAUTION

If for any reason you do not understand the test procedures or are unable to perform the tests/repairs safely, contact your **Local Lincoln Authorized Field Service Facility** for technical troubleshooting assistance before you proceed.

AIR VANTAGE® 500 (AU)



Observe all Safety Guidelines detailed throughout this manual

PROBLEMS (SYMPTOMS)	POSSIBLE CAUSE	RECOMMENDED COURSE OF ACTION
Battery does not stay charged.	<ol style="list-style-type: none"> 1. Faulty battery . 2. Faulty engine alternator. 3. Loose or broken lead in charging circuit. 4. Loose fan belt may need tightening. 	<p>If all recommended possible areas of misadjustment have been checked and the problem persists, Contact your local Lincoln Authorized Field Service Facility.</p>
Engine will not idle down to low speed.	<ol style="list-style-type: none"> 1. Idler switch in HIGH idle position, make sure switch is set to AUTO. 2. External load on welder or auxiliary power. 3. Mechanical problem in idler solenoid linkage. 4. Faulty wiring in solenoid circuit. 5. No or low voltage @ idle solenoid 6. Faulty idler solenoid. 7. Faulty, Weld Control PCB (Printed Circuit Board), Pull Coil /Battery PCB 	
Engine will not go to high idle when attempting to weld.	<ol style="list-style-type: none"> 1. Poor work lead connection to work. 2. Broken idler solenoid spring. 3. Welding Terminals switch in wrong position. 4. No open circuit voltage at output studs. 5. Faulty, Pull Coil/Battery PCB or Weld Control PCB. 	
Engine will not go to high idle when using auxiliary power.	<ol style="list-style-type: none"> 1. Broken wire in auxiliary current sensor wiring. 2. Auxiliary power load is less than 100 watts. 3. Faulty Pull Coil/Battery PCB or Weld Control PCB. 	

 **CAUTION**

If for any reason you do not understand the test procedures or are unable to perform the tests/repairs safely, contact your **Local Lincoln Authorized Field Service Facility** for technical troubleshooting assistance before you proceed.

AIR VANTAGE® 500 (AU)



Observe all Safety Guidelines detailed throughout this manual

PROBLEMS (SYMPTOMS)	POSSIBLE CAUSE	RECOMMENDED COURSE OF ACTION
Engine goes to low idle but does not stay at low idle.	1. Faulty Peripheral PCB, Pull Coil/Battery PCB or Weld Control PCB.	If all recommended possible areas of misadjustment have been checked and the problem persists, Contact your local Lincoln Authorized Field Service Facility.
No welding output or auxiliary output.	1. Broken lead in rotor circuit. 2. Faulty field diode module. 3. Faulty Weld Control PCB. 4. Faulty rotor.	
Welder has some/ no output and no control. Auxiliary output OK	1. Faulty remote kit. 2. Faulty output control potentiometer. 3. Faulty output control wiring. 4. Faulty Weld Control PCB, Pull Coil/Battery PCB or Chopper PCB.	
No welding output. Auxiliary output OK.	1. WELDING TERMINALS switch in wrong position, be sure switch is in WELDING TERMINALS ALWAYS ON position. 2. Faulty Weld Control PCB, Pull Coil/Battery PCB or Chopper PCB.	
No auxiliary power.	1. RCD may have tripped. 2. Open breakers may need to be reset. 3. Faulty receptacle. 4. Faulty auxiliary circuit wiring.	

 **CAUTION**

If for any reason you do not understand the test procedures or are unable to perform the tests/repairs safely, contact your **Local Lincoln Authorized Field Service Facility** for technical troubleshooting assistance before you proceed.

AIR VANTAGE® 500 (AU)



AIR VANTAGE 500 (K32012-1) WIRING DIAGRAM

ELECTRICAL SYMBOLS PER E1537

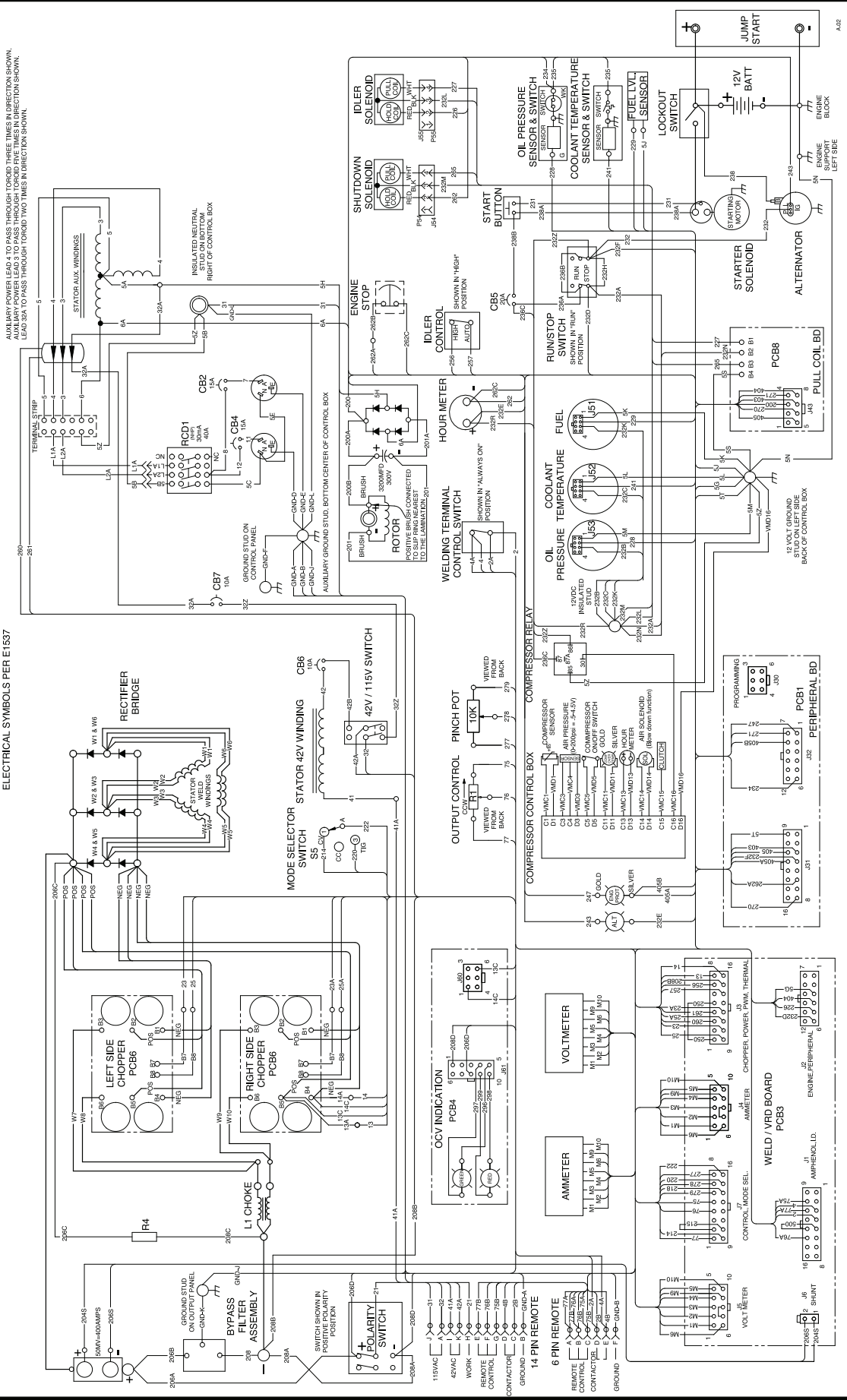

G6823-1

NOTE: This diagram is for reference only. It may not be accurate for all machines covered by this manual. The specific diagram for a particular code is included with the machine. If the diagram is illegible, write to the Service Department for a replacement. Give the equipment code number.

AIR VANTAGE® 500 (AU)



ENGINE WELDERS / K691-10 / K488 / K487 SPOOL GUN CONNECTION DIAGRAM

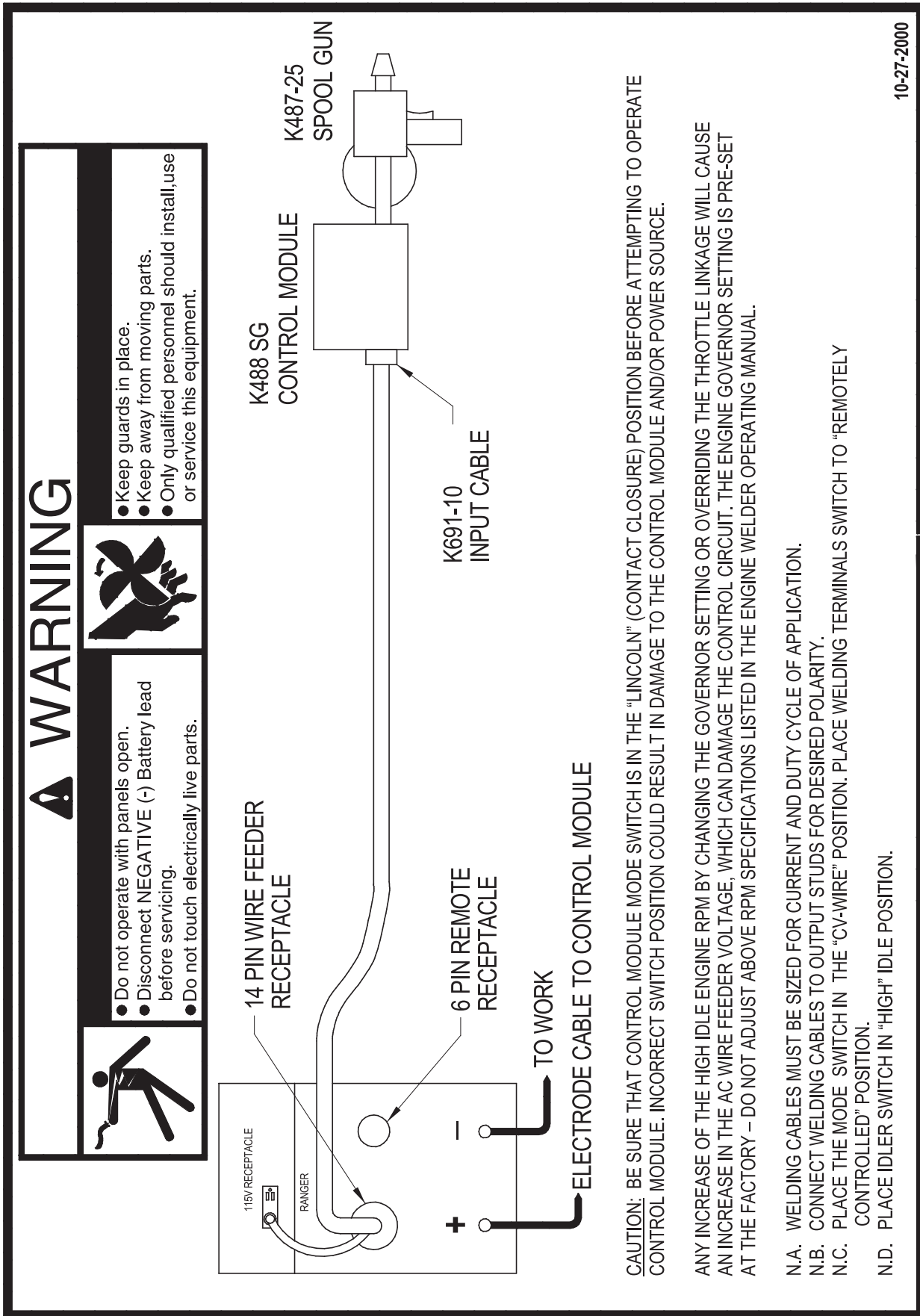

ENGINE WELDERS / K867 / K775 / LN-7 CONNECTION DIAGRAM

	<p>WARNING</p> <p>ELECTRIC SHOCK can kill</p>	
<ul style="list-style-type: none"> • Do not operate with panels open. • Disconnect NEGATIVE (-) BATTERY LEAD before servicing. • Do not touch electrically live parts. 	<ul style="list-style-type: none"> • Keep guards in place. • Keep away from moving parts. • Only qualified personnel should install, use or service this equipment. 	<p>MOVING PARTS can injure</p>

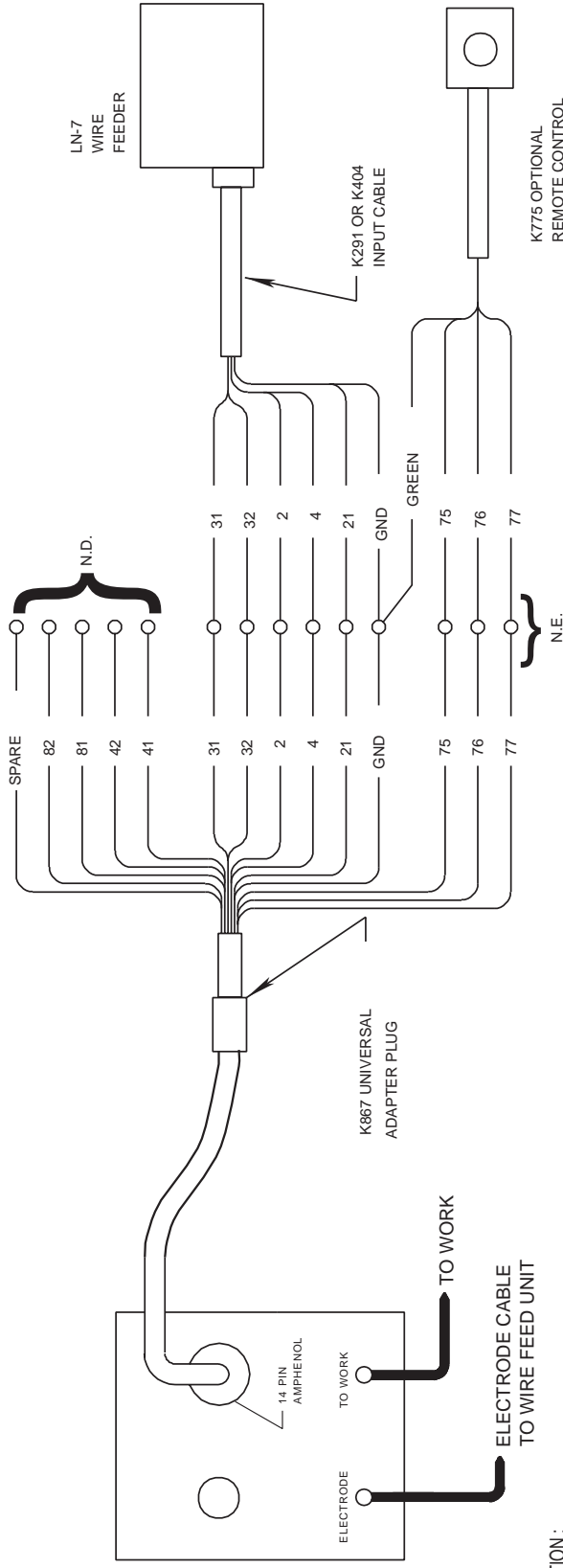

CAUTION :
 ANY INCREASE OF THE HIGH IDLE ENGINE RPM BY CHANGING THE GOVERNOR SETTING OR OVERRIDING THE THROTTLE LINKAGE WILL CAUSE AN INCREASE IN THE AC AUXILIARY VOLTAGE. IF THIS VOLTAGE GOES OVER 140 VOLTS, WIRE FEEDER CONTROL CIRCUITS MAY BE DAMAGED. THE ENGINE GOVERNOR SETTING IS PRE-SET AT THE FACTORY - DO NOT ADJUST ABOVE RPM SPECIFICATIONS LISTED IN THE ENGINE WELDER OPERATING MANUAL.

- N.A. WELDING CABLE MUST BE OF PROPER CAPACITY FOR THE CURRENT AND DUTY CYCLE OF IMMEDIATE AND FUTURE APPLICATIONS. SEE OPERATING MANUAL.
- N.B. USE VOLTMETER SWITCH TO SELECT DESIRED ELECTRODE POLARITY. POSITION THE "SELECTOR" SWITCH TO "WIRE WELDING CV". PLACE WIRE FEEDER SWITCH TO "WIRE FEEDER WITH CONTROL CABLE POSITION."
- N.C. IF OPTIONAL REMOTE OUTPUT CONTROL IS USED, CONTROL IS AUTOMATICALLY SWITCHED TO REMOTE CONTROL
- N.D. INSULATE EACH UNUSED LEAD INDIVIDUALLY.
- N.E. SPLICE LEADS AND INSULATE.

ENGINE WELDERS /LN-7 CONNECTION DIAGRAM

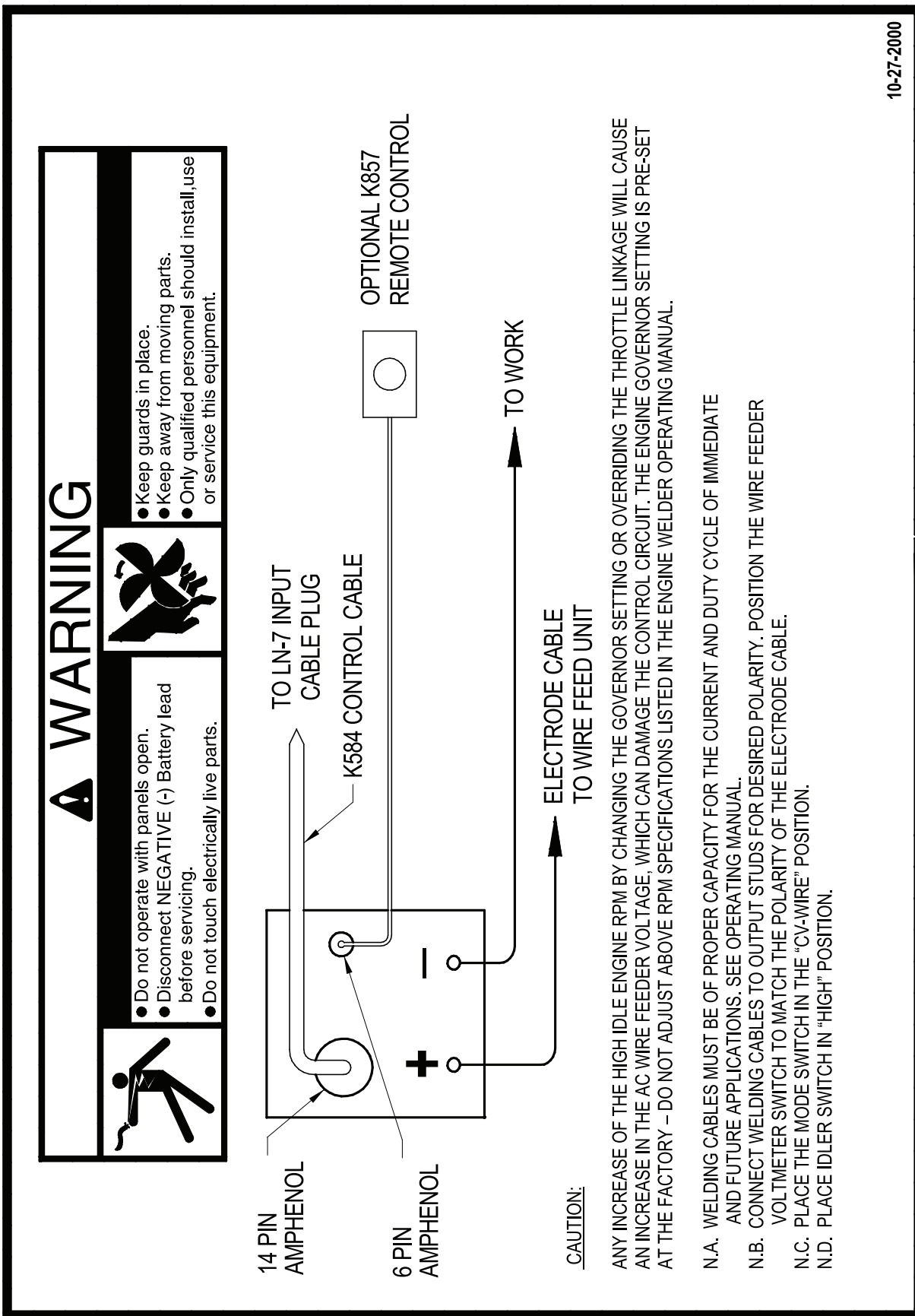

ENGINE WELDERS TO K867 CONTROL CABLE ADAPTER CONNECTION DIAGRAM

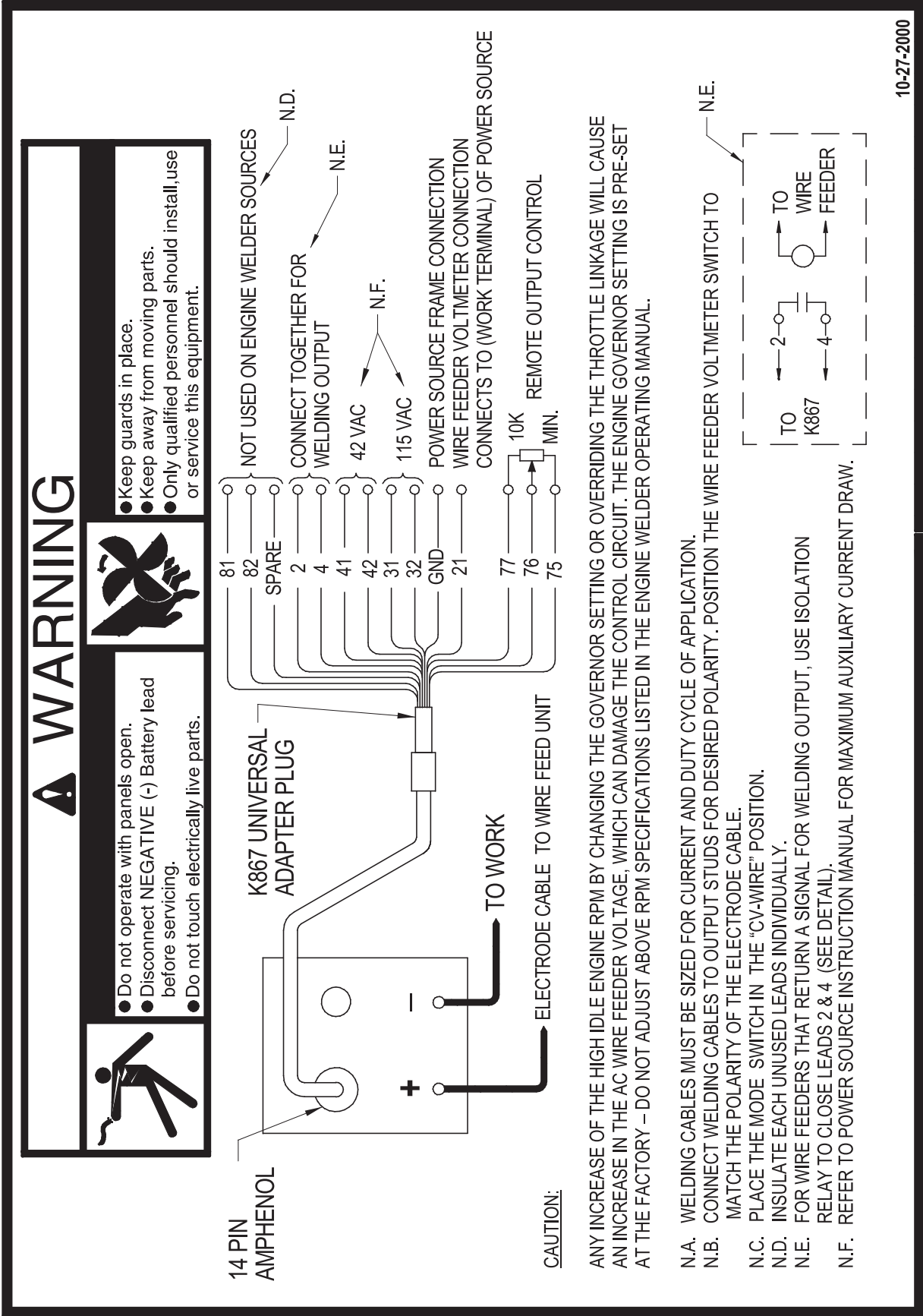

10-27-2000

S24787-7

ENGINE WELDERS / K867 / LN-8 CONNECTION DIAGRAM



ELECTRIC SHOCK can kill

- Do not operate with panels open.
- Disconnect NEGATIVE (-) BATTERY LEAD before servicing.
- Do not touch electrically live parts.

WARNING



MOVING PARTS can injure

- Keep guards in place.
- Keep away from moving parts.
- Only qualified personnel should install, use or service this equipment.

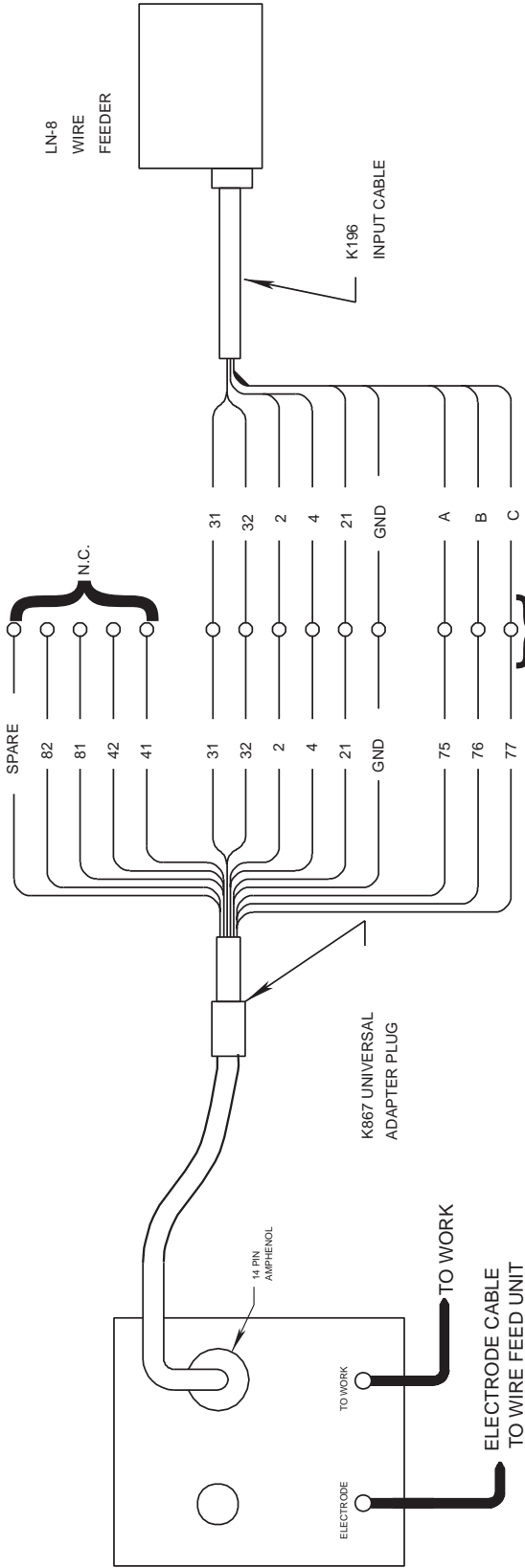

CAUTION :
 ANY INCREASE OF THE HIGH IDLE ENGINE RPM BY CHANGING THE GOVERNOR SETTING OR OVERRIDING THE THROTTLE LINKAGE WILL CAUSE AN INCREASE IN THE AC AUXILIARY VOLTAGE. IF THIS VOLTAGE GOES OVER 140 VOLTS, WIRE FEEDER CONTROL CIRCUITS MAY BE DAMAGED. THE ENGINE GOVERNOR SETTING IS PRE-SET AT THE FACTORY - DO NOT ADJUST ABOVE RPM SPECIFICATIONS LISTED IN THE ENGINE WELDER OPERATING MANUAL.

- N.A. WELDING CABLE MUST BE OF PROPER CAPACITY FOR THE CURRENT AND DUTY CYCLE OF IMMEDIATE AND FUTURE APPLICATIONS. SEE OPERATING MANUAL.
- N.B. USE VOLTMETER SWITCH TO SELECT DESIRED ELECTRODE POLARITY. POSITION THE SELECTOR SWITCH TO "WIRE WELDING CV".
- N.C. INSULATE EACH UNUSED LEAD INDIVIDUALLY.
- N.D. SPLICE LEADS AND INSULATE.

7-2000
 S23989

ENGINE WELDERS /LN-25 ACROSS THE ARC CONNECTION DIAGRAM WITH OPTIONAL K857 REMOTE CONTROL



WARNING



- Do not operate with panels open.
- Disconnect NEGATIVE (-) Battery lead before servicing.
- Do not touch electrically live parts.

- Keep guards in place.
- Keep away from moving parts.
- Only qualified personnel should install, use or service this equipment.

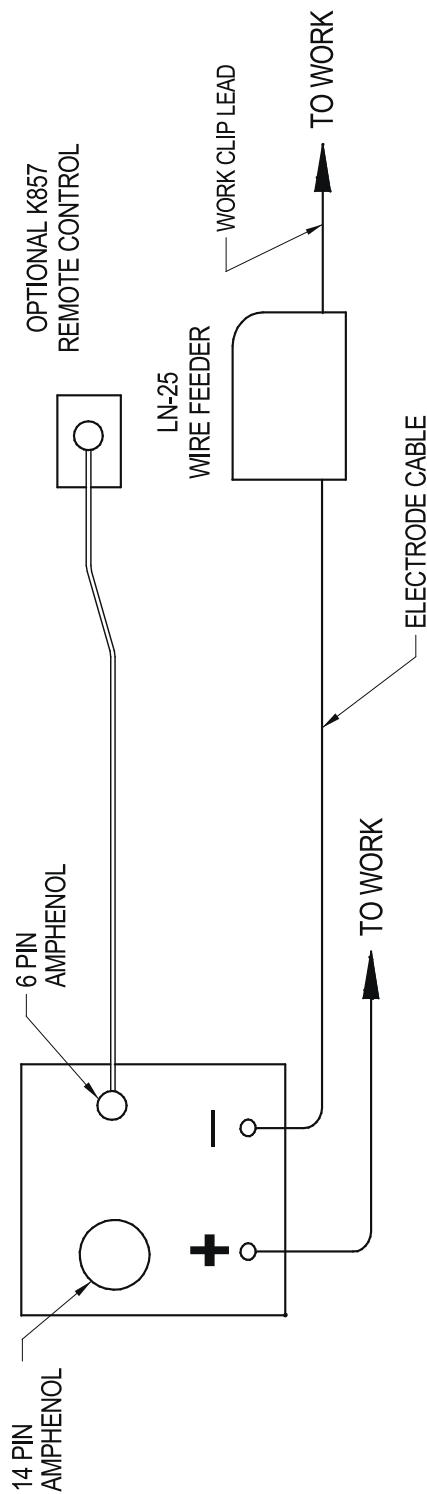

- N.A. WELDING CABLES MUST BE OF PROPER CAPACITY FOR THE CURRENT AND DUTY CYCLE OF IMMEDIATE AND FUTURE APPLICATIONS. SEE OPERATING MANUAL.
- N.B. CONNECT WELDING CABLES TO OUTPUT STUDS FOR DESIRED POLARITY. POSITION THE WIRE FEEDER VOLTMEETER SWITCH TO MATCH THE POLARITY OF THE ELECTRODE CABLE.
- N.C. PLACE THE MODE SWITCH IN THE "CV-WIRE" POSITION.
- N.D. PLACE THE WELDING TERMINALS SWITCH IN THE "WELD TERMINALS ON" POSITION.
- N.E. PLACE IDLER SWITCH IN "AUTO" OR "HIGH" IDLE POSITION AS DESIRED.

10-27-2000

S24787-1

ENGINE WELDERS /LN-8 CONNECTION DIAGRAM

	<h2>WARNING</h2>	<ul style="list-style-type: none"> • Do not operate with panels open. • Disconnect NEGATIVE (-) Battery lead before servicing. • Do not touch electrically live parts.
		
<ul style="list-style-type: none"> • Keep guards in place. • Keep away from moving parts. • Only qualified personnel should install, use or service this equipment. 		

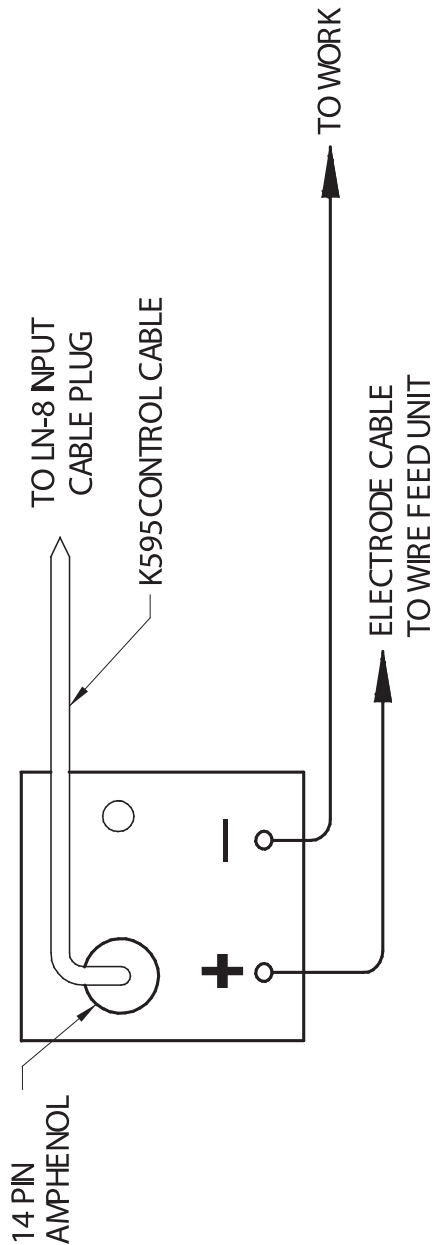

CAUTION

ANY INCREASE OF THE HIGH IDLE ENGINE RPM BY CHANGING THE GOVERNOR SETTING OR OVERRIDING THE THROTTLE LINKAGE WILL CAUSE AN INCREASE IN THE AC WIRE FEEDER VOLTAGE, WHICH CAN DAMAGE THE CONTROL CIRCUIT. THE ENGINE GOVERNOR SETTING IS PRE-SET AT THE FACTORY - DO NOT ADJUST ABOVE RPM SPECIFICATIONS LISTED IN THE ENGINE WELDER OPERATING MANUAL.

N.A. WELDING CABLES MUST BE OF PROPER CAPACITY FOR THE CURRENT AND DUTY CYCLE OF IMMEDIATE AND FUTURE APPLICATIONS. SEE OPERATING MANUAL.

N.B. CONNECT WELDING CABLES TO OUTPUT STUDS FOR DESIRED POLARITY. POSITION THE WIRE FEEDER VOLTMETER SWITCH TO MATCH THE POLARITY OF THE ELECTRODE CABLE.

N.C. PLACE IDLER SWITCH IN "HIGH" POSITION.

4-14-2000

S24787-6

ENGINE WELDERS /LN-25 WITH K624-1 42 VOLT REMOTE OUTPUT CONTROL MODULE CONNECTION DIAGRAM

	<h2>WARNING</h2>	<ul style="list-style-type: none"> ● Do not operate with panels open. ● Disconnect NEGATIVE (-) Battery lead before servicing. ● Do not touch electrically live parts.
	<ul style="list-style-type: none"> ● Keep guards in place. ● Keep away from moving parts. ● Only qualified personnel should install, use or service this equipment. 	

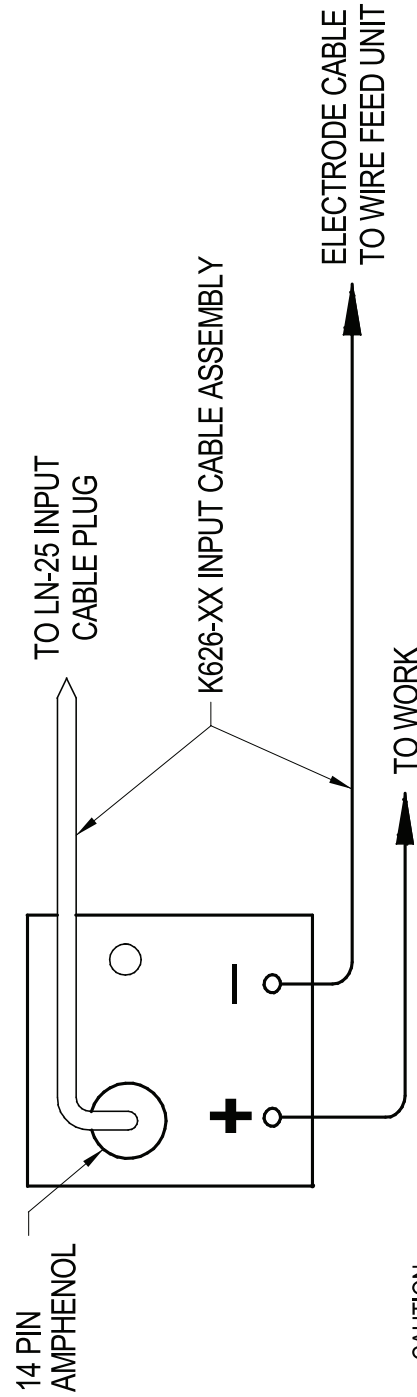

CAUTION:

ANY INCREASE OF THE HIGH IDLE ENGINE RPM BY CHANGING THE GOVERNOR SETTING OR OVERRIDING THE THROTTLE LINKAGE WILL CAUSE AN INCREASE IN THE AC WIRE FEEDER VOLTAGE, WHICH CAN DAMAGE THE CONTROL CIRCUIT. THE ENGINE GOVERNOR SETTING IS PRE-SET AT THE FACTORY – DO NOT ADJUST ABOVE RPM SPECIFICATIONS LISTED IN THE ENGINE WELDER OPERATING MANUAL.

N.A. PLACE THE MODE SWITCH IN THE "CV-WIRE" POSITION. PLACE WELDER TERMINALS SWITCH TO "REMOTELY CONTROLLED" POSITION.

N.B. CONNECT WELDING CABLES TO OUTPUT STUDS FOR DESIRED POLARITY. POSITION THE WIRE FEEDER VOLTMETER SWITCH TO MATCH THE POLARITY OF THE ELECTRODE CABLE.

N.C. WELDING CABLES MUST BE OF PROPER CAPACITY FOR THE CURRENT AND DUTY CYCLE OF IMMEDIATE AND FUTURE APPLICATIONS. SEE OPERATING MANUAL.

N.D. PLACE IDLER SWITCH IN "AUTO" OR "HIGH" IDLE POSITION AS DESIRED.

10-27-2000

S24787-3

ENGINE WELDERS /LN-25 ACROSS THE ARC CONNECTION DIAGRAM WITH OPTIONAL K444-1 REMOTE CONTROL

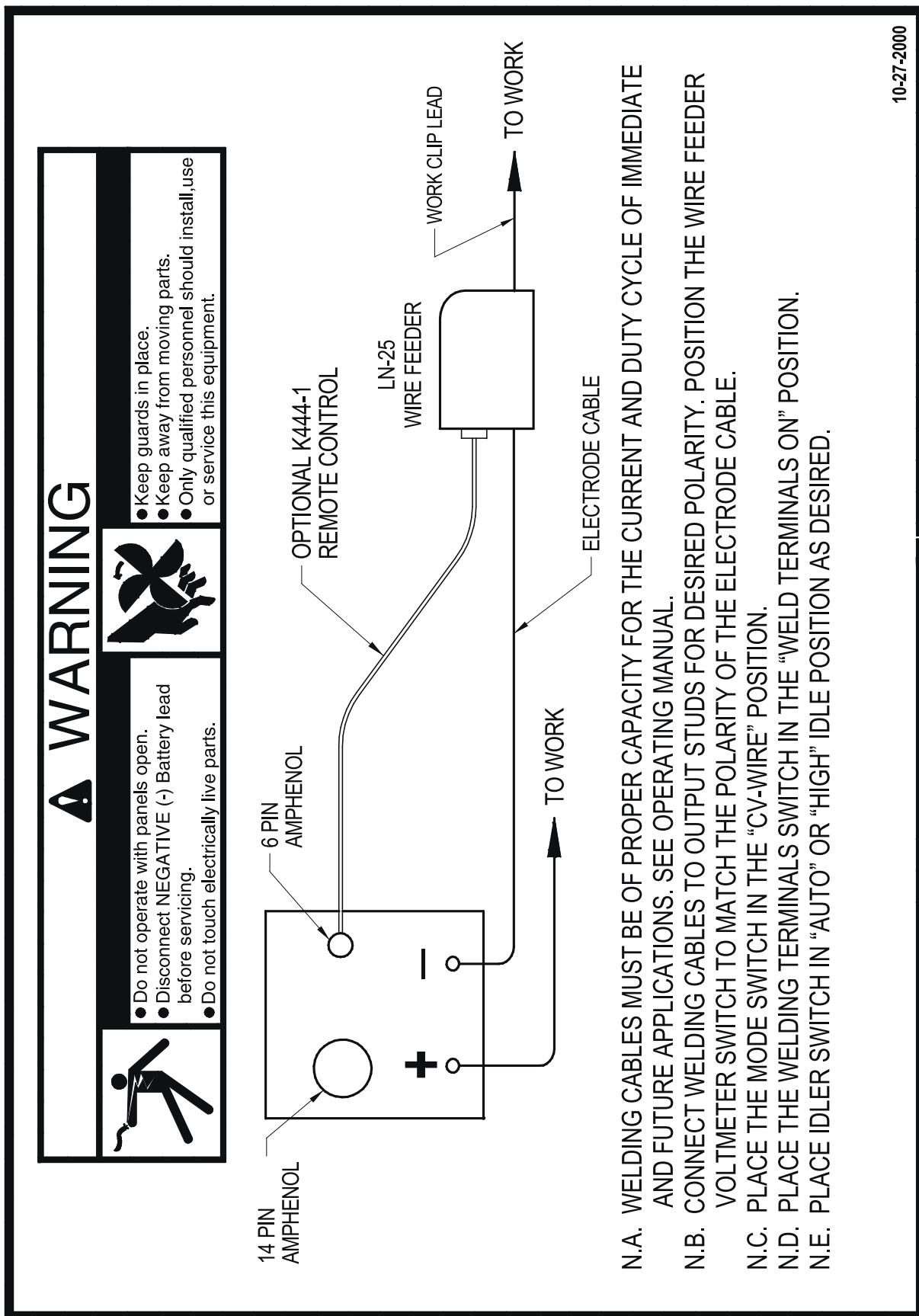

ENGINE WELDERS / K930 TIG MODULE / CONNECTION DIAGRAM

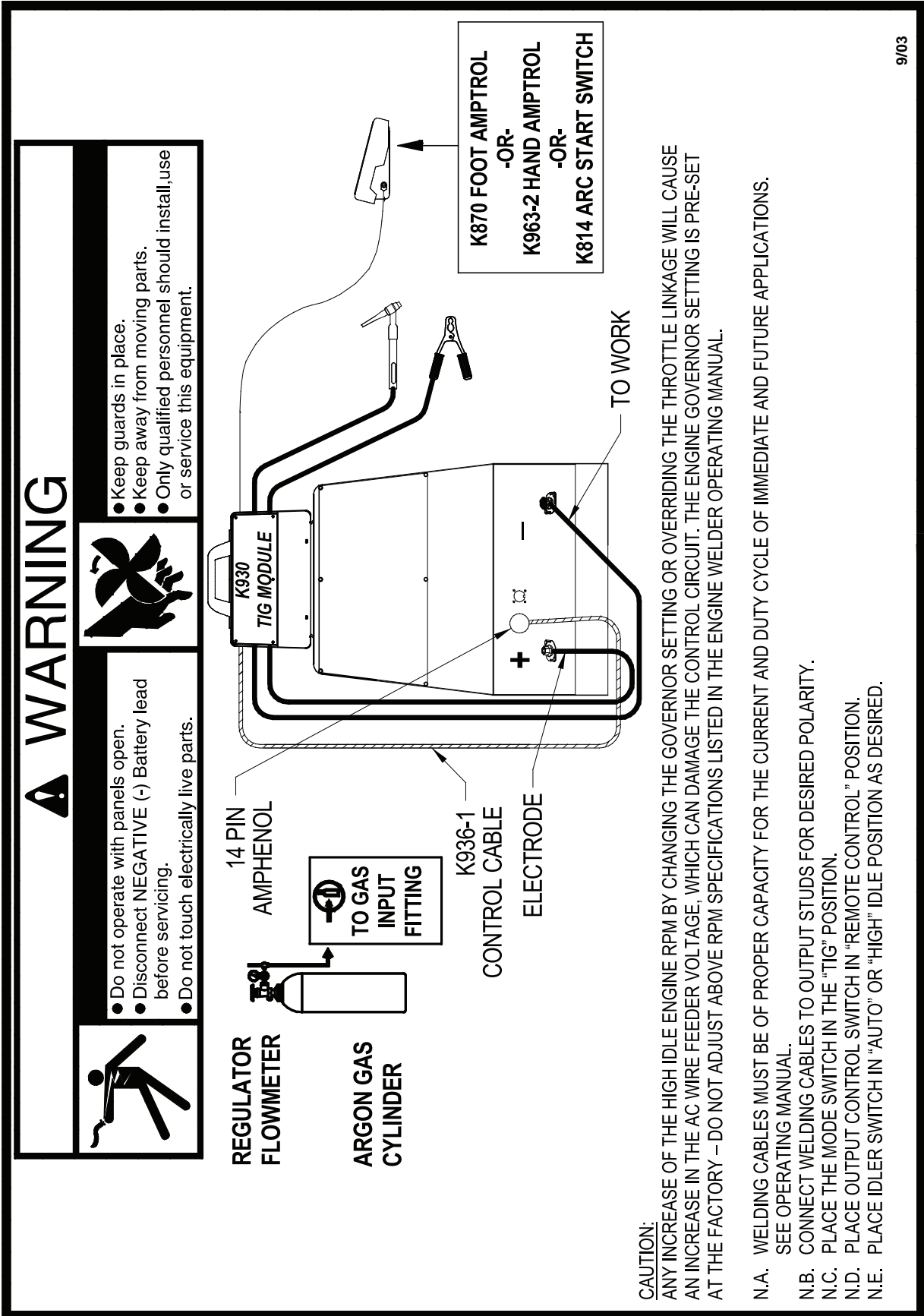

ENGINE WELDERS /LN-742 CONNECTION DIAGRAM

	<h2>WARNING</h2>	
<ul style="list-style-type: none"> • Do not operate with panels open. • Disconnect NEGATIVE (-) Battery lead before servicing. • Do not touch electrically live parts. 		<ul style="list-style-type: none"> • Keep guards in place. • Keep away from moving parts. • Only qualified personnel should install, use or service this equipment.

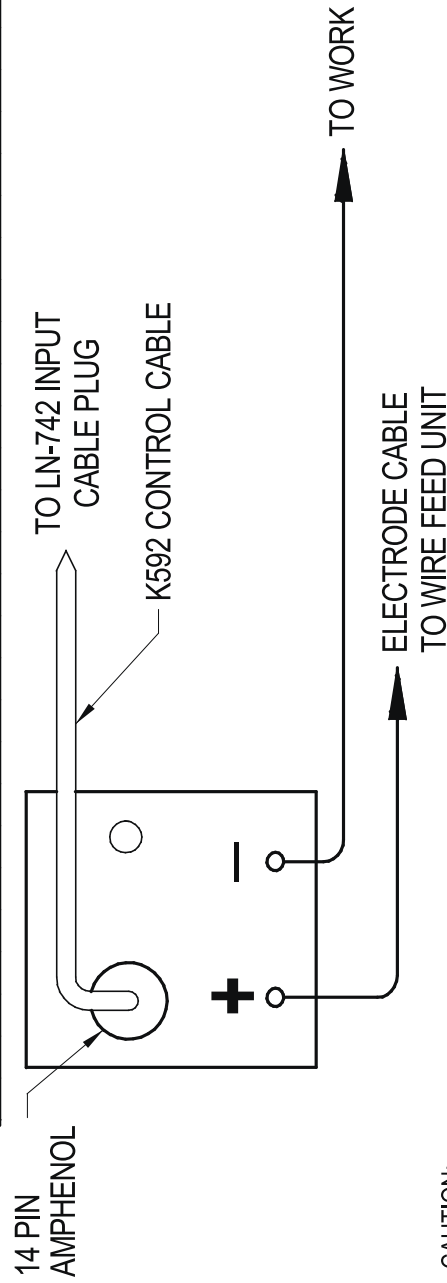

CAUTION:

ANY INCREASE OF THE HIGH IDLE ENGINE RPM BY CHANGING THE GOVERNOR SETTING OR OVERRIDING THE THROTTLE LINKAGE WILL CAUSE AN INCREASE IN THE AC WIRE FEEDER VOLTAGE, WHICH CAN DAMAGE THE CONTROL CIRCUIT. THE ENGINE GOVERNOR SETTING IS PRE-SET AT THE FACTORY – DO NOT ADJUST ABOVE RPM SPECIFICATIONS LISTED IN THE ENGINE WELDER OPERATING MANUAL.

N.A. WELDING CABLES MUST BE OF PROPER CAPACITY FOR THE CURRENT AND DUTY CYCLE OF IMMEDIATE AND FUTURE APPLICATIONS. SEE OPERATING MANUAL.

N.B. CONNECT WELDING CABLES TO OUTPUT STUDS FOR DESIRED POLARITY. POSITION THE WIRE FEEDER VOLTMETER SWITCH TO MATCH THE POLARITY OF THE ELECTRODE CABLE.

N.C. PLACE THE MODE SWITCH IN THE "CV-WIRE" POSITION.

N.D. PLACE WELDER TERMINALS SWITCH TO "REMOTELY CONTROLLED" POSITION.

N.E. PLACE IDLER SWITCH IN "AUTO" OR "HIGH" IDLE POSITION AS DESIRED.

10-27-2000

S24787-5

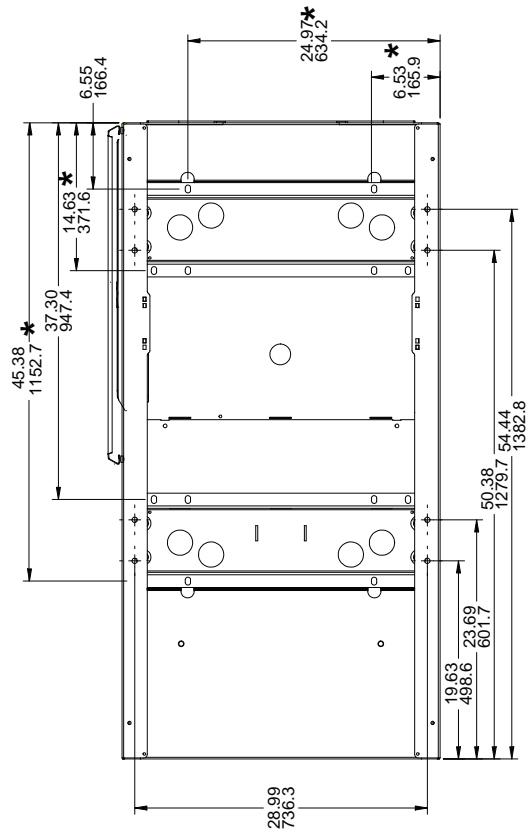
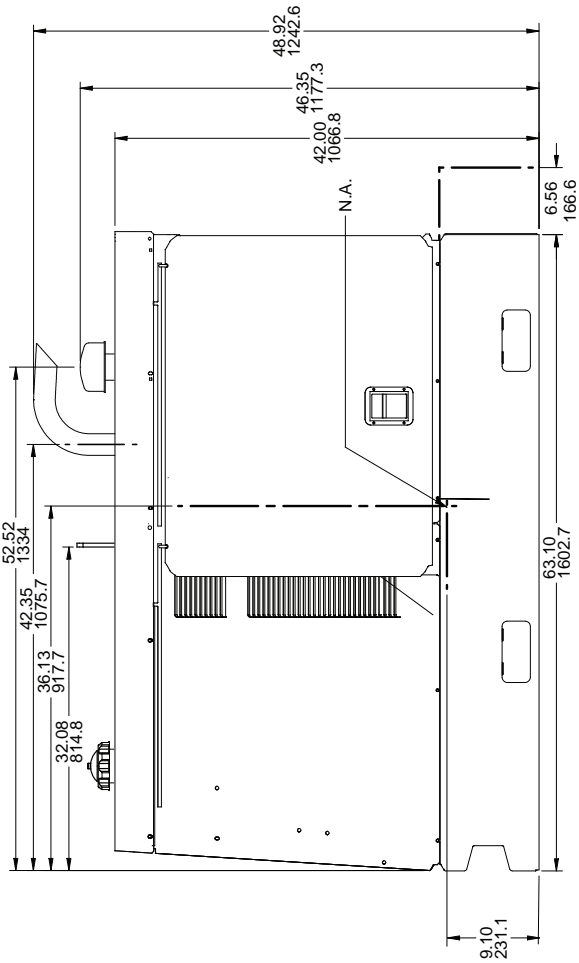
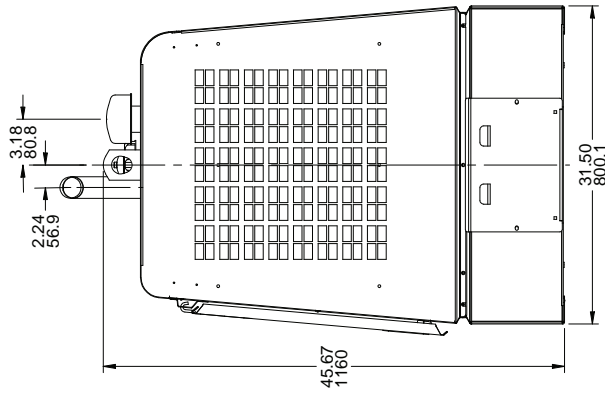

BOTTOM VIEW OF WELDER BASE.

N.A. CENTER OF GRAVITY WITH OIL IN ENGINE, OIL IN COMPRESSOR, COOLANT IN RADIATOR, AND EMPTY FUEL TANK.

* TRAILER MOUNTING HOLE LOCATIONS.

B

M18962-4

NOTES

AIR VANTAGE® 500 (AU)



			
WARNING	<ul style="list-style-type: none"> Do not touch electrically live parts or electrode with skin or wet clothing. Insulate yourself from work and ground. 	<ul style="list-style-type: none"> Keep flammable materials away. 	<ul style="list-style-type: none"> Wear eye, ear and body protection.
Spanish AVISO DE PRECAUCION	<ul style="list-style-type: none"> No toque las partes o los electrodos bajo carga con la piel o ropa mojada. Aislese del trabajo y de la tierra. 	<ul style="list-style-type: none"> Mantenga el material combustible fuera del área de trabajo. 	<ul style="list-style-type: none"> Protéjase los ojos, los oídos y el cuerpo.
French ATTENTION	<ul style="list-style-type: none"> Ne laissez ni la peau ni des vêtements mouillés entrer en contact avec des pièces sous tension. Isolez-vous du travail et de la terre. 	<ul style="list-style-type: none"> Gardez à l'écart de tout matériel inflammable. 	<ul style="list-style-type: none"> Protégez vos yeux, vos oreilles et votre corps.
German WARNUNG	<ul style="list-style-type: none"> Berühren Sie keine stromführenden Teile oder Elektroden mit Ihrem Körper oder feuchter Kleidung! Isolieren Sie sich von den Elektroden und dem Erdboden! 	<ul style="list-style-type: none"> Entfernen Sie brennbares Material! 	<ul style="list-style-type: none"> Tragen Sie Augen-, Ohren- und Körperschutz!
Portuguese ATENÇÃO	<ul style="list-style-type: none"> Não toque partes elétricas e electrodos com a pele ou roupa molhada. Isole-se da peça e terra. 	<ul style="list-style-type: none"> Mantenha inflamáveis bem guardados. 	<ul style="list-style-type: none"> Use proteção para a vista, ouvido e corpo.
Japanese 注意事項	<ul style="list-style-type: none"> ● 通電中の電気部品、又は溶材にヒブやぬれた布で触れないこと。 ● 施工物やアースから身体が絶縁されている様にして下さい。 	<ul style="list-style-type: none"> ● 燃えやすいものの側での溶接作業は絶対にしてはなりません。 	<ul style="list-style-type: none"> ● 目、耳及び身体に保護具をして下さい。
Chinese 警告	<ul style="list-style-type: none"> ● 皮肤或湿衣物切勿接触带电部件及焊缝。 ● 使你自已与地面和工件绝缘。 	<ul style="list-style-type: none"> ● 把一切易燃物品移离工作场所。 	<ul style="list-style-type: none"> ● 佩戴眼、耳及身体劳动保护用具。
Korean 위험	<ul style="list-style-type: none"> ● 전도체나 용접봉을 젖은 헝겍 또는 피부로 절대 접촉치 마십시오. ● 모재와 접지를 접촉치 마십시오. 	<ul style="list-style-type: none"> ● 인화성 물질을 접근 시키지 마십시오. 	<ul style="list-style-type: none"> ● 눈, 귀와 몸에 보호장구를 착용하십시오.
Arabic تحذير	<ul style="list-style-type: none"> ● لا تلمس الاجزاء التي يسري فيها التيار الكهربائي أو الألكترود بجلك الجسم أو بالملابس المبللة بالماء. ● ضع عازلا على جسمك خلال العمل. 	<ul style="list-style-type: none"> ● ضع المواد القابلة للاشتعال في مكان بعيد. 	<ul style="list-style-type: none"> ● ضع أدوات وملابس واقية على عينيك وأذنيك وجسمك.

READ AND UNDERSTAND THE MANUFACTURER'S INSTRUCTION FOR THIS EQUIPMENT AND THE CONSUMABLES TO BE USED AND FOLLOW YOUR EMPLOYER'S SAFETY PRACTICES.

SE RECOMIENDA LEER Y ENTENDER LAS INSTRUCCIONES DEL FABRICANTE PARA EL USO DE ESTE EQUIPO Y LOS CONSUMIBLES QUE VA A UTILIZAR, SIGA LAS MEDIDAS DE SEGURIDAD DE SU SUPERVISOR.

LISEZ ET COMPRENEZ LES INSTRUCTIONS DU FABRICANT EN CE QUI REGARDE CET EQUIPMENT ET LES PRODUITS A ETRE EMPLOYES ET SUIVEZ LES PROCEDURES DE SECURITE DE VOTRE EMPLOYEUR.

LESEN SIE UND BEFOLGEN SIE DIE BETRIEBSANLEITUNG DER ANLAGE UND DEN ELEKTRODENEINSATZ DES HERSTELLERS. DIE UNFALLVERHÜTUNGSVORSCHRIFTEN DES ARBEITGEBERS SIND EBENFALLS ZU BEACHTEN.

			
<ul style="list-style-type: none"> • Keep your head out of fumes. • Use ventilation or exhaust to remove fumes from breathing zone. 	<ul style="list-style-type: none"> • Turn power off before servicing. 	<ul style="list-style-type: none"> • Do not operate with panel open or guards off. 	WARNING
<ul style="list-style-type: none"> • Los humos fuera de la zona de respiración. • Mantenga la cabeza fuera de los humos. Utilice ventilación o aspiración para gases. 	<ul style="list-style-type: none"> • Desconectar el cable de alimentación de poder de la máquina antes de iniciar cualquier servicio. 	<ul style="list-style-type: none"> • No operar con panel abierto o guardas quitadas. 	Spanish AVISO DE PRECAUCION
<ul style="list-style-type: none"> • Gardez la tête à l'écart des fumées. • Utilisez un ventilateur ou un aspirateur pour ôter les fumées des zones de travail. 	<ul style="list-style-type: none"> • Débranchez le courant avant l'entretien. 	<ul style="list-style-type: none"> • N'opérez pas avec les panneaux ouverts ou avec les dispositifs de protection enlevés. 	French ATTENTION
<ul style="list-style-type: none"> • Vermeiden Sie das Einatmen von Schweißrauch! • Sorgen Sie für gute Be- und Entlüftung des Arbeitsplatzes! 	<ul style="list-style-type: none"> • Strom vor Wartungsarbeiten abschalten! (Netzstrom völlig öffnen; Maschine anhalten!) 	<ul style="list-style-type: none"> • Anlage nie ohne Schutzgehäuse oder Innenschutzverkleidung in Betrieb setzen! 	German WARNUNG
<ul style="list-style-type: none"> • Mantenha seu rosto da fumaça. • Use ventilação e exaustão para remover fumo da zona respiratória. 	<ul style="list-style-type: none"> • Não opere com as tampas removidas. • Desligue a corrente antes de fazer serviço. • Não toque as partes elétricas nuas. 	<ul style="list-style-type: none"> • Mantenha-se afastado das partes moventes. • Não opere com os painéis abertos ou guardas removidas. 	Portuguese ATENÇÃO
<ul style="list-style-type: none"> ● ヒュームから頭を離すようにして下さい。 ● 換気や排煙に十分留意して下さい。 	<ul style="list-style-type: none"> ● メンテナンス・サービスに取りかかる際には、まず電源スイッチを必ず切して下さい。 	<ul style="list-style-type: none"> ● パネルやカバーを取り外したまま機械操作をしないで下さい。 	Japanese 注意事項
<ul style="list-style-type: none"> ● 頭部遠離煙霧。 ● 在呼吸區使用通風或排風器除煙。 	<ul style="list-style-type: none"> ● 維修前切斷電源。 	<ul style="list-style-type: none"> ● 儀表板打開或沒有安全罩時不準作業。 	Chinese 警告
<ul style="list-style-type: none"> ● 얼굴로부터 용접가스를 멀리하십시오. ● 호흡지역으로부터 용접가스를 제거하기 위해 가스제거기나 동풍기를 사용하십시오. 	<ul style="list-style-type: none"> ● 보수전에 전원을 차단하십시오. 	<ul style="list-style-type: none"> ● 관널이 열린 상태로 작동치 마십시오. 	Korean 위험
<ul style="list-style-type: none"> ● ابعد رأسك بعيداً عن الدخان. ● استعمل التهوية أو جهاز ضغط الدخان للخارج لكي تبعد الدخان عن المنطقة التي تتنفس فيها. 	<ul style="list-style-type: none"> ● اقطع التيار الكهربائي قبل القيام بأية صيانة. 	<ul style="list-style-type: none"> ● لا تشغيل هذا الجهاز اذا كانت الاعطية الحديدية الواقية ليست عليه. 	Arabic تحذير

LEIA E COMPREENDA AS INSTRUÇÕES DO FABRICANTE PARA ESTE EQUIPAMENTO E AS PARTES DE USO, E SIGA AS PRÁTICAS DE SEGURANÇA DO EMPREGADOR.

使う機械や溶材のメーカーの指示書をよく読み、まず理解して下さい。そして貴社の安全規定に従って下さい。

請詳細閱讀並理解製造廠提供的說明以及應該使用的銀焊材料，並請遵守貴方的有閣勞動保護規定。

이 제품에 동봉된 작업지침서를 숙지하시고 귀사의 작업자 안전수칙을 준수하시기 바랍니다.

اقرأ بتمعن وافهم تعليمات المصنع المنتج لهذه المعدات والمواد قبل استعمالها واتبع تعليمات الوقاية لصاحب العمل.



• World's Leader in Welding and Cutting Products •

• Sales and Service through Subsidiaries and Distributors Worldwide •

Cleveland, Ohio 44117-1199 U.S.A. TEL: 216.481.8100 FAX: 216.486.1751 WEB SITE: www.lincolnelectric.com