

LifeFitness

ARCTIC SILVER 95SW Stairclimber

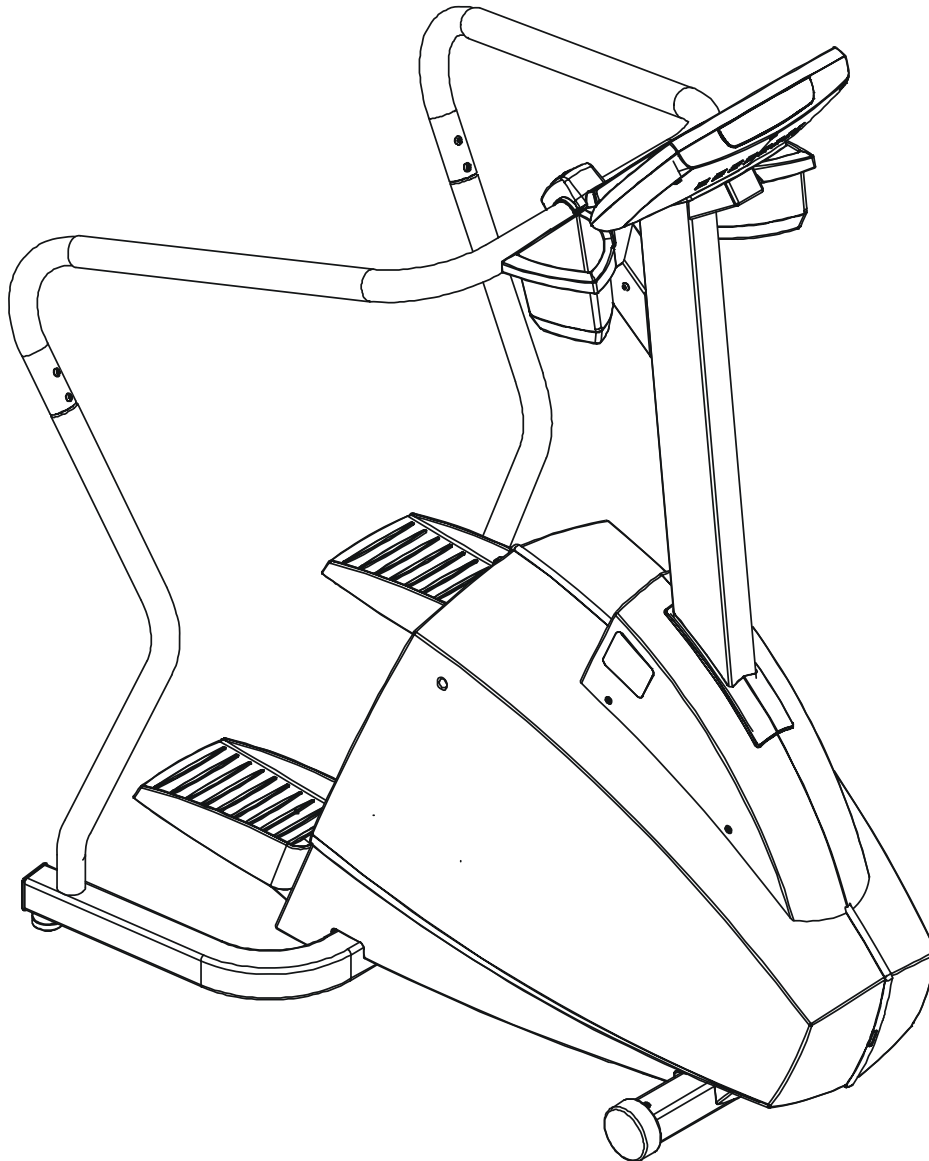

Customer Support Services
PARTS MANUAL revised 14 Jul 2008

OPERATION MANUAL	M051-00K47-A025
HARDWARE BAG	AK47-00106-0000
TOUCH UP PAINT: SPRAY CAN .5 OZ BOTTLE W/APPLICATOR .33 OZ PEN	0017-00008-0204 0017-00008-0205 0017-00008-0206
ACCESS PANEL ASSEMBLY CONSISTS OF: 1) COAX CABLE 2) POWER EXT. CABLE 3) MOUNTING PLATE 4) F TYPE CONNECTOR	AK32-00020-0002 AK32-00078-0001 0K47-01197-0001 0017-00021-2846
SERVICE MANUAL	M051-00K47-A013

NOTE: ADDING THE LCD BOLT-ON SCREEN

TO A 95SW-0XXX-01 MAKES IT A 95SER-0XXX-02.

	Page
CONSOLE COMPONENTS	4
FRAME COMPONENTS.....	5
SHROUDS AND PEDAL TUBE	6
PEDAL ASSEMBLY.....	7
CLUTCH/SHAFT/PULLEY ASSEMBLY	8
LEFT CLUTCH ASSEMBLY	9
CROSSOVER PULLEY ASSEMBLY	10
ALTERNATOR ASSEMBLY.....	11
GUIDE ROLLERS	12
POWER CONTROL BOARD & RESISTORS	13
POLAR RECEIVER ASSEMBLY	14
CABLES.....	15

ARCTIC SILVER 95SW
Console Components

95SW-0XXX-01
S/N WSC100000 and up

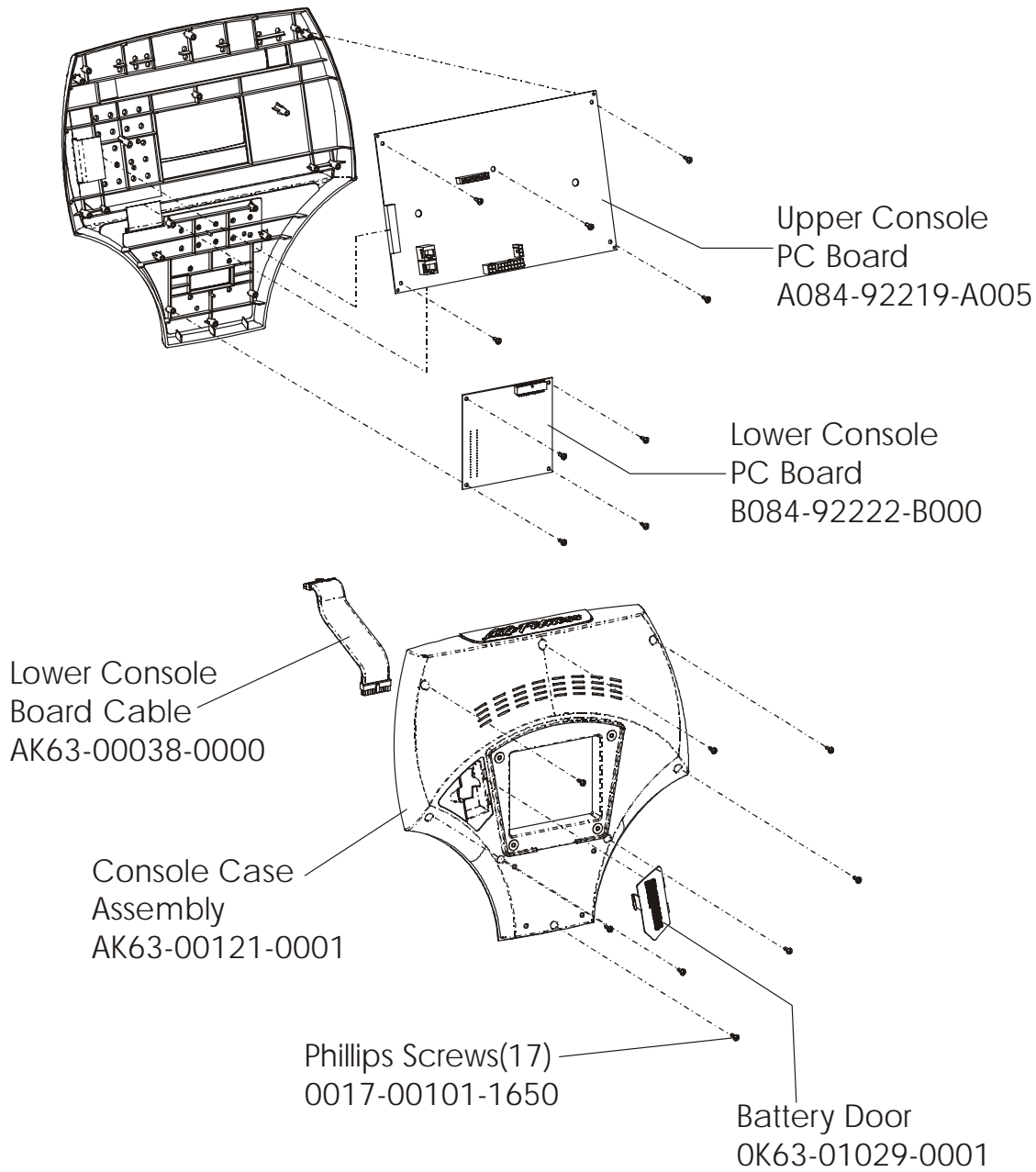

Console Assembly	Overlay/Bezel/Switch Assy.
AK47-00094-0001 Eng Met	AK47-00098-0001 Eng Met
AK47-00094-0003 Ger Met	AK47-00098-0003 Ger Met
AK47-00094-0004 Spn Met	AK47-00098-0004 Spn Met
AK47-00094-0006 Jap Met	AK47-00098-0006 Jap Met
AK47-00094-0007 Frn Met	AK47-00098-0007 Frn Met
AK47-00094-0008 Itl Met	AK47-00098-0008 Itl Met
AK47-00094-0009 Dut Met	AK47-00098-0009 Dut Met
AK47-00094-0010 Por Met	AK47-00098-0010 Por Met

ARCTIC SILVER 95SW
Frame Components

95SW-0XXX-01
S/N WSC100000 and up

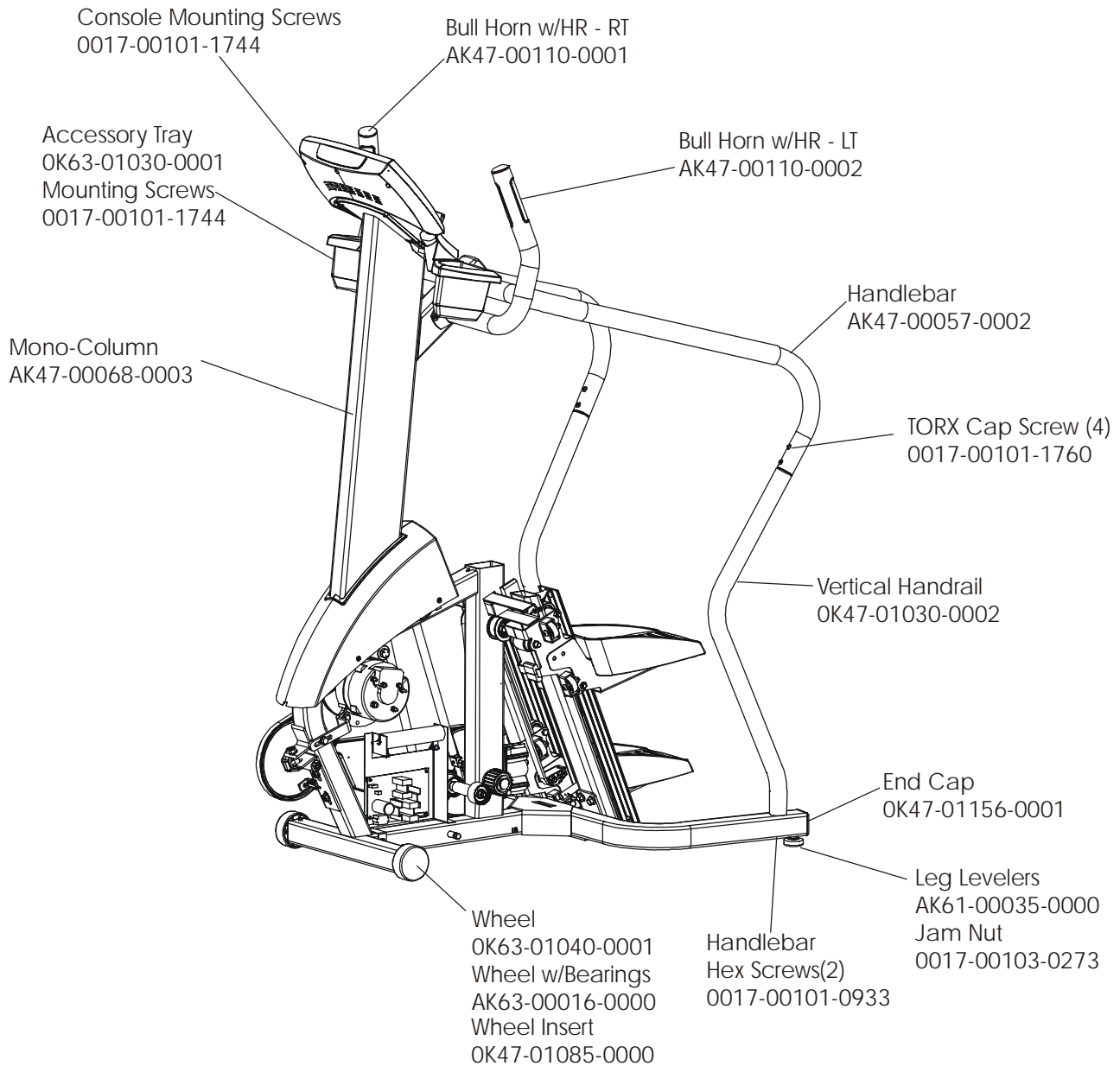

ARCTIC SILVER 95SW

Shrouds and Pedal Tube

95SW-0XXX-01
S/N WSC10000 and up

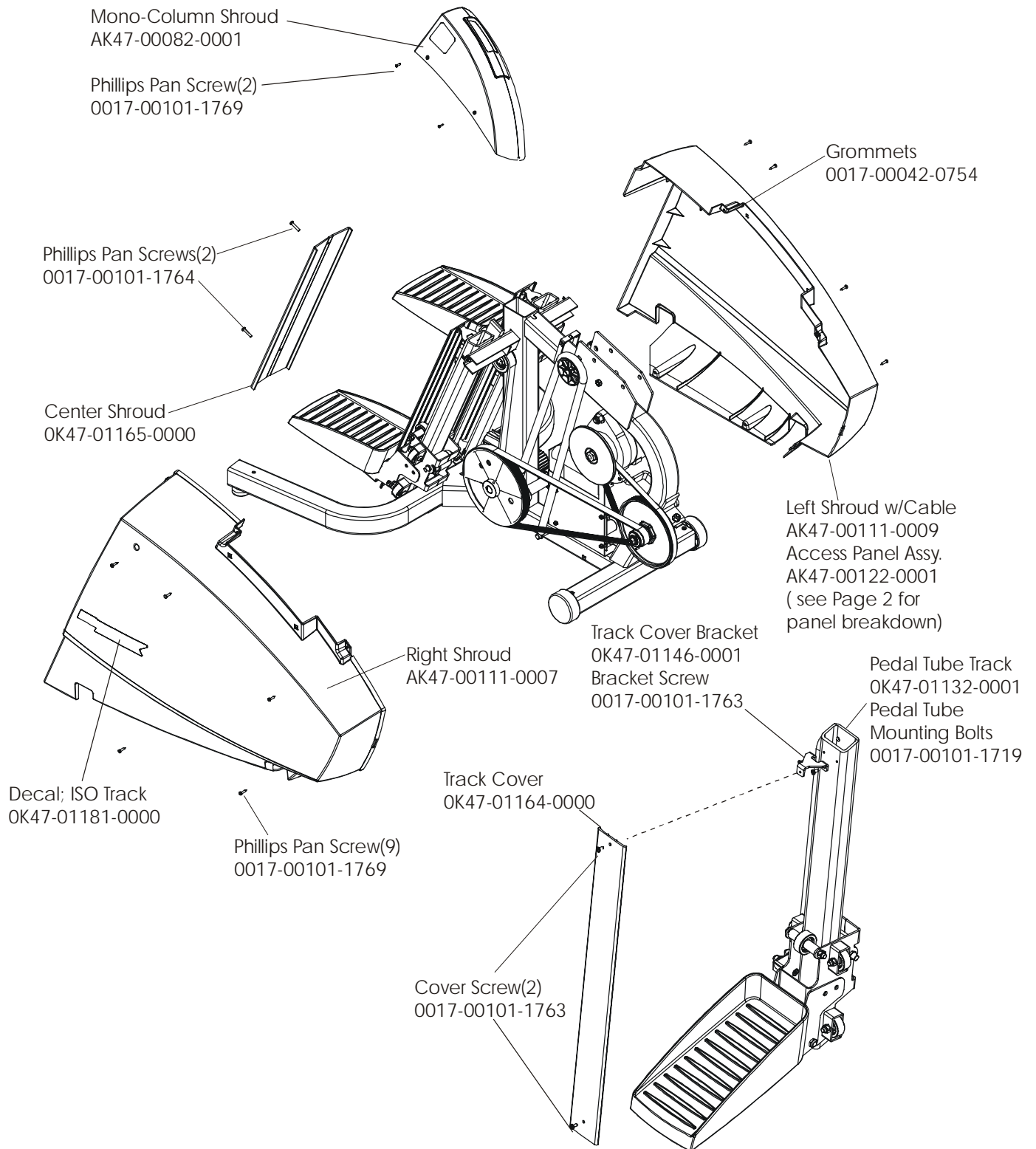

ARCTIC SILVER 95SW

Pedal Assembly

95SW-0XXX-01
S/N WSC10000 and up

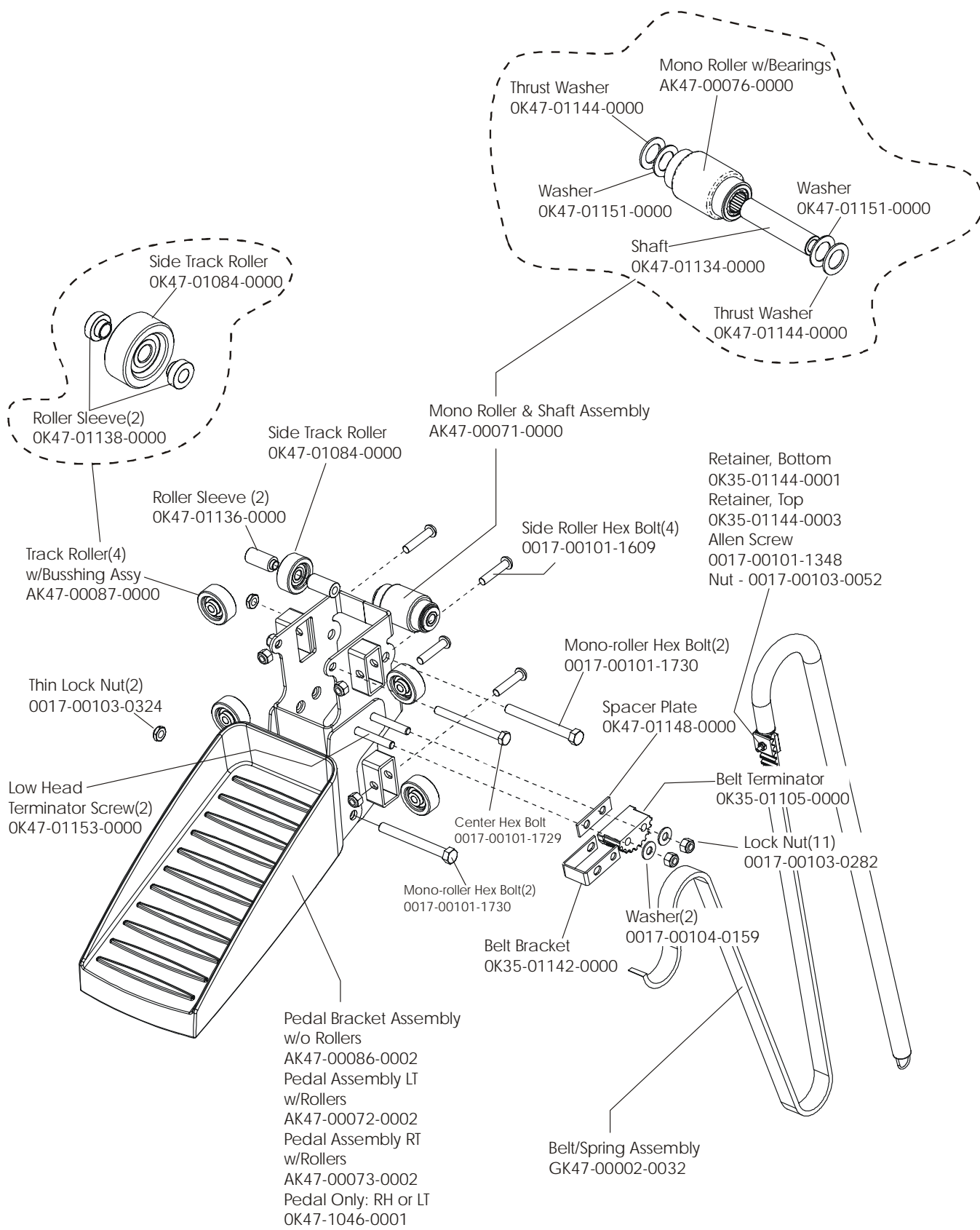

ARCTIC SILVER 95SW
Clutch/Shaft/Pulley Assembly

95SW-0XXX-01
S/N WSC100000 and up

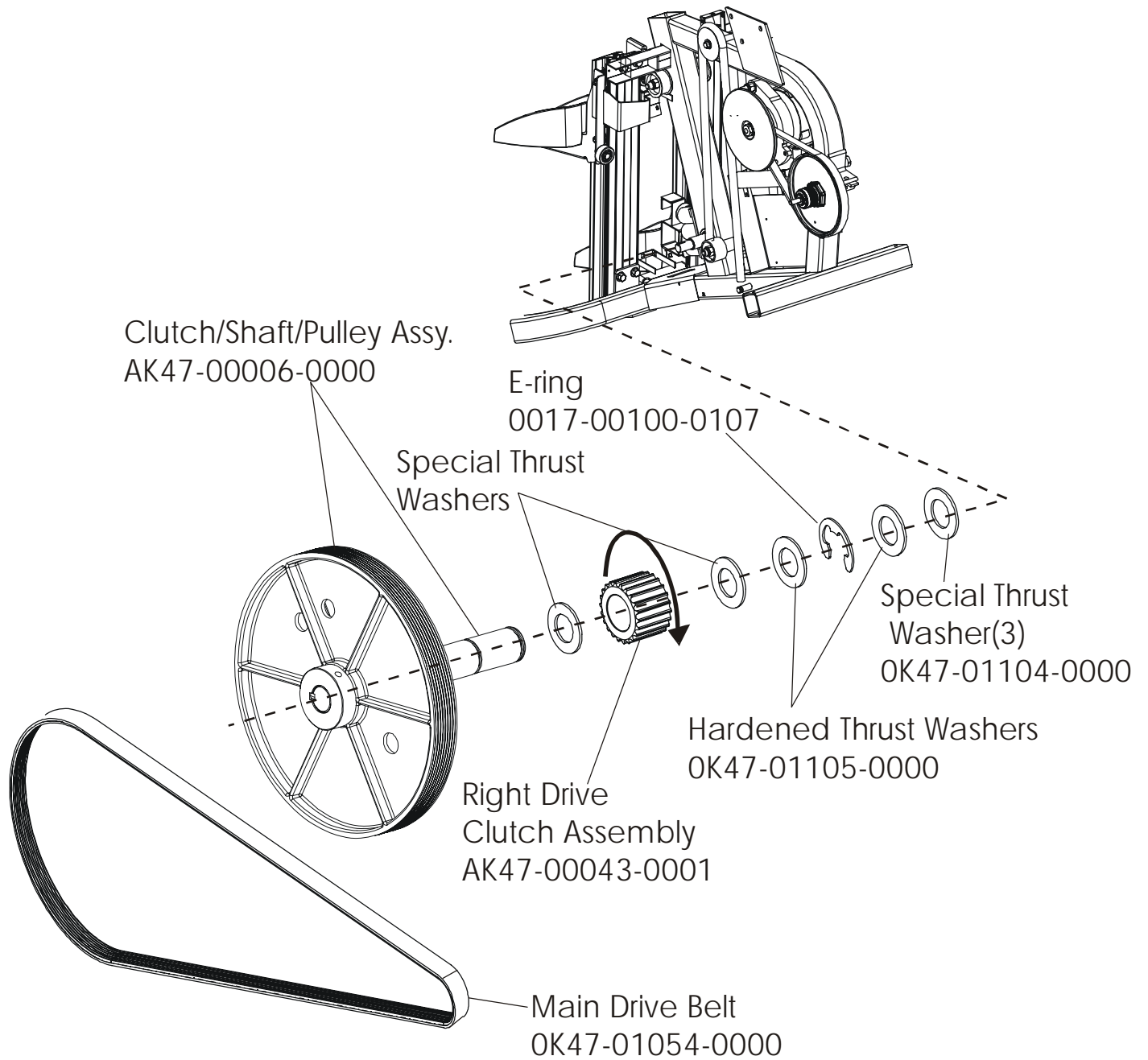

ARCTIC SILVER 95SW
Left Clutch Assembly

95SW-0XXX-01
S/N WSC100000 and up

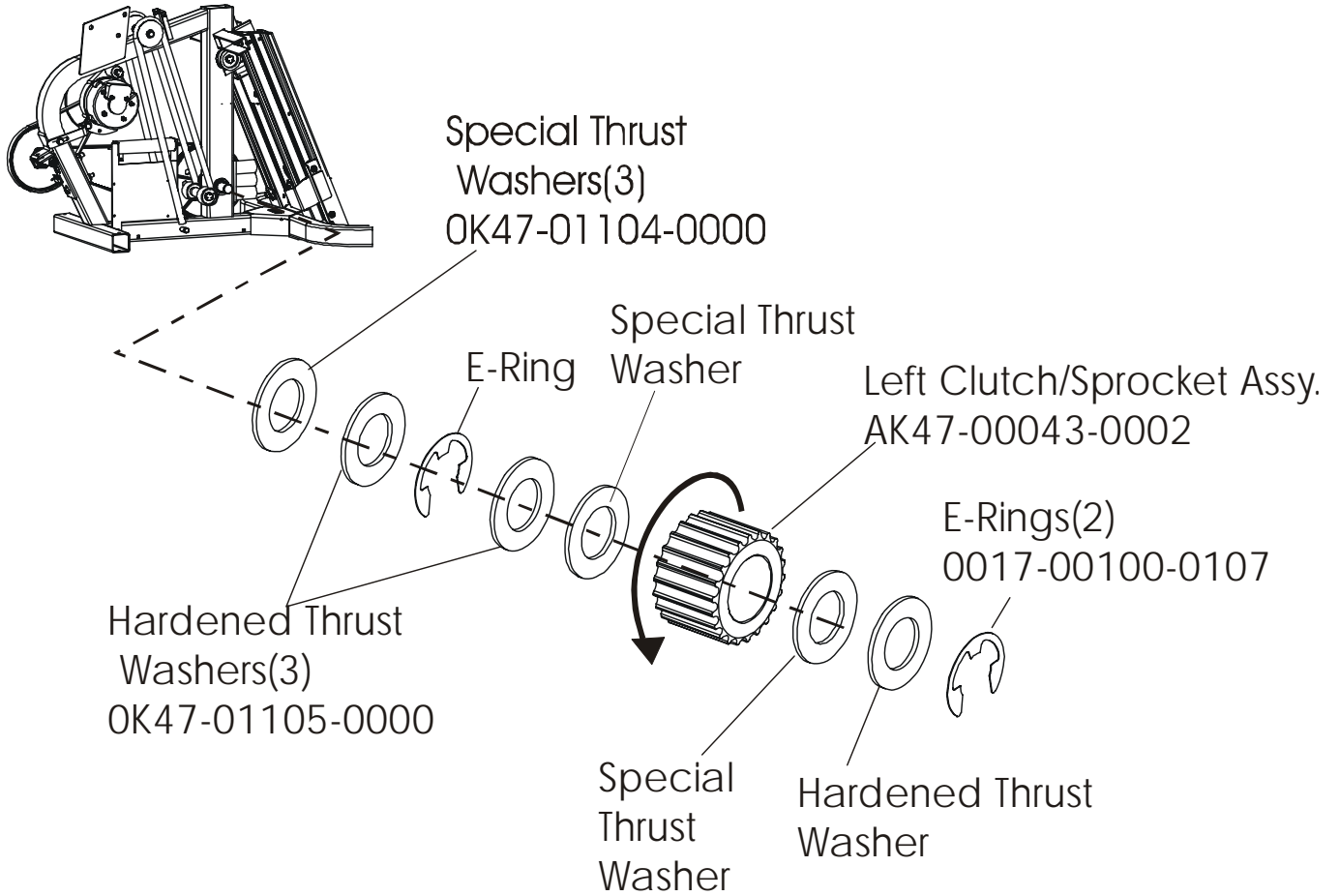

ARCTIC SILVER 95SW
Crossover Pulley Assembly

95SW-0XXX-01
S/N WSC100000 and up

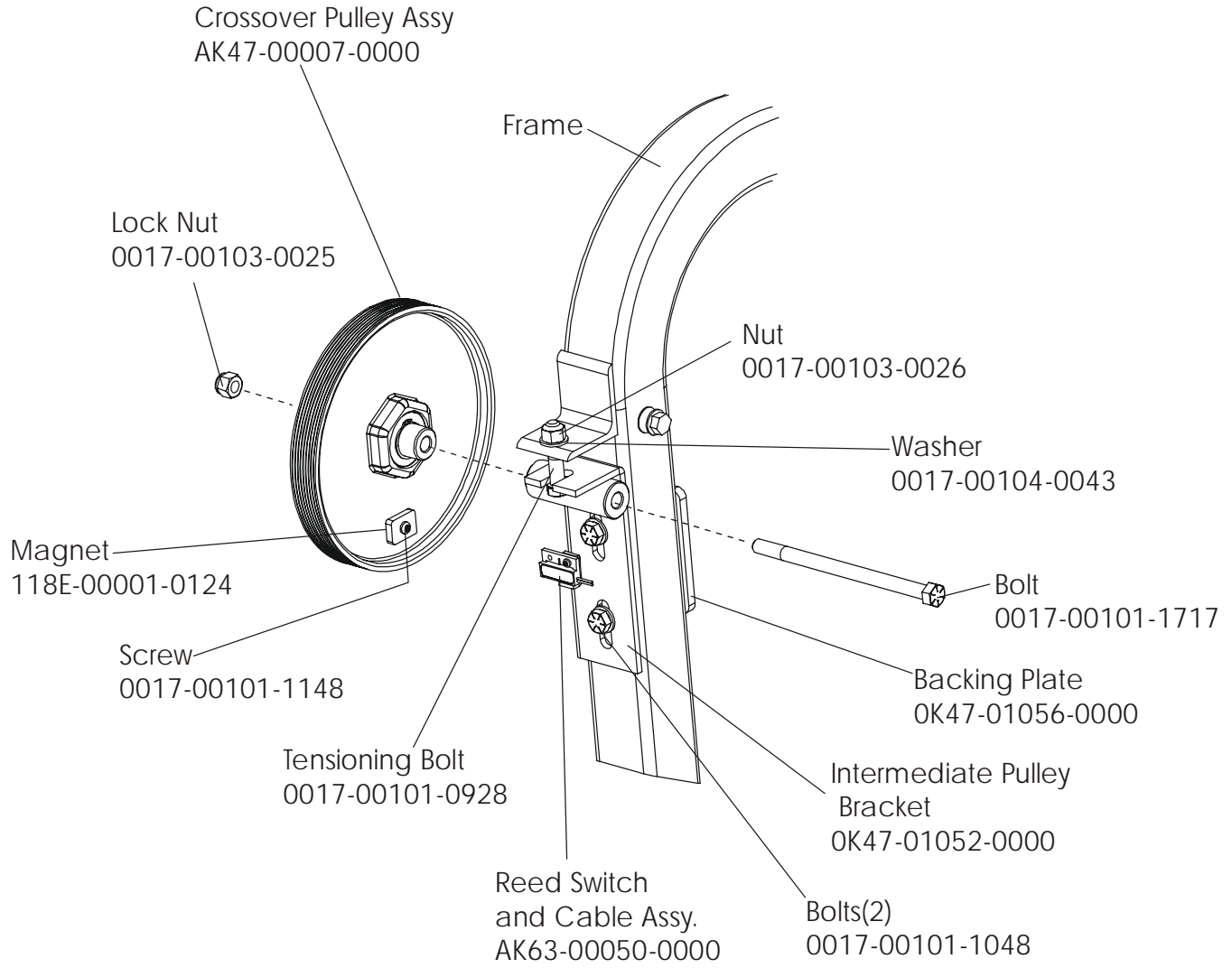

ARCTIC SILVER 95SW
Alternator Assembly

95SW-0XXX-01
S/N WSC100000 and up

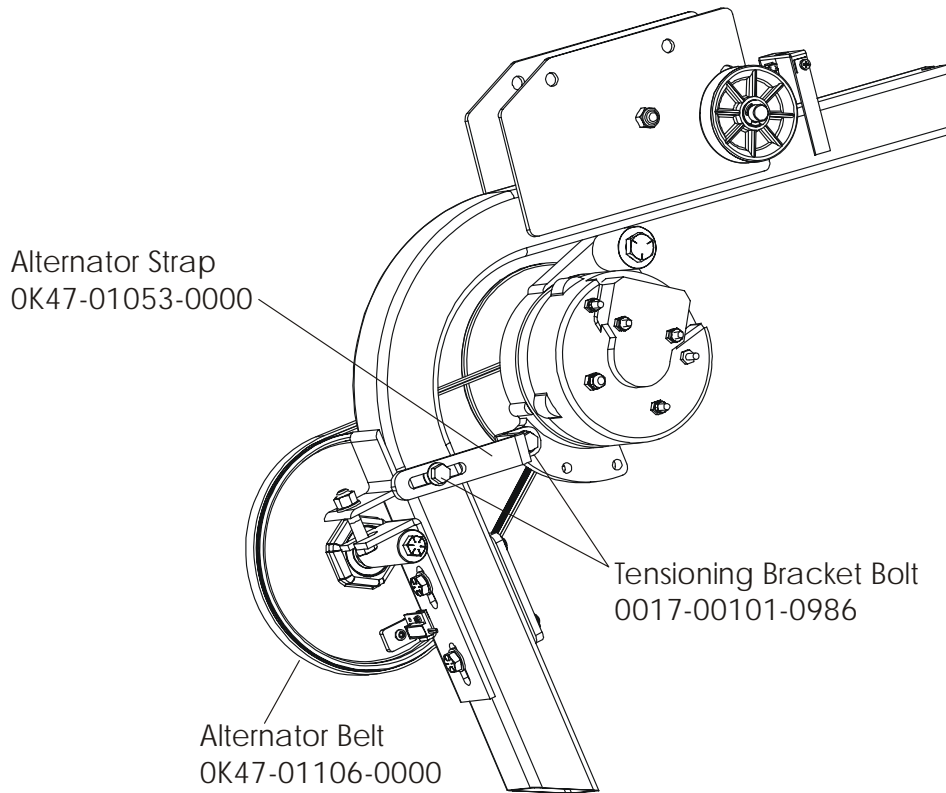
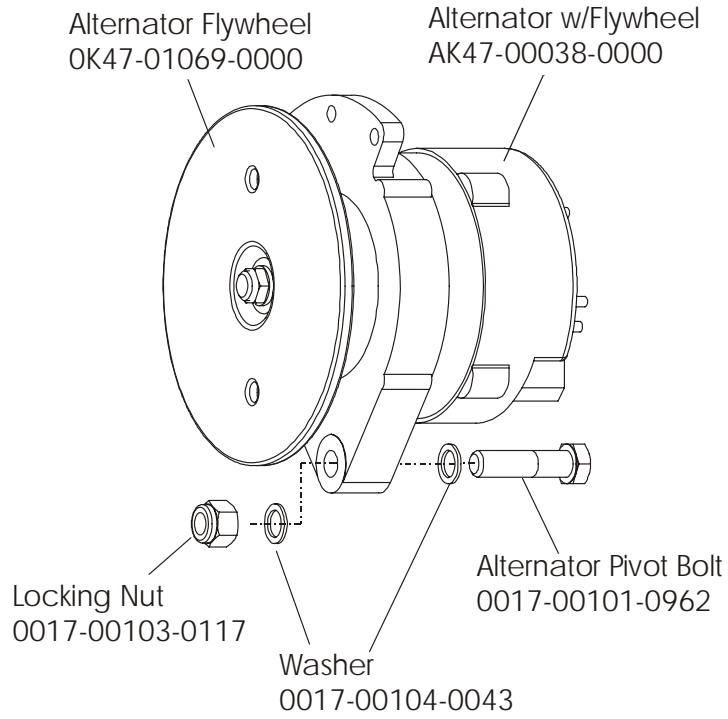

ARCTIC SILVER 95SW
Guide Rollers

95SW-0XXX-01
S/N WSC100000 and up

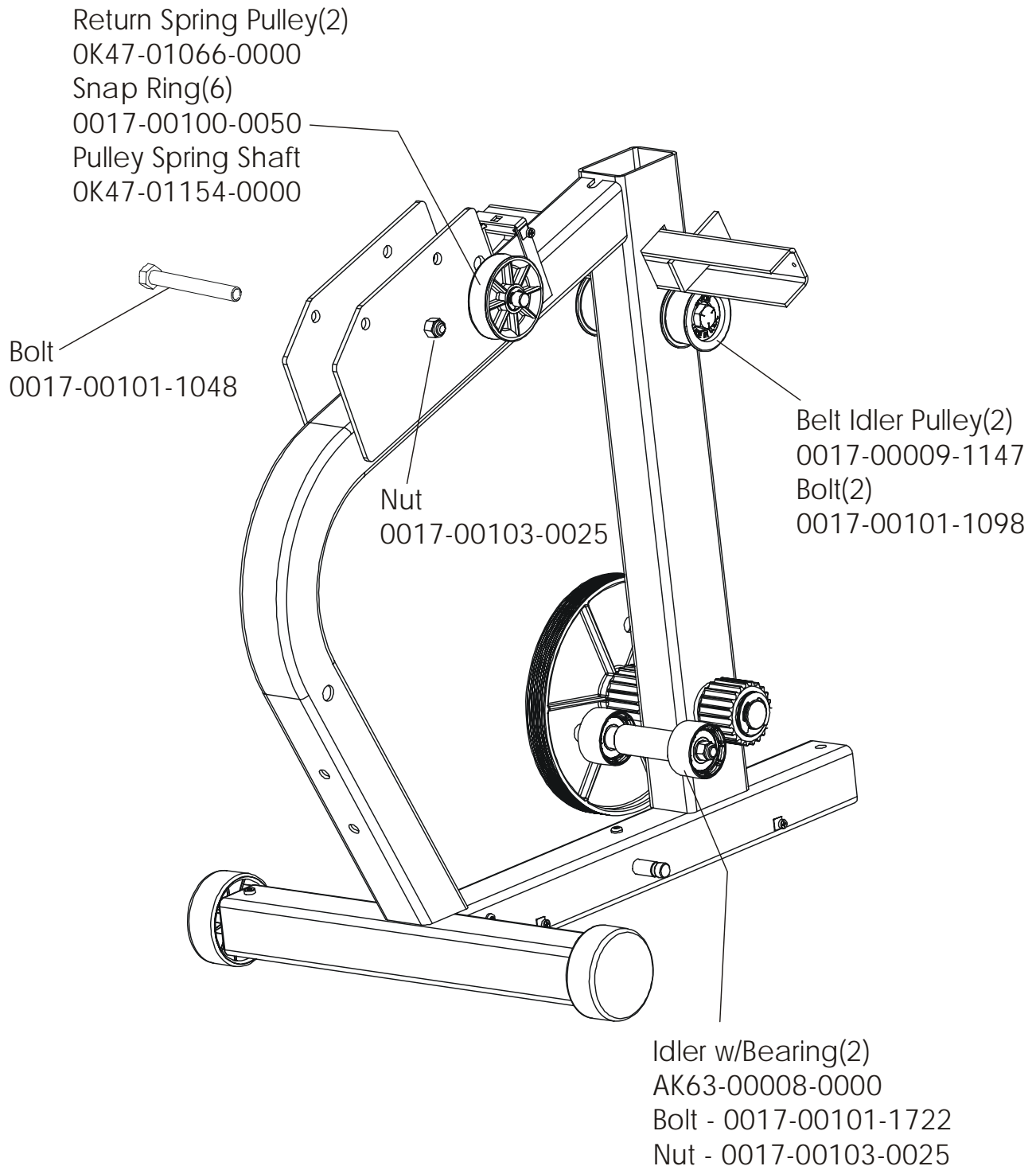

ARCTIC SILVER 95SW
Power Control Board & Resistor

95SW-0XXX-01
S/N WSC100000 and up

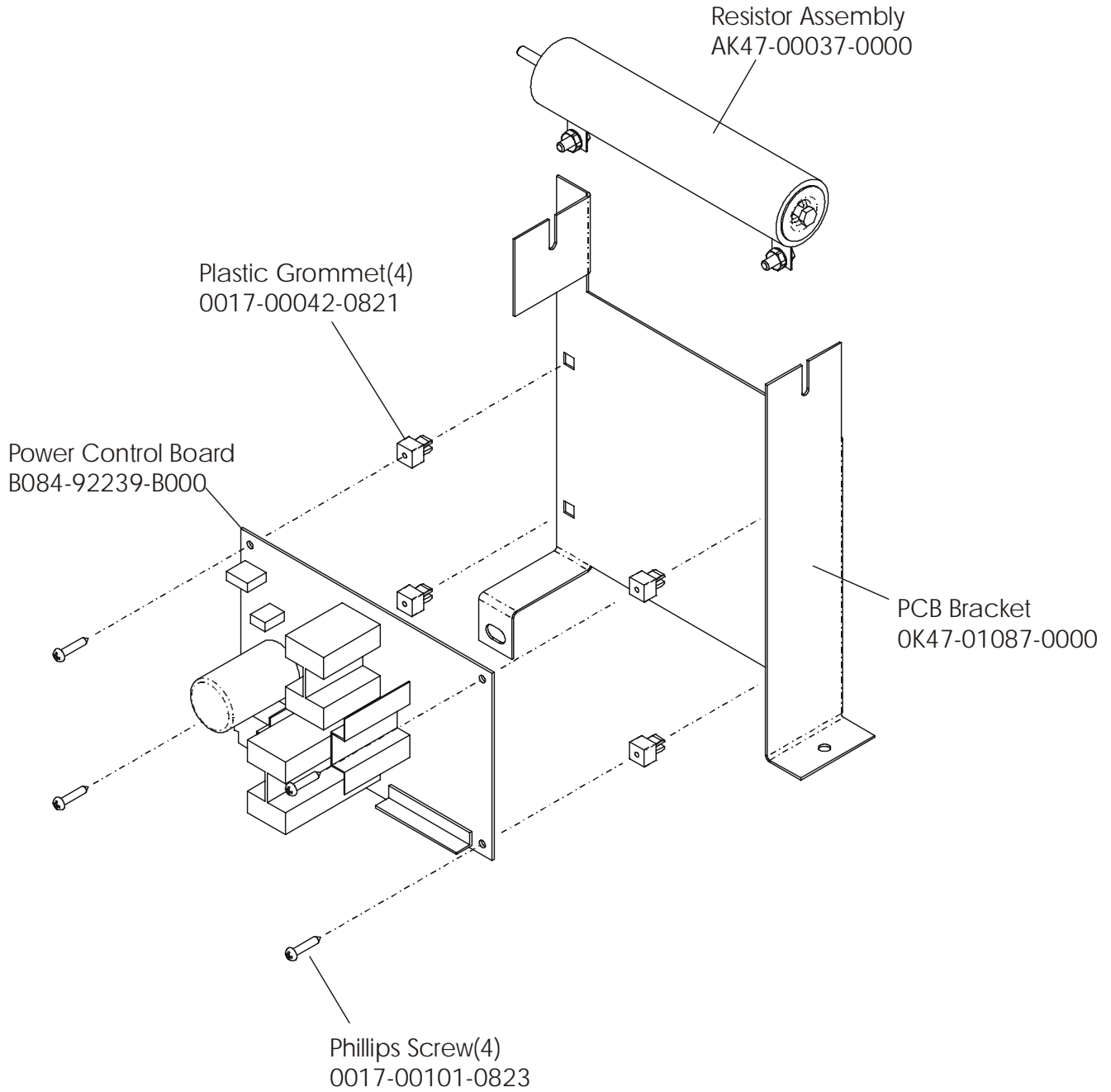

ARCTIC SILVER 95SW
Polar Receiver Assembly

95SW-0XXX-01
S/N WSC100000 and up

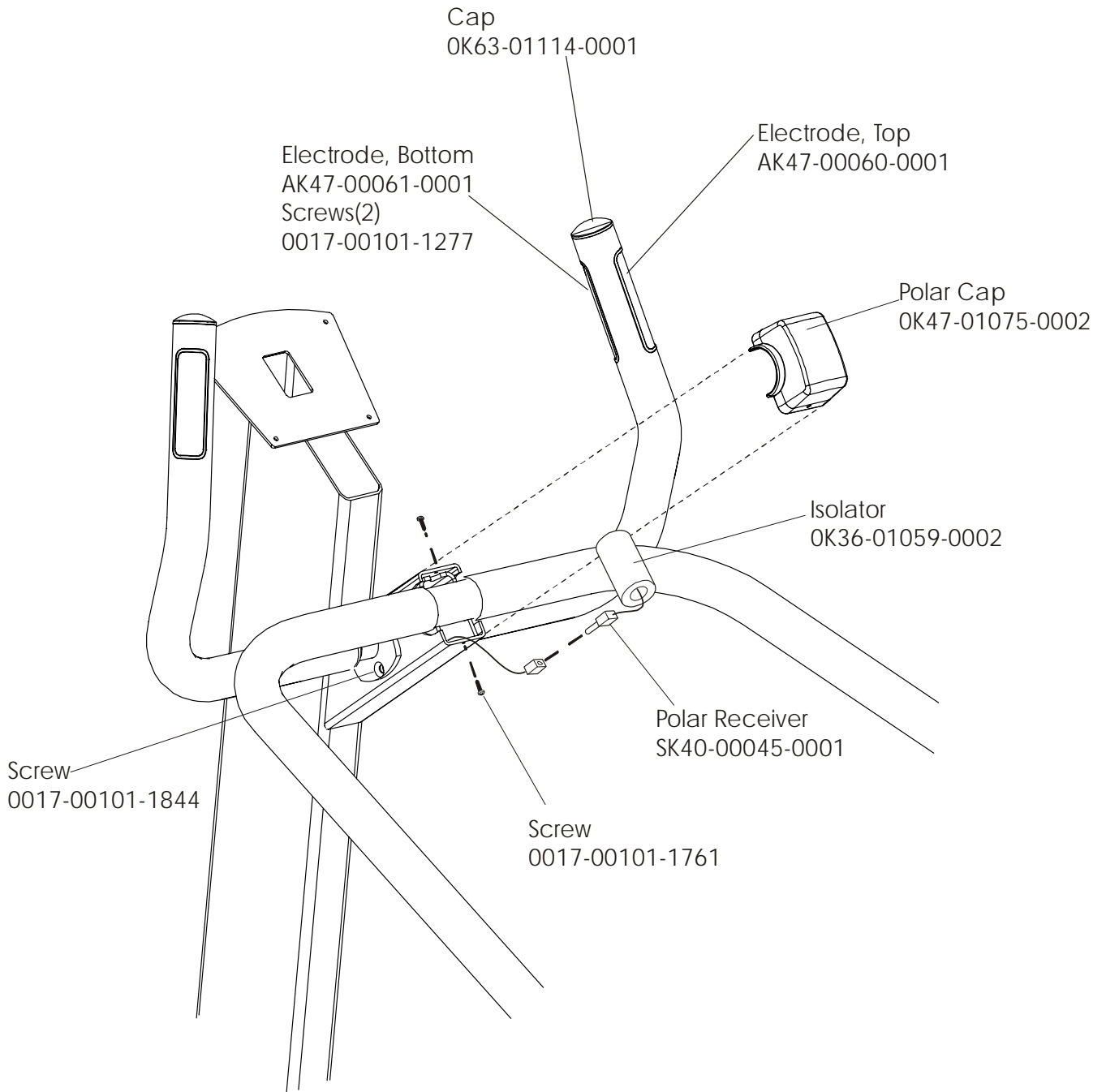

ARCTIC SILVER 95SW

Cables

95SW-0XXX-01
S/N WSC10000 and up

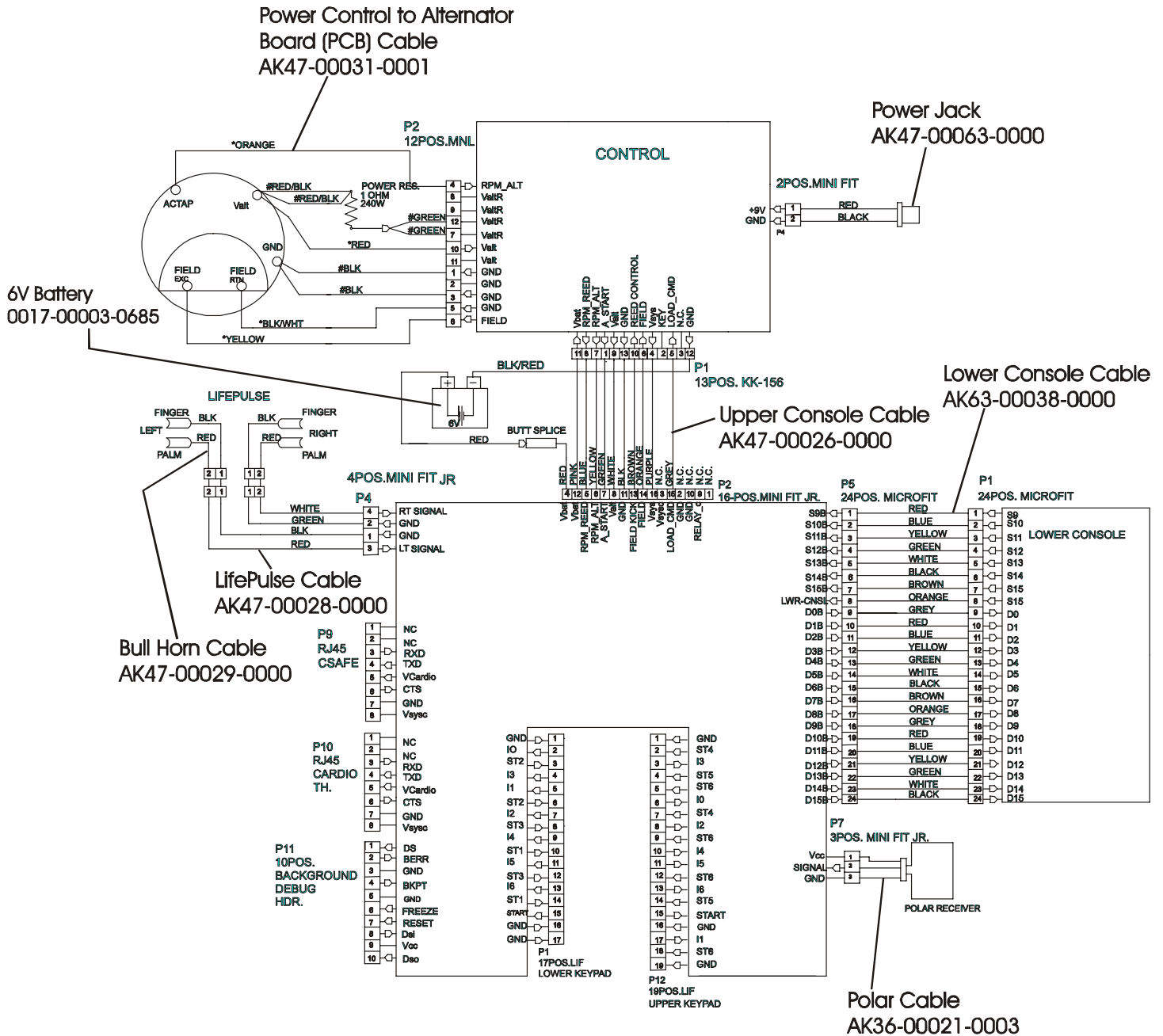

Description	Part Number
Domestic 120/60 Battery Charge w/Cord	118E-00001-0165
Universal Battery Charger w/o Line Cord	118E-00001-0166
Line Cord 220V/60Hz	0017-00003-0704
Line Cord 100V/50Hz	
Line Cord 240+	0017-00003-0918
Line Cord 220V/50Hz	
Line Cord 200V/50Hz	0017-00003-0691
Line Cord 230V/50Hz	