

LifeFitness

Model 8500 Rower

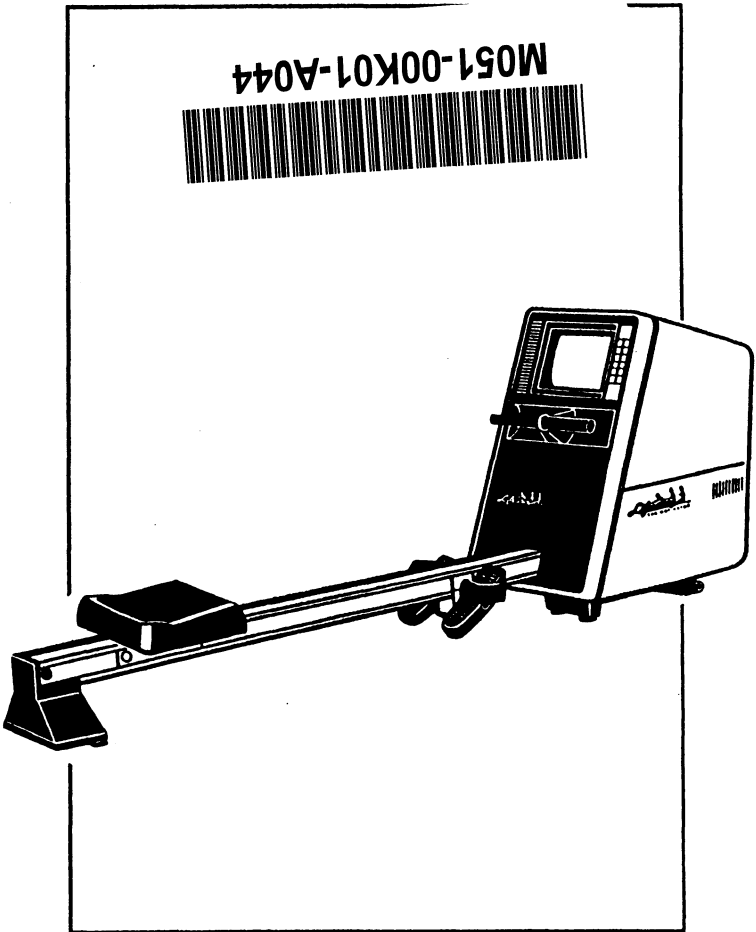

**OPERATION
MANUAL**



We bring fitness to life.®

Life Fitness
Product Support
10601 West Belmont Avenue
Franklin Park, Illinois 60131
(708) 451-0036
Telex: 721596
(800) 351-3737 TOLL FREE
FAX: (708) 451-4137

Europe:

Life Fitness Europe GmbH
Siemensstrasse 3
8044 Unterschleissheim
Munich, West Germany
Telex: 5215918 LSG
Telefon: 049 89/310 13 49
FAX: 049 89/310 73 69

TABLE OF CONTENTS

Introduction	4
TECHNICAL SAFETY INFORMATION	
Important Safety Instructions	5
Grounding Instructions	7
ROWING TECHNIQUES	
How To Row Properly	8
General Body Form	8
Rowing Position 1 (The Catch)	8
Rowing Position 2 (The Drive)	9
Rowing Position 3 (The Release)	9
Rowing Position 4 (The Recovery)	10
OPERATING INSTRUCTIONS	
Operating Instructions Summarized	11
Preliminary Operating Instructions	12
Competing Against the Pacer	12
Liferower Conditioner External Physical Features	12
How to Operate the Interval Training Program	16
Race Recap	20
The Honor Roll	21
How to Operate the Standard Program	22
How to Operate the Create Your Own Program	23
FITNESS OBJECTIVES	
How To Exercise Effectively	24
Training Heart Rate Range (THRR) Calculation	24
Checking the Pulse	24
MAINTENANCE	
Preventative Maintenance Tips	28
How To Solve Minor Operating Problems	29
How to Obtain Service for Your Product	30
SPECIFICATIONS	
Liferower Model 8500 Product Specifications	31
FIGURES:	
Figure 1: Proper Grounding	7
Figure 2: Rowing Position 1 (The Catch)	8
Figure 3: Rowing Position 2 (The Drive)	9
Figure 4: Rowing Position 3 (The Release)	9
Figure 5: Rowing Position 4 (The Recovery)	10
Figure 6: Physical Features	13
Figure 7: Keypad	13

Figure 8: Screen in START Stage	.14
Figure 9: Proper Rowing Technique	.14
Figure 10: Screen with Program Selection	.15
Figure 11: Helicopter Adds Men to Your Competitor's Boat	.16
Figure 12: Shark "Removes" the Competition	.16
Figure 13: Interval Training Program Times	.17
Figure 14: Levels of Difficulty	.17
Figure 15: Levels of Difficulty Stroke Rates	.18
Figure 16: Countdown Screens	.19
Figure 17: Coaching from the Coxswain	.19
Figure 18: Race Recap	.20
Figure 19: Honor Roll	.21
Figure 20: Program Time Choices	.22
Figure 21: Training Heart Rate Range (THRR) Chart	.25
Figure 22: Training Heart Rate Range (THRR) Numerical Table	.26
Figure 23: Preventative Maintenance	.28
Figure 24: Serial Number Location	.30
Figure 25: "Daisy Chain"	.31

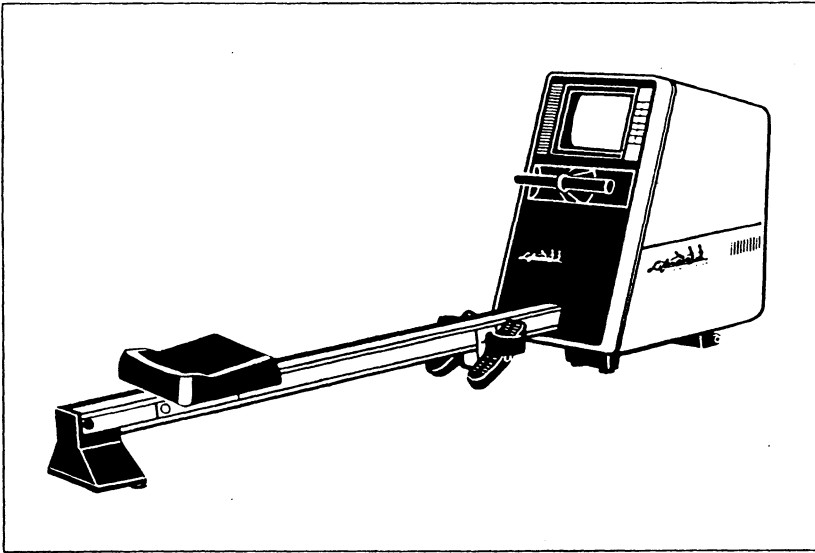

The Liferower® total body conditioner, appropriately called "The Motivator," brings competitive video motivation to traditional rowing exercise. A full-color CRT screen shows the user challenging an opponent pace boat. Rowers select difficulty levels from Beginner to Olympic. Performance readouts of distance between sculls, stroke rate, meters rowed, elapsed time and calories burned provide critical workout data, allowing the user to monitor his progress.

Life Fitness, manufacturer of the Liferower total body conditioner, is recognized as the leading producer of state-of-the-art exercise equipment. We are the same company that designed and manufactured the Lifecycle® aerobic trainer, the world's most popular computerized stationary exercise bicycle, as well as the Lifestep® aerobic trainer and the Lifecircuit® strength training system.

IMPORTANT SAFETY INSTRUCTIONS

READ THIS MANUAL NOW.

It is essential that you read this entire manual. It explains the design philosophy of the Liferower unit, how to operate the equipment and ways to tailor individual aerobic workout plans to meet individual fitness needs.

DANGER: To reduce the risk of electrical shock, always unplug the Liferower total body conditioner from the electrical outlet or the electrical power supply cord before cleaning or attempting any maintenance activity.

WARNING: To reduce the risk of burns, fire, electrical shock, or personal injury, it is imperative that you **CONNECT THE LIFEROWER UNIT TO A PROPERLY GROUNDED OUTLET ONLY** . (See "Grounding Instructions" page 9.)

SAFETY FIRST

1. The Liferower total body conditioner should never be left unattended when plugged in. Unplug from outlet when not in use, and before initiating any maintenance or repair function.
2. The equipment is for use only by adults, and close supervision is necessary when the Liferower unit is used near children, disabled persons, or pets. Appropriate measures should be taken to prevent spectators or pets from interfering in any way with the user while the user is performing an exercise routine.
3. Both hands must be on the rower handle at all times during the exercise. Never operate with only one hand.
4. The Liferower total body conditioner should be used only for the intended exercise described in this manual. Do not use attachments not recommended in writing by Life Fitness, Inc.
5. Never operate the Liferower total body conditioner if it has a damaged cord or electrical plug; if it has been dropped or damaged; or immersed in water, even partially. Contact the Product Support Center for examination procedures and repair.
6. Do not carry, drag or move the unit by the electrical cord or use such cord as a handle.
7. Keep the electrical cord away from heated surfaces.
8. Never operate the Liferower total body conditioner with the air openings blocked. Keep the air openings free of lint, hair or any obstructing material.
9. Never drop or insert any object into any opening in the Liferower unit.
10. Do not use the Liferower total body conditioner outdoors.

11. Do not use where aerosol spray products are being used, or where oxygen is being administered. Such substances increase the danger of combustion or explosion.
12. To disconnect, move the power switch to the "OFF" position, then remove the plug from the electrical outlet by gripping the plug firmly and pulling it out of the outlet. Do not disengage the plug from the electrical outlet by pulling on the cord.
13. **WARNING: HANDLE WILL RETRACT FORCEFULLY, DO NOT RELEASE HANDLE WHEN EXTENDED.**

THIS PRODUCT IS INTENDED FOR HOUSEHOLD AND COMMERCIAL USE.

NOTE: Underwriter's Laboratories has reviewed this product with respect to the applicable UL standards for household use of this product. The listing mark carried by the product is an indication that UL has found that the product has met the requirements of that testing.

14. Before using the Liferower total body conditioner, make sure that the machine is level and both rear levelers at the base pedestal are touching the floor.

SAVE THESE INSTRUCTIONS FOR FUTURE REFERENCE.



Underwriters Laboratories Inc. ®

GROUNDING INSTRUCTIONS

The Liferower total body conditioner must be properly grounded. If the product should malfunction or break down, proper grounding provides a path of least resistance for electrical current which reduces the risk of electrical shock to someone touching or using the unit. It is equipped with an electrical cord which includes an equipment grounding conductor and a grounding plug. The plug must be plugged into an appropriate outlet (Illustration A in Figure 1) that is properly installed and grounded in accordance with all local codes and ordinances.

Figure 1. Proper grounding

Illustration A

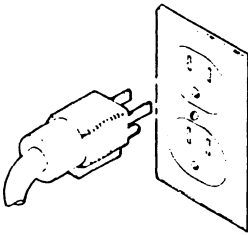
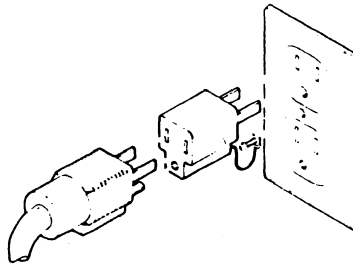

Illustration B



DANGER - A risk of electrical shock may result from improper connection of the equipment-grounding conductor. Check with a qualified electrician or serviceman if you are in doubt as to proper grounding technique. Do not modify the plug provided with the product. If it will not fit your electrical outlet, have a proper outlet installed by a qualified electrician.

This product is for use on a normal 120-volt electrical circuit, and has a grounding plug that looks like the plug depicted in Illustration A in Figure 1. A temporary adapter similar to adapter illustrated in Illustration B may be used to connect this plug to a 2-pole receptacle if a properly grounded outlet is not available. **THE TEMPORARY ADAPTER SHOULD BE USED ONLY UNTIL A PROPERLY GROUNDED OUTLET (Illustration A) CAN BE INSTALLED BY A QUALIFIED ELECTRICIAN. THE GREEN EAR OR LUG MUST BE CONNECTED TO A PERMANENT GROUND SUCH AS A PROPERLY GROUNDED OUTLET BOX COVER. IT MUST BE HELD IN PLACE SECURELY BY THE COVERPLATE SCREW.**

SAVE THESE INSTRUCTIONS FOR FUTURE REFERENCE



Underwriters Laboratories Inc.®

HOW TO ROW PROPERLY

GENERAL BODY FORM

Rowing on a Liferower total body conditioner is a fluid motion which blends the use of legs, shoulders, back and arms together into a coordinated powerful motion. There should never be any jerking or lunging. The separate muscle groups should not produce independent power surges, but instead they should work together to produce a blended, coordinated motion. Peak power should come at mid-stroke with only a slight decrease in power leading up to the finish of the stroke. Though power is released quickly at the finish of the stroke, it should still be a smooth motion with no sudden jerks toward the chest. Your club members must be careful not to slump low in the seat with their lower back. They should sit up straight but remain relaxed and they must never sit in a rigid or stiff position during any part of the stroke cycle.

In order to achieve a pleasant rowing feeling, your members must learn to move their bodies in a smooth and efficient manner. They will find that the basic rowing motion is quite simple to develop.

There are four important positions to be aware of as your club members begin to master the fluid motion of rowing. Thinking about these positions as they row will help them blend their efforts into a coordinated, pleasing motion.

ROWING POSITION 1

Figure 2: Start of the stroke (also called "the catch" by competitive rowers)

A. Correct

B. Incorrect

C. Incorrect

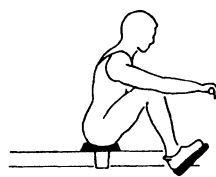
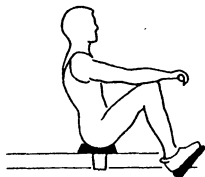
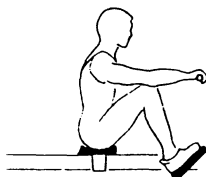

The upper body should be tilted forward until the stomach and chest are gently touching the thighs. With both hands firmly grasping the handle, the arms should be extended forward enough so that the legs are in the position of a deep knee bend. Figure 2B and 2C above are both incorrect because the upper body has too little or too much forward tilt.

ROWING POSITION 2

Figure 3: Mid-stroke (also called "the drive")

A. Correct

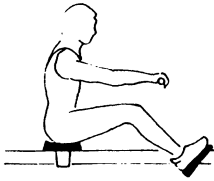

B. Incorrect

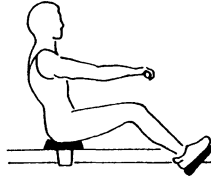

C. Incorrect

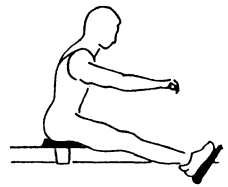

At mid-stroke, the shoulders should be in a vertical line with the hips, with the arms still fully extended and the legs extended halfway or slightly past halfway as depicted in Figure 3A. The position in Figure 3B is incorrect because the back is now tilting too far backwards. This is usually caused by starting in position 3B. Position 3C is also incorrect because the back is tilted too far forward and the legs are nearly extended. This results from starting in position 3C or pushing too hard with the legs and letting the back collapse forward. Rowers call this "shooting your seat" which is an inefficient way to use leg energy and tends to cause low back strain.

ROWING POSITION 3

Figure 4: Finish of the stroke (also called "the release")

A. Correct

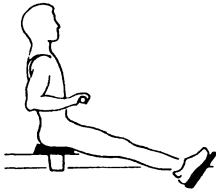

B. Incorrect

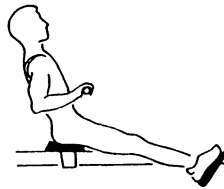

C. Incorrect

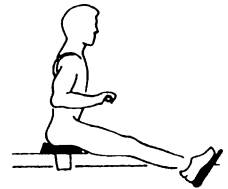

At the finish of the stroke, the upper body should be tilted back slightly past perpendicular and the legs fully extended. The arms should be pulled in with the forearms nearly horizontal. Positions in Figures 4B and 4C are incorrect because the upper body again has an incorrect angle.

ROWING POSITION 4

Figure 5: "The Recovery"

A. Correct

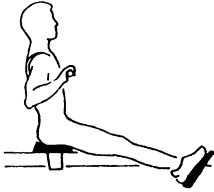

B. Incorrect

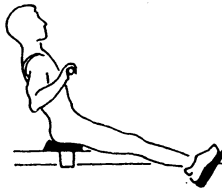

C. Incorrect

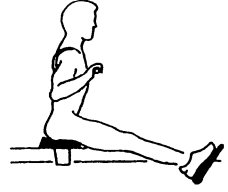

The recovery is a very important part of the stroke cycle because this is where the rower moves his arms into the correct position to start the next stroke. The key here is to have the arms bent with the handles drawn to the chest when the seat is fully extended.

OPERATING INSTRUCTIONS SUMMARIZED

- Adjust footstraps
- Press "Start" key
- Select a program
 - Press "1" for Interval Training
 - Press "2" for Standard program
 - Press "3" for Create Your Own program
- Press "Enter"
- Select an exercise time:
 - Interval Training: 6, 12, 18, 24
 - Standard program: 1, 3, 6, 12, 15, 20
 - Create Your Own program: 1-6
- Press "Enter"
- Select a stroke rate: 20-45 (only for Create Your Own program)
- Press "Enter"
- Select an exercise level
 - Interval Training: 1-15
 - Standard program: 1-15
 - Create Your Own program: 1-15
- Press "Enter"

PRELIMINARY OPERATING INSTRUCTIONS

The Liferower total body conditioner is a very sophisticated piece of aerobic conditioning equipment which is intended only for use by adult club members. It provides a thorough workout for all major muscle groups. The Liferower unit is also one of the easiest pieces of exercise equipment to use on the market today. All of the guesswork previously associated with the programming of electronic equipment has been eliminated through the use of the instructional capabilities provided for you on a CRT (TV screen). There is even a tutorial segment that will teach members the fundamentals involved in the rowing stroke. The section "How to Row Properly" of this manual goes into much further detail, describing the subtle movements and timing involved in a properly executed rowing stroke. Make sure your members are familiar with the proper rowing techniques before introducing them to the Liferower program.

COMPETING AGAINST THE PACER

When racing against the pace boat, your members should be ready for a real workout. They should also understand how their performance is being evaluated. When the Liferower total body conditioner was being developed, Olympic class rowers raced against the developmental prototype. The strokes taken during those races were recorded, computer analyzed and used to set the speed of the pace boat. Each stroke the user takes is evaluated by three variables: **stroke rate, length of stroke, and strength of stroke**. This provides an accurate reading of his speed against the pace boat and of the realism of the race taking place in the water. As a result, increasing the number of strokes taken per minute without maintaining proper form will not help the rower beat the pace boat. He must concentrate and complete each stroke. Rather than speed up his pace, it is better to have him slow down and make sure that his form is correct.

The pace boat can be beaten, but the user will have to exert himself to win. Your members will actually be able to **SEE** their improvement as they slowly begin to pull away from the pace boat during the race.

LIFEROWER CONDITIONER EXTERNAL PHYSICAL FEATURES

Before taking your members through a step-by-step demonstration of how the Liferower conditioner is used, you should familiarize them with the different external physical aspects of the machine. This way, they will understand the terminology you will be using during your demonstration. Figure 6 should help you to become familiar with the external parts. Figures 7 and 8 depict the keypad and monitor screen in more detail.

Figure 6: Physical features

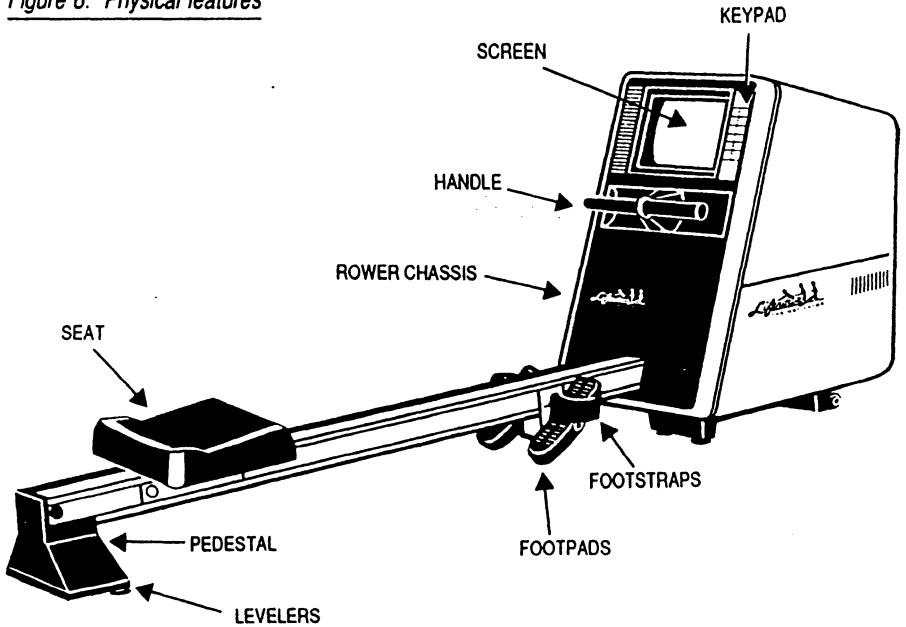

Before the rower begins, he must make sure that his feet are securely fastened in the foot straps. The foot straps adjust both to the length and width of the feet. He should slide the top of each foot under the corresponding footstrap with the bottoms of each foot touching the footpads. Both heels should be resting on the back plate of the footpad. Properly adjusted foot straps will be tightly secured around the upper mid-section of the feet.

Once the user has secured his feet in the foot straps, he should press "Start". He may want to press "Start" first and then secure the foot straps as he may find it difficult to reach the console with his feet secured. Note that the foot straps have an easy-release mechanism for use when the rower completes his exercise routine.

Figure 7: Keypad

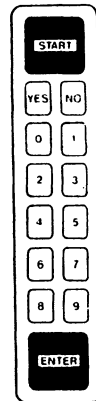
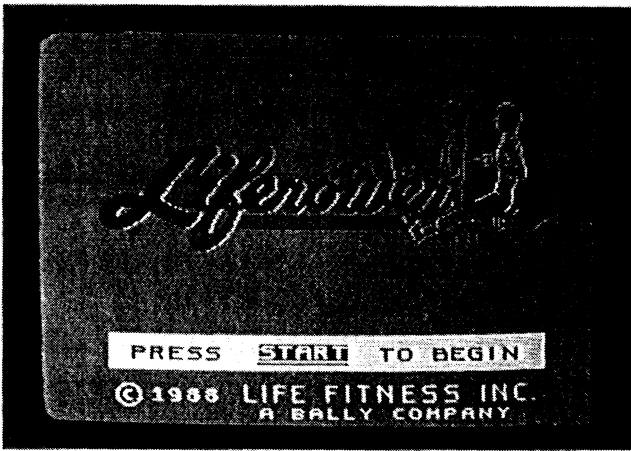
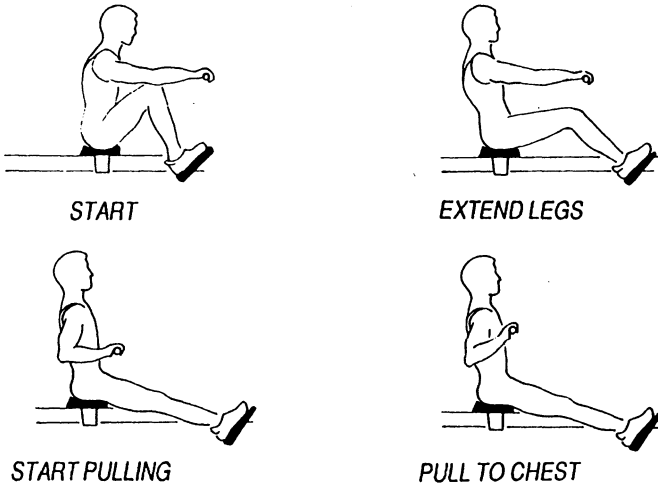

Figure 8: Screen in "Start" stage



The rower will be asked whether or not he has used the Liferower total body conditioner before. If he has not, he should press "No." When he presses "No," he will be shown a short animated tutorial depicting the correct rowing stroke in slow motion with general comments regarding technique accompanying the figures (Figure 9). The user can begin practice strokes at this time to perfect his form and warm-up his muscles.

Figure 9: Proper rowing technique



The next screen that the user will see will ask him to choose from a selection of three programs: Interval Training, Standard or the Create Your Own program.

Figure 10: Screen with program selection

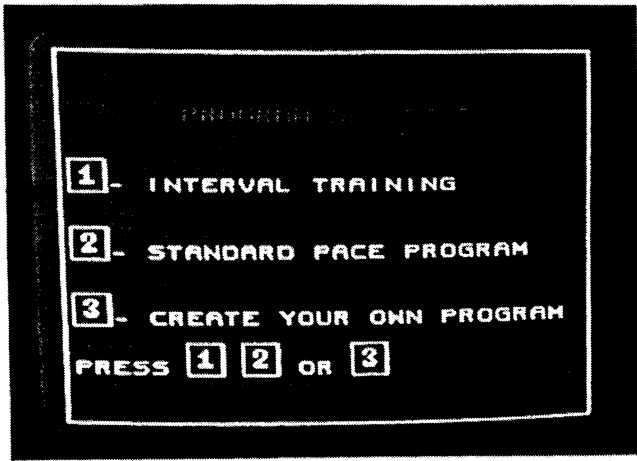

HOW TO OPERATE THE INTERVAL TRAINING PROGRAM

The Interval Training program on the Liferower total body conditioner provides a workout with a computer-generated profile comprised of periods of greater intensity followed by periods of reduced intensity. The peaks of intensity become progressively greater during the course of the exercise program. As with the other Liferower programs, you will be asked to select a time and level of difficulty. The stroke rate will be automatically computed for the rower.

During the program, when periods of greater intensity are required, a helicopter will appear on the screen and add additional rowers to the pace boat to "motivate" the user to work harder. When periods of less intensity are required, a shark fin will move across the screen and eliminate the extra pace boat rowers. (See Figures 11 and 12.)

Figure 11: Helicopter adds men to your competitor's boat

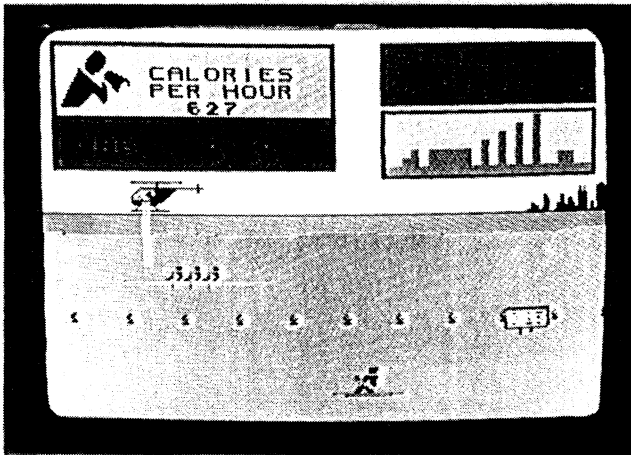
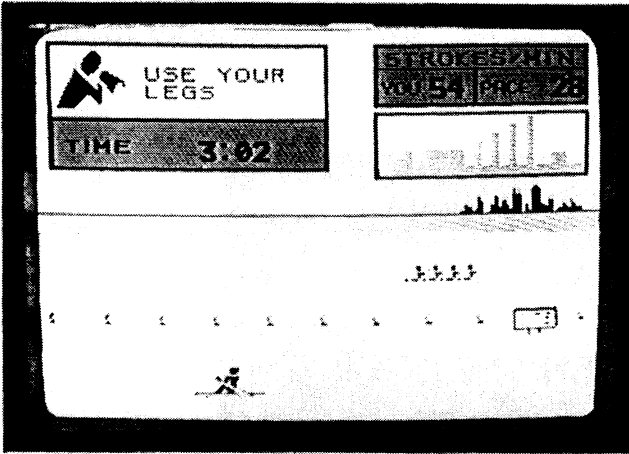

Figure 12: Shark "removes" the competition



(See "Preliminary Operation Instructions," page 12, up to the point where the program selection prompt appears.) To start an Interval Training program, when the screen prompt asks for a program selection, the rower must press the "1" key and then "Enter." The Interval Training program only offers program time selections of 6, 12, 18 or 24 minutes. These will appear on the screen in front of the rower. (See Figure 13 for table indicating interval training workout durations and corresponding objectives.) After the rower selects a time duration, he must press the "Enter" key.

Figure 13: Interval Training program times

SELECT ROWING TIME THEN PRESS "ENTER"	
6	WARM-UP
12 18	AEROBIC CONDITIONING
24	ADVANCED CONDITIONING

Next, the rower will be asked to choose the level of difficulty for his workout. The screen is color-coded to assist him in determining which level is best for him. When he chooses a level of difficulty, he is selecting a level of strokes per minute that must be maintained to keep up with the pace boat. The screen is divided into four segments. (See Figure 14.)

Figure 14: Levels of difficulty

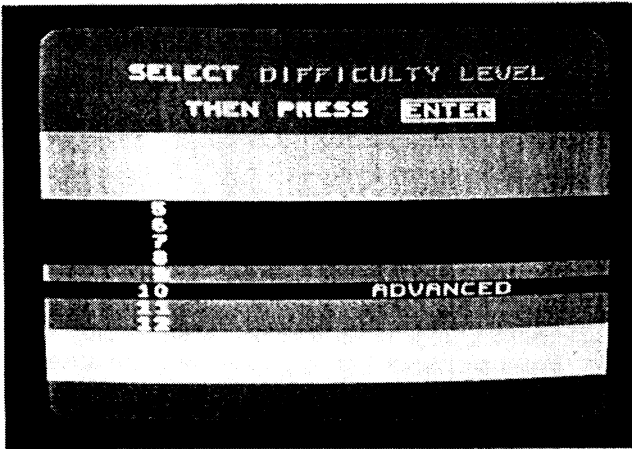

When the rower chooses the level of difficulty, the computer automatically computes his stroke rate and displays it for him on the screen. Although the information in Figure 15 is not displayed, your club members may be interested in knowing that each grouping has a different recommended stroke rate.

Figure 15: Level of difficulty stroke rates

LEVELS OF DIFFICULTY	PAGE
1	22
2	
3	
4	
5	24
6	
7	
8	
9	26
10	
11	
12	
13	28
14	
15	

NOTE: IT IS NOT RECOMMENDED THAT THE USER ROWS AT A PACE ABOVE 32 STROKES PER MINUTE ON LEVELS BELOW 9.

The suggested stroke rates provided in Figure 15 are guidelines that will help the rower understand how to beat the pace boat. The pace boat has been programmed to stroke at the middle of the ranges displayed. The strokes that the pacer will be taking are very powerful and efficient. They are modeled after strokes taken by Olympic rowers, and it may take members several tries before they are able to beat the pacer. *Note: A complete description of the proper techniques involved in the rowing stroke is provided in the "How to Row Properly" section of this manual.*

After the user has entered his desired level and has been advised of the suggested stroke rate, the next screen that appears will be the starting line. The rower should check that his feet are firmly secured in the foot straps, both hands are firmly gripping the handle and he is watching the starter in the top left corner of the screen. (See Figure 16.)

Figure 16: Countdown screens



The first 30 seconds of the race constitute a warm up period which will allow the user's body to become accustomed to the rowing motion. This time should also be used to bring the boat up to speed and set a comfortable pace for the rest of the race.

As the race progresses, the rower should watch the upper left hand corner of the screen (where the starter was) for vital information during the race. This coxswain or coach will let him know where he is in relation to the pace boat and the distance that he has covered in meters. The coxswain will also remind him to pull through the entire stroke, to keep his back straight, to use his legs and will remind him of the recommended stroke rate. (See Figure 17.)

Figure 17: Coaching from the coxswain

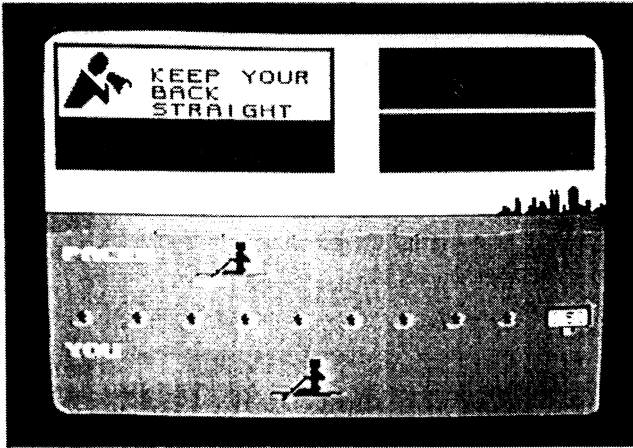

In the upper right hand corner, the rower can monitor his progress during the Interval Training program by watching the flashing light move through the "Hill and Valley" profile which made the Lifecycle aerobic trainer so popular. However, in the Liferower program, the hills and valleys relate to higher and lower stroke rates. When the rower reaches the highest "peaks" in the program, he will be competing against more rowers in the pace boat requiring him to work even harder. During the "valleys," he will be using less energy against just one rower. The Interval Training program is beneficial because it builds up the user's heart rate to his specific training heart rate range (THRR). (See page 24 for a thorough information about finding the training heart rate range.) By keeping within this range, the rower will achieve optimal aerobic benefits while avoiding unnecessary stress to his cardiorespiratory system.

The user's current stroke rate, the time remaining in the race and the current approximation of the workload expressed in calories per hour will be displayed at all times during the race. The stroke rate indicator will begin flashing if he is outside of the recommended stroke rate (too slow or too fast), and remain static when he is within the recommended range.

When the user is rowing, he may decide that the time, stroke rate or level of difficulty should be changed to better suit him. This can be done by simply pressing "Start." He will then be able to adjust the time, stroke rate or level of difficulty to best achieve his maximum performance.

HINT: If your members begin to fall behind the pace boat, simply increasing their stroke rate will not necessarily allow them to catch up with it. They must make sure that they are rowing properly, using their legs and arms correctly during the strokes.

At the end of the race (after passing the finish line), the user will immediately begin a 30-second cool down period. In this segment of the program, the stroke rate will gradually decrease allowing his body to begin to recover from his vigorous exercise bout.

If the rower qualifies, he can enter his initials on the "Honor Roll." (See Figure 19.)

RECAP OF YOUR RACE

After the cool down period is over, the rower will be shown a recap of his race accomplishments. If he has won, he will see the message "You Won" and hear the crowd cheering. If he has lost, he will see the message "Better Luck Next Time." The information that is recapped is shown in Figure 18.

Figure 18: Race recap

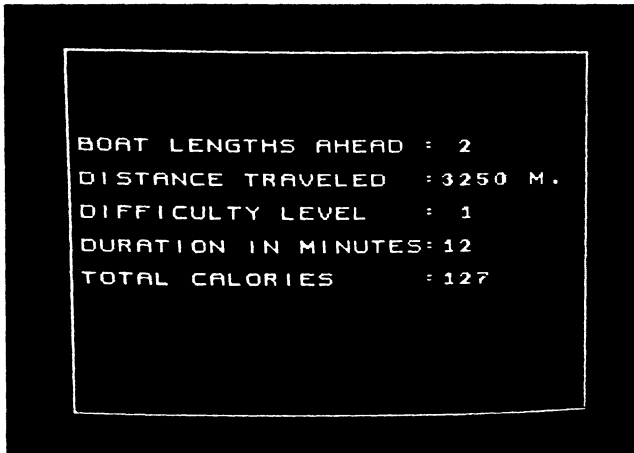

THE HONOR ROLL

In addition to this recap screen, if your club member has bettered the top distance recorded for his particular level of difficulty and time (only at level 13 and above and for time distinctions of 12, 15 or 20 minutes), he will be able to enter his initials onto THE HONOR ROLL screen. This score will be retained in the computer's memory and displayed periodically while the power is on and the machine is not being used. He may enter his initials by moving the cursor around using the "Yes" and "No" keys on the keypad. Hold the "Yes" button down to move to the right, and hold the "No" button to move to the left. Once the desired letter is highlighted, press "Enter." (This feature is only available for the times and levels listed in Figure 19.)

Figure 19: Entering initials on THE HONOR ROLL

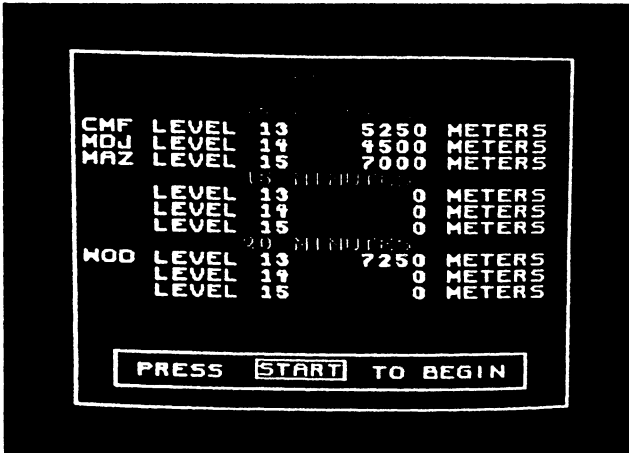

HOW TO OPERATE THE STANDARD PROGRAM

Some exercise physiologists recommend the combined use of interval and steady-state training. The Liferower total body conditioner allows both of these forms of training. The Standard program provides a complete steady-state training workout. To thoroughly understand how to operate the Standard and Create Your Own programs, you must be familiar with the previous section of this manual, "Operating The Interval Training Program."

To begin a Standard program, the rower will follow the same steps used to start the Interval Training program. (See "Preliminary Operating Instructions" section of this manual.)

First, the rower must select his program time choice. The selections are divided into three segments (Figure 20) and are more varied than the time durations for the Interval Training program.

Figure 20: Program time choices

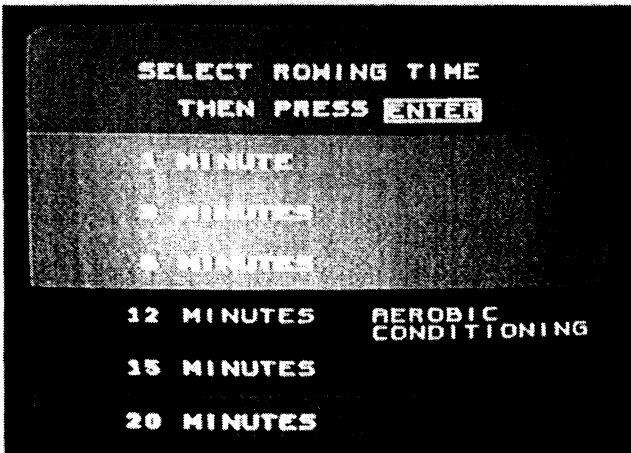

Next, the user should select his level of intensity and press "Enter." The level of intensity he selects will determine the stroke rate for the entire program. Unlike the Interval Training program, the pace does not change during the exercise. (See Figure 14.)

HOW TO OPERATE THE 'CREATE YOUR OWN PROGRAM'

If your members choose the Create Your Own program, they can create a customized program based on their specific workout goals. They will select a time, stroke rate and level of difficulty in that sequence.

For instance, they may select a workout duration of between 1 and 60 minutes. Next, they must select a stroke rate of 20 to 45 strokes per minute and a level of difficulty from 1 to 15.

A typical Create Your Own Program could consist of 6 minutes at 31 strokes per minute at level 12 or 30 seconds at 35 strokes at level 13. Once your members become familiar with this program, they will be able to program their selections specifically for their training objectives.

After entering their level of difficulty, the screen displays their stroke rate and a prompt that reads: "Wait For The Gun To Sound To Begin."

At the conclusion of the race, a summary or Recap Of Your Race will appear showing distance travelled, total calories and other race information.

HOW TO EXERCISE EFFECTIVELY

TRAINING HEART RATE RANGE CALCULATION

As a club owner, you know that exercising too hard is as ineffective as not working hard enough. In fact, it can be harmful. For an effective workout, your members must determine their optimal workout frequency, duration and intensity and stick to it!

To approximate their Training Heart Rate Range (THRR), they must first calculate their theoretical maximum heart rate. Subtract their age from 220. (This formula is recognized by the American College of Sports Medicine as a method for determining one's maximum heart rate). For example, if a member is 35 years old, his theoretical maximum heart rate is 185. Establish his THRR by multiplying this number (185) first by 65% to establish the lower limit and then by 90% to establish the upper limit.

EXAMPLE: age 35

Cardiorespiratory Training Range:

Lower Limit $(220 \text{ less } 35 = 185) \times .65 = 120 \text{ beats/minute}$

Upper Limit $(220 \text{ less } 35 = 185) \times .90 = 166 \text{ beats/minute}$

NOTE: A stress test, administered by a doctor, is the most accurate method of determining a member's maximum heart rate and overall cardiorespiratory condition. We strongly recommend that members see their doctor before beginning any exercise program, especially if they have a history of high blood pressure, heart problems or if they are over the age of 45. You, your member and his doctor can decide whether a maximum stress test is advisable.

By making sure their heart rate stays within this range during their workout, they will achieve optimal training benefits with minimal stress to their cardiorespiratory system. As their fitness program progresses, their aerobic capacity will build and their body will begin to show the benefits of what is referred to by fitness experts as "the training effect."

You can use the chart and table on page 25 and 26 to determine a member's theoretical maximum heart rate and THRR for their age category.

CHECKING THE PULSE

For best results, the user should stay within his THRR during exercise. To do this, he should check his pulse periodically during his workout.

You may wish to use an electronic pulse meter, but the member's own two fingers will suffice. A pulse can be conveniently monitored in two locations: (1) half way between the ear and wind pipe on the neck or (2) on the thumb side of the inside of the wrist. To monitor the pulse, hold the index and middle fingers together against either site. (The neck site is easiest during exercise.)

CAUTION: Do not press too hard, especially when taking a neck pulse. Excessive pressure can reduce blood flow and cause the heart to slow down.

A 15-second count is recommended. The heart rate per minute is 4 times the 15-second count.

NOTE: ROWERS SHOULD NOT ATTEMPT TO CHECK THEIR PULSE WHILE ROWING.

Figure 21: Training Heart Rate Range (THRR) chart

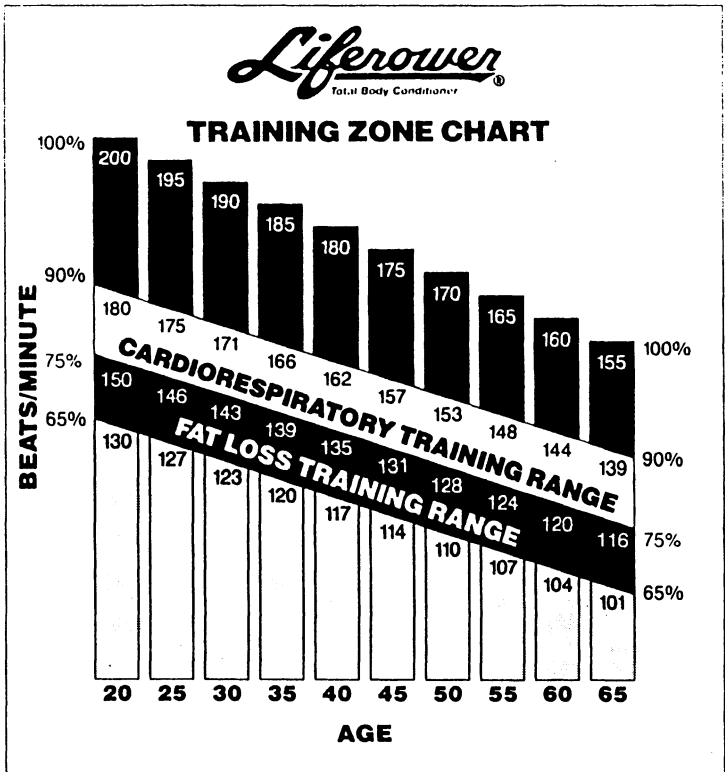

- It is not recommended to train above 90% of your theoretical maximum heart rate.
- CARDIORESPIRATORY TRAINING RANGE** -- between 75% and 90% of your theoretical maximum heart rate.
- FAT LOSS TRAINING RANGE** -- between 65% and 75% of your theoretical maximum heart rate.
- For most people, training benefits are difficult to achieve below 65% of your theoretical maximum heart rate.

Figure 22: Training Heart Rate Range (THRR) for Cardiorespiratory Improvement

AGE	MAX HR*	65% HR	75% HR	90% HR	OPTIMAL TRAINING HR**
20	200	130	150	180	160
21	199	129	149	179	159
22	198	129	148	178	158
23	197	128	148	177	158
24	196	127	147	176	157
25	195	127	146	176	156
26	194	126	145	174	155
27	193	125	145	174	154
28	192	125	144	173	154
29	191	124	143	172	153
30	190	124	142	171	152
31	189	123	142	170	151
32	188	122	141	169	150
33	187	122	140	168	150
34	186	121	139	167	149
35	185	120	139	167	148
36	184	120	138	166	147
37	183	119	137	165	146
38	182	118	136	164	146
39	181	117	136	163	145
40	180	117	135	162	144
41	179	116	134	161	143
42	178	116	133	160	142
43	177	116	133	159	142
44	176	115	132	158	141
45	175	114	131	158	140
46	174	113	130	157	139
47	173	112	130	156	138
48	172	112	129	155	138
49	171	111	128	154	137
50	170	111	127	153	136
51	169	110	127	152	135
52	168	109	126	151	134
53	167	109	125	150	134
54	166	108	124	149	133
55	165	107	124	149	132
56	164	107	123	148	131
57	163	106	122	147	130
58	162	105	121	146	130
59	161	105	121	145	129
60	160	104	120	144	128
61	159	103	119	143	127
62	158	103	118	142	126
63	157	102	118	141	126
64	156	101	117	140	125
65	155	101	116	140	124
66	154	100	115	139	123
67	153	99	115	138	122
68	152	99	114	137	122
69	151	98	113	136	121
70	150	98	112	135	120

See footnotes and explanation on the next page.

*Theoretical maximum heart rate is recognized by the American College of Sports Medicine.

** Operational training heart rate is hypothetical, based on an average person in the population; however, exercising at a specific heart rate is a precise determination that can only be made by qualified medical personnel.

A greater percentage of calories is burned when heart rate averages between 65% and 75% of the exerciser's theoretical maximum. Fat is burned best when there is plenty of oxygen available in the blood. Working out at a lower heart rate for a longer period of time tends to optimize the amount of fat burned. Lower intensity exercise allows one to work out longer, thus allowing one to burn more **total** calories.

PREVENTATIVE MAINTENANCE TIPS

1. Clean seat daily.
2. Clean extrusion's roller path and monitor cover weekly.
3. Clean outside housing bi-weekly.
4. Inspect for wear and tear on exterior parts monthly, especially the cable, cable booth, seat rollers and handle assembly.

NOTE: When cleaning the exterior of the unit, non-abrasive cleanser and soft cotton cloth are strongly recommended. At no time should cleanser be applied directly to any part of the equipment. Instead, place the non-abrasive cleaning solution on a soft cloth and wipe down the unit.

Figure 23: Preventative Maintenance

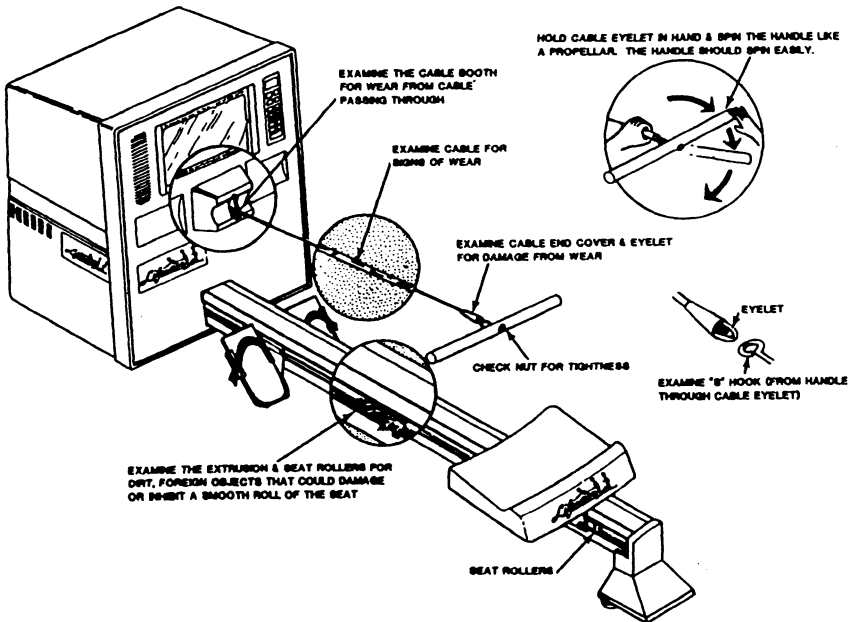

HOW TO SOLVE MINOR OPERATING PROBLEMS

SYMPTOM

SOLUTION

No power

1. Check connection at wall outlet.
2. Check connection at Liferower outlet if using "daisy-chain" power supply method.
3. Check on-off switch's position.
4. Check Liferower unit's circuit breaker.
5. Massage the keypad.

No tension

1. Check if user selected desired level of difficulty.
2. Check Liferower unit's circuit breaker.

Keys will not respond

1. Is user selecting available programming options?
2. Massage the keypad.

HOW TO OBTAIN SERVICE FOR YOUR PRODUCT

If you have a problem . . .

STEP 1:

- If possible, verify the symptom.

Speak with the person who encountered the problem. Sometimes, the problem turns out to be unfamiliarity with a product's features.

STEP 2:

- Locate and document the serial number of the unit.

The serial number of the Liferower unit is located on the rear of the housing in the lower right corner. (See figure 24, below.)

STEP 3:

- Contact Life Fitness Product Support.

Toll Free: 800-351-3737 (United States and Canada), Illinois: 708-451-0036.

FAX: 708-451-4137

Or write: Life Fitness Product Support,
10601 W. Belmont Avenue, Franklin Park, IL 60131.

Please have the serial number of the product and the symptom ready for the Support Specialist who will be assisting you. This information is necessary for us to help solve any problems you may be encountering.

Figure 24: Serial number location

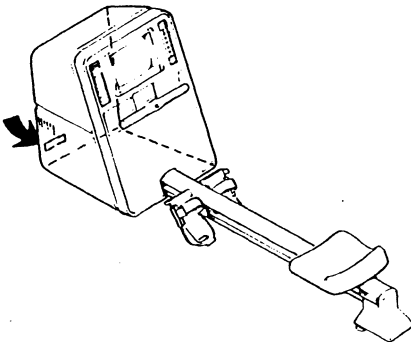

LIFEROWER MODEL 8500 PRODUCT SPECIFICATIONS

All specifications are for a fully assembled Liferower model 8500 aerobic trainer.

Physical:

Length	.90 inches
Width	22 1/4 inches
Height	.34 inches
Weight	.190 pounds
Shipping Weight	.205 pounds
Color	Warm grey with black and red accents

Electrical:

Required Power Source 120 volts, 60 Hz, 20 Amp circuit

Shipping dimensions:

Chassis 27" long, 24" wide, 36" high

Extrusion 82" long, 14" wide, 13" high

Up to three Liferower units can be powered from one circuit via the "daisy-chain" method.

Figure 25: "Daisy-chain" method

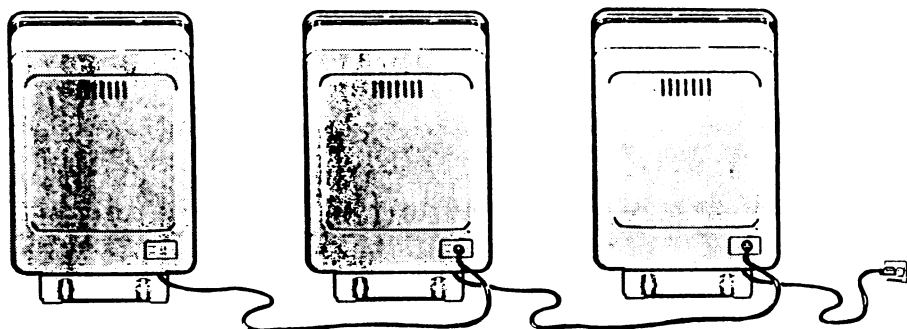

LifeFitness

Copyright 1990 Life Fitness.

All rights reserved. Life Fitness and Liferower are trademarks of Life Fitness.

M051-00K01-A044