

LARGAN

EASY 200

DIGITAL STILL CAMERA

USER'S MANUAL

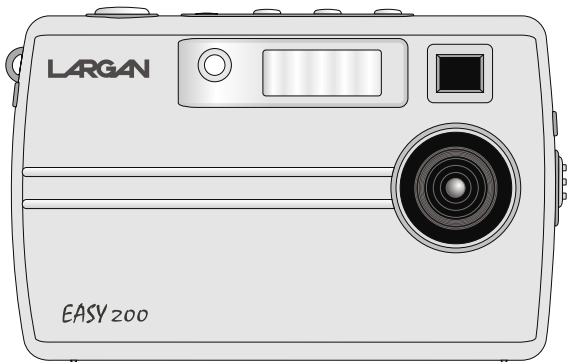

DIGITAL STILL CAMERA

2.0 MEGAPIXEL
2.5X DIGITAL ZOOM

Welcome

Thank you for purchasing this product. We strongly recommend that you read the user's manual before operating the camera. Keep the manual handy for quick reference. You are on your way to experience a digital camera like no other. This easy-to-follow user's manual shows you how to use your new camera like a pro, whether you want to:

- download photos to your computer.
- preview and take images via the television.
- create a mini movie using the live video feature.

Before using the camera, please ensure that you:

- Read and understand the user's manual.
- Check the contents to make sure that all of the components are included.
- Format the internal memory. (Pg. 22)
- Check that your camera is recording the images correctly by taking a number of test shots.
- Please follow the instructions on Pg. 27.
- If your camera is used for a prolonged period, the camera body may become warm. Please be aware of this and take care when operating the camera.

Table of Contents

CHAPTER 1: Components Guide

| | |
|---|---|
| The Camera Kit..... | 1 |
| Index of Controls (Front / Left / Right / Back / Up / Bottom View)..... | 2 |
| On Screen Display (OSD) | 6 |

CHAPTER 2: Getting Started

| | |
|---|----|
| Attaching the Strap..... | 8 |
| Turning the Power On/Off..... | 8 |
| Charging the Battery..... | 9 |
| Installing the Battery..... | 11 |
| Inserting / Removing a Secure Digital Card..... | 12 |
| The Memory Priority..... | 13 |
| Setting the Language (^a b _c)..... | 13 |

CHAPTER 3: Basic Photography





























| | |
|--|----|
| Taking Pictures..... | 14 |
| Adjust the Digital Zoom | |
| Press the Shutter Button | |
| Switching the LCD Monitor Display Information (□)..... | 16 |
| Using the Flash (A ₂ / A ₂ / ) | 17 |
| Using the Self-Timer () | 17 |
| Using the Macro () | 18 |
| Adjusting the Exposure Compensation..... | 18 |

Table of Contents

CHAPTER 4: Advanced Features Photography

| | |
|---|----|
| Capture Mode ( /  / )..... | 19 |
| Scene Mode ( /  /  /  /  / )..... | 20 |
| Delete Mode ( / )..... | 22 |
| Resolution ()..... | 24 |
| Compression Ratio ( /  / )..... | 26 |
| Sharpness / Softness ()..... | 26 |
| Light Metering Mode (AE)..... | 27 |
| Communication Setting ()..... | 28 |
| Beeper On/Off ( / )..... | 29 |
| Monitor Brightness ()..... | 29 |
| Auto Power Off ()..... | 30 |
| Setting the Date and Time ()..... | 30 |
| Anti-Flicker Setting ()..... | 31 |
| Setting the TV System ()..... | 32 |
| Reset Definition ()..... | 32 |

CHAPTER 5: Viewing the Images



| | |
|---|----|
| Switching between Capture and Replay Mode..... | 33 |
| Multi-Image Replay () | 33 |
| Auto Playback | 34 |
| The Zoom in the Replay Mode..... | 34 |
| Erasing the Single Image | 35 |
| Protecting Images () | 35 |
| Playing Back Movies | 36 |

Table of Contents

CHAPTER 6: Capturing / Replaying with a TV Monitor

| | |
|--|----|
| Connecting the Camera with a TV Monitor..... | 37 |
| Capturing the Images with a TV Monitor..... | 37 |
| Replaying the Images with a TV Monitor..... | 38 |

CHAPTER 7: Installing the USB DISK Driver

| | |
|--------------------------|----|
| For Windows 98 only..... | 39 |
|--------------------------|----|

CHAPTER 8: Download Images via USB DISK..... 41

CHAPTER 9: Appendix

| | |
|-----------------------------|----|
| Troubleshooting | 43 |
| Additional Information..... | 46 |
| Where to Get Help | 49 |

1. Components Guide

The Camera Kit

The camera kit includes:

1. The camera
2. Li-ion rechargeable battery
3. Camera strap
4. Mini USB cable
5. User's manual
6. CD
7. Li-ion battery charger
8. Leatherette camera case
9. TV cable

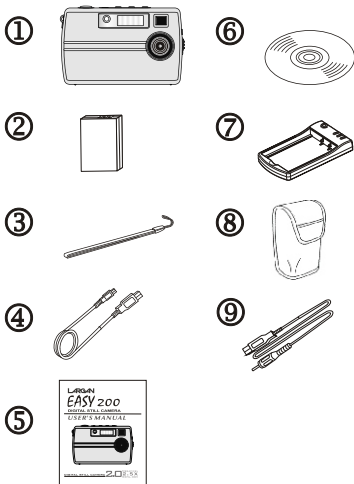

This is not your traditional camera. This is a "digital" camera. A digital camera allows you to take pictures without the use of film. With the camera, going digital is just the beginning. Before going into creating fun projects with the camera, familiarize yourself with the camera's features and functions.

Index of Controls (Front/Left/Right/Back/Up/Bottom View)

Front View

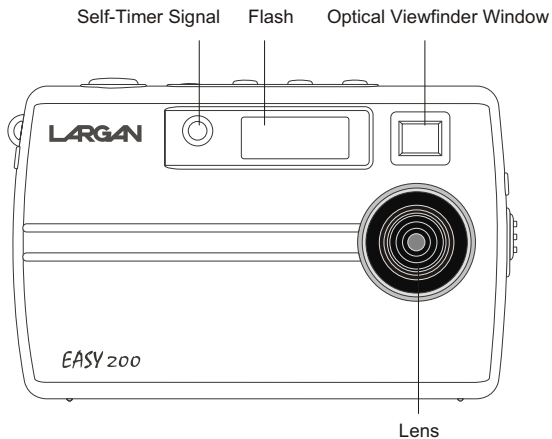

Index of Controls (Front/Left/Right/Back/Up/Bottom View)

Left View

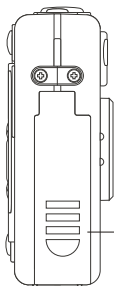

External Memory
Card Slot /
Battery Cover

Right View

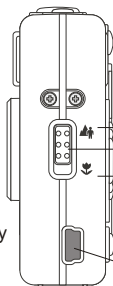

Standard Mode
Macro Switch
Macro Mode

USB Terminal

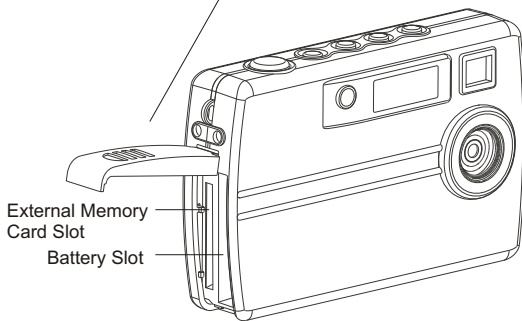

External Memory
Card Slot

Battery Slot

Index of Controls (Front/Left/Right/Back/Up/Bottom View)

Back View

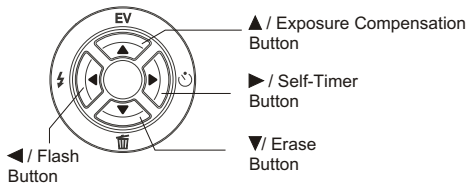
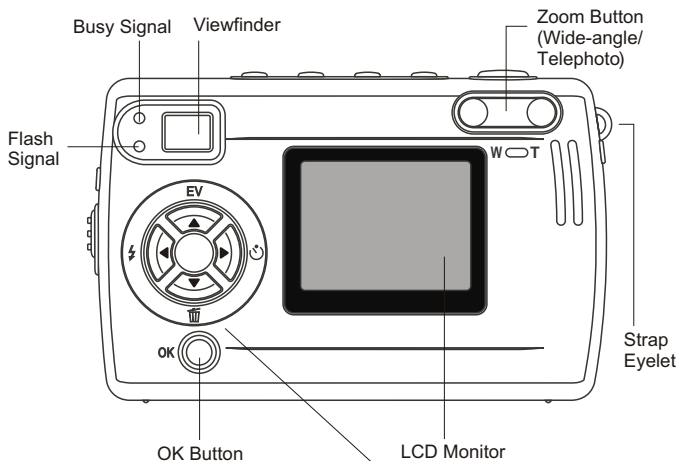

Index of Controls (Front/Left/Right/Back/Up/Bottom View)

Top View

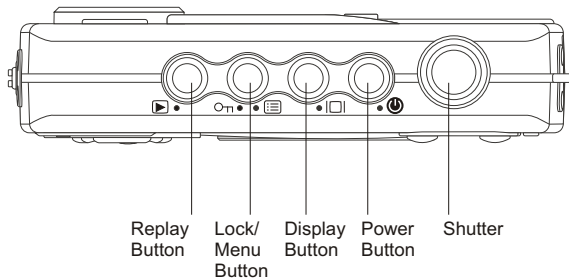

Bottom View

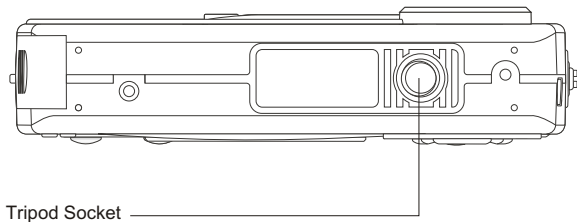

On Screen Display (OSD)

Capture Mode

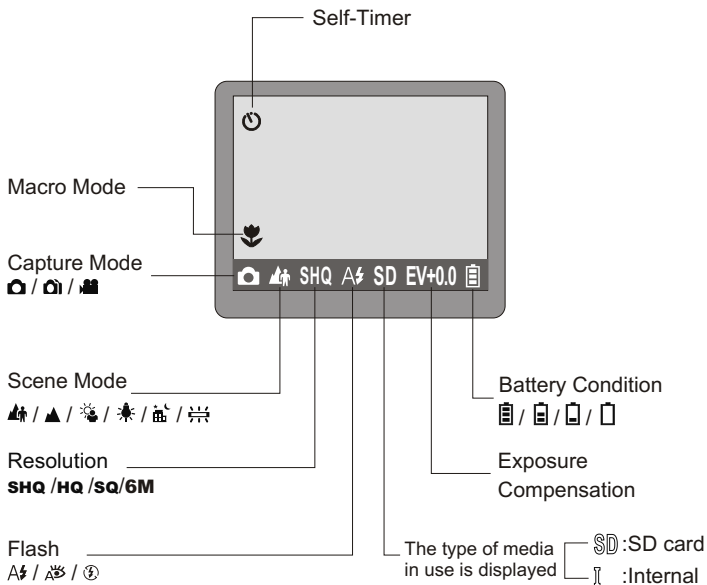

On Screen Display (OSD)

Capture Mode

Press the "▶" button to switch from replay mode to capture mode.

Images Taken

SD-0001/1000

I-0001/1000

— Last Image Taken

— First Image Taken

— SD Card / Internal

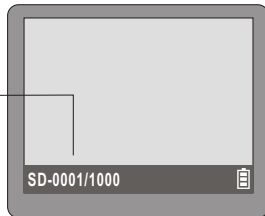

Replay Mode

Press the "▶" button again to switch to replay mode. Use the "▲", "▼", "◀" or "▶" button to select the photo. Press the "OK" button to enlarge the photo.

Images Taken

SD-0001/1000

I-0001/1000

— Last Image Number

— Image Number Selected

— SD Card / Internal

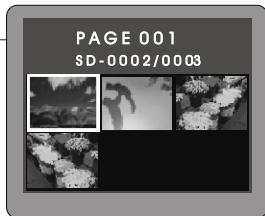

2. Getting Started

Attaching the Strap

Attach the camera strap as shown in the illustration below.

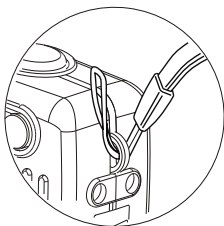

Figure 1

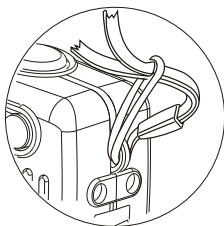
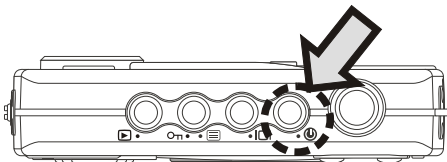

Figure 2

Turning the Power On/Off

Press the "⏻" button to turn the camera on. Hold down the "⏻" button 3 seconds to turn the camera off.



Charging the Battery

Charge the battery before you use it for the first time and when the LCD monitor on the camera indicates, **"CHANGE BATTERY"**.

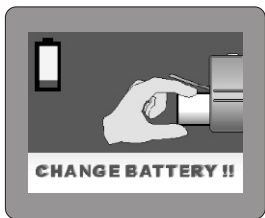

1. Put the battery in the charger

Align the edge of the battery with the line on the charger, then slide the battery in the direction of the arrow. To remove the battery, push the battery forward (against the contact spring) and lift.

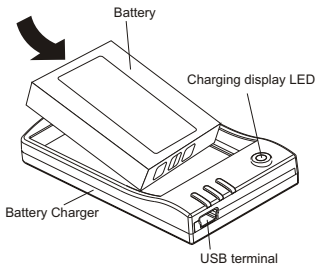

NOTE-----
Your computer must be turned on to charge the battery.

2. Using the USB cable

- 2-1. Attach the USB cable to the USB terminal on the charger. Plug the other end of the USB cable into the USB port on the PC.
- 2-2. To turn the computer on. While the battery is being charged, the chargers display LED will be red; when the battery is fully charged, the light will turn green.

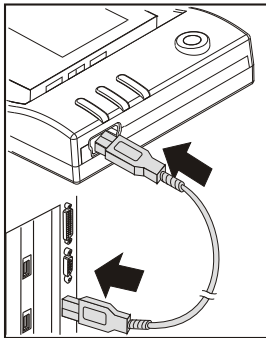

NOTE-----

1. Charger:

Input Voltage: USB 5V

2. Battery:

Voltage: 3.7V

Nominal capacity: 700mAh

Dimensions: 33.1 (W) x 53 (H) x 7.3 (D) mm



Incorrect usage of charger/battery could cause damage to the camera or yourself, other people or equipment. The camera's manufacturer and it's distributors are not liable for any consequential damages arising from inappropriate devices and/or use of such devices.

Installing the Battery

1. Open the external memory card slot/battery cover in the direction of the arrow.
2. Put the battery in.
3. Close the cover.

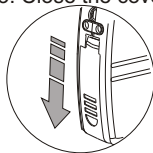

Step1

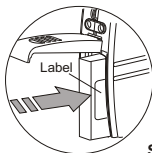

Step2

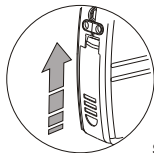

Step3

NOTE

Remove the battery if you are not going to use the camera.
Do not short, disassemble or throw the battery into a fire.

Battery Condition

As the battery is depleted, the indication changes as follows.



Full

Low

Empty

Power is running out, charge the battery.

Inserting / Removing an External Memory Card

1. Turn off the camera.
2. Open the external memory card slot/battery cover.

NOTE

The external memory card is optional, please purchase at www.largan.com or your local retailer.

Works with MMC cards up to 128 MB or SD cards up to 256 MB.

3. Inserting the card

Orient the external memory card correctly and push it into the card slot as far as it will go. It will click into place.

NOTE

Note the orientation of the card. If it is inserted incorrectly, it may become jammed.

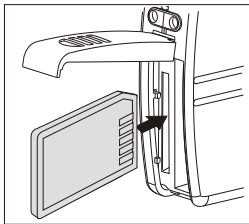

4. Removing the card

- 4-1. Push the card in slightly and allow it to eject back out.
- 4-2. Grasp the card and pull it straight out.

NOTE

Never remove the card while the camera is turned on. It will destroy the image data or damage the card itself.

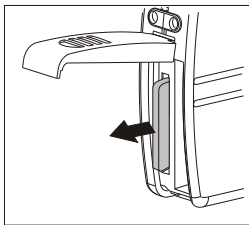



The Memory Priority

You can store image data with an external memory card or the internal memory of the camera. When the external memory card is inserted into the camera, the image data will be recorded to or viewed from the external memory card first. Only if the external memory card is removed from the camera will the image data be recorded to or viewed from the internal memory of the camera.

Setting the Language (a_bc)

You can select from 9 different languages:

Traditional Chinese / English / German / French / Italian / Spanish / Portuguese / Dutch / Polish

1. Press the  button to display the menu.
2. Use the "▲" or "▼" button to select this mode (a_bc).
3. Use the "◀" or "▶" button to select the language.
4. When you have selected the setting, press the  button to exit.

3. Basic Photography

Taking Pictures

1. Press the on/off "Ⓞ" button. The camera will beep.
2. Aim the camera at the subject.

3. Adjust the Digital Zoom

- 3-1. Use the zoom lever to achieve the desired composition.
- 3-2. To zoom in on the subject, press the "T" button. To zoom out, press the "W" button. The zoom bar appears on the LCD monitor when you zoom in or out.

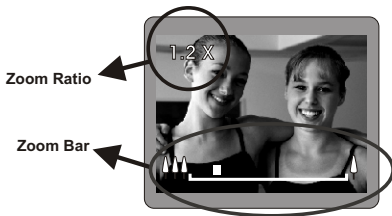

NOTE

-
1. **W** = Wide Angle **T** = Telephoto
 2. The zoom ratio is displayed on the LCD monitor.
-



4. Press the Shutter Button

- 4-1. Press the "shutter" button down fully to take the picture.

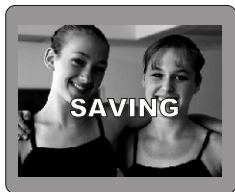
- 4-2. The camera will beep and the data is recorded.



Switching the LCD Monitor Display Information ()

Pressing the "" button switches the LCD monitor display information. In the capture mode, pressing the  button cycles the LCD monitor to the next mode each time the button is pressed.

Detailed Display:

The LCD monitor displays information such as the camera setting, resolution, battery condition.....

Simple Display:

The LCD monitor only displays remaining image capacity.

No Information Display:

The LCD monitor displays no information on it.

Monitor Off:

Turn off the monitor.

NOTE

.....
Digital zoom cannot be used
if the LCD monitor is turned off.
.....

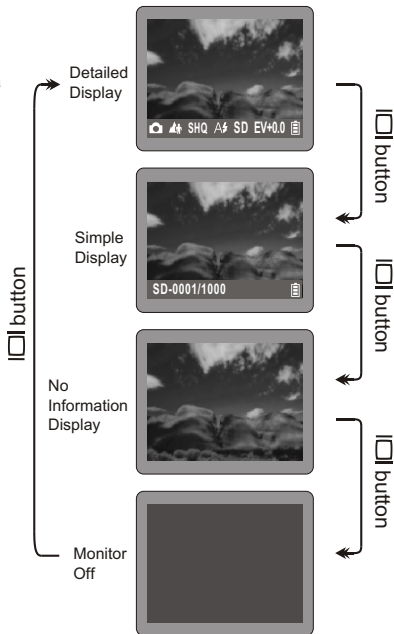

Using the Flash (A⚡ / A👁 / Ⓜ)

The flash mode is used to add extra light to your image. Press the flash "⚡" button to select the flash setting. The flash setting changes (A⚡, A👁, Ⓜ) each time you press the "⚡" button. And the selected flash mode appears on the LCD monitor.

NOTE

A⚡ : Auto Flash A👁 :Auto Red-Eye Reduction with Auto Flash Ⓜ :No Flash



Using the Self-Timer (⌚)

This mode is used to take a picture with a 10 second delay.

1. Press the "⌚" button to select the self-timer setting. The "⌚" icon appears on the LCD monitor.
2. Take the picture by pressing the "shutter" button. You have 10 seconds to capture the photo, indicated by the camera beeping and the self-timer indicator blinking on the front of the camera.



NOTE

Press the "⌚" button again to cancel this mode.

Using the Macro (🌸)

1. The macro mode is used to take a close-up photos up to 8 inches. Slide the macro switch from Standard to Macro mode. The "🌸" icon appears on the LCD monitor.
2. Press the on/off "🔆" button. The camera will beep.

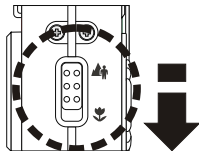

NOTE

.....
In the macro mode, the flash will be turned off.
.....

Adjusting the Exposure Compensation

Adjust the exposure compensation setting to obtain the optimum image brightness (Exposure) when the subject is much brighter or darker than the background.

1. Press the "EV" button to get into the Exposure Value mode. The exposure compensation bar will appear on the LCD monitor.
2. Press the "◀" or "▶" button. The brightness of the subject will be adjusted according to the exposure value. You can see the change on the LCD monitor.
3. Press the "OK" button to exit.

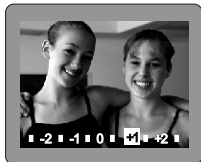

NOTE

.....
The settings can be adjusted in 1/2 increments in the range of -2.5EV~+2.5EV. The higher the value, the greater the exposure (brightness).
.....

4. Advanced Features Photography

Capture Mode (📷 / 📷 / 🎥)

In the capture mode, you can choose from 3 types of shots:

📷 Single Shot / 📷 Continuous Shots / 🎥 Recording













1. Press the "☰" button to display the menu.
2. Use the "▲" or "▼" button to select this mode (📷).
3. Use the "◀" or "▶" button to select 📷 or 📷 or 🎥.
4. Press the "☰" button to confirm setting.
5. The selected mode will appear on the LCD monitor.





| 📷 Single Shot | 📷 Continuous Shots |
|---|---|
| <p>Use this mode to take a single picture.</p> <ol style="list-style-type: none">1. Press the "shutter" button to take a picture. | <p>Use this mode to take continuous snapshots.</p> <ol style="list-style-type: none">1. Press the "shutter" button to take the pictures. <p>*Take up to 3 pictures in super fine resolution at one time.</p> <p>*Take up to 6 pictures in fine resolution at one time.</p> <p>*Take up to 12 pictures in normal resolution at one time.</p> |
| 🎥 Recording | |
| <p>Use this mode to record a short movie.</p> <ol style="list-style-type: none">1. Press the "shutter" button to start recording.2. Press the "shutter" button again to stop recording. <p>*The available shooting time depends on the amount of free space on the external memory card.</p> | |

Scene Mode (/ / / / /)

In the scene mode, you can choose from 6 types of scenes:

 Portrait /  Landscape /  Back Light /  Tungsten /
 Night Landscape /  Fluorescent

1. Press the "" button to display the menu.
2. Use the "" or "" button to select this mode (.
3. Use the "" or "" button to select  or  or  or  or  or .
 When the scene type is selected, press the "" button again to exit the menu.
4. The selected mode will appear on the LCD monitor.

| | |
|---|---|
| <p> Portrait</p> <p>Use this mode for pictures of people.</p> <p>1. Press the "shutter" button to take a picture.</p> <p>NOTE ----- Use this mode for normal, everyday use. -----</p> | <p> Landscape</p> <p>Use this mode for daytime pictures of scenery.</p> <p>1. Press the "shutter" button to take a picture.</p> |
| <p> Back Light</p> <p>Use this mode for pictures in back light.</p> <p>1. Press the "shutter" button to take a picture.</p> | <p> Tungsten</p> <p>Use this mode for pictures in incandescent light.</p> <p>1. Press the "shutter" button to take a picture.</p> |

 **Night Landscape**

Use this mode for pictures taken in the evening or at night.

1. Press the "shutter" button to take a picture.

 **Fluorescent**

Use this mode for pictures in fluorescent light.

1. Press the "shutter" button to take a picture.

Delete Mode (🗑️ / 🗑️)

In the delete mode, no matter what type of media (SD card / Internal memory) you set, you can choose from 2 types of this mode:

🗑️ Delete All / 🗑️ Format

Delete All (External memory card)

1. Make sure the external memory card is in the camera.
2. Press the "☰" button to display the menu.
3. Use the "▲" or "▼" button to select this mode (🗑️).
4. Use the "◀" or "▶" button to select "🗑️" in higher level.
5. Press the "OK" button.
6. Select "Yes" using the "◀" or "▶" button.
7. Press the "OK" button to delete all the images.



NOTE

.....
Locked images cannot be deleted.
.....

Format an external memory card

1. Make sure the external memory card is in the camera.
2. Press the "☰" button to display the menu.
3. Use the "▲" or "▼" button to select this mode (🗑️).
4. Use the "◀" or "▶" button to select "🗑️" in higher level.
5. Press the "OK" button.
6. Select "Yes" using the "◀" or "▶" button.
7. Press the "OK" button to format the card.



Delete All (the internal memory)

1. Make sure the external memory card is out of the camera.
2. Press the "MENU" button to display the menu.
3. Use the "▲" or "▼" button to select this mode (⏏).
4. Use the "◀" or "▶" button to select "⏏" in the lower level.
5. Press the "OK" button.
6. Select "Yes" using the "◀" or "▶" button.
7. Press the "OK" button to delete all the images.

NOTE

Locked images cannot be deleted.



Format the internal memory

1. Make sure the SD card is out of the camera.
2. Press the "MENU" button to display the menu.
3. Use the "▲" or "▼" button to select this mode (⏏).
4. Use the "◀" or "▶" button to select "⏏" in the lower level.
5. Press "OK" button.
6. Select "Yes" using "◀" or "▶" button.
7. Press "OK" button to format.

NOTE

It is important to format the internal memory and all external memory cards prior to using them for the first time.



Resolution (◀▶)

In the resolution mode, you can choose the setting (**SHQ** / **HQ** / **SQ** / **6M**) according to the type of shot you want to take.

NOTE

SHQ = 1600 x 1200 pixels / Super Fine



HQ = 1024 x 768 pixels / Fine

SQ = 640 x 480 pixels / Normal

6M = 2976x2240 pixels / Interpolation

1. Press the "☰" button to display the menu.
2. Use the "▲" or "▼" button to select this mode (◀▶).
3. Use the "◀" or "▶" button to select the quality.
4. When you have selected the setting, press the "☰" button to exit.
5. The selected resolution icon will appear on the LCD monitor.



Selecting the Image Quality

| Resolution Mode | Features | Quality | File Size | Optimal Print Size |
|-----------------|---|---|---|---------------------------------------|
| SHQ | <ol style="list-style-type: none"> 1. The highest quality mode 2. Highest quality prints 3. Larger file sizes 4. Harder to email 5. Factory default setting |  |  | A4 size 11.7" x 8.3" or smaller |
| HQ | <ol style="list-style-type: none"> 1. Smaller file size 2. Save more images to memory 3. Good for editing on a PC or printing | | | Card Size 3.4" x 3.5" |
| SQ | <ol style="list-style-type: none"> 1. Smallest resolution size 2. A standard quality mode 3. The highest number of images can be saved to memory 4. Good for emailing images, viewing them on a PC, or uploading to a website | | | Typically not suitable for prints |
| 6M | <ol style="list-style-type: none"> 1. Images have large file size 2. Suitable for printing over 11.7" x 8.3" | | | Larger than 11.7" x 8.3" |

Note

Intepolation is a way to add pixels that are not really there to make an image print properly at sizes larger than normal. Interpolation softens the image. Use this mode to print images larger than 11.7 " x 8.3". For the best quality images and prints, always use SHQ mode.

Compression Ratio (S / /

In the compression ratio mode, you can choose the quality setting (S /  / ) according to the type of shot you want to take.

NOTE

 = Super Fine

 = Fine

 = Normal

1. Press the "☰" button to display the menu.
2. Use the "▲" or "▼" button to select this mode (S).
3. Use the "◀" or "▶" button to select the quality.
4. When you have selected the setting, press the "☰" button to exit.

Sharpness / Softness ()

Use this setting to emphasize (soften) the outlines of the image.

NOTE

The settings can be adjusted in the range of -3 ~ +3.

-1~-3 = Softness

0 = Normal

+1~+3 = Sharpness

1. Press the "☰" button to display the menu.
2. Use the "▲" or "▼" button to select this mode ()
3. Use the "◀" or "▶" button to select the grade.
4. When you have selected the setting, press the "☰" button to exit.

Light Metering Mode (AE)

Use this mode for scenes where the brightness of the subject and background differ markedly. You can choose from 2 types of this mode.

1. Press the "☰" button to display the menu.
2. Use the "▲" or "▼" button to select this mode (AE).
3. Use the "◀" or "▶" button to select "[]" or "[•]".
4. When you have selected the setting, press the "☰" button to exit.

NOTE

[]/ Center - Average:

Averages the exposure at the center of the image. Use this mode when the subject is backlit or surrounded by bright light.

[•]/Center - Weighted:

Place more weight of the exposure at the center of the image. It is useful for subjects with strongly contrasting light and dark areas.
.....

Communication Setting (M)

The default setting is "S". The camera uses the USB DISK to download the images. When you download the images for the first time, please do this:

1. Press the "M" button to display the menu.
2. Use the "▲" or "▼" button to select this mode (M).
3. Press the "OK" button to start, and "INSERT CABLE" will appear on the LCD monitor. Please see p.40 for more details.

NOTE

If you have Windows 98 operating system on your PC, make sure you have installed the USB disk driver first.



Beeper On/Off (🔊) / (🔇)

In this mode, you can set the beeper on or off.

1. Press the "☰" button to display the menu.
2. Use the "▲" or "▼" button to select this mode (🔊).
3. Use the "◀" or "▶" button to select "🔊" or "🔇".
4. When you have selected the setting, press the "☰" button to exit.

Monitor Brightness (💡)

You can adjust the monitor brightness in the range of 1~4.

NOTE

1 = Monitor- Darker

4 = Monitor- Lightest

1. Press the "☰" button to display the menu.
2. Use the "▲" or "▼" button to select this mode (💡).
3. Use the "◀" or "▶" button to select the grade.
4. When you have selected the setting, press the "☰" button to exit.

Auto Power Off

Use this function when you want to get the maximum possible running time from the battery.

NOTE

The settings can be adjusted in 30 / 45 / 60 / 120 / 180 seconds and turn off.

1. Press the "☰" button to display the menu.
2. Use the "▲" or "▼" button to select this mode .
3. Use the "◀" or "▶" button to select the time.
4. When you have selected the setting, press the "☰" button to exit.

Setting the Date and Time

Choose your setting from these five options:

M1 = MM / DD / YY

M2 = YY / MM / DD

M3 = M / D / Y / H / M

M4 = Y / M / D / H / M

M5 = NO DISPLAY

1. Press the "☰" button to display the menu.
2. Use the "▲" or "▼" button to select this mode .
3. Use the "◀" or "▶" button to select **M1** or **M2** or **M3** or **M4** type.
4. Press the "OK" button to setup.
5. Use the "◀" or "▶" button to select the desired item and then use "▲" or "▼" button to correct the setting.
6. If you do not want the date displayed on photos select **M5**.
7. When you have selected the setting, press the "OK" button to return the menu.

Anti-Flicker Setting

Your camera needs to be set to the frequency of the local power supply to avoid problems when taking pictures under fluorescent lighting. If you do not know which setting is correct for your country, consult your dealer.

EX.:

| | |
|--|------|
| U.S.A., Taiwan, South Korea.... | 60Hz |
| France, Germany, China, Japan, Netherlands, Portugal, Spain, Poland, Italy..... | 50Hz |



1. Press the "☰" button to display the menu.
2. Use the "▲" or "▼" button to select this mode (.
3. Use the "◀" or "▶" button to select "50" or "60" .
4. When you have selected the setting, press the "☰" button to exit.

NOTE

.....
An incorrect flicker setting could result in barred or blurred images.
.....



Setting the TV System ()

In this mode, you can set the TV system in **NTSC** or **PAL**.

1. Press "" button to display the menu.
2. Use the "▲" or "▼" button to select this mode ().
3. Use the "◀" or "▶" button to select "**NTSC**" or "**PAL**" .
4. When you have selected the setting, press the "" button to exit.

Reset Definition ()

You can reset all of the menu and button operation settings to the factory settings.

1. Press the "" button to display the menu.
2. Use the "▲" or "▼" button to select this mode ().
3. Press the "OK" button to reset.
4. When you have selected the setting, press the "" button to exit.

NOTE

Do not use the "Reset Definition" mode to confirm new settings. This mode should only be used to reset the menu to the factory default settings.

.....

5. Viewing the Images

Switching between Capture and Replay Mode

1. Press the "▶" button to switch from capture mode to replay mode.
2. In the replay mode, you can preview and zoom in on the images.

NOTE

When the memory setting is in the external memory card mode (an MMC cards or SD card is in the camera), you can only view or download the images stored on the external memory card. If you want to view or download the images in the internal memory of the camera, please remove the external memory card first (p. 12).

Multi-Image Replay (▶)

1. Select the image by pressing the "▲", "▼", "◀" and "▶" button to move to the desired image.
2. You can enlarge the desired image by pressing the "OK" button. Select the other enlarged images by pressing the "◀" and "▶" button.



NOTE

Press the "OK" button to switch between the enlarged image and multi-image replay mode.

Auto Playback

The function automatically plays all the images stored in the camera.

1. In single image replay, hold on the "◀" or "▶" button for 2 seconds to preview the images automatically (slide show).
2. Adjust the playback speed by pressing the "▲" or "▼" button.
3. Press the "◀" or "▶" button to pause.
4. Press the "OK" button to stop this function or press the "⏮" button to go back to the capture mode.

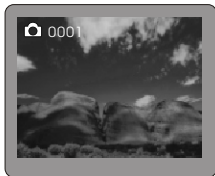

NOTE

To playback the images slowly, press the "▼" button.

.....

The Zoom in the Replay Mode

1. In single image replay, the displayed image can be zoomed in and out by using the "W" and the "T" button.
2. Select the desired photo and press the "OK" button to switch to the single image replay. Press the "T" button to magnify the image. Press the "▲", "▼", "◀" and "▶" button to move around the magnified image.
3. To return to the normal mode (zoom ratio=1X), press the "W" button.

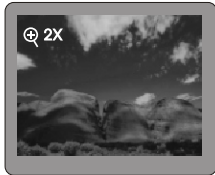

NOTE

The zoom ratio is displayed on the LCD monitor.

.....

Erasing the Single Image

1. In single image replay mode, select the image you wish to erase using the "◀" or "▶" button.
2. Press the "🗑️" button.
3. Select "Yes" using the "◀" or "▶" button.
4. Press the "OK" button to erase the image.

Protecting Images (🔒)

In single image replay mode, select an image you want to protect using the "◀" or "▶" button and press the "🔒" button. The image has been locked and cannot be deleted. Press the "🔒" button again to unlock the image. .

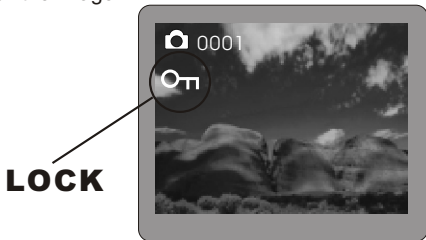

Playing Back Movies

1. In single image replay, select the movie you wish to play using the "◀" or "▶" button.
2. Pressing the "W" button will play the movie images. You can press the "W" button again to pause the movie.
3. If you want to stop during playback, press the "T" button.
4. Press the "◀" or "▶" button to continue view the other image.
5. You can press the "📷" button to go back to the capture mode.

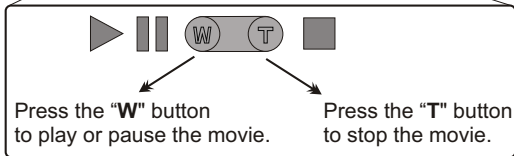
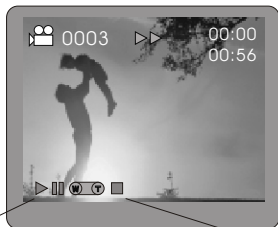

NOTE

📷 is displayed on the movie image.

6. Capturing / Replaying with a TV Monitor

Connecting the Camera with a TV Monitor

1. Turn off the camera and TV.
2. Attach the TV cable to the USB terminal on the camera.
3. Plug the other end of the TV cable to the video in jack on the TV.

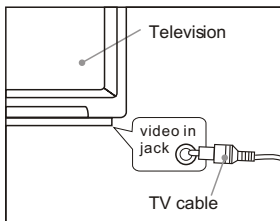
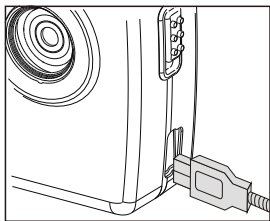

Capturing the Images with a TV Monitor

1. Make sure you have connected the camera to the TV.
2. Turn on the TV and switch it to video mode.
3. Turn on the camera and select the type of capturing (p. 19).
4. Begin taking pictures or recording video clips.

NOTE

.....
If an incorrect TV system is set, the output image will not display properly. Please set the TV system correctly (p. 31).
.....

Replaying the Images with a TV Monitor

1. Make sure you have connected the camera to the TV.
2. Turn on the TV and switch it to video mode.
3. Switch the camera to replay mode (p. 32).
4. In the replay mode, you can preview and zoom in on the images.

NOTE

If an incorrect TV system is set, the output image will not display properly. Please set the TV system correctly (p. 31).

7. Installing the USB DISK Driver

For Windows 98 only

If you have Windows 98 operating system on your PC, please place the CD-ROM into the appropriate drive, then install the USB DISK driver (msd98_setup.exe) to your computer. If your operating system is Windows 2000/ME/XP, you do not need to install any driver.

1. Click "**Install USB disk driver**" on the autorun screen.



2. Click "**Next**" on the Welcome screen.



3. The files will begin to copy to your computer.

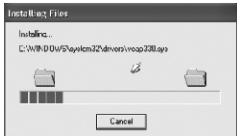

4. Click "**Finish**" to end the setup.

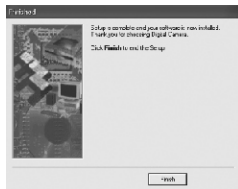

5. In order for the driver to take effect, you should click "**OK**" to restart your computer now.

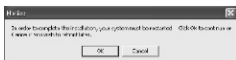

8. Download Images via USB DISK

1. Switch the camera to the **Communication Setting** mode and press the "OK" button. The LCD monitor will show "**INSERT CABLE**" (p. 27).

NOTE

Make sure you have installed the USB disk driver first, if you have Windows 98 operating system on your PC.

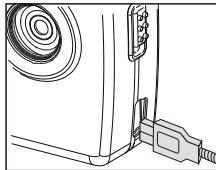

2. Attach the USB cable to the USB terminal on the camera.

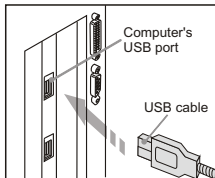

3. Plug the other end of the USB cable to the USB port on the PC.

4. After a moment, Windows will find new hardware, and install the driver automatically. You will find the images as follows:

My Computer / Removable Disk /
DCIM / 100IMAGE

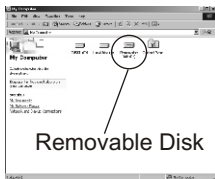

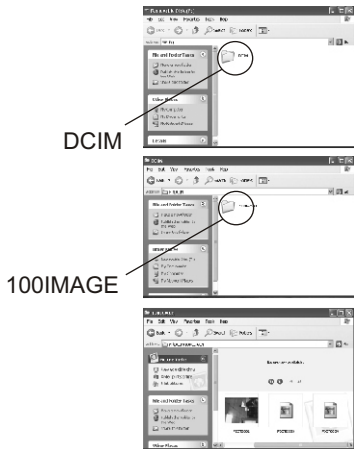

NOTE

When the memory setting is in the external memory card mode (an MMC card or SD card is in the camera), you can only view or download the images stored on the external memory card. If you want to view or download the images in the internal memory of the camera, please remove the external memory card first (p. 12).

.....

9. Appendix

Troubleshooting

| | Symptom | Check this | Remedy |
|------------------------|--|--|--|
| Power supply | Power will not turn on | Battery level too low | Charge the battery |
| | Power turns off right after turning on | Battery level too low | Charge the battery |
| Taking pictures | Cannot take a picture when pressing the shutter button | Power supply not on | Turn power on |
| | | No space on the external memory card | Delete unwanted files or insert a new card |
| | | The camera is not set to capture mode | Set to capture mode |
| | | End of external memory card service life | Insert a new card |

| | Symptom | Check this | Remedy |
|-----------------|--|--|---|
| Taking pictures | Does not Flash | In the "🌸" mode | Switch to "🌳" mode |
| | | Flash is set to "🔇" mode | Change flash mode to "A" or "AB". |
| | | Capture mode is set to "📷", "👤" mode | Switch capture mode to "📷" mode |
| | | Battery is exhausted | Charge the battery |
| | Image appears dark | Distance too great, the flash did not reach the subject | Move closer to subject |
| Play back | Cannot playback image or playback screen will not appear | Mode is not set to "▶" mode | Set to "▶" mode |
| | | No image data or the data is erased | Take photos |
| | | The external memory card is not inserted or does not contain any files | Take photos |
| | | The external memory card is not formatted with this camera | Format the external memory card with this camera (p.22) |

| | Symptom | Check this | Remedy |
|------------------|-------------------------|--------------------------------|--------------------------|
| Play back | Cannot delete the image | Image is protected (locked) | Unlock this image (p.34) |
| Other | No image on TV screen | Incorrect video system setting | See p.31 |

Additional Information

Technical Specifications

Sensor Resolution

1600 x 1200 CMOS sensor with 2.0M pixels

Image Resolution

Still Mode :

1600 x 1200; 1024 x 768; 640 x 480 pixels

2976 x 2240 (Interpolation) pixels

Video Clip: 320 x 240 pixels

Lens

f=8.79 mm (~22 mm) (2.5X Digital Zoom)

Focus Range

48 inches (1.22m) to infinity

Focus Range-Macro Mode

8 inches (0.2m)(macro mode)

Shutter

Electronic shutter

Strobe / Continuous Shots

Yes

Video-Out

Live / Still (Preview)

Interface

Mini USB

LCD Display

TFT LCD (1.6")

Protocol

Mass storage

Technical Specifications

Self Timer

10 seconds

Image Type

JPEG

Image Capacity

SD card / MMC card / Internal 16 MB flash memory

Power Source

USB 5V / Li-ion rechargeable battery (3.7V)

Power Saving

Automatically power off after 30 / 45 / 60 / 120 / 180 seconds

Dimensions

3.54"(W) x 2.24"(H) x 0.7"(D) ;

90 x 57 x 18 mm

Weight

2.6 oz. (76g) without battery & external memory card

System Requirements for PC

1. Windows 98 / ME / 2000 / XP
2. A Pentium, Pentium II or higher PC, or compatible computer with MMX
3. A hard disk with at least 200 MB space available to run the program
4. At least 64 MB of RAM (128 MB recommended)
5. Built-in USB port

System Requirements for MAC

1. OS 9.1 or above
2. USB connector (1.1 compliant)

Maintenance and Storage

- Stop operating the camera immediately if it emits smoke or noxious fumes. Immediately turn the camera's power off and remove the camera's battery. Continued use of the product may result in fire or electrical shock.
- Do not dismantle, modify or repair the camera yourself. Fire and/or electrical shock may occur as a result.
- Do not allow the camera to come into contact with, or become immersed in, water or other liquids. The camera has not been waterproofed. If the exterior comes into contact with liquids or salt air, wipe it dry with a soft, absorbent cloth.
- Do not drop or insert metal objects or combustible items inside the camera. Fire and/or electrical shock may occur as a result.
- Do not directly look at the sun through the viewfinder or use the flash near eyes. Eye injury may occur as a result.
- Do not use or store this camera in environments of direct sunlight, high humidity and dusty places, next to air conditioner, electric heater or other heat sources, in a closed car,.....etc.
- Do not use organic solvents, such as alcohol, to clean the camera. If the lens or viewfinder are dirty, use a lens brush or soft cloth. Never use your fingers.
- To prevent electrical shock, do not attempt to disassemble or repair the camera. Water may cause fire or electric shock, store in a dry place.
- Usage environment / temperature: 0 to 40 degrees celsius
Usage environment / relative humidity: 45% ~80%

Where to Get Help

Help with your camera is available from several resources:

Online Services

Contact Largan Digital at www.largan.com to access FAQs, the latest drivers and camera instructions. Customer service and toll free numbers are also available online.

Customer Support

If you have any questions about the camera or connections to your computer, you should:

Email us at support@largan.com

Web: www.largan.com

Phone: 602-944-6116 Fax: 602-944-6226

Toll Free Support - 1-877-4PIXELS or 1-877-474-9357

Toll Free Sales - 1-877-4LARGAN or 1-877-452-7426

Your LARGAN camera is backed by worldwide unlimited service and support.

US Office

Largan, Inc.

2432 W. Peoria Avenue

Bldg. 9, Suite 1165-1166

Phoenix, AZ 85029

Sales: 1-877-4LARGAN

Support: 1-877-4PIXELS

Fax: 1-602-944-6226

Email: support@largan.com

sales@largan.com

Web: www.largan.com

Head Office

Largan Digital Co., Ltd.

22F, No.123, Sec. 3,

Taichung Harbor Road,

Taichung City, Taiwan

Tel: 886-4-23584455

Fax: 886-4-23584465

Email: digital@largan.com.tw

Web: www.largan.com.tw

