

KTM

ERSATZTEILKATALOG | 199 SPARE PARTS MANUAL



FAHRGESTELL CHASSIS

ART. NR. 3.204.66
3.99

400/620 SUPER COMPETITION

Die **KTM Sportmotorcycle AG** behält sich das Recht vor, Ausrüstung, technische Angaben, Farben, Materialien, Dienstleistungsangebote, Serviceleistungen und ähnliche Dinge entsprechend den örtlichen Bedingungen ohne Ankündigung und ohne Angabe von Gründen zu ändern, bzw. ersatzlos zu streichen. Es ist zulässig die Fertigung eines bestimmten Modells ohne Ankündigung einzustellen. Im Falle solcher Änderungen erkundigen Sie sich bitte bei Ihrem örtlichen KTM Händler. Für Druckfehler übernehmen wir keine Haftung.

KTM Sportmotorcycle AG reserves the right to modify any equipment, technical specifications, colors, materials, services offered and rendered, and the like so as to adapt them to local conditions without previous announcement and without giving reasons, or to cancel any of the above items without substituting them with others. It shall be acceptable to stop manufacturing a certain model without previous announcement. In the event of such modifications, please ask your local KTM dealer for information.
We shall not be held liable for any printing errors.



INHALTSVERZEICHNIS

INDEX

TELEGABEL WP USD43 FRONT FORK WP USD43

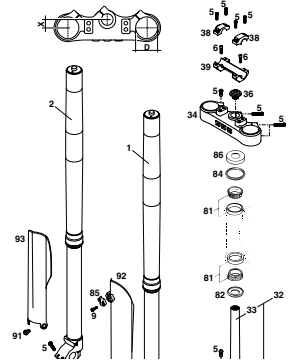

SEITE
Page
4

GABELBEINE WP USD43 FORK LEGS WP USD43

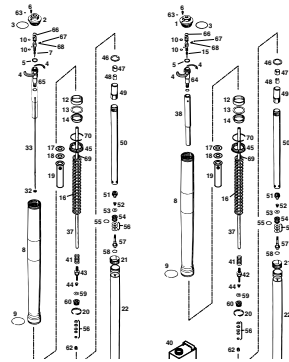

SEITE
Page
5

LENKER, ARMATUREN HANDLEBAR, CONTROLS

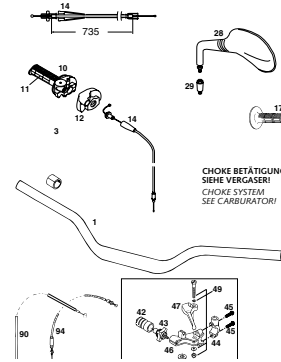

SEITE
Page
7

HANDBREMSZYLINDER HAND BRAKE CYLINDER

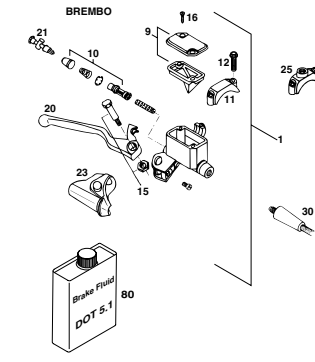

SEITE
Page
8

RAHMEN, AUSLEGER FRAME, SUB FRAME

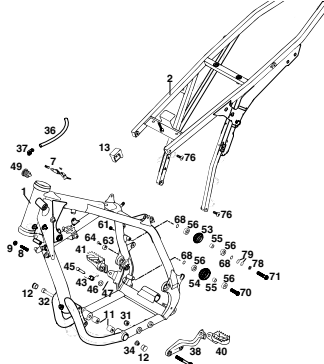

SEITE
Page
9

MITTELSTÄNDER CENTER STAND

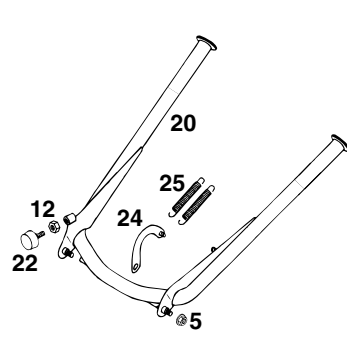

SEITE
Page
11

SCHWINGARM, KETTENSCHUTZ SWINGARM, CHAIN GUARD

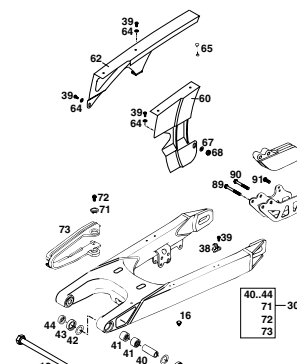

SEITE
Page
12

PRO LEVER ANLENKUNG .PRO LEVER SYSTEM

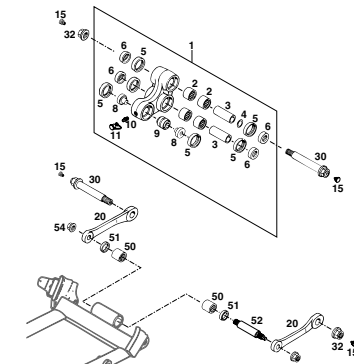

SEITE
Page
13

FUSSBREMSBETÄTIGUNG REAR BRAKE CONTROL

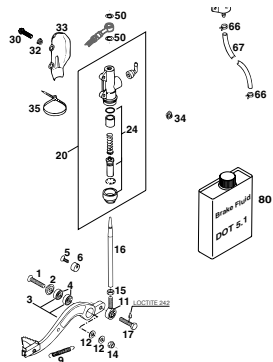

SEITE
Page
14

FEDERBEIN WP SHOCK ABSORBER WP

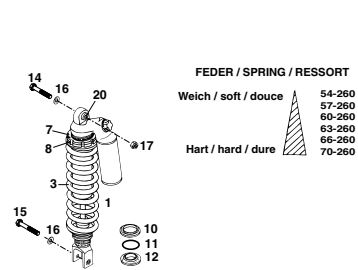

SEITE
Page
15

KRÜMMER, VORSCHALLDÄMPFER PIPES, PRE SILENCER

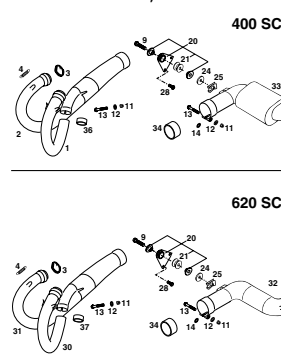

SEITE
Page
16

ENDDÄMPFER SILENCER

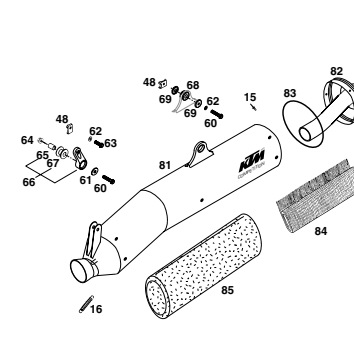

SEITE
Page
17



INHALTSVERZEICHNIS

INDEX

LUFTFILTERKASTEN AIR FILTER BOX

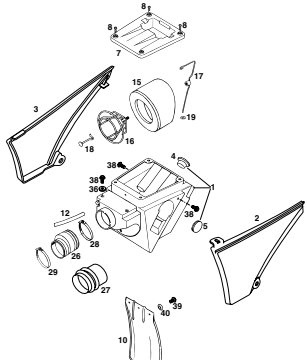

SEITE
Page
18

TANK, SITZBANK, VERKLEIDUNG TANK, SEAT, COVER

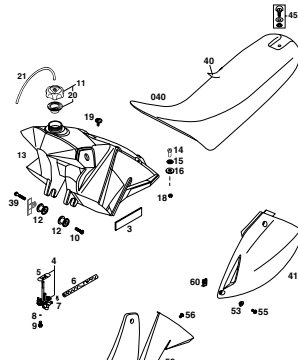

SEITE
Page
19

MASKE, KOTFLÜGEL MASK, FENDERS

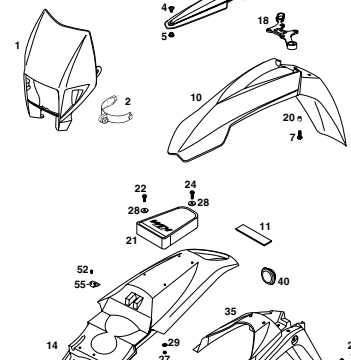

SEITE
Page
20

DEKOR DECAL

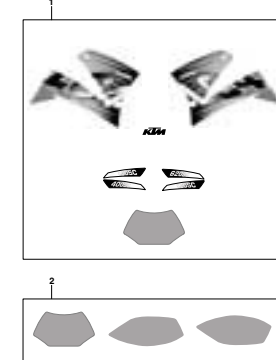

SEITE
Page
21

VORDERRAD FRONT WHEEL

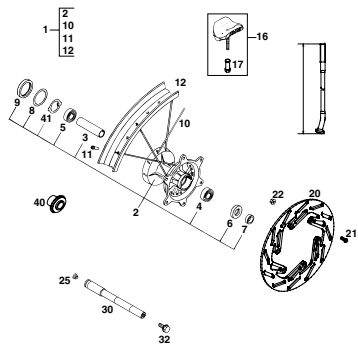

SEITE
Page
22

BREMSZANGE VORNE BRAKE CALIPER FRONT

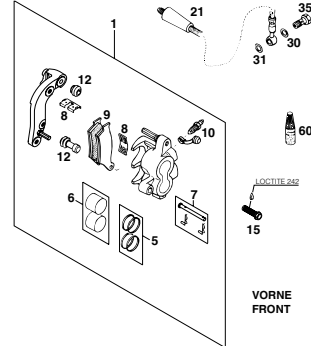

SEITE
Page
23

HINTERRAD REAR WHEEL

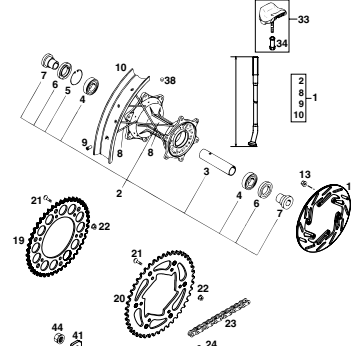

SEITE
Page
24

BREMSZANGE HINTEN BRAKE CALIPER REAR

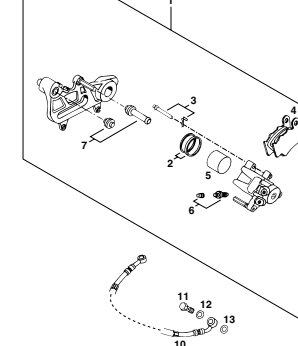

SEITE
Page
25

SCHEINWERFER HEAD LIGHT

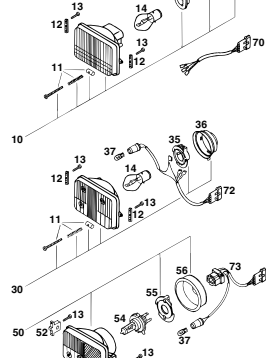

SEITE
Page
26

BLINKER, RÜCKLICHT FLASHER, REAR LIGHT

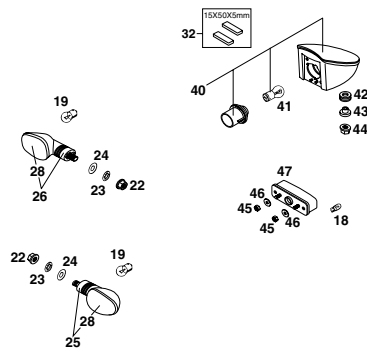

SEITE
Page
27

TACHOANLAGE SPEEDOMETER

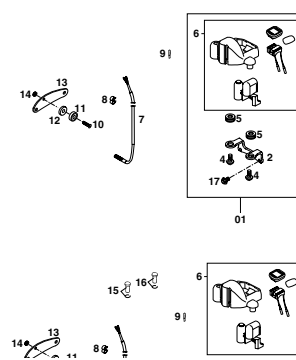

SEITE
Page
28

TACHOANLAGE AUSTRALIEN SPEEDOMETER AUSTRALIA

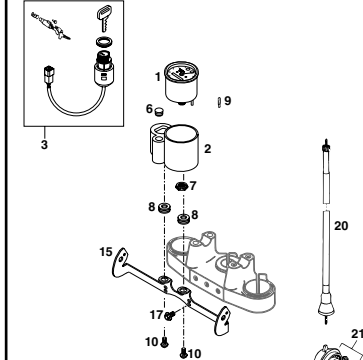

SEITE
Page
29

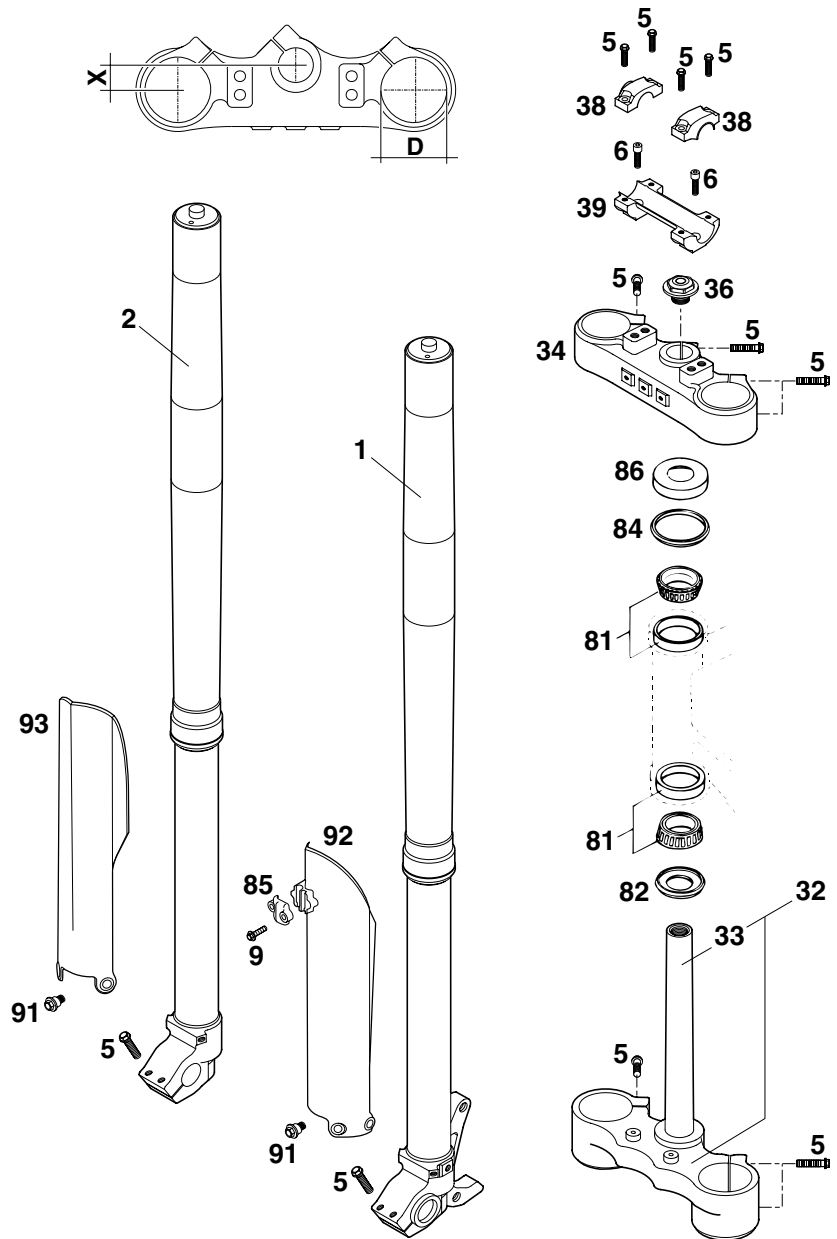

FIG	TEILNR/PARTNR	BEZEICHNUNG	DESCRIPTION	QTY
1*	0518 T781LS	GABELBEIN LI. WP 400/620SC '99	FORK LEG L/S WP 400/620 SC '99	1
2*	0518 T781RS	GABELBEIN RE. WP 400/620 SC'99	FORK LEG R/S WP 400/620 SC '99	1
5	0015 080303	SK.BUNDSCHRAUBE M 8X30 SW=10	HH COLLAR SCREW M 8X30 WS=10	17
6	0912 100258	ISK.SCHRAUBE DIN6912-M10X25	AH SCREW DIN6912-M10X25	2
9	0017 060203	SONDERSCHRAUBE T60 M 6X20	SPECIAL SCREW T60 M 6X20	2
32*	590.01.132.020	GABELBR.UNT.KPL.X=20MM/D=57MM	BOT.TRIPLE CLAMP X=20MM/D=57MM	1
33	501.01.033.100	GABELSCHAFTTROHR L=244 '91	FORK TUBE L=244 '91	1
34*	590.01.034.020	GABELBRÜCKE OBEN X=20MM/D=54MM	TOP TRIPLE CLAMP X=20MM/D=54MM	1
36*	503.01.036.000	STEUERKOPFSCHR. M20X1,5 SW=27	STEER.HEAD SCREW M20X1,5 SW=27	1
38*	590.01.038.100	LENKERKLEMMBRÜCKE 28MM SC'99	HANDLEBAR CLAMP 28MM SC'99	2
39*	590.01.039.100	LENKERAUFNAHME 28MM SC'99	HANDLEBAR SUPPORT 28MM SC'99	1
81	542.01.081.000	KEGELROLLENLAGER STEUERKOPF	TAPERED ROLLER BEARING	2
82	546.01.084.100	O-RINGTRÄGER M. DICHTLIPPE '91	O-RING SUPPORT W. SEALING LIP	1
84	546.01.184.000	STEUERKOPFABDICHTUNG OBEN	STEERING HEAD GASKET TOP	1
85*	590.01.085.000	KLEMME F.BREMSSCHLAUCH SC '99	CLAMP F. BRAKE HOSE SC '99	1
86	542.01.086.000	SCHUTZRING	STEERING HEAD COVER	1
91*	590.01.092.050	SONDERSCHRAUBE M6X12,5 SW=8	SPECIAL SCREW M6X12,5 SW=8	6
92*	590.01.092.000	GABELSCHUTZ LINKS SILBER SC'99	FORK PROTEC. L/S SILVER SC '99	1
93*	590.01.093.000	GABELSCHUTZ RE. SILBER SC '99	FORK PROTEC. R/S SILVER SC '99	1

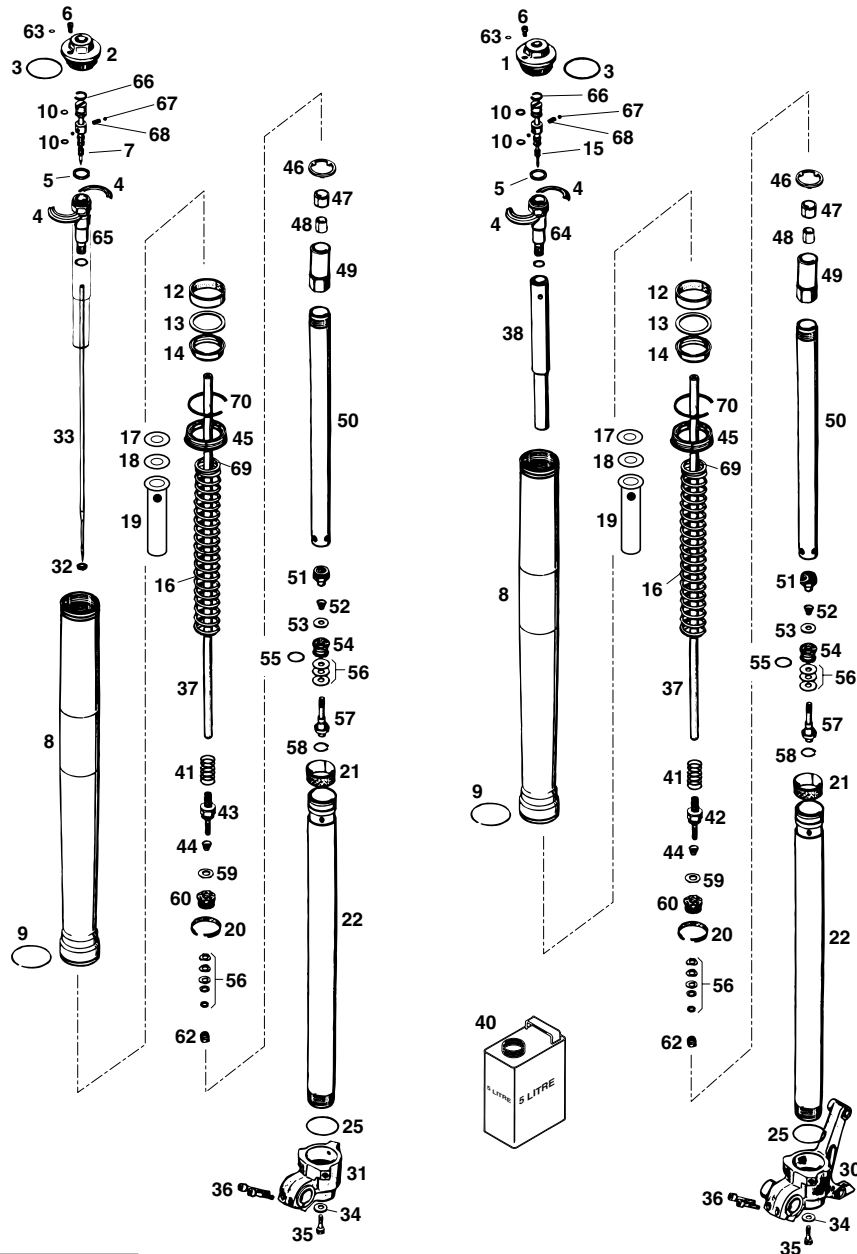

FIG	TEILNR/PARTNR	BEZEICHNUNG	DESCRIPTION	QTY
1*	4054.1269	VERSCHLUSSCHRAUBE M49X1,5 COMP	SCREW CAP M49X1,5 COMP	1
2*	4054.1273	VERSCHLUSSKAPPE M49X1,5 ZUGST.	SCREW CAP M49X1,5 REBOUND	1
3*	4054.0026	O-RING NBR 43X3	O-RING NBR 43X3	2
4*	4054.0470	HALBMOND KEIL D=47MM	SPRINGRETAINER D=47MM	4
5*	4054.0492	GUMMIRING 14,1 X 22 X 4	RUBBER RING 14,1 X 22 X 4	2
6*	4054.1270	LUFT EINSTELLSCHRAUBE	AIR ADJUSTING SCREW	2
7*	4054.1246	EINSTELLSCHRAUBE ZUGSTUFE	TAP ADJ. REBOUND	1
8*	4357.0091	AUSSENROHR L=577MM D=54/57MM	OUTER TUBE L=577MM D=54/57MM	2
9*	4357.0099	DRAHTSPRENGRING D=53MM	GUIDING RING D=53MM	2
10*	4054.1257	O-RING NBR 4X2	O-RING NBR 4X2	4
12*	4357.0019	STAUBMANSCHETTE 47 X 43 X 20	DUST BUSH 47 X 43 X 20	2
13*	4357.0092	TRÄGERRING 45 X 52,5 X 1,5	SUPPORT RING 45 X 52,5 X 1,5	2
14*	4357.0009	ÖLDICHRING 43 X 52,5 X 10,5	OIL SEAL RING 43 X 52,5 X 10,5	2
15*	5060.0083	EINSTELLSCHRAUBE DRUCKSTUFE	TAP ADJ. COMPRESSION	1
16*	9601.00455	FEDER 3,8 N/MM SET D=4,75MM	SPRING 3,8 N/MM SET D=4,75MM	X
16*	9601.00465	FEDER 4,0 N/MM SET D=4,75MM	SPRING 4,0 N/MM SET D=4,75MM	X
16*	9601.00475	FEDER 4,2 N/MM SET D=4,9MM	SPRING 4,2 N/MM SET D=4,9MM	1
16*	9601.00505	FEDER 4,4 N/MM SET D=4,9MM	SPRING 4,4 N/MM SET D=4,9MM	X
16*	9601.00485	FEDER 4,6 N/MM SET D=5,0MM	SPRING 4,6 N/MM SET D=5,0MM	X
16*	9601.00495	FEDER 4,8 N/MM SET D=5,0MM	SPRING 4,8 N/MM SET D=5,0MM	X
17*	4054.0359	VORSPANNBÜCHSE L=2,5MM	PRELOAD SPACER L=2,5MM	2
18*	4054.0040	VORSPANNBÜCHSE L=5MM	PRELOAD SPACER L=5MM	2
19*	4357.0121	FEDER FÜHRUNG TA	SPRING GUIDE TA	2
20*	4054.0851	KOLBENRING 5 X 1 X 62	PISTON RING 5 X 1 X 62	2
21*	4357.0020	STAUBMANSCHETTE 43,8 X 43 X 20	DUST BUSH 43,8 X 43 X 20	2
22*	4357.0089	GABELHOLM D=43MM L=600MM	INNER TUBE D=43MM L=600MM	2
25*	4357.0023	O-RING NBR 41X2	O-RING NBR 41X2	2
30*	4357.0087	GABELFAUST LI. USD43 260MM '99	AXLE CLAMP L/S USD43 260MM '99	1
31*	4357.0086	GABELFAUST RECHTS USD43 M8 '99	AXLE CLAMP R/S USD43 M8 '99	1
32*	4054.1267	O-RING NBR 3X1	O-RING NBR 3X1	1
33*	4054.1374	NADEL ZUGSTUFE D=4MM L=542MM	REBOUND NEEDLE D=4MM L=542MM	1
34*	4681.0360	KUPFERSCHEIBE 8X12X1,5	WASHER COPPER 8X12X1,5	2
35*	5060.0130	SK-BUNDSCHRAUBE M8X20 SW=13	HH-COLLAR SCREW M8X20 WS=13	2
36*	5060.0061	SK BUNDSCHRAUBE M 8X30	HH COLLAR SCREW M 8X30	4
37*	4054.1373	KOLBENSTANGE M9X1 L=528MM	PISTON ROD M9X1 L=528MM	2
38*	4054.13765	HYDR.STOP L=222,5MM KPL. COMP.	HYDR.STOP L222,5MM KPL. COMP.	1
40*	4054.0882	GABELÖL REZ 71 SAE 5	FORKOIL REZ 71 SAE 5	1
41*	4054.1346	FEDER ZUGSTUFE C=60N/MM	REBOUND SPRING C=60N/MM	2

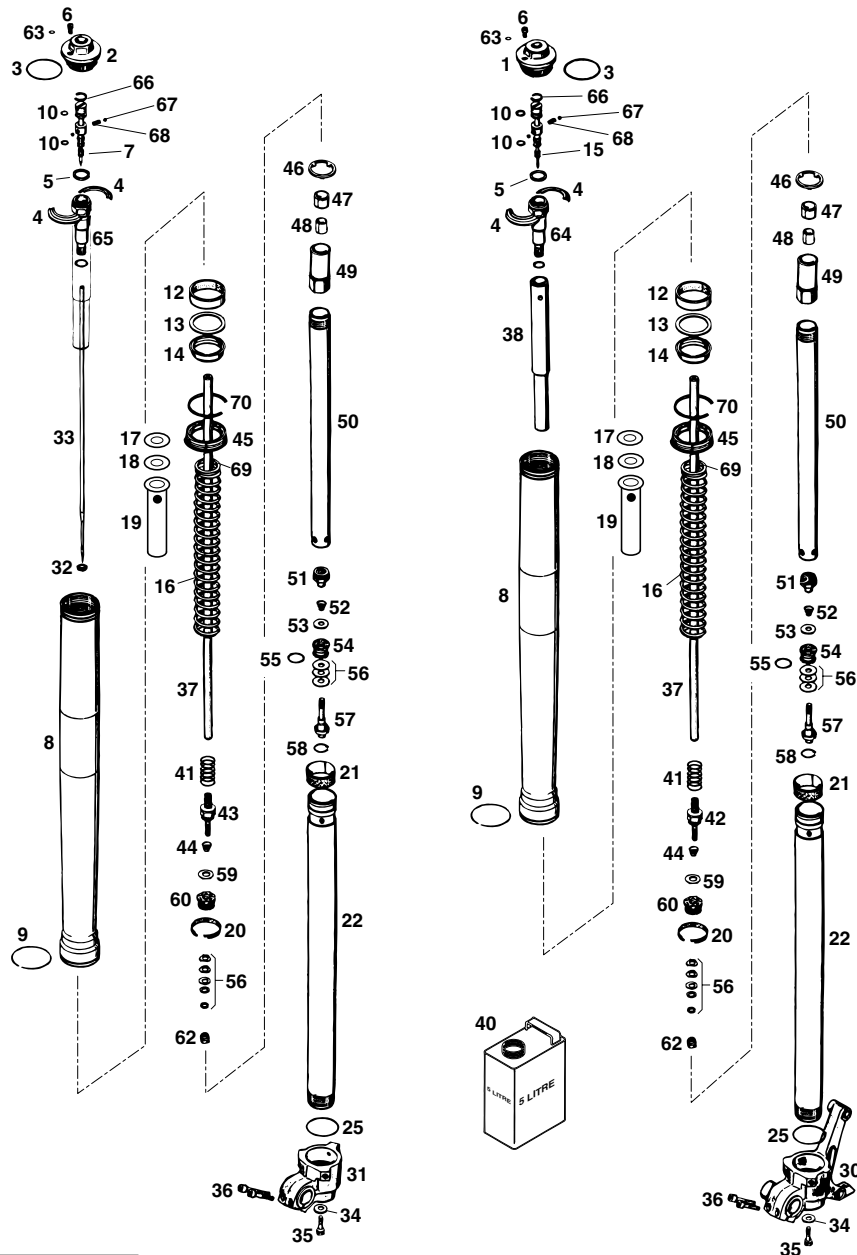
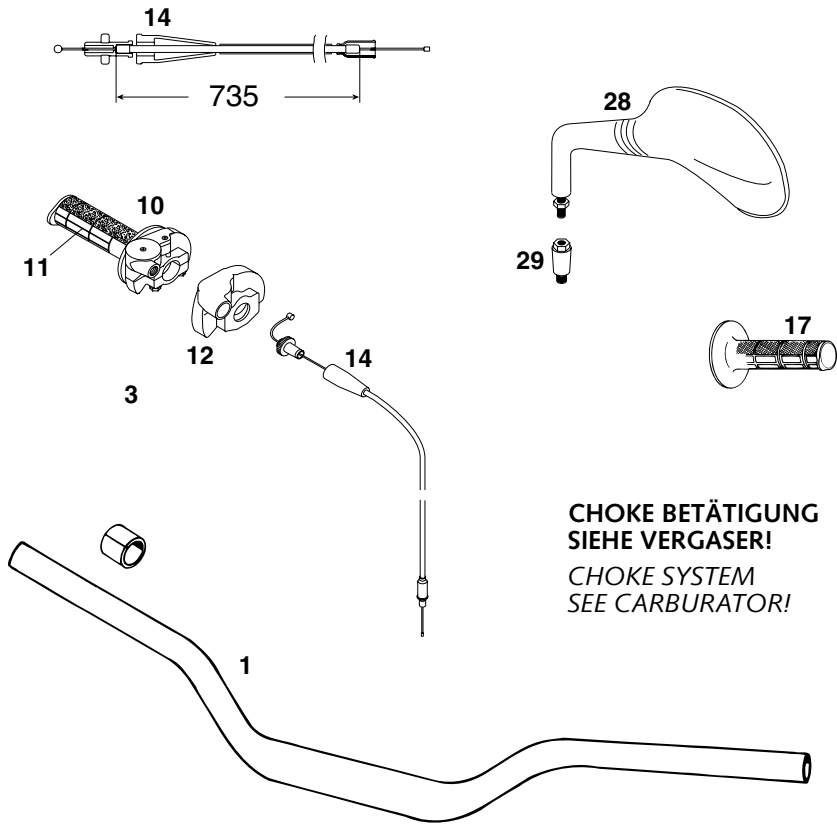

FIG	TEILNR/PARTNR	BEZEICHNUNG	DESCRIPTION	QTY
42*	4054.1245	KOLBENSTANGE COMPRESSION	PISTON ROD TAP COMPRESSION	1
43*	4054.1244	KOLBENSTANGE ZUGSTUFE	PISTON ROD TAP REBOUND	1
44*	4054.1278	EINSTELLFEDER VENTIL D=0,5MM	SPRING CHECK VALVE D=0,5MM	2
45*	4357.0094	STAUBKAPPE D=43MM	DUST STRIPPER D=43MM	2
46*	4054.0629	FEDER HALTER 22,1X35,6X2	SPRINGRETAINER 22,1X35,6X2	2
47*	4054.0487	GUMMIMANSCHETTE	BUMPRUBBER	2
48*	4054.0434	BÜCHSE 12X14X8	DU BUSH 12X14X8	2
49*	4054.1378	SCHRAUBBÜCHSE M24X0,8X56	SCREW SLEEVE M24X0,8X56	2
50*	4054.1236	ROHR 24X1,5X385	TUBE 24X1,5X385	2
51*	4054.1241	EINSTELLMUTTER VENTIL M6X0,5	CHECK VALVE NUT M6X0,5	2
52*	4054.1278	EINSTELLFEDER VENTIL D=0,5MM	SPRING CHECK VALVE D=0,5MM	2
53*	4054.0477	SCHEIBE 8X18X0,4	SHIM 8X18X0,4	2
54*	4054.0445	KOLBEN DRUCKSTUFE MA	PISTON COMPRESSION MA	2
55*	4054.0437	O-RING NBR 15,6X1,78	O-RING NBR 15,6X1,78	2
56*	4054.0411	SCHEIBE 6X18X0,2	SHIM 6X18X0,2	X
56*	4054.0449	SCHEIBE 6X9X0,3	SHIM 6X9X0,3	X
56*	4054.0404	SCHEIBE 6X12X0,15	SHIM 6X12X0,15	X
56*	4054.0401	SCHEIBE 6X14X0,1	SHIM 6X14X0,1	X
56*	4054.0402	SCHEIBE 6X16X0,1	SHIM 6X16X0,1	X
56*	4054.0403	SCHEIBE 6X18X0,1	SHIM 6X18X0,1	X
56*	4054.1383	SCHEIBE 6X11X0,1	SHIM 6X11X0,1	X
56*	4054.0774	SCHEIBE 6X18X0,1	SHIM 6X18X0,1	X
56*	4054.0409	SCHEIBE 6X14X0,2	SHIM 6X14X0,2	X
57*	4054.1242	EINSTELNADDEL COMPRESSION	TAP COMPRESSION	2
58*	4054.1256	SPRENGRING 21X1,6	CIRCLIP 21X1,6	2
59*	4054.0477	SCHEIBE 8X18X0,4	SHIM 8X18X0,4	2
60*	4054.1085	KOLBEN ZUGSTUFE W5	PISTON REBOUND W5	2
62*	4054.0486	MUTTER M6X0,5 ZUGSTUFE	NUT M6X0,5 REBOUND	2
63*	4054.0867	O-RING NBR 3X2	O-RING NBR 3X2	2
64*	4054.13765	HYDR.STOP L=222,5MM KPL. COMP.	HYDR.STOP L=222,5MM KPL. COMP.	1
65*	4054.13775	HYDR. STOP L=222,5MM KPL. REB.	HYDR. STOP L=222,5MM KPL. REB.	1
66*	4054.1259	SPERRSCHEIBE SB11	LOCK WASHER SB11	2
67*	4054.0296	STAHLKUGEL D=4MM	STEEL BALL D=4MM	2
68*	4054.0472	FEDER FÜR EINSTELLSCHRAUBE	SPRING FOR ADJUST. SCREW	2
69*	4357.0122	RING 28X38X1,5	RING 28X38X1,5	2
70*	4357.0093	SICHERUNGSRING D=59MM	LOCK WASHER D=59MM	2



**CHOKE BETÄTIGUNG
SIEHE VERGASER!**
*CHOKE SYSTEM
SEE CARBURATOR!*

FIG	TEILNR/PARTNR	BEZEICHNUNG	DESCRIPTION	QTY
1	583.02.001.300	ALU-LENKER SX,SC,ADVENTURE'97	ALU-HANDLEBAR SX,SC,ADVENT.'97	1
3	502.02.010.000	DISTANZBÜCHSE 22X28X22 PVC	SPACER BUSHING 22X28X22PVC	X
10*	583.02.010.300	GASDREHGRIF DOMINO SXC'98	THROTTLE GRIP DOMINO SXC'98	1
11	502.02.003.000	DREHGRIFÜBERZUG DOMINO SCHW.	TWIST GRIP COVER DOMINO BLACK	1
12*	503.02.020.000	SCHUTZKAPPE DOMINO '97	PROTECTION COVER '97	1
14*	590.02.091.000	GASSEIL DOMINO 735MM SC '99	THROT.CABLE DOMINO 735MM SC'99	1
17	502.02.052.000	FESTGRIF DOMINO SCHWARZ '95	FIXED GRIP DOMINO BLACK '95	1
28*	584.12.040.000	SPIEGEL LINKS LC4 '98	MIRROR L/S LC4 '98	1
—*	584.12.041.000	SPIEGEL RECHTS LC4 '98	MIRROR R/S LC4 '98	1
29*	584.12.040.050	ADAPTER FÜR SPIEGEL LC4 '98	SUPPORT FOR MIRROR '98	2
40	583.02.040.100	KUPPLUNGHEBEL KPL. DOMINO '94	CLUTCH LEVER ASSY CPL.DOMINO	1
41	584.02.042.000	KUPPLUNGHEBEL LOSE SILBER '97	CLUTCH LEVER LOOSE SILVER '97	1
42	583.02.126.000	FALTENBALG KUPPLUNGHEBEL '95	CLUTCH LEVER BOOT '95	1
43	583.02.043.000	STELLSCHRAUBE KPL. M7	ADJUSTMENT SCREW CPL.M7	1
44	583.02.044.000	KLEMMSCHELLE SPIEGEL M10X1,25	CLAMP MIRROR M10X1,25	1
45	0015 060253	SK.BUNDSCHRAUBE M 6X25 SW=8	HH COLLAR SCREW M 6X25 WS=8	2
46	583.02.023.000	GELENKSTÜCK DOMINO	JOINT DOMINO	1
47	583.02.047.000	DEKOHEBEL LOSE	DECOMPRESSION LEVER LOOSE	1
48	583.02.048.000	SCHUTZKAPPE	PROTECTING COVER	1
49	583.02.049.000	HEBELSCHRAUBE KPL.	LEVER SCREW CPL.	1
90*	584.02.090.000	KUPPLUNGSEIL 4T L=1115MM '99	CLUTCH CABLE 4T L=1115MM '99	1
94*	583.02.094.200	HANDDEKOSEIL L=693,5MM LC4 '99	DECOMPR. CABLE L=693,5 LC4 '99	1

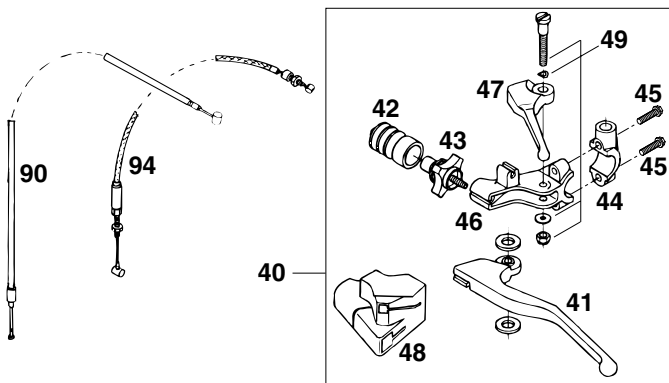
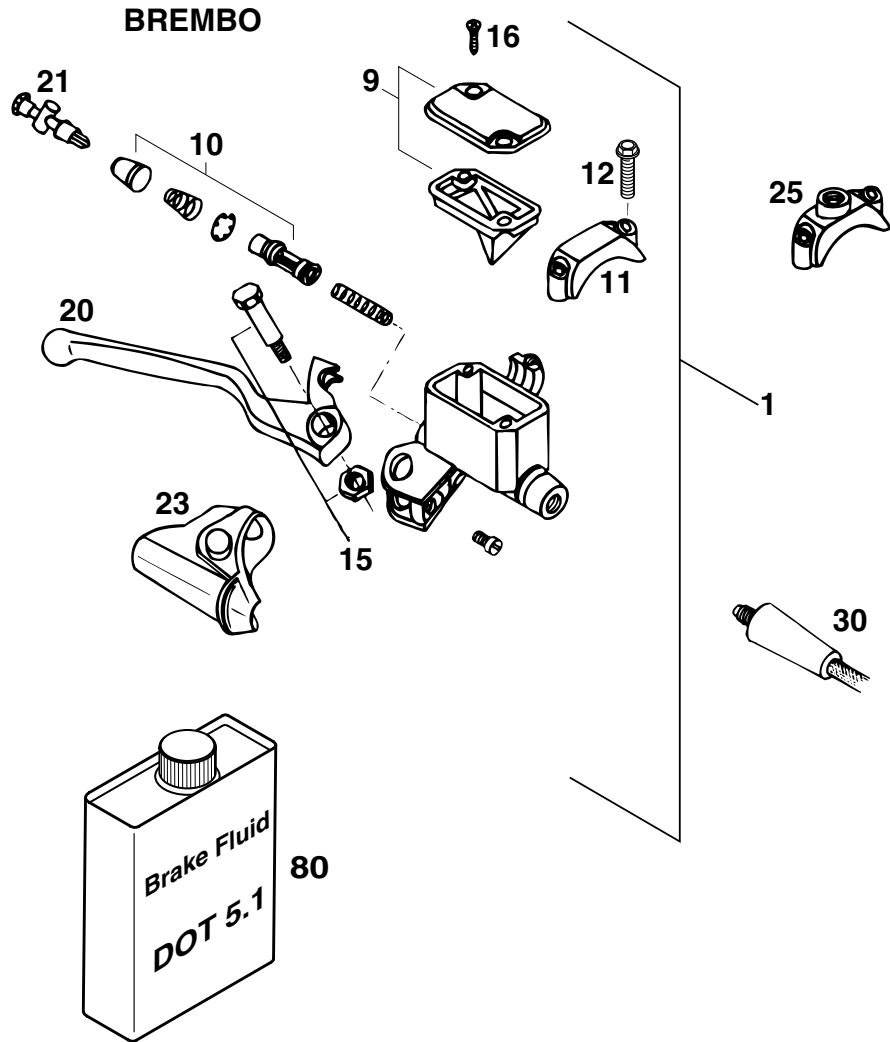

FIG	TEILNR/PARTNR	BEZEICHNUNG	DESCRIPTION	QTY
1	502.13.001.044	HANDBREMSZYLINDER BREMBO'94 D=11MM	HANDBRAKE CYLINDER BREMBO '94 D=11MM	1
9	502.13.012.000	DECKEL KPL.	COVER CPL.	1
10	502.13.050.000	REPARATUR-SATZ KOLBEN 11MM	REPAIR KIT PISTON 11MM	1
11	544.13.011.000	SCHELLE BREMBO ETL	CLAMP BREMBO	1
12	0015 060253	SK.BUNDSCHRAUBE M 6X25 SW=8	HH COLLAR SCREW M 6X25 WS=8	2
15	502.13.015.000	HEBELSCHRAUBE KPL.	LEVER SCREW CPL.	1
16	0965 050163	SENKSCHRAUBE DIN0965-M 5X16	FLAT HEAD SCREW DIN0965-M 5X16	2
20	502.13.020.000	HANDBREMSHEBEL LOOSE BREMBO'94	HAND BRAKE LEVER LOOSE BREM'94	1
21	502.13.021.000	STELLSCHRAUBE KPL.	ADJUSTING SCREW CPL.	1
23	502.13.023.000	SCHUTZKAPPE BREMBO'94	PROTECTION CAP BREMBO'94	1
25	580.12.040.150	KLEMMSCHELLE FÜR SPIEGEL '94	CLAMP FOR MIRROR '94	1
30*	583.13.011.100	BREMSSCHLAUCH VO.WP 1290MM '99	BRAKE HOSE FRONT WP 1290MM '99	1
80	306054	BREMSSCHLAUCH VO.WP 1290MM '99	BRAKE FLUID DOT 5.1	1



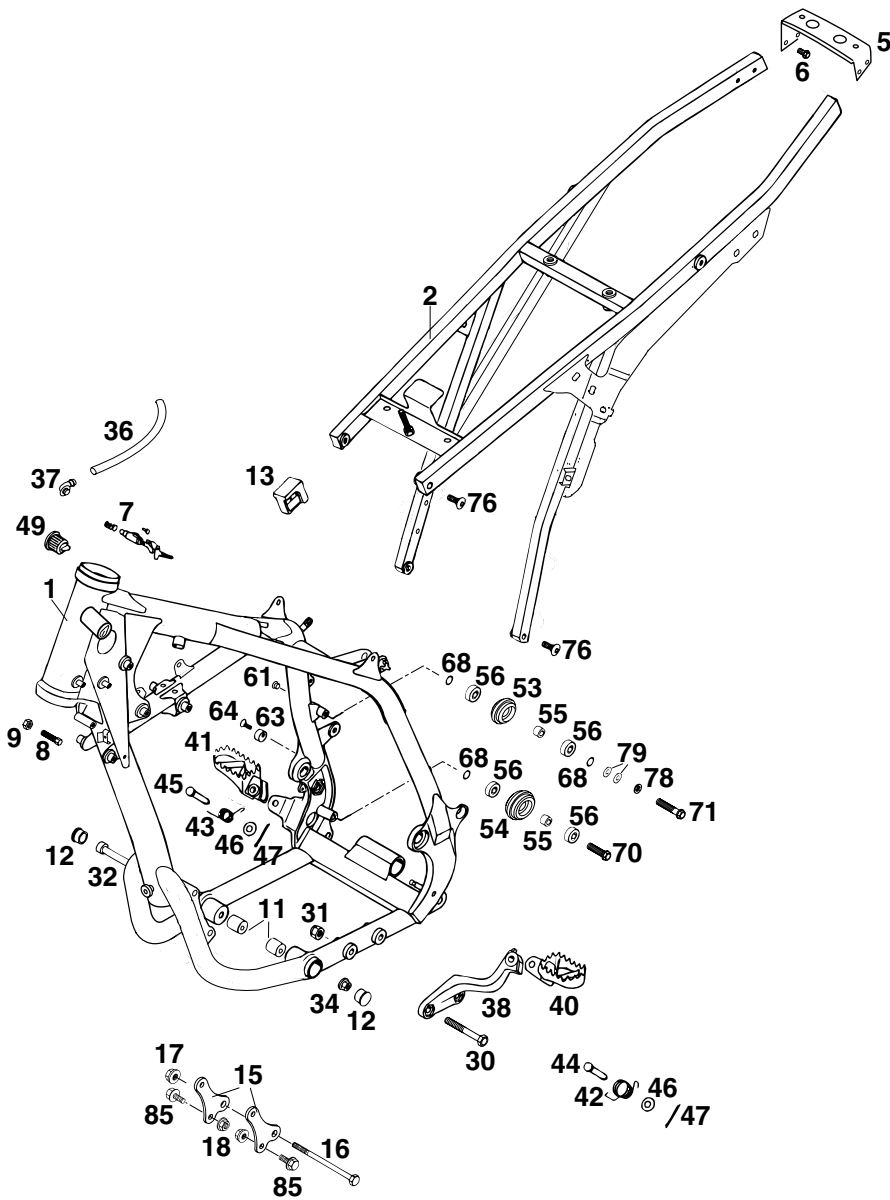

FIG	TEILNR/PARTNR	BEZEICHNUNG	DESCRIPTION	QTY
1*	583.03.101.300	RAHMEN 400/620 SC SILBER '99 MIT LAGER FÜR ANLENKUNG	FRAME 400/620 SC SILVER '99 WITH BEARINGS FOR LINKING	1
2*	583.03.102.500	AUSLEGER KPL. ALU 400/620SC'99	SUB FRAME CPL. ALU SC '99	1
5*	584.03.002.152	ÜBERLAGBLECH F. AUSLEGER SC'99	OVERLAP METAL SHEET S.FRAME'99	1
6	0015 060103	SK.BUNDSCHRAUBE M 6X10 SW=8	HH COLLAR SCREW M 6X10 WS=8	4
7	710.03.007.000	STEUERKOPFSCHLOSS KPL. ZADI	STEERING HEAD LOCK CPL. ZADI	X
8*	590.01.037.000	ANSCHLAGSCHRAUBE M8X26 SW=10	SPECIAL SCREW M8X26 WS=10	2
9	0934 080003	SK.MUTTER DIN0934-M 8	HEXAGON NUT DIN0934-M 8	2
11	580.03.012.000	DISTANZROLLE 10,3X20X22	SPACER ROLLER 10,3X20X22	2
12	710.01.012.000	PVC ABSCHLUSSKAPPE D=22MM	PVC CAP D=22MM	2
13	583.07.015.000	TANKAUFLAGE '93	TANK SUPPORT '93	2
15	583.03.055.000	MOTORAUFHÄNGUNG AGW '94	ENGINE SUPPORT AGW '94	2
16	0931 101103	SK.SCHRAUBE DIN0931-M10X110	HH SCREW DIN0931-M10X110	1
17	490.09.082.000	STOVERFLANSCHMUTTER M10 SS	SELF LOCKING NUT M10 WS=17	1
18	543.10.086.000	STOVERFLANSCHMUTTER M8	SELF LOCKING NUT M8	4
30	0931 100603	SK.SCHRAUBE DIN0931-M10X60	HH SCREW DIN0931-M10X60	2
31	0985 100003	SS.MUTTER DIN0985-M10	SELF LOCKING NUT DIN0985-M10	2
32	0912 101603	ISK.SCHRAUBE DIN0912-M10X160	AH SCREW DIN0912-M10X160	1
34	546.30.044.000	BUNDMUTTER M10 SW=13	COLLAR NUT M10 WS=13	1
36	550.07.016.001	SCHLAUCH 7X10 PER METER	PVC-HOSE 7X10 PER METER	0,3
37	503.03.089.000	WINKELSTÜCK '97	ANGEL PIECE '97	1
38*	583.03.038.000/90	FUßRASTENTRÄGER LI. SILBER '99	FOOTREST BRACKET L/S SILVER '99	1
40*	583.03.040.000/90	FUSSRASTE LINKS SILBER '99	FOOTREST L/S SILVER '99	1
41*	546.03.140.000/90	FUSSRASTE RECHTS SILBER '98	FOOT REST R/S SILVER '98	1
42	583.03.041.000	FUSSRASTENFEDER LINKS '93	FOOTREST SPRING L/S '93	1
43	546.03.041.000	FUSSRASTENFEDER LINKS & RECHTS	FOOTREST SPRING L/S & R/S	1
44	583.03.044.000	BOLZEN FÜR FUSSRASTER 9,8 X 43	BOLT FOR FOOTREST 9,8 X 43	1
45	546.03.044.000	BOLZEN FÜR FUSSRASTER 9,8 X 50	BOLT FOR FOOTREST 9,8 X 50	1
46	0125 100003	UNTERLEGSSCHEIBE DIN0125-A10,5	WASHER DIN0125-A10,5	2
47	0094 032253	SPLINT DIN0094-3,2X25 STAHL	PIN DIN0094-3,2X25 STEEL	2
49	420.07.049.000	SCHUTZKAPPE	PLASTIC CAP	X
53*	523.03.053.000	KETTENROLLE D=30MM 125-380 '99	CHAIN ROLL D=30MM 125-380 '99	1
54*	523.03.053.100	KETTENROLLE D=35MM 125-380 '99	CHAIN ROLL D=35MM 125-380 '99	1
55	740.03.021.000	BÜCHSE 8 X 12 X 6,5	BUSHING 8 X 12 X 6,5	2
56	0625 006087	RILLENKUGELLAGER 608 2RS C3	GROOVED BALL BEAR. 608 2RS C3	4

FIG	TEILNR/PARTNR	BEZEICHNUNG	DESCRIPTION	QTY
61	544.03.135.000	VERSCHLUSSPFROPFEN SFL10	PLASTIC CAP SFL10	1
63	583.03.063.000	BREMSHEBELANSCHLAG '93	BRAKE LEVER STOP '93	1
64	0991 060203	SENKSCHRAUBE DIN7991-M 6X20	FLAT HEAD SCREW DIN7991-M 6X20	1
68	360.03.014.000	SCHNORR-SICHERUNGSSCHEIBE 8MM	LOCK WASHER 8MM	X
70	0015 080303	SK.BUNDSCHRAUBE M 8X30 SW=10	HH COLLAR SCREW M 8X30 WS=10	1
71	0015 080353	SK.BUNDSCHRAUBE M 8X35 SW=10	HH COLLAR SCREW M 8X35 WS=10	1
76	545.10.052.000	KETTENRADSCHRAUBE-ISK M 8X26	SPROCKET SCREW-AH M 8X26	4
78	0797 080003	ZAHNSCHEIBE DIN6797-J 8,4	TOOTHLOCK WASHER DIN6797-A 8,4	X
79	0125 080003	UNTERLEGSCHLEIBE DIN0125-A 8,4	WASHER DIN0125-A 8,4	X
85	491.09.481.052	SK.BUNDSCHRAUBE M 8X16	HH COLLAR SCREW M 8X16	4

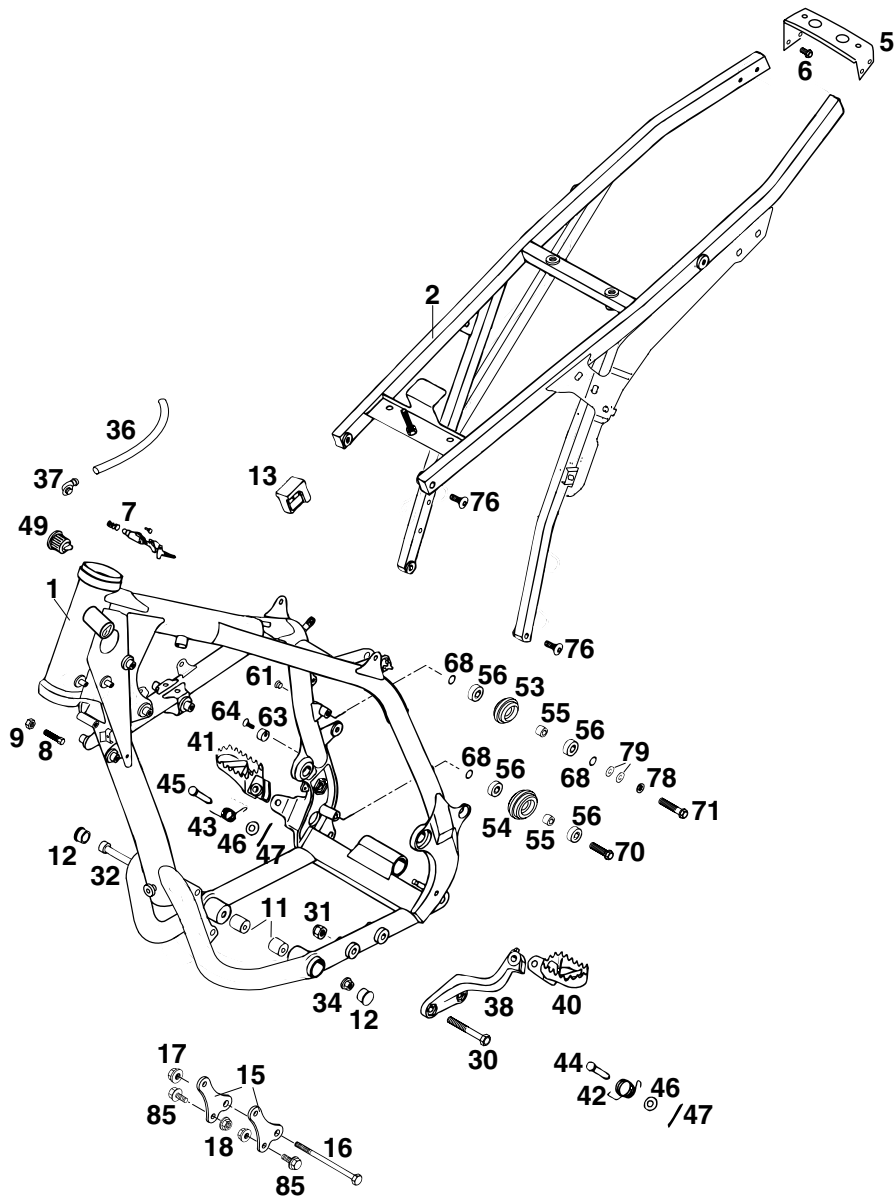
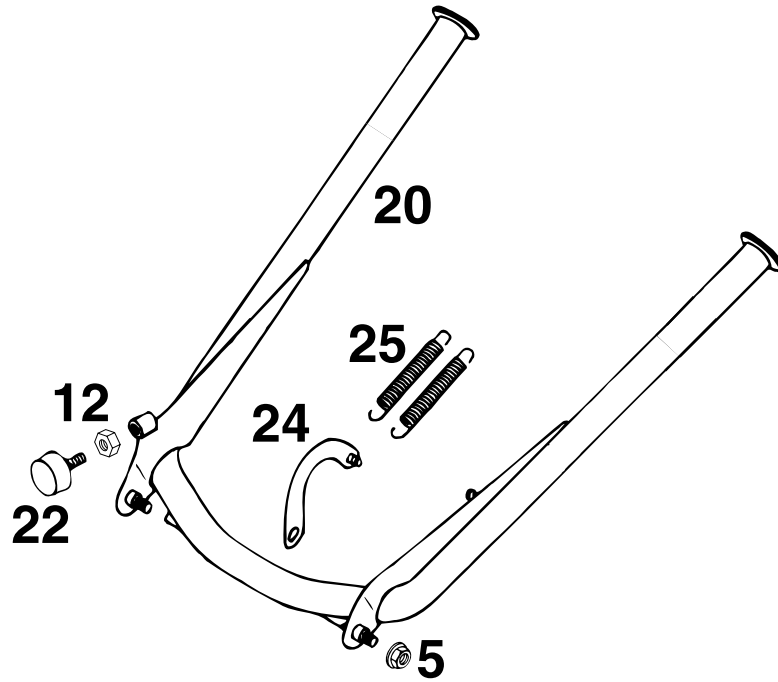

FIG	TEILNR/PARTNR	BEZEICHNUNG	DESCRIPTION	QTY
5	543.10.086.000	STOVERFLANSCHMUTTER M8	SELF LOCKING NUT M8	2
12	0934 080003	SK.MUTTER DIN0934-M 8	HEXAGON NUT DIN0934-M 8	1
20*	583.03.022.000/90	MITTELSTÄNDER 415MM SILBER '99	CENTER STAND 415MM SILVER '99	1
22	583.03.070.000	ANSCHLAGGUMMI M8	STOP RUBBER M8	1
24*	583.03.027.000/90	FEDERBÜGEL SILBER '99	SPRINGBOW SILVER '99	1
25	100.03.021.000	STÄNDERFEDER KURZ	STAND SPRING SHORT	2



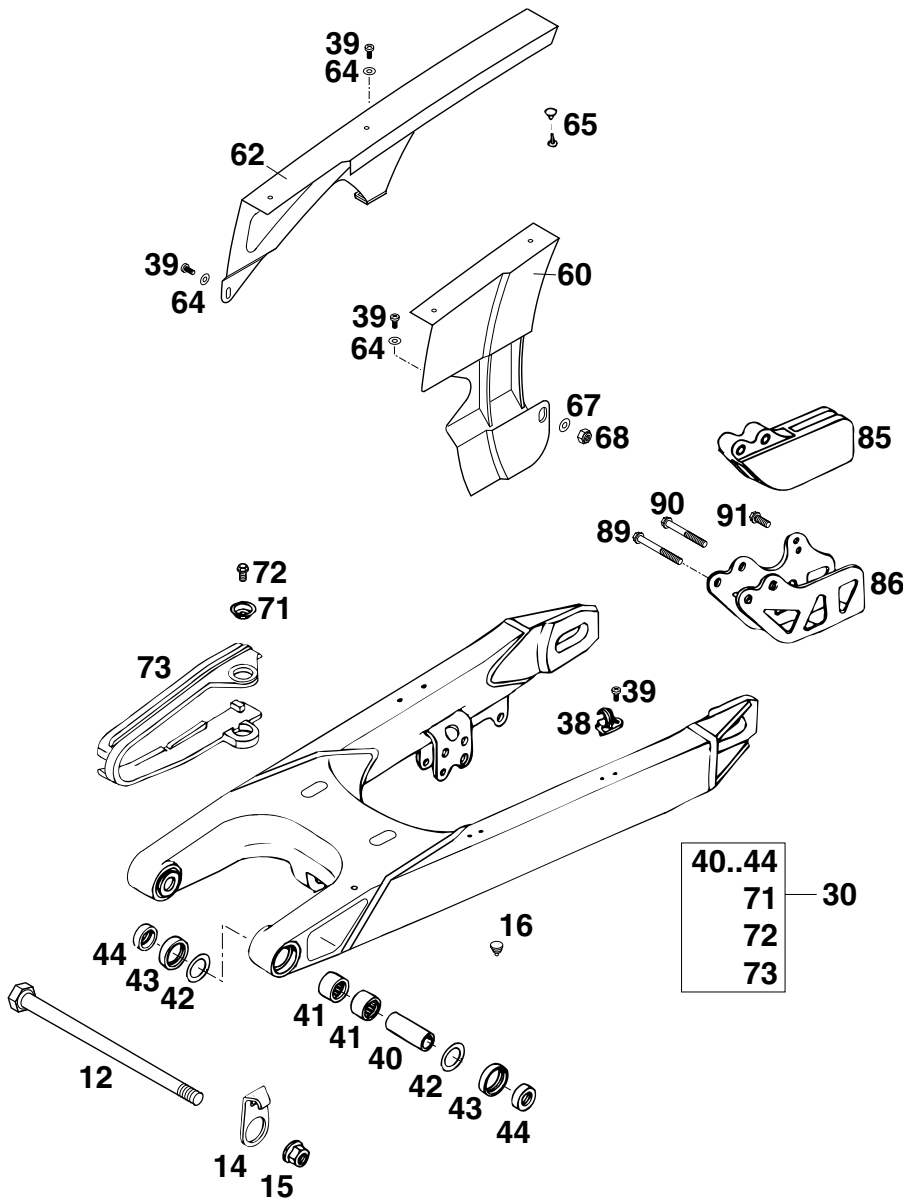

FIG	TEILNR/PARTNR	BEZEICHNUNG	DESCRIPTION	QTY
12	546.03.014.000	SCHWINGARMBOLZEN 15X250	SWINGARM BOLT 15X250	1
14	502.30.211.000	BREMSSCHLAUCHFÜHRUNG '89	BRAKE HOSE GUIDE '89	1
15	546.03.015.000	STOPPMUTTER M14X1,5 SW=19	SELF LOCKING NUT M14X1,5 WS=19	1
16	544.03.135.000	VERSCHLUSSPFROPFEN SFL10	PLASTIC CAP SFL10	X
30	583.03.130.344	SCHWINGARM KPL. L=567MM '97	SWINGARM CPL. L=567MM '97	1
38	546.11.076.100	HALTESCHELLE FÜR BREMSSCHL.'96	RETAIN.CLAMP FOR BRAKE HOSE'96	2
39	0010 050103	GEW.FURCHSCHRAUBE M 5,0X10	SPECIAL SCREW M 5,0X10	5
40	502.03.081.700	LAGERHÜLSE 15X20X38,75	BEARING SLEEVE 15X20X38,7	2
41	502.03.097.000	NADELHÜLSE HK 2012	NEEDLE BUSH HK 2012	4
42	546.03.036.000	ANLAUFSCHLEIBE 22,2X31,7X1	STOP DISK 22,2X31,7X1	2
43	0760 253270	WELLENDICHTRING 25X32X7	SHAFT SEAL RING 25X32X7	4
44	546.03.090.000	TASSE FÜR WELLENDICHTR.15X25X9	BUCKET F.SHAFTSEALRING 15X25X9	4
60	583.07.060.000	KETTENSCHUTZ KLEIN '96	CHAINGUARD SMALL '96	1
62	583.07.060.150	KETTENSCHUTZ GROSS '97	CHAINGUARD LARGE '97	1
64	0125 050003	UNTERLEGSCHLEIBE DIN0125-A 5,0	WASHER DIN0125-A 5,0	3
65	200.12.062.055	HOHLNIET 2-TLG.	HOLLOW RIVET TWO PARTS	2
67	0125 060003	UNTERLEGSCHLEIBE DIN0125-A 6,4	WASHER DIN0125-A 6,4	1
68	0985 060003	SS.MUTTER DIN0985-M 6	SELF LOCK. NUT DIN0985-M 6	1
71	722.10.079.000	STÜTZSCHALE	BUCKET	2
72	0015 060103	SK.BUNDSCHRAUBE M 6X10 SW=8	HH COLLAR SCREW M 6X10 WS=8	2
73	583.07.073.000	KETTENGLEITSCHUTZ DUKE'94	CHAIN SLIDING GUARD DUKE'94	1
85	546.07.066.100	KETTENFÜHRUNG HINTEN '94	CHAIN GUIDE REAR '94	1
86	502.07.070.000	HALTEBLECH KETTENFÜHRUNG '94	RETAINING PLATE CHAIN GUIDE'94	1
89	0015 060553	SK.BUNDSCHRAUBE M 6X55 SW=8	HH COLLAR SCREW M 6X55 WS=8	1
90	0015 060503	SK.BUNDSCHRAUBE M 6X50 SW=8	HH COLLAR SCREW M 6X50 WS=8	1
91	0015 060163	SK.BUNDSCHRAUBE M 6X16 SW=8	HH COLLAR SCREW M 6X16 WS=8	1

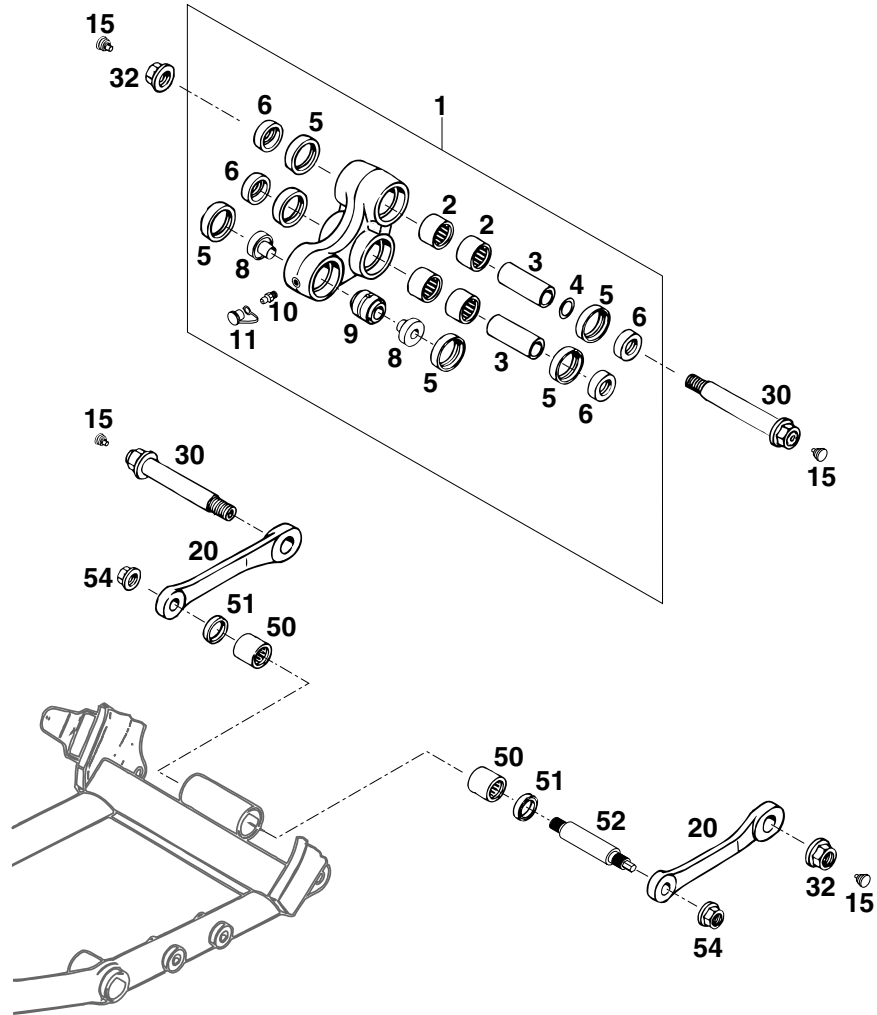

FIG	TEILNR/PARTNR	BEZEICHNUNG	DESCRIPTION	QTY
1*	583.03.080.244	WINKELH.KPL.GESCHMIEDET LC4'99	ROCKER ARM CPL. FORGED LC4 '99	1
2	546.03.097.000	NADELHÜLSE HK 2016	NEEDLE BUSH HK 2016	4
3	546.03.081.000	LAGERHÜLSE 15 X 20 X 48	BEARING SLEEVE 15 X 20 X 48	2
4	546.03.090.010	STAHSCHIBE 15,2X19X0,1	STEEL WASHER 15,2X19X0,1	X
-	546.03.090.020	STAHSCHIBE 15,2X19X0,2	STEEL WASHER 15,2X19X0,2	X
-	546.03.090.030	STAHSCHIBE 15,2X19X0,3	STEEL WASHER 15,2X19X0,3	X
5	0760 253270	WELLENDICHTRING 25X32X7	SHAFT SEAL RING 25X32X7	6
6	583.03.090.000	TASSE F. WELLENDICHTR.15X25X11	SPAC.F.SHAFT SEALRING 15X25X11	4
8	583.03.085.100	BUNDBÜCHSE FÜR GELENKLAGER '95	BUSHING FOR BEARING LINK '95	2
9	542.03.083.050	GELENKLAGER 12X25X22 (16-1061)	LINK BEARING 12X25X22(16-1061)	1
10	720.03.035.000	SCHMIERNIPPEL M6 GERADE	GREASE FITTING M6 STRAIGHT	1
11	530.03.099.000	SCHUTZKAPPE MIT SCHLAUFE ROT	CAP WITH LOOP RED	1
15	544.03.135.000	VERSCHLUSSPFROPFEN SFL10	PLASTIC CAP SFL10	4
20	583.03.083.000	VERBINDUNGSSTANGE L=127MM '93	LINKAGE ARM L=127MM '93	2
30	546.03.182.044	BOLZEN VERB.STANGE-WINKELH.KPL 15X98MM / M14X1,5	BOLT LINK. ARM-ROCKER ARM CPL 15X98MM / M14X1,5	2
32	546.03.015.000	STOPPMUTTER M14X1,5 SW=19	SELF LOCKING NUT M14X1,5 WS=19	2
50	565.03.195.100	NADELLAGER HK 1816	NEEDLE BEARING HK 1816	2
51	0760 182442	WELLENDICHTRING 18X24X4	SHAFT SEAL RING 18X24X4	2
52	583.03.084.100	LAGERBOLZ.VERBINDUNGSSTANGE'96	BEARING BOLT CONNECTING ROD'96	1
54	491.03.415.000	STOV.FLA.MUTTER M12X1,75 SW19	SELF LOCK. NUT M12X1,75 WS=17	2

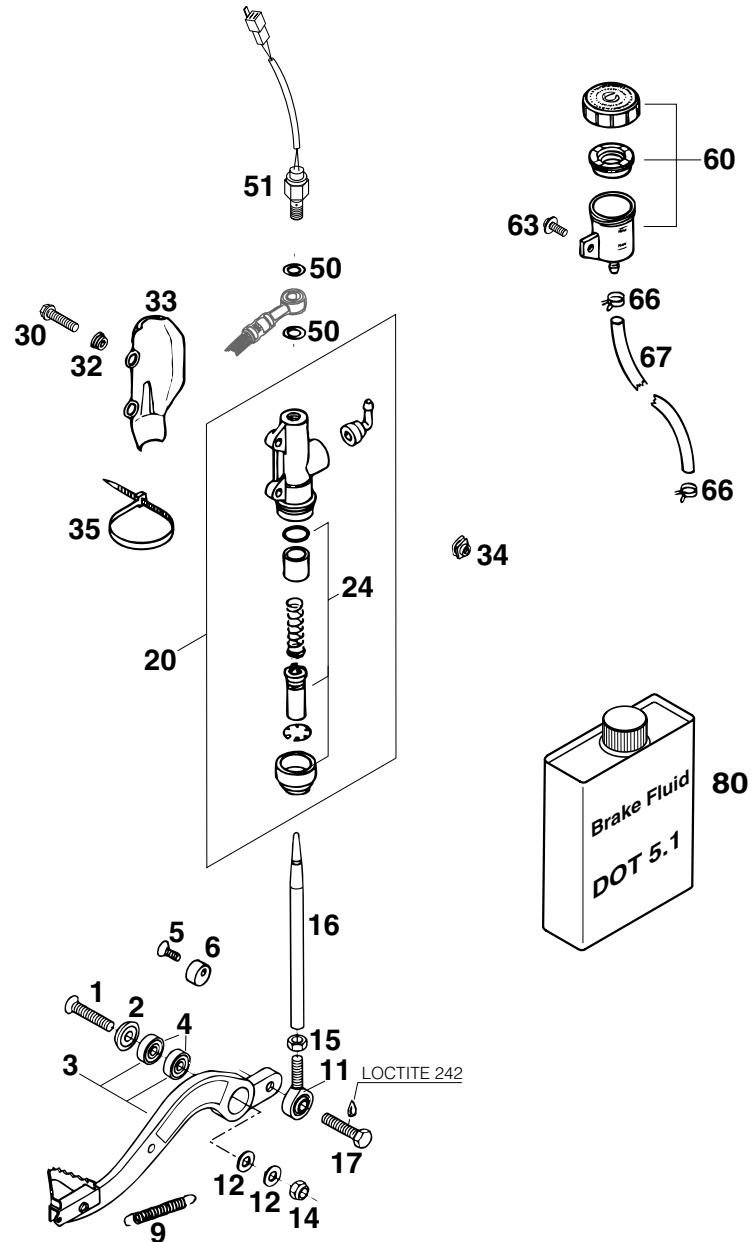
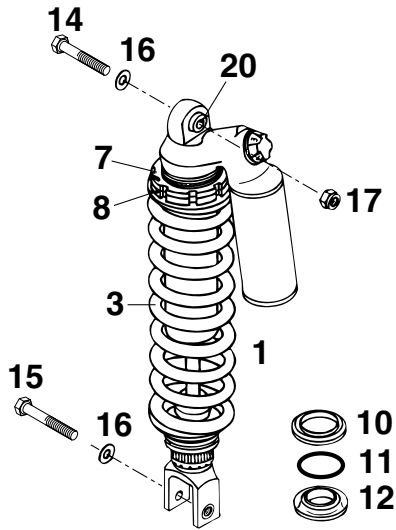

FIG	TEILNR/PARTNR	BEZEICHNUNG	DESCRIPTION	QTY
1	0991 080353	SENKSCHRAUBE DIN7991-M 8X35	FLAT HEAD SCREW DIN7991-M 8X35	1
2	583.03.061.000	FASONSCHIBE ALU 8 X 24 MM	SPECIAL WASHER ALU 8 X 24 MM	1
3	583.03.060.044	FUSSBREMSHEBEL KPL. '93	FOOT BRAKE LEVER CPL. '93	1
4	0625 006087	RILLENKUGELLAGER 608 2RS C3	GROOVED BALL BEAR. 608 2RS C3	2
5	0991 060203	SENKSCHRAUBE DIN7991-M 6X20	FLAT HEAD SCREW DIN7991-M 6X20	1
6	583.03.063.000	BREMSHEBELANSCHLAG '93	BRAKE LEVER STOP '93	1
9	130.03.062.000	RÜCKHOLFEDER	RETURN SPRING	1
11	583.03.062.000	GELENKKOPF M8 B=12MM '93	HEIM JOINT M8 W=12MM '93	1
12	0125 080003	UNTERLEGSCHIBE DIN0125-A 8,4	WASHER DIN0125-A 8,4	2
14	0985 080003	SS.MUTTER DIN0985-M 8	SELF LOCKING NUT DIN0985-M 8	1
15	0934 080003	SK.MUTTER DIN0934-M 8	HEXAGON NUT DIN0934-M 8	1
16	583.03.068.100	DRUCKSTANGE ALU L=178MM '93	PUSH ROD ALU L=178MM '93	1
17*	0933 080223	SK.SCHRAUBE DIN0933-M 8X22 8.8	HH SCREW DIN0933-M 8X22 8.8	1
20	545.13.101.044	HAUPTBREMSZYLINDER '89	MAIN BRAKE CYLINDER '89	1
24	545.13.150.000	REPARATUR SATZ KOLBEN 13MM	REPAIR KIT PISTON 13MM	1
30	0015 060253	SK.BUNDSCHRAUBE M 6X25 SW=8	HH COLLAR SCREW M 6X25 WS=8	2
32	502.13.161.000	BUNDBÜCHSE	COLLAR BUSHING	2
33	545.13.038.000	BREMSZYLINDERSCHUTZ „BREMBO“	BRAKE CYL. PROTECTOR „BREMBO“	1
34	502.35.033.300	KLIPS-MUTTERNHALTER M6 KP142	SNAP-NUT HOLDER M6 KP142	2
35	440.11.076.305	KABELBAND 290MM	CABLE TIE 290MM	1
50	420.13.226.000	CU-DICHRING DIN7603-10X16X1	CU-SEAL RING DIN7603-10X16X1	2
51	503.11.051.100	BREMSLICHTSCHALTER HINTEN '98	BRAKE LIGHT SWITCH REAR '98	1
60	545.13.030.044	BREMSFLÜSSIGKEITSRESERVIOR '89	BRAKE FLUID RESERVOIR '89	1
63	0014 060103	SK.BUNDSCHRAUBE M 6X10 SW=8	HH COLLAR SCREW M 6X10 WS=8	1
66	580.07.017.000	YDNAC KLAMMER 10101 (9MM)	YDNAC CLAMP 10101 (9MM)	2
67	580.07.016.101	SCHLAUCH FÜR RESERVIOR 6X1,5	HOSE FOR RESERVOIR 6X1,5	0,1
80	306054	BREMSFLÜSSIGKEIT DOT 5.1	BRAKE FLUID DOT 5.1	1



FEDER / SPRING / RESSORT

Weich / soft / douce

Hart / hard / dure



54-260
57-260
60-260
63-260
66-260
70-260

FIG	TEILNR/PARTNR	BEZEICHNUNG	DESCRIPTION	QTY
1*	0118.T705	MONOSHOCK WP „0118T705“ SC '99	MONOSHOCK WP „0118T705“ SC '99	1
3	583.04.011.054	FEDER WP 54-260	SPRING WP 54-260	X
3	583.04.011.057	FEDER WP 57-260	SPRING WP 57-260	X
3	583.04.011.060	FEDER WP 60-260	SPRING WP 60-260	X
3	583.04.011.063	FEDER WP 63-260	SPRING WP 63-260	1
3	583.04.011.066	FEDER WP 66-260	SPRING WP 66-260	X
3	583.04.011.070	FEDER WP 70-260	SPRING WP 70-260	X
7	542.04.109.000	KONTERMUTTER	COUNTER NUT	1
8	542.04.009.000	EINSTELLMUTTER	ADJUSTING NUT	1
10	583.04.017.000	RING FÜR MONOSHOCK	RING FOR SHOCK ABSORBER	1
11	583.04.090.000	O-RING 32 X 8	O-RING 32 X 8	1
12	583.04.018.000	O-RING TRÄGER 14MM HOCH	O-RING CARRIER 14MM HIGH	1
14	565.03.086.000	SONDERSCHRAUBE M10X47 10.9	SPECIAL SCREW M10X47 10.9	1
15	565.03.093.000	SONDERSCHRAUBE M10X55 10.9	SPECIAL SCREW M10X55 10.9	1
16	0125 100003	UNTERLEGSCHIEBE DIN0125-A10,5	WASHER DIN0125-A10,5	2
17	543.10.086.100	SS.MUTTER M10 CU SW=14	SELF LOCKING NUT M10 CU WS=14	1
20	542.04.020.100	BUCHSE KPL. D=24MM B=24MM	BUSHING CPL. D=24MM B=24MM	1

400 SC

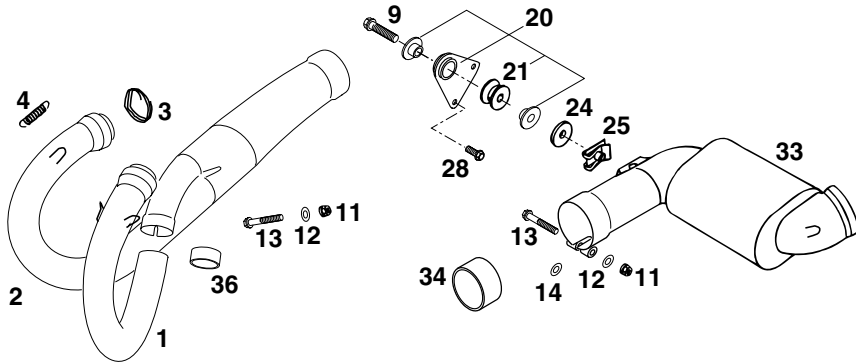

620 SC

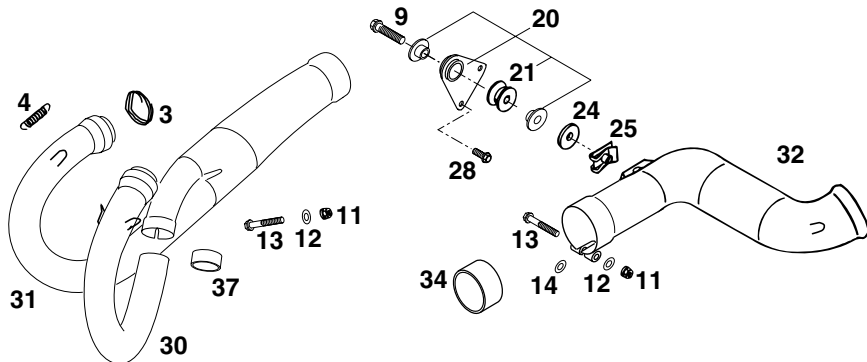

FIG	TEILNR/PARTNR	BEZEICHNUNG	DESCRIPTION	QTY
1	577.05.007.100	AUSPUFFROHR LI. „KTM577“ '98	EXHAUST PIPE L/S „KTM577“ '98	1
2	577.05.008.100	AUSPUFFROHR RE. „KTM577“ '98	EXHAUST PIPE R/S „KTM577“ '98	1
3	583.05.053.001	KERAMIKSCHNUR 1 METER	CERAMIC LINE 1 METER	1
4	543.09.036.000	ZUGFEDER L=38MM	RETURN SPRING L=38 MM	4
9	0015 080353	SK.BUNDSCHRAUBE M 8X35 SW=10	HH COLLAR SCREW M 8X35 WS=10	1
11	510.10.086.000	SS-MUTTER M 6 CU	SELF LOCKING NUT M 6 COPPER	2
12	0125 060003	UNTERLEGSCHIBE DIN0125-A 6,4	WASHER DIN0125-A 6,4	2
13	0015 060403	SK.BUNDSCHRAUBE M 6X40 SW=8	HH COLLAR SCREW M 6X40 WS=8	2
14	120.11.016.000	SCHEIBE 6 X 12 X 3	WASHER 6 X 12 X 3	1
20*	583.05.065.044/90	HALT.VORSCHALLD.KPL.SILBER '99	BRACKET-PRE-SIL.CPL SILVER '99	1
21	543.05.068.100	DÄMPFUNGSELEMENT SILICON GRAU	DAMPING COMPONENT SILICON GREY	1
24	510.05.067.000	ISOLIERSCHEIBE 8,5X28X3	INSULATE WASHER 8,5X28X3	1
25	546.03.048.000	MEHRBEREICHSBLECHMUTTER M8	RANGE CHANGE METAL NUT M8	1
28	0015 060163	SK.BUNDSCHRAUBE M 6X16 SW=8	HH COLLAR SCREW M 6X16 WS=8	2
30	584.05.007.200	AUSPUFFROHR LI. „KTM584“ '98	EXHAUST PIPE L/S „KTM584“ '98	1
31	584.05.008.200	AUSPUFFROHR RE. „KTM584“ '98	EXHAUST PIPE R/S „KTM584“ '98	1
32*	583.05.175.300	ERSATZROHR VORSCHALLDÄMPFER'99	TUBE-PRE SILENCER '99	1
33	584.05.050.200	VORSCHALLDÄMPFER „KTM V2“ '98	PRESILENCER „KTM V2“ '98	1
34	584.05.005.001	GRAPHITRING 45X50X25	GRAPHITRING 45X50X25	1
36	577.05.005.000	GRAPHITRING 28X32X20	GRAPHIT RING 28X32X20	1
37	584.05.005.000	GRAPHITRING 32X37X20	GRAPHIT RING 32X37X20	1

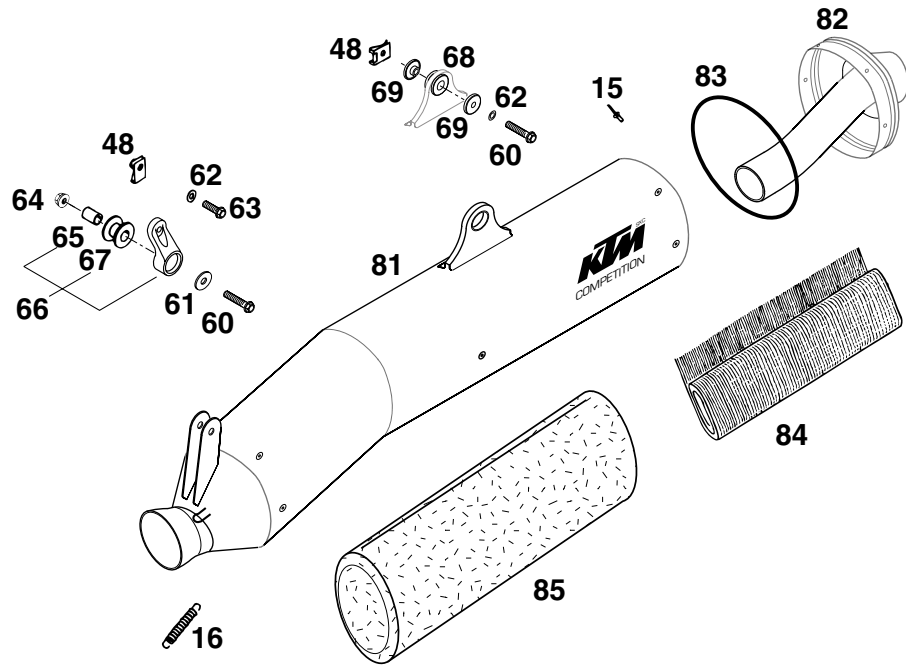

FIG	TEILNR/PARTNR	BEZEICHNUNG	DESCRIPTION	QTY
15	0011 480802	BLINDNIETE 4,8X 8,0 NIRO	DUMMY RIVET 4,8X 8,0 NIRO	10
16	503.05.016.000	ZUGFEDER L=55MM ÖSEN BEWEGLICH	TENSION SPRING L=55MM	2
48	546.03.048.100	MEHRBEREICHSBLECHMUTTER M6	RANGE CHANGE METAL NUT M6	2
60	0015 060303	SK.BUNDSCHRAUBE M 6X30 SW=8	HH COLLAR SCREW M 6X30 WS=8	2
61	0021 060003	SCHEIBE DIN9021-A 6,4	WASHER DIN9021-A 6,4	1
62	0137 060000	FEDERSCHEIBE DIN0137-B 6	SPRING WASHER DIN0137-B 6	2
63	0015 060203	SK.BUNDSCHRAUBE M 6X20 SW=8	HH COLLAR SCREW M 6X20 WS=8	1
64	565.09.064.000	STOVER-FLANSCHMUTTER M6	SELF LOCKING NUT M6	1
65	543.05.069.000	BÜCHSE 12 X 7 X 16	BUSHING 12 X 7 X 16	1
66	583.05.165.244	SCHALLDÄMPFERHAL. KPL. KURZ'96	SILENCER BRACKET CPL. SHORT'96	1
67	543.05.068.100	DÄMPFUNGELEMENT SILICON GRAU	DAMPING COMPONENT SILICON GREY	1
68	546.05.068.000	DÄMPFUNGELEMENT SCHWARZ	EXHAUST BRACKET RUBBER BLACK	1
69	546.05.069.000	BÜCHSE 7,5X12X28X7,8 '96	BUSHING 7,5X12X28X7,8 '96	2
81	583.05.081.000	ENDDÄMPFER GEDROSSELT SXC'98	SILENCER THROTTLED SXC'98	1
81	583.05.081.100	ENDDÄMPFER UNGEDROSSELT SXC'98	SILENCER UNTHROTTLED SXC'98	1
82	583.05.081.003	ENDKAPPE KPL.SXC GEDROSSELT'98	END CAP CPL. SXC THROTTLED '98	1
82	583.05.081.004	ENDKAP.KPL.SXC UNGEDROSSELT'98	END CAP CPL.SXC UNTHROTTLED'98	1
83	0770 223601	O-RING 82,14X3,53 SILIKON	O-RING 82,14X3,53 SILIKON	2
84	583.05.078.002	DÄMMSTOFFMATTE HINTEN 90GR.'98	STUFFING YARN REAR 90 GRAMM'98	1
85	583.05.078.000	DÄMMSTOFF VORNE 400 GRAMM '98	STUFFINGYARN FRONT 400GRAMM'98	1

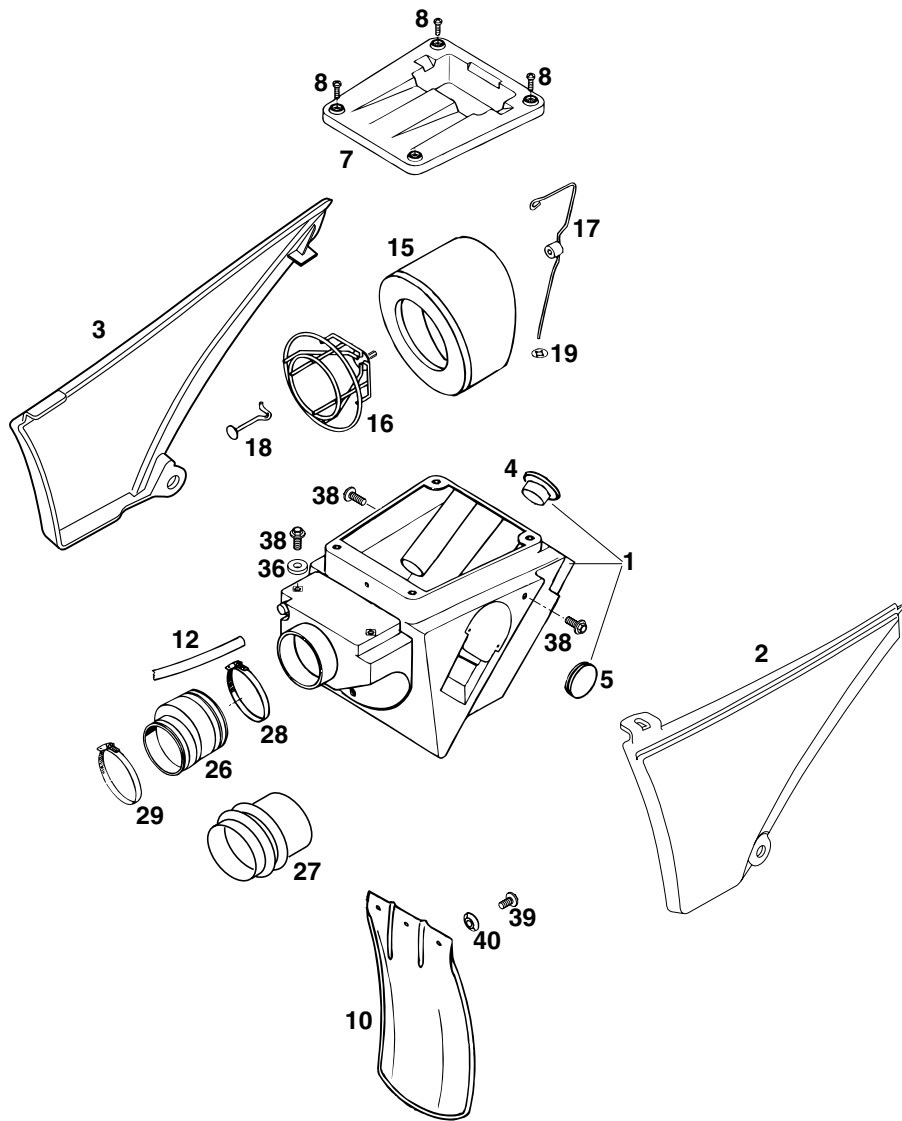

FIG	TEILNR/PARTNR	BEZEICHNUNG	DESCRIPTION	QTY
1	583.06.001.100	FILTERKASTEN KPL. OHNE SLS '94	FILTER BOX CPL. WITHOUT SLS'94	1
2*	583.06.003.000	FILTERKASTENDECKEL LINKS SC'99	FILTER BOX COVER L/S SC '99	1
3*	584.06.004.000	FILTERKASTENDECKEL RE. LC4'98	FILTER BOX COVER R/S LC4'98	1
4	583.06.004.000	VERSCHLUSSKAPPE 30MM	PLUG 30 MMM	1
5	546.06.004.000	VERSCHLUSSKAPPE 37MM	PLUG 37 MM	1
7	583.06.102.000	FILTERKASTENDECKEL GESCHLOSSEN	FILTER BOX COVER CLOSED	1
8	0985 050103	LINSENSCHRAUBE DIN7985-M 5X10	OVAL HEAD SCR. DIN7985-M 5X10	4
10	546.06.010.000	SPRITZSCHUTZ FÜR FILTERKASTEN	SPLASH PROTECT.FOR FILTER BOX	1
12	570.05.020.001	SCHLAUCH 10X14 PER METER	HOSE 10X14 PER METER	0,19
15	565.06.015.100	FILTERELEMENT 125/550/LC4/DUKE	FILTERELEMENT 125/550/LC4/DUKE	1
16	583.06.016.100	FILTERTRÄGER '97	FILTER CARRIER '97	1
17	583.06.017.100	HALTEBÜGEL FÜR LUFTFILTER '97	HOLDING HANGER FOR FILTER '97	1
18	583.06.017.050	HAKEN FÜR FILTERHALTEBÜGEL	HOOK FOR FILTER BRACKET	1
19	546.06.019.004	KLEMMSCHEIBE KS4	CLAMPING DISK KS4	1
26	583.06.026.000	VERGASERMANSCHETTE PHM38SD '98 400 SC	CARBURETOR CONNECTION BOOT '98 400 SC	1
27	580.06.026.500	VERGASERMANSCHETTE 540/620/640 620 SC	AIR FILTER BOOT 540/620/640 620 SC	1
28	550.06.028.000	SCHLAUCHBINDER 60-80MM	HOSE CLAMP 60-80MM	1
29	510.06.027.000	SCHLAUCHBINDER 50-70MM	HOSE CLAMP 50-70MM	1
36	502.32.050.001	STAHSCHLEIBE 6X17X3	STEEL WASHER 6X17X3	X
38	0014 060153	SK.BUNDSCHRAUBE M 6X15 SW=8	HH COLLAR SCREW M 6X15 WS=8	4
39	0014 060103	SK.BUNDSCHRAUBE M 6X10 SW=8	HH COLLAR SCREW M 6X10 WS=8	2
40	722.10.079.000	STÜTZSCHALE	BUCKET	2

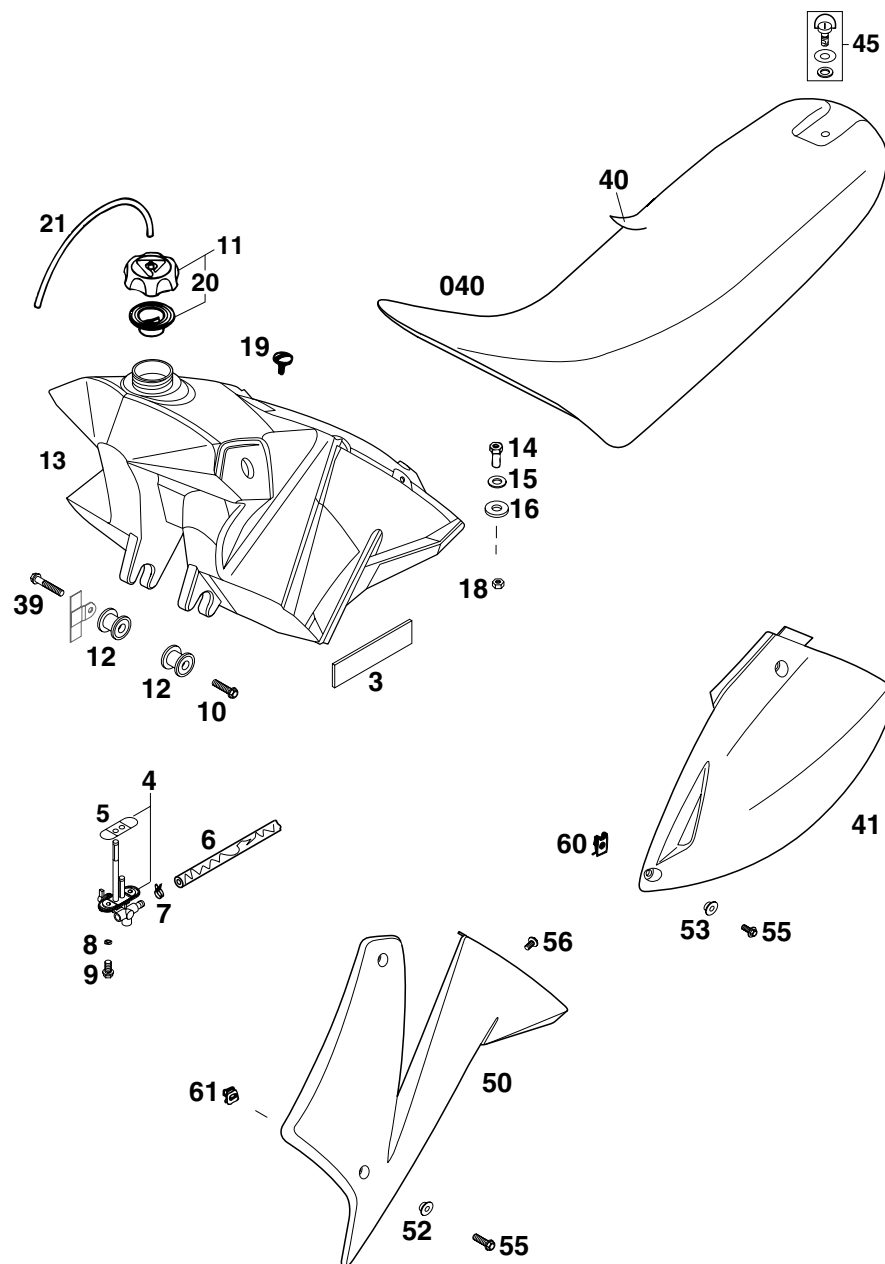

FIG	TEILNR/PARTNR	BEZEICHNUNG	DESCRIPTION	QTY
3*	546.01.097.000	GUMMISTREIFEN 85X25X3 MM	RUBBER STRIP 85X25X3 MM	4
4	583.07.005.100	BENZINHAHN MIKUNI CK-84 '96	FUEL COCK MIKUNI CK-84 '96	1
5	583.07.106.100	DICHTUNG BENZINHAHN MIKUNI	GASKET FUEL COCK MIKUNI	1
6	544.35.024.001	ND-SCHLAUCH ID 7,5 PER METER	HOSE ID 7,5 PER METER	0,32
7	580.31.005.000	YDNAC KLAMMER 10128 12MM	CLAMP YDNAC 10128 12MM	2
8	0603 061001	CU-DICHRING DIN7603- 6X10X1	CU-SEAL RING DIN7603- 6X10X1	2
9	0015 060123	SK.BUNDSCHRAUBE M 6X12 SW=8	HH COLLAR SCREW M 6X12 WS=8	2
10	0015 060253	SK.BUNDSCHRAUBE M 6X25 SW=8	HH COLLAR SCREW M 6X25 WS=8	1
11	490.07.008.044	TANKVERSCHLUSS KPL. KLEIN	FILLER CAP CPL. SMALL	1
12	583.07.113.250	TANKROLLE KPL. 12 X 34 X 25	TANK BUSHING CPL. 12 X 34 X 25	2
13*	583.07.013.700	BENZINTANK 9 LIT.SCHWARZ SC'99 SCHWARZ	FUEL TANK 9 LITER BLACK SC'99 BLACK	1
14	583.07.014.000	HALSMUTTER M8	SPECIAL NUT M8	1
15	583.07.019.000	SCHEIBE 10,5 X 25 X 1,5	WASHER 10,5 X 25 X 1,5	1
16	510.05.067.100	ISOLIERSCHEIBE 12X28X3	INSULATE WASHER 12X28X3	1
18	0934 080003	SK.MUTTER DIN0934-M 8	HEXAGON NUT DIN0934-M 8	1
19	580.07.044.000	LINSENSCHRAUBE M6X15 250/4T	OVAL HEAD SCREW M6X15 250/4T	1
20	490.07.009.000	DICHTUNG FÜR TANKVERSCHLUSS	GASKET FOR FILLER CAP	1
21	310.07.107.001	PVC-SCHLAUCH 6X9 MM PER METER	PVC-HOSE 6X9 MM PER METER	0,44
39	0015 060303	SK.BUNDSCHRAUBE M 6X30 SW=8	HH COLLAR SCREW M 6X30 WS=8	1
040*	583.07.340.700	SITZBANK SCHWARZ/ORANGE SC '99	SEAT BLACK/ORANGE SC '99	1
40*	583.07.340.750	SITZB.ÜBERZUG SCHW./ORANGE '99	SEAT COVER BLACK/ORANGE '99	1
41*	584.08.041.000/90	SEITENVERKL. LI SILBER LC4 '98	SIDE COVER L/S SILVER LC4 '98	1
—*	584.08.042.100/90	SEITENVERKL. RE. SILBER LC4'98	SIDE COVER R/S SILVER LC4 '98	1
45	583.07.040.551	SCHNELLVERSCHLUSS KPL. '96	QUICK RELEASE CPL. '96	1
50*	584.08.050.000/04	SPOILER LINKS ORANGE LC4 '98	SPOILER L/S ORANGE LC4 '98	1
—*	584.08.051.000/04	SPOILER RECHTS ORANGE LC4 '98	SPOILER R/S ORANGE LC4 '98	1
52	503.08.052.000	BÜCHSE FÜR SPOILER 6X11X16X5	BUSH FOR SPOILER 6X11X16X5	2
53	503.08.053.000	BÜCHSE FÜR SPOILER 6X11X16X7,5	BUSH FOR SPOILER 6X11X16X7,5	2
55	0015 060203	SK.BUNDSCHRAUBE M 6X20 SW=8	HH COLLAR SCREW M 6X20 WS=8	4
56	0014 060103	SK.BUNDSCHRAUBE M 6X10 SW=8	HH COLLAR SCREW M 6X10 WS=8	6
60	546.03.048.100	MEHRBEREICHBLECHMUTTER M6	RANGE CHANGE METAL NUT M6	2
61	502.35.033.300	KLIPS-MUTTERNHALTER M6 KP142	SNAP-NUT HOLDER M6 KP142	2

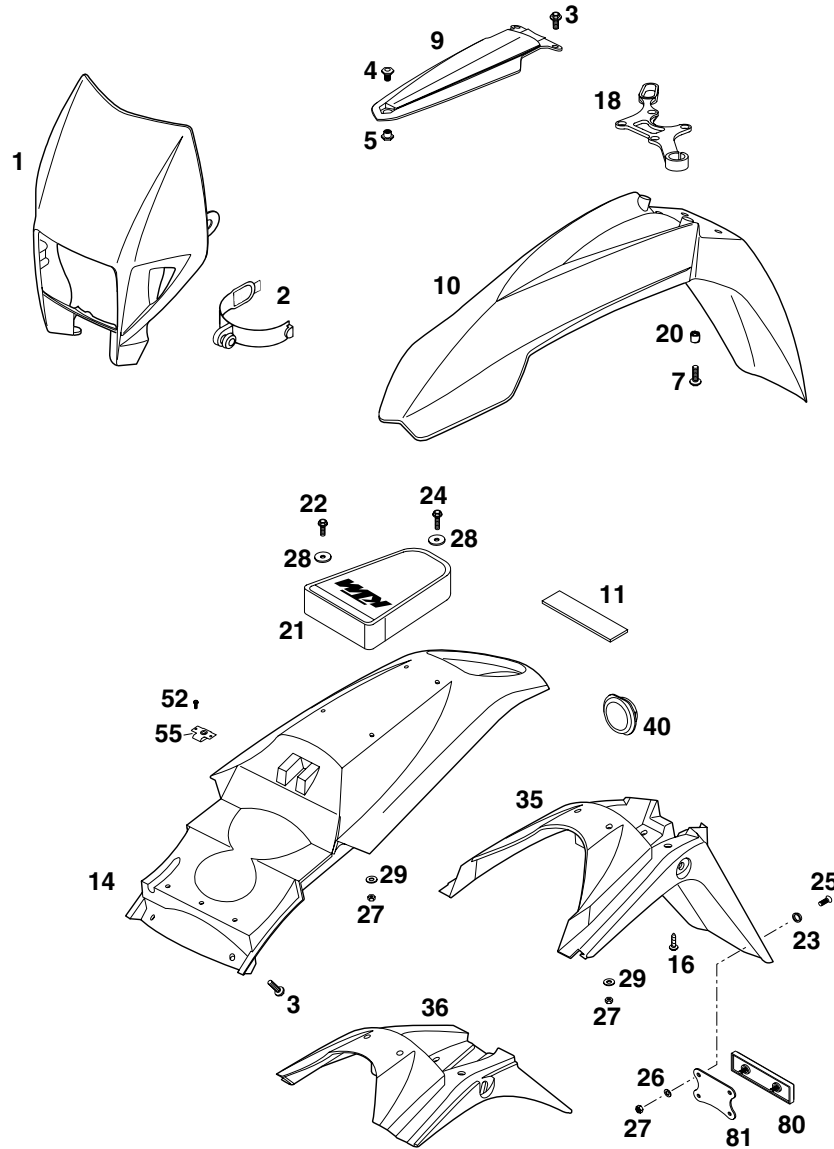
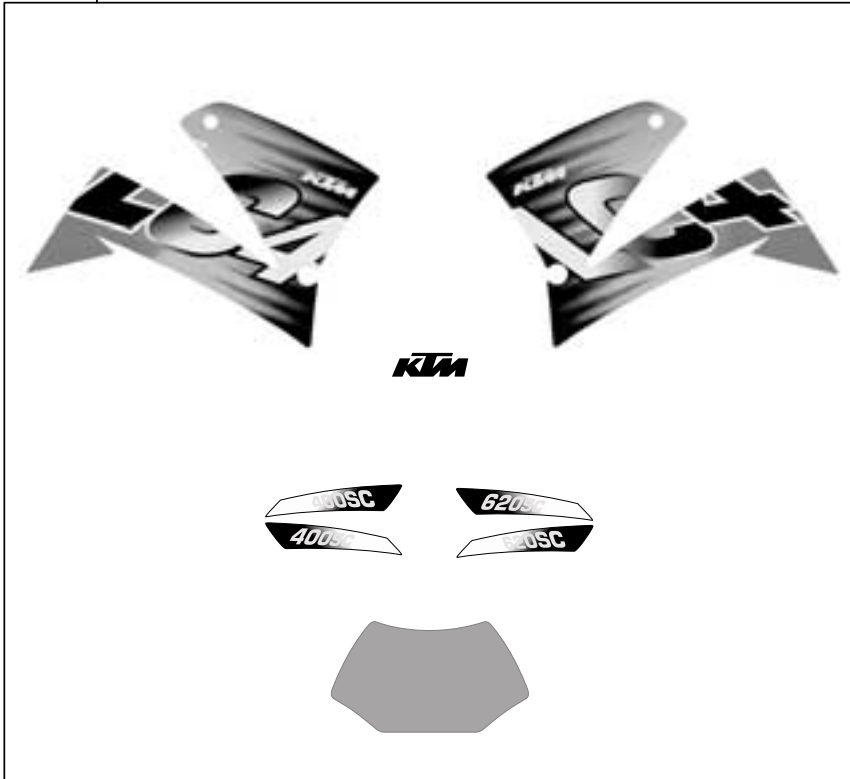

FIG	TEILNR/PARTNR	BEZEICHNUNG	DESCRIPTION	QTY
1*	503.08.001.000/04	SCHEIN.MASKE ORANGE EXC/EGS'99	H.LIGHT MASK ORANGE EXC/EGS'99	1
2	503.08.002.000	MASKENGUMMI UFO D=50MM '97	MASK RUBBER UFO D=50MM '97	2
3	0014 060153	SK.BUNDSCHRAUBE M 6X15 SW=8	HH COLLAR SCREW M 6X15 WS=8	4
4*	503.08.009.050	SCHRAUBE KOTFL.STR.M8X9 SW=17	SCREW FEND.BRACE M8X9 WS=17	1
5*	503.08.009.051	MUTTER KOTFL.STR. M8 SW=17	NUR FENDER BRACE M8 WS=17	1
7	0014 060203	SK.BUNDSCHRAUBE M 6X20 SW=8	HH COLLAR SCREW M 6X20 WS=8	4
9*	503.08.009.100	KOTFLÜGELSTREBE SCHWARZ '99	FENDER BRACE BLACK '99	1
10*	503.08.010.100/04	KOTFLÜGEL VORNE ORANGE '99	FENDER FRONT ORANGE '99	1
11*	546.01.097.000	GUMMISTREIFEN 85X25X3 MM	RUBBER STRIP 85X25X3 MM	2
14*	584.08.014.100/90	KOTFLÜGEL HINTEN SILBER LC4'99	FENDER REAR SILVER LC4 '99	1
16	0017 060203	SONDERSCHRAUBE T60 M 6X20	SPECIAL SCREW T60 M 6X20	2
18*	503.08.019.000	TACHOWELLENFÜHRUNG 125-380 '98	SPEEDO.CABLE GUIDE 125-380 '98	1
20	502.08.020.000	DISTANZBÜCHSE 7X10X7,5	SPACER BUSHING 7X10X7,5	4
21*	583.12.078.000	WERKZEUGTASCHE SCHWARZ SC '99	TOOL BAG BLACK SC '99	1
22	0015 050163	SK.BUNDSCHRAUBE M 5X16 SW=8	HH COLLAR SCREW M 5X16 WS=8	2
23	400.06.006.000	FASSONSCHIBE 6MM	WASHER 6MM	2
24	0015 050203	SK.BUNDSCHRAUBE M 5X20 SW=8	HH COLLAR SCREW M 5X20 WS=8	2
25	0966 050163	LI.SENKSCHRAUBE DIN0966-M 5X16	OVAL HEAD SCREW DIN0966-M 5X16	2
26	0125 050003	UNTERLEGSCHIBE DIN0125-A 5,0	WASHER DIN0125-A 5,0	2
27	0985 050003	SS.MUTTER DIN0985-M 5	SELF LOCKING NUT DIN0985-M 5	6
28	510.06.097.000	SCHEIBE 6,4X21,8X1MM	WASHER 6,4X21,8X1MM	4
29	0021 050003	SCHEIBE DIN9021-A 5,3	WASHER DIN9021-A 5,3	4
35*	584.08.015.000	NUMMERTAFELTRÄGER SCHW. LC4'98	NUMB.PLATE CARRIER BLACK LC4	1
36*	583.08.015.100	NUMMERTAFELTRÄGER SCHW. SC'99	NUMB.PLATE CARRIER BLACK SC'99	X
40*	584.14.040.050	GUMMITÜLLE FÜR KOTFLÜGEL HI.	RUBBER FOR FENDER REAR	1
52*	0016 035181	KUNSTSTOFFSCHR.KBL35X18 WN1411	PLASTIC SCREW KBL 35X18 WN1411	2
55	583.07.042.051	WIDERLAGER SCHNELLVERSCHLUSS	THRUST BEARING QUICK RELEASE	1
80*	584.12.080.000	RÜCKSTRAHLER ROT LC4 '98	REFLECTOR RED LC4 '98	1
81*	584.12.080.050	HALTERUNG FÜR RÜCKSTRAHLER	BRACKET FOR REFLECTOR	1

FIG	TEILNR/PARTNR	BEZEICHNUNG	DESCRIPTION	QTY
1*	583.08.099.144	DEKORSATZ KPL. 400/620 SC '99	DECAL SET CPL. 400/620 SC '99	1
2*	583.08.088.200	STARTNUM.FELDER GELB SC '99	STARTNUMB.PLATE YELLOW SC '99	1

1



2

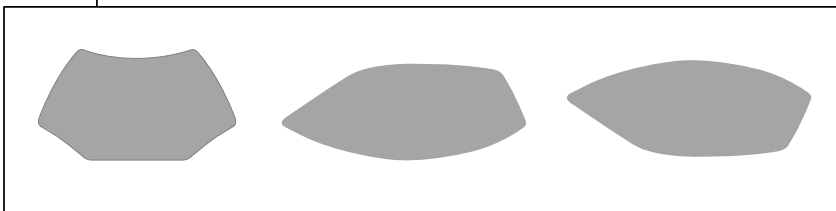

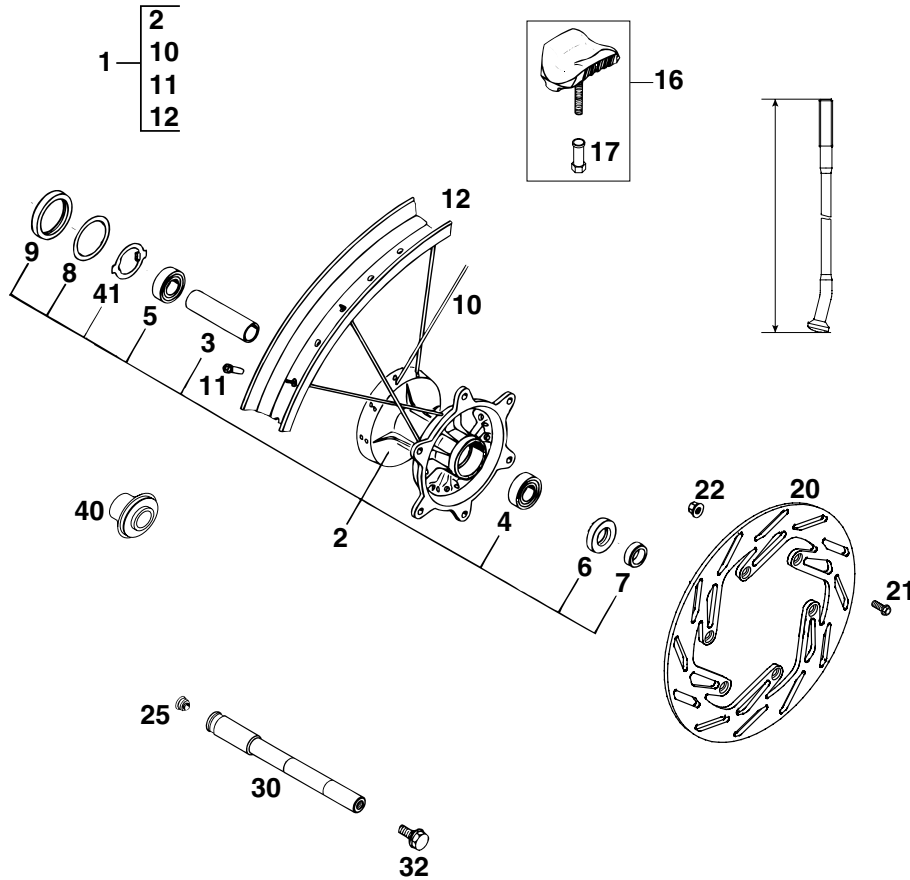

FIG	TEILNR/PARTNR	BEZEICHNUNG	DESCRIPTION	QTY
1	580.09.001.144/90	VORDERRAD 1,6X21" DID '93	FRONT WHEEL 1,6X21" DID '93	1
2	546.09.010.044/90	VORDERRADNABE KPL.SILBER GS'93	FRONT HUB CPL. SILVER GS'93	1
3	546.09.011.000	LAGERDISTANZROHR 17,5X22X64,5	BEAR.SPACER TUBE 17,5X22X64,5	1
4	0625 060037	RILLENKUGELLAGER 6003 2RSR.C3	GROOVED BALL BEAR. 6003 2SR C3	1
5	0625 062032	RILLENKUGELLAGER 6203 2RSR.C3	GROOVED BALL BEAR. 6203 2SR C3	1
6	0760 253570	WELLENDICHTRING 25X35X7 BTSL	SHAFT SEAL RING 25X35X7 BTSL	1
7	546.09.051.000	DISTANZRING 17X25X7,5	SPACER RING 17X25X7,5	1
8	581.11.054.000	SCHEIBE 40 X 52 X 0,15 '92	WASHER 40 X 52 X 0,15 '92	1
9	0760 405270	WELLENDICHTRING 40X52X7 B	SHAFT SEAL RING 40X52X7 B	1
10	583.09.071.234	SPEICHE M5X234-15G 21" DDE	SPOKE M5X234-15G 21" DDE	36
11	583.09.072.000	STAHLNIPPEL M5 VERCHROMT	STEEL NIPPLE M5 CHROME PLATED	36
12	546.09.070.200	FELGE VORNE 1,6X21" DID	FRONT RIM 1,6X21" DID	1
16	510.09.100.100	REIFENHALTER VM1 (1,60")	RIM LOCK VM1 (1,60")	1
17	503.10.090.050	MUTTER FÜR REIFENHALTER '96	NUT WHEEL HOLDER '96	1
20	565.09.060.700	BREMSSCHEIBE VORNE D=260MM	FRONT BRAKE DISK D=260MM	1
21	0015 060163	SK.BUNDSCHRAUBE M 6X16 SW=8	HH COLLAR SCREW M 6X16 WS=8	6
22	565.09.064.000	STOVER-FLANSCHMUTTER M6	SELF LOCKING NUT M6	6
25	550.09.086.000	VERSCHLUSSPFROPFEN SFL13	PLUG SFL13	1
30*	580.09.181.600	STECKACHSE VORNE L=226MM '95	WHEEL SPINDLE FRONT L=226MM'95	1
32	490.32.011.000	SK.BUNDSCHRAUBE M10X20	HH COLLAR SCREW M10X20	1
40	503.09.019.000	DISTANZBÜCHSE FÜR VORDERRAD NUR FÜR SIGMA SPORT 500	SPACER BUSHING FOR FRONT WHEEL ONLY FOR SIGMA SPORT 500	1
41	581.11.053.100	MITNEHMER FÜR TACHOANTRIEB '92	DRIVING DOG F.SPEEDOM.DRIVE'92	1

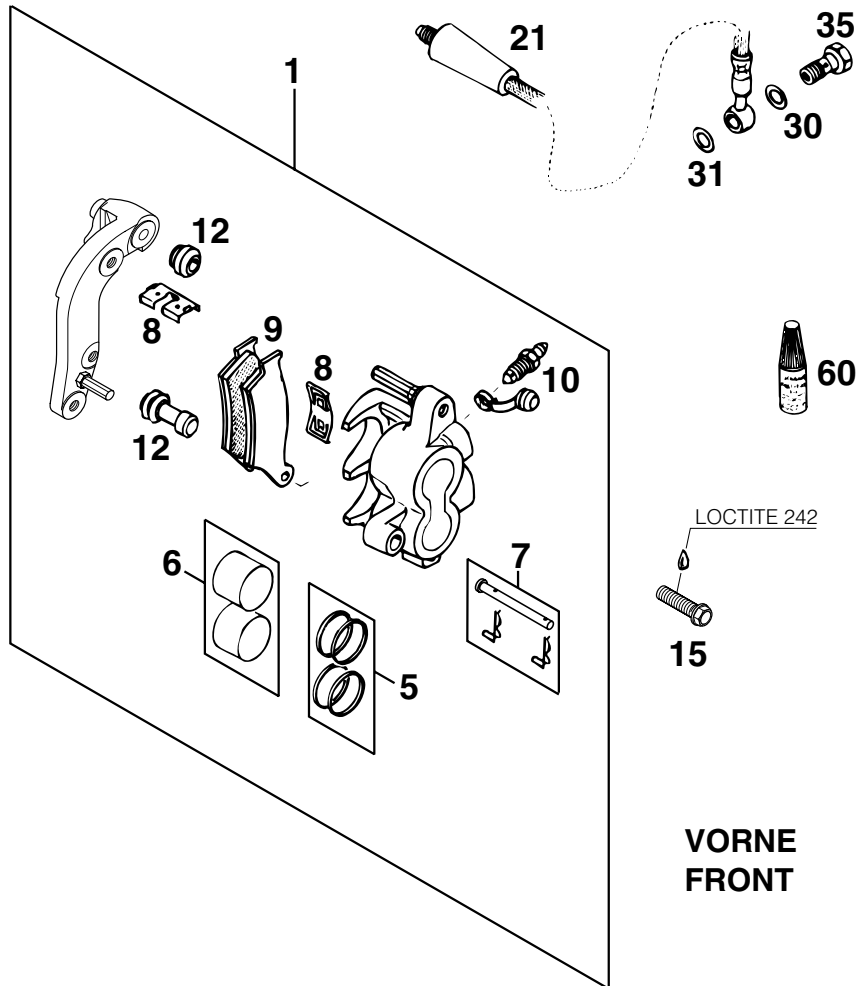

FIG	TEILNR/PARTNR	BEZEICHNUNG	DESCRIPTION	QTY
1*	590.13.015.044	BREMSZANGE VORNE KPL.BREMBO'99	BRAKE CALIPER FRONT BREMBO '99	1
5	546.13.205.000	REPARATURSATZ 28MM	REPAIR KIT 28MM	1
6	546.13.206.000	REPARATUR SATZ KOLBEN 28MM	REPAIR KIT PISTON 28MM	1
7	546.13.210.100	BOLZEN KPL. 6X56	BOLT CPL. 6X56	1
8	546.13.212.000	HALTEBLECHE GARNITUR BREMBO	RETAINING PLATE SET BREMBO	1
9*	503.13.030.000	GARN.BREMSKLÖTZE TOSHIBA H38	BRAKE PAD SET TOSHIBA H38	1
9	546.13.209.044	GARN. BREMSKLÖTZE FERODO ID450	BRAKE PAD SET FERODO ID450	X
10	545.13.214.000	ENTLÜFTUNGSSCHRAUBE M10X1	BLEEDER SCREW M10X1	1
12	546.13.218.000	MANSCHETTENSATZ	CUP SET SHORT	1
15	0015 080353	SK.BUNDSCHRAUBE M 8X35 SW=10	HH COLLAR SCREW M 8X35 WS=10	2
21*	583.13.011.100	BREMSSCHLAUCH VO.WP 1290MM '99	BRAKE HOSE FRONT WP 1290MM '99	1
30	420.13.226.000	CU-DICHTRING DIN7603-10X16X1	CU-SEAL RING DIN7603-10X16X1	2
31	420.13.026.000	CU-DICHTRING DIN7603-10X16X1,5	CU-SEAL RING DIN7603-10X16X1,5	2
35	502.13.025.000	HOHLSCHRAUBE M10X1X19	HOLLOW SCREW M10X1X19	1
60	6 899 785	LOCTITE 242 BLAU 6CCM	LOCTITE 242 BLUE 6CCM	1

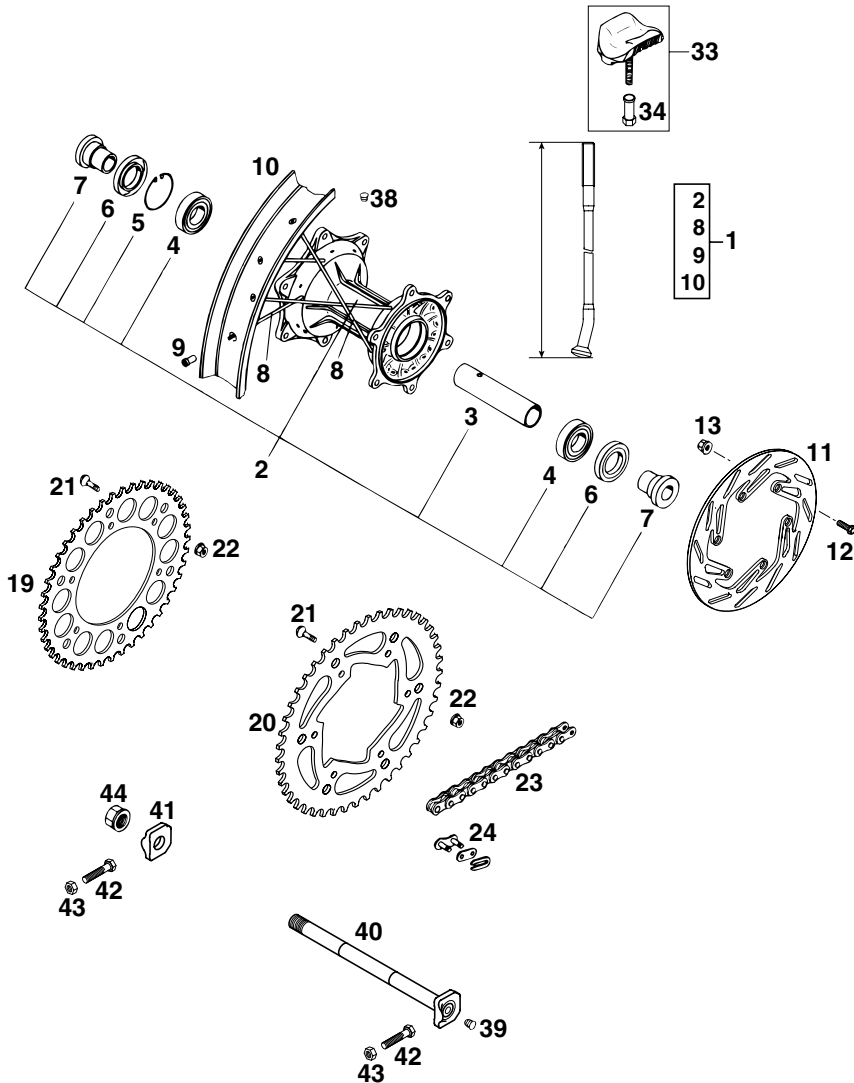

FIG	TEILNR/PARTNR	BEZEICHNUNG	DESCRIPTION	QTY
1	503.10.001.044	HINTERRAD KPL. 2.15X18" DID'98	REAR WHEEL CPL.2.15X18" DID'98	1
2	546.10.010.044/90	HINTERRADNABE KPL. SILBER	REAR WHEEL HUB CPL. SILVER	1
3	565.10.011.000	LAGERDISTANZROHR 121,5 MM	BEARING SPACER TUBE 121,5MM	1
4	0625 060058	RILLENKUGELLAGER 6005 2RSR.C3	GROOVED BALL BEAR. 6005 2RS C3	2
5	0472 047175	SICHERUNGSRING DIN0472-47X1,75	CIRCLIP DIN0472-47X1,75	1
6	0760 324771	WELLENDICHTRING 32X47X7 BSL	SHAFT SEAL RING 32X47X7 BSL	2
7	546.10.016.000	BÜCHSE FÜR NABE	BUSHING FOR HUB	2
8	583.10.071.200	SPEICHE M5X200-10G 18" DDE	SPOKE M5X200-10G 18" DDE	36
9	583.09.072.000	STAHLNIPPEL M5 VERCHROMT	STEEL NIPPLE M5 CHROME PLATED	36
10	546.10.070.300	FELGE HINTEN 2,15X18" DID	REAR RIM 2,15X18" DID	1
11	580.10.060.600	BREMSSCHEIBE 220MM ANGESENKT	REAR BRAKE DISK 220MM COUNTERS	1
12	0015 060203	SK.BUNDSCHRAUBE M 6X20 SW=8	HH COLLAR SCREW M 6X20 WS=8	6
13	565.09.064.000	STOVER-FLANSCHMUTTER M6	SELF LOCKING NUT M6	6
19	583.10.051.038	KETTENRAD 38-Z	REAR SPROCKET 38-T	X
19	583.10.151.040	KETTENRAD 40-Z	REAR SPROCKET 40-T	1
19	583.10.051.042	KETTENRAD 42-Z	REAR SPROCKET 42-T	X
19	583.10.151.045	KETTENRAD 45-Z	REAR SPROCKET 45-T	X
20	583.10.151.048	KETTENRAD 48-Z	REAR SPROCKET 48-T	1
20	583.10.151.050	KETTENRAD 50-Z	REAR SPROCKET 50-T	X
20	583.10.151.052	KETTENRAD 52-Z	REAR SPROCKET 52-T	X
21	545.10.052.000	KETTENRADSCHRAUBE-ISK M 8X29	SPROCKET SCREW-AH M 8X29	6
22	543.10.086.000	STOVERFLANSCHMUTTER M8	SELF LOCKING NUT M8	6
23	500.10.065.100	O-RING KETTE 5/8X1/4" DID 118 ROLLEN	O-RING CHAIN 5/8X1/4" DID 118 ROLLS	1
23	500.10.065.101	O-RING KETTE 5/8X1/4"PER METER	O-RING CHAIN 5/8X1/4"PER METER	X
24	500.10.066.100	KETTENSCHLOSS 5/8X1/4" O-RING	MASTER LINK 5/8X1/4" O-RING	1
33	540.10.100.100	REIFENHALTER VM3 (2.15")	RIM LOCK VM3 (2.15")	1
34	503.10.090.050	MUTTER FÜR REIFENHALTER '96	NUT WHEEL HOLDER '96	1
38	550.03.135.000	BLINDSTOPFEN FÜR FELGE	PLUG FOR RIM	X
39	502.10.086.000	ABDECKKAPPE SFL16	COVERING CAP SFL16	2
40	502.10.085.044	STECKACHSE HINTEN KPL.L=264MM	WHEEL SPINDLE REAR CPL.L=264MM	1
41	565.10.084.100	KETTENSANNER MIT BOHRUNG '95	CHAIN TENSIONER '95	1
42	502.03.030.090	SK.SCHRAUBE M8X40 A2 SW=10	HH SCREW M8X40 A2 WS=10	2
43	0934 080003	SK.MUTTER DIN0934-M 8	HEXAGON NUT DIN0934-M 8	2
44	503.10.099.000	SK-MUTTER M20X1,5 '98	HEXAGON NUT M20X1,5 '98	1

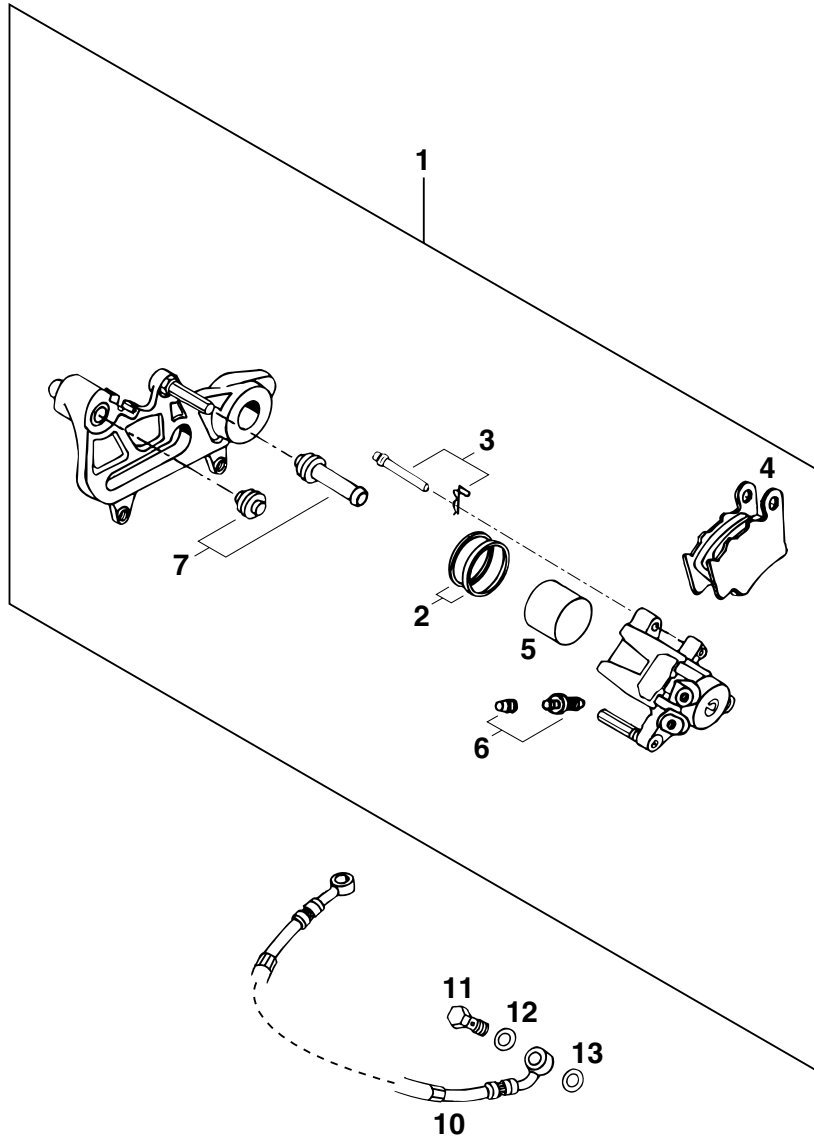

FIG	TEILNR/PARTNR	BEZEICHNUNG	DESCRIPTION	QTY
1	502.13.301.644	BREMSSATTEL KPL HINTEN LINKS	BRAKE CALIPER CPL. REAR L/S	1
2	546.13.318.200	REPARATUR SATZ DICHRINGE 34MM	REPAIR KIT SEALING RINGS 34MM	1
3	546.13.310.200	BOLZENSATZ	BOLT SET	1
4	546.13.309.200	GARN. BREMSKLÖTZE FERODO ID450	BRAKE PAD SET FERODO ID450	1
4	546.13.309.300	GARN. BREMSKLÖTZE SINTER	BRAKE PAD SET SINTER	X
5	546.13.305.200	BREMSKOLBEN 34MM	BRAKE PISTON 34MM	1
6	545.13.214.000	ENTLÜFTUNGSSCHRAUBE M10X1	BLEEDER SCREW M10X1	1
7	546.13.218.000	MANSCHETTENSATZ	CUP SET SHORT	1
10	583.13.070.000	BREMSSCHLAUCH HINTEN 790MM '97	BRAKE HOSE REAR 790MM '97	1
11	502.13.025.000	HOHLSCHRAUBE M10X1X19	HOLLOW SCREW M10X1X19	1
12	420.13.226.000	CU-DICHRING DIN7603-10X16X1	CU-SEAL RING DIN7603-10X16X1	1
13	420.13.026.000	CU-DICHRING DIN7603-10X16X1,5	CU-SEAL RING DIN7603-10X16X1,5	1

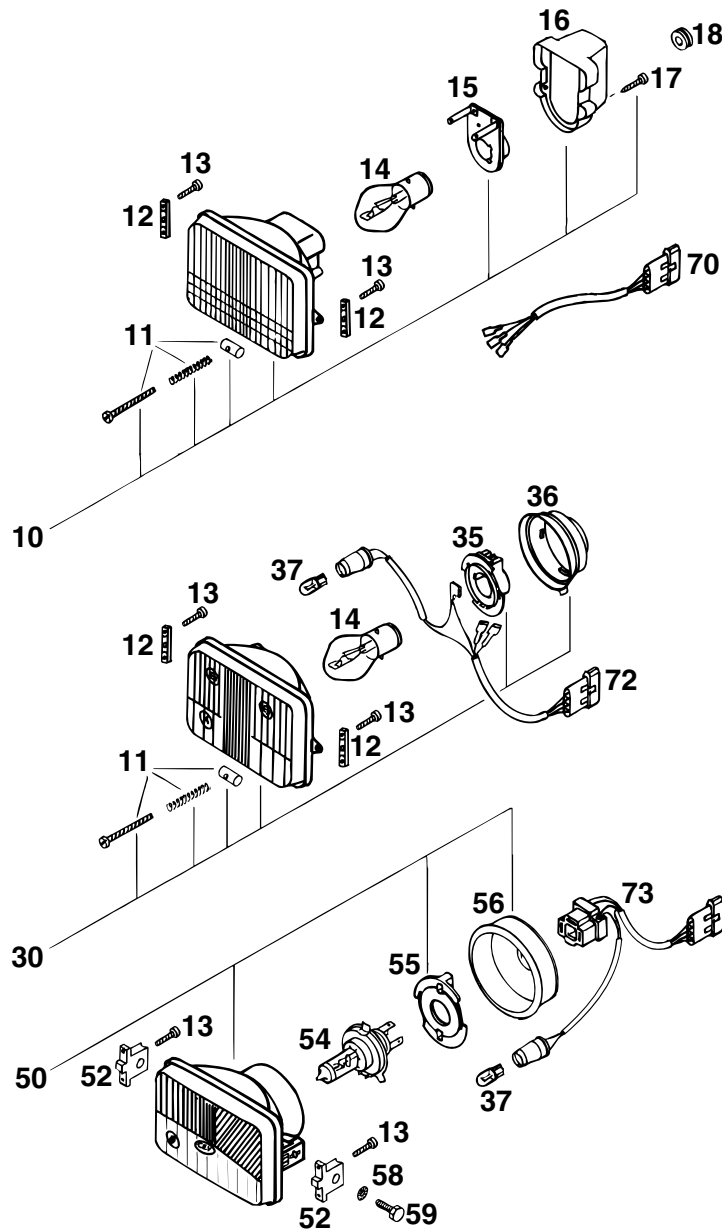

FIG	TEILNR/PARTNR	BEZEICHNUNG	DESCRIPTION	QTY
10	502.11.610.000	SCHEINWERFER KPL. ELCOM '93	HEADLIGHT CPL. ELCOM '93	1
11	502.11.631.000	STELLSCHRAUBE KPL. M4X40	ADJUSTING SCREW CPL. M4X40	1
12	502.11.410.050	SCHEINWERFERHALTERUNG '93	HEADLIGHT BRACKET '93	2
13*	0016 040183	KUNSTSTOFFSCHR. KB40X18 WN1412	PLASTIC SCREW KB40X18 WN1412	4
14	441.11.038.000	BILUX-LAMPE 12V 35/35W BA20D	BILUX-BULB 12V 35/35W BA20D	1
15	570.11.036.000	LAMPENFASSUNG	BULB SOCKET	1
16	502.11.637.000	ABDECKKAPPE	COVER CAP	1
17	0981 350133	LI.BLECHSCHR. DIN7981- 3,5X13	SHEET MET.SCR.DIN7981-3,5X13	2
18	310.08.060.000	KABELTÜLLE D=8MM OFFEN	RUBBER SLEEVE D=8MM OPEN	1
30	502.11.410.000	SCHEINWERFER KPL CEV 322 '93	HEADLIGHT CPL. CEV 322 '93	1
35	502.11.436.000	LAMPENFASSUNG	BULB SOCKET	1
36	502.11.437.000	ABDECKKAPPE	COVER CAP	1
37	490.11.435.000	LAMPE 12V 5W (W2,1X9,5D)	BULB 12V 5W (W2,1X9,5D)	1
50	502.11.510.000	SCHEINWERFER KPL. CEV 394 '93	HEADLIGHT CPL. CEV 394 '93	1
52	584.14.010.000	SCHEINWERFERHALTERUNG '98	HEAD LIGHT SUPPORT '98	2
54	571.11.038.000	LAMPE H4 12V 60/55W (P43T)	BULB H4 12V 60/55W (P43T)	1
55	490.11.436.000	LAMPENHALTER	BULB HOLDER	1
56	502.11.537.000	GUMMIKAPPE	RUBBER CAP	1
58	0797 060003	ZAHNSCHEIBE DIN6797-J 6,4	TOOTH LOCK WASH. DIN6797-A 6,4	2
59	0933 060203	SK.SCHRAUBE DIN0933-M 6X20	HH SCREW DIN0933-M 6X20	2
70	502.11.610.010	KABEL FÜR SCHEINWERFER '93	CABLE FOR HEADLIGHT '93	1
72	502.11.410.010	KABEL FÜR SCHEINWERFER '93	CABLE FOR HEADLIGHT '93	1
73	502.11.510.010	KABEL FÜR SCHEINWERFER '93	CABLE FOR HEADLIGHT '93	1

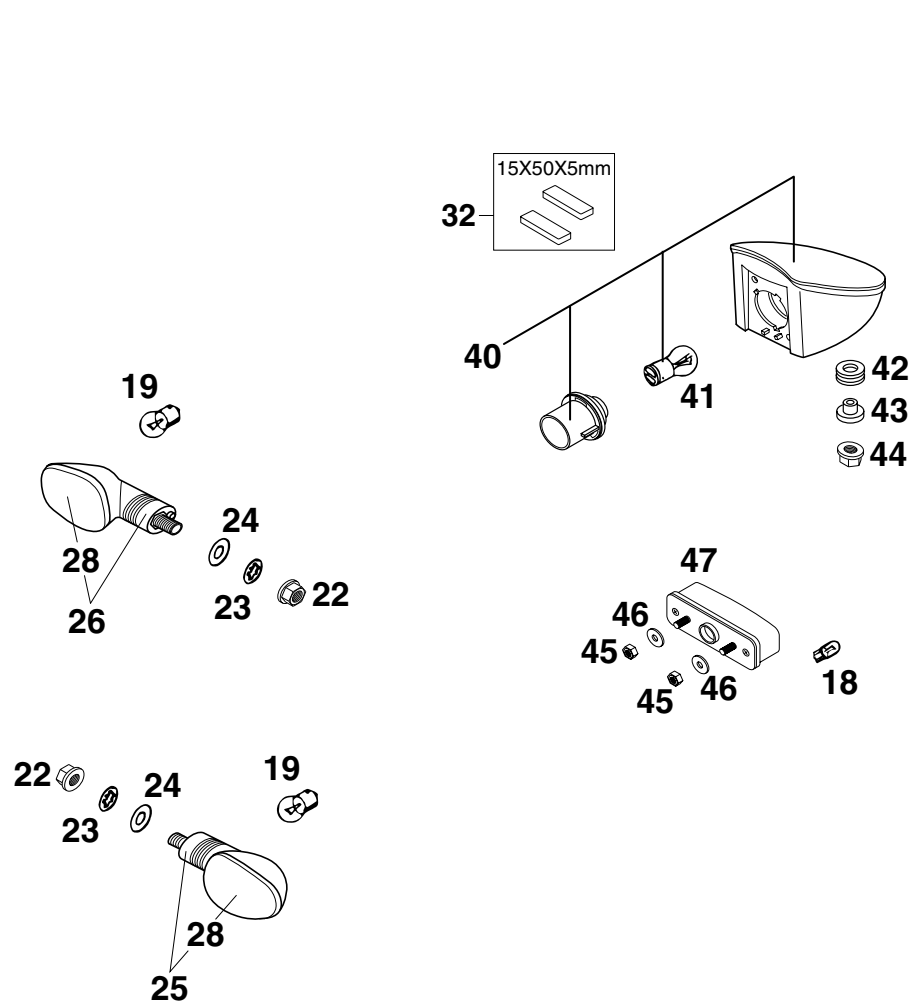

FIG	TEILNR/PARTNR	BEZEICHNUNG	DESCRIPTION	QTY
18	490.11.435.000	LAMPE 12V 5W (W2,1X9,5D)	BULB 12V 5W (W2,1X9,5D)	1
19	441.11.015.100	LAMPE 12V 10W (BA15S)	BULB 12V 10W (BA15S)	4
22	584.14.030.000	SK-BUNDMUTTER M10X1,25 SW=13	HH COLLAR NUT M10X1,25 WS=13	4
23	0797 100003	ZAHNSCHEIBE DIN6797-J10,5 ZI	LOCK WASHER DIN6797-J10,5 ZI	4
24	0125 100003	UNTERLEGSCHLEIFE DIN0125-A10,5	WASHER DIN0125-A10,5	4
25*	584.14.025.000/30	BLINKER KPL. VO.LI./HI.RE. '99 SCHWARZ	FLASHER CPL.FRONT L/S REAR R/S BLACK	2
26*	584.14.026.000/30	BLINKER KPL. VO.RE./HI.LI. '99 SCHWARZ	FLASHER CPL.FRONT R/S REAR L/S BLACK	2
28*	584.14.028.000	LEUCHTHAUBE LINKS & RECHTS '98	FLASHER LENS L/S & R/S '98	4
32*	584.11.055.150	METAMOLL F. BATTERIEHALTEBÜGEL 15MM X 50MM X 5MM	METAMOLL FOR BATTERY BRACKET 15MM X 50MM X 5MM	1
40*	584.14.040.000	RÜCKLICHT KPL. LC4 '98	REAR LIGHT CPL. LC4 '98	1
41*	584.14.042.000	LAMPE 12V 21/5W VERSTÄRKT	BULB 12V 21/5W REINFORCED	1
42	410.01.052.000	KABELTÜLLE D=12MM	RUBBER SLEEVE D=12MM	3
43	546.35.036.000	BÜCHSE	BUSHING	3
44	565.09.064.000	STOVER-FLANSCHMUTTER M6	SELF LOCKING NUT M6	3
45	0985 050003	SS.MUTTER DIN0985-M 5	SELF LOCKING NUT DIN0985-M 5	2
46	0021 050003	SCHEIBE DIN9021-A 5,3	WASHER DIN9021-A 5,3	2
47*	584.14.047.000	KENNZEICHENBELEUCHTUNG LC4 '98	LICENSE-PLATE ILLUMINATION '98	1

FIG	TEILNR/PARTNR	BEZEICHNUNG	DESCRIPTION	QTY
01*	503.14.065.244	TACHOGEHÄUSE KPL. EXC GED. '99	SPEEDOMETER CASE CPL. EXC '99	1
2*	503.14.060.000	TACHOHALTERUNG EXC SCHWARZ '99	SPEEDOMET.BRACKET EXC BLACK'99	1
3*	503.14.061.100	TACHOHALTERUNG EGS SCHWARZ '99	SPEEDOMET.BRACKET EGS BLACK'99	1
4	0016 050121	KUNSTSTOFFSCHR. KA50X12 PT1411 SCHWARZ	PLASTIC SCREW KA50X12 PT1411 BLACK	2
5	310.08.060.000	KABELTÜLLE D=8MM OFFEN	RUBBER SLEEVE D=8MM OPEN	2
6*	503.14.069.044	TACHO SIGMA SPORT 500 KPL. '99	SPEEDOM.SIGMASPORT 500 CPL.'99	1
7	583.14.069.151	GEBERKABEL FÜR SIGMA 500 '98	CABLE FOR SIGMA 500 '98	1
8	550.11.022.100	ABSTANDHALTER D=6/8MM,SCHW.	CLAMP 6/8MM BLACK	3
9*	491.11.425.000	LAMPE 12V 1,2W W2X4,6D	BULB 12V 1,2W (W2X4,6D)	2
10	0963 040203	SENKSCHRAUBE DIN0963-M 4X20	FLAT HEAD SCREW DIN0963-M 4X20	1
11	583.14.069.050	MAGNET LOSE '97	MAGNET LOOSE '97	1
12	502.32.050.001	STAHLSCHEIBE 6X17X3	STEEL WASHER 6X17X3	1
13	583.12.099.073	HALTEBLECH F. TRIPPMASTERGEBER	BRACKET FOR TRIPPMASTER SENSOR	1
14	0985 040003	SS.MUTTER DIN0985-M 4	SELF LOCKING NUT DIN0985-M 4	1
15*	580.11.021.300	FERNLICHTKONTROLLEU. BLAU '98	H.BEAM INDICATOR LIGHT BLUE'98	1
16*	580.11.024.300	BLINKERKONTROLLEUCHTE GRÜN '98	FLASHER INDICAT.LIGHT GREEN'98	1
17	0014 060103	SK.BUNDSCHRAUBE M 6X10 SW=8	HH COLLAR SCREW M 6X10 WS=8	2

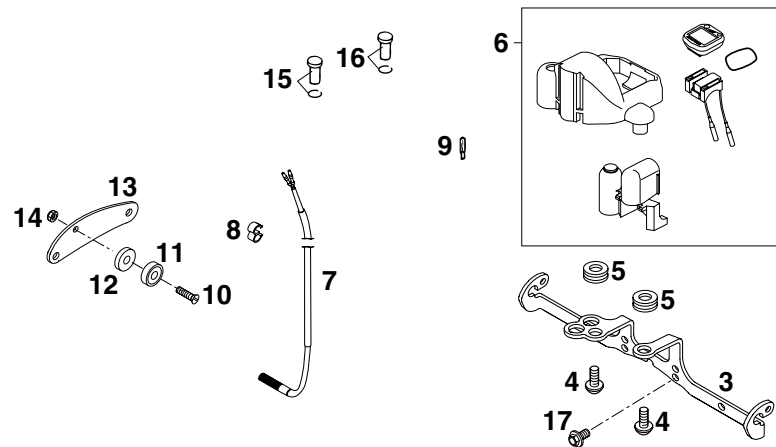
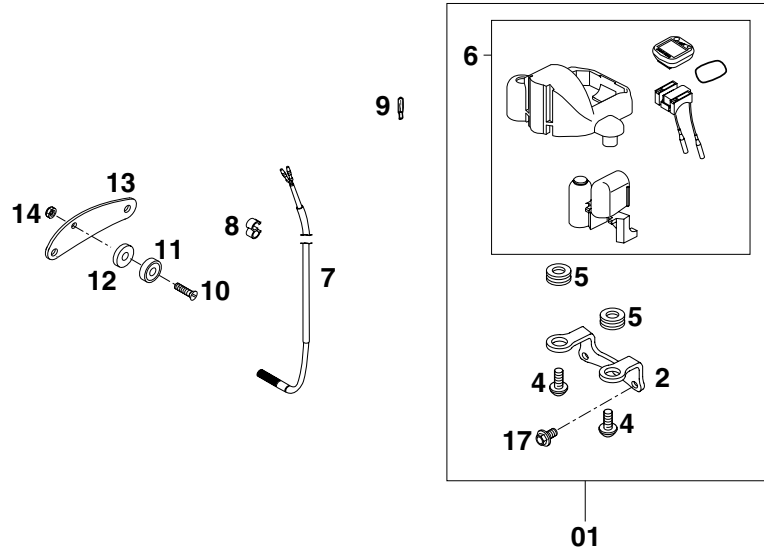
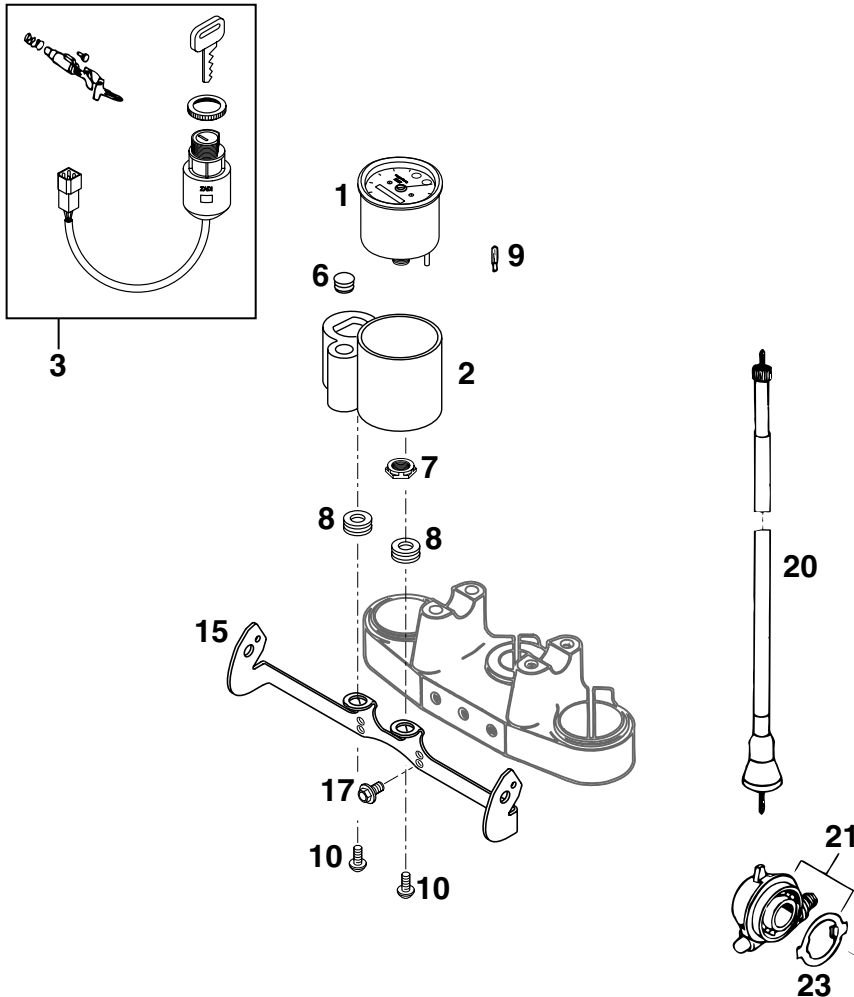

FIG	TEILNR/PARTNR	BEZEICHNUNG	DESCRIPTION	QTY
1*	503.14.057.000	TACHOMETER FACOMSA 180 KM/H '99	SPEEDOMETER FACOMSA 180 KM/H '99	1
2*	503.14.065.100	TACHOGEHÄUSE 125-380 EGS '99	SPEEDOMETER CASE 125-380 EGS '99	1
3*	503.11.065.000	ZÜND-UND LENKSCHLOSS KPL. ZADI	IGNITION LOCK CPL. ZADI '99	1
6	502.10.086.000	ABDECKKAPPE SFL16	COVERING CAP SFL16	1
7*	503.14.057.050	MUTTER FÜR TACHOMET. M12 SW=17	NUT FOR SPEEDOM. M12 SW=17	1
8	310.08.060.000	KABELTÜLLE D=8MM OFFEN	RUBBER SLEEVE D=8MM OPEN	2
9*	491.11.425.000	LAMPE 12V 1,2W W2X4,6D	BULB 12V 1,2W (W2X4,6D)	3
10*	0016 050121	KUNSTSTOFFSCHR. KA50X12 PT1411 SCHWARZ	PLASTIC SCREW KA50X12 PT1411 BLACK	2
15*	503.14.061.000	TACHOHALTERUNG 125-380 EGS '99	SPEEDOM.BRACKET 125-380 EGS '99	1
17	0014 060103	SK.BUNDSCHRAUBE M 6X10 SW=8	HH COLLAR SCREW M 6X10 WS=8	2
20*	584.14.055.200	TACHOWELLE M12/M12 960MM '99	SPEEDOM.CABLE M12/M12 960MM '99	1
21	581.11.052.100	TACHOANTRIEB 748217 (3,0)	SPEEDOMETER DRIVE 748217 (3,0)	1
23	581.11.053.100	MITNEHMER FÜR TACHOANTRIEB '92	DRIVING DOG F.SPEEDOM.DRIVE '92	1



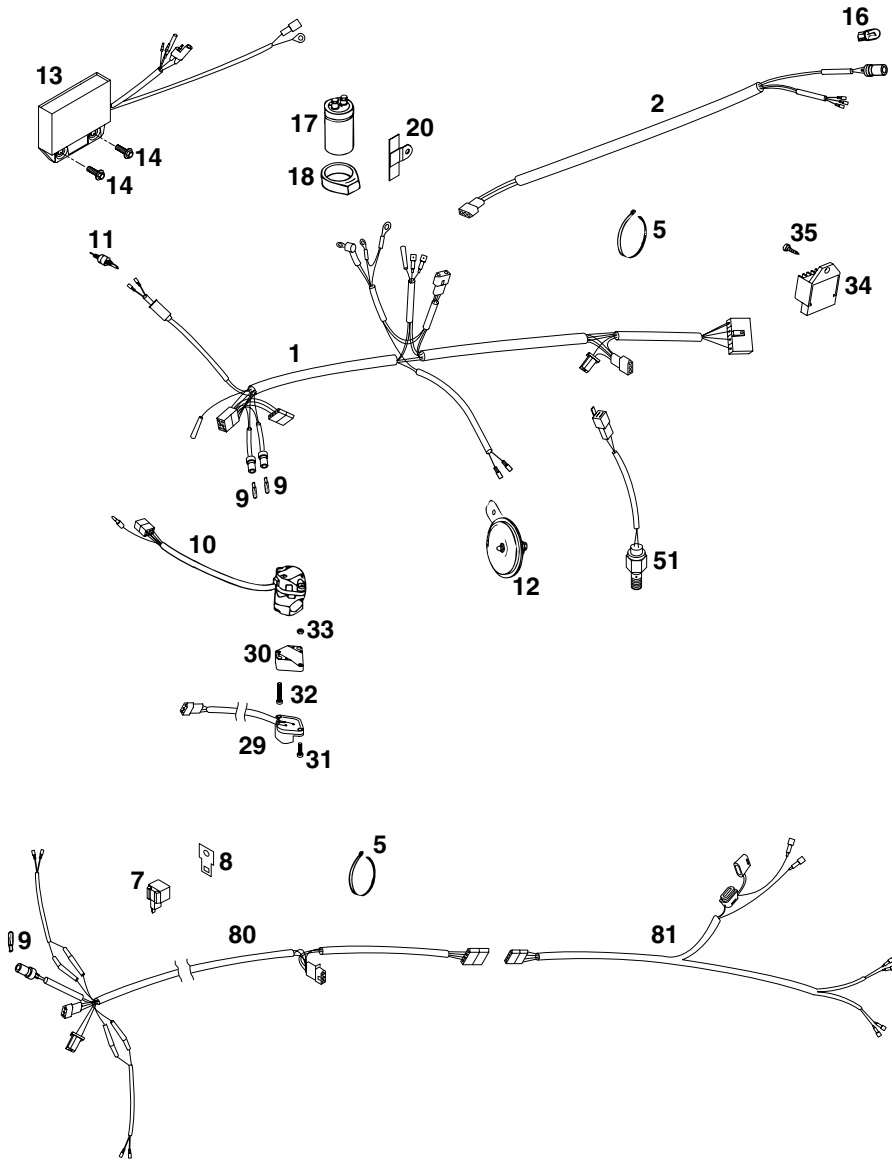

FIG	TEILNR/PARTNR	BEZEICHNUNG	DESCRIPTION	QTY
1*	583.11.375.100	HAUPTKABELSTRANG 400/620 SC'99	MAIN WIRING HARNESS SC '99	1
2*	583.11.176.200	KABELSTRANG HINTEN SC '99	WIRING HARNESS REAR SC '99	1
5	440.11.076.100	KABELBAND 100MM	CABLE TIE 100MM	X
-	440.11.076.200	KABELBAND 200MM	CABLE TIE 200MM	X
-	440.11.176.305	KABELBAND 305MM	CABLE TIE 305MM	X
7	446.11.207.200	BLINKGEBER SUMITOMO ADV.'97	FLASHER UNIT SUMITOMO ADV.'97	1
8	582.11.031.100	HALTEBLECH FÜR BLINKRELAIS	BRACKET FOR FLASHER RELAIS	1
9	491.11.425.000	LAMPE 12V 1,2W W2X4,6D	BULB 12V 1,2W (W2X4,6D)	3
10	503.11.070.000	LICHTSCHALTER CEV 2/4TAKT '98 SYMBOLE WEISS	H.LIGHT SWITCH CEV 2/4TAKT '98 SYMBOLS WHITE	1
11	510.11.050.000	BREMSLICHTSCHALTER VORNE	FRONT BRAKE LIGHT SWITCH	1
12	545.11.060.100	GLEICHSTROMHORN 12V NIKKO	DC HORN 12V NIKKO	1
13*	583.39.031.000	DIGITALBOX CDI CU7437 SC'99	DIGITAL BOX CDI CU7437 SC'99	1
14	0014 060203	SK.BUNDSCHRAUBE M 6X20 SW=8	HH COLLAR SCREW M 6X20 WS=8	2
16	490.11.435.000	LAMPE 12V 5W (W2,1X9,5D)	BULB 12V 5W (W2,1X9,5D)	1
17	491.11.435.100	KONDENSATOR 25VOLT, 10.000 MF	CONDENSATOR 25V, 10.000 MF	1
18	545.11.048.000	KONDENSATORAUFNAHME	CAPACITOR BRACKET	1
20	546.11.448.000	HALTERUNG FÜR KONDENSATOR	BRACKET FOR CAPACITOR	1
29	503.11.029.000	BLINKERSCHALTER CEV '98	FLASHER SWITCH CEV '98	1
30	130.11.070.060	ADAPTER FÜR BLINKERSCHALTER'98	ADAPTER FOR FLASHER SWITCH '98	1
31	0985 040163	LINSENSCHRAUBE DIN7985-M 4X16	FLAT HEAD SCREW DIN7985-M 4X16	2
32	0084 040223	ZYL.SCHRAUBE DIN0084-M 4X22 A	CYL.HEAD SCREW DIN0084-M 4X22A	2
33	0934 040003	SK.MUTTER DIN0934-M 4	HEXAGON NUT DIN0934-M 4	2
34*	503.11.034.000	SPANNUNGSREGLER 12V 125-200'98	VOLTAGE REGULA. 12V 125-200'98	1
35	0017 060203	SONDERSCHRAUBE T60 M 6X20	SPECIAL SCREW T60 M 6X20	1
51	503.11.051.100	BREMSLICHTSCHALTER HINTEN '98	BRAKE LIGHT SWITCH REAR '98	1
80*	503.11.080.100	BLINKERKABELSTR.VO.125-380 '99	FLAS.WIRINGHARN. FRONT 125-380	1
81	503.11.081.000	BLINKERKABELSTR.HI.125-380 '98	FLAS.WIRINGHARN. REAR 125-380	1

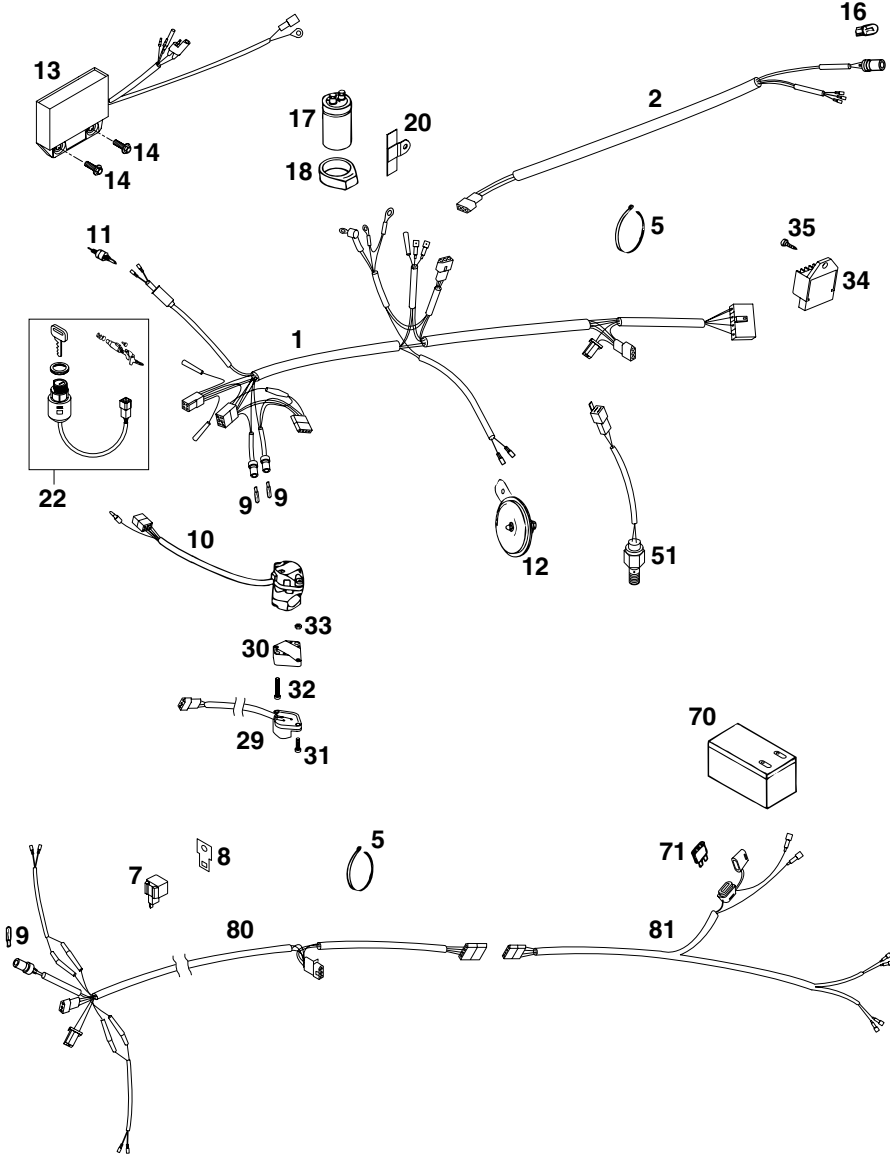

FIG	TEILNR/PARTNR	BEZEICHNUNG	DESCRIPTION	QTY
1*	583.11.375.000	HAUPTKABELSTRANG SC AUS '99	MAIN WIRING HARNESS SC AUS '99	1
2*	583.11.176.200	KABELSTRANG HINTEN SC '99	WIRING HARNESS REAR SC '99	1
5	440.11.076.100	KABELBAND 100MM	CABLE TIE 100MM	X
-	440.11.076.200	KABELBAND 200MM	CABLE TIE 200MM	X
-	440.11.176.305	KABELBAND 305MM	CABLE TIE 305MM	X
7	446.11.207.200	BLINKGEBER SUMITOMO ADV.'97	FLASHER UNIT SUMITOMO ADV.'97	1
8	582.11.031.100	HALTEBLECH FÜR BLINKRELAIS	BRACKET FOR FLASHER RELAY	1
9	491.11.425.000	LAMPE 12V 1,2W W2X4,6D	BULB 12V 1,2W (W2X4,6D)	3
10	503.11.070.100	LICHTSCHALTER CEV EGS AUS. '98 SYMBOLE GELB	H.LIGHT SWITCH CEV EGS AUS. '98 SYMBOLS YELLOW	1
11	510.11.050.000	BREMSLICHTSCHALTER VORNE	FRONT BRAKE LIGHT SWITCH	1
12	545.11.060.100	GLEICHSTROMHORN 12V NIKKO	DC HORN 12V NIKKO	1
13*	583.39.031.000	DIGITALBOX CDI CU7437 SC'99	DIGITAL BOX CDI CU7437 SC'99	1
14	0014 060203	SK.BUNDSCHRAUBE M 6X20 SW=8	HH COLLAR SCREW M 6X20 WS=8	2
16	490.11.435.000	LAMPE 12V 5W (W2,1X9,5D)	BULB 12V 5W (W2,1X9,5D)	2
17	491.11.435.100	KONDENSATOR 25VOLT, 10.000 MF	CONDENSATOR 25V, 10.000 MF	1
18	545.11.048.000	KONDENSATORAUFNAHME	CAPACITOR BRACKET	1
20	546.11.448.000	HALTERUNG FÜR KONDENSATOR	BRACKET FOR CAPACITOR	1
22*	503.11.065.000	ZÜND-UND LENKSCHLOSS KPL. ZADI '99	IGNITION LOCK CPL. ZADI '99	1
29	503.11.029.000	BLINKERSCHALTER CEV '98	FLASHER SWITCH CEV '98	1
30	130.11.070.060	ADAPTER FÜR BLINKERSCHALTER'98	ADAPTER FOR FLASHER SWITCH '98	1
31	0985 040163	LINSENSCHRAUBE DIN7985-M 4X16	FLAT HEAD SCREW DIN7985-M 4X16	2
32	0084 040223	ZYL.SCHRAUBE DIN0084-M 4X22 A	CYL.HEAD SCREW DIN0084-M 4X22A	2
33	0934 040003	SK.MUTTER DIN0934-M 4	HEXAGON NUT DIN0934-M 4	2
34*	503.11.034.000	SPANNUNGSREGLER 12V 125-200'98	VOLTAGE REGULA. 12V 125-200'98	1
35	0017 060203	SONDERSCHRAUBE T60 M 6X20	SPECIAL SCREW T60 M 6X20	1
51	503.11.051.100	BREMSLICHTSCHALTER HINTEN '98	BRAKE LIGHT SWITCH REAR '98	1
70	545.11.008.000	BATTERIE 12V 1,2AH	BATTERY 12V 1,2AH	X
71	580.11.109.010	STECKSICHERUNG 10 A	FUSE 10 A	X
80*	503.11.080.100	BLINKERKABELSTR.VO.125-380 '99	FLAS.WIRINGHARN. FRONT 125-380	1
81	503.11.081.000	BLINKERKABELSTR.HI.125-380 '98	FLAS.WIRINGHARN. REAR 125-380	1

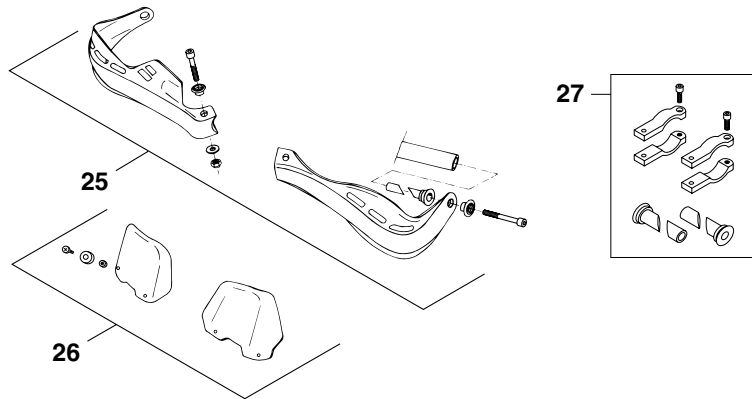
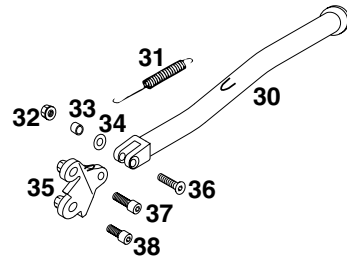
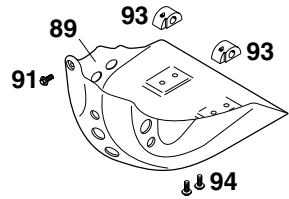
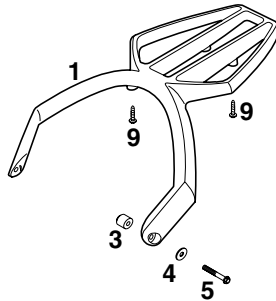

FIG	TEILNR/PARTNR	BEZEICHNUNG	DESCRIPTION	QTY
1*	584.12.010.100/90	GEPÄCKTRÄGER SILBER LC4 '98	BAGGAGE CARRIER SILVER LC4 '98	1
3*	584.12.011.000	BÜCHSE GEPÄCKTRÄGER 6X16X17,5	BUSH BAGGAGE CARRIER 6X16X17,5	2
4	502.32.050.000	STAHLSCHEIBE 6,2 X 18 X 2	WASHER 6,2 X 18 X 2	2
5	0015 060353	SK.BUNDSCHRAUBE M 6X35 SW=8	HH COLLAR SCREW M 6X35 WS=8	2
9	0017 060303	SONDERSCHRAUBE T60 M 6X30	SPECIAL SCREW T60 M 6X30	4
25	502.02.079.044/30	HANDSCHUTZ LI.&RE.KPL. SCHWARZ	HAND GUARD CPL.L+R/S BLACK	1
26	502.02.079.050/30	WINDSCHUTZ LI.&RE.KPL. SCHWARZ	SCREEN CPL.L+R/S BLACK	1
27	502.02.079.051	BEFESTIGUNGSKIT HANDSCHUTZ KPL.	FASTENING KIT HAND GUARDS CPL.	1
30*	583.03.023.200/90	SEITENST.SILBER L=381MM SXC'99	SIDESTAND SILVER L=381MM '99	1
31	510.03.021.000	STÄNDERFEDER LANG	SIDESTAND SPRING LONG	1
32	543.10.086.000	STOVERFLANSCHMUTTER M8	SELF LOCKING NUT M8	1
33	571.03.225.000	BÜCHSE 8,2 X 12 X 10	BUSHING 8,2 X 12 X 10	1
34	546.03.025.000	SCHEIBE 12,5 X 25 X 1,5	WASHER 12,5 X 25 X 1,5	1
35	583.03.026.250	SEITENSTÄNDERKONSOLE '97	SIDE STAND BRACKET '97	1
36	0991 080353	SENKSCHRAUBE DIN7991-M 8X35	FLAT HEAD SCREW DIN7991-M 8X35	1
37	0912 100303	ISK.SCHRAUBE DIN0912-M10X30	AH SCREW DIN0912-M10X30	1
38	0912 100256	ISK.SCHRAUBE DIN0912-M10X25	AH SCREW DIN0912-M10X25	1
89	583.03.005.144	MOTORSCHUTZ KPL. KUNSTSTOFF'97	ENG. PROTECTOR CPL. PLASTIC'97	1
91	0014 060103	SK.BUNDSCHRAUBE M 6X10 SW=8	HH COLLAR SCREW M 6X10 WS=8	1
93	580.03.012.200	MOTORSCHUTZHALTERUNG RE. '97	ENGINE PROTECTOR BRACKET '97	2
94	0014 060153	SK.BUNDSCHRAUBE M 6X15 SW=8	HH COLLAR SCREW M 6X15 WS=8	4

TECHNISCHE DATEN - FAHRGESTELL 400 / 620 SC '99

	400 SC	620 SC
Rahmen	Zentralrohrrahmen aus Chrom-Molybdän-Stahlrohren	
Gabel	White Power – Up Side Down 43	
Federweg vorne/hinten	295 / 320 mm	
Hinterradfederung	Zentralfederbein (WP) mit PRO-LEVER-Anlenkung zur nadelgelagerten Alu-Hinterradschwinge	
Bremse vorne	Scheibenbremse mit gelochter Brems Scheibe Ø 260 mm, Bremsattel schwimmend gelagert	
Bremse hinten	Scheibenbremse mit gelochter Brems Scheibe Ø 220 mm, Bremsattel schwimmend gelagert	
Bereifung vorne	90/90-21 54R	
Luftdruck Gelände	1,0 bar	
Luftdruck Straße solo	1,5 bar	
Bereifung hinten	140/80-18 70R	
Luftdruck Gelände	1,2 bar	
Luftdruck Straße solo	2,0 bar	
Tankinhalt	9 Liter, davon 2,5 Liter Reserve	
Übersetzung-Hinterrad	16:48 (14:50)	16:40 (15:50)
Kette	5/8 x 1/4" O-Ring	
Steuerkopfwinkel	62,5°	
Radstand	1510 ± 10 mm	
Sitzhöhe unbelastet	940 mm	
Bodenfreiheit unbelastet	375 mm	
Trockengewicht	122 kg	

STANDARD-EINSTELLUNG – GABEL	
	05.18.17.81
Druckstufendämpfung	10
Zugstufendämpfung	12
Feder	4,2 N/mm
Federvorspannung	6 mm
Luftkammerlänge	130 mm
Füllmenge pro Gabelholm	ca 700 ccm
Gabelöl	SAE5

STANDARD-EINSTELLUNG – FEDERBEIN	
	01.18.17.05
Druckstufendämpfung	3
Zugstufendämpfung	5
Feder	63 / 260
Federvorspannung	23 mm

HINWEIS FÜR WHITE POWER GABELN:

Die Dämpfungseinheiten im linken und im rechten Gabelbein sind nicht gleich ausgeführt. Vertauschen Sie bei Reparaturen oder Servicearbeiten diese Teile nicht.

ANZUGSDREHMOMENTE			
Bundschraube Steckachse vorne	M10		40 Nm
Bremszange vorne	M8	Loctite 242 + 25 Nm	
Bundmutter Steckachse hinten	M20x1,5		80 Nm
Sechskantmutter Schwingarmbolzen	M14x1,5		100 Nm
Klemmschrauben Gabelbrücke oben	M8		23 Nm
Klemmschrauben Gabelbrücke unten	M8		18 Nm
Klemmschrauben Gabelfüaste	M8		10 Nm
Bundschraube Lenkerklemmbrücke	M8		20 Nm
Imensechskantschraube Lenkeraufnahme	M10		40 Nm
Restliche Schrauben Fahrgestell	M6		10 Nm
	M8		25 Nm
	M10		45 Nm

TECHNICAL SPECIFICATIONS - CHASSIS 400 / 620 SC '99

	400 SC	620 SC
Frame	Central chrome-moly-steel frame	
Fork	White Power – Up Side Down 43	
Wheel travel front/rear	295 / 320 mm (11,6 / 12,6 in)	
Rear suspension	Central shock absorber (WP) with PRO-LEVER linkage to rear-swingarm with needle bearing	
Front brake	Disc brake with carbon-steel brake disc Ø 260 mm (10,2 in), brake caliper floated	
Rear brake	Disc brake with carbon-steel brake disc Ø 220 mm (8,7 in), brake caliper floated	
Tyres front	90/90-21 54R	
Air pressure offroad	1,0 bar (14 psi)	
Air press. road, driver only	1,5 bar (21 psi)	
Tyres rear	140/80-18 70R	
Air pressure offroad	1,2 bar (17 psi)	
Air press. road, driver only	2,0 bar (28 psi)	
Fuel tank capacity	9 liter (2,38 US gallons) of that 2,5 liter (0,66 US gallons) reserve	
Final drive ratio	16:48 (14:50)	16:40 (15:50)
Chain	5/8 x 1/4 " O-Ring	
Steering angle	62,5°	
Wheel base	1510 ± 10 mm (59,4 ± 0,4 in)	
Seat high	940 mm (37 in)	
Ground clearance	375 mm (14,8 in)	
Dead weight without fuel	122 kg (269 lbs)	

STANDARD ADJUSTMENT - FORK	
	05.18.T7.81
Compression adjuster	10
Rebound adjuster	12
Spring	4,2 N/mm
Spring preload	6 mm (0,24 in)
Air chamber length	130 mm (5,1 in)
Capacity per fork leg	ca 700 ccm
Fork oil	SAE5

STANDARD-ADJUSTMENT - SHOCK ABSORBER	
	01.18.T7.05
Compression adjuster	3
Rebound adjuster	5
Spring	63 / 260
Spring preload	23 mm (0,9 in)

NOTE FOR WHITE POWER FORKS:
The damping units in the left and the right fork leg are of different design.
Make sure not to mix them up in case of repair or service works.

TORQUES			
Collar screw front axle	M10	40 Nm	(30 ft.lb)
Brake caliper front	M8	Loctite 242 + 25 Nm	(18 ft.lb)
Collar nut rear axle	M20x1,5	80 Nm	(59 ft.lb)
Hex. nut swing arm bolt	M14x1,5	100 Nm	(74 ft.lb)
Clamping screw top triple clamp	M8	23 Nm	(17 ft.lb)
Clamping screw bottom triple clamp	M8	18 Nm	(13 ft.lb)
Clamping screws fork leg axle passage	M8	10 Nm	(7 ft.lb)
Collar screw handlebar clamp	M8	20 Nm	(15 ft.lb)
Allan head screw handlebar support	M10	40 Nm	(30 ft.lb)
Other screws chassis	M6	10 Nm	(7 ft.lb)
	M8	25 Nm	(18 ft.lb)
	M10	45 Nm	(33 ft.lb)

SCHMIER- UND WARTUNGSTABELLE



2 99
620 SX
400/540 SXC
400/620 SC

**BEI SPORTEINSATZ IST DER 5000 KM SERVICE
NACH JEDEM RENNEN DURCHZUFÜHREN**

	KTM Fahrer	KTM Fachwerkstätte		
Motorölstand kontrollieren	● vor jeder Inbetriebnahme			
Motoröl wechseln		● ●	● ●	● ●
Ölsieb und Magneten der Ablassschrauben bei Motorölwechsel reinigen		● ●	● ●	● ●
Ölfiltersatz wechseln			●	● ●
Mikrofilter wechseln				● ●
Ölleitungen auf Beschädigungen und auf knickfreie Verlegung prüfen		● ●		● ●
Ventilspiel kontrollieren				● ●
Zündkerze reinigen und Elektrodenabstand einstellen				● ●
Zündkerze nach 10 000 km wechseln				● ●
Zündzeitpunkt prüfen				● ●
Schwimmerkammer des Vergasers entleeren und reinigen		●		● ●
Leerlauf einstellen				● ●
Schläuche von Motor- und Tankentlüftung auf knickfreie Verlegung prüfen		●	●	● ●
Luftfilter und Filterkasten reinigen		●		● ●
Kettenräder, Kettenführungen und Kette prüfen	● ●	● ●	● ●	● ●
Kette reinigen und ölen	● ●	● ●	● ●	● ●
Kettenspannung prüfen	● ●	● ●	● ●	● ●
Kühlfülligkeitsstand prüfen	● ●	● ●	● ●	● ●
Frostschutz prüfen				● ●
Kühlsystem auf Dichtheit prüfen - Sichtprüfung	● ●	● ●	● ●	● ●
Auspuffanlage auf Dichtheit prüfen				● ●
Glasfasergerm-Füllung des Schalldämpfers erneuern (Alu-Enddämpfer)			●	● ●
Aufhängungen der Auspuffanlage prüfen		● ●		● ●
Bremsschleifensstand in den Vorratsbehältern prüfen	● ●	● ●		● ●
Bremsschleifigkeit wechseln				● ●
Belagstärke der Bremsklötze prüfen	● ●			● ●
Bremscheiben prüfen				● ●
Zustand und Verlegung der Bremsschläuche prüfen	● ●	● ●		● ●
Leervorgang und Leichtigkeit des Handbremshebels und des Fußbremshebels prüfen	● ●	● ●		● ●
Einstellung und Dämpfung der Telegabel prüfen	● ●			● ●
Telegabel auf Dichtheit prüfen				● ●
Entlüftungsschrauben an den Gabelbeinen lösen (Überdruck)				● ●
Öl der Telegabel wechseln				● ●
Telegabel vollständig warten				● ●
Staubmanschetten der Telegabel reinigen		●		● ●
Steuerkopflager auf Spiel prüfen / einstellen			●	● ●
Steuerkopflager und deren Dichtungselemente reinigen und fetten	● ●			● ●
Einstellung und Dämpfung des Federbeines prüfen				● ●
O-Ring des Federbeines auf Verschleiß prüfen				● ●
Federbein vollständig warten				● ●
Schmiernipfel am Winkelhebel des Pro Lever Federungssystems schmieren				● ●
Anlenkung des Pro Lever Federungssystems zerlegen und warten				● ●
Schwingarmlagerung warten				● ●
Speicherspannung und Felgenschlag prüfen	● ●	● ●		● ●
Radlager auf Spiel prüfen	● ●			● ●
Reifenzustand und Reifenluftdruck prüfen	● ●			● ●
Seitzüge auf Beschädigungen und Leichtigkeit prüfen	● ●			● ●
Seitzüge einstellen und ölen	● ●	● ●		● ●
Elektrische Anlage prüfen	● ●	● ●		● ●
Scheinwerferreinigung prüfen				● ●
Zündschloß, Not-Aus Schalter, Kurzschlußtaster und Lichtschalter mit Kontaktspray behandeln	● ●	● ●		● ●
Alle Schrauben, Muttern und Schlauchklappen auf festen Sitz prüfen	● ●	● ●		● ●
Alle Gleit- und Lagerstellen ölen bzw. fetten	● ●	● ●		● ●

PERIODIC MAINTENANCE SCHEDULE



2,99
620 SX
400/540 SX
400/620 SC

IF THE MOTORCYCLE IS USED PRIMARILY FOR OFF ROAD RIDING OR COMPETITIVE RACING, THE 5000 KM (3000 MILES) SERVICE NEEDS TO BE CARRIED OUT AFTER EACH RIDE OR RACE

	before each start	after washing	1st service, after 1000 km (600 miles) or 10 hours	after 2500 km (1500 miles) or 25 hours	after 5000 km (3000 miles) or once a year	at least once a year
Check engine oil level	●		●	●		●
Change engine oil			●	●		●
Clean oil screen and magnet of the drain plugs whenever you exchange the engine oil			●	●		●
Change oil filter unit			●	●		●
Change microfilter				●		●
Check oil lines for leakage and proper instalment			●			●
Check valve clearance			●			●
Clean spark plug and adjust electrode gap						●
Change spark plug after 10 000 kilometers (6 200 miles)						●
Check valve clearance						●
Drain and clean carburator float bowl		●				●
Adjust idling						●
Check breather hoses of engine gase and gas tank for correct position without buckles			●			●
Clean air filter and air filter box		●				●
Check sprockets, chain guides and chain for wear			●			●
Clean and lube chain		●				●
Check chain tension			●			●
Check cooling liquid level			●			●
Check quality of antifreeze						●
Check cooling system for leaks			●			●
Check exhaust system for leaks						●
Check exhaust system for leakage						●
Change exhaust muffler packing (aluminium-muffler)				●		●
Check exhaust brackets			●			●
Disassemble and clean spark arrestor discs (USA models)			●			●
Check brake fluid level front and rear			●			●
Change brake fluid						●
Check brake pad thickness			●			●
Check brake discs						●
Check condition and correct instalment of brake hoses			●			●
Check freeplay and easy operation of hand brake lever and foot brake lever			●			●
Check adjustment and function of fork			●			●
Check fork for leaks						●
Loosen breather screws at fork legs (overpressure)						●
Change fork oil						●
Perform a full maintenance job for the telescopic fork						●
Clean dust scrubber on forks		●				●
Check steering head bearing clearance / adjust			●			●
Clean and grease steering head bearings and its seals						●
Check adjustment and funktion of shock absorber	●					●
Check O-ring of the shock absorber for wear						●
Servicing the shock absorber						●
Grease lubricating nipple of the Pro Lever suspension system						●
Disassemble the Pro Lever suspension system and perform a full maintenance job on it						●
Servicing swingarm pivots						●
Check tightness of spokes and rim join			●			●
Check wheel bearings for clearance			●			●
Check tire condition and air pressure			●			●
Check cables for damage and easy working			●			●
Lube and adjust cables		●				●
Check the electrical system			●			●
Check adjustment of head light						●
Spray ignition lock, emergency OFF switch, short circuit button, and light switch with contact spray		●				●
Check all screws, nuts and hose clamps for proper tightness	●		●			●
Grease or lube all pivot points and sliding components		●				●



*K T M - S P O R T M O T O R C Y C L E A G
A-5230 Mattighofen • Postfach 91 • Austria
I n t e r n e t : <http://www.ktm.at>
F N 102019 d - Landesgericht Ried im Innkreis*

Gedruckt auf chlorfrei gebleichtem, umweltfreundlichen Papier. - aumayer-druck-mattighofen