



# Installation & User Guide

## Dual-Flush Toilet

**K-3735**



**K-3736**



**K-19896**

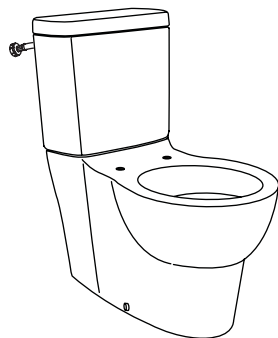

**K-4346**



THE BOLD LOOK  
OF **KOHLER**®

1102602-A2-A



## Tools and Materials

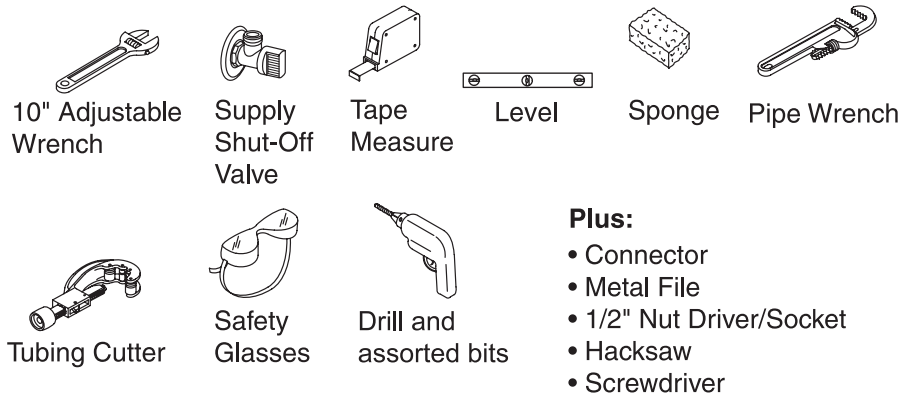

## Thank You For Choosing Kohler Company

We appreciate your commitment to Kohler quality. Please take a few minutes to review this manual before you start installation. If you encounter any installation or performance problems, please don't hesitate to contact us. Our phone numbers are listed on the back cover. Thanks again for choosing Kohler Company.

## Before You Begin



**CAUTION: Risk of personal injury or product damage.** Handle with care. Vitreous china can break or chip if the product is handled carelessly.

- Observe all local plumbing and building codes.
- Carefully inspect the new toilet for damage.
- If the existing toilet does not have a supply shut-off valve below the cistern, install one before installing the new toilet.

## Installation

**1** Remove the existing toilet: Turn off the water supply and flush the toilet, then sponge out all remaining water from the cistern. Disconnect the supply shut-off valve (if present), and remove the old pan and cistern.

**CAUTION:** Risk of hazardous gases. If the new toilet is not installed immediately, temporarily stuff a rag in the closet flange.

**2** Define the position of connector: Place the connector onto the pan, position between outlet and waste pipe.

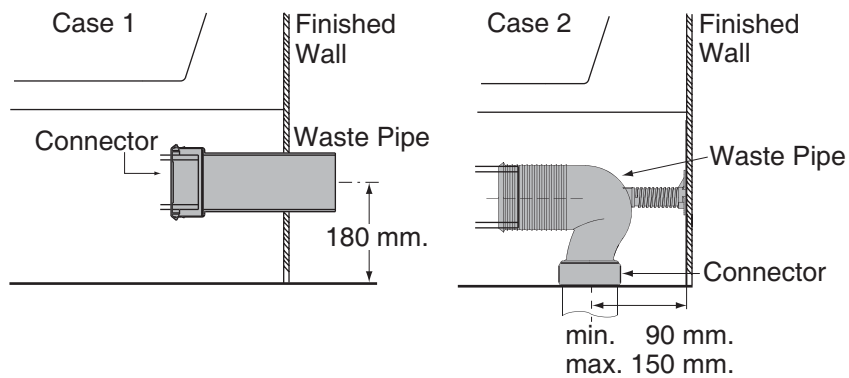

For this model, there are two types of connector. You can choose one of the above pictures which is most suitable to your local plumbing and building codes.

**3** Position the template on the floor to ensure the rear pan against the wall. Mark the mounting hole centerline on the floor.

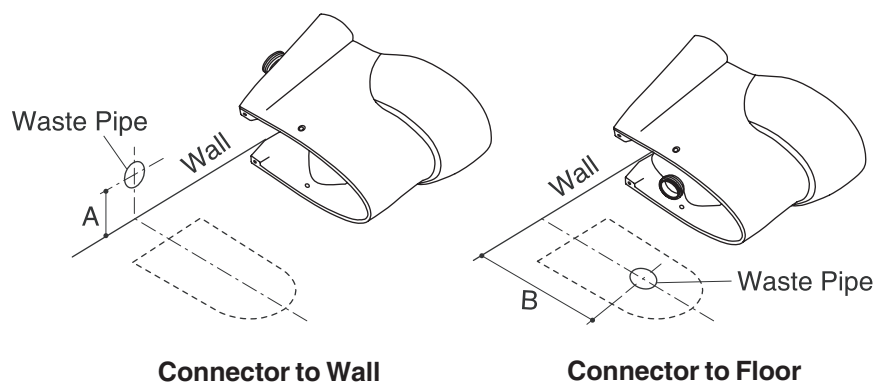

## Installation

- 4** Drill 3/8" (10 mm) mounting hole between the mark locations on the floor and insert the anchor.

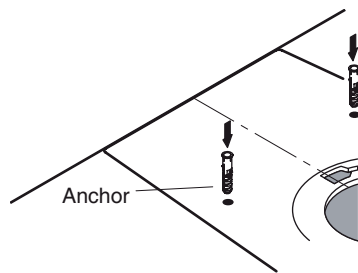

- 5** Install the washer and insert the hexagon screw into the bracket then tighten the screw.

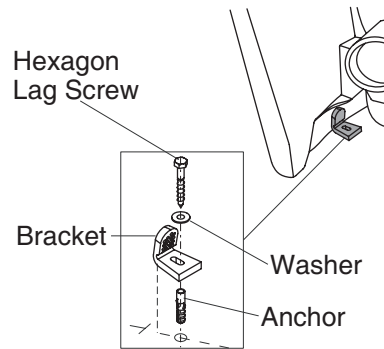

- 6** Install the sleeves, tighten the screw and attach the caps.

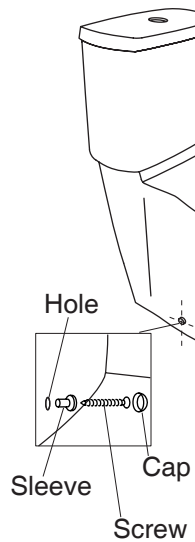

- 7** Position the cistern on the pan by centering the gasket on the pan inlet. Assemble the retaining washer and sealing washer to the screw. Securely tighten the screws so the cistern is level.

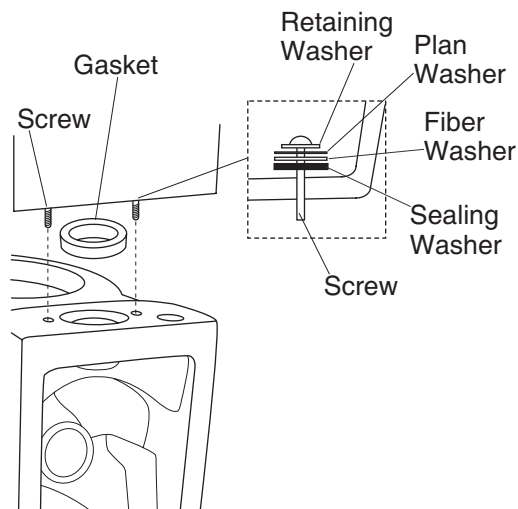

## Installation

- 8** Connect the supply shut-off valve to the supply hose and connect supply hose to toilet supply shank.



**Bottom Inlet Type**



**Rear Inlet Type**

- 9** In cistern.

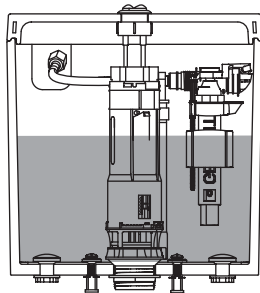

**Rear Water Inlet  
K-19896**

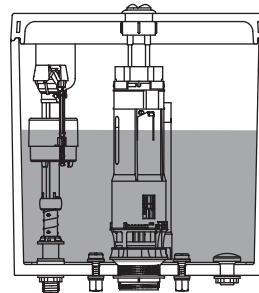

**Bottom Water Inlet  
K-3736**

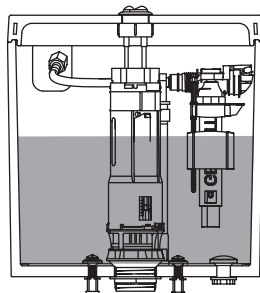

**Rear Water Inlet  
K-3735, K-4346**

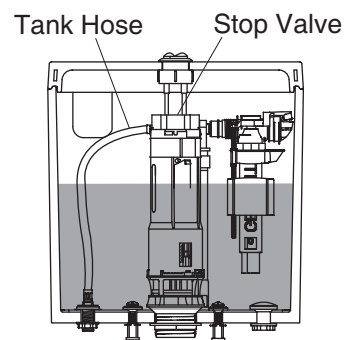

**Bottom Water Inlet  
Optional 148794A-NA**

## Install the Push Buttons

**1** Remove the tape and protective pad.

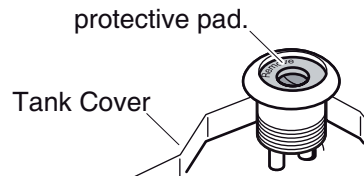

**2** Press down on the large button.

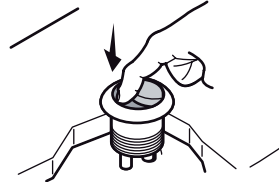

**3** Pull out and remove the small button.

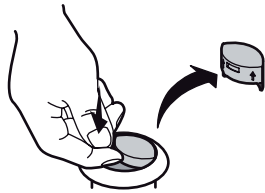

**4** Pull out and remove the large button.

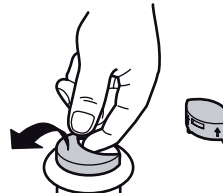

**5** Press the large button on to the black rod.

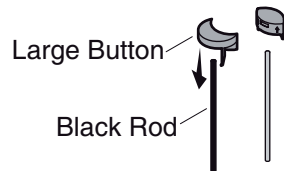

**6** Press the small button on to the green rod.

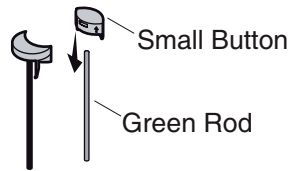

**7** Insert the rod into the holes in the push button housing.

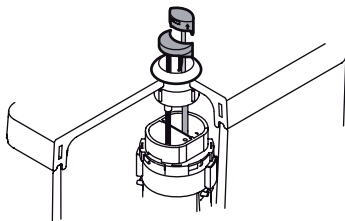

**8** Press down on the push buttons until they click into place.

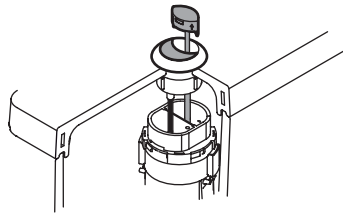

## Install Flush Valve

**1** Release flush valve by turn right and pull straight up on the canister.

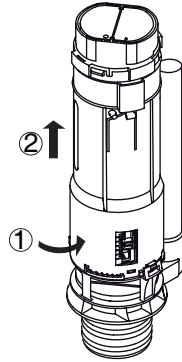

**2** Assembly flush valve by push straight down into the canister and turn left.

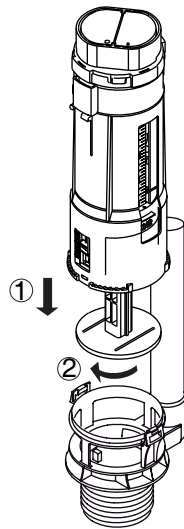



**New Zealand**

Kohler New Zealand Ltd.

Phone: 64 9 980 6888, 0 800 100 382 Fax: 64 9 980 6899

**Australia**

Kohler Co.

Phone: 61 1300 362 284 Fax: 61 1300 652 284

THE BOLD LOOK  
OF **KOHLER**®

©2008 Kohler Co.

1102602-A2-A

