

MDV 300

Progressive Scan
DVD-Video Player
Owner's manual

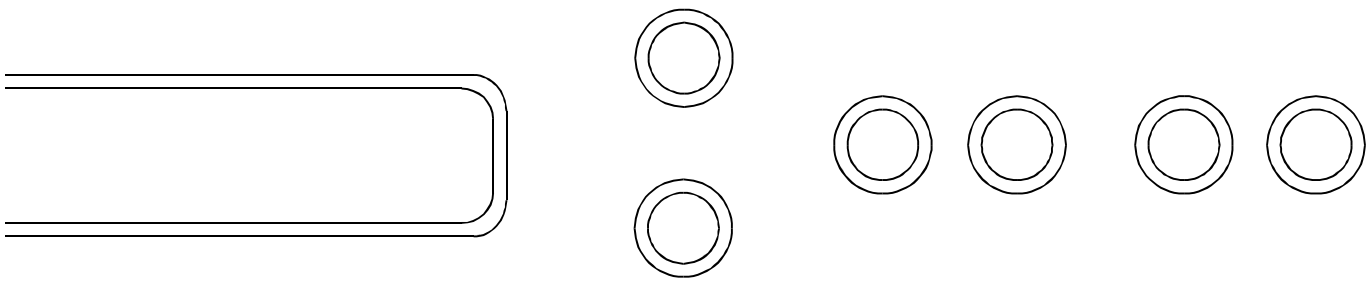

MDV 300 DVD Player

MYRYAD

SAFETY INFORMATION

TO REDUCE THE RISK OF FIRE AND ELECTRIC SHOCK, DO NOT EXPOSE THIS UNIT TO RAIN OR MOISTURE.



CAUTION : To reduce the risk of fire and electric shock, do not remove the cover (or back) of the unit. Refer servicing only to qualified service personnel.



The lightning flash with arrowhead symbol, within an equilateral triangle, is intended to alert the user to the presence of uninsulated "dangerous voltage" within product's enclosure that may be of sufficient magnitude to constitute a risk of electric shock.



The exclamation point within an equilateral triangle is intended to alert the user to the presence of important operation and servicing instructions in the literature accompanying the appliance.

WARNING: TO REDUCE THE RISK OF FIRE OR ELECTRIC SHOCK, DO NOT EXPOSE THIS APPLIANCE TO RAIN OR MOISTURE.

CAUTION: TO PREVENT ELECTRIC SHOCK, MATCH WIDE BLADE OF PLUG TO WIDE SLOT, FULLY INSERT.

IMPORTANT SAFEGUARDS

In addition to the careful attention devoted to quality standards in the manufacture of your video product, safety is a major factor in the design of every instrument. However, safety is your responsibility, too. This sheet lists important information that will help to assure your enjoyment and proper use of the video product and accessory equipment. Please read them carefully before operation and using your video product.

Installation

1. Read and Follow Instructions- All the safety and operation instructions should be read before the video product is operated. Follow all operating instructions.
2. Retain Instructions- The safety and operating instructions should be retained for future reference.
3. Heed all Warnings- Comply with all warnings on the video product and in the operating instructions.
4. Polarization- This video product is equipped with a polarized alternating-current line plug. This plug will fit into the power outlet, try reversing the plug. If the plug still fails to fit, contact your electrician to replace your obsolete outlet. To prevent electric shock, do not use this polarized plug with an extension cord, receptacle, or other outlet unless the blades can be fully inserted without blade exposure. If you need an extension cord, use a polarized cord.
5. Power Sources- This video product should be operated only from the type of power source indicated on the marking label. If you are not sure of the type of power supply to your home, consult your video dealer or local power company. For video products intended to operate from battery power, or other sources, refer to the operating instructions.
6. Overloading- Do not overload wall outlets or extension cords as this can result in a risk of fire or electric shock. Overloaded AC outlets, extension cords, frayed power cords, damaged or cracked wire insulation, and broken plugs are dangerous. They may result in a shock or fire hazard. Periodically examine the cord, and if its appearance indicates damage or deteriorated insulation, have it replaced by your service technician.
7. Power-Cord Protection- Power-supply cords should be routed so that they are not likely to be walked on or pinched by items placed upon or against them, paying particular attention to cords at plugs, convenience receptacles, and the point where they exit from the video product.
8. Ventilation- Slots and openings in the case are provided for ventilation to ensure reliable operation of the video product and to protect it from overheating. These openings must not be blocked or covered. The openings should never be blocked by placing the video product on a bed, sofa, rug, or heat register. This video product should not be placed in a built-in installation such as a book case or rack, unless proper ventilation is provided or the video product manufacturer's instructions have been followed.
9. Attachments- Do not use attachments unless recommended by the video product manufacturer as they may cause hazards.

10. Water and Moisture- do not use this video product near water for example, near a bath tub, wash bowl, kitchen sink or laundry tub, in a wet basement, or near a swimming pool and the like. Caution: Maintain electrical safety. Powerline operated equipment or accessories connected to this unit should bear safety certification mark on the accessory itself and should not be modified so as to defeat the safety features. This will help avoid any danger and should not be modified so as to defeat the safety features. This will help avoid any potential hazard from electrical shock or fire. If in doubt, contact qualified service personnel.

11. Accessories- Do not place this video product on an unstable cart, stand, tripod, bracket, or table. The video product may fall, causing serious injury to a child or adult as well as serious damage to the video product. Use this video product only with a cart, stand, tripod, bracket, or table recommended by the manufacturer's or sold with the video product. Any mounting of the product should follow the manufacturer's instructions and use of a mounting accessory recommended by the manufacturer.

12. A video product and cart combination should be moved with care. Quick stops, excessive force, and uneven surfaces may cause the video product and cart combination to overturn.

Note to CATV system installer

This reminder is provided to call the CATV system installer's attention to Section 820-40 of the NEC which provides guidelines for proper grounding and, in particular, specifies that the cable ground shall be connected to the grounding system of the building, as close to the point of cable entry as practical.

13. Outdoor Antenna Grounding- If an outside antenna or cable system is connected to the video product, be sure the antenna or cable system is grounded so as to provide some protection against voltage surges and built-up static charges. Section 810 of the National Electrical Code, ANSI/NFPA No. 70-1984 (Section 54 of Canadian Electrical Code, Part 1) provides information with respect to proper grounding of the mast and supporting structure, grounding of the lead-in wire to an antenna-discharge unit, connection to grounding electrodes, and requirements for the grounding electrode.

14. Power Lines- An outside antenna system should not be located in the vicinity of overhead power lines, other electric light or power circuits, or where it can fall into such power lines or circuits. When installing an outside antenna system, extreme care should be taken to keep from touching or approaching such power lines or circuits, as contact with them might be fatal. Installing an outdoor antenna can be hazardous and should be left to a professional antenna installer.

Use

15. Cleaning- Unplug this video product from the wall outlet before cleaning. Do not use liquid cleaners or aerosol cleaners. Use a damp cloth for cleaning.

16. Objects that may touch dangerous voltage points or "short-out" parts could result in a fire or electric shock. Never spill liquid of any kind on the video product.

17. Lightning- For added protection for this video product during a lightning storm, or when it is left unattended and unused for long periods of time, unplug it from the wall outlet and disconnect the antenna or cable system. This will prevent damage to the video product due to lightning and power line surges.

Service

18. Servicing- Do not attempt to service this video product yourself, as opening or removing covers may expose you to dangerous voltage or other hazards. Refer all servicing to qualified service personnel.

19. Conditions Requiring Service- Unplug this video product from the wall outlet and refer servicing to qualified service personnel under the following conditions:

- A. When the power-supply cord or plug is damaged.
- B. If liquid has been spilled, or objects have fallen into the video product.
- C. If the video product has been exposed to rain or water.
- D. If the video does not operate normally by following the operating instructions. Adjust only those controls that are covered by operating instructions. Improper adjustment of other controls may result in damage and will often require extensive work by a qualified technician to restore the video product to its normal operation.
- E. If the video product has been dropped or cabinet has been damaged.
- F. When the video product exhibits a distinct change in performance- this indicates a need for service.

20. Replacement Parts- When replacement parts are required, have the service technician verify that the replacements he uses have the same safety characteristics as the original parts. Use of replacements specified by the video product manufacturer can prevent fire, electric shock, or other hazards.

21. Safety Check- Upon completion of any service or repairs to this video product, ask the service technician to perform safety checks recommended by the manufacturer to determine that the video product is in safe operating condition.

22. Wall or Ceiling Mounting- The product should be mounted to a wall or ceiling only as recommended by the manufacturer.

23. Heat- The product should be situated away from heat sources such as radiators, heat registers, stoves, or other products (including amplifiers) that produce heat.

FEATURES

DVD, CD, VCD, SVCD, MP3, WMA,
Picture CD compatible
CD-R, CD-RW capable
DVD-R, DVD+R capable

TV format:

PAL / NTSC color system
4:3 / 16:9 screen format select

Video output:

Composite Video output
S-Video output
Y Pb Pr (component) interlaced scan output
Y Pb Pr progressive scan output

Audio output:

Down-mix stereo output
Dolby Digital 5.1 decoded output
Dolby Digital digital output
DTS digital output

DVD features:

Multi Subtitle select
Multi Language select
MultiAngle select

Other features:

On screen display menu
Video equalizer
6 speaker setup and pink noise test
Digital zooming
Fast scan forward / backward
Slow motion
Child lock
Auto screen saver

Manufactured under license from Dolby Laboratories.
Dolby and the double-D symbol are trademarks of Dolby
Laboratories. Confidential Unpublished Works.
©1992-1997 Dolby Laboratories.
All rights reserved.

This product incorporates copyright protection technology that is
protected by method claims of certain U.S. patents and other
intellectual property rights owned by Macrovision Corporation and
other rights owners. Use of this copyright protection technology
must be authorized by Macrovision Corporation, and is intended
for home and other limited viewing uses only unless otherwise
authorized by Macrovision Corporation. Reverse engineering or
disassembly is prohibited.



The player has built in copyright
protection technology that
prevents copying from a DVD
disc to any media.

**If a video recorder is connected to
the player, the video output image
will be distorted during recording.**

CONTENTS

Page

WARNING IMPORTANT NOTICE FEATURES ESSENTIAL SETUP

1-2

INTRODUCTION

About DVD	3-4
About MP3	5
About the player	
Front panel	6
Rear panel	6
Remote control	7

SYSTEM CONNECTION

Connecting to a TV set	8
Connecting to Progressive TV	9
Connecting to stereo amplifier	9
Connecting to digital amplifier	10
Connecting to 5.1 ready amplifier	10

GETTING STARTED

Play a disc	11
OSD - DVD	12
OSD - VCD/CD	12
MP3 mode	13
Kodak Picture mode	14

FUNCTION BUTTONS

15-21

SETUP MENU

22-24

SMART MY-LINK

25

MYRYAD A/V REMOTES

26

TROUBLESHOOTING

27-28

SPECIFICATIONS

29-30

ESSENTIAL SETUP





Video outputs

The player is equipped with the following video output ports:

Interlaced scan output: Composite video (CVBS), S-Video, Y Pb Pr, SCART
Progressive scan output: Y Pb Pr

DEFAULT The factory default video output setting is S-Video (interlaced scan). In this mode the active video output ports are: Composite video (CVBS) and S-Video.

To change the video output setting, after the system connection is completed (see "SYSTEM CONNECTION"), follow these steps:

- 1 In STOP mode, press **SETUP** button , setup menu appears.
- 2 Press **RIGHT** button  highlight "Video" icon.
- 3 Press **ENTER** button , sub-menu appears.
- 4 Highlight "Interlace Out" icon, press **ENTER** button, sub menu appears.
- 5 Highlight "S-Video", "YCbCr" or "RGB" as desired and press **ENTER** button.
- 6 Press **SETUP** button  to quit.

IMPORTANT NOTE

- 1 The composite video (CVBS) output is active in all three video output settings. Always connect the CVBS signal to the TV if any problem is experienced with obtaining a picture.
- 2 When Progressive Scan has been selected, no signal will be sent to the CVBS, S-Video or SCART outputs.



Once the video "Interlace Out" has been set using this procedure, the active video output ports are as shown in the table below:

Video port ->	CVBS	S-Video	Y Pb Pr	RGB (SCART)
Interlace Out				
S-Video	Yes	Yes	No	No
Y Cb Cr	Yes	No	Yes	No
RGB	Yes	No	No	Yes

For Progressive scan output

With no disc in the player press the PROG SCAN button on the remote control twice. Progressive scan component signals will be output from the Y/Pb/Pr jacks, whatever the previous "Interlace Out" video setting. The same procedure is used to switch back to interlace scan mode.





Audio outputs (analogue)

The player can provide either stereo (Left and Right) output or 5.1 channel decoded output (from Dolby Digital Sources).

DEFAULT Factory default audio output is: **Stereo Left and Right only** (Downmix)

For 5.1 decoded output connection, the following setup is required:

After system connection is completed (see "SYSTEM CONNECTION"), setup as following steps:

- 1 In STOP mode, press **SETUP** button , setup menu appears.
- 2 Press **RIGHT** button  highlight "Audio 2" icon.
- 3 Press **ENTER** button , sub-menu appears.
- 4 Highlight "Spkr Setup" icon, press **ENTER** button, sub menu appears.
- 5 Highlight "5.1 Channel" icon, press **ENTER** button.
- 6 Highlight the connected speaker's name, press **ENTER** button to switch ON or OFF the speaker.
- 7 Highlight "C S Spkr Size" and press **ENTER** button to select Large or Small Centre and Surround speakers. If "Large" is selected the speakers will receive the full frequency range. If "Small" is selected the bass frequencies in the centre and surround channels will be redirected to the subwoofer.
- 8 After setting all speakers, Press **SETUP** button  to quit.



INTRODUCTION

Introduction

The Myryad MDV 300DVD-Video Player has been designed to offer a combination of high quality sound reproduction and elegant styling in keeping with other Myryad products. The MDV 300 is a full-function remote controlled DVD-Video player. It has fixed-level low-impedance audio outputs to drive a Myryad pre-amplifier or integrated amplifier or other high quality amplifier. Video outputs are provided in composite, s-video and component form and can be fed to an audio-video preamplifier (such as the Myryad MDP 500 G6) or amplifier or direct to a TV. In addition the MDV 300 has coax and optical digital outputs (SPDIF standard) to feed a digital surround processor and a Smart My-Link control input and output.

The MDV 300 offers a range of expansion possibilities:

- The My-Link can be connected to a Myryad pre-amplifier or integrated amplifier so that the MDV 300 will be switched on or off when the amplifier is switched on or off.
- The My-Link input/output can be coupled to other Myryad products that can then be remote-controlled via the MDV 300's infra-red receiver, or vice-versa.
- When linked to a "Smart My-Link" compatible Myryad preamplifier or integrated amplifier a number of extra features become available which make the system as a whole easier and quicker to operate.

Accessories

Your MDV 300 is supplied with the following accessories:

- Separate mains power cord to suit country of sale.
- My-Link interconnect (0.5m RCA-RCA).
- MDV 300 remote control handset.
- Two AAA batteries for handset (not in some countries).

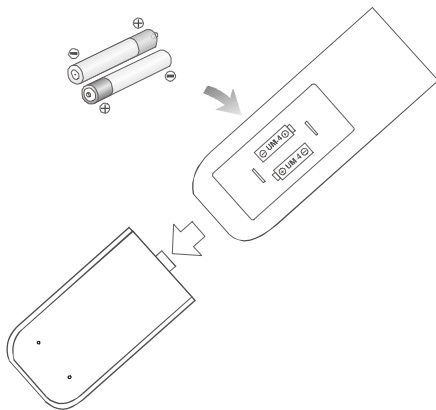

Loading batteries into the remote control

- Remove the battery compartment cover.
- Load two AAA (UM-4 or R03) batteries into the battery compartment.
- Check that batteries are fitted correctly and that the polarity of the batteries matches the polarity indicated in the battery compartment. Replace the battery compartment cover.
- Always replace both batteries. Do not mix new and used batteries as this will reduce the operating period.
- Remove the batteries if the unit is not to be used for a prolonged period of time.

The remote control transmits a directional infrared beam. Be sure to aim the remote control directly at the infrared sensor of the unit during operation.

If the sensor has been covered or there is a large object between the remote control and the sensor, the sensor may not respond.

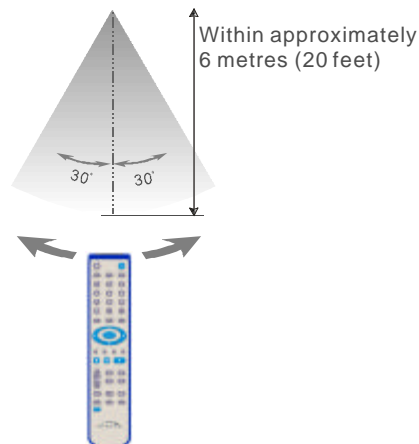

The sensor may not be able to receive the remote signal when it is exposed to direct sunlight or a strong artificial light (fluorescent or strobe light). In these instances, change the direction of the light or reposition the unit to avoid direct lighting.



About DVD









DVD (Digital Versatile Disc) is a digital video medium using the MPEG II format and featuring a variety of revolutionary entertainment capabilities. The MPEG II video compression technology provides capacity for an excellent picture of at least 500 lines of resolution on screen, up to 8 language soundtracks, up to 9 views from different camera angles and up to 32 language subtitles (provided the DVD disc itself supports these features).

Disc information

Disc types	DVD	CD
Recording Method	Digital / MPEG II	Digital
Capacity	Single-layer/Singleside 4.7GB=2 hr Single-layer / Double sides 8.5GB=4 hr Double-layers/ Singleside 9.4GB=4.5 hr Double-layers / Doublesides 17GB=8hr	650MB=74min
Disc size	12cm / 8cm	12cm / 8cm
Horizontal Resolution	500 lines up	-
Sub-titles	32	-
Sound tracks	8	1
Symbol		

DVD features symbols

Each DVD disc contains various features depending on production of the disc. Below are some of the symbols representing the features:

-  Regional Code / Video output system
-  Dolby Digital Surround
-  Screen Format
-  DTS Digital Surround
-  Child Lock
-  Number of Audio Tracks
-  Angle Indicator
-  Number of Sub-titles

 The player has built in copyright protection technology that prevents copying from a DVD disc to any media.

If a video recorder is connected to the player, the video output image will be distorted during recording.

REMARK

Some features contained in this DVD player are related to the DVD disc's software.

Some features cannot be performed if the disc does not support the feature, or requires special settings.

Check the features printed on the disc's packing or follow the instructions of the disc's on screen menu.

Select a DVD disc

DVD Region Code

DVD discs and DVD players are manufactured under the worldwide agreed DVD Regional Code System. The player will operate only with a corresponding disc of the same Regional Code.

Region code	Region
1	Canada, USA
2	Europe (incl. Poland, Romania, The Czech republic), Japan, Middle East (incl. Saudi Arabia, Egypt, Iran, South Africa)
3	East Asia (incl. Hong Kong, Taiwan, South Korea), South-East Asia
4	Australia, Caribbean, Central & South America, Mexico, New Zealand
5	Africa, Former Soviet Union, India, North Korea, Pakistan, Turkmenistan
6	China

Care of discs

Video discs contain high-density compressed data and require correct handling.

- Hold the disc with fingers. Hold the disc's outer edge and/or the center spindle hole. Do not touch the disc surface.

Video

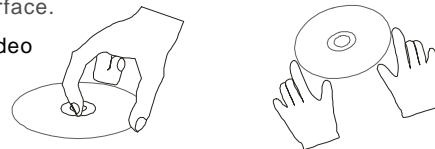

- Do not bend or press the disc. Do NOT expose the disc to direct sunlight or heating sources.



- Do not allow discs to become wet. Prevent exposure to:
 - Direct sunlight
 - Heat or exhaust from a heating device.
 - Extreme humidity.
- Clean the disc surface with a soft, dry cleaning cloth. Wipe the disc surface gently, radially, from center toward the outer edge.
- Do not apply thinner, alcohol, chemical solvent or sprays when cleaning. Such cleaning fluids will permanently damage the disc surface.

This player is compatible with the following disc types:

- DVD single sided / double sided
single layered / double layered
- CD-DA
- CD-MP3
- VCD/SVCD
- Photo CD
- CD-R / CD-RW*
- DVD-R/DVD+R*

***NOTE:** Some PC application files on CD-R or CD-RW **CANNOT** be accepted by the unit, e.g. CD-ROM under PC Windows, etc. Also CD-R / CD-RW and DVD-R/DVD+R writing format may be different, some discs are not acceptable.

About MP3

MP3 (MPEG 1, Audio Layer 3) is a compressed digital audio format. MP3 uses entropy encoding to reduce the redundant information in an audio signal to a minimum. It takes music from a CD and reduces it by a factor of 12, with minimal loss of quality. On a normal CD of 74 minutes you can store over 130 MP3 songs.

Disc information

When creating an MP3 disc, the sampling rate should be 44.1 kHz and the bit rate should be between 128 Kbps and 256 Kbps in order to achieve the best performance. In general, higher quality settings result in larger file sizes.

MP3 Format

Sampling rate	Bit rate	Quality
44.1 kHz	56 Kbps	↓ FM Radio Quality ↓
44.1 kHz	64 Kbps	
44.1 kHz	80 Kbps	
44.1 kHz	96 Kbps	
44.1 kHz	112 Kbps	↓ Near CD Quality ↓
44.1 kHz	128 Kbps	
44.1 kHz	160 Kbps	Good CD Quality ↓
44.1 kHz	192 Kbps	Better than CD Quality ↓
44.1 kHz	224 Kbps	↓ Studio Quality
44.1 kHz	256 Kbps	

Discs that cannot be played



The following discs cannot be played in the DVD player:

- DVDs with region codes that do not match the player's region code (Check the region code printed on the disc's packing. Region code "ALL" will be acceptable by all players.)
- Some DVDs purchased from abroad.
- PC applications on CD-R/CD-RW.
- CD-ROM for PC interface only.
- CD-MP3 under Windows format.
- Improperly formatted MP3 CD-R/CD-RW DVD-R/DVD+R (see "Tips for making a good MP3 CD" below)

Tips for making a good MP3 CD

- System Requirement (Recommended) :
IBM PC or compatible 200 MHz or faster
Windows 95 / 98 / ME / XP / NT / 2000
32 MB RAM
205 MB free hard disk space (at least 140 MB of this space must reside on the system boot drive)
CD-Recordable or CD-ReWritable drive
Windows compatible sound card 16-bit or better (optional).
- Use a good quality CD-RW disc. Either 650 MB (74-minute CD) or 700 MB (80-minute CD) blanks may be used.
- Select a high quality and stable CD Recorder (Writer).
- Select an advanced CD burning software.
- MP3 is data and not WAV information. Mode 1 must be selected when compiling and burning your discs.
- Drag and drop (Direct CD) must not be used to compile the disc. The player will not recognise this format.
- Only single session recordings can be used. Multi session recordings are not recognised and will not be played
- Use either the ISO 9660 or Joliet file systems.
- CDs should be "finalized" after they have been burnt.

About the player

Front panel

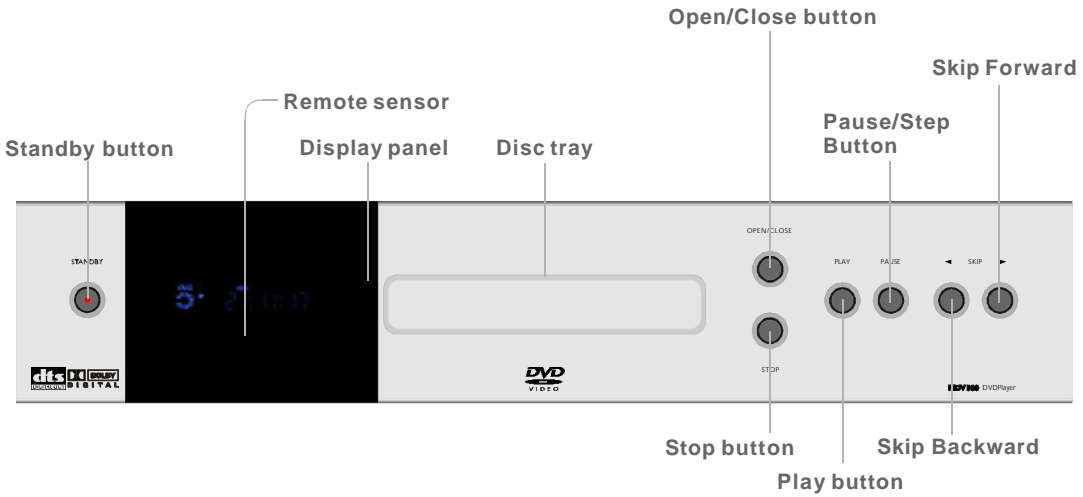

Rear panel

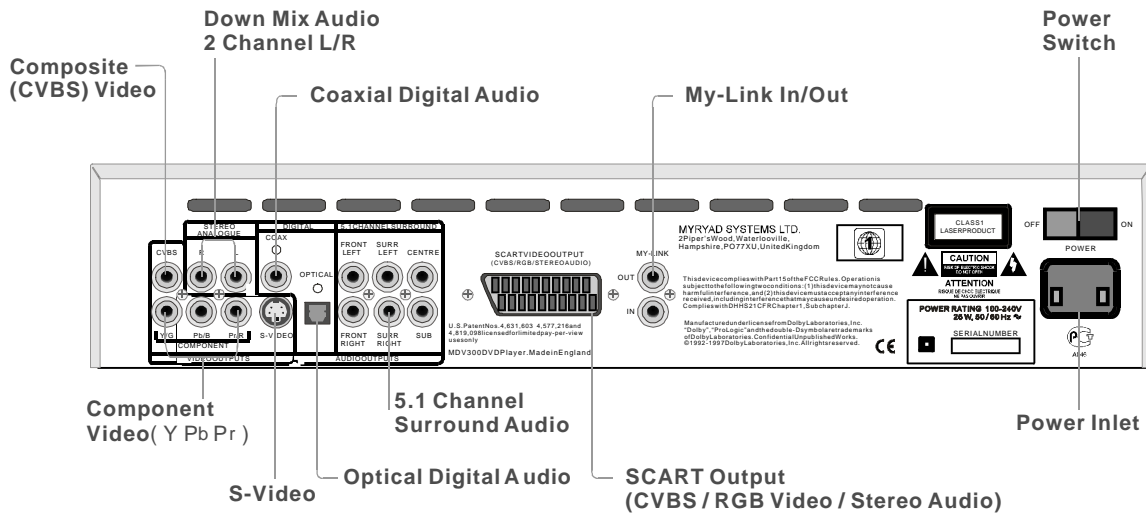

Remote control

Some features of the player can only be performed by the remote control.
 Some features described in this owner's manual are related to the disc's encoding.
 Some features may not be available, if the disc encoding does not support the feature.

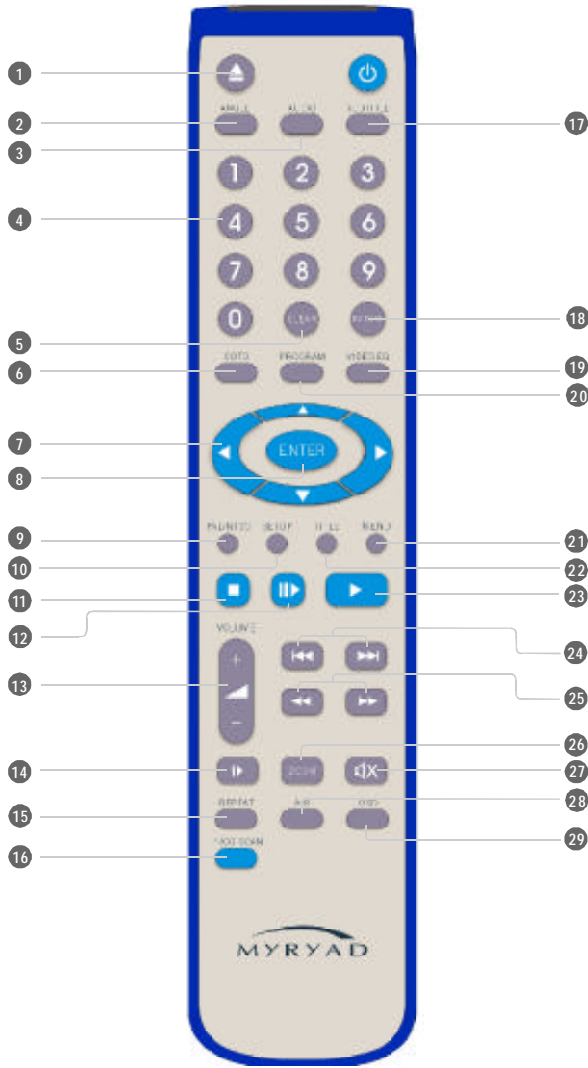

- 1 Drawer Open/Close
- 2 Angle select (DVD feature)
- 3 DVD audio soundtrack (DVD feature)
- 4 Numeric entry
- 5 Clear the last entry
- 6 Goto track or time search
- 7 Arrow
Up / Down / Left / Right
- 8 Enter
- 9 PAL/NTSC (TV system)
- 10 Setup menu
- 11 Stop
Press once - Stop (may resume with PLAY button)
Press twice - Stop
- 12 Pause / Step play
Press once to Pause
Press again to play frame by frame
- 13 Volume Up/Down (on Myryad amp or pre-amp, only in a My-Linked system)
- 14 Slow motion play
- 15 Repeat playback
Title / Chapter / Disc
- 16 Progressive / Interlace video output select (in STOP mode)
- 17 Subtitle select (DVD disc feature)
- 18 Return to the previous menu
- 19 Video Equalizer (Brightness/Sharpness/ Colour/Contrast)
- 20 Programming mode
- 21 Return to DVD Menu
- 22 Return to DVD Title
- 23 Play
- 24 Skip backward and forward
- 25 Scan backward and forward
- 26 Zoom
- 27 Mute (on Myryad amp or pre-amp, only in a My-Linked system)
- 28 A-B Repeat
- 29 On Screen Display on/off

REMARK
 Some features contained in this DVD player are related to the DVD disc's software.
 Some features cannot be performed if the disc does not support the feature, or requires special settings.
 Check the features printed on the disc's packing or follow the instructions of the Disc's on screen menu.

SYSTEM CONNECTION

 Do **NOT** connect the AC power socket to the wall outlet before the system connection is completed

SYSTEM CONNECTION

Connecting to a TV (Interlaced)

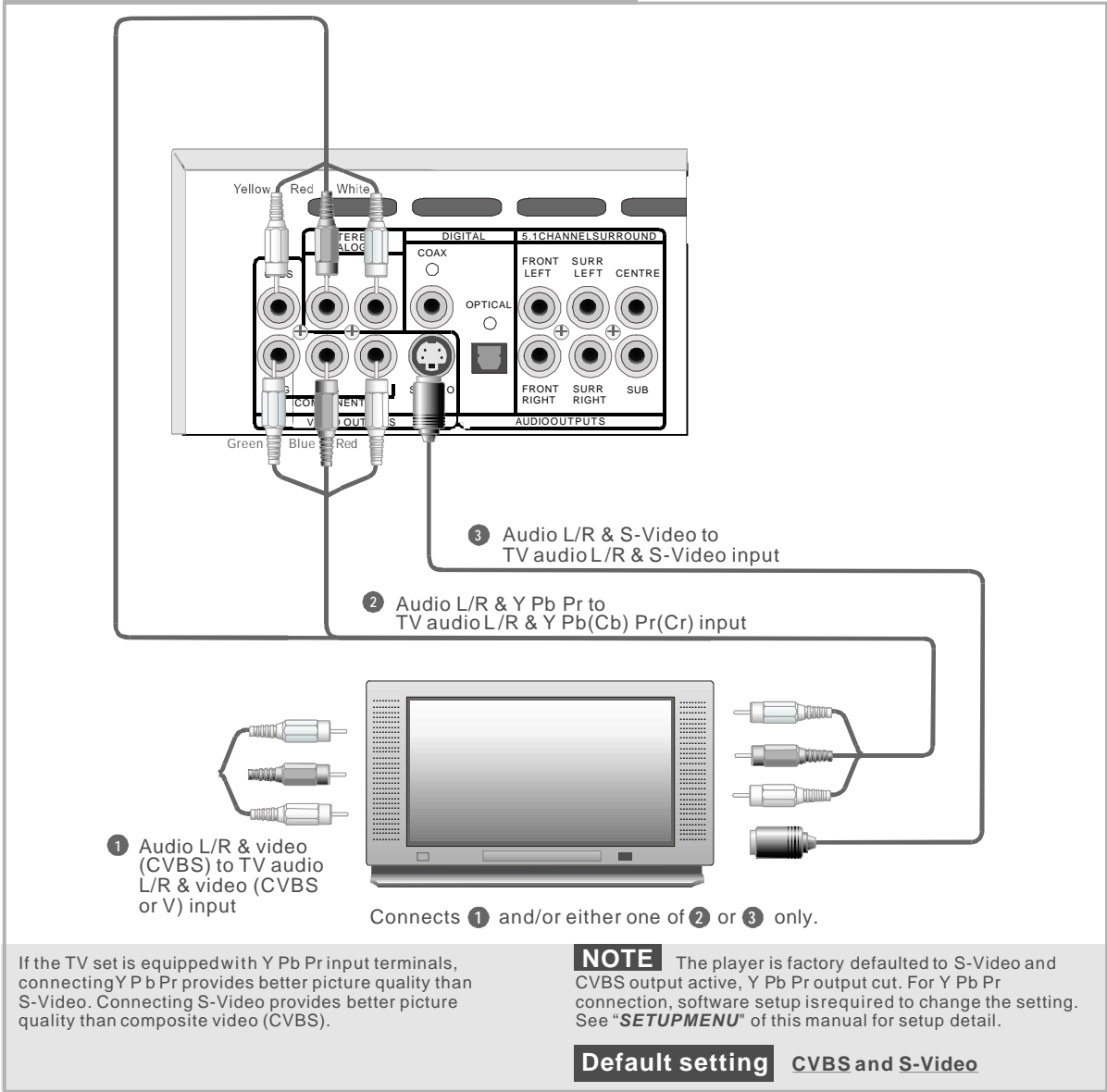

Connecting to progressive scan TV

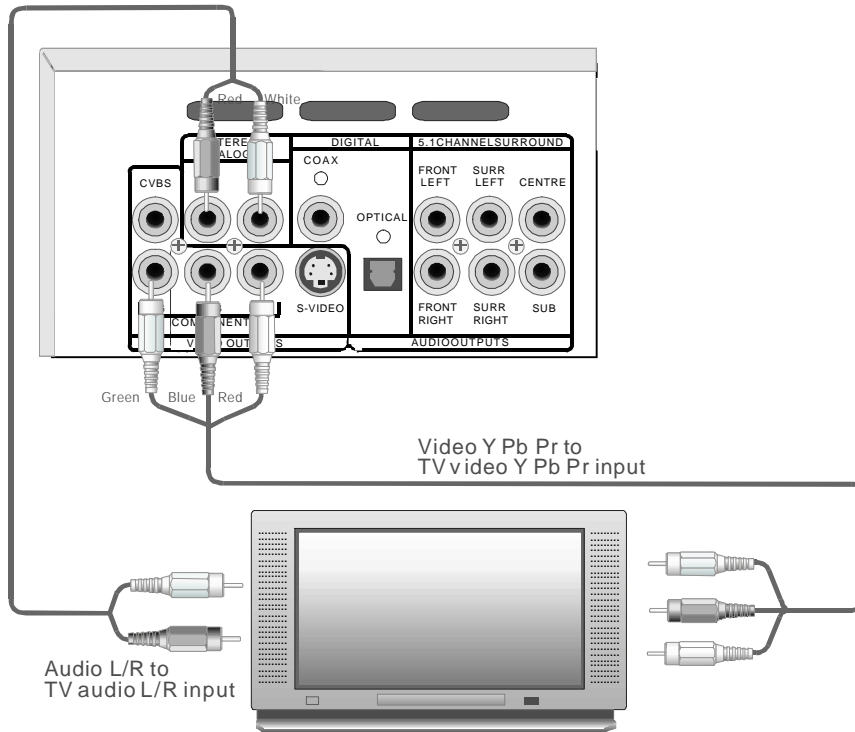

After connection completed, press **PROG SCAN** button on the remote.

Y Pb Pr progressive scan connection provides the best picture quality.

NOTE The player is factory defaulted to interlaced video output active, progressive scan Y Pb Pr output cut. Once connection is completed, with no disc in the player, press **PROG SCAN** button on the remote twice to change the video output to progressive scan mode.

SYSTEM CONNECTION

Connecting to stereo amplifier

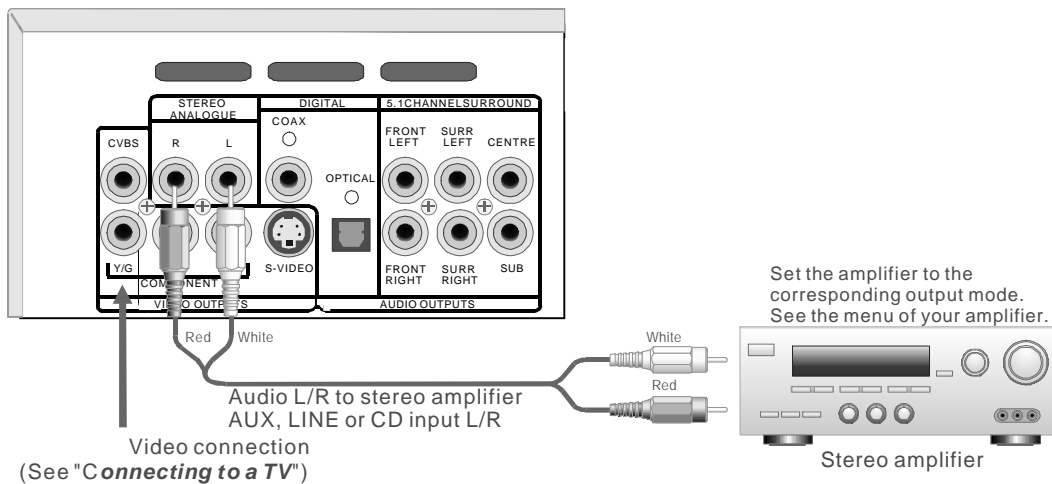

Connecting to digital amplifier

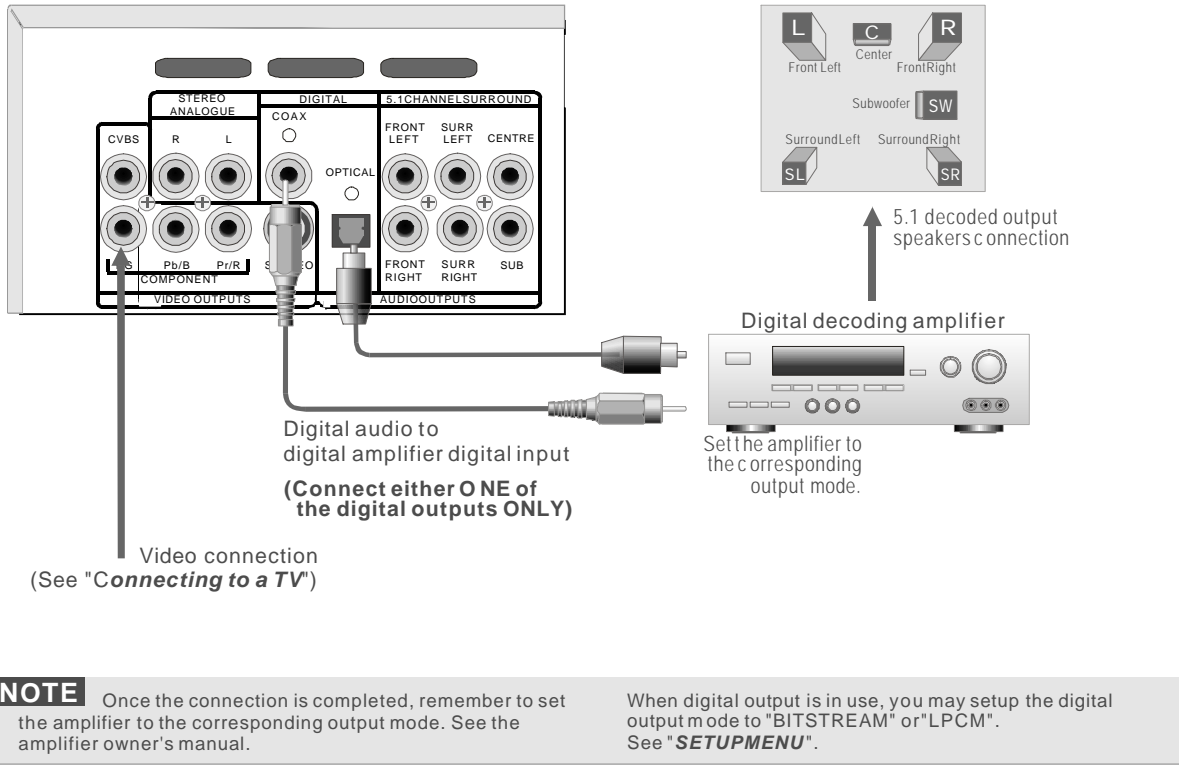

Connecting to 5.1 ready amplifier

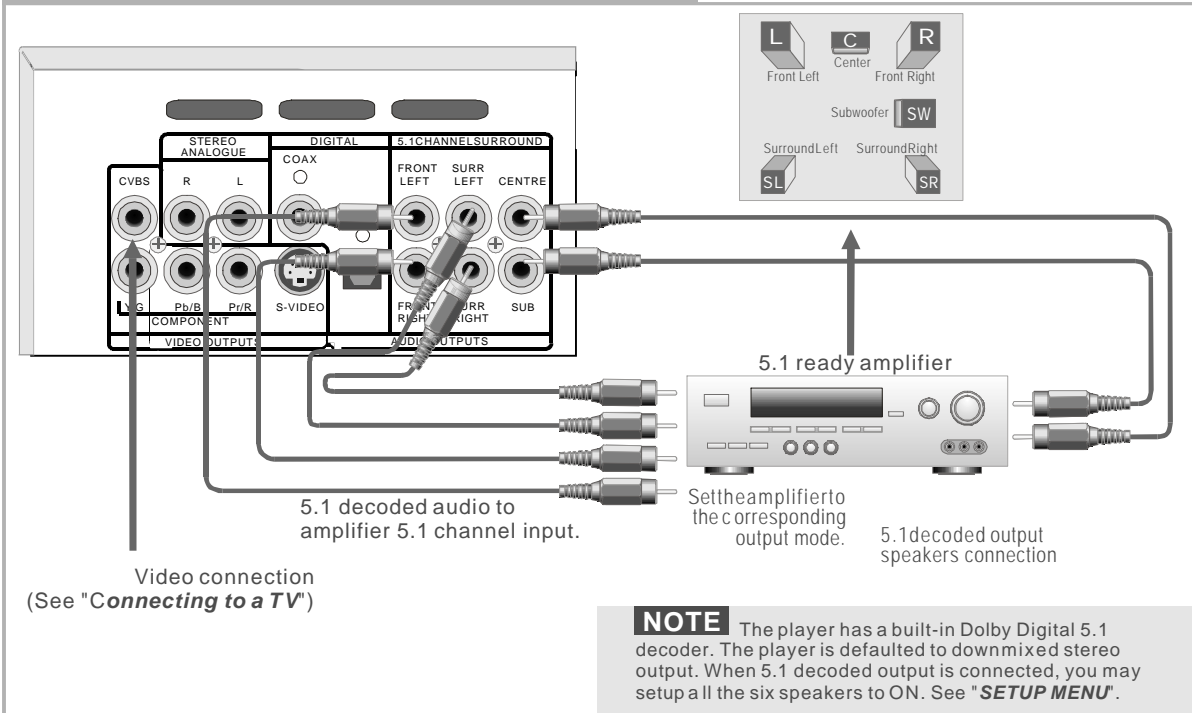

GETTING STARTED

- Unpack the unit.
- Read through this owner's manual before installation and use.
- Load batteries into the remote control unit.
- Connect the system.
- Connect the power cable to the player and then to the A C power outlet.
- Set the **POWER** switch on the rear panel to the ON position.

Play a disc

Switch on the player

Press the Standby button to turn on the DVD unit. Turn on the TV set and the amplifier if connected.

Set up the system

Select the corresponding setting on the TV set (AV1, AV2, S-Video etc.) and the amplifier, until the DVD power on screen appears.

Load a disc

Press the **Open/Close** button on the remote control (or front panel) to eject the disc tray. Load a disc and press the **Open/Close** button again to close the disc tray.

(Place the disc's label side up, blank side down)



Automatic Play

The unit will take a few seconds to load the disc data, display the disc type logo in the left upper corner of the TV screen, and then start playing automatically.

If a DVD Disc Menu appears on screen

- 1 Press **PLAY** button on the remote (or on the unit) to start playing.

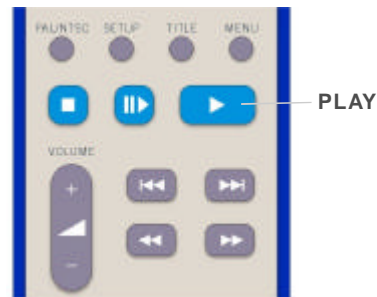

or

- 2 Press **ARROW** buttons to select the desired feature in the menu, and then press the **ENTER** button to confirm the selection.

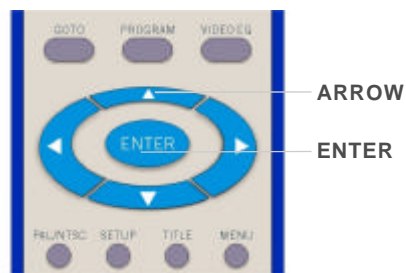

NOTE Normally, when an MP3, or Photo CD disc is loaded, the player will take more time to download the initial data.

The following DVD discs cannot or may not be executed by the player:

- 1) DVD disc of the wrong region code.
- 2) DVD disc with higher parental level than the player's setting.
- 3) DVD-ROM for PC application (e.g. PC game) that may come with the DVD movie packing.

Press **OSD** button. An On Screen Display (OSD) indicator will appear in the upper part of the TV screen with the disc information and operating status.

The first press of the OSD button will bring up just the Playback time/remain time display. A second press will show the full information displays as indicated below. The OSD display will remain on-screen until the button is pressed a third time to turn it off.

The OSD is a user friendly interface designed for displaying the status of the playing disc. When a different disc is loaded (DVD, CD or MP3), the OSD indicator will change.

OSD - DVD mode

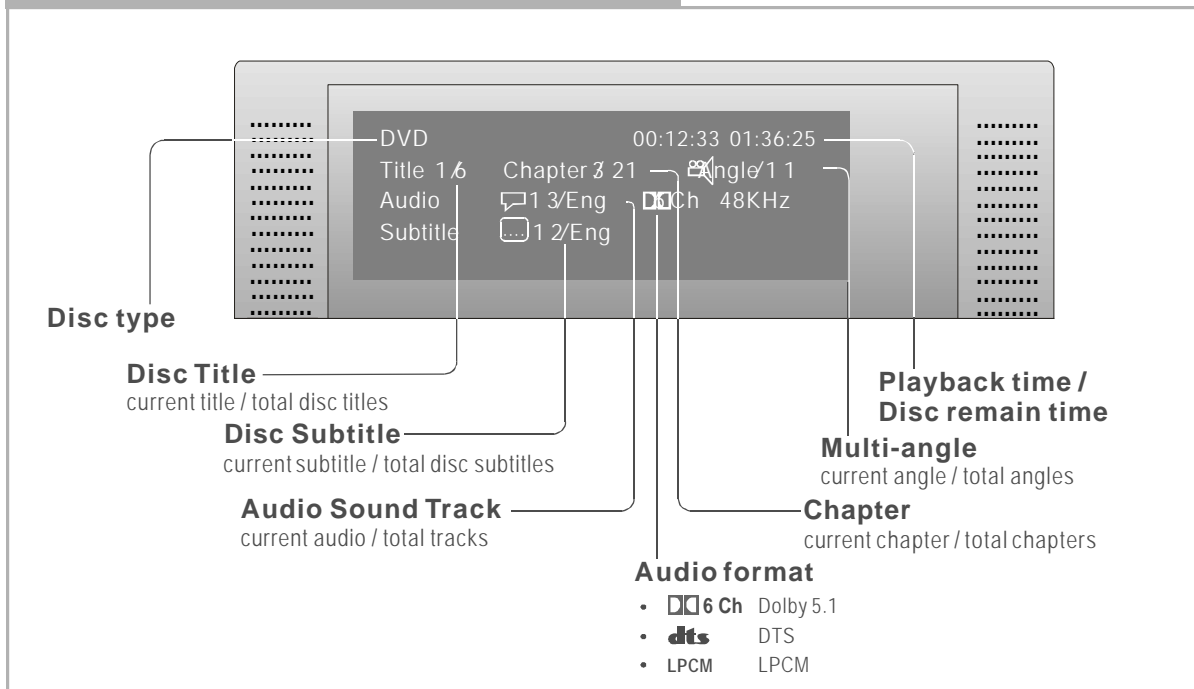

OSD - CD mode

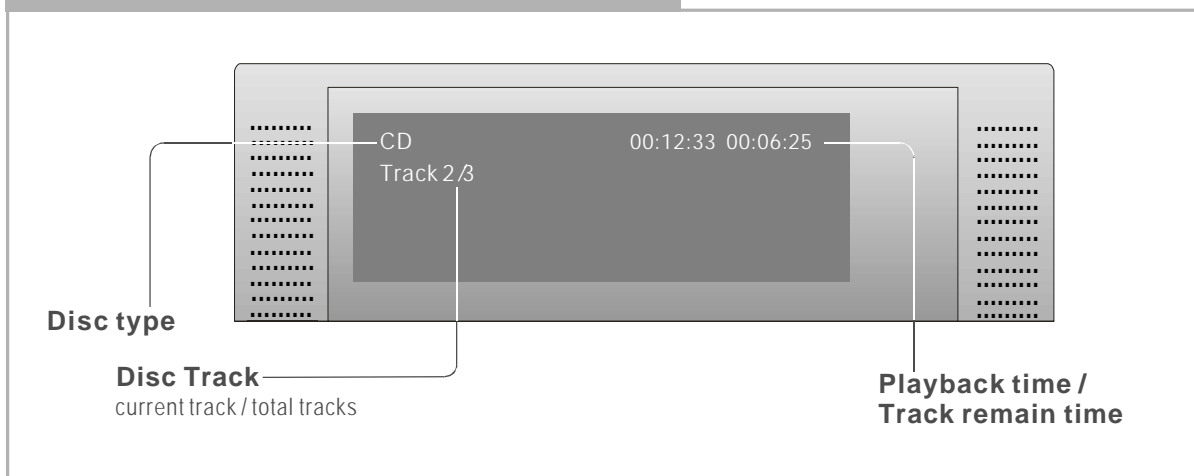

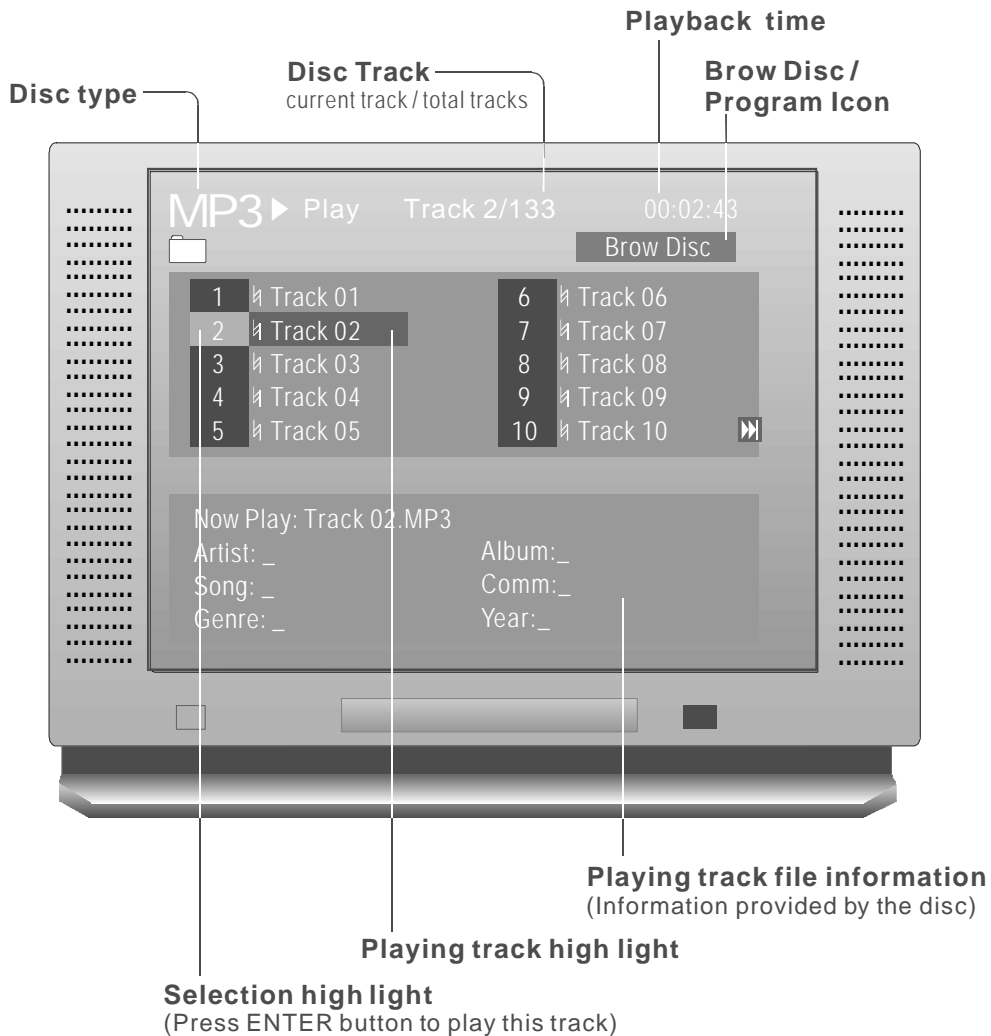
MP3 mode**Auto playback**

The player will load the MP3 disc and will play all tracks in the root directory.

Select a track

Press the **ARROW** buttons to highlight the desired track, press **ENTER** button to play the selected track.

Program playback

In **STOP** mode, highlight the **Brow Disc / Crea Prog** icon on the upper right-hand corner of the screen. Highlight the desired track and press **ENTER**. Repeat as necessary. When programming is complete, press the **PLAY** button to start program playback.

Displaying track information

You can add track information when you create the disc, e.g. artist, song title and date etc. This information will be displayed in the lower part of the screen when the track is played.

Kodak picture CD mode

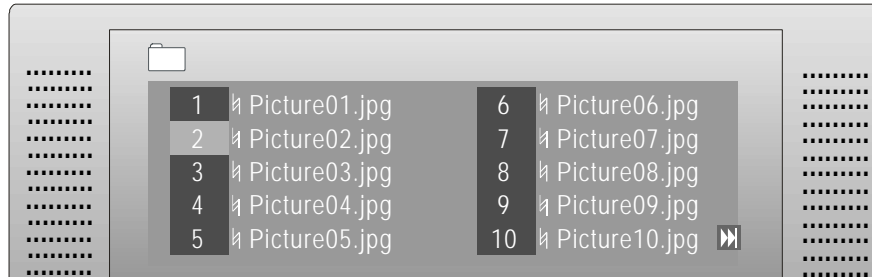

About Kodak Picture CD

A Kodak Picture CD has the size and shape of a regular CD. You can order a KODAK Picture CD simply by checking the box on the photo finishing envelope when you drop off a roll of film (35mm or Advanced Photo System (APS) color print film) at the time of processing in Kodak Express store displaying "Kodak Picture CD" sign. When your order is returned, you receive your prints, negatives, and your full roll of pictures safely stored on your KODAK Picture CD. Each KODAK Picture CD brings you the tools to enhance, share and manage your pictures on your computer.

Now, you can playback Kodak Picture CDs on our DVD players and view your pictures on your TV in the comfort of your living room.

Playing back your Kodak Picture CD

The new feature enables the decoding of JPEG files from a Kodak Picture CD disk.

When a Kodak Picture CD has been loaded in the player, an automatic slide show will be launched. Each picture in the Kodak Picture CD will be displayed consecutively in a slide-show fashion and will be scaled to fit in the whole TV screen.

Press **PAUSE** button  to display an image indefinitely.

Press **SKIP** buttons to view the next or previous picture.

Press **PLAY** button to resume the automatic slide show.

Press **SETUP** button  **Display time** menu appears.



Use **ARROW** button Left/Right to adjust the automatic slide time.

Image rotation

There are two modes to rotate a picture, rotate to the left and rotate to the right.

These operations are allowed only when a picture is being displayed normally and will be cancelled automatically when a new picture is displayed.

Press **ARROW** button to select the different rotation modes:

Press the right arrow button rotate to the right

Press the left arrow button rotate to the left

Zoom

Both Zoom in and Zoom pan function for the pictures are provided.

Press **ZOOM** button to execute zoom function and select the zoom enlarging scale.

In zoom mode, press **ARROW** buttons to adjust the zooming position, thus the position of the partial picture to be displayed. With zoom mode off, the next picture will be scaled to normal fitting to the whole TV screen.

Press the **PLAY** button to cancel the zoom and resuming to the slide show.

Notes: During zoom function, slide show transition and image rotation are disabled.

BUTTON FUNCTIONS

Standby ON / OFF



STANDBY

To switch the player into or out of standby mode:

Press **STANDBY** button  on the remote
or
STANDBY button on the front panel

(Always switch the player into standby mode after use)

Open / Close disc tray



OPEN

To open and close the disc tray:

Press **OPEN/CLOSE** button  on the remote
or
OPEN/CLOSE button on the front panel

Progressive/Interlaced Scan Mode

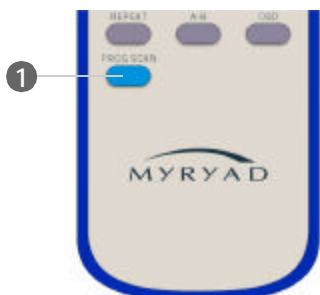

The player is equipped with two video output modes:
1) Interlaced scan video output (CVBS, S-Video, Y Pb Pr), and
2) Progressive scan video output (YPbPr only)

To switch between the two modes:

Press **PROG SCAN** button twice in stop mode with the drawer open.

Note: The first press of the **PROG SCAN** button will briefly indicate the current Video Mode, both on the TV and the front panel display:

Interlaced: "Interlace Out" on TV, "IntEr" on Front Panel
Progressive scan: "Progressive" on TV, "PS" on front panel
The second press (within approx. 3 seconds) then changes the Video Mode.

IMPORTANT NOTE

Incorrect setting of the Video Scan Mode may lead to black screen with no signal output.

If you observe this symptom, please press the PROG SCAN button to change the Video Mode.

Video EQ

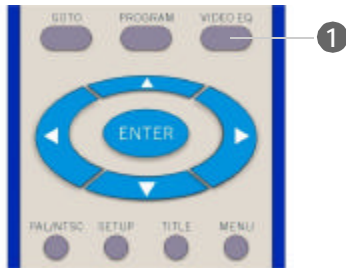

The player has a built in video equalizer, to allow the picture to be adjusted as necessary:

Press **VIDEO EQ** button, Video Equalizer menu appears:

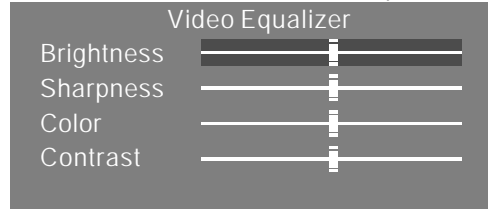

Use the UP/DOWN ARROW buttons to highlight the desired icon. Use Left/Right ARROW buttons to adjust the level.

Press **VIDEO EQ** button again to store the adjusted levels and exit the menu.

Volume level / Mute

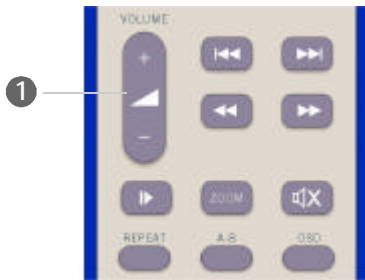

To adjust the audio volume output level.

Press the "+" or "-" volume buttons to turn the volume level up or down.

To turn the audio output off, press MUTE button once. Press the MUTE button again to resume audio output.

Note: The volume and mute controls will only be active if the player is used with Myryad amplifiers in a My-Linked system.

Play / Pause / Step/ Stop



1 Press PLAY button to play the disc.

2 Press PAUSE button to pause.

Press the P pause button repeatedly to step forward frame by frame.

Press PLAY to resume normal playback.

3 Press STOP button to stop in two modes:

a) First Press: STOP memorizes the interrupt position. (May resume with Play button)

b) Second Press: To stop completely. (Will NOT resume with Play button)

Skip Forward / Backward

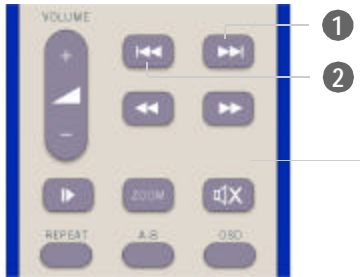

- 1 Press to skip to the next chapter
- 2 Press to skip to the previous chapter

Player will not advance or reverse during "WARNING" section of any disc.

Scan Forward / Backward

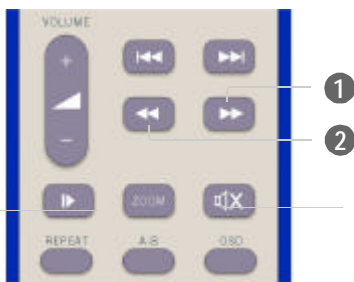

The unit is muted in SCAN mode.

- 1 Press to scan forward
Press the button repeatedly to change scan speed
X2 → X4 → X8 → X20 → X60 → X100 →
- 2 Press to scan backward
Press the button repeatedly to change scan speed
X2 → X4 → X8 → X20 → X60 → X100 →
- 3 Press **PLAY** button
to resume normal playback

Player will not advance or reverse during "WARNING" section of any disc.

Slow motion playback



The unit is muted when in SLOW mode

- 1 Press to play forwards slowly
Press the button repeatedly to play more slowly
1/2 → 1/3 → 1/4 → 1/5 →
- 2 Press **PLAY** button
to resume normal playback

Select an item in a menu

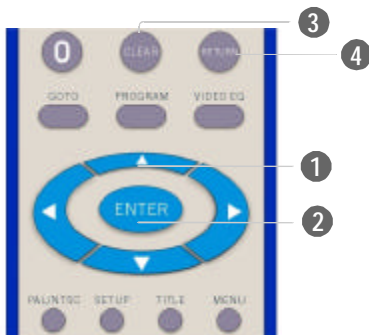

In the disc menu or setup menu

- 1 **press ARROW button** to move between menu items.
- 2 **Press ENTER** to confirm a selection.
- 3 **Press CLEAR** to cancel an entry.
- 4 **Press RETURN** to return to the previous menu.

On Screen Display Menu



- 1 **Press OSD button** to switch the OSD indicator on or off.

There are different OSD indicators for different types of disc: DVD, CD and MP3.

See "GETTING STARTED" in this manual for more details.

Disc Title / Menu

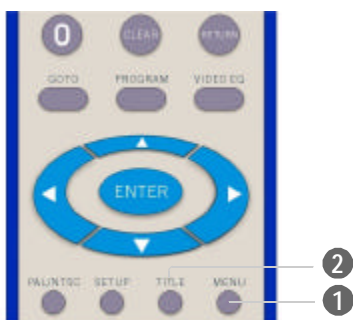

- 1 **Press MENU button** to access the DVD Menu.
- 2 **Press TITLE button** to return to the DVD Title menu.

Disc MENU Disc menu is a DVD disc feature, allowing users to select functions on screen. When playing a VCD or SVCD disc, the **MENU** key switches the PBC function "on" or "off" (which allows use of SKIP and REPEAT keys).

Disc TITLE Disc title is the first track of a DVD disc. Some DVD discs do not support the "TITLE" function.

GOTO a specific point

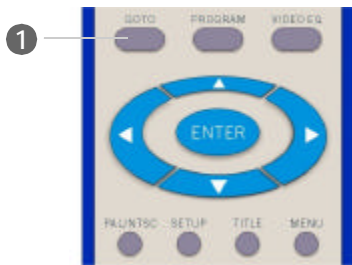

To start playback at a particular point (Time, Title or Chapter)

Press the GOTO button 
Search menu appears on screen.

In DVD mode:

Search	00:12:33	01:36:25
Time	--:--:--	
Title	--	
Chapter	18	

In CD mode:

Track Search	
Time	--:--:--
Track	--

In the Search Menu, highlight the desired search icon and input the desired data using the number keys. Press **ENTER** button to execute the search.

- NOTE**
- Some DVD discs do not allow the GOTO function.
 - GOTO does NOT function during Program playback.

Repeat

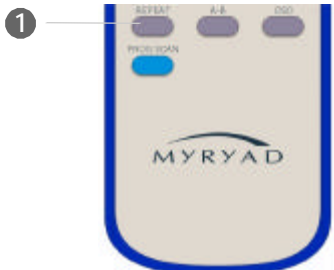

Press the REPEAT button
to activate the desired repeat mode:

In DVD mode:

Selects Chapter, Title, Disc or Off

In CD mode:

Selects Single (Track), Disc or Off

- NOTE** Some DVDs do not allow the repeat function.

A-B repeat

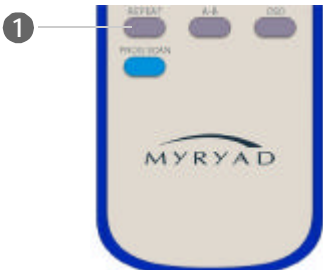

To repeat a section of the disc.

At the beginning of the desired section, "A"

Press the A-B button

At the end of the desired section, "B"

Press the A-B button again,
the player will repeat playback the section A to B

Press the A-B button to clear the setting

- NOTE** Some DVD discs do not allow A-B function.

Numeric Key Pad / Direct Program access



Direct Program access

During DVD or CD playback, enter the desired Chapter or track number using the number buttons. The player will skip directly to the Chapter (DVD) or Track (CD) chosen. If a CD has 10 tracks or more press ENTER after selecting track 1, if 20 tracks or more, press ENTER after selecting tracks 1 or 2 and so on.

Numeric input - Function / Menu

Use the numeric key pad to input data for the DVD disc menu or the player's setup menu.

Multi-Audio Soundtrack



A DVD may contains up to 8 audio tracks.

When playing a disc, press the **AUDIO** button repeatedly to select the desired audio track. The status will be displayed on screen.

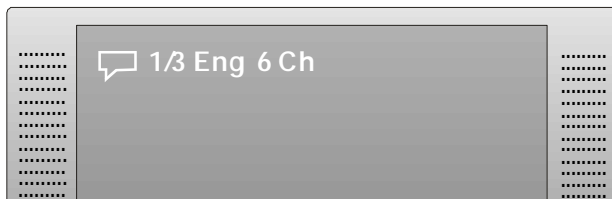

NOTE In many case, Audio Language selection will be available in the DVD disc start menu.

Multi-Angle

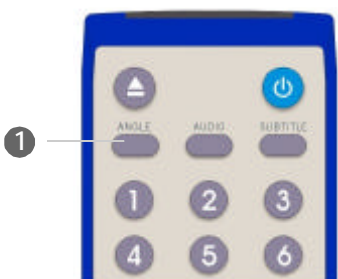

A DVD may contains up to 9 camera angles

When playing a disc, press the **ANGLE** button repeatedly to select the desired camera angle. The status will be displayed on screen.

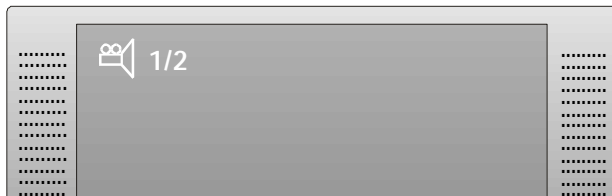

Note: Many DVDs do not contain multiple camera angles so the ANGLE button will have no effect and  will be displayed briefly in the top left corner of the screen.