

musicdock™

Executive Hi-Fidelity AM/FM Shelf system with CD player, remote control, and dock for iPod

Model KS-600
Owner's Manual





KLH Audio Systems
11131 Dora St.
Sun Valley, CA 91352

iPod not included.
iPod is a trademark of Apple Inc., registered in the US and other countries

WARNING

- TO PREVENT FIRE OR SHOCK HAZARD. DO NOT EXPOSE THIS APPLIANCE TO RAIN OR MOISTURE.
- THIS APPLIANCE SHALL NOT BE EXPOSED TO DRIPPING OR SPLASHING WATER AND THAT NO OBJECT FILLED WITH LIQUIDS SUCH AS VASES SHALL BE PLACED ON APPARATUS.

 <p>This lightning flash with arrowhead symbol, within an equilateral triangle, is intended to alert the user to the presence of uninsulated "dangerous voltage" within the product's enclosure that may be of sufficient magnitude to constitute a risk of electric shock to persons.</p>	<p>CAUTION RISK OF ELECTRIC SHOCK DO NOT OPEN</p> <p>Warning: To reduce the risk of electric shock, do not remove cover (or back) no user-serviceable parts inside. Refer servicing to qualified service personnel.</p>	 <p>The exclamation point within an equilateral triangle is intended to alert the user to the presence of important operating and maintenance (servicing) instructions in the literature accompanying the appliance.</p>
------------------------------------------------------------------------------------------------------------------------------------------------------------------------------------------------------------------------------------------------------------------------------------------------------------------------------------------------------------------------------------	------------------------------------------------------------------------------------------------------------------------------------------------------------------------------------------------------------------------------------------------------	--------------------------------------------------------------------------------------------------------------------------------------------------------------------------------------------------------------------------------------------------------------------------------------------------------------------

IMPORTANT SAFETY INSTRUCTIONS

- 1) Read these instructions.
- 2) Keep these instructions.
- 3) Heed all warnings.
- 4) Follow all instructions.
- 5) Do not use this apparatus near water.
- 6) Clean only with dry cloth.
- 7) Do not block any ventilation openings. Install in accordance with the manufacturer's instructions.
- 8) Do not install near any heat sources such as radiators, heat registers, stoves, or other apparatus (including amplifiers) that produce heat.
- 9) Do not defeat the safety purpose of the polarized or grounding-type plug. A polarized plug has two blades with one wider than the other. A grounding type plug has two blades and a third grounding prong. The wide blade or the third prong are provided for your safety. If the provided plug does not fit into your outlet, consult an electrician for replacement of the obsolete outlet.
- 10) Protect the power cord from being walked on or pinched particularly at plugs, convenience receptacles, and the point where they exit from the apparatus.

11) Only use attachments/accessories specified by the manufacturer.

12) Use only with the cart, stand, tripod, bracket, or table specified by the manufacturer, or sold with the apparatus. When a cart is used, use caution when moving the cart/apparatus combination to avoid injury from tip-over.



13) Unplug this apparatus during lightning storms or when unused for long periods of time.

14) Refer all servicing to qualified service personnel. Servicing is required when the apparatus has been damaged in any way, such as power-supply cord or plug is damaged, liquid has been spilled or objects have fallen into the apparatus, the apparatus has been exposed to rain or moisture, does not operate normally, or has been dropped.

15) Grounding or Polarization – This product may be equipped with a polarized alternating-current line plug (a plug having one blade wider than the other). This plug will fit into the power outlet only one way. This is a safety feature. If you are unable to insert the plug fully into the outlet, try reversing the plug. If the plug should still fail to fit, contact your electrician to replace your obsolete outlet. Do not defeat the safety purpose of the polarized plug.

16) Ventilation – Slots and openings in the cabinet are provided for ventilation and to ensure reliable operation of the product and to protect it from overheating, and these openings must not be blocked or covered. The openings should never be blocked by placing the product on a bed, sofa, rug, or other similar surface. This product should not be placed in a built-in installation such as a bookcase or rack unless proper ventilation is provided or the manufacturer's instructions have been adhered to.

17) The MAINS plug or an appliance coupler is used as the disconnect device, the disconnect device shall remain readily operable.

18) The use of controls or adjustments or performance of procedures other than those specified herein may result in hazardous radiation exposure.

19) The Caution Mark is located on the bottom of the product.

FCC Statement

This equipment has been tested and found to comply with the limits for a Class B digital device, pursuant to Part 15 of the FCC Rules. These limits are designed to promote reasonable protection against harmful interference in a residential installation. This equipment generates, uses, and can radiate radio frequency energy and, if not installed and used in accordance with the instructions, may cause harmful interference to radio communications. However, there is no guarantee that interference will not occur in a particular installation. If this equipment does cause harmful interference to radio or television reception, which can be determined by turning the equipment off and on, the user is encouraged to try to correct the interference by one of more of the following measures:

- Reorient or relocate the equipment and/or the receiving antenna.
- Increase the separation between the equipment and receiver.
- Connect the equipment into an outlet on a circuit different from that to which the receiver is connected.
- Consult the dealer or an experienced radio/TV technician for help.

CAUTION

Changes or modifications to this equipment not expressly approved by KLH for compliance will void the user's warranty.

TABLE OF CONTENTS:

Page

Antenna – AM	6
Antenna – FM	6
Aux input	16
Battery for remote	5
Clock	10
Clock – viewing while listening to radio	11
Control locations	7
CR2032 battery	5
Dock for iPod	12
Electrical power	6
FCC	3
Feature descriptions	8
Feature identification	7
Headphones, using with	16
iPod, using with	12
Packing list	5
Placement of KS-600	6
Playback order – CD	15
Preparing for use	5
Presets – favorite radio stations	11
Programmed playback order – CD	15
Programming on/off times	11
Radio	10
Remote control	5
Repeat – CD	15
Repeat – iPod	14
Setting the clock	10
Setting the turn on and off times	11
Shuffle mode – CD	14
Shuffle mode – iPod	13
Sleep function	17
Speakers	5
Storing favorite stations	11
Time display w/ Radio playing	11
Timer	11
Troubleshooting	17
Tuner	10
Unpack	5
User notes	19
Video output from iPod using w/ TV	13
Warranty	20

Thank you for purchasing the **musicdock™** by KLH model KS-600 AM/FM executive shelf system with CD player, dock for iPod, and remote control. With proper care this system should provide many years of reliable operation.

UNPACK and verify that all accessories are present. Here is what is included:

1. The main unit
2. Two speakers
3. iPod dock w/ adjustable support
4. AM Loop antenna
5. Base for AM loop antenna
6. FM wire antenna
7. 3.5 mm to 3.5 mm interconnect cable
8. Remote control
9. Battery for remote control (may be installed)
10. This instruction booklet

PREPARING THE KS-600 FOR USE

Unroll the wire from the right speaker. Grip the side of the wire that is marked with a dashed line. Depress the R+ (red) thumb tab and insert the bare wire end into the oval hole. Release the thumb tab to complete the connection. Connect the unmarked side of the R speaker wire to the black R terminal. Similarly, connect the left speaker to the left speaker terminals. The speaker terminals are identified as **(30)** on the control and feature identification drawing.

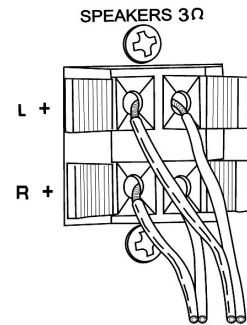

If you will be using the KS-600 with an iPod, insert the plug at the end of the dock cable into the socket **(27)** on the right side of the KC-600. **DO NOT** twist the plug to achieve alignment, as this **WILL** damage the plug. This dock only needs to be connected if you will be using an iPod with the KS-600.

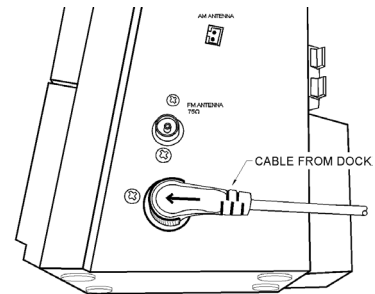

Install the **CR2032** "coin" cell **BATTERY** in the remote control. To do accomplish, press down and pull back to remove the battery compartment cover. Insert the battery with the large smooth surface marked with a + up as shown in the photo. Replace the cover.

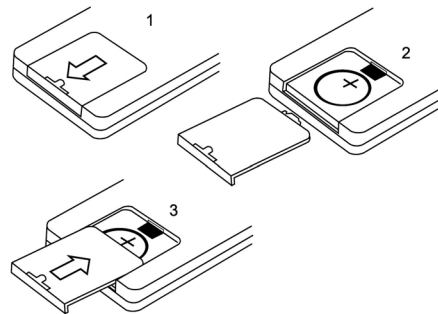

Replace this battery when the remote's operating range deteriorates.

ANTENNAS – AM AND FM

Unpack the **AM** antenna and snap its cylindrical end onto the base/mounting plate. Stretch out the twisted cord and insert the small rectangular plug at the end into the socket (29) located on the side of the main unit. Note, this plug is keyed and only fits one way. Orient the AM antenna for best reception of your favorite AM station.

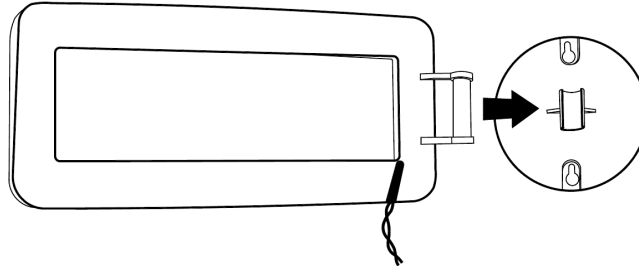

Locate the **FM** wire antenna and stretch it out. The plastic connector on the end of this wire should be pressed onto the center post of the FM antenna connector (28) on the right side of the KS-600. Some force may be necessary to accomplish this. Position this antenna for best reception of your favorite FM station.

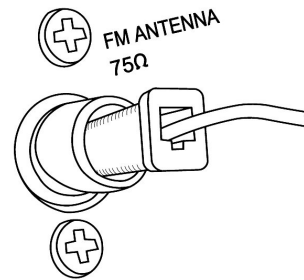

SELECT A LOCATION for your KS-600

Because the KS-600 generates heat during operation it is necessary to provide open space around it for proper cooling. Failure to do so can significantly reduce the service life. Do not place the KS-600 near a heater or in direct sunlight. The KS-600 should not be placed atop electronic devices that generate heat.

In most situations the best radio reception will be had when the KS-600 and its antennas are near a window.

For proper remote control operation there must be an unobstructed path between the remote and the KS-600 face.

The KS-600 includes an aux input allowing external devices with a headphone output to be played through the KS-600. If this feature will be used, keep in mind the length of the interconnect cable needed when selecting the location.



CONNECT POWER

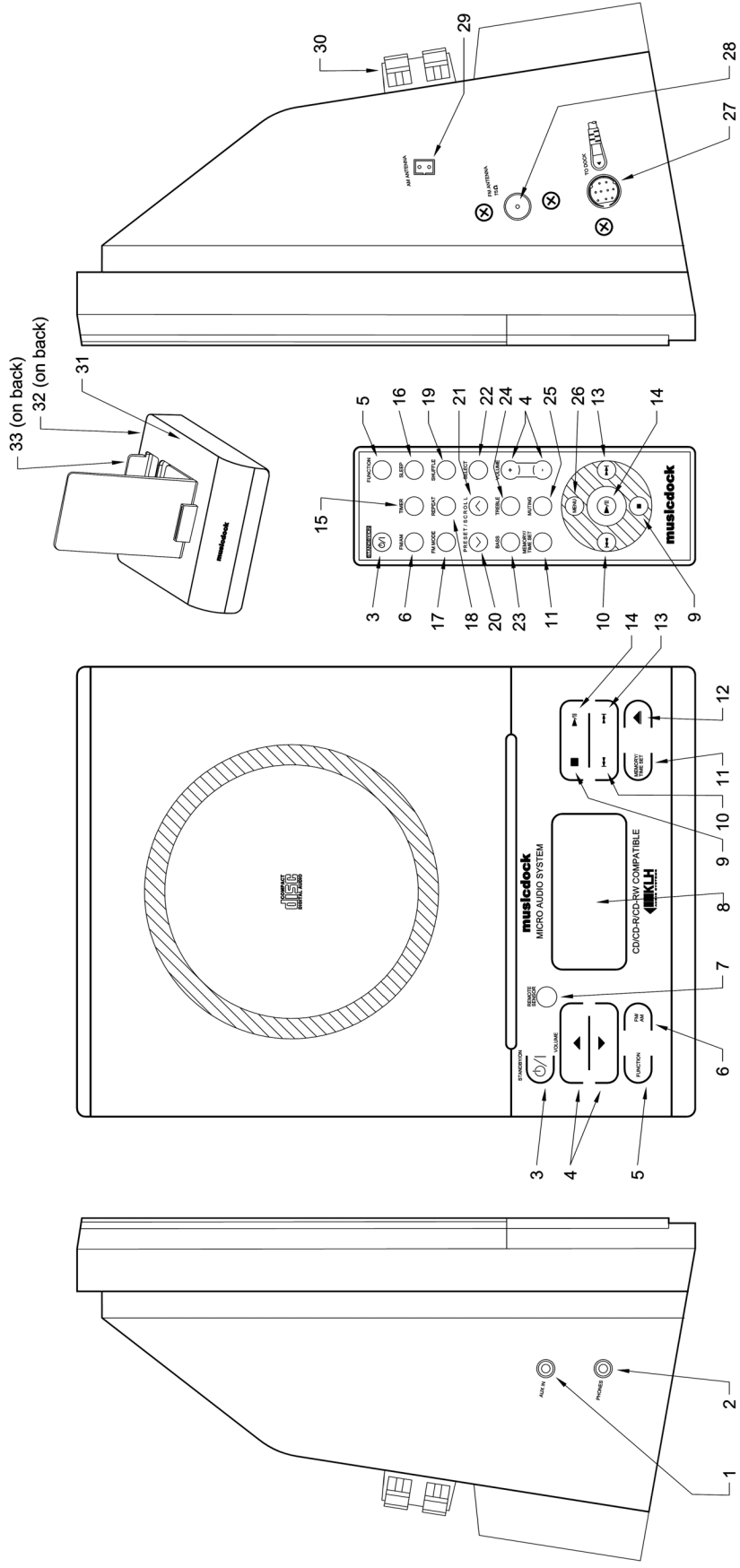

Plug the Power cord into an un-switched electrical outlet. Press the STANDBY/ON button to verify that the blue panel lights come on.

CONTROL AND FEATURE IDENTIFICATION



CONTROL AND FEATURE DESCRIPTIONS

- 1:** 3.5 mm AUXILIARY INPUT allows a personal music player, TV, computer or any other device with a headphone output to be played through the KS-600.
- 2:** PHONE output. Plug in conventional stereo headphones or ear buds here for personal listening.
- 3:** STANDBY/ON – basically the “power switch”. Note: this switch does not completely power down the KS-600. If the KS-600 will not be used for a long period of time, it should be unplugged to save energy. In standby mode, the KS-600 consumes approximately 5-watts.
- 4:** VOLUME. With the unit playing, these controls increase or decrease the sound level.
- 5:** FUNCTION – selects iPod, AUX, CD, or TUNER.
- 6:** FM/AM selector – switches between FM and AM radio bands.
- 7:** REMOTE SENSOR window. Point the remote control toward this window for best remote control range.
- 8:** MAIN DISPLAY WINDOW provides information specific to the selected operating mode of the KS-600.
- 9:** STOP button. Used to halt play of the CD, *but not of the iPod*.
- 10:** TUNING DOWN/SKIP  In TUNER mode (AM or FM) decreases the received frequency. When an iPod or CD is present and playing, controls the tracks, or if held down, allows searching within the current track.
- 11:** MEMORY/TIME SET dual function button. In TUNER mode, used to store a radio station frequency for quick access. Also used to set the built-in clock.
- 12:** OPEN/CLOSE used to raise or lower the CD drive cover providing access to the CD spindle.
- 13:** TUNING UP/SKIP  In TUNER mode (AM or FM) increases the received frequency. When an iPod or CD is present and playing, controls the tracks, or if held down, allows searching within the current track.
- 14:** PLAY/PAUSE  used to start and pause CD or iPod playback.
- 15:** TIMER used to setup turn on and turn off times.

- 16:** SLEEP button – sets a countdown timer to silence the KS-600 after the user has gone to sleep.
- 17:** FM MODE Overrides automatic switching between stereo and mono modes. Use this control to force mono operation, which is less susceptible to background hiss and noise when the received FM stereo signal is weak.
- 18:** REPEAT used in CD and iPod mode to repeat selections.
- 19:** SHUFFLE used to play back available tracks in random order.
- 20:** PRESET/SCROLL down  – in TUNER mode, used to select a lower pre-set station number. In iPod mode, scrolls down the menu.
- 21:** PRESET/SCROLL up  – in TUNER mode, used to select a higher pre-set station number. In iPod mode, scrolls up the menu.
- 22:** SELECT duplicates the function of the center button on the iPod. Used to confirm menu selections.
- 23:** BASS Press this button and then use the volume up/down buttons to set the bass level to your liking.
- 24:** TREBLE Press this button and then use the volume up/down buttons to set the treble level to your liking.
- 25:** MUTING Press once to silence the KS-600 momentarily. Press again to un-mute.
- 26:** MENU duplicates the function of the iPod menu button.
- 27:** iPod DOCK connector. Insert the plug at the end of the iPod dock cord into this socket. Do not twist the plug. Orient the plug so that the wire runs to the back before inserting it.
- 28:** FM antenna connector. Connect the supplied FM wire antenna here. If an outdoor FM antenna is available, the cable from it can be connected here.
- 29:** AM antenna connector. Connect the supplied AM loop antenna here.
- 30:** SPEAKER quick-connect terminals. Attach speaker wires here.
- 31:** iPod dock.
- 32:** Composite video out
- 33:** S-Video out

SETTING THE CLOCK

Note: You must progress through the following process with less than 7 seconds between steps to avoid dropping out of time set mode.

1. If the KS-600 is playing, press the STANDBY/ON button **(3)** to enter standby mode.
2. Hold the MEMORY/TIME SET button **(11)** down for 3 seconds. The time display will begin flashing. *Note: If this function is accidentally activated do nothing and normal operation will resume after 7 seconds.*
3. Within 7 seconds, press either of the TUNING UP/DOWN/SKIP **◀◀▶▶▶▶** buttons **(10 or 13)** to select 12 or 24 hour mode.
4. Within 7 seconds, press the TUNING UP/DOWN/SKIP **◀◀▶▶▶▶** buttons **(10 or 13)** to set the hour. In the 12-hour mode, you must step through the AM hours to set PM hours. AM and PM icons are displayed in the main window **(8)**.
5. Press MEMORY/TIME SET **(11)** to advance to minute setting. As before, within 7 seconds, use the TUNING UP/DOWN/SKIP **◀◀▶▶▶▶** buttons **(10 and 13)** to set the minute.
6. Within 7 seconds, press the MEMORY/TIME SET **(11)** button one last time to finalize the setting. The seconds (not displayed) will start from 00 when you complete this step.

USING THE RADIO



1. Press the STANDBY/ON button **(3)** to turn the unit on. If the radio does not begin playing, press FUNCTION button **(5)** to select TUNER.
2. Use the FM/AM button **(6)** to select the FM or AM band.
3. Use the TUNING/SKIP UP/DOWN **◀◀▶▶▶▶** buttons **(10 and 13)** to tune the radio. There are two tuning modes. Briefly pressing either **(10)** or **(13)** changes the tuning frequency in 100 kHz steps on FM or 10 kHz on AM. Press and hold either SKIP button for 1 second then release and the radio will automatically tune to the next receivable station.
4. Radio reception is strongly influenced by antenna placement. Tune in your favorite AM or FM station and position the respective antenna for best reception.

5. To **DISPLAY THE CLOCK** while listening to the radio, press and hold the MEMORY/TIME SET button **(11)** for 3 seconds. The current time will display for 4 seconds.



STORING FAVORITE STATIONS for easy access using **PRESETS**

1. Tune to an AM or FM station that you wish to add to your favorites.
2. From the remote control, briefly press the MEMORY/TIME SET button **(11)** and *within 5 seconds*, press one of the PRESET/SCROLL  buttons **(20 or 21)** 1 to 10 times to choose location 1 to 10 to store the station on, and, *within 5 seconds* press the MEMORY/TIME SET button **(11)** to store.
3. Repeat the above process to store up to 10 AM and 10 FM favorites.

ACCESSING PRESET STATIONS

1. Turn the KS-600 on. Use the FUNCTION button **(5)** to select TUNER. Use the FM/AM button **(6)** to select AM or FM.
2. Press either of the PRESET/SCROLL  buttons **(20 or 21)**, to step through the stored stations until the desired station is received. Note: the PRESET/SCROLL  buttons are located on the remote control.

PROGRAMMING THE TIMER The KS-600 features a timer that can be programmed to turn the unit on and off at specified times. The clock **MUST** be set prior to using this feature. Note: While programming the timer mode, you must progress through the following steps with no more than 7 seconds between button pushes to avoid having the TIMER mode cancel.

1. Press and hold the TIMER button **(15)** until the hour display begins to flash and TIME ON shows on the display **(8)**.
2. While the hour is flashing, use the TUNING UP/DOWN/SKIP  buttons **(10 or 13)** to set the hour that you wish the KS-600 to begin playing.
3. Press TIMER **(15)** once to advance to minute setting.
4. While the minutes are flashing, use the TUNING UP/DOWN/SKIP  buttons **(10 or 13)** to set the minutes to when you wish the KS-600 to begin playing.
5. Press TIMER **(15)** once more to advance to the TIME OFF setting. The Hours will begin flashing.

6. Use the TUNING UP/DOWN/SKIP **⏪⏩** buttons **(10 or 13)** to set the hour that you wish the KS-600 to stop playing.
7. Press TIMER **(15)** once again to advance to the TIME OFF minute setting.
8. While the minutes are flashing, use the TUNING UP/DOWN/SKIP **⏪⏩** buttons **(10 or 13)** to set the minutes for when you wish the KS-600 to stop playing.
9. Press TIMER **(15)** once again.
10. Use the TUNING UP/DOWN/SKIP **⏪⏩** buttons **(10 or 13)** to select iPod, CD, or TUNER.
11. Press TIMER **(15)** once again.
12. Use the TUNING UP/DOWN/SKIP **⏪⏩** buttons **(10 or 13)** to set the volume level that the KS-600 will come on with.
13. Press TIMER **(15)** to finalize the setting. "TIMER" will be displayed in the main window **(8)** when the timer mode is active.
14. De-activate or re-activate the timer mode by briefly pressing the TIMER button **(15)**. After activating the timer this way, the main display **(8)** will cycle through the current timer settings for your review. When the timer is active, TIMER will show in the main display **(8)**.

USING YOUR iPod WITH THE KS-600

1. If you have not already done so, locate the iPod dock **(31)** and plug its cord into the connector **(27)** on the right side of the KS-600.
2. Mount your iPod on the dock as shown and adjust the brace to fit snugly against the back of the iPod to prevent the iPod from rocking back when its controls are used.
3. **IMPORTANT:** Each time the iPod is mounted, it is necessary to initiate play once using the iPod's controls. This step makes the KS-600 and the iPod aware of each other.
4. After step 3 has been completed, selecting CD, TUNER, or AUX on the KS-600 will place the iPod in standby mode. When iPod is selected again using the FUNCTION button **(5)**, the iPod will

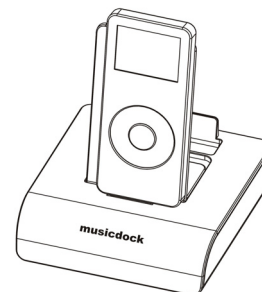
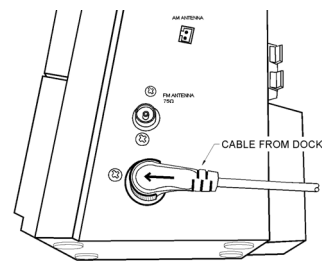

resume play – unless it was removed from the dock in the interim, in which case it will be necessary to re-introduce the iPod to the KS-600 as described in step 3.

5. Use the TUNING UP/DOWN/SKIP **⏮⏪⏩⏭** buttons **(10 or 13)** to change tracks. If pressed and held, these buttons allow rapid scanning within a track.
6. The MENU button **(26)** duplicates the function of the MENU button on the iPod.
7. The SELECT button **(22)** duplicates the function of the center button on the iPod.
8. Use the PRESET/SCROLL **^**/**v** buttons **(20 or 21)** in conjunction with the SELECT button **(22)** to navigate through the iPods menu selections.
9. To temporarily suspend playback, press the PLAY/PAUSE **▶/||** button **(14)**. To resume playback, press this button again.
10. Press the SHUFFLE button **(19)** to mix up the order in which songs are played. The shuffle icon **↻** will appear on the iPods display screen when the shuffle mode is active. Pressing the SHUFFLE button repeatedly cycles through the following choices: Songs – Albums – Off
11. Press the REPEAT button **(18)** during playback to activate repeat on the iPod. Each press of this button cycles through One – All – Off. The status of this function is indicated on the iPods display. Repeat the current track is indicated by the **↺** icon. Repeat all is indicated by the **↻** icon.
12. The KS-600 will fully charge an iPod when the iPod is mounted in the dock and the KS-600's line cord is plugged into an AC outlet.
13. The STOP button **(9)** does NOT function in the iPod mode. This button is a CD specific control.





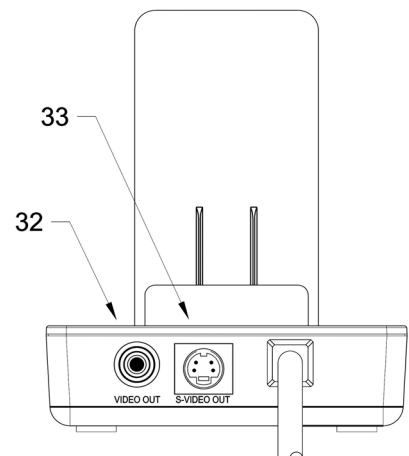

VIDEO OUTPUT FROM YOUR iPod

1. **Composite video (32)** and **S-Video (33)** outputs are located on the back of the docking station. If you have a *video* iPod, you can view videos from it on your TV via these connections. Obtain a composite or S-Video cable (sold separately) and connect either of the outputs on the dock to a video input on your TV.



2. To view video from the iPod on a TV, you must change one iPod setting. From the iPod screen, go to Videos / Video Settings. Change “TV” Out to “Ask”. From this point on, when you select a video on the iPod, the iPod will ask you to select “TV Off” or “TV On”. Select “TV On” to view on your TV, or “TV Off” to view on the iPod’s screen. When playing a video, you will hear the sound through the KS-600, and the picture will be fed to the TV via the cable attached to **(32)** or **(33)**. You must select the input on your TV that this cable is attached to. Details will be found in the TV’s instruction book.

PLAYING A CD

1. Press the FUNCTION button **(5)** until CD shows in the main display window **(8)**.
2. When no CD is present, the display will show “no cd”.
3. Press OPEN/CLOSE  **(12)** to raise the CD protective panel.
4. Mount a CD on the spindle with the label facing out. Be sure that the CD is firmly held by the grips on the spindle.
5. Press OPEN/CLOSE  **(12)** to lower the CD protective panel.
6. After a few seconds, the main display window **(8)** will show the statistics for the disc. The total number of tracks on the disc will be on the left and the total length of the CD in minutes and seconds is on the right.
7. Press PLAY/PAUSE  **(14)** to start playback of the disc.
8. When playback starts, the display will show the number of the track that is playing and the elapsed time.
9. Press PLAY/PAUSE  **(14)** to suspend playback of the disc.
10. To stop playback, press the STOP button **(9)**.
11. To increment or decrement the track, press TUNING UP/DOWN/SKIP   buttons **(10 or 13)**. If pressed and held, these buttons allow rapid scanning within a track.
12. Press REPEAT **(18)** to repeat a track or the entire disc. Each push of this button cycles REPEAT – REPEAT ALL – OFF. Note: Pressing STOP **(9)**, FUNCTION **(5)**, FM/AM **(6)**, OPEN/CLOSE **(12)**, or STANDBY/ON **(3)** will cancel the repeat function.

13. Press the SHUFFLE button **(19)** to initiate random playback of tracks. "SHUFFLE" will be displayed in the main window **(8)**. Pressing TUNING UP/DOWN/SKIP **⏮⏪⏩⏭** buttons **(10 or 13)** will select another track randomly. A track cannot be repeated during shuffle playback. Note: Pressing STOP **(9)**, FUNCTION **(5)**, FM/AM **(6)**, OPEN/CLOSE **(12)**, or STANDBY/ON **(3)** will cancel the shuffle function.
14. Shuffle mode cannot be initiated during repeat once playback or programmed playback.

PROGRAMMED PLAYBACK

By using this function, you can program up to 32 tracks of a CD to play in any desired order. Note: This is a CD only function. It is not available during iPod playback.

1. Press the FUNCTION button **(5)** until CD shows in the main display window **(8)**.
2. Press the MEMORY/TIME SET button **(11)** and notice that blinking "MEMORY" and "P-01" show in the main display window **(8)**.
3. Press TUNING UP/DOWN/SKIP **⏮⏪⏩⏭** buttons **(10 or 13)** to select a track and then press the MEMORY/TIME SET button **(11)**.
4. Notice that "P-02" now shows indicating that the unit is ready to store your next selection in playback slot number 2. Select the next track using the TUNING UP/DOWN/SKIP **⏮⏪⏩⏭** buttons **(10 or 13)** and press the MEMORY/TIME SET button **(11)** to store this track in memory.
5. Repeat the above process to store up to 32 tracks.
6. When you have completed programming the tracks in the order that you wish to hear them, press the PLAY/PAUSE **▶/||** button **(14)** to initiate programmed playback.
7. Press the STOP button **(9)** to cancel programmed playback.
8. After programmed playback has finished playing back all of the tracks that were programmed, the memory indicator will go off.
9. Your track program will remain in memory and can be re-activated by pressing the MEMORY/TIME SET button **(11)** followed by the PLAY/PAUSE **▶/||** button **(14)**.

used with the KS-600; however, an adapter (not supplied) is required. Suitable adapters are available at most electronic stores.

USING THE SLEEP FUNCTION:

Press the SLEEP button **(16)** to activate the sleep timer. This feature automatically silences the KS-600 after a 90, 60, or 30-minute delay, allowing the user to go to sleep to music. Pressing the sleep button a fourth time during the 90, 60, 30 selection process displays 00, meaning that the sleep function is disabled. While the sleep timer is running, you can check the remaining time by pressing the sleep button once.

TROUBLESHOOTING:

Power button does not turn the unit on.

Is the unit plugged in?

Check the outlet to make sure it has power. Is it a switched outlet? Plug in a light and verify that the electrical outlet is live.

No sound through speakers.

Check the connections to the speakers. Only the bare wire tips should enter the oval shaped holes on the speaker connectors.

Confirm that the correct source is selected. Try FM or AM radio.

See if headphones are plugged into the headphone jack. Having headphones plugged in will silence the speakers.

Is the volume turned up?

Is the sound "muted"? If so, un-mute the sound.

Remote control does not function.

Check the battery in the remote control. If you have a cell phone camera, camcorder, web cam, or digital camera, have someone point the remote toward the camera and start pressing buttons. If the battery is good, the camera's display will show the light on the end of the remote flashing. This light is invisible to the eye, but electronic cameras can see it.

Confirm that there are no obstructions blocking the remote sensor window on the front of the KS-600.

Is the remote more than 15 feet from the KS-600? If so, move closer.

Is there sunlight or other strong light falling on the remote sensor window on the face of the KS-600? If so, relocate the KS-600, shade it, or eliminate the source of strong light.

iPod problems:

If you cannot hear the iPod through the KS-600 or the iPod does not respond to the controls on the KS-600, check the following:

After mounting the iPod on the dock, you must initiate play using the iPod's controls once. Each time the iPod is removed from the dock, this step must be repeated. This action makes the microprocessors inside the iPod and the KS-600 aware of each other.

Use the function button to re-select iPod mode.

Remove the iPod wait 10 seconds, and re-mount it. Restart play from the iPod's controls.

Is the KS-600 muted?

Is the volume turned up?

Is the dock firmly plugged into the connector on the side of the KS-600?

Confirm that your iPod's firmware is up to date. This is accomplished through iTunes while your iPod is connected to your computer and with your computer on-line. Further instructions are available within iTunes.

You hear sound from your video iPod, but there is no picture on an external TV hooked to the dock, check the following:

In the iPod menu, verify that "TV On" was selected.

Check to see that the video cable is properly inserted at both the dock and TV ends.

Make sure that the correct video input is selected on your TV set.

CD Player problems:

CDs will not play at all or they skip

Check that the CD is securely mounted on the spindle and that the printed side of the CD is facing out.

Is the playback side of the CD clean? To clean a CD, use a damp cloth and wipe from the center outward. Never clean a CD with a circular motion.

If the CD is a home recorded CD or a homemade copy of a CD, be sure that the CD was finalized. For more information on finalization, consult the documentation for the CD burning software that was used to create the CD.

Never attempt to play CDs that are warped, cracked, de-laminated, or that have been mechanically damaged.

Never play a CD that has tape or anything else attached to its surface that could throw it out of balance. CDs spin at high speeds and anything that unbalances them can cause wobble which eventually damages the transport or laser focusing system.

Radio Problems:

Poor or no reception

Check that the AM and FM antennas are connected.

Move the antennas to a position near a window.

Experiment with antenna placement.

Static and distortion are usually caused by weak signals or multi-path, from reflections off of buildings and hills. The best solution for these problems is usually an outdoor antenna. Static can also be caused by nearby fluorescent lights and computers. In these cases, relocating the KS-600 and or its antennas is the best solution.

If you are a great distance from the nearest city, an outdoor antenna may be needed to receive FM broadcasts.

USER NOTES – where & when purchased, price paid, serial number etc.:

WARRANTY

ONE-YEAR NEW PRODUCT WARRANTY

VALID ONLY IN THE U.S.A. ON NON-REFURBISHED PRODUCTS

This **musicdock™** by KLH product is warranted to be free from defects in workmanship and materials under normal use and service for a period of one year from the date of original purchase. During the warranty period, KLH agrees to repair or replace defective components without charge to the original purchaser. To obtain service, the purchaser must return the component to KLH. The purchaser will pay all costs incurred in returning product to KLH. KLH assumes no risk until the product is accepted at our facility. Upon receipt and at its sole discretion, KLH will repair or replace defective component using new or refurbished parts. KLH agrees to return product to the purchaser prepaid, by the shipment method of its choice. Replaced components are warranted to be free from defects in workmanship and materials for the balance of the original product's warranty period based on the original purchase date.

To obtain service under this warranty, a legible **COPY** of the original dated purchase invoice must be included with the returned product. Do not send the original invoice.

The liability of KLH will be limited to the purchase price of the product, and KLH will not be liable for incidental or consequential damages. KLH limits its obligations under any implied warranties under state laws to a length of time not to exceed the warranty period. Some states do not allow limitations on the length of an implied warranty. Additionally, some states do not allow the exclusion or limitation of incidental or consequential damages. The above limitations or exclusions may not apply to you. This warranty gives you specific legal rights, and you may have other rights, which vary, from state to state.

**KLH Audio Systems
11131 Dora Street
Sun Valley, CA 91352**

Customer service: (818) 767-2843 ext. 117