



Advanced Integrated Reception

## Automatic Satellite System with built-in digital off-air antenna

### KD-2200 Stationary KD-3200 In-Motion

#### Installation and Operating Instructions



*Digital TV Solutions for Mobile Markets*

11200 Hampshire Avenue South, Bloomington, MN 55438-2453  
Phone: (952) 922-6889 Fax: (952) 922-8424

[www.kingcontrols.com](http://www.kingcontrols.com)



## IMPORTANT!

The TV market is expanding and changing. The information in this manual was accurate at the time of printing. If your *King-Dome<sup>AIR</sup>* does not operate as outlined in this manual please call King Controls at (952) 922-6889 or visit our website at [www.kingcontrols.com](http://www.kingcontrols.com).

The *King-Dome<sup>AIR</sup>* is factory pre-set for DIRECTV® standard digital programming broadcast from the 101° W satellite. If you also receive your local channels from DIRECTV's 119 satellite or if you subscribe to DISH® or Bell TV programming, **YOU MUST RECONFIGURE THE ANTENNA** to work with your satellite service. Doing this will allow the *King-Dome<sup>AIR</sup>* to lock on the correct satellites to receive your programming and also enable automatic satellite switching via the receiver's remote control for multi-satellite service.

Antenna configuration is a one time procedure that **MUST BE COMPLETED** before using your *King-Dome<sup>AIR</sup>* antenna. Configuration may be done with the supplied wall mount controller, or the #1844 Keypad (dealer tool). See the antenna configuration section in this manual for specific instructions.

The *King-Dome<sup>AIR</sup>* can receive available HDTV programming from DIRECTV Ku band satellites at 101° and 119°. It will not receive channels broadcast from DIRECTV's Ka band satellites at 99° and 103°.

Please read this entire manual before beginning the installation.

## TABLE OF CONTENTS

Section	Contents	Page
1.	INTRODUCTION.....	2
2.	DEFINITION OF TERMS.....	3
3.	INSTALLATION.....	4-13
4.	ANTENNA CONFIGURATION.....	15-31
5.	SATELLITE ANTENNA OPERATION.....	32-35
6.	OFF-AIR ANTENNA OPERATION.....	36-38
7.	TROUBLESHOOTING.....	39
8.	MAINTENANCE.....	40
9.	LIMITED WARRANTY.....	41

The *King-Dome*<sup>AIR</sup> 2200 and 3200 Satellite Systems include 2 main components (**Fig. 1**).

- |                     |  |
|---------------------|--|
| Dome (Antenna) Unit | Located on the roof of the vehicle. The satellite dish, off-air antenna and electronics are covered by a protective dome that keeps operational components free from the elements. |
| Controller          | Located in the vehicle. Activates the search mode and provides limited diagnostic functions using the status light.  |

Note: A TV, satellite receiver, and program subscription are also required for satellite TV viewing (sold separately).

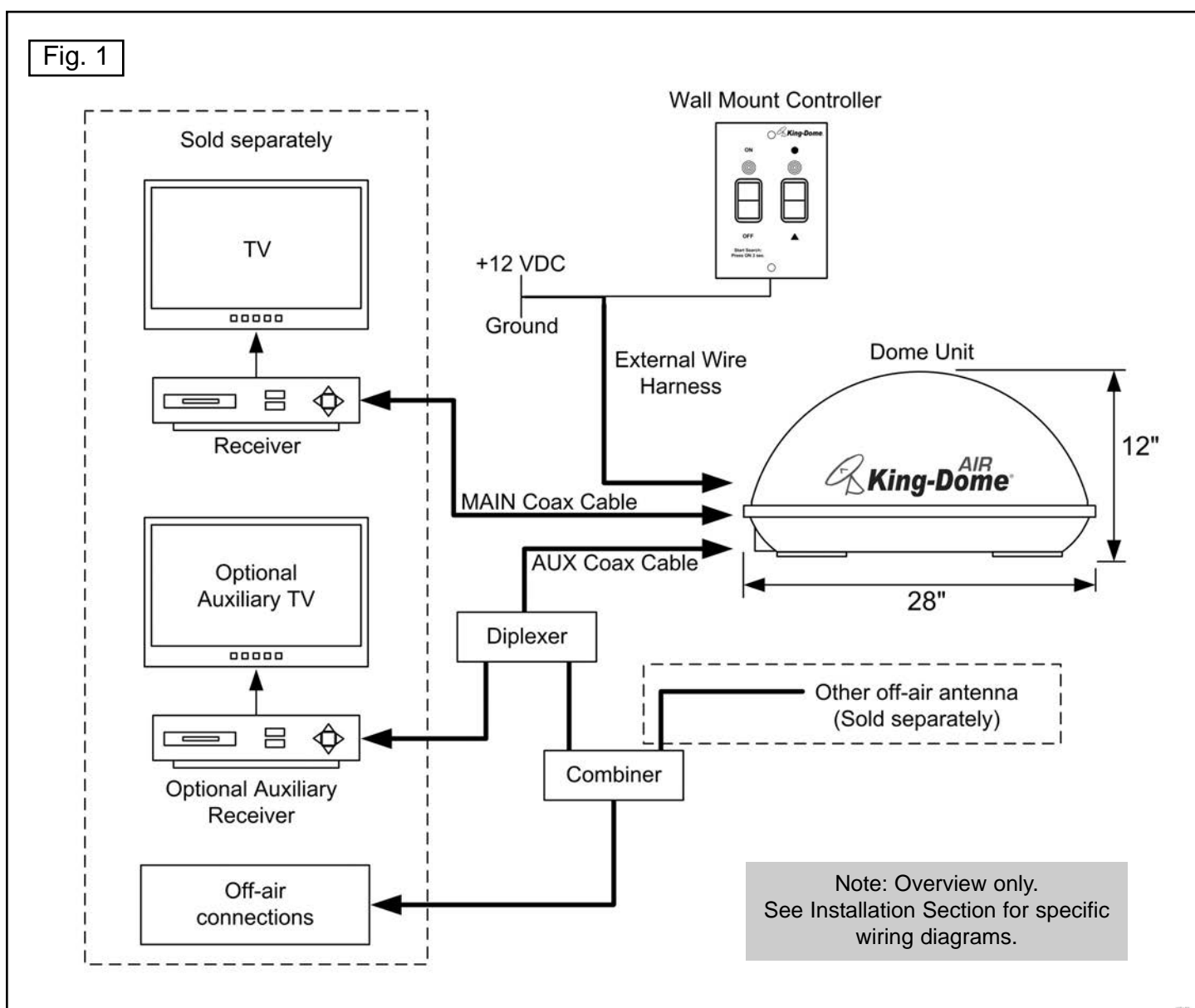

**AZIMUTH:** Circular rotation around the vehicle. Using the clock as a reference, the front of the vehicle is 12:00, and the rear is 6:00 (**Fig. 2**).

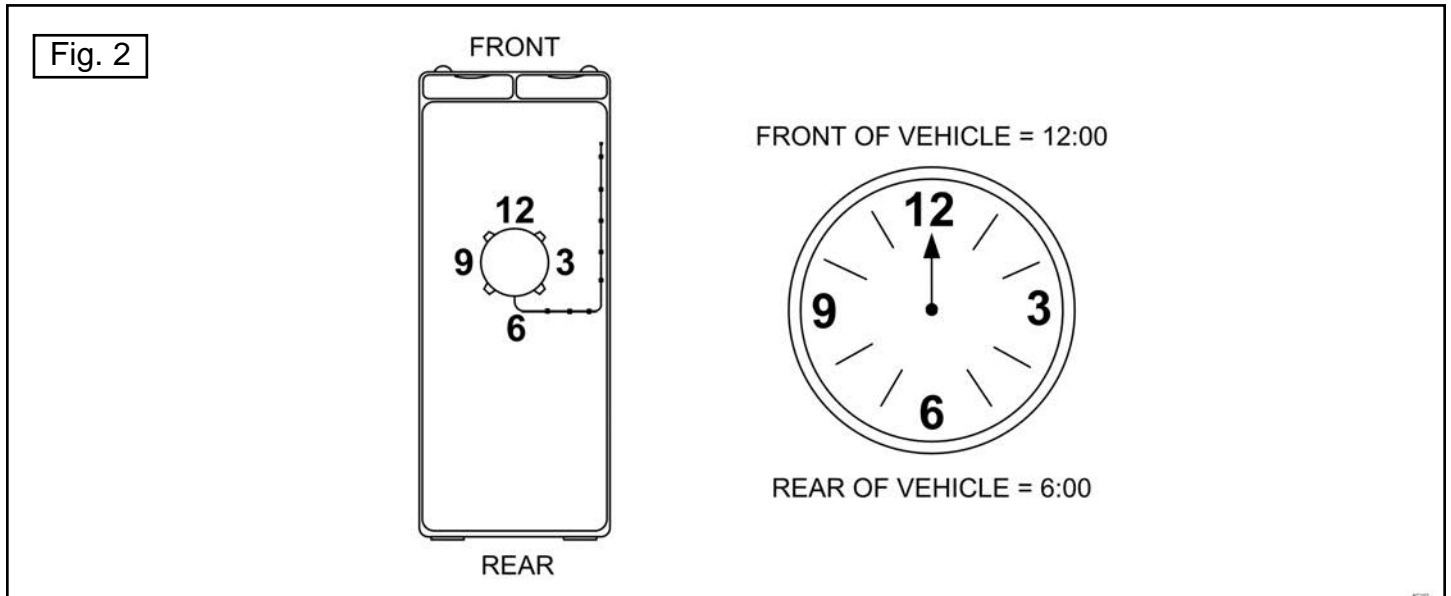

**ELEVATION:** Angle in degrees measured from a level plane (**Fig. 3**).

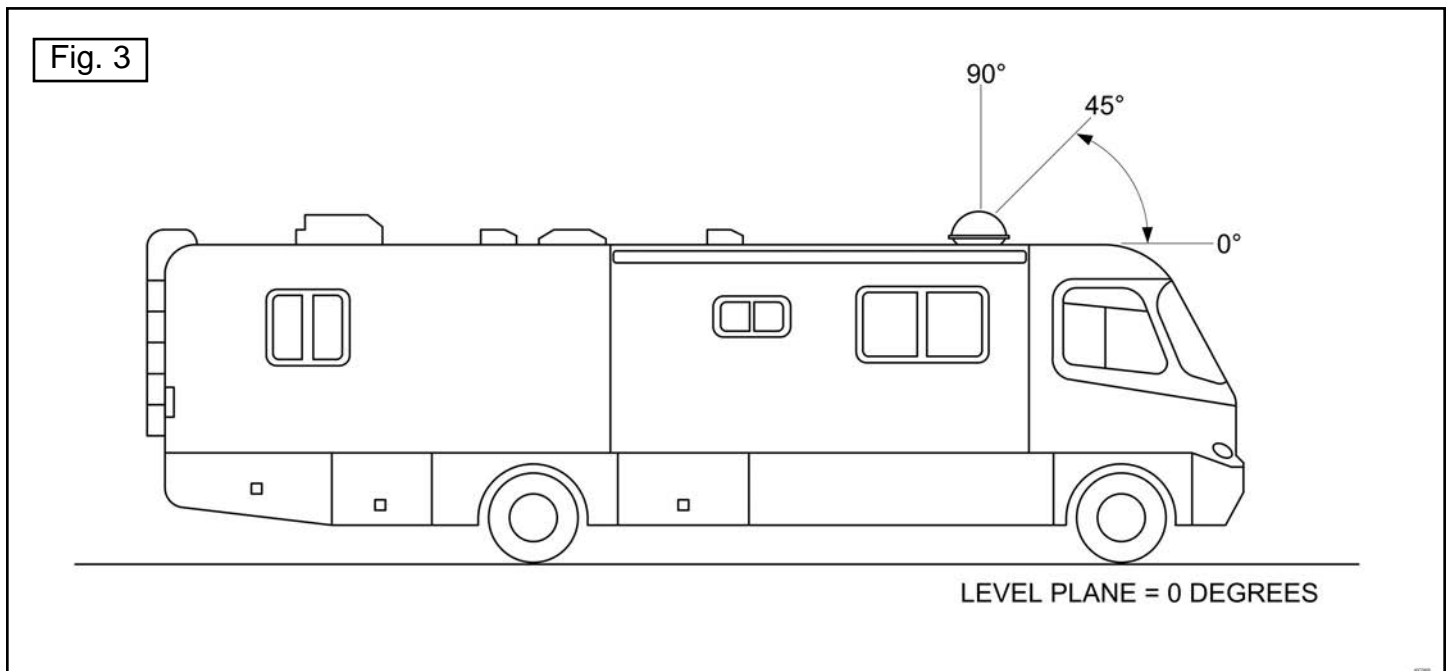

**SIGNAL STRENGTH:** Intensity of signal received from the satellite or off-air transmission.

## TOOLS AND MATERIALS REQUIRED

- drill and drill bit set
- tape measure
- 7/16" open end wrench (coax connections)
- adhesive sealant (compatible with roof material)
- appropriate fasteners to install all components and wiring
- 5/32" allen wrench, channel lock or pliers (to remove shipping bolts)
- wire cutter (to remove shipping tie strap)
- Optional: #1844 King Controls Keypad

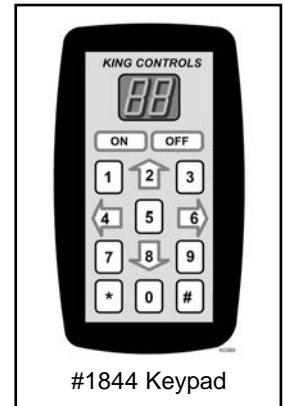

## KIT CONTENTS

1. Unpack and identify all components (**Fig. 4**).

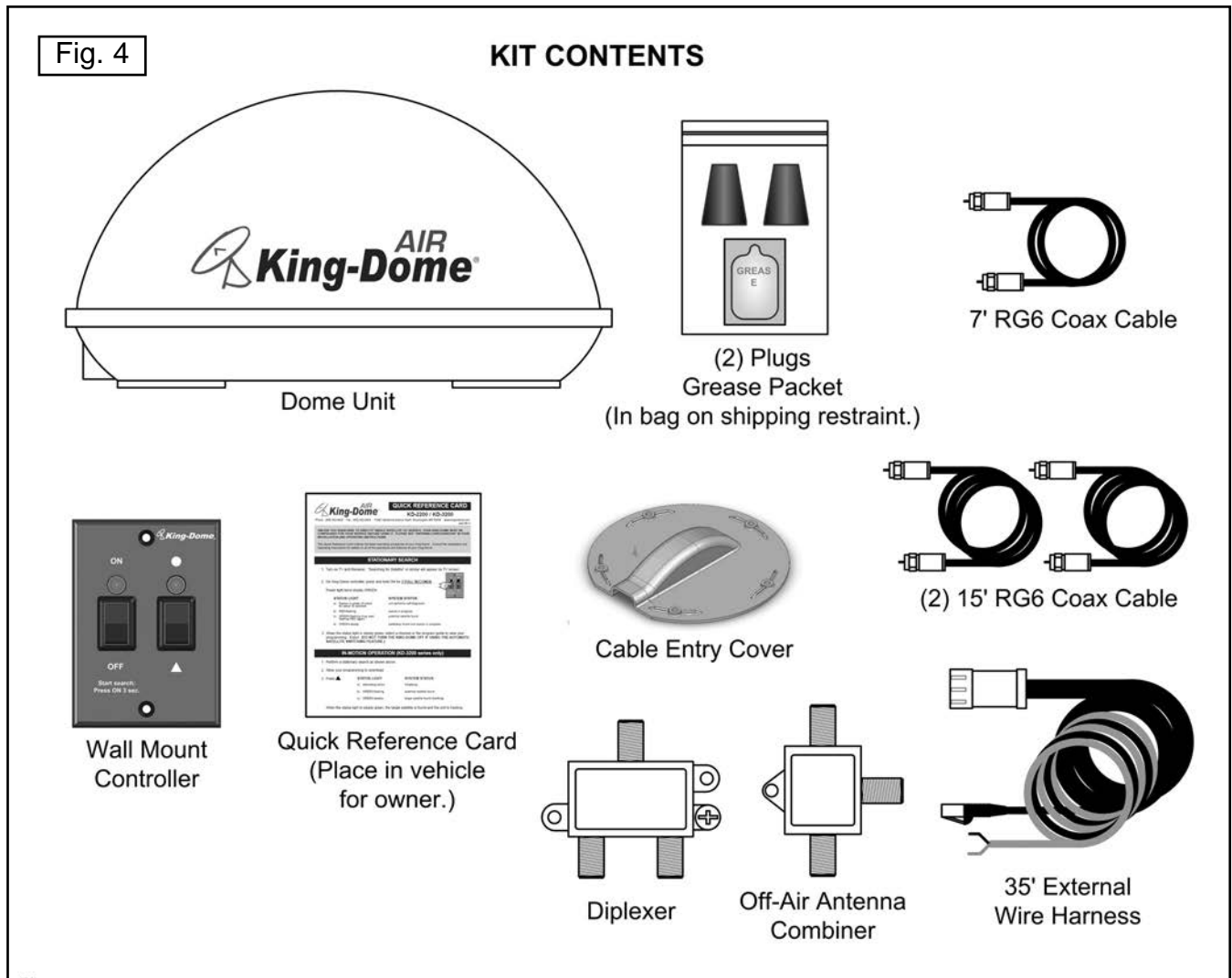

**IMPORTANT!** The tie strap and spacer, and the shipping bolts and washers must be removed from the bottom of the dome unit prior to installation. **DO NOT REMOVE THE DOME COVER TO REMOVE THESE SHIPPING RESTRAINTS.**

**YOU MUST PLUG THE SHIPPING BOLT HOLES WITH THE SUPPLIED PLUGS (ATTACHED TO TIE STRAP SHIPPING RESTRAINT).**

2. Remove and discard the tie strap and spacer (**KEEP RUBBER PLUGS AND GREASE PACKET**), and the 2 bolts and 2 washers that pass through the bottom of the base (**Fig. 5**).
3. Insert provided plugs into holes that were occupied by the shipping bolts. Inserted plugs should be flush with base (**Fig. 5**).

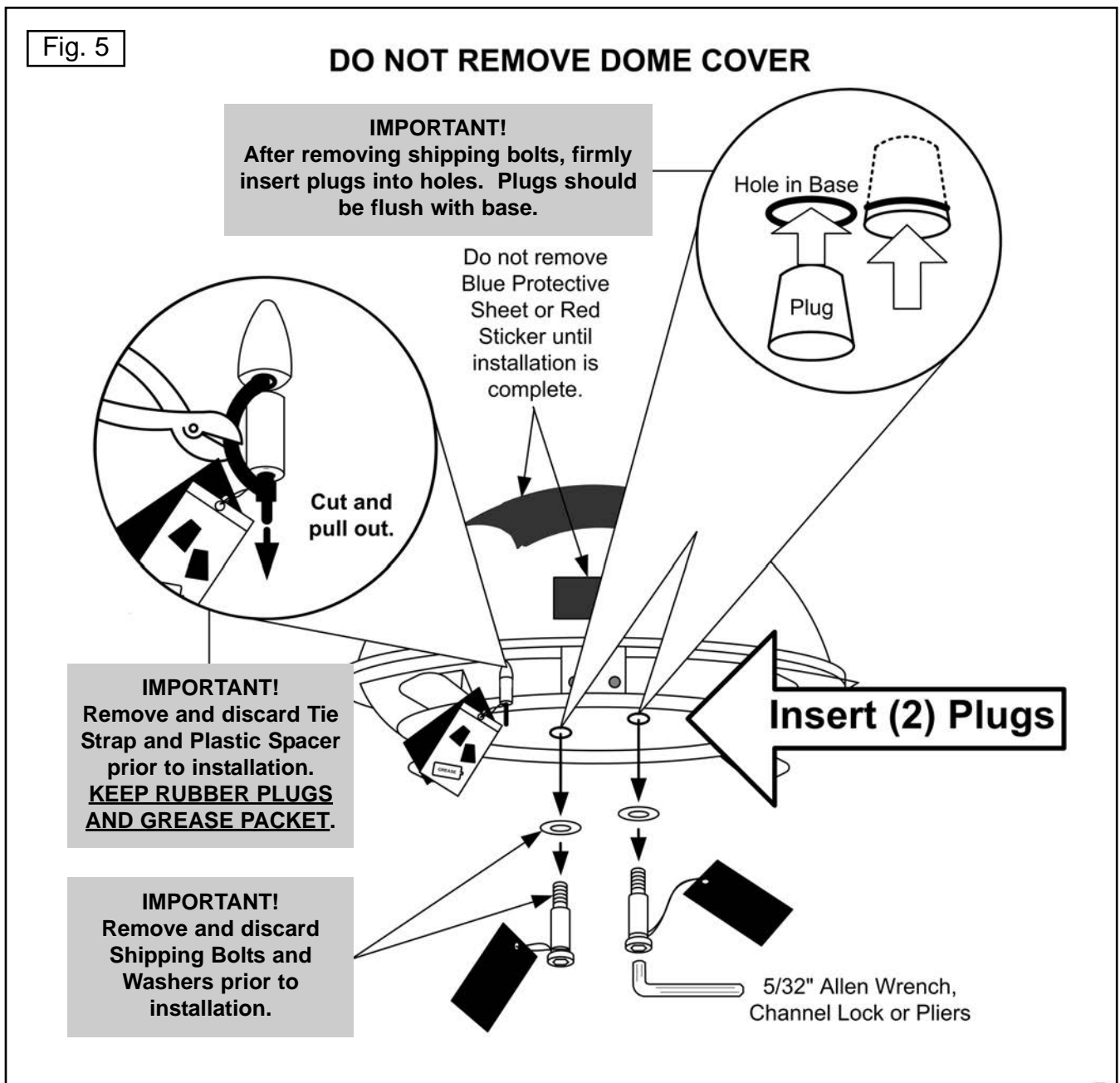

## DOMES LOCATION

4. Select an area on the roof for the dome unit and the location where the wiring will enter the vehicle through the roof to the satellite receiver, controller, combiner, diplexer, and 12 volt power source inside, using the following criteria:
  - a) The dome unit should be mounted as far away as possible from the existing off-air antenna if the antenna signals will be combined.
  - b) A shorter distance between the dome unit and the satellite receiver is most desirable.
  - c) The dome unit requires a 28 inch diameter mounting area.
  - d) The dome unit should be mounted on the centerline of the vehicle.
  - e) There must be no "line of sight" obstructions. Air conditioning units, other antennas, and storage areas that are too close to the dome unit may obstruct the satellite signal and off-air transmissions (**Fig. 6**).

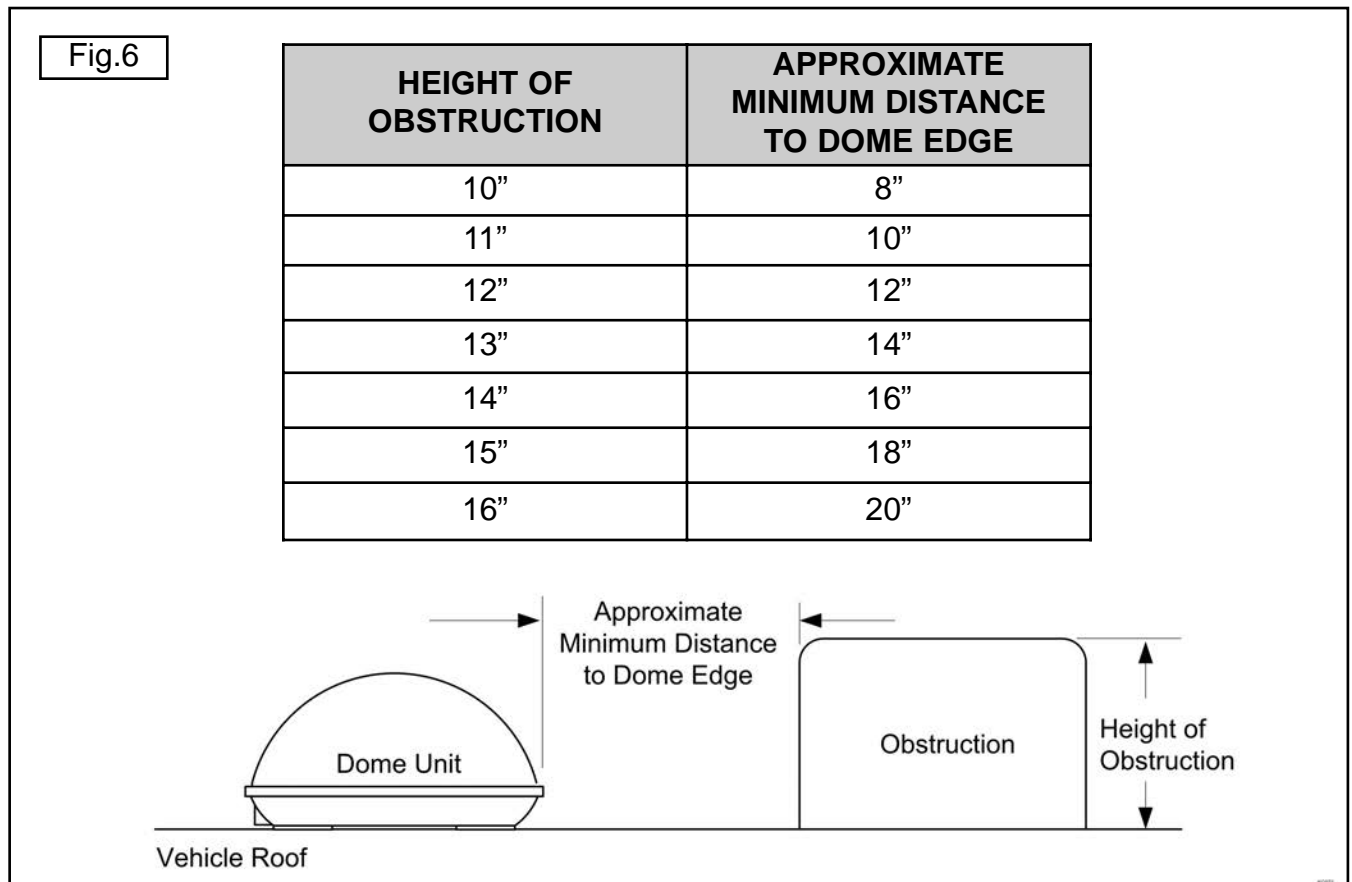



## DOME INSTALLATION

**IMPORTANT!** Make sure shipping restraints are removed from bottom of dome unit and plugs are inserted in holes (Fig. 5, Page 5).

Cable connections must **ALWAYS** be positioned facing the rear of vehicle.

- Place dome unit on installation location chosen using the criteria discussed in the previous section. Shipping restraints must be removed, plugs must be inserted in holes (**Fig. 5, Page 5**), and cable connections must be positioned facing rear of vehicle.
- Position the dome unit so that both feet on each side of the vehicle are equal distances from the roof edge. This should be checked by measuring the distance from each foot to the roof edge. Confirm that these measurements are equal (**Fig. 7**).

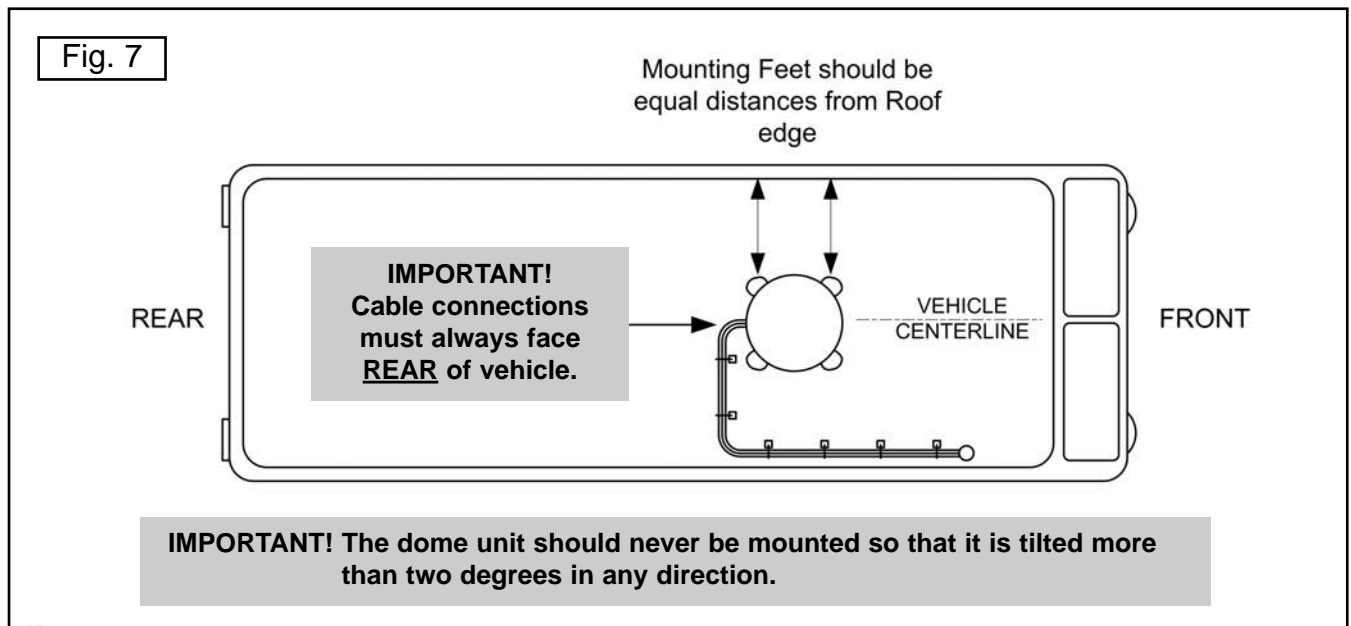

Note: The installer is responsible for determining the most appropriate fastener to secure the dome unit to the roof. Depending on the roof material, fasteners such as lag screws, sheet metal screws, toggle bolts and T anchors may be used, and should always be used in combination with a roof compatible sealant.

**IMPORTANT!** The installer is responsible for weatherproofing all holes with sealant.

- Mount the dome unit. Use the pre-drilled holes in the mounting feet as a guide to install the fasteners into the roof. Use additional fasteners whenever necessary.
- Test that the dome unit is secure by pulling upward from each foot location.

## EXTERNAL WIRING

9. Plug external wire harness into wiring port on back of dome unit and tighten connection until it clicks past the detent lock (**Fig. 8**).

Note: The *King-Dome<sup>AIR</sup>* is wired for multiple receiver support. There are two coax ports on the back of the dome unit. The one labeled "MAIN" **MUST** be connected to the main receiver in vehicle. This is the receiver that will control automatic satellite switching if applicable. The one labeled "AUX" is connected to the off-air components, and can be used for an additional receiver hook-up as well. You may wish to label the ends of the coax cables to avoid confusion when making connections.

**IMPORTANT! You must fill the ends of all external coax cables with the supplied dielectric grease. Failure to do so will void product warranty.**

10. Fill end of coax cable that will connect to the MAIN port on the dome unit with supplied dielectric grease. Connect this end of the coax cable to the MAIN port and tighten connection (**Fig. 8**).

Fill end of coax cable that will connect to the AUX port on the dome unit with supplied dielectric grease. Connect this end of the coax cable to the AUX port and tighten connection.

**DO NOT OVER TIGHTEN CONNECTIONS.**

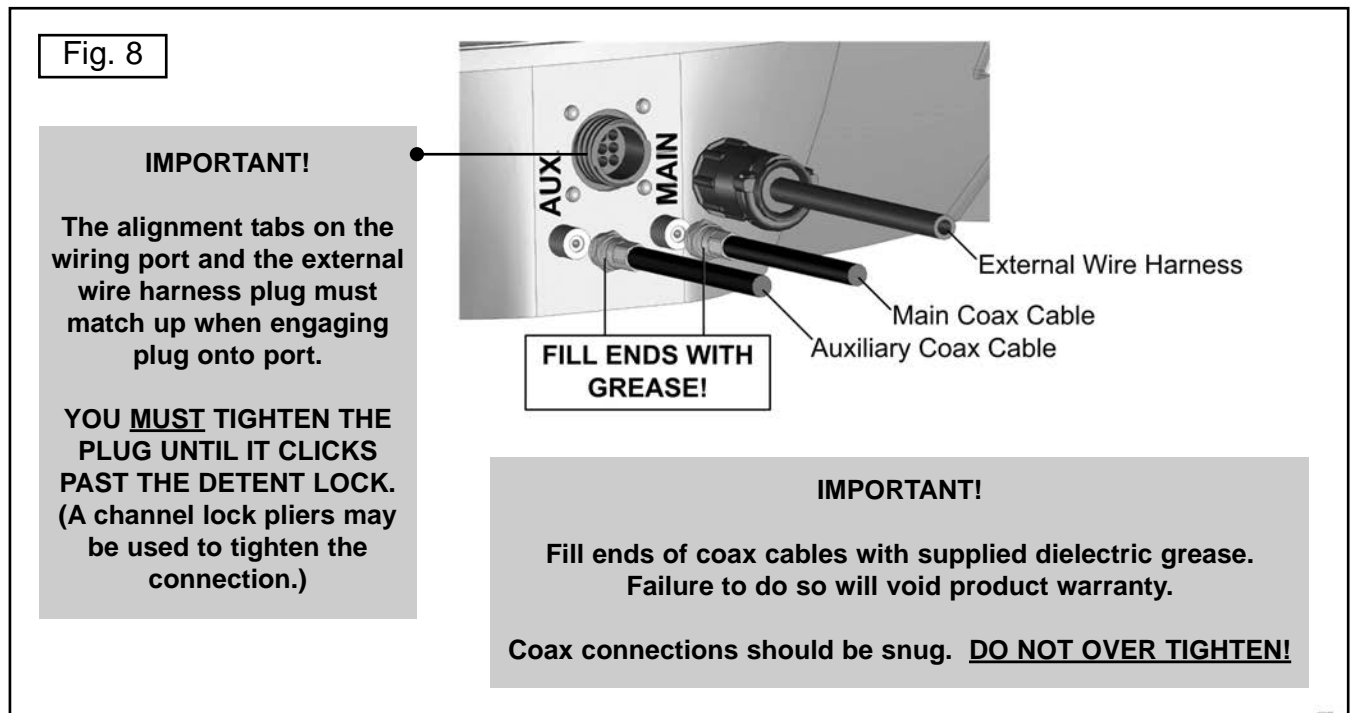

## AVOID SHARP BENDS WHEN ROUTING COAX!

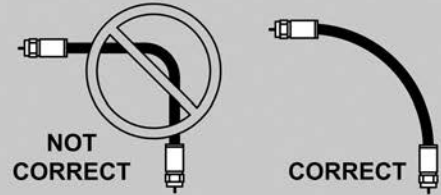

11. Run wiring from the back of the dome unit to the roof edge, then along edge to location where wiring will be fed into the vehicle. Secure wiring to roof every 12-18 inches (**Fig. 9**).

**IMPORTANT! Installer is responsible for determining proper roof compatible fasteners for cable entry cover.**

**Roof hole for wiring must be sealed so it is completely waterproof. Mounting holes, perimeter of cable entry cover and cable opening of cable entry cover must be sealed so they are completely waterproof. SEALANT MUST BE ROOF COMPATIBLE.**

12. Drill 3/4" hole for the wiring through the roof and into the cabinet where receiver is stored. Feed wiring down through hole. Seal opening with roof compatible sealant so that it is completely waterproof (inside and outside of the hole).
13. Fasten cable entry cover to roof. Seal mounting holes, perimeter of cover and cable opening so they are completely waterproof.

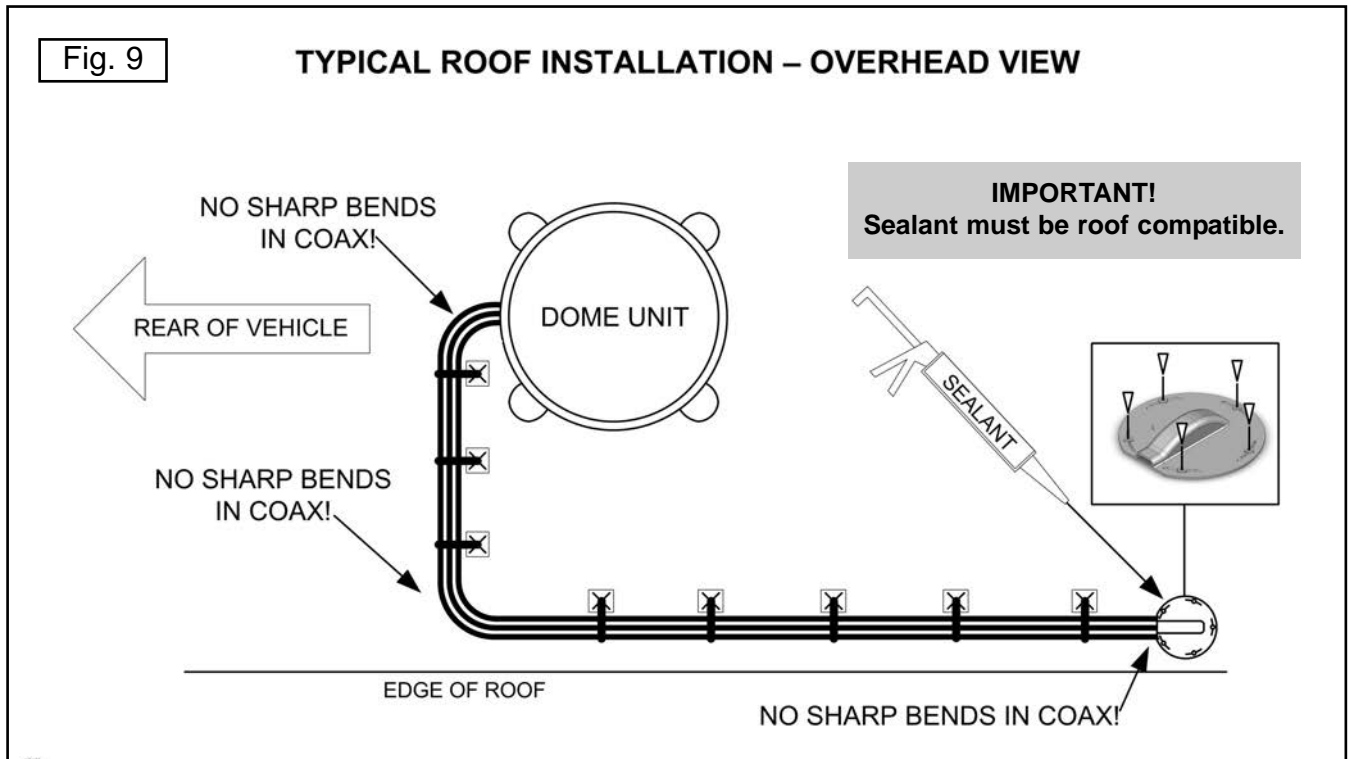

14. Remove blue protective sheet and red "position to rear" sticker from the dome unit.

## AVOID SHARP BENDS WHEN ROUTING COAX!

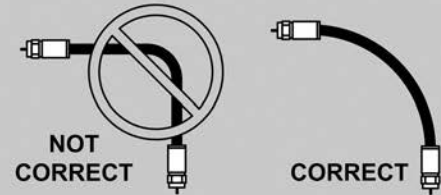

### INTERNAL WIRING

Note: Using multiple receivers is not recommended for multi-satellite services where automatic satellite switching is desired.

Components and wiring supplied with the KD-2200/KD-3200 are shown in black.  
Existing components and wiring or those sold separately are shown in gray.

#### 15. Choose your desired wiring configuration:

Wall Plate Antenna Power Switch with single off-air output Fig. 10, Page 11

A/V Distribution Box with A/V Antenna Power Switch, single off-air output Fig. 11, Page 12

A/V Distribution Box with A/V Antenna Power Switch, multiple off-air outputs Fig. 12, Page 13

#### 16. Inside the vehicle, make the connections as shown in the wiring diagrams, keeping in mind the following important points:

- a) The connection between the dome unit and the main satellite receiver must be a direct connection with no other devices in between.
- b) Power connection must be a non-shared circuit. Excessive current draw on the circuit will cause the unit to operate improperly. Power and ground connections must be made after all wiring is connected to the dome unit.
- c) If fusing the circuit, the fuse must be rated at 7.5 amps.
- d) Install the off-air combiner only if using the existing off-air antenna as well. If not using the existing antenna, connect the diplexer "ANT OUT" directly to TV, converter box, off-air input of receiver, or off-air splitter.
- e) HDTV receivers require HDMI or component video/audio cable connection to TV (sold separately).

#### 17. When installation is complete, go to Section 4, **ANTENNA CONFIGURATION** on page 15.

Fig. 10

# King-Dome<sup>AIR</sup> Series 2200 and 3200 Wiring Diagram Wall Plate Antenna Power Switch, single off-air output

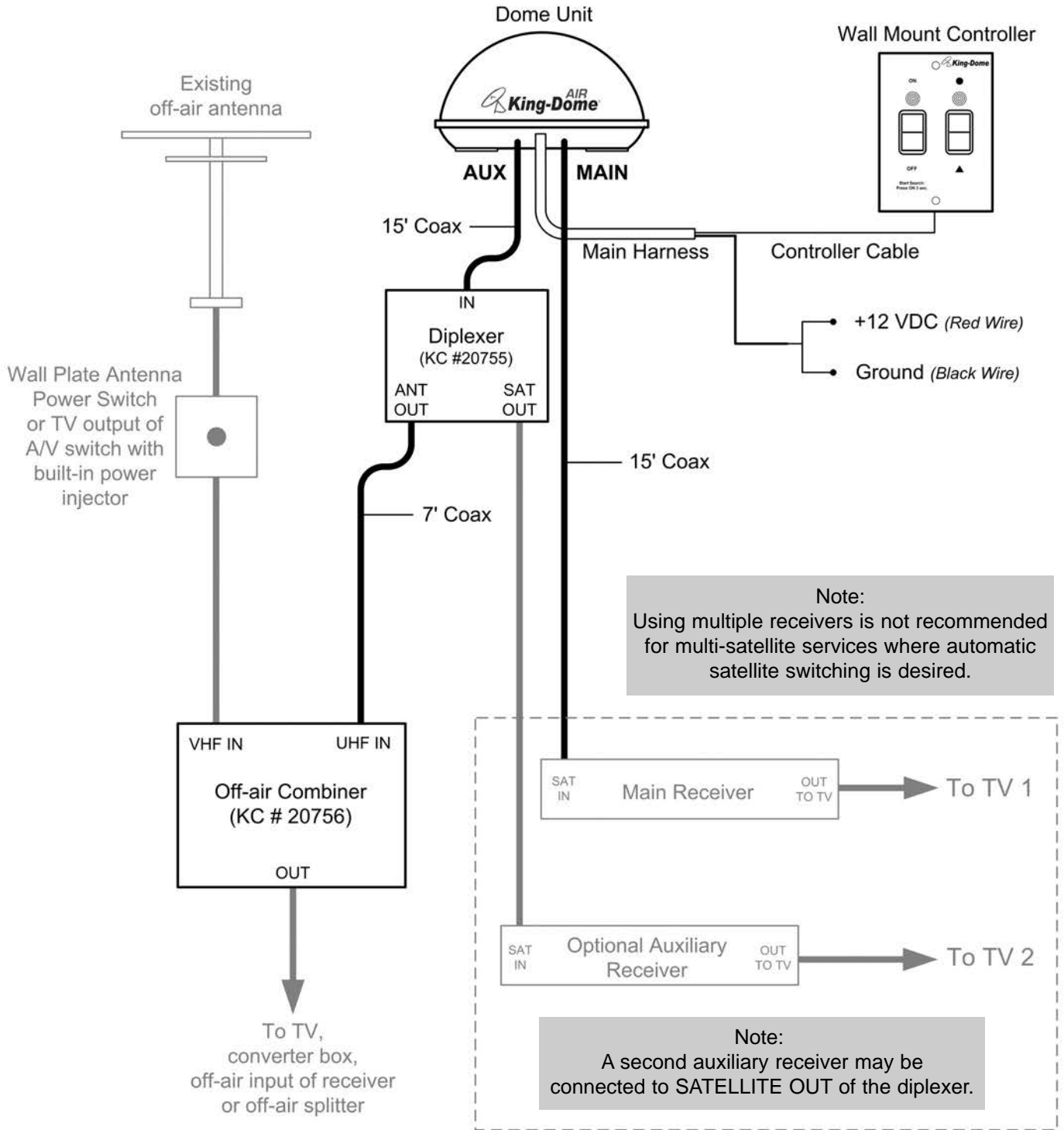

Note:  
Using multiple receivers is not recommended for multi-satellite services where automatic satellite switching is desired.

Note:  
A second auxiliary receiver may be connected to **SATELLITE OUT** of the diplexer.

Fig. 11

### King-Dome<sup>AIR</sup> Series 2200 and 3200 Wiring Diagram A/V Distribution Box with A/V Antenna Power Switch, single off-air output

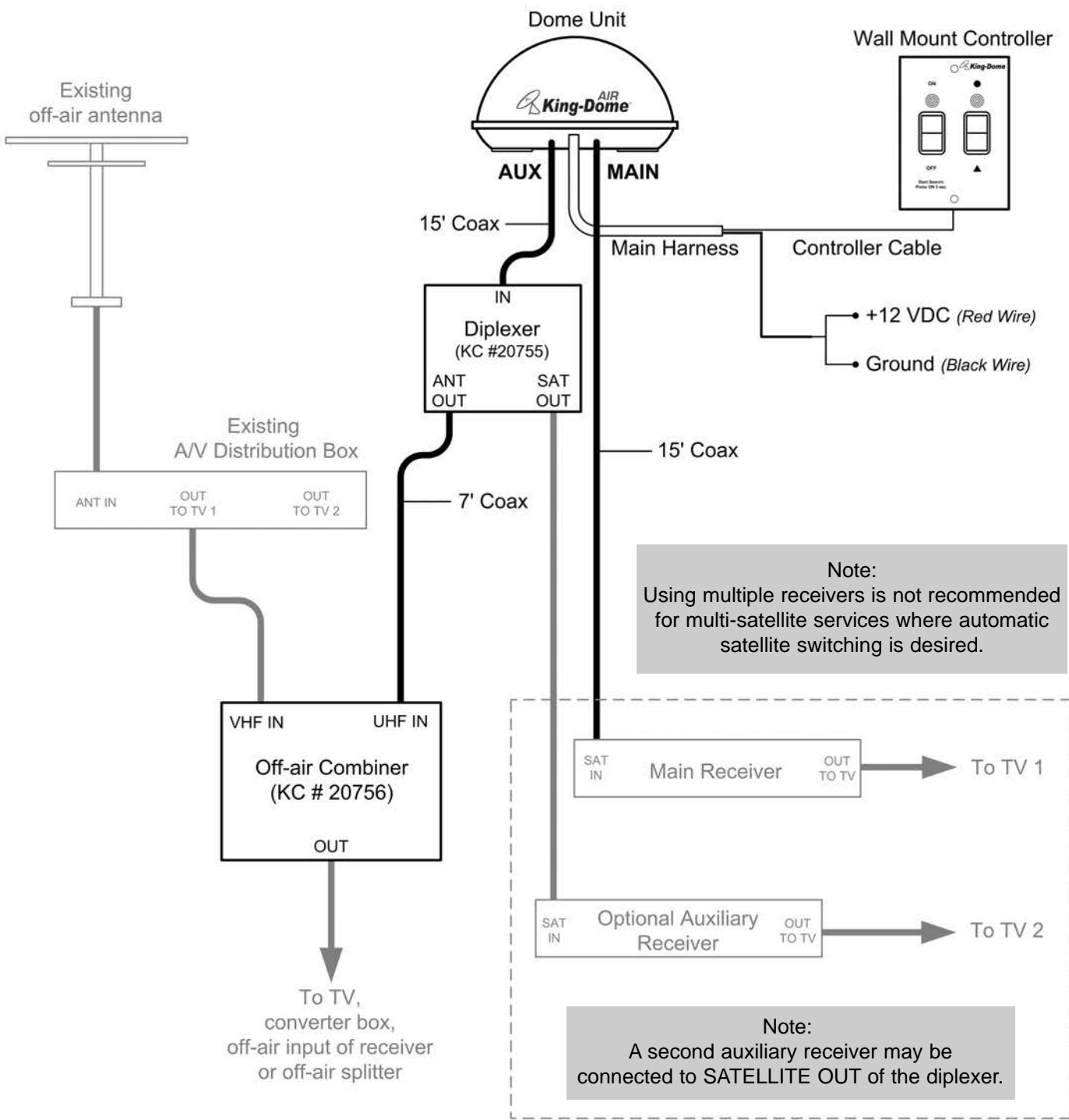
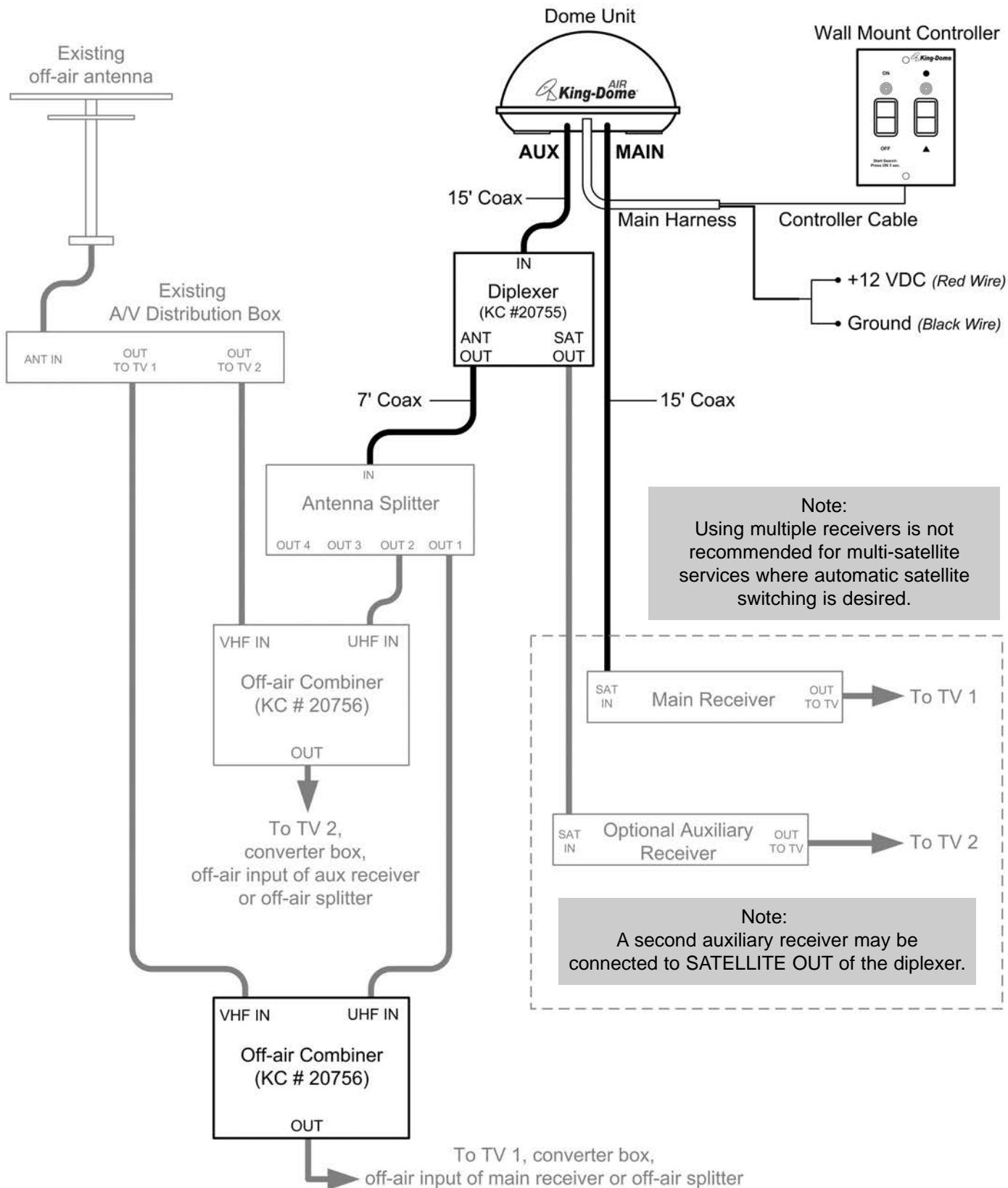

Fig. 12

### King-Dome<sup>AIR</sup> Series 2200 and 3200 Wiring Diagram

## A/V Distribution Box with A/V Antenna Power Switch, multiple off-air outputs





This page intentionally left blank.



The *King-Dome<sup>AIR</sup>* is factory pre-set for DIRECTV standard digital programming broadcast from the 101° W satellite.

If you also receive your local channels from DIRECTV's 119 satellite or if you subscribe to DISH or Bell TV programming, you must re-configure the antenna to work with your satellite service. Doing this will allow the *King-Dome<sup>AIR</sup>* to lock on the correct satellites to receive your programming and also enable automatic satellite switching via the receiver's remote control for multi-satellite service.

Antenna configuration is a one time procedure that **MUST BE COMPLETED** before using your *King-Dome<sup>AIR</sup>* antenna.

To configure your antenna, follow these steps:

### 1. SATELLITE SERVICE OPTIONS

Determine the service you will use (pages 16-17).

### 2. ANTENNA CONFIGURATION

Configure the antenna for the service you chose in step 1.

You can use either:

**A)** the supplied wall mount controller (page 18).

or

**B)** #1844 Keypad (page 25).



### 3. DISH AND BELL TV CHECK SWITCH PROCEDURE

For all DISH and Bell TV services:

Configure your receiver for mobile use by running a check switch (page 29).

# STEP 1: SATELLITE SERVICE OPTIONS

## DIRECTV

### Single Satellite 101

Receive standard digital programming from the DIRECTV 101 satellite only.

### DIRECTV Plus: 101, 119

Receive standard digital programming from the 101, and locals from the 119, and automatically switch between the two.

**IMPORTANT!** The *King-Dome<sup>AIR</sup>* can receive available HDTV programming from DIRECTV Ku band satellites at 101° and 119°. It will not receive channels broadcast from DIRECTV's Ka band satellites at 99° and 103°.

## Bell TV

(May not be available in all areas due to geographic variance in satellite signal strength.)

### Standard Digital 91

Receive programming from the 91 satellite only.

### HDTV 82/91 and HDTV 82/91 Alternate

Automatically switch between the 82 and 91 satellites for Bell TV by using the receiver's remote control.

Choose the HDTV 82/91 option. If you can not lock onto the satellites in step 2 of the check switch procedure (page 29), you may get better results by choosing the HDTV 82/91 Alternate. The HDTV 82/91 Alternate is for **STATIONARY USE ONLY**.

Note: Tracking satellites is only possible with adequate signal strength.

# DISH

## DISH 500

Automatically switch between the 110 and 119 satellites for DISH Standard Digital Service by simply changing channels with the receiver's remote control.

## DISH HD Eastern Arc

Automatically switch between the 61.5 and 72 satellites for DISH by simply changing channels with the receiver's remote control.

## DISH HD Eastern and Western Arc with Locals

DISH HD programming is broadcast from multiple satellites including these two trios: the DISH HD Western Arc Trio - 110, 119, 129 satellites, and the DISH HD Eastern Arc Trio - 61.5, 72, 77 satellites. The map below shows the approximate coverage for each trio.

**(Note: With the Eastern Arc Trio, you cannot receive programming from the 77 satellite while in motion.)**

The *King-Dome<sup>AIR</sup>* antenna can be easily configured to work with either trio. By choosing the appropriate trio based on where you are, you can receive all of your desired programming.

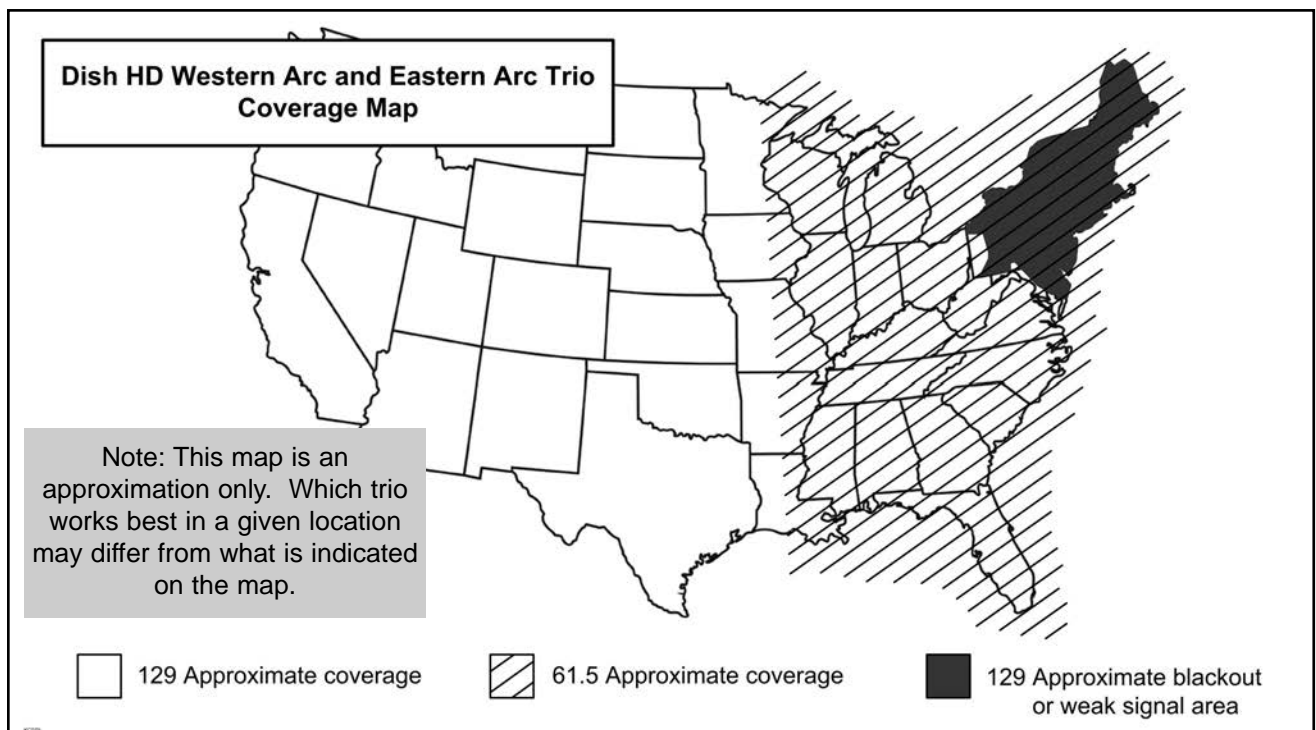

## DISH HD Alternate with Locals

Choose this option for satellites 61.5, 110, and 119 only if you are unable to view your programming with DISH HD Western Arc or DISH HD Eastern Arc with Locals.

# STEP 2-A: ANTENNA CONFIGURATION USING WALL MOUNT CONTROLLER

Note: If you are using the keypad for programming, go to page 25.

On pages 19-23, find your service and follow the instructions in the box.

## DIRECTV

Single Satellite 101 (Factory Pre-set) . . . . .Page 19  
DIRECTV Plus . . . . .Page 19

## DISH

DISH 500 . . . . .Page 20  
DISH HD Eastern Arc . . . . .Page 20  
DISH HD Western Arc with Locals . . . . .Page 21  
DISH HD Eastern Arc with Locals . . . . .Page 21  
DISH HD Alternate with Locals . . . . .Page 22

## Bell TV

Bell TV Standard Digital 91 . . . . .Page 22  
Bell TV HDTV 82/91 . . . . .Page 23  
Bell TV HDTV 82/91 Alternate . . . . .Page 23

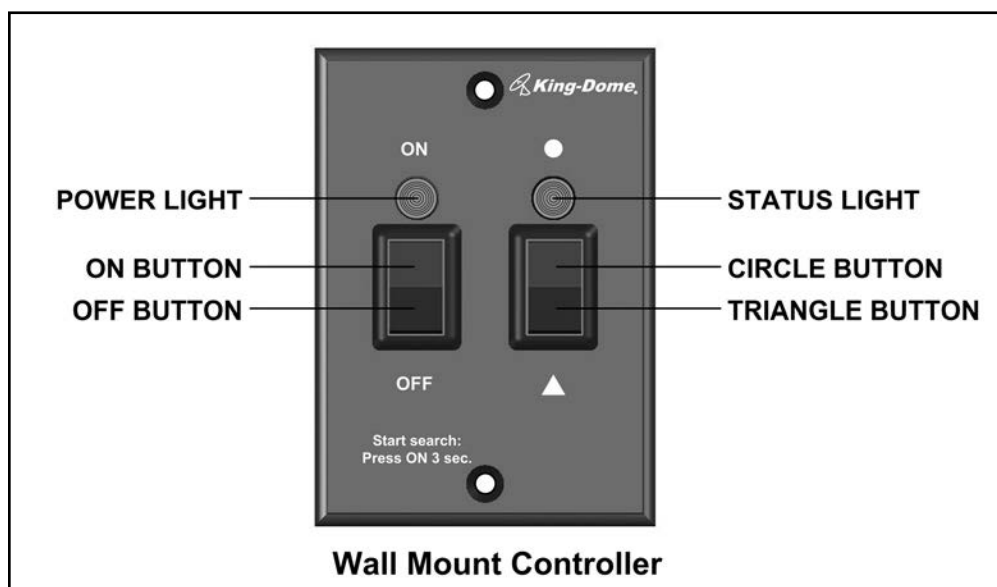

# DIRECTV ANTENNA CONFIGURATION

## Single Satellite 101

The King-Dome is factory pre-set for the DIRECTV 101 satellite. Unless the antenna has been configured for another option since leaving the factory, **PERFORM STEP 5 ONLY.**

1. On the King-Dome controller, press and release the ON button.  
Wait for status light to flash orange, then **WAIT 4 MORE SECONDS.**
2. Press and release the ON button **16** times.  
The status light starts rapidly flashing green and red.
3. Press and hold the ▲ button for 4 seconds. The status light will turn orange for 1 second, and then start flashing green or red.
4. Press OFF.
5. If you have a newer receiver or current software, choose the following dish configuration settings (do this through the receiver's satellite set-up menu screens):

Dish Type: 01: 18" Round                      Switch Type: 02:Multiswitch  
If you have an older receiver, choose round dish-1 satellite.

Configuration is complete. **Go to page 32.**

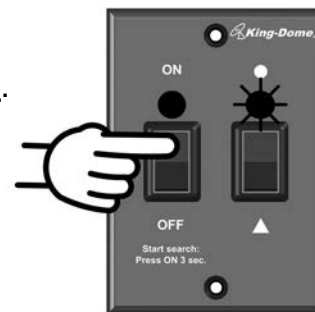

## DIRECTV Plus (satellites 101, 119)

1. On the King-Dome controller, press and release the ON button.  
Wait for status light to flash orange, then **WAIT 4 MORE SECONDS.**
2. Press and release the ON button **8** times.  
The status light starts rapidly flashing green and red.
3. Press and hold the ● button for 4 seconds. The status light will turn orange for 1 second, and then start flashing green or red.
4. Press OFF.
5. If you have a newer receiver or current software, choose the following dish configuration settings (do this through the receiver's satellite set-up menu screens):

Dish Type: 02: 3-LNB (18 x 20")                      Switch Type: 02:Multiswitch  
If you have an older receiver, choose oval dish-2 satellites.

Configuration is complete. **Go to page 32.**

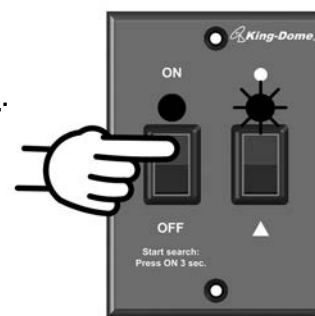

## DISH ANTENNA CONFIGURATION

### DISH 500 (satellites 110, 119)

1. On the King-Dome controller, press and release the ON button. Wait for the status light to flash orange, and then **WAIT 4 MORE SECONDS.**
2. Press and release the ON button **12** times. The status light starts rapidly flashing green and red.
3. Press and hold the ● button for 4 seconds. The status light will turn orange for 1 second, and then start flashing green or red.
4. Press OFF.
5. After you have successfully configured the antenna, you must configure your receiver for mobile use.

To configure your receiver, **go to page 29 and run the check switch.**

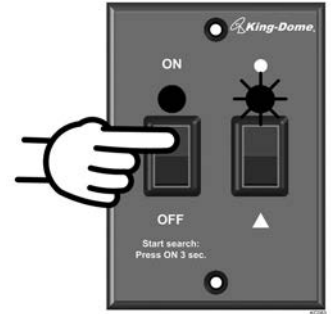

### DISH HD Eastern Arc (satellites 61.5, 72)

1. On the King-Dome controller, press and release the ON button. Wait for the status light to flash orange, and then **WAIT 4 MORE SECONDS.**
2. Press and release the ON button **36** times. The status light starts rapidly flashing green and red.
3. Press and hold the ON button for 4 seconds. The status light will turn orange for 1 second, and then start flashing green or red.
4. Press OFF.
5. After you have successfully configured the antenna, you must configure your receiver for mobile use.

To configure your receiver, **go to page 29 and run the check switch.**

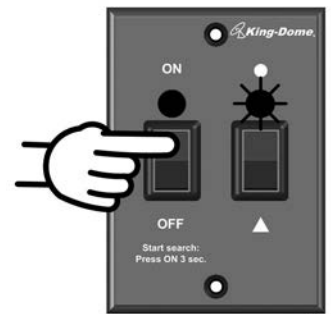

## DISH HD Western Arc with Locals (satellites 110, 119, 129)

1. On the King-Dome controller, press and release the ON button.  
Wait for the status light to flash orange,  
and then **WAIT 4 MORE SECONDS.**
2. Press and release the ON button **20** times.  
The status light starts rapidly flashing green and red.
3. Press and hold the ● button for 4 seconds.  
The status light will turn orange for 1 second,  
and then start flashing green or red.
4. Press OFF.
5. After you have successfully configured the antenna, you must configure your receiver for mobile use.

To configure your receiver, **go to page 29 and run the check switch.**

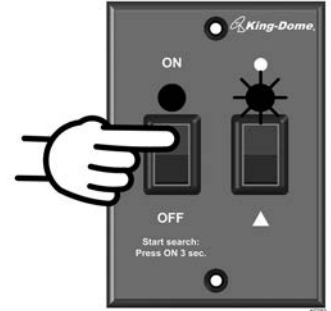

## DISH HD Eastern Arc with Locals (satellites 61.5, 72, 77)

**You cannot receive programming  
from the 77 satellite while in motion.**

1. On the King-Dome controller, press and release the ON button.  
Wait for the status light to flash orange,  
and then **WAIT 4 MORE SECONDS.**
2. Press and release the ON button **12** times.  
The status light starts rapidly flashing green and red.
3. Press and hold the ▲ button for 4 seconds.  
The status light will turn orange for 1 second,  
and then start flashing green or red.
4. Press OFF.
5. After you have successfully configured the antenna, you must configure your receiver for mobile use.

To configure your receiver, **go to page 29 and run the check switch.**

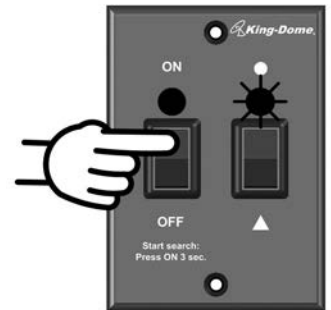

## DISH HD Alternate with Locals (satellites 61.5, 110, 119)

1. On the King-Dome controller, press and release the ON button. Wait for the status light to flash orange, and then **WAIT 4 MORE SECONDS**.
2. Press and release the ON button **16** times. The status light starts rapidly flashing green and red.
3. Press and hold the ● button for 4 seconds. The status light will turn orange for 1 second, and then start flashing green or red.
4. Press OFF.
5. After you have successfully configured the antenna, you must configure your receiver for mobile use.

To configure your receiver, **go to page 29 and run the check switch.**

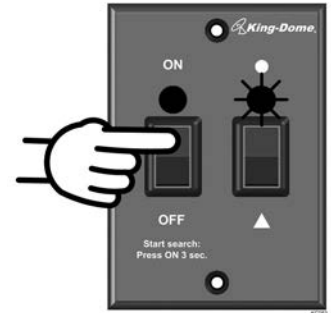

## BELL TV ANTENNA CONFIGURATION

### Bell TV Standard Digital 91 (satellite 91)

1. On the King-Dome controller, press and release the ON button. Wait for the status light to flash orange, and then **WAIT 4 MORE SECONDS**.
2. Press and release the ON button **8** times. The status light starts rapidly flashing green and red.
3. Press and hold the ▲ button for 4 seconds. The status light will turn orange for 1 second, and then start flashing green or red.
4. Press OFF.
5. After you have successfully configured the antenna, you must configure your receiver for mobile use.

To configure your receiver, **go to page 29 and run the check switch.**

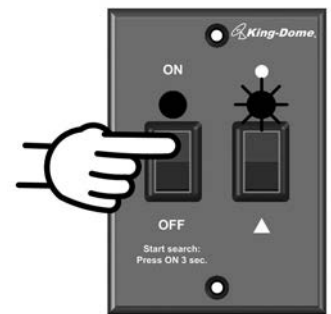



## Bell TV HDTV 82/91 (satellites 82, 91)

1. On the King-Dome controller, press and release the ON button.  
Wait for the status light to flash orange,  
and then **WAIT 4 MORE SECONDS.**
2. Press and release the ON button **32** times.  
The status light starts rapidly flashing green and red.
3. Press and hold the ON button for 4 seconds.  
The status light will turn orange for 1 second,  
and then start flashing green or red.
4. Press OFF.
5. After you have successfully configured the antenna, you must configure your receiver for mobile use.

To configure your receiver, **go to page 29 and run the check switch.**

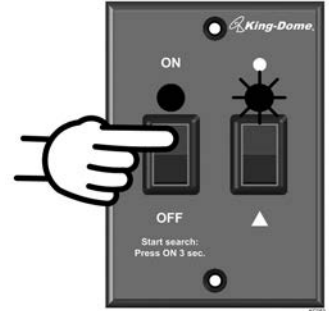

## Bell TV HDTV 82/91 Alternate (satellites 82, 91)

### **STATIONARY USE ONLY**

1. On the King-Dome controller, press and release the ON button.  
Wait for the status light to flash orange,  
and then **WAIT 4 MORE SECONDS.**
2. Press and release the ON button **36** times.  
The status light starts rapidly flashing green and red.
3. Press and hold the ▲ button for 4 seconds.  
The status light will turn orange for 1 second,  
and then start flashing green or red.
4. Press OFF.
5. After you have successfully configured the antenna, you must configure your receiver for mobile use.

To configure your receiver, **go to page 29 and run the check switch.**

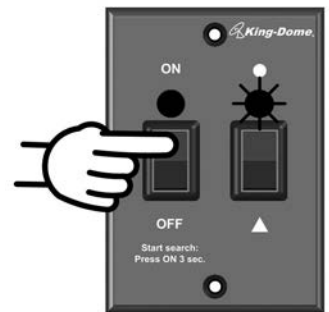



This page intentionally left blank.

# STEP 2-B: ANTENNA CONFIGURATION

## USING #1844 KEYPAD



Note: If you are using the wall mount controller for programming, go to page 18.

Find your service in the chart below.  
Determine your Switching Mode and Provider Code, and then **go to page 26**.

### SWITCHING MODE AND PROVIDER CODE CHART

Service	Satellites	Switching Mode	Provider Code
<b>DIRECTV<sup>3</sup></b>			
Single Satellite 101 (Factory Preset)	101	02	01
DIRECTV Plus	101, 119	16	01
<b>DISH</b>			
DISH 500 (SW21 Switch)	110, 119	26	10
DISH HD Eastern Arc (SW21 Switch)	61.5, 72	26	62
DISH HD Western Arc with Locals (SW64 Switch)	110, 119, 129	62	10
DISH HD Eastern Arc with Locals (SW64 Switch) <sup>1</sup>	61.5, 72, 77	62	62
DISH HD Alternate with Locals (SW64 Switch)	61.5, 110, 119	66	10
<b>Bell TV</b>			
Bell TV Standard Digital 91	91	02	91
Bell TV HDTV 82/91	82, 91	26	82
Bell TV HDTV 82/91 Alternate <sup>2</sup>	82, 91	26	91

Note: <sup>1</sup> With the Eastern Arc Trio, you cannot receive programming from the 77 satellite while in motion.

<sup>2</sup> Bell TV HDTV 82/91 Alternate is for stationary use only.

<sup>3</sup> The *King-Dome<sup>AIR</sup>* can receive available HDTV programming from DIRECTV Ku band satellites at 101° and 119°. It will not receive channels broadcast from DIRECTV's Ka band satellites at 99° and 103°.

Perform the programming on these two pages using the codes determined from the chart on page 25 (**EXCEPT DIRECTV 101 SERVICE - SEE BOX BELOW**).

### **DIRECTV 101 Service Only!**

The King-Dome is factory pre-set for the DIRECTV 101 satellite. Unless the antenna has been configured for another option since leaving the factory, do the following:

Set your receiver as shown in this box.

If you have a newer receiver or current software, choose the following dish configuration settings (do this through the receiver's satellite set-up menu screens):

Dish Type: 01: 18" Round                      Switch Type: 02:Multiswitch

If you have an older receiver, choose round dish-1 satellite.

Configuration is complete. **Go to page 32.**

## **SET SATELLITE SWITCHING MODE**

1. Unplug the controller and plug in the Keypad.
2. Press ON.
3. Press **\* 46 #** to display the current satellite switching mode (see chart on page 25).
4. To change the satellite switching mode, press  
**\* 96 #**  
**\* 66 #**  
**\* 88 #**
5. Press the UP and DOWN arrows (2 and 8 keys) to choose your desired switching mode from the chart on page 25.
6. Press **\* 47 #** to lock in setting.
7. Turn unit OFF and back ON to save setting.
8. Press **\* 46 #** to display and verify code for new satellite switching mode.
9. Continue with SET SATELLITE PROVIDER CODE on next page.



# SET SATELLITE PROVIDER CODE

1. Press \* **24 #** to display the current service provider (see chart on page 25).
2. To change the current service provider, press
  - \* **96 #**
  - \* **66 #**
  - \* **88 #**



3. Press the UP and DOWN arrows (2 and 8 keys) to choose your desired service provider from the chart on page 25.
4. Press \* **25 #** to lock in setting.
5. Turn unit OFF and back ON to save setting.
6. Press \* **24 #** to display and verify code for new service provider.
7. Press OFF.
8. Unplug the Keypad and plug the controller back in.
9. Continue with RECEIVER CONFIGURATION below.

## RECEIVER CONFIGURATION

### DIRECTV Plus: 101/119

If you have a newer receiver or current software, choose the following dish configuration settings (do this through the receiver's satellite set-up menu screens):

Dish Type: 02: 3-LNB (18 x 20")      Switch Type: 02:Multiswitch

If you have an older receiver, choose oval dish-2 satellites.

Configuration is complete. **Go to page 32.**

For all of the following, **go to page 29** and run the check switch.

### DISH 500

### DISH HD Eastern Arc

### DISH HD Western Arc with Locals

### DISH HD Eastern Arc with Locals

### DISH HD Alternate with Locals

### Bell TV Standard Digital 91

### Bell TV HDTV 82/91



This page intentionally left blank.

# STEP 3: DISH AND BELL TV CHECK SWITCH PROCEDURE

**IMPORTANT! YOU MUST HAVE COMPLETED THE ANTENNA CONFIGURATION (STEP 2-A, PAGE 18 OR STEP 2-B, PAGE 25) AND PERFORMED A SUCCESSFUL SEARCH (STEP 2 BELOW) BEFORE RUNNING THE CHECK SWITCH (STEP 3 BELOW).**

Note: For automatic satellite switching, King Controls recommends using a DISH model 311 receiver for DISH 500, and a DISH model VIP211 or a VIP211k HDTV receiver for DISH HD Eastern Arc / DISH HD Western Arc with Locals / DISH HD Eastern Arc with Locals / DISH HD Alternate with Locals. Do not use dual tuner receivers or receivers with built-in recorders.

If you do not have a clear view of the satellites, the switch will not load correctly.

The SW21 and SW64 switches are a receiver software configuration that is loaded into the receiver after running a check switch test with the dish locked on and configured for the appropriate service.

This one time procedure will not need to be repeated after successful installation, unless

- check switch test is run again while connected to a home dish system.
- check switch is run when a receiver is not connected.
- you travel outside the coverage area of the pre-set satellite trio and switch trios (DISH HD Western Arc with Locals/DISH HD Eastern Arc with Locals).
- you are parked in an area where the selected satellites are blocked, but are able to select alternate satellites and get signal..

1. Turn on the TV and satellite receiver.
2. On the King-Dome controller, press and hold the ON button for **3 FULL SECONDS**.

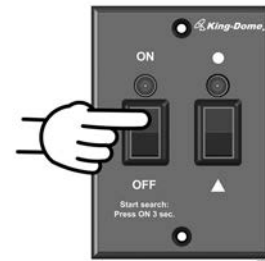

The antenna will lock onto all the appropriate satellites before completing the search process.

**After the satellites have been located and the acquisition process is complete, the status light will be steady green.**

**If the antenna cannot acquire the designated satellites, you may have to choose an alternate satellite option. See pages 16-17 for details.**

3. On the receiver remote, press Menu, 6, 1, 1.
4. Highlight Check Switch and press select.

**Note: Some receivers may prompt you to select check switch a second time to initiate the test.**

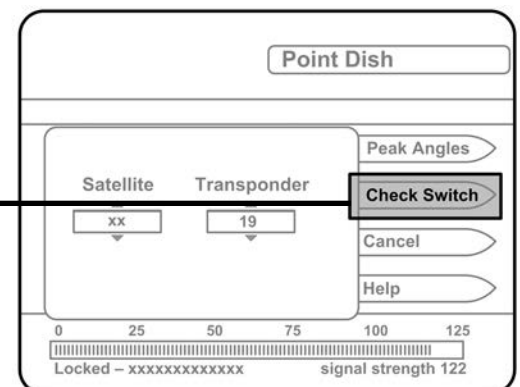

(Continued on next page)

Screen graphics may vary.

**Note: Not all receivers will display a screen with options that include superdish and alternate boxes.**

5. Make sure Superdish and Alternate boxes are **NOT** selected.
6. Highlight Test and press Select.

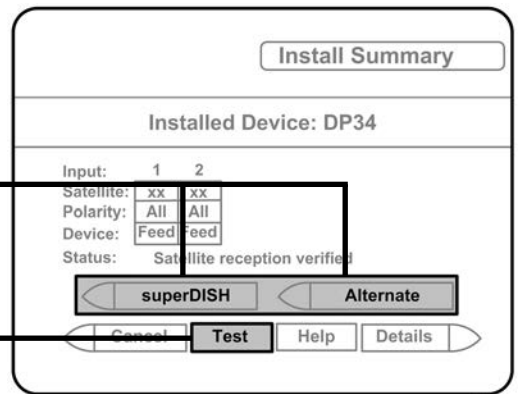

Screen graphics may vary.

The unit will perform a check switch test, and the antenna will periodically move back and forth. (This process will take several minutes.)

7. When test is complete, a screen similar to one **below or on the next page** should appear. After screen verification, continue with check switch procedure on next page.

**Receivers are always changing, and therefore screen graphics may vary. Older DISH receivers, for example, may not show "OK" for the 72 satellite.**

### DISH 500

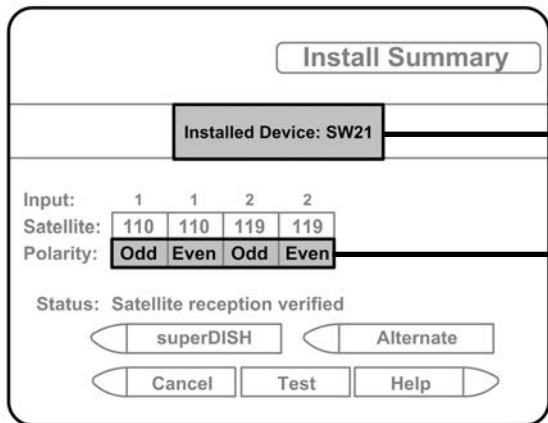

**MUST SHOW  
"SW21"  
  
NO "X"s**

### DISH HD Eastern Arc

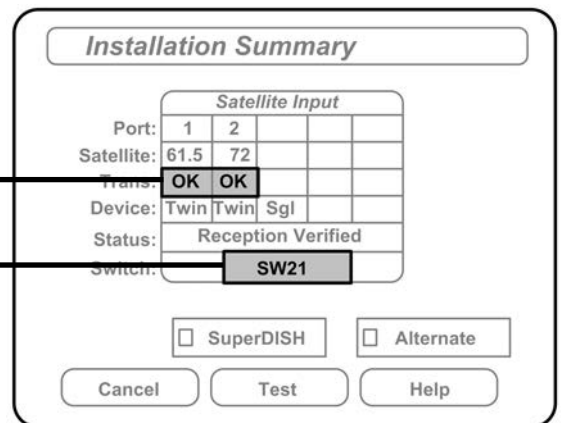

### DISH HD Western Arc with Locals

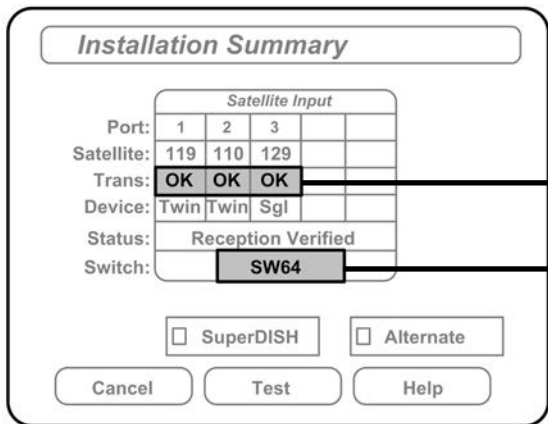

**NO "X"s  
  
MUST SHOW  
"SW64"**

### DISH HD Eastern Arc with Locals

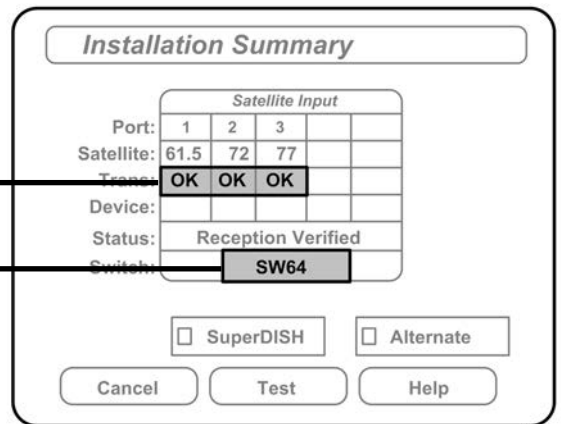



## DISH HD Alternate with Locals

**Installation Summary**

Satellite Input			
Port:	1	2	3
Satellite:	119	110	61.5
Trans:	OK	OK	OK
Device:	Twin	Twin	Sgl
Status:	Reception Verified		
Switch:	SW64		

SuperDISH     Alternate

NO "X"s

MUST SHOW "SW64"

## Bell TV 91

**Install Summary**

NO SWITCH DETECTED

Input:	1	1	2	2
Satellite:	91	91	x	x
Polarity:	Odd	Even	x	x

Status: Satellite reception verified

"NO SWITCH DETECTED"  
or  
"INSTALLED DEVICE UNKNOWN"  
or  
similar

MUST SHOW "SW21"  
NO "X"s

## Bell TV HDTV 82/91 Bell TV HDTV 82/91 Alternate

**Install Summary**

Installed Device: SW21

Input:	1	1	2	2
Satellite:	82	82	91	91
Polarity:	Odd	Even	Odd	Even

Status: Satellite reception verified

If indicated results are not obtained, go back to Step 3 and run test again. Contact King Controls if the check switch fails to load after 4 attempts.

8. Save the settings, exit to the main menu screen and wait for programming to download.
9. **DISH HD Eastern and Western Arc with Locals only:** Verify your saved settings show your desired satellite trio 61.5, 72, 77 or 110, 119, 129. To switch trios, see page 34.

**Configuration is complete. Go to page 32, OPERATION.**

**IMPORTANT:** Unless you have DIRECTV service for single satellite 101, you must have completed the antenna configuration as instructed in Section 4 ANTENNA CONFIGURATION.

There must be a clear “line of sight” to the southern sky. Mountains, buildings, trees, telephone poles, etc. can all block the satellite signal from reaching the antenna.

The distance driven since last performing a search may affect how long it takes for the King-Dome to find the satellite.

This King-Dome can receive available HDTV programming from DIRECTV Ku band satellites at 101° and 119°. It will not receive channels broadcast from DIRECTV’s Ka band satellites at 99° and 103°.

## STATIONARY SEARCH

1. Turn on TV and Receiver. “Searching for Satellite” or similar will appear on TV screen.

2. On King-Dome controller, press and hold ON for **3 FULL SECONDS**.

Power light turns steady GREEN.

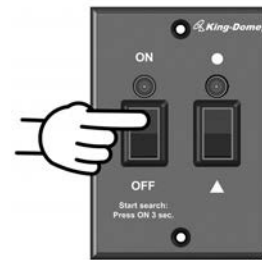

### STATUS LIGHT

- a) flashes a variety of colors for about 30 seconds
- b) RED-flashing
- c) GREEN-flashing (may start flashing RED again)
- d) GREEN-steady

### SYSTEM STATUS

- unit performs self-diagnostic
- search in progress
- potential satellite found
- satellite(s) found and search is complete

3. When the status light is steady green, select a channel or the program guide to view your programming. Enjoy! **(DO NOT TURN THE KING-DOME OFF IF USING THE AUTOMATIC SATELLITE SWITCHING FEATURE.)**

Note: If the status light is steady GREEN and your programming does not appear, press the reset button on your DIRECTV receiver. If using DISH, hold the receiver power button in for 10 seconds to reset your receiver. Consult your receiver owner’s manual for further details. (Note that it may take several minutes for the guide to re-download.)

When receiver reset is complete and the guide is downloaded, select a channel or the program guide to view your programming.

# AUTOMATIC SATELLITE SWITCHING

1. After you have properly configured the *King-Dome<sup>AIR</sup>* antenna and your satellite receiver, the dish will automatically switch between satellites by simply selecting your desired channel using the receiver's remote control.

Note: For better performance when using the automatic satellite switching feature, change channels by selecting your program from the channel guide rather than channel surfing.

It is common for the picture to pixel or display an error message when the antenna is switching between satellites, or the signal has been temporarily blocked. PLEASE BE PATIENT. THE PICTURE WILL RETURN.

If an error message appears for an extended period, selecting CANCEL on your receiver's remote control may help clear the message more quickly.

**DISH HD users:** If you are unable to receive all of your HD programming, see **DISH HDTV: Changing the Satellite Trio** on page 34.

## IN-MOTION OPERATION (KD-3200 series only)

1. Perform a stationary search as shown on the previous page.
2. Allow your programming to download.

3. Press ▲.

### STATUS LIGHT

- a) alternating colors
- b) GREEN-flashing
- c) GREEN-steady

### SYSTEM STATUS

- initializing
- potential satellite found
- target satellite found (tracking)

When the status light is steady green, the target satellite is found and the unit is tracking.

## ALTERNATE SEARCH METHOD (Above method is the manufacturer's preferred method)

1. Press ON.
2. Press ▲. Before putting the vehicle into motion, wait for the status light to turn steady green and your programming to download.

Note: While driving and in tracking mode, objects such as bridges, buildings and trees may occasionally block the satellite signal from reaching the antenna. Line of sight obstructions may cause the picture on your TV to freeze, pixel or be lost temporarily. PLEASE BE PATIENT. THE PICTURE WILL RETURN.

If the antenna does not sense vehicle motion after several minutes, it will enter sleep mode. The antenna will automatically wake and begin tracking if it senses vehicle motion or a severe drop in satellite signal.

When you park for the evening or any extended period, it is recommended that you perform a stationary search.

# DISH HDTV: Changing the Satellite Trio

## DISH HD Western and Eastern Arc with Locals

**IMPORTANT!** Perform this procedure only if you are unable to receive all of your HD programming in a particular area of the country.

You cannot use this method to change trios if the antenna has not been initially configured for DISH HD Western Arc with Locals or DISH HD Eastern Arc with Locals (see ANTENNA CONFIGURATION section).

You can only switch between the DISH HD Western Arc with Locals and the DISH HD Eastern Arc with Locals Trios. The DISH HD Alternate with Locals Trio is not included in this function. (See ANTENNA CONFIGURATION for when and how to choose the DISH HD Alternate with Locals Trio.)

DISH HD programming is broadcast from multiple satellites including these two trios:

- the DISH HD Western Arc with Locals Trio: 110, 119, 129 satellites
- the DISH HD Eastern Arc with Locals Trio: 61.5, 72, 77 satellites

The map below shows the approximate coverage for each trio.

The *King-Dome<sup>AIR</sup>* antenna can be easily configured to work with either trio as you travel from one coverage area to another. By choosing the appropriate trio based on where you are, you can receive all of your desired programming.

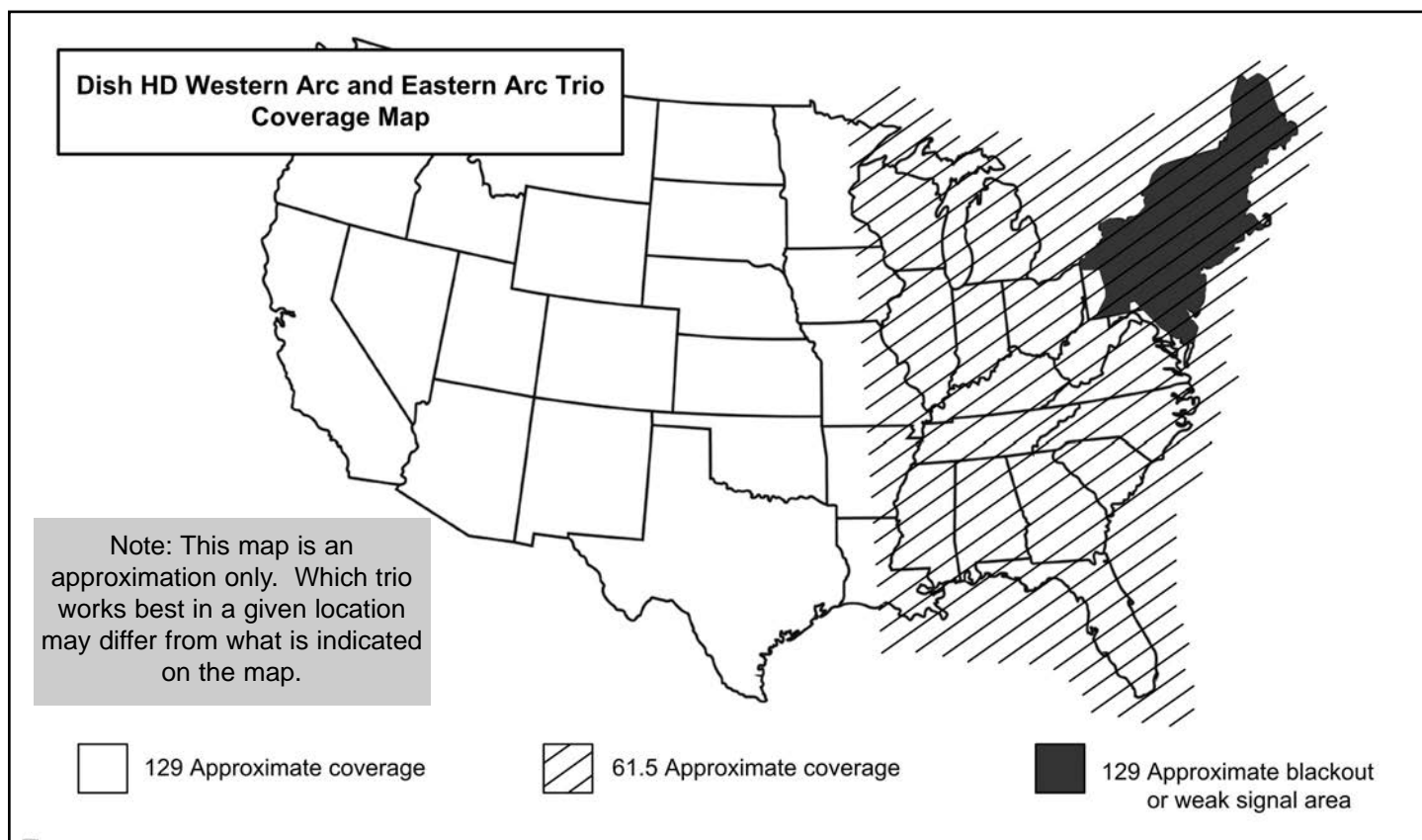

1. Press ON. Wait for the Status Light to flash orange, and then **wait 4 more seconds.**

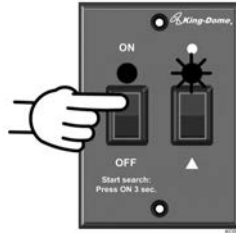

2. Press and release ON 4 times. Status Light starts rapidly flashing green and red.
3. Select the trio you want to change to:

**DISH HD Eastern Arc Trio 61.5, 72, 77**

Press and hold ▲ for 4 seconds.

A diagram of the control panel with a hand holding the white triangle button above the 'OFF' button.

The Status Light turns orange for 1 second and then starts flashing green or red.

**DISH HD Western Arc Trio 110, 119, 129**

Press and hold ● for 4 seconds.

A diagram of the control panel with a hand holding the black circle button above the 'ON' button.

The Status Light turns orange for 1 second and then starts flashing green or red.

4. Turn the unit off.
5. Perform a stationary search and reload the check switch (page 29).  
**YOU MUST DO THIS STEP!**

**EXTREMELY IMPORTANT!**  
You **MUST** perform a stationary search and reload the check switch any time you switch trios.

**IMPORTANT!: There is no guarantee you will receive off-air digital programming in a given area. Weather, terrain, buildings, excessive signal reflections (ghosting), proximity to the transmission towers, transmission strength, etc. can all affect your ability to receive off-air programming.**

Note: Digital programming received via your off-air antenna is transmitted from land based towers. These towers are usually grouped together in or near a city, and transmit over a given area. If you are in this area, you should receive the programming. Keep in mind there must be a line of sight between the transmitting towers and your off-air antenna. Distance is also important. The closer you are to the towers, the stronger the signal will be.

To find out about local channels available in your area, visit [titantv.com](http://titantv.com).

To find out more information about off-air digital tv reception, visit [antennaweb.org](http://antennaweb.org) and [dtv.gov](http://dtv.gov).

The *King-Dome<sup>AIR</sup>* is equipped with an internal off-air antenna to receive local digital and HDTV programming. Follow the appropriate instructions:

*King-Dome<sup>AIR</sup>* NOT CONNECTED to existing off-air antenna . . . .Page 37

*King-Dome<sup>AIR</sup>* CONNECTED to existing off-air antenna . . . . .Page 38

Note: You will not have off-air signal reception while the vehicle is in motion.

## King-Dome<sup>AIR</sup> Off-Air Antenna Only

1. Turn the *King-Dome<sup>AIR</sup>* off (press OFF).

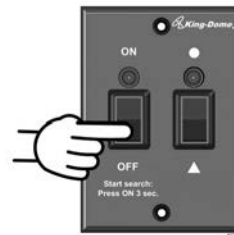

2. Press and release ON. Wait for the Status Light to flash orange, and then **wait 2 more seconds**.

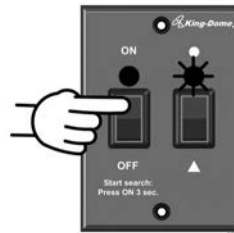

3. Press and release ●. The Status light will flash a variety of colors and then turn steady green. When both lights are steady green the off-air antenna pointing feature is active.



Note: Performing a channel scan in steps 4 and 7 will erase channels from your previous scan. If you wish to keep previous channels, you may have an “Update” or “Edit” feature on your digital TV or converter box. See your TV or converter box owner’s manual for details.

4. Perform a channel scan (see your TV or converter box owner’s manual).

5. Go to the signal meter screen and use the *King-Dome<sup>AIR</sup>* off-air antenna to peak signal strength as follows:

Press the ● button to rotate the *King-Dome<sup>AIR</sup>* antenna clockwise. Release the button when signal strength appears on the screen.

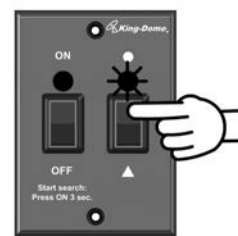

It will take the antenna one minute to rotate 360° and hit its rotational limit. When the limit is reached the status light will turn from a flashing green to a solid red. If you did not find any signal, you can rotate the antenna counter-clockwise by pressing the ▲ button. It will take the antenna approximately one and a half minutes to rotate to its other limit. If you do not find signal strength by this time, there is likely something blocking the signal, there is some type of interference, or you are out of the coverage area, and no channels will appear after the channel scan in step 7.

6. Use the ● and ▲ buttons to fine tune the signal strength as high as possible.

When fine tuning, press and release the buttons quickly. Each time you rotate the antenna while fine tuning, you may need to wait a few seconds for the signal strength to stabilize, as some receivers have a slight delay in displaying signal strength after it changes.

7. After peaking the signal strength, perform the channel scan again. You are now ready to watch TV. Enjoy!

## ***King-Dome<sup>AIR</sup>* Off-Air Antenna and Existing Off-Air Antenna**

1. Lock on your satellite with the *King-Dome<sup>AIR</sup>* (see instructions on page 32).
2. Raise or turn on the other off-air antenna (***not the King-Dome<sup>AIR</sup>***).

Note: Performing a channel scan in steps 3 and 5 will erase channels from your previous scan. If you wish to keep previous channels, you may have an "Update" or "Edit" feature on your digital TV or converter box. See your TV or converter box owner's manual for details.

3. Perform a channel scan (see your TV or converter box owner's manual).
4. Go to the signal meter screen and fine tune the signal strength as high as possible using the existing off-air antenna (see your owner's manual).
5. After peaking the signal strength, perform the channel scan again. You are now ready to watch TV. Enjoy!



## SECTION 7

**TROUBLESHOOTING**

SYMPTOM	POSSIBLE REASON	COURSE OF ACTION
<b>STATIONARY</b>		
Unit does not find satellite. (STATUS light flashes red or green.)	Did not hold ON/SEARCH button for <u>3 FULL SECONDS.</u>	Hold ON/SEARCH button for <u>3 FULL SECONDS.</u>
STATUS light flashes orange.	Before search: bad coax connection.  After unsuccessful search (approximately 25 minutes): obstruction in line of sight between dome and satellite.	Call King Controls.  Move vehicle to have unobstructed view of southern sky.
STATUS light does not stop rapidly flashing red and green.	Self check failed: potential motor problem.	Call King Controls.
STATUS light does not turn on or is dim.	Bad power source (low voltage).  Bad power or controller cable connection at dome.  Bad controller cable connection at controller.	Call King Controls.
STATUS light is steady green but no picture.	Satellite receiver is off or requires reset.  <i>King-Dome<sup>AIR</sup></i> is factory set for DIRECTV Single Satellite 101 and you have a different service.	Turn receiver on or reset.  Configure the <i>King-Dome<sup>AIR</sup></i> for your service (page 15).
<b>IN-MOTION</b>		
Picture freezes, pixelates, or is temporarily lost.	Objects such as bridges, buildings, and trees may temporarily block signal from reaching the antenna.	Problem will stop when objects no longer block signal.
STATUS light is steady green but no picture.	Satellite receiver is off or requires reset.  <i>King-Dome<sup>AIR</sup></i> is factory set for DIRECTV Single Satellite 101 and you have a different service.	Turn receiver on or reset.  Configure the <i>King-Dome<sup>AIR</sup></i> for your service (page 15).
<b>OFF-AIR ANTENNA</b>		
Cannot receive local off-air programming.	Off-air antenna is not turned on  Line of sight obstruction	Review procedure on pages 36-38.  Move vehicle to have clear view of transmission towers.
Note: You will not receive off-air channels while in motion.		

The *King-Dome*<sup>AIR</sup> Satellite System has been designed to be maintenance and trouble free.

For optimum signal strength, keep the dome clean from dirt, bugs, and other debris. Periodic washing of the dome with mild soap and water is recommended.

**IMPORTANT!** Do not power wash the *King-Dome*<sup>AIR</sup>.

If you plan on storing your vehicle for long periods of time, it is recommended that the system be put through a search procedure on a quarterly basis to keep all moving parts in good working order.

If you have any comments or questions, please contact the King Controls Service Department at (952) 922-6889, or email King Controls at [info@kingcontrols.com](mailto:info@kingcontrols.com).

### Rain Fade

Rain or dew on the dome can cause signal interference and make the digital picture freeze, pixel or go out altogether. This loss of signal is commonly referred to as “rain fade” and is caused by the combination of water in the atmosphere and water on the dome surface.

To minimize this issue and eliminate the effects of water on the dome, apply King Controls **Dome Magic**<sup>®</sup> rain fade solution to the dome. This will prevent water from sticking to the dome surface and blocking the signal. For additional details on **Dome Magic**<sup>®</sup> rain fade solution please contact an authorized King-Dome dealer or call King Controls at (952) 922-6889.



Single Application Packet #1830-SP



Spray Can #1830

Note: **Dome Magic**<sup>®</sup> will discolor black domes or domes painted a dark color.

## SECTION 9

# LIMITED WARRANTY

Every new King-Dome Satellite System is thoroughly inspected and tested before leaving the factory, and is covered by the following two year parts and one year labor limited warranty from the date of original purchase:

- Two year parts warranty: The customer is not responsible for the cost of replacement parts if the original part is determined to be defective under the terms of the warranty. The customer is responsible for the cost of replacement parts after two years.
- One year labor warranty: The customer is not responsible for labor costs to repair unit if unit falls under the terms of the warranty. Any warranty labor outside of that performed at the factory is not covered unless the product has been installed by an authorized dealer/installer or OEM manufacturer. The customer is responsible for all labor costs after one year.

Should any trouble develop during the warranty period, contact King Controls. You must contact King Controls before the warranty period expires. The customer must supply proof of purchase (such as a dated sales receipt) when requesting warranty service. If customer cannot supply proof, warranty period shall start 30 days after date of manufacture.

Only King Controls and certified dealers are authorized to perform warranty evaluations and repairs. Depending upon the problem, King Controls may authorize the dealer to perform the necessary repairs, or may have the unit returned to King Controls for repairs.

A certified dealer must not perform any repair without first contacting King Controls for a Service Order Number. King Controls will advise the dealer on how to proceed with any repairs.

If it is determined that the unit needs to be returned to King Controls, customer must return COMPLETE product, freight prepaid, to: **King Controls, 11200 Hampshire Avenue South, Bloomington, MN 55438-2453.**

If inspection shows the trouble is caused by defective workmanship or material, King Controls will repair (or at its option, replace) without charge.

When returning product, King Controls will supply an RMA number (Return Merchandise Authorization). This number must be clearly written on the box. Failure to clearly write RMA number on box may result in delays in processing claim. Along with product, customer should include in the box: his/her name, address, daytime phone number, proof of purchase and description of the problem.

This warranty does not cover installation and external wiring, or remanufactured units. This warranty is not transferable from the original owner.

Due to the expanding and changing TV market, King Controls cannot be held responsible for changes made to satellite services. Software updates to address such issues are not covered under warranty.

This warranty also does not apply where:

- The product has been abused, misused, improperly installed or improperly maintained.
- Repairs have been made or attempted by others that are not certified by King Controls to do such repairs.
- Repairs are required because of normal wear and tear.
- Alterations have been made to the product.
- The dome cover has been removed without authorization.
- Damage has been caused by power washing.
- Supplied grease not used in the external coax connections as specified in the instructions (non-portable only).
- Circumstances beyond the control of King Controls cause the product to no longer operate correctly.
- Customer is not the original owner.

**In no event shall King Controls be liable for any indirect, incidental, or consequential damages from the sale or use of the product. This disclaimer applies both during and after the term of the warranty.**

**King Controls disclaims liability for any implied warranties, including implied warranties of "merchantability" and "fitness for a specific purpose," after the one year term of this warranty.**

This warranty gives you specific legal rights, and you may also have other rights, which vary from state to state. Some states do not allow the exclusion or limitation of incidental or consequential damages, so the above limitation or exclusion may not apply to you. Some states do not allow limitations on how long an implied warranty lasts, so the above limitation may not apply to you.

## Notes:

## Notes:

## Notes:





11200 Hampshire Avenue South, Bloomington, MN 55438-2453  
Phone: (952) 922-6889 Fax: (952) 922-8424

[www.kingcontrols.com](http://www.kingcontrols.com)