

KENWOOD

COMPACT HI-FI SYSTEM

XD-SERIES

XD-502/XD-552/XD-572S

XD-402/XD-452

INSTRUCTION MANUAL

KENWOOD CORPORATION

This instruction manual is used to describe multiple models listed above.
Model availability and features (functions) may differ depending on the country
and sales area.



2 Before applying power

XD-SERIES (En)

⚠ Caution : Read this page carefully to ensure safe operation.

Units are designed for operation as follows.

U.S.A. and Canada AC 120 V only
Austraria AC 240 V only

Europe and U.K. AC 230 V only
China and Russia AC 220 V only
***Other countries** AC 110-120 / 220-240 V switchable

For the United Kingdom

Factory fitted moulded mains plug

1. The mains plug contains a fuse. For replacement, use only a 13-Amp ASTA-approved (BS1362) fuse.
2. The fuse cover must be refitted when replacing the fuse in the moulded plug.
3. Do not cut off the mains plug from this equipment. If the plug fitted is not suitable for the power points in your home or the cable is too short to reach a power point, then obtain an appropriate safety approved extension lead or adapter, or consult your dealer.

If nonetheless the mains plug is cut off, remove the fuse and dispose of the plug immediately, to avoid a possible shock hazard by inadvertent connection to the mains supply.

IMPORTANT: The wires in the mains lead are coloured in accordance with the following code:

Blue : Neutral
Brown : Live

Do not connect those leads to the earth terminal of a three-pin plug.

*AC voltage selection

The AC voltage selector switch on the rear panel is set to the voltage that prevails in the area to which the unit is shipped. Before connecting the power cord to your AC outlet, make sure that the setting position of this switch matches your line voltage. If not, it must be set to your voltage in accordance with the following direction.

AC voltage selector switch

Move switch lever to match your line voltage with a small screwdriver or other pointed tool.

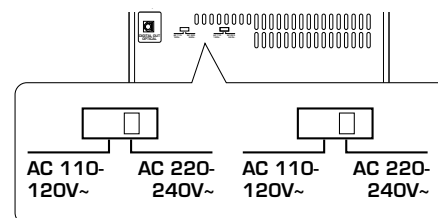

Note:

Our warranty does not cover damage caused by excessive line voltage due to improper setting of the AC voltage selector switch.

Safety precautions

WARNING : TO PREVENT FIRE OR ELECTRIC SHOCK, DO NOT EXPOSE THIS APPLIANCE TO RAIN OR MOISTURE.

	CAUTION RISK OF ELECTRIC SHOCK DO NOT OPEN		CAUTION: TO REDUCE THE RISK OF ELECTRIC SHOCK, DO NOT REMOVE COVER (OR BACK). NO USER-SERVICEABLE PARTS INSIDE. REFER SERVICING TO QUALIFIED SERVICE PERSONNEL.
	THE LIGHTNING FLASH WITH ARROWHEAD SYMBOL, WITHIN AN EQUILATERAL TRIANGLE, IS INTENDED TO ALERT THE USER TO THE PRESENCE OF UNINSULATED "DANGEROUS VOLTAGE" WITHIN THE PRODUCT'S ENCLOSURE THAT MAY BE OF SUFFICIENT MAGNITUDE TO CONSTITUTE A RISK OF ELECTRIC SHOCK TO PERSONS.		
	THE EXCLAMATION POINT WITHIN AN EQUILATERAL TRIANGLE IS INTENDED TO ALERT THE USER TO THE PRESENCE OF IMPORTANT OPERATING AND MAINTENANCE (SERVICING) INSTRUCTIONS IN THE LITERATURE ACCOMPANYING THE APPLIANCE.		



The marking of products using lasers (Except for some areas)

**CLASS 1
LASER PRODUCT**

The marking is located on the rear panel and says that the component uses laser beams that have been classified as Class 1. It means that the unit is utilizing laser beams that are of a weaker class. There is no danger of hazardous radiation outside the unit.

Contents

Preparation section

 Before applying power	2
 Safety precautions	2
 IMPORTANT SAFEGUARDS	4
Special features	6
Handling of discs and tapes	7
System connection	8
Accessories	8
Connection of the System Accessories	8
Connection with other components (optional or commercially-available equipment)	10
Controls and indicators	12
Main Unit	12
Display	14
Remote control Unit	15
Operation of remote control unit	16
CHANNEL SPACE setting	16
Operation of jog dials	17

Basic section

Let's put out some sound	18
Basic use method	18
Playback of CD	20
Playback of tape	22
Searching for the desired music program (DPSS) ...	25
Receiving broadcast station	26
Let's record	28
Recording on TAPE	28
Copying tape (Tape dubbing)	31

Application section

Playback of CD	32
Listening in the desired sequence (program playback)	32
Repeated playback	34
Random playback	36
R.D.S. (Radio Data System) (For U.K., Europe and Russia)	37
Searching for a desired program type (PTY search)	38
To be able to listen to the desired information at any time (EON)	40
Convenient CD recording	42
Selection of the Recording Type	42
Recording only desired titles (CD ONE TRACK RECORDING)	43
Recording of an entire CD (CD DIRECT RECORDING)	44
Recording the programmed titles (CD PROGRAM RECORDING)	45
Effective Sound Adjustment	46
Balance adjustment	46
Input level adjustment	47
Listening to music with desired tone and sound field/Switching the display (Equalizer effect and 3D surround effect)	48
Creation and memorizing of an equalizer pattern	49
Clock adjustment	50
Timer operation	51
Sleep timer (SLEEP)	51
Operate easy To use Timer (O.T.T.)	52
Timer programming	53

Knowledge section

Important Items	56
Maintenance	56
Reference	56
In case of difficulty	57
Specifications	61



As an ENERGY STAR® Partner, Kenwood Corporation has determined that this products meets the ENERGY STAR® guidelines for energy efficiency.
This product can save energy. Saving energy reduces air pollution and lowers utility bills.

4 IMPORTANT SAFEGUARDS

XD-SERIES (En)

! Caution :Read this page carefully to ensure safe operation.

Please read all of the safety and operating instructions before operating this appliance. Adhere to all warnings on the appliance and in the instruction manual. Follow all the safety and operating instructions. These safety and operating instructions should be retained for future reference.

- 1. Power sources** – The appliance should be connected to a power supply only of the type described in the instruction manual or as marked on the appliance. If you are not sure of the type of power supply to your home, consult your appliance dealer or local power company. For appliances intended to operate from battery power, or other sources, refer to the instruction manual.
- 2. Power-cord protection** – Power-supply cords should be routed so that they are not likely to be walked on or pinched by items placed upon or against them, pay particular attention to cords at plugs, convenience receptacles, and the point where they exit from the appliance.

Never pull or stretch the cord.

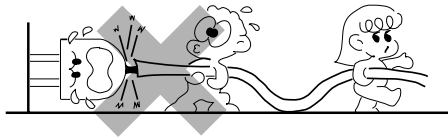

- 3. CAUTION – Polarization** – This appliance may be equipped with a polarized alternating-current line plug (a plug having one blade wider than the other). This plug will fit into the power outlet only one way. This is a safety feature. If you are unable to insert the plug fully into the outlet, try reversing the plug. If the plug should still fail to fit, contact your electrician to replace your obsolete outlet. Do not defeat the safety purpose of the polarized plug.

- 4. Ventilation** – Slots and openings in the cabinet are provided for ventilation and to ensure reliable operation of the appliance and to protect it from overheating, and these openings must not be blocked or covered. The appliance should be situated so that its location or position does not interfere with its proper ventilation.

To maintain good ventilation, do not put records or a table-cloth on the appliance. Place the appliance at least 10 cm away from the walls.

Do not use the appliance on a bed, sofa, rug or similar surface that may block the ventilation openings. This appliance should not be placed in a built-in installation such as a bookcase or rack unless proper ventilation is provided or the manufacturer's instructions have been adhered to.

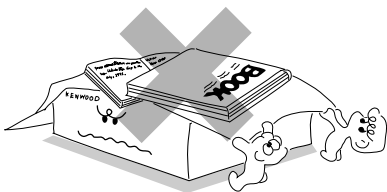

- 5. Water and moisture** – The appliance should not be used near water - for example, near a bathtub, washbowl, kitchen sink, laundry tub, in a wet basement, or near a swimming pool, etc.

- 6. Temperature** – The appliance may not function properly if used at extremely low, or freezing temperatures. The ideal ambient temperature is above +5°C (41°F).

- 7. Heat** – The appliance should be situated away from heat sources such as radiators, heat registers, stoves, or other appliances (including amplifiers) that produce heat.

- 8. Electric shock** – Care should be taken so that objects do not fall and liquid is not spilled into the enclosure through openings. If a metal objects, such as a hair pin or a needle, comes into contact with the inside of this appliance, a dangerous electric shock may result. For families with children, never permit children to put anything, especially metal, inside this appliance.

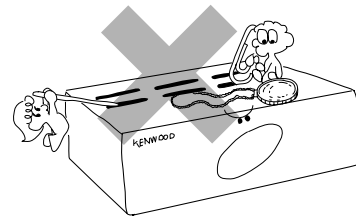

- 9. Enclosure removal** – Never remove the enclosure. If the internal parts are touched accidentally, a serious electric shock might occur.

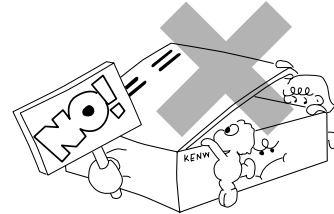

- 10. Magnetic fields** – Keep the appliance away from sources of magnetic fields such as TV sets, speaker systems, radios, motorized toys or magnetized objects.

- 11. Cleaning** – Unplug this appliance from the wall outlet before cleaning. Do not use volatile solvents such as alcohol, paint thinner, gasoline, or benzine, etc. to clean the cabinet. Use a clean dry cloth.

- 12. Accessories** – Do not place this appliance on an unstable cart, stand, tripod, bracket, or table. The appliance may fall, causing serious injury to a child or adult, and serious damage to the appliance. Use only with a cart, stand, tripod, bracket, or table recommended by the manufacturer, or sold with the appliance. Any mounting of the appliance should follow the manufacturer's instructions, and should use a mounting accessory recommended by the manufacturer. An appliance and cart combination should be moved with care. Quick stops, excessive force, and uneven surfaces may cause the appliance and cart combination to overturn.



13. Lightning – For added protection for this appliance during a lightning storm, or when it is left unattended and unused for long periods of time, unplug it from the wall outlet and disconnect the antenna or cable system. This will prevent damage to the appliance due to lightning and power-line surges.

14. Abnormal smell – If an abnormal smell or smoke is detected, immediately turn the power OFF and unplug the appliance from the wall outlet. Contact your dealer or nearest service center.

POWER OFF!

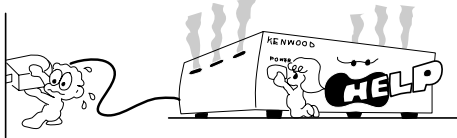

15. Damage requiring service – The appliance should be serviced by qualified service personnel when:

- A. The power-supply cord or the plug has been damaged.
- B. Objects have fallen, or liquid has been spilled into the appliance.
- C. The appliance has been exposed to rain or water.
- D. The appliance does not appear to operate normally by following the instruction manual. Adjust only those controls that are covered by the instruction manual as an improper adjustment of other controls may result in damage and will often require extensive work by a qualified technician to restore the appliance to its normal operation.
- E. The appliance has been dropped, or the enclosure damaged.
- F. The appliance exhibits a marked change in performance.

16. Servicing – The user should not attempt to service the appliance beyond that described in the instruction manual. All other servicing should be referred to qualified service personnel.

17. Outdoor antenna grounding – If an outside antenna is connected to the appliance, be sure the antenna system is grounded so as to provide some protection against voltage surges and built up static charges. Article 810 of the National Electrical Code ANSI/NFPA 70, provides information with respect to proper grounding of the mast and supporting structure, grounding of the lead-in wire to an antenna discharge unit, size of grounding conductors, location of antenna discharge unit, connection to grounding electrodes, and requirements for the grounding electrode. See Figure.

18. Power lines – An outside antenna system should not be located in the vicinity of overhead power lines or other electric light or power circuits, or where it can fall into such power lines or circuits. When installing an outside antenna system, extreme care should be taken to keep from touching such power lines or circuits as contact with them might be fatal.

19. AC outlets – Do not connect other audio equipment with a power consumption larger than that specified to the AC outlet on the rear panel. Never connect other electrical appliances, such as an iron or toaster, to it to prevent fire or electric shock.

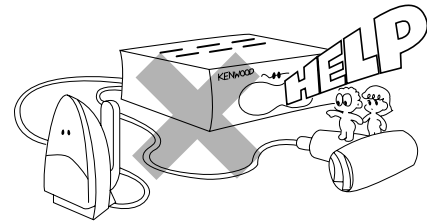

20. Overloading – Do not overload wall outlets, extension cords, or integral convenience receptacles as this can result in a risk of fire or electric shock.

21. Attachment – Do not use attachments not recommended by the appliance manufacturer as they may cause hazards.

22. Replacement parts – When replacement parts are required, be sure the service technician has used replacement parts specified by the manufacturer or have the same characteristics as the original parts. Unauthorized substitutions may result in fire, electric shock, or other hazards.

23. Safety check – Upon completion of any service or repairs to this appliance, ask the service technician to perform safety checks to determine that the appliance is in proper operating condition.



1. Item 3 is not required except for grounded or polarized equipment.
2. Item 17 and 18 are not required except for units provided with antenna terminals.
3. Item 17 complies with UL in the U.S.A.

EXAMPLE OF ANTENNA GROUNDING AS PER NATIONAL ELECTRICAL CODE

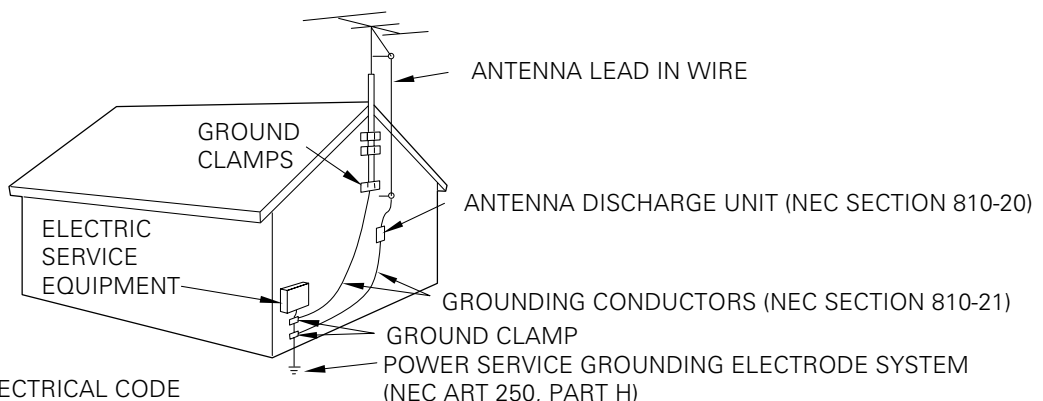

NEC – NATIONAL ELECTRICAL CODE

Simplified operations using large-sized, Twin Jog Dials**Multi-control jog dial (Right dial: For use in selecting a function)**

This dial allows you to set the CD program and timer-related operations while observing the operating conditions shown by the display and icons.

Sound control jog dial (Left dial: For use in selecting the tone and sound field)

This dial allows you to reproduce realistic audio by setting and registering desired equalizer patterns as well as selecting the preset equalizer patterns.

3D large-sized color display panel

The large sound level meter represents the movement in music with brilliant colors to offer the joy of viewing the music at the same time as listening.

3-Disc carousel CD player

Three discs can be set. There are various ways for enjoyment at the time of program playback, repeat playback, random playback, etc.

Convenient timer functions

Timer programming : Timer playback, timer recording and AI timer playback can be programmed.

- **AI timer playback :** When the unit is turned ON by the timer, the sound level increases gradually.

O.T.T. : Timer with easy setting, which operates only once.

Sleep timer : Useful when you want to go asleep while listening to music.

CD text information display (CD TEXT compatibility)

The text information (disc title and track titles) recorded in CDs can be displayed.

Demonstration

When the power supply is restored after a power failure or the power cord is unplugged and plugged in again during use, this unit automatically starts the demonstration function (display only). During the demonstration, the display changes in sequence but the audio does not change.

To cancel :

Press the DISPLAY/DEMO key during demonstration to stop it.

To switch over the demonstration :

Turn the unit OFF (STANDBY mode) and press the key.

DISPLAY
/DEMO



Each press of the key switches the demonstration as shown below.

- ① "Demo on" (Demonstration executed)
- ② "Demo off" (Demonstration canceled)

Disc handling precautions

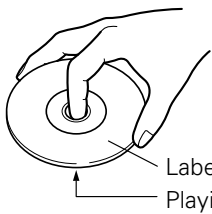

Handling

Hold the discs so that you do not touch the playing surface.

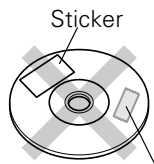

Sticky paste

Do not attach paper or tape to either the playing side or the label side of the discs.

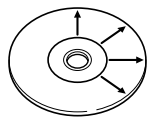

Cleaning

If fingerprints or foreign matter become attached to the disc, lightly wipe the disc with a soft cotton cloth (or similar) from the center of the disc outwards in a radial manner.

Storage

When a disc is not to be played for a long period of time, remove it from the player and store it in its case.

Discs which can be played with this unit

CD (12 cm, 8 cm), and the audio part of CDV, CD-G, CD-EG and CD-EXTRA.

Use discs that comply with the IEC standard, for example a disc carrying the  marking on the label surface.

Never play a cracked or warped disc

During playback, the disc rotates at high speed in the player. Therefore, to avoid danger, never use a cracked or deformed disc or a disc repaired with tape or adhesive agent. Please do not use discs which are not round because they may cause a malfunction.

Disc accessories

The disc accessories (stabilizer, protection sheet, protection ring, etc.) which are marketed for improving the sound quality or protecting discs as well as the disc cleaner should not be used with this system because they may cause malfunction.

Notes on cassette tape

Safety tab (accidental erasure prevention tab)

After an important recording has been finished, break the safety tab, to prevent the recorded contents from being erased or recorded on accidentally.

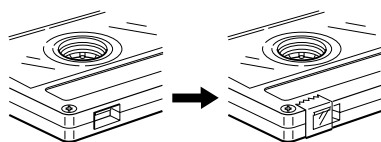
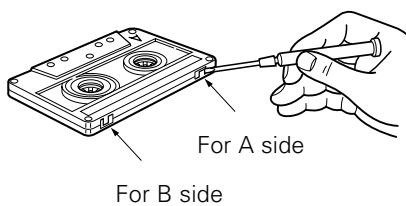

To re-record

Apply tape only to the position where the tab has been removed.

To store cassette tapes

Do not store the tapes in a place which is subject to direct sunlight, or near equipment that generates heat. Keep the cassette tapes away from any magnetic field.

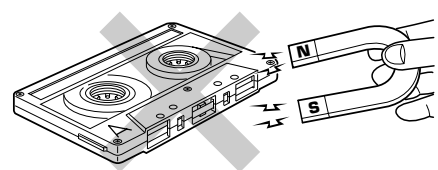

When there is slack in the tape

In such a case, insert a pencil into the reel hole and wind the reel hub to remove the slack.

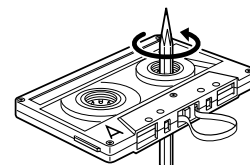

1. Longer tape than 110 minutes cassette tape

Since longer tape than 110 minutes cassette tape is very thin, the tape could adhere to the pinch roller or be easily cut. It is recommended that these tapes not be used with this unit to prevent possible damage.

2. Endless tapes

Do not use an endless tape, as this could damage the mechanism of the unit.

Accessories

FM indoor antenna (1)

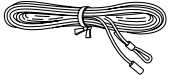

AM loop antenna (1)

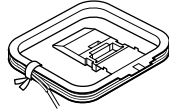

Remote control unit (1)

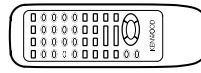

Batteries (R6/AA) (2)

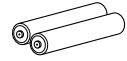

AC plug adaptor (1)

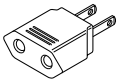

Use to adapt the plug on the power cord to the shape of the wall outlet. (Accessory only for regions where use is necessary.)

Speaker cords (2)

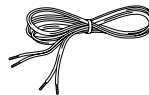

Provided in the speaker package

Preparation section

Unpacking

Unpack the unit carefully and make sure that all accessories are put aside so they will not be lost.

Examine the unit for any possibility of shipping damage. If your unit is damaged or fails to operate, notify your dealer immediately. If your unit was shipped to you directly, notify the shipping company without delay. Only the consignee (the person or company receiving the unit) can file a claim against the carrier for shipping damage.

We recommend that you retain the original carton and packing materials for use should you transport or ship the unit in the future.

Keep this manual handy for future reference.

Connection of the System Accessories

CAUTION Note on Connection

Connect the components as shown in the diagram. Only plug the power cord into a power outlet once connections are completed. The rear panel configuration is variable depending on the models (countries or area).

FM indoor antenna

The accessory antenna is for temporary indoor use only. For stable signal reception we recommend using an outdoor antenna. Remove the indoor antenna if you connect one outdoors.

- ❶ Connect to the antenna terminal.
- ❷ Locate the position providing good reception condition.
- ❸ Fix the antenna.

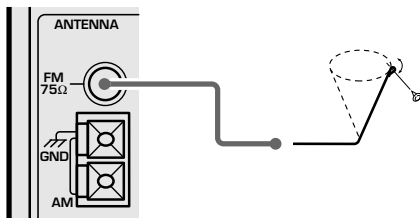

AM loop antenna

The supplied antenna is for indoor use. Place it as far as possible from the main system, TV set, speaker cords and power cord, and set it to a direction which provides the best reception.

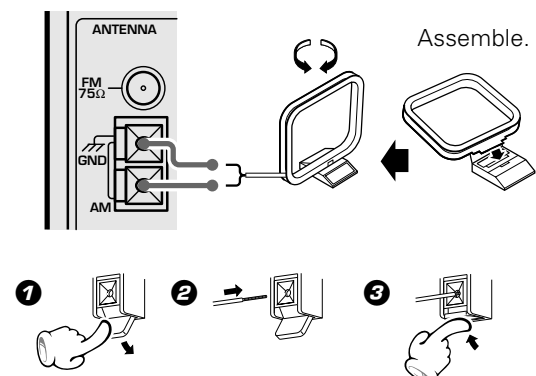

Speakers

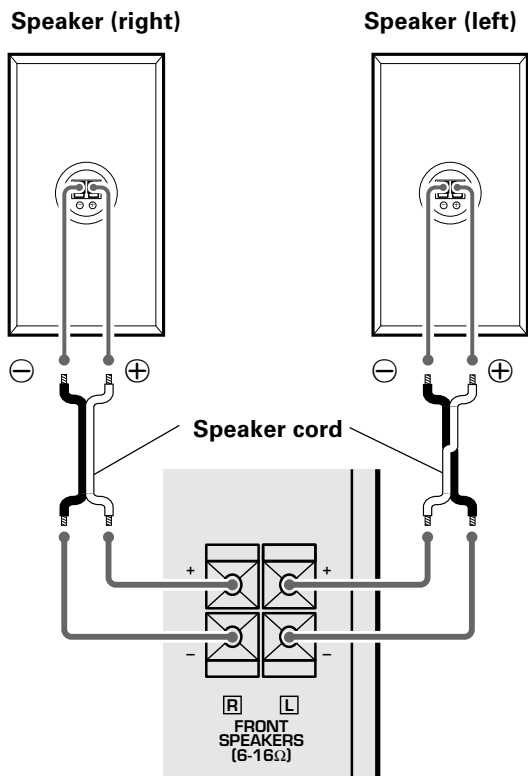

- Never short-circuit the "+" and "-" speaker cords.
- If the left and right speaker connections or the "+" and "-" polarity are inverted, the sound will be unnatural with unclear positioning of musical instruments, etc. Be sure to connect them without mistake.

System Name	Speaker Model Name
XD-402	LS-N402
XD-452	LS-N452
XD-502	LS-N502
XD-572S/XD-552	LS-N552

Main Unit

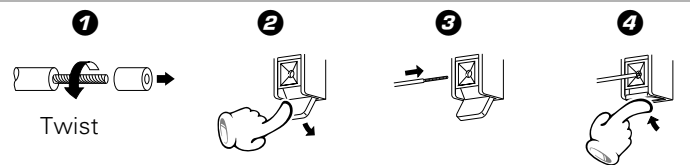

Speaker Unit

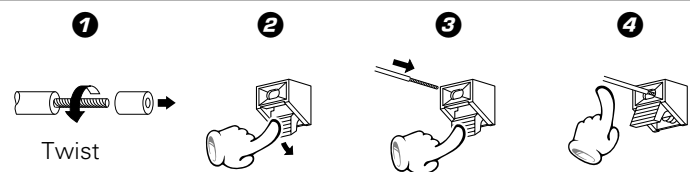

Caution regarding placement

(For U.S.A., U.S.-Military and Canada)

Be sure to adhere followings. Or proper ventilation will be blocked causing damage or fire hazard.

- Do not place any objects impairing heat radiation onto the top of unit.



1. Be sure to insert all connection cords securely. If their connections are imperfect, the sound may not be produced or noise may interfere.
2. Before plugging or unplugging a connection cord, be sure to unplug the power cord from the wall AC outlet. If connection cords are plugged or unplugged with the power cord left plugged in, malfunction or damage may result.

Malfunction of microcomputer

If operation is not possible or erroneous display appears even though all connections have been made properly, reset the microcomputer referring to "In case of difficulty".

— 57

Speaker and TV installation

If there is a magnet or other device generating magnetic force nearby, interaction between the magnet and speaker may cause color blotching on the TV. If this happens, move the speaker at least 20 cm away from the TV set.

Caution regarding placement (Except for U.S.A., U.S.-Military and Canada)

Be sure to adhere followings. Or proper ventilation will be blocked causing damage or fire hazard.

- Do not place any objects impairing heat radiation onto the top of unit.
- Leave a space around the unit (from the largest outside dimension including projection) equal or greater than, shown below.

Top panel : 50 cm, Side panel : 10 cm, Back panel : 10 cm

Connection with other components (optional or commercially-available equipment)

CAUTION Note on Connection

Connect the components as shown in the diagram. Only plug the power cord into a power outlet once connections are completed. The rear panel configuration is variable depending on the models (countries or area).

MD recorder, DVD player, VCR or analog turntable

MD recorder/VCR



Audio input

Audio output

Optical-fiber cable
(Provided with the MD recorder)

DVD player/analog turntable (P-110/optional)

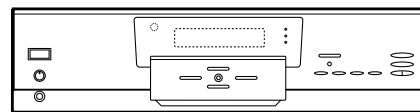

Audio output

- If an external component such as a DVD player is connected to the **MD/DVD INPUT** jacks, the **MD REC OUTPUT** jacks do not output the audio of the external component.

Super woofer

Extremely low sound is played back powerfully.

(SW-500/optional)

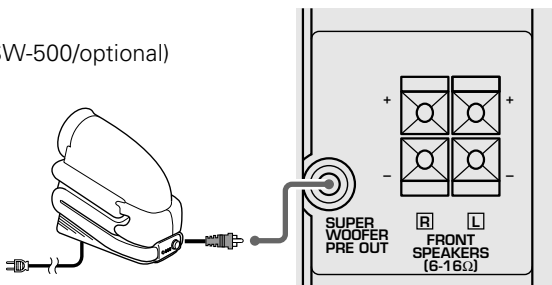

Power cord
To wall AC outlet

DIGITAL OUT jack (OPTICAL)

Remove the cap and plug the optical-fiber cable.

(Except for U.S.A. and Canada)

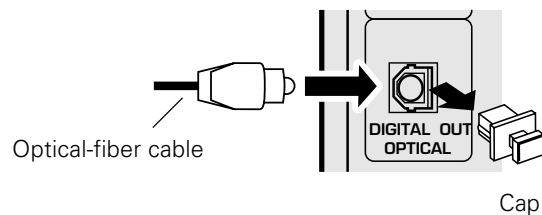

- Insert the optical-fiber cable straight into the connector until it clicks.
- Be sure to attach the protection cap when the connector is not used.
- Never band or bundle the optical-fiber cable.



In case an associated system component is connected, also read the instruction manual of the component.

Surround (rear) speakers

XD-5....series : Except for U.S.A. and Canada
XD-4....series : Except for U.S.A., Canada, U.K., Europe and Russia

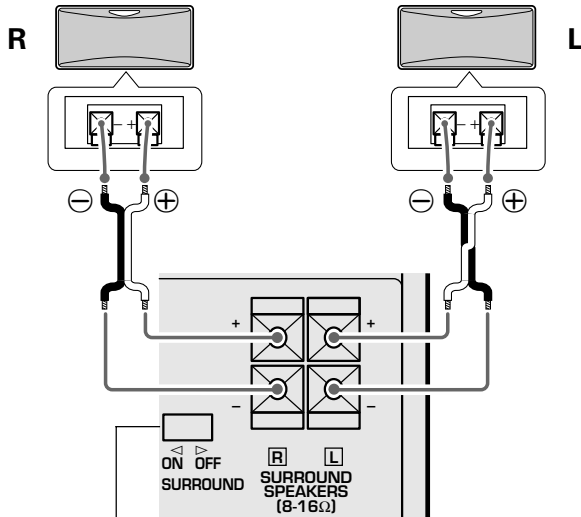

Surround switch

In regard to the SURROUND switch

This switch can be used only when the separately sold surround (rear) speakers are connected. When the switch is set to ON, surround playback can be enjoyed. When this switch is set to OFF, normal playback is executed.

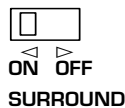

- Please operate this switch while the power is switched off.
- We recommend to keep this switch set to OFF when no surround (rear) speakers are connected to obtain a better sound quality.
- When the switch is set to OFF, no sound will come from the surround (rear) speakers.

Main Unit

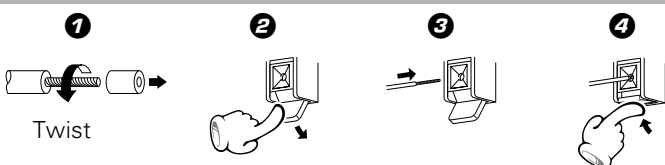

Speaker Unit

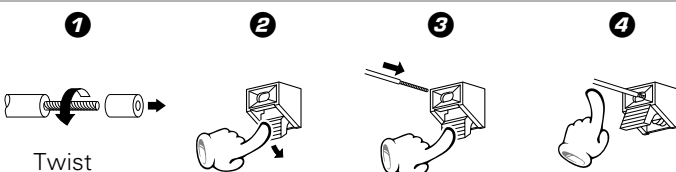

FM outdoor antenna

Lead the 75Ω coaxial cable connected to the FM outdoor antenna into the room and connect it to the FM 75Ω terminal.

Use a commercially-available antenna adapter (a small-sized model).

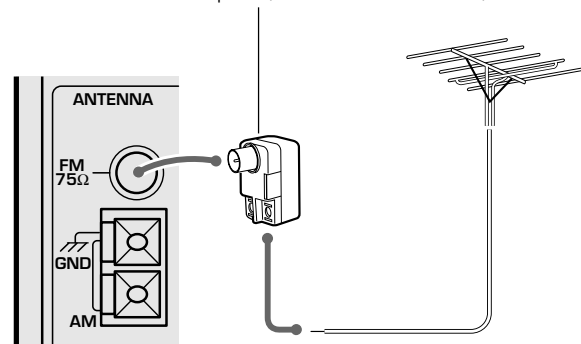

Reception mode switching of FM broadcast (For Russia)

When you want to receive an FM broadcast in PILOT TONE mode, changing the setting as follows.

- 1 Select the TUNER input.
- 2 While holding the SELECT key depressed, turn the SOUND CONTROL jog dial to select the system mode.



- 1 POLAR system
- 2 PILOT TONE system

Polar → Pilot

- 3 Establish the selection.



Main Unit

Preparation section

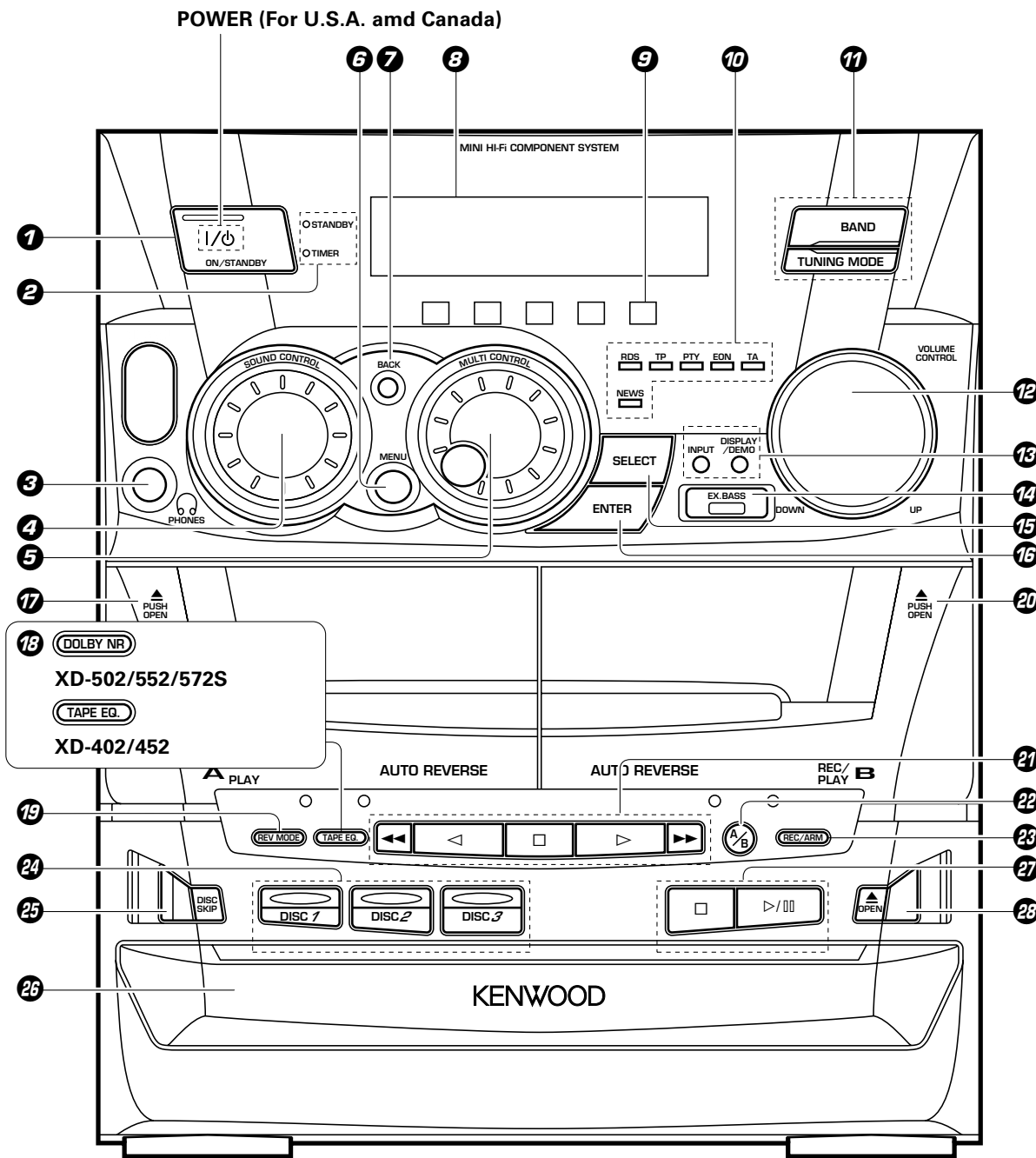

CD player unit

- 24 DISC SELECTOR key** → 21
 The disc for playback (or recording) is selected.
DISC SELECTOR indicators (XD-5... series only)
 The indicators corresponding to the trays accommodating discs light up. During playback of a CD, the indicator corresponding to the CD blinks.
- 25 DISC SKIP key** → 21
 The disc for playback (or recording) is selected. This is also used for insertion of a CD to the inside of the disc tray.
- 26 Disc tray** → 20
 Three discs can be stored.
- 27 CD operation keys** → 20 → 21
Play/pause (▷/⏸) key
Stop (◻) key
- 28 Tray open/close (▲ OPEN) key** → 20
 The disc tray is opened and closed.

Receiver**① ON/STANDBY (I / ⏻) key** → 18
ON/STANDBY (POWER) key (For U.S.A. Canada) → 18

Power ON/OFF switching is executed.

② STANDBY indicator → 19

The indicator lights up when the power is set to the STANDBY mode.

TIMER indicator → 52 → 55

The indicator lights up together with the STANDBY indicator when the power is set to the STANDBY mode after having activated a timer program.

③ PHONES terminal → 18

For connection of a headphone (optional).

④ SOUND CONTROL jog dial → 17 → 48

Turn this dial to select or cancel the equalizer and 3D surround settings.

⑤ MULTI CONTROL jog dial → 17 → 21 → 26

Turn this dial to select optimum modes according to the desired operations.

When the CD input is selected, this dial is used to skip tracks.

When the TUNER input is selected, this dial is used to select a station.

⑥ MENU key → 17

Press to switch the mode set with the **MULTI CONTROL** jog dial ON or OFF. The item selected by this key is variable depending on the current operation mode.

MENU indicator (XD-5... series only)

The indicator starts to blink when the **MENU** key is pressed.

⑦ BACK key → 17

Press when setting a mode using the **MULTI CONTROL** jog dial to return to the previous step and restart the operation from there.

⑧ DISPLAY → 14**⑨ Icon indicators** → 17**(CD PGM, REC. , DUBBING, AUDIO, CLOCK)**

When a mode is set using the **MULTI CONTROL** jog dial, the icon indicators corresponding to the current mode light up.

⑩ RDS-related indicators → 37
(For U.K., Europe and Russia)**⑪ Tuner operation keys** → 26**BAND key**

Press to switch the receiving band.

TUNING MODE key

Switches the tuning mode.

⑫ VOLUME CONTROL knob → 18

This is used for volume adjustment.

⑬ INPUT key → 18

Press to select the input source. When TAPE or CD is selected, playback starts automatically provided that a tape or disc has already been loaded.

DISPLAY/DEMO key → 6 → 48

Switches the displayed information.

When power is STANDBY:

Switches the demonstration on and off.

⑭ EX. BASS (Extra bass) key → 19

Switches the extra bass play on and off.

EX.BASS indicator (XD-5... series only) → 19

The indicator lights up when the Extra Bass is switched on.

⑮ SELECT key → 17 → 50

Used for setting of various modes or establishing a selection.

When power is STANDBY:

Used for displaying the time. (When this key is pressed while the "TIMER" indicator is lit, the "PROG." or "O.T.T." indicator also lights up, the timer reservation setting mode is displayed, then the display returns to the previous condition.)

⑯ ENTER key → 17

Used for entering a selected mode in memory or executing it.

Cassette deck unit**⑰ A deck cassette holder**

Press the area marked ▲ **PUSH OPEN** to load or eject a tape.

⑱ DOLBY NR key (XD-5...series only) → 29

Dolby noise reduction ON/OFF switching is executed.

TAPE EQ. key (XD-4... series only) → 23

Press to switch the Tape Equalizer on and off.

⑲ REV. MODE key → 23

The reverse mode of the deck (both sides, repeated, one side) is switched.

⑳ B deck cassette holder

Press the area marked ▲ **PUSH OPEN** to load or eject a tape.

㉑ Cassette deck operation keys → 22 → 23**Play (◀ ▶) keys****Stop (□) key****Fast forward and rewind (◀◀ ▶▶) keys****㉒ A/B key** → 22

Press to select the deck to be operated.

(For Russia) → 30

Used as the beat cancel key during recording of LW broadcasting.

㉓ REC/ARM key → 29 → 30

Press to start recording. Pressing the key during recording stops it after leaving a non-recorded space (blank) of about 4 seconds.

Display

The displays given in this manual are approximations only. They may differ from what actually appears on the display.

XD-502 / XD-552/ XD-572S

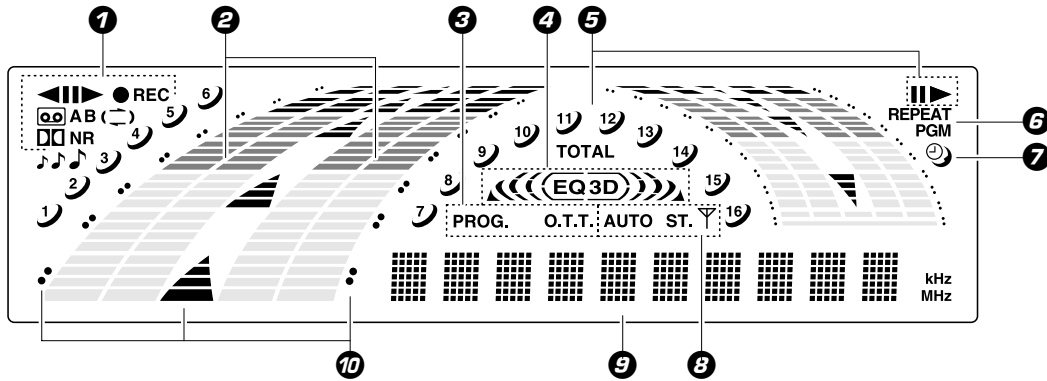

① Cassette deck-related indicators

This section contains the cassette deck operation indicators. The indicated information includes the tape reverse mode and tape transport direction.

② Sound level meter

The display varies according to the music or the operations of the CD, tape, etc. During the volume adjustment, this meter displays the current sound level as a reference.

③ Timer-related indicators

④ Equalizer/3D surround/"S. direct" indicators

⑤ CD player-related indicators

This section contains the CD play and pause mode indicators. It also shows the track numbers in the current disc.

⑥ REPEAT/PGM indicators

⑦ Sleep timer indicator

⑧ Tuner-related indicators

⑨ Character information display

Displays the input selection, frequency, volume level, etc.

⑩ Guideline

Blinks during the setting of an item using the jog dial.

XD-402 / XD-452

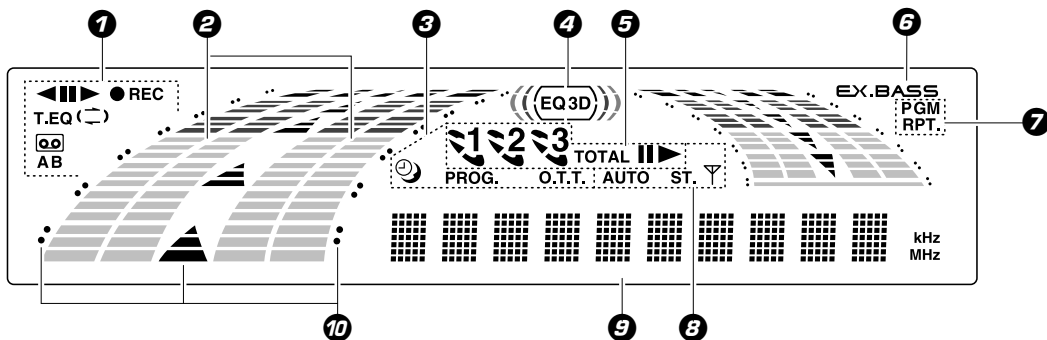

① Cassette deck-related indicators

This section contains the cassette deck operation indicators. The indicated information includes the tape reverse mode and tape transport direction.

② Sound level meter

The display varies according to the music or the operations of the CD, tape, etc. During the volume adjustment, this meter displays the current sound level as a reference.

③ Timer-related indicators

④ Equalizer/3D surround/"S. direct" indicators

⑤ CD player-related indicators

This section contains the CD play and pause mode indicators. It also shows the disc number being selected.

⑥ EX.BASS indicator

⑦ PGM/RPT. indicators

⑧ Tuner-related indicators

⑨ Character information display

Displays the input selection, frequency, volume level, etc.

⑩ Guideline

Blinks during the setting of an item using the jog dial.

Remote control Unit

The keys on the remote control unit with the same names as on the main unit have the same function as the keys on the main unit.

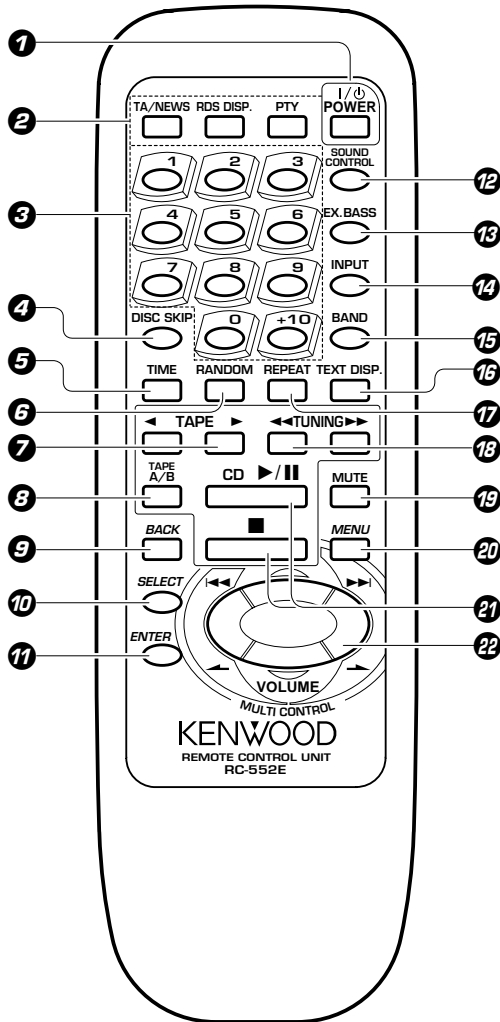

For U.K., Europe and Russia : RC-552E
 Other countries : RC-552

- 1 ON/STANDBY (I / ⏻ POWER) key** → 18
 Power ON/OFF switching is executed.
- 2 RDS-related keys (For U.K., Europe and Russia)**
- TA/NEWS key** → 40
 Used for automatic reception of transmissions of a certain content.
- RDS DISP. key** → 37
 The display contents are switched during reception of RDS broadcasts.
- PTY key** → 38
 This is used to specify the program type when searching for a station.
- 3 Numeric keys** → 21
 Used as number keys when the input is CD or TUNER.
- 4 DISC SKIP key** → 21

- 5 TIME key** → 21
 Press to switch the time information on the CD player unit.
- 6 RANDOM key** → 36
 For CD playback, switching is executed between random playback and normal playback.
- 7 TAPE play (◀ ▶) keys** → 22
- 8 TAPE A/B key** → 22 → 30
- 9 BACK key** → 17
- 10 SELECT key** → 17
- 11 ENTER key** → 17
- 12 SOUND CONTROL key** → 17 → 48
 Press to select or cancel the equalizer and 3D surround settings.
- 13 EX. BASS key** → 19
- 14 INPUT key** → 18
- 15 BAND key** → 26
- 16 TEXT DISP. key** → 42
 Press to switch the text information recorded in a CD TEXT disc.
- 17 REPEAT key** → 34
 Used for repeated playback of a CD.
- 18 TUNING (◀◀ ▶▶) keys (CD/TAPE/TUNER)** → 21 → 23 → 26
 When the CD or TAPE input is selected, press to fast forward or backward (rewind) the disc or tape.
 When the TUNER input is selected, press to select a station.
- 19 MUTE key** → 19
 This is used to mute the sound temporarily.
- 20 MENU key** → 17
- 21 CD play/pause (▶/⏸) key** → 20
Stop (■) key → 20 → 27
- 22 MULTI CONTROL/VOLUME keys** → 17 → 18
Skip/preset call (◀◀, ▶▶) keys (CD/TUNER) → 21 → 27

The left and right keys have the same functions as the MULTI CONTROL jog dial on the main unit.
 When the CD input is selected, press to skip forward or backward on the disc.
 When the TUNER input is selected, press to select preset station.
 The top and bottom keys are used to adjust the volume.

Loading batteries

❶ Remove the cover.

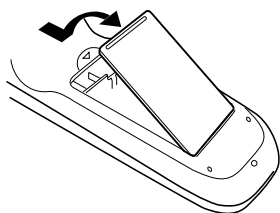

❷ Insert batteries.

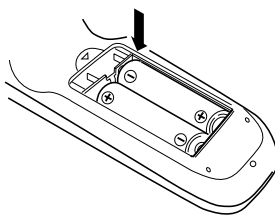

❸ Close the cover.

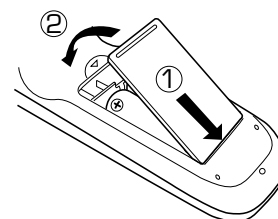

- Insert two R6 ("AA"-size) batteries following the polarity indications.

Operation

Plug the power cord into the mains power outlet and press the on/standby (I / ⏻ POWER) key of the remote control unit to turn power ON. After the power has been turned ON, press the desired key.

To turn power off, press the on/standby (I / ⏻ POWER) key again.

The power mode enters the **STANDBY** mode in which the "STANDBY" indicator lights up. (The "TIMER" indicator also lights in this mode if a timer program has been activated.)

- When pressing more than one remote control keys successively, press the keys securely by leaving an interval of 1 second or more between keys.

Operating range (approx.)

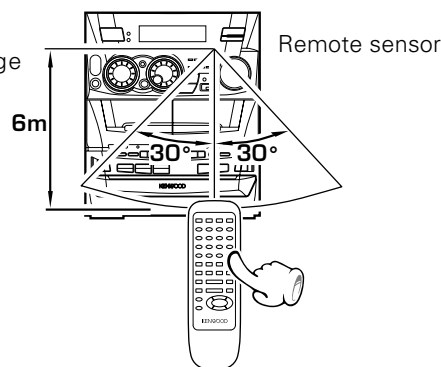

1. The provided batteries are intended for use in operation checking, and their service life may be short.
2. When the remote controllable distance becomes short, replace both of the batteries with new ones.
3. If direct sunlight or the light of a high-frequency fluorescent lamp (inverter type, etc.) is incident to the remote sensor, malfunction may occur. In such a case, change the installation position to avoid malfunction.

CHANNEL SPACE setting

(Except for the U.S.A., Canada, U.K., Europe, Australia and Russia)

The space between radio channels has been set to the one that prevails in the area to which the system is shipped. However, if the current channel space setting does not match the setting in the area where the system is to be used, for instance when you move from area 1 or area 2 shown in the following table or vice versa, proper reception of AM/FM (MW/FM) broadcasts cannot be expected. In this case, change the channel space setting in accordance with your area by referring to the following table.

Area	CHANNEL SPACE freq.
❶ USA, Canada and South American countries	FM : 100 kHz AM : 10 kHz
❷ Other countries	FM : 50 kHz AM : 9 kHz

❶ Select the TUNER input.

❷ While holding the SELECT key depressed, turn the SOUND CONTROL jog dial to select the system mode.

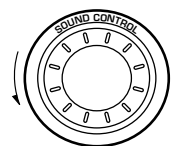

- ❶ "FM100/AM10 kHz" STEP,
- ❷ "FM 50 /AM 9 kHz" STEP,

FM100/AM10 kHz → FM 50/AM 9 kHz

- The "AM" display is variable depending on the model (country or area), and "MW" may be displayed in some areas.

❸ Establish the selection.



This unit has two jog dials named the **MULTI CONTROL** and **SOUND CONTROL** jog dials. The **MULTI CONTROL** jog dial makes it possible to set (establish) many functions in a simple procedure. When the **MENU** key is pressed, the icon indicators light according to the **MULTI CONTROL** jog dial operation so you can select the desired mode based on a more intuitive method.

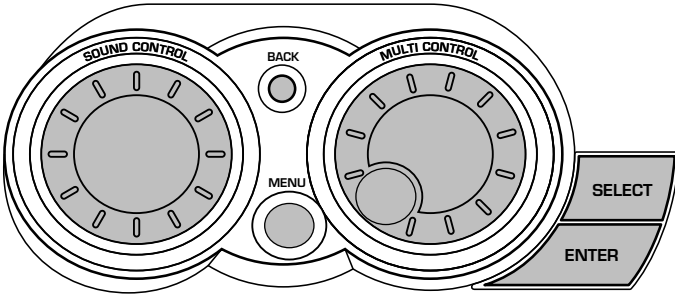

Icon indication example:

When "Tape Dubbing" is selected with the **MULTI CONTROL** jog dial (or the **MULTI CONTROL** key on the remote control unit), the "DUBBING" icon indicator lights up.

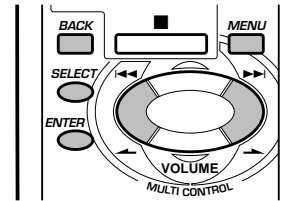

SOUND CONTROL jog dial

The **SOUND CONTROL** jog dial (or the **SOUND CONTROL** key on the remote control unit) makes it possible to select a tone or sound effect in an easy procedure.



Equalizer patterns and 3D surround levels that can be recalled

- "Rock" Rock music
- "Disco" Disco music
- "Pop" Pop music
- "Movie" Movie music
- "Jazz" Jazz music
- "Classic" Classic music
- "Custom EQ 1" } Equalizer's manual
- "Custom EQ 2" } memory created by the
- "Custom EQ 3" } user
- "3D Level 1" 3D surround level 1
- "3D Level 2" 3D surround level 2
- "S. direct" Pure sound can be reproduced by bypassing the EX.BASS, equalizer and 3D surround circuitry.
- "Effect off" Normal playback

- Pressing the **SOUND CONTROL** key on the remote control unit allows selection of same items as the **SOUND CONTROL** jog dial.

In the **MULTI CONTROL** setting mode (while the guideline is blinking), the **BAND** and play keys are defeated and inoperative.

MULTI CONTROL jog dial

- ❶ Press the **MENU** key to enter the **MULTI CONTROL** setting mode.
- ❷ Select an operation mode by turning the **MULTI CONTROL** jog dial (or pressing the **MULTI CONTROL** keys on the remote control unit).
- ❸ Set, establish or execute (determine) items by pressing the **SELECT** key and/or **ENTER** key.

Display examples

The following items can be selected by turning the **MULTI CONTROL** jog dial.

The messages inside () may not be displayed under certain situations.

- "CD Program Play")
Only when the CD input is selected
- "Recording Options")
Only when a tape is present in deck B
- "Tape Dubbing")
Only when the selected input is TAPE and tapes are present in both decks A and B
- "Audio Options"
- "Clock Options"

- To cancel the mode for setting (using) **MULTI CONTROL**, read the description of each item in this manual.
- Press the **BACK** key to return to the previous step and restart operation from there. (The **BACK** key is inoperative once scrolling message "Press ' ENTER ' to Start" has been displayed.)
- With the remote control unit, pressing the **MENU** key makes it possible to select the same items as those available on the main unit using the **MULTI CONTROL** keys.

Basic use method

Listening through headphones
Insert the headphone plug into the PHONES jack.
● The sounds from all speakers are cut off.

Muting the sound temporarily

Reproducing sound with enhanced bass

Reproducing sound with enhanced bass

Basic section

POWER ON/STANDBY or I/O ON/STANDBY

1

1. Switching the power ON (OFF)

When the power is ON, pressing the ON/STANDBY key enters the power STANDBY mode, in which the standby indicator lights up.

INPUT

2

2. Selecting the desired output

- ① TUNER (Radio) → 26
- ② CD → 20
- ③ TAPE → 22
- ④ MD/DVD (External input) → 10 → 47

● If you select the **MD/DVD** (external input) mode, also read the instruction manual of the component connected to the **MD/DVD INPUT** jacks.

VOLUME CONTROL

3

DOWN UP

3. Volume adjustment

● The display shows a reference value. (The reference value is also shown visually by the sound level meter.)

Muting the sound temporarily (Remote control unit only)

Blinks



- Press again to resume the original volume.
- The sound muting is also canceled when the volume is controlled.

Reproducing sound with enhanced bass (EX. BASS)

Lights

XD-5....series

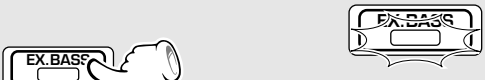

XD-4....series



- Each press switches EX.BASS on and off alternately.
- The EX.BASS is switched off automatically during recording or when the **SOUND CONTROL** jog dial is turned.

One-touch operation function

The power can also be turned ON by pressing the play key of the CD player, the play key of the cassette deck or the BAND key of the tuner.

It is also possible to turn the power ON by simply pressing the **▲ OPEN** key.

- When the CD or TAPE input is selected and a disc has been loaded in the disc tray or a tape has been loaded in the deck for use in playback, playback starts at the same time.

Standby mode

While the "STANDBY" indicator of the unit is lit, a small amount of current is flowing into the unit to back up its internal memory. (The **TIMER** indicator also lights if a timer program has been activated before entering the **STANDBY** mode.)

This condition is referred to as the standby mode of the unit. While the unit is in the standby mode, it can be turned ON from the remote control unit.

This unit has been designed to minimize power consumption.

When CD has been selected.



Volume display

Playback of CD



If a disc has already been loaded in the CD player and the power is OFF, simply pressing the CD play key turns power automatically ON and starts playback.

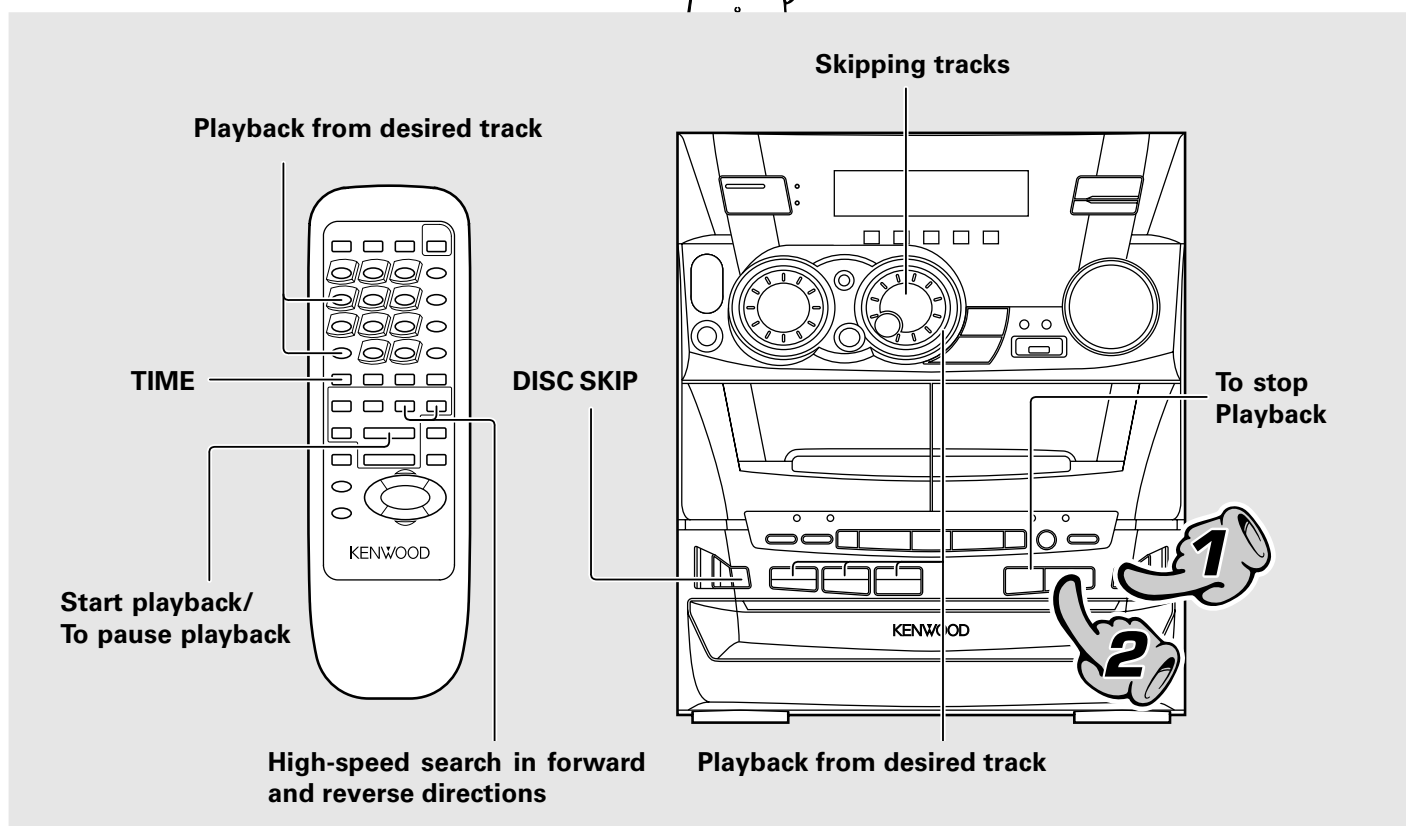

The tray opens when the key is pressed and closes when the key is pressed again.

1. Load a disc.

- ① Open the tray.
- ② Place a disc.
- ③ Close the tray.

Disc played first when the ▷/⏏ key is pressed.

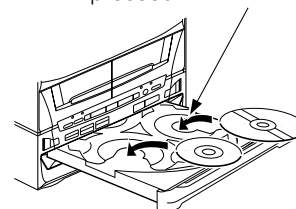

The label must be on top.

2. Start playback.

XD-5....series

The recorded track No. are shown.

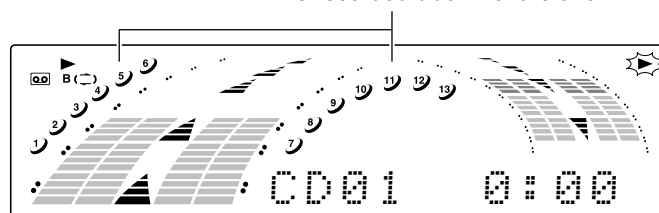
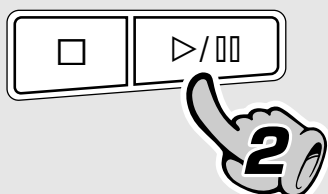

- After a few seconds, play starts from track No.1.
- Playback stops after having played all discs in the trays. (Relay play)
- When the ▲ OPEN key is pressed during playback, the tray opens but the playback continues. (The DISC SKIP key is inoperative at this time.)

Skipping tracks



To skip backward **To skip forward**

- The tracks in the direction the dial is rotated are skipped, and the selected track will be played from the beginning.
- When the jog dial is rotated a little in the direction of counterclockwise once during playback, the track being played will be played from the beginning.
- The CD tracks can also be skipped using the ◀◀ or ▶▶ key of the remote control unit.

High-speed search in forward and reverse directions (Remote control unit only)

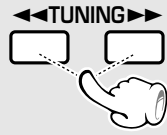

Backward search **Forward search**

- Playback starts from the position where the key is released.

- Do not touch the played side of disc.
- Rotate the tray with the **DISC SKIP** key to insert the third disc.
- The tray containing the disc to be played should come to the front right position when the unit is seen from the front.

XD-4....series

The selected disc is indicated.

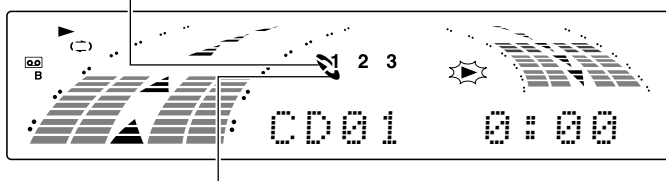

Lights when a disc is inserted at the time of playback.

Playback from desired track

Select the disc

(Main unit)

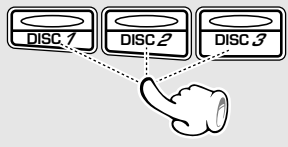

(Remote control unit)

DISC SKIP



Select the desired track No.

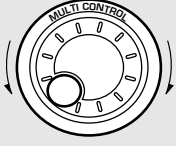
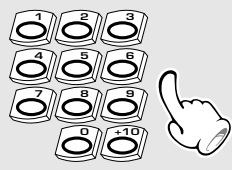



Press the numeric keys as shown below....

To select track No. 23: **+10 +10 3**

To select track No. 40: **+10 +10 +10 +10 0**

To pause playback



- Each press pauses and plays the CD alternately.

To stop playback

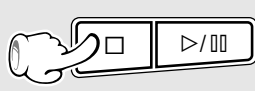

Time display on the CD player

Each press of the **TIME** key of the remote control unit switches the displayed time information.

- ① @ : 12 Elapsed time of track being played
- ② -4 : 18 Remaining time of track being played
- ③ 12 : 46 Elapsed time of disc ("TOTAL" lights up)
- ④ -63 : 14 Remaining time of disc ("TOTAL" lights up)

- Only the elapsed time of the track being played is displayed during program playback, random playback and single-track repeated playback.

Playback of tape



By loading a tape in the cassette deck to be used in playback beforehand, simply pressing the play key automatically turns the power ON and starts playback.

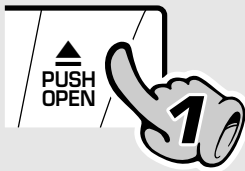
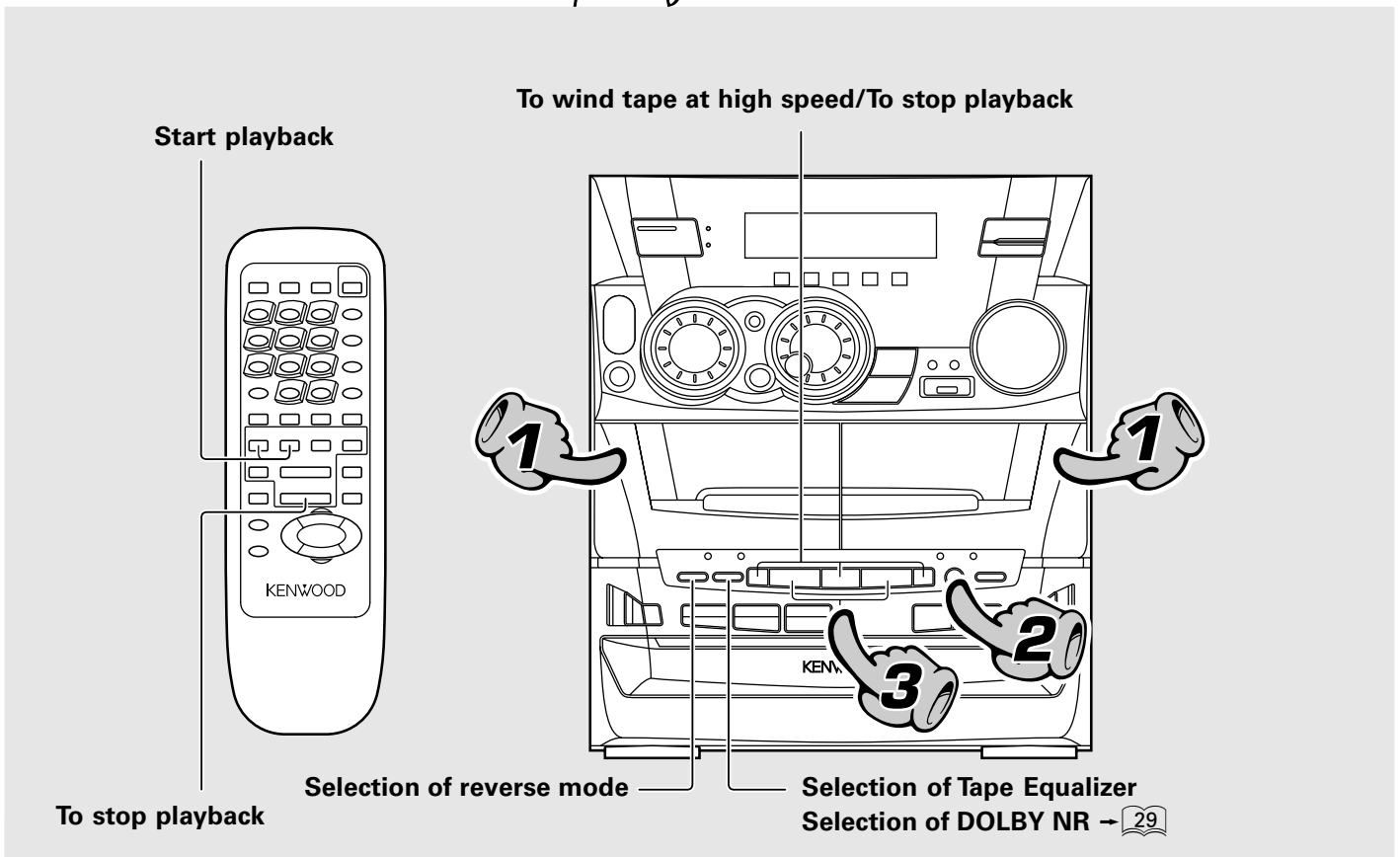

1. Load a cassette tape.

- ① Open the door.
- ② Insert a tape and close the door.

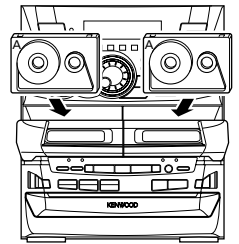

2. Select the deck to be used for playback.

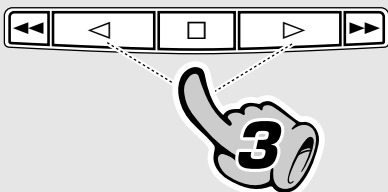

3. Start playback.

Press the play key of the desired direction.

- When playing back a source which has been recording using the equalizer or 3D surround effect, select "Effect off" with the **SOUND CONTROL** jog dial.

To wind tape at high speed

To fast wind in direction ← To fast wind in direction →

● Press the □ key to stop fast winding.

Selection of reverse mode (Main unit only)

Each press switches the modes as follows.

- ① "↔" Playback stops after having played both sides of tape in a deck. (Relay play : → 24)
- ② "↔" ... Endless playback of both sides of tape.
- ③ "↔" Playback stops after having played one side of tape.

Selection of Tape Equalizer (Main unit only) (XD-4....series only)

Select Tape Equalizer only when playing back a tape recorded with Dolby Noise Reduction. (A tape recorded without Dolby NR cannot be reproduced in normal audio if Tape Equalizer is selected when playing it.)



Each press switches the modes as follows.

- ① "T. EQ" ON Tape Equalizer is used
- ② "T. EQ" OFF Tape Equalizer is not used

- The Tape Equalizer is effective for reduction of higher-frequency noise.

To stop playback

● Do not take out the cassette tape until the tape transport has stopped completely.

- Normal (TYPE I), high (TYPE II), or metal (TYPE IV) tape selection is set automatically.
- Remove tape slack before loading.
- Close the door securely.

XD-5....series

XD-4....series

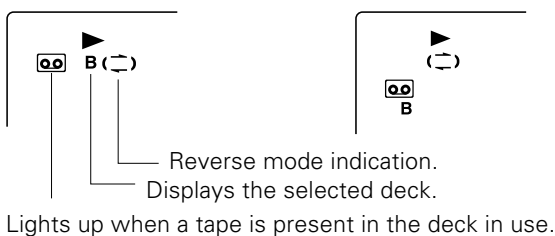

Transport direction indicators

The indicators (◀, ▶) indicate the current direction in which the tape advances when playback or recording is started automatically by the one-touch operation function, etc. This direction is the direction stored in memory when the tape was last stopped. (To switch the tape transport direction, press the play key corresponding to the desired direction then press the stop (□) key.)

Tape direction indicators of currently selected deck.



XD-5....series

XD-4....series

- If the tape transport direction is opposite to the desired direction, press the play key corresponding to this.

Relay play

When tapes are set in the decks A and B and the reverse mode is set to "↔" (play of both sides), play of the second deck will be started automatically after play of the first deck has been completed. Tape play will be repeated alternately.

- Relay play is not possible in the reverse modes "↺" and "↻".
- If a tape is loaded only in either deck, playback stops after having played both sides of the tape.

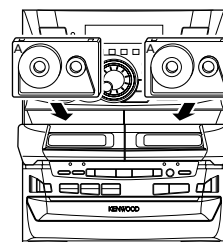

A tip for use of the tape counter

The tape counter is set to "0000" when a cassette tape is loaded. By writing down the counter reading in case you want to interrupt recording (playback) in the middle of the tape, the memo will be helpful as a reference for locating the same position when continuing the recording (playback) the next time. The tape counter figure decrements during recording or playback of the back side (while the ◀ tape transport indicator is lit).

To set the tape counter to "0000", open the cassette holder once. Then the counter will be reset.

TAPE 0000

Searching for the desired music program (DPSS)(XD-5....series only)

The DPSS (Direct Program Search System) is capable of detecting non-recorded spaces of more than 4 seconds as "blanks between programs" and, based on this information, can return to the beginning of the music program being played or the beginning of a desired program by skipping up to 16 other programs.

During play in direction ►

To play the next program : Press once.
 To play the 4th program after the current program : Press 4 times.

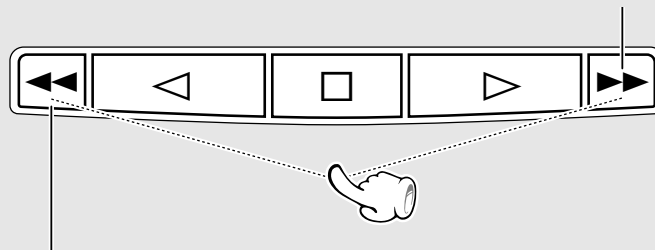

To return to the beginning of the current program : Press once.
 To play the 4th program before the current program : Press 5 times.

During play in direction ◀

To return to the beginning of the current program : Press once.
 To play the 4th program before the current program : Press 5 times.

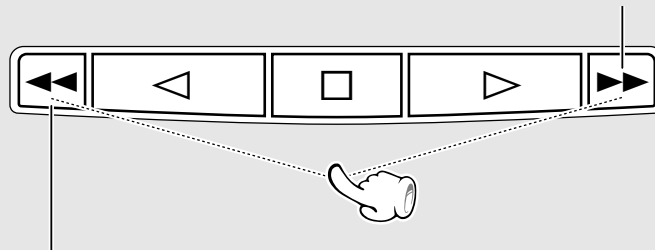

To play the next program : Press once.
 To play the 4th program after the current program : Press 4 times.



The DPSS may not function normally with the following kinds of tape.

- Tapes containing several no-sound intervals of more than 4 seconds, such as conversation and talk tapes.
- Tapes containing pianissimo sections, such as classical music tape.
- Tapes in which large noise is recorded in blanks between programs.
- Tapes containing blanks between programs that are shorter than 4 seconds.
- Tapes recorded at low level.
- Tapes recorded by cross-fade recording (in which the beginning of next program is overlapped on the end of previous program).

Receiving broadcast station

It is also possible to receive them by one-touch operations by storing up to 30 stations in the pre-set memory.



When the BAND key is pressed, this unit will be switched on automatically.

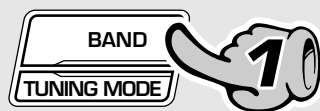
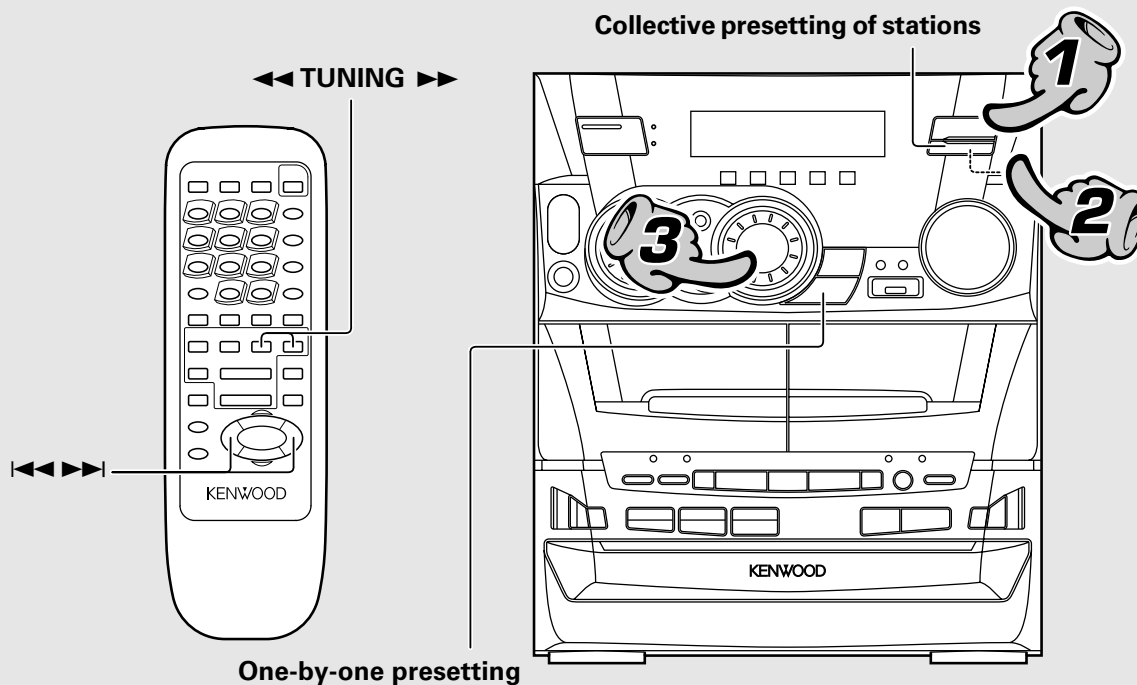

1. Select the broadcast band.

Each press changes the band.

- | | | | | |
|------|----|-----------|----|-----------|
| ① FM | or | ① FM | or | ① FM |
| ② AM | | ② MW (AM) | | ② MW (AM) |
| | | ③ LW | | ③ SW |

●The broadcast bands are variable depending on the model (country or area).

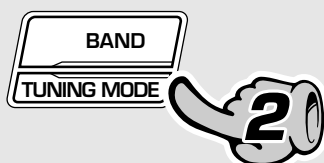

2. Selecting the tuning mode

Each press alternates the mode.

- “Auto” (Auto tuning)
- “P.call” (Preset call)
- “Manual” (Manual tuning)

●When no operation has been performed for 5 seconds while “P.call” is displayed, the tuning mode is set automatically to “AUTO”.



3. Select a station.

When no stations have been memorized

- Auto tuning** : Turn the **MULTI CONTROL** jog dial to receive the next tuned station automatically.
(On the remote control unit, press the ◀◀ or ▶▶ key.)
- Manual tuning** : Turn the **MULTI CONTROL** jog dial to select a station.
(On the remote control unit, press the ◀◀ or ▶▶ key.)

Collective presetting of stations (auto preset)

Keep the TUNING MODE key depressed (about 2 seconds).

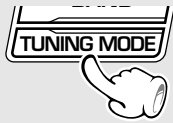

For U.K., Europe and Russia



Other countries

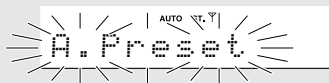

- Some stations may not be able to be preset if their reception conditions are weak.
- A maximum of 30 stations are preset automatically by giving the priority to the FM band.
- When there are many stations and the intended station has not been preset, please also use "One-by-one presetting (manual preset)".
- The stations which have been preset are overwritten.

Example when an FM station is received

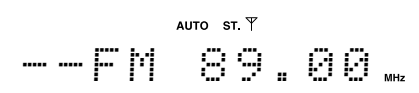

- Use the manual tuning mode when reception is noisy due to weak reception. (In the manual mode, stereo broadcasts are received in monaural.)
- Normally, use the "AUTO" (Auto tuning) mode.
- If you are operating the remote control unit, the "AUTO" (Auto tuning) and manual tuning mode can be alternated by pressing the stop (■) key.

When stations have been memorized (Preset call)

Turn the MULTI CONTROL jog dial to select a station. (On the remote control unit, press the ◀◀ or ▶▶ key.)

- When a key is held depressed, preset stations will be skipped at an interval of about 0.2 second.
- Preset stations can also be recalled using the numeric keys of the remote control unit.

One-by-one presetting (manual preset)

1 Press the ENTER key during reception.

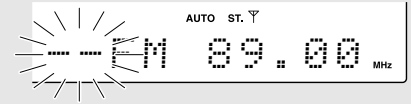
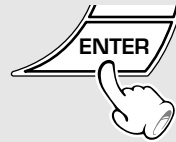

Presetting is cancelled when no operation is executed for 5 seconds or more.

2 Select one of the preset numbers from 1 to 30.

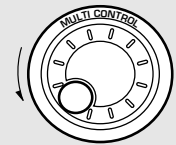

Presetting is cancelled when no operation is executed for 5 seconds or more.

3 Press the ENTER key again.



- Repeat steps 123 to preset other stations.
- If several stations are preset under the same number, the previous memory is replaced with the latest memory contents.

Lights during stereo reception

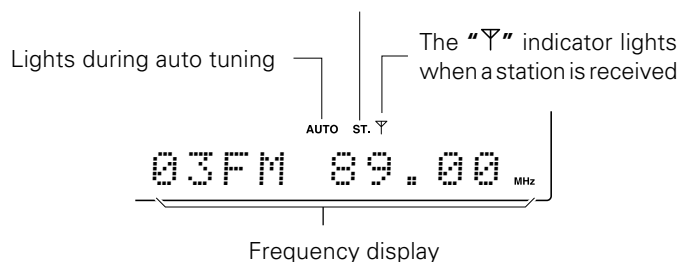

Recording on TAPE



Note that this cassette deck cannot record onto Metal tapes.

When equalizer or another effect is applied to the sound, the sound with the applied effect can be recorded.

→ 48

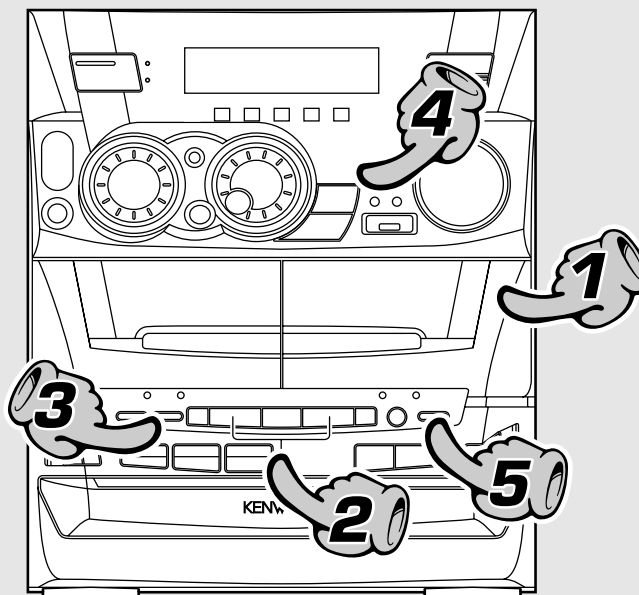
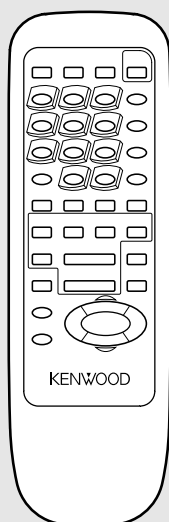

1. Load a cassette tape. (Recording is available on deck B only.)

- ❶ Open the door of deck B.
- ❷ Insert a tape.
- ❸ Close the door.

- Differentiation between normal (TYPE I) and high (TYPE II) tape is set automatically.
- Remove tape slack before loading.



2. Select the tape transport direction.

To reverse the transport direction

- ❶ Select deck B by pressing the A/B key.
- ❷ Press the play key corresponding to the desired direction.
- ❸ Stop playback (by pressing the □ key).

- When recording is started, the tape is transported in the direction selected in this step.
- Wind the tape to the position where recording is to be started.

Check the tape transport direction indicator. → 23

REV. MODE

DOLBY NR



3. Set the recording condition.

- ❶ Select the reverse mode.
- ❷ Select the DOLBY NR mode. (XD-5...series only)

→ 29

→ 29

- The Tape Equalizer cannot be used in recording. (XD-4...series only)

To pause recording (Main unit only)

Lights

XD-5....series **XD-4....series**

- Pressing the key pauses recording after leaving a non-recorded space of about 4 seconds.
- If the key is pressed again in less than 4 seconds after it has been pressed, recording resumes from that instant.

Selection of the reverse mode (Main unit only)

REV. MODE

Each press switches the modes as follows.

- ① "↔" Recording stops after having recorded both sides of tape.
- ② "↔" ... Recording stops after having recorded both sides of tape.
- ③ "←" Recording stops after having recorded one side of tape.

- When the "←" transport direction indicator is lit, recording always stops after having recorded one side of tape.

Selection of DOLBY NR (Noise Reduction) (Main unit only) (XD-5....series only)

The DOLBY NR system minimizes the hiss noise heard when playing tape. When playing a tape prerecorded with DOLBY NR ON, be sure to set the DOLBY NR ON for playback.

Lit when "DOLBY NR" is ON.



Each press switches the modes as follows.

- ① "□□ NR" ON DOLBY NR is used.
- ② "□□ NR" OFF ... DOLBY NR is not used.

- Select the DOLBY NR mode according to the recording condition of the tape.

Dolby noise reduction manufactured under license from Dolby Laboratories.
"DOLBY" and the double-D symbol are trademarks of Dolby Laboratories.

Select an input source other than "TAPE".

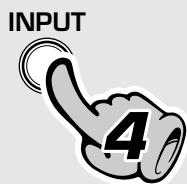

4. Select the source to be recorded.

- ① TUNER (Radio)
- ② CD
- ③ TAPE (This source cannot be recorded.)
- ④ MD/DVD (External input)
(Input level adjustment → 47)

CD01 1:12

The input source component to be recorded should be displayed.

- If a disc has already been loaded when the CD input is selected, it will start to play automatically. In this case, press the stop (□) key to stop it.

5. Start recording.

- ① Start recording.
- ② Play (or tune) the input source to be recorded.

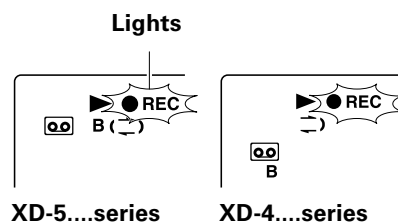
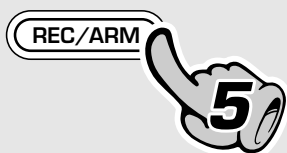

- Even if deck A is selected, it is automatically switched to deck B at the start of recording.
- Recording stops automatically when the tape side(s) to be recorded have been fully recorded.
- Press the stop (□) key of the cassette deck unit to stop recording.

Points in CD recording

When recording CD tracks onto a tape, if you leave the cassette deck in record-pause mode beforehand, the cassette deck recording can be started at the same time as the CD starts to be played. (Synchro recording function)

- ① Put the CD player in pause mode.
- ② Select the track to be recorded with the skip (|◀◀, ▶▶|) keys.
(The CD player pauses at the beginning of the selected track.)
- ③ Put the cassette deck in Record-pause mode.
(Press the REC/ARM key twice.)
- ④ Start playing the CD.
(Synchro recording starts.)

- Recording stops when the stop (□) key of the CD player is pressed.

Beat cancel function (For Russia)

There may be cases in which beat noise interferes with recording of LW broadcasting.

In such a case, press the A/B key during recording to reduce or suppress the beat noise.



Copying tape (Tape dubbing)

The contents of the tape in deck A can be copied onto the tape in deck B.

Load tapes in the decks.

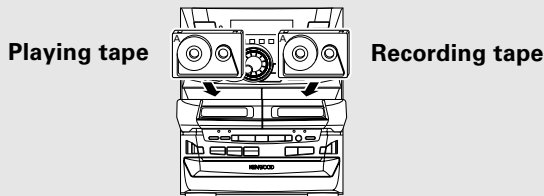

1 Select the "TAPE" input.



2 Press the stop key.



3 Select "⇄" (double-side recording) or "⇆" (one-side recording).



4 Select "Tape Dubbing".

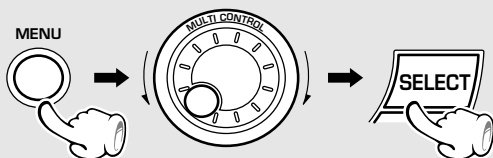

The following items can be selected by turning the MULTI CONTROL jog dial.

- "Recording Options"
- "Tape Dubbing"
- "Audio Options"
- "Clock Options"

← Scrolled display (Tape Dubbing)

Tape Dubbi

Lights



5 Use the same tape transport directions.

- When recording is started, the tape will be transported in the direction selected in this step.
(▶ : side A, ◀ : side B)

(1) Select the transport direction of deck A.

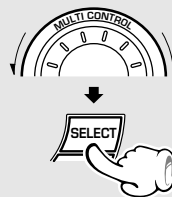

← Scrolled display (Deck A Play Direction)

Deck A Pla

A deck ▶

(2) Select the transport direction of deck B.



← Scrolled display (Deck B Record Direction)

Deck B Rec

B deck ▶

6 Start dubbing.

← Scrolled display (Press 'ENTER' to Start)

Press 'ENT



- Dubbing ends automatically when the side(s) to be dubbed has been completed.

To stop dubbing



- The deck B will stop after creating a non-recorded portion of about 4 sec, and then the deck A will stop.
- Dubbing can also be stopped by pressing the stop (□) key of the cassette deck unit. Note that the non-recorded space is not created in this case.

The DOLBY NR or TAPE EQ. key is ineffective during dubbing.
The tape recorded on deck B assumes the same Dolby NR condition as the tape played on deck A.

Listening in the desired sequence (program playback)

Any titles on the discs in the tray can be listened to in the desired sequence. (Max. 32 titles)

Select the "CD" input.

1 Check that the CD player is in the stop mode.

If it is in play mode



2 Select "CD Program Play".

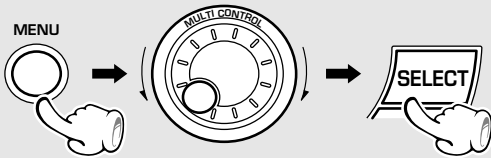

3 Enter track No.s in the order you want to play them.

① Select the disc.

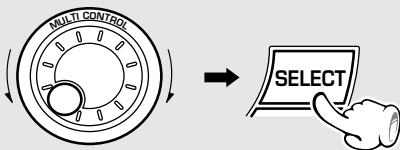

② Select the track.

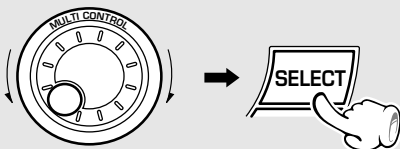

(To select other tracks, repeat steps ① and ② for each of the additional tracks.)

③ Press the ENTER key.



(Go to step ② if you do not need to check the program contents.)

- If the operation in step ② is performed during playback of a track, the current track can be programmed as the first track in the program.

The following items can be selected by turning the MULTI CONTROL jog dial.

"CD Program Play"
("Recording Options")
"Audio Options"
"Clock Options"

←Scrolled display (CD Program Play)

CD Program

Lights



←Scrolled display (Select Disc/Track No.)

Select Dis

Lights



P01 D1 T??

P01 D1 T01

- Even if you program a disc or track which does not exist in the tray, it is deleted automatically in playback.
- Press the **BACK** key to return to the previous step and restart operation from there.
- Up to 32 tracks can be programmed. When "Full" is displayed, no more tracks can be programmed.

←Scrolled display

(Press 'ENTER' to Start, 'JOG' to Check)

Press 'ENT

4 Check the programmed tracks (and replace, add or delete tracks as required).

To check:

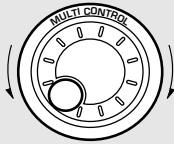

To replace a track in the program:

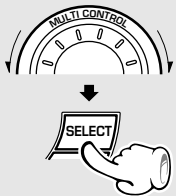

- 1 Select the programmed disc or track to be replaced and press the SELECT key.
- 2 Select a disc or track to replace the disc or track selected above (step 3-1 and 2).

To add a track to the program:

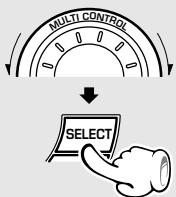

- 1 Select the display as shown on the right and press the SELECT key.
- 2 Perform the same operations as in step 3-1 and 2.

To delete a track from the program:



- 1 Select the programmed disc or track to be cleared and press the SELECT key.
- 2 Select "clear" and press the SELECT key.

5 Enter it.



(Playback starts from the first programmed track (program No. 1))

- Turn the **MULTI CONTROL** jog dial during program playback to stop to the previous or next programmed track.
- When the jog dial is rotated a little in the direction of counterclockwise once during playback, the track being played will be played from the beginning.
- To check (modify, add or delete) the programmed tracks after playback, perform the operations in steps 2 and 4.

Press the **TIME** key on the remote control unit to switch the time display.

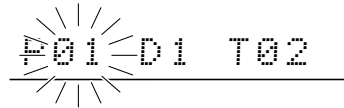

- The programmed tracks are displayed in sequence.

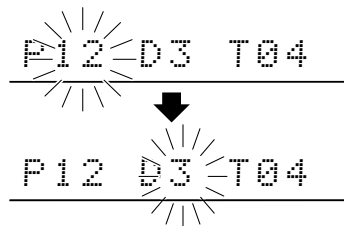

- The blinking item can be replaced.

Display when 12 tracks have been programmed



- The added track number is added to the end of the existing program.

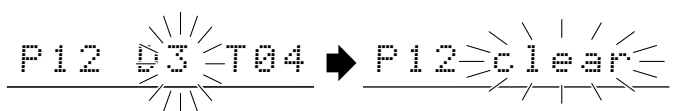

To quit the program mode

- 1 Select "CD Program Play".

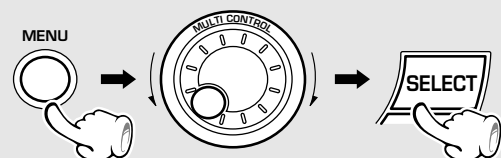

- 2 Press the MENU key.



- If the key is pressed during playback, normal playback in order of tracks resumes from the current track.
- The program mode can also be canceled by pressing the **OPEN** key.



Repeated playback

Desired titles or discs can be played back repeatedly.

Select the "CD" input.

To repeat only one track

1 Cancel "PGM".

If the "PGM" indicator is lit, make sure to turn it off.  Goes off 

2 Select the disc.



3 Select the track.

(Main unit)

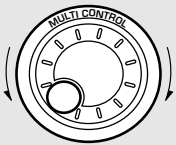

(Remote control unit)

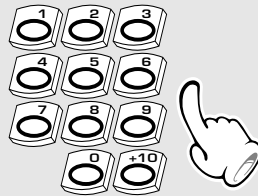

4 Select "One Track Repeat".

(Remote control unit only)

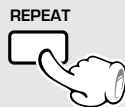

Press the key repeatedly to switch the display.

- ① "Repeat off" (Repeat canceled)
- ② **"One Track Repeat"**
- ③ "Disc Repeat"
- ④ "All Repeat"

← Scrolled display
(One Track Repeat)

One Track

Lights





XD-5....series



XD-4....series

To repeat a disc

1 Cancel "PGM".

If the "PGM" indicator is lit, make sure to turn it off.  Goes off 

2 Select the disc.



3 Select "Disc Repeat".

(Remote control unit only)

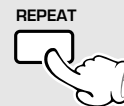

Press the key repeatedly to switch the display.

- ① "Repeat off" (Repeat canceled)
- ② "One Track Repeat"
- ③ **"Disc Repeat"**
- ④ "All Repeat"

← Scrolled display(Disc Repeat)

Disc Repea

Lights



XD-5....series



XD-4....series

To stop repeated playback

Press the REPEAT key repeatedly until the repeat mode is switched off.

- The repeat mode can also be canceled by pressing the **▲ OPEN** key.

To repeat all discs

1 Cancel "PGM".

If the "PGM" indicator is lit, make sure to turn it off.  Goes off

2 Select the disc to be played first.



3 Select "All Repeat".

(Remote control unit only)

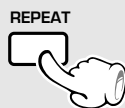

Press the key repeatedly to switch the display.

- ① "Repeat off" (Repeat canceled)
- ② "One Track Repeat"
- ③ "Disc Repeat"
- ④ "All Repeat"

← Scrolled display (All Repeat)

All Repeat

Lights



XD-5....series



XD-4....series

To repeat only the programmed tracks

1 Perform the procedure in "Listening in the desired sequence (program playback)" till step 3 to program the desired CD tracks.

Lights



- All of the programmed tracks will be played repeatedly.

2 Start playback.



3 Select "PGM Repeat".

(Remote control unit only)

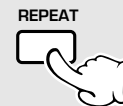

Press the key repeatedly to switch the display.

- ① "PGM Repeat"
- ② "Repeat off" (Repeat canceled)

← Scrolled display (PGM Repeat)

PGM Repeat

Lights



XD-5....series



XD-4....series

To stop repeated playback

Press the REPEAT key repeatedly until the repeat mode is switched off.

- The repeat mode can also be canceled by pressing the **▲ OPEN** key.

Random playback

As the titles each time are selected randomly, the music can be enjoyed without getting tired of it. Random playback can play tracks in one to three discs.

Select the "CD" input.

1 Cancel "PGM".

Goes off



If the "PGM" indicator is lit, make sure to turn it off. → 33

2 Select the RANDOM mode.

(For "One Disc Random" playback, select the disc in advance.)

(Remote control unit only)



Press the key repeatedly to switch the display.

- ① "One Disc Random"
Random play of one disc
- ② "All Disc Random"
Random play of all discs
- ③ "Random off" (Normal playback)

Random play of one disc

←Scrolled display (One Disc Random)

One Disc R → D RNDM T15

Random play of all discs

←Scrolled display (All Disc Random)

All Disc R → A RNDM T12

- Playback stops after each title has been played once.
- When the **TIME** key of the remote control unit is pressed during playback, the time display appears but it soon returns to the original display.

To select another track in the middle of playing one

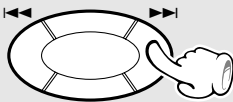

- Pressing the ◀◀ key once returns to the beginning of the track being played.

To repeat random playback

Select "Random Repeat".

(Remote control unit only)



Each press switches the modes as follows.

- ① "Random Repeat" Random repeat mode
- ② "Repeat off" Repeat canceled

To cancel random playback

Select "Random off".

(Remote control unit only)



- The displayed character information returned to normal display and normal playback in order of track numbers starts from the track being played.

RDS is a system which transmits useful information (digital data) for FM broadcasts together with the broadcast signal. Tuners and receivers designed for RDS reception can extract the information from the broadcast signal for use with various functions such as automatic display of the station name.





This unit is equipped with the following functions utilizing RDS data:

PTY (Program Type Identification) Search : →  38
The tuner automatically searches for a station which is currently broadcasting a specified program type (genre).

PS (Program Service Name) Display : (See below.)
When an RDS broadcast is received, the station name is automatically displayed.

EON (Enhanced Other Network) : →  40
When the information to be received is set in advance and any RDS station in the same network starts broadcasting of such information, the reception automatically will be switched to that station.

The "RDS" indicator lights up when an RDS broadcast (signal) is received.

RDS TP PTY EON TA





NEWS

- Some functions may not be provided or be given different names depending on countries or areas.

Note before the use of RDS

For reception of RDS stations, the auto presetting function must be used to preset the stations. With the auto presetting function, RDS stations are preset with priority.

Set the receiving band to FM and preset RDS stations with the auto preset function. →  27

To switch the display contents

Pressing the RDS DISP. key changes the display contents.



(Remote control unit only)



Display mode priority ranking

When an RDS broadcast is received :

- ① **PS (Program Service Name) Display** :
When an RDS broadcast is received, the station name is automatically displayed.
If no PS data was sent, "NO PS" is displayed.

AUTO ST. 

- ② **Frequency Display** :
The frequency of the current station is displayed.

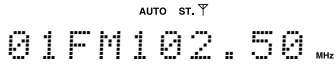
AUTO ST. 

Searching for a desired program type (PTY search)

By specifying the type of program (genre) you want to listen to, the tuner automatically searches for a station which is currently broadcasting a program of the specified type.

Set the reception band to FM. Preset RDS stations with the auto preset function. → 27

1 Select the PTY search mode.

(Remote control unit only)



2 Select the desired program type.

Use program type table on the right for your convenience.

Ⓐ To select using the ◀▶ keys

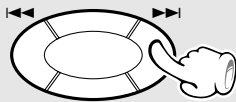

Select while "PTY" is lit.

The ◀▶ keys can be used to select one of the 29 program types by displaying them in sequence.

Press and hold the key and release it when the desired program type appears.

Ⓑ To select using the numeric keys

(Remote control unit only)

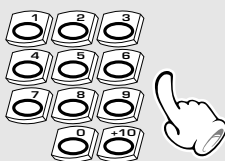

The numeric keys can be used to specify the desired program type directly by selecting a number between 01 and 28.

Example:

To select 23: Press [+10] [+10] [3].

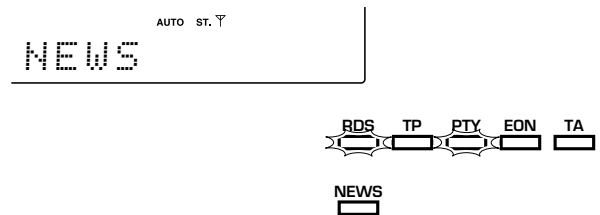

When an RDS broadcast is received, the program type is shown on the display. If no PTY data is available, or if the station is not an RDS station, "NONE" is displayed.

Program type table

Ⓐ ◀▶ keys	Ⓑ	Program Type Name	Display
DOWN ↑ UP ▶▶	01	Pop Music	POP M
	02	Rock Music	ROCK M
	03	Easy Listening Music	EASY M
	04	Light classical	LIGHT M
	05	Serious classical	CLASSICS
	06	Other Music	OTHER M
	07	News	NEWS
	08	Current Affairs	AFFAIRS
	09	Information	INFO
	00	Sport	SPORT
	10	Education	EDUCATE
	11	Drama	DRAMA
	12	Culture	CULTURE
	13	Science	SCIENCE
	14	Varied	VARIED
	15	Weather	WEATHER
	16	Finance	FINANCE
	17	Children's program	CHILDREN
	18	Social Affairs	SOCIAL
	19	Religion	RELIGION
	20	Phone In	PHONE IN
	21	Travel	TRAVEL
	22	Leisure	LEISURE
	23	Jazz Music	JAZZ
	24	Country Music	COUNTRY
	25	National Music	NATION M
	26	Oldies Music	OLDIES
	27	Folk Music	FOLK M
28	Documentary	DOCUMENT	

3 Start the search.

(Remote control unit only)



(Press the key again during search to cancel it.)

- No sound is heard while "PTY" is blinking.
- If a program of the desired type cannot be found, "NO PROG" is displayed, then after several seconds the display returns to the original display.
- If a program of the desired type is found, that program is received and the program type name display changes temporarily to the frequency display, and then to the station name display.

When searching for a Rock Music broadcast

Display while the tuner is searching.

Program type name display.

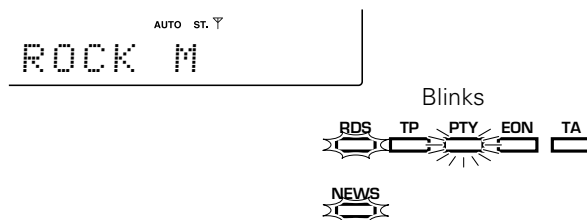

When a station is received.

Station name display.

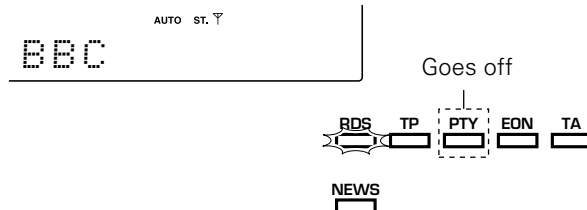

To change to a different program type :

Repeat steps 1, 2, 3.

To be able to listen to the desired information at any time (EON)

By using the EON function, which manages the information of other stations, listening to desired information like traffic information or news etc. can be reserved even when it is not being transmitted at the present. When listening to a station with the "EON" display lit and another station of the same network starts to broadcast an information program for which a reservation has been made, then that station will be selected automatically. When the desired information program ends, return is made to the original program.

Set the reception band to FM. → 26

1 Auto preset the stations.

- ① Receive a broadcast.
- ② Keep the TUNING MODE key pressed (2 sec or longer).

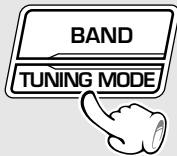

(The EON data presently being broadcast are taken in automatically.)

2 Select the desired information.

(Remote control unit only)



3 Receive an RDS station.

Select a station where "RDS" and "EON" are lit.

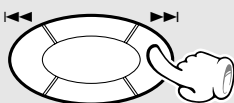

This is not required when auto presetting has already been executed. → 27

- When all 30 stations have already been preset by the procedure for "One-by-one presetting (manual preset)", the EON function will not operate. Auto presetting must be used.

Each press switches the modes as follows.

- ① TA Traffic Announcement
- ② NEWS News
- ③ TA/NEWS Traffic Announcement/ News
- ④ Display not lit EON cancelled

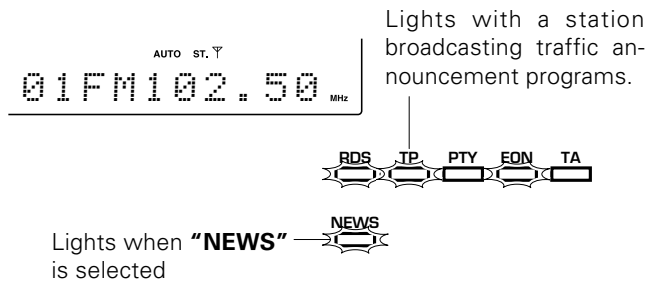

- Please execute automatic presetting when TA and NEWS can not be selected.

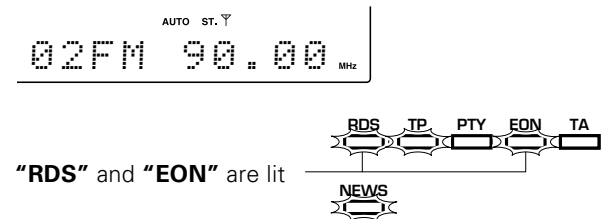

- When "EON" does not light although an RDS station is received, that station is not transmitting EON data. Please select a different station.
- If you want TA programs, select the stations with which the "TP" indicator lights.

4 *Wait for the desired information.*

**CD or tape playback may also be started.
As long as the unit is ON, the unit is always
ready for the reception.**

- When one of the stations of the network of the station received in **3** starts broadcasting the program contents selected in **2**, that station will be received automatically. At this time, tape playback will stop and CD playback will pause. However, external equipment (MD/DVD) will remain as it is.
- The EON function does not operate during recording (including dubbing).
- When the transmission of the selected program contents ends in case of automatic reception with the EON function, return will be made to the status directly before operation of the EON function. When tape or CD playback has been interrupted, it will be continued from the point of interruption.

Waiting for information while a RDS station without EON function is tuned

If the EON indicator does not light with the RDS station in steps **3** and **4**, the tuner will wait for only the desired information broadcast from the tuned RDS station provided that the desired information has been selected in the previous step.

TP (Traffic Program) indicator

The lighting of the TP indicator indicates that the currently tuned station or a station in the same network as it broadcasts traffic announcement programs. If the TP indicator already lights with the current station, you can listen to the traffic announcement program through the station without making reservation with the EON function.

Selection of the Recording Type

With this unit, the following edit recording is possible according to the purpose.



Note that this cassette deck cannot record onto Metal tapes.

If you want to select the track to be recorded while playing a CD

Recording only desired titles

→ 43

CD ONE TRACK RECORDING



Perform this operation when a track you want to record starts during CD playback. This starts recording of the track from the beginning.

If you want to record a CD in order of track numbers

Recording of an entire CD

→ 44

CD DIRECT RECORDING



Perform the "CD DIRECT RECORDING" operation while the CD player is in stop mode to start recording.

If you want to record only the desired tracks

Recording the programmed titles

→ 45

CD PROGRAM RECORDING



Program the desired tracks from up to 3 CD discs in the desired order and record the programmed playback onto tape.



With recording onto tape, the track will be interrupted for the part of the guide tape at the tape reversal, where recording is not possible. Please use single-side recording if this is to be avoided.

In regard to CD-TEXT (Remote control unit only)

When a CD-TEXT disc is played on this unit, it displays the text information (disc or track title) recorded in the CD.

To switch the displayed text information between the disc title and track title during playback, press the TEXT DISP. key.

(When pressed during playback)

TEXT DISP.



Scrolls the disc title display.

World Musi

CD player's time display.

CD01 1:12

Scrolls the track title display.

New York : B

Recording only desired titles (CD ONE TRACK RECORDING)

At the time of CD playback, any desired title can be selected immediately for recording.



When equalizer or another effect is applied to the sound, the sound with the applied effect can be recorded. → 48

Recording preparations are required. → 28 (Steps 1 to 3)

1 Playback of CD.



2 Select "Recording Options".

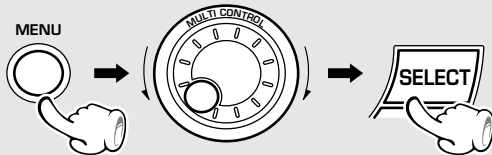

3 Select "CD One Track Recording".

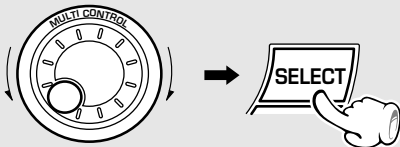

4 Start recording.



When recording has been completed, a non-recorded portion of 4 seconds will be produced and the cassette deck part will stop. The CD player will enter temporary stop condition.

To record a different track, repeat the steps 1 to 4.

- Select a mode other than random play.

The following items can be selected by turning the MULTI CONTROL jog dial.

- "CD Program Play"
- "Recording Options"
- "Audio Options"
- "Clock Options"

← Scrolled display (Recording Options)

Recording

Lights



The following items can be selected by turning the MULTI CONTROL jog dial.

- "CD One Track Recording"
- (Only during CD playback)
- "CD Direct Recording"
- "CD Program Recording"
- "Timer Recording"

← Scrolled display (CD One Track Recording)

CD One Tra

← Scrolled display (Press 'ENTER' to Start)

Press 'ENT

- Playback restarts from the beginning of the track being played and recording starts at the same time.

To end recording in the middle



- Both the cassette deck and CD player stop.

Recording of an entire CD (CD DIRECT RECORDING)

Perform the following operation while the CD player is in stop mode to start recording at the same time as the start of playback.



When equalizer or another effect is applied to the sound, the sound with the applied effect can be recorded. → 48

Recording preparations are required. → 28 (Steps 1 to 4)

1 Check that the CD player is in the stop mode.

If it is in play mode



2 Select "Recording Options".

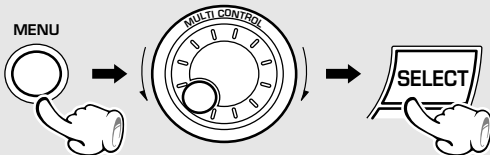

3 Select "CD Direct Recording".

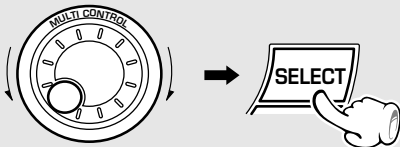

4 Select the disc.

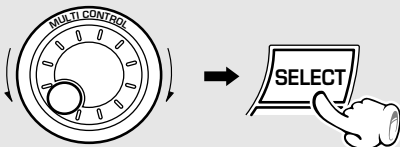

5 Start recording.



- Recording of CD starts at the same time as playback.
- At the end of tape, the music is not recorded on the leader tape portion. If you do not want any music to be interrupted in the middle, refer to "Recording on TAPE" and start recording of side B with the interrupted track. → 28

The following items can be selected by turning the MULTI CONTROL jog dial.

"CD Program Play"

"Recording Options"

"Audio Options"

"Clock Options"

← Scrolled display (Recording Options)

Lights

Recording



The following items can be selected by turning the MULTI CONTROL jog dial.

"CD Direct Recording"

"CD Program Recording"

"Timer Recording"

← Scrolled display (CD Direct Recording)

CD Direct

← Scrolled display (Select Disc No.)

Select Dis → Disc No. 1

← Scrolled display (Press 'ENTER' to Start)

Press 'ENT

To end recording in the middle



- Both the cassette deck and CD player stop.

Recording the programmed titles (CD PROGRAM RECORDING)

Program the desired tracks from up to 3 CD discs in the desired order and record the programmed playback onto tape.



When equalizer or another effect is applied to the sound, the sound with the applied effect can be recorded. → 48

Recording preparations are required. → 28 (Steps 1 to 4)

1 Check that the CD player is in the stop mode.

If it is in play mode



2 Select "Recording Options".

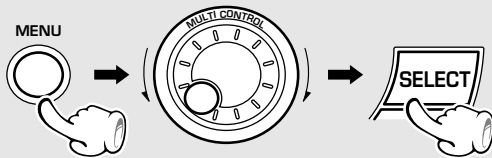

3 Select "CD Program Recording".

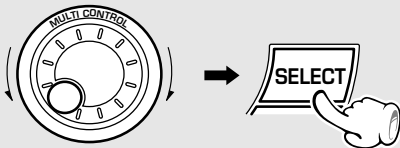

4 Program the desired tracks.

- 1 Select tracks in the order you want to play them. (Perform step 2 on page 32.)
- 2 Check, replace, add or delete the programmed tracks as required. (Perform step 4 on page 33.)

5 Start recording.



The following items can be selected by turning the MULTI CONTROL jog dial.

- ← "CD Program Play"
- ← "Recording Options"
- ← "Audio Options"
- ← "Clock Options"

← Scrolled display (Recording Options)

Recording

Lights



The following items can be selected by turning the MULTI CONTROL jog dial.

- ← "CD Direct Recording"
- ← "CD Program Recording"
- ← "Timer Recording"

← Scrolled display (CD Program Recording)

CD Program

Lights



← Scrolled display

(Press 'ENTER' to Start, 'JOG' to Check)

Press 'ENT

- The program mode is maintained even after completion of recording. To return to the normal mode, it is required to cancel the program mode. → 33

To end recording in the middle

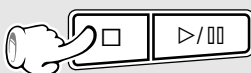

- Both the cassette deck and CD player stop.

This unit permits selection of the levels of the equalizer and sound field reproduction effects. Please select the equalizer as desired according to the music genre. Select the sound field mode according to the desired atmosphere.

Balance adjustment

Adjusts the balance of left and right volume.

1 Select "Audio Options".

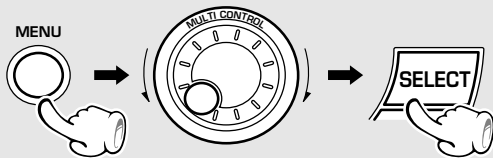

The following items can be selected by turning the MULTI CONTROL jog dial.

- ← ("CD Program Play")
- ← ("Recording Options")
- ← ("Tape Dubbing")
- ← **"Audio Options"**
- ← "Clock Options"

← Scrolled display (Audio Options)

Audio Opti

Lights



2 Select "Balance".

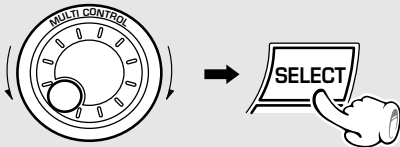

The following items can be selected by turning the MULTI CONTROL jog dial.

- ← "Custom EQ 1"
- ← "Custom EQ 2"
- ← "Custom EQ 3"
- ← **"Balance"**
- ← "MD/DVD Input Level"

(Only when the MD/DVD input is selected)

← Scrolled display (Balance)

Balance

← Scrolled display (Adjust L/R balance)

Adjust L/R

Indicates the center

L --- * --- R

Indicates the balance setting

3 Adjust.

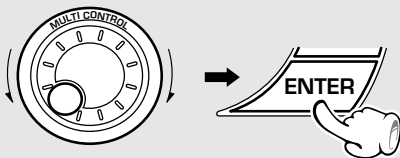

The right volume is decreased.

The left volume is decreased.

Input level adjustment

The input level from an external component connected to the MD/DVD INPUT jacks, such as a MD recorder, DVD player, VCR or analog turntable can be adjusted as desired. Adjust so that the volume of the MD/DVD input source sounds at an equivalent level to the CD .

1 Select the "MD/DVD" input.



2 Select "Audio Options".

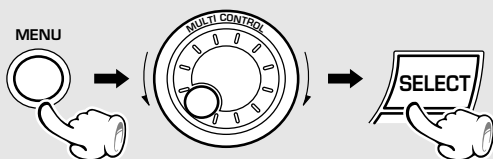

3 Select "MD/DVD Input Level".

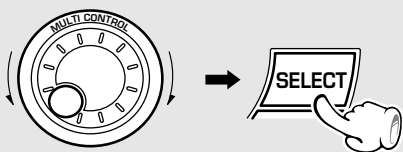

4 Adjust

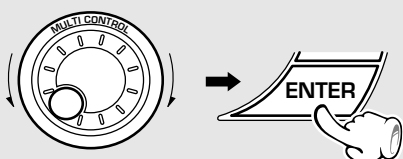

The level is decreased.

The level is increased.

The following items can be selected by turning the MULTI CONTROL jog dial.

- ← ("Recording Options")
 - ← "Audio Options"
 - ← "Clock Options"

← Scrolled display (Audio Options)



The following items can be selected by turning the MULTI CONTROL jog dial.

- ← "Custom EQ 1"
- ← "Custom EQ 2"
- ← "Custom EQ 3"
- ← "Balance"
- ← "MD/DVD Input Level"

← Scrolled display (MD/DVD Input Level)

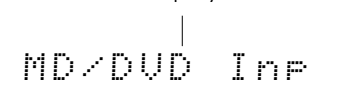

← Scrolled display (Adjust Level)

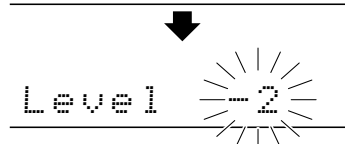
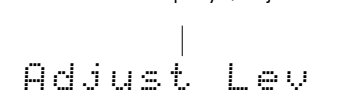

● Adjustment is possible in the range from 0 to - 7.

Listening to music with desired tone and sound field/ Switching the display (Equalizer effect and 3D surround effect)

This unit permits selection of six preset equalizer patterns and three user's equalizer patterns as well as the 3D surround levels. The "S.direct" (Source Direct) mode allows you to reproduce pure sound by bypassing the EX.BASS, equalizer and 3D surround circuitry.

Selecting the equalizer pattern and 3D surround level

Select the desired pattern and 3D surround level according to the category of the played music. The equalizer and 3D surround effects can be recorded together with the music.

1 Play desired music.

2 Select the desired equalizer pattern.

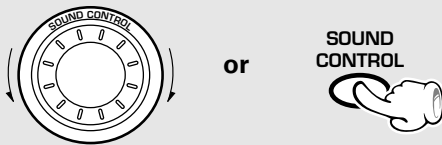

- The equalizer pattern and 3D surround level cannot be switched on/off or controlled in the middle of recording.

Lights when "S.direct" is selected.

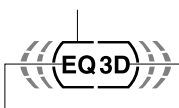

Lights when 3D surround is selected.

Lights when equalizer is selected.

Equalizer patterns and 3D surround levels that can be recalled

"Rock"	Rock music
"Disco"	Disco music
"Pop"	Pop music
"Movie"	Movie music
"Jazz"	Jazz music
"Classic"	Classic music
"Custom EQ 1"	Equalizer's manual memory created by the user
"Custom EQ 2"	
"Custom EQ 3"	
"3D Level 1"	3D surround level 1
"3D Level 2"	3D surround level 2
"S. direct"	Pure sound can be reproduced by bypassing the EX.BASS, equalizer and 3D surround cir- cuitry
"Effect off"	Normal playback

- To cancel the equalizer, 3D surround and "S.direct", select "Effect off".

Switching the sound level meter display mode

Each press switches the modes as follows.

DISPLAY
/DEMO



- "Display Auto"
- "Display 1"
- "Display 2"
- "Display 3"

- When "Display Auto" is selected, the display mode during CD playback changes to "Display 1", "Display 2" and "Display 3" every time the track changes.
- "Display 3" is displayed regardless of the current music signal.

3D surround

This is a system producing a three-dimensional sound space. The feeling of depth, the width of the sound field, etc. are improved clearly, and the listening area also is widened.

Creation and memorizing of an equalizer pattern

You can edit desired patterns manually and store them in memory.

1 Select "Audio Options".

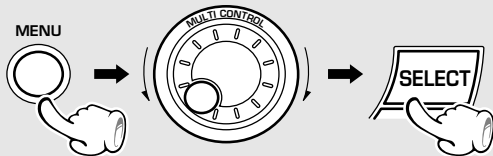

The following items can be selected by turning the MULTI CONTROL jog dial.

- ("CD Program Play")
- ("Recording Options")
- ("Tape Dubbing")
- **"Audio Options"**
- "Clock Options"

← Scrolled display (Audio Options)



Lights



2 Select the number to be used for storage. (Custom EQ1 ~ EQ3)

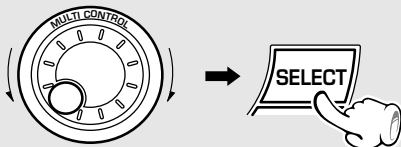

The following items can be selected by turning the MULTI CONTROL jog dial.

- "Custom EQ 1"
- "Custom EQ 2"
- "Custom EQ 3"
- "Balance"
- "MD/DVD Input Level"

(Only when the MD/DVD input is selected)

3 Adjust the equalizer pattern.

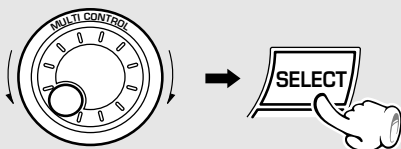

← Scrolled display (Adjust Bass)

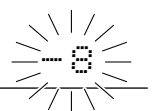

To decrease the level To increase the level

- Each frequency band can be adjusted in the range between **- 8** and **+ 8**.
- The "Bass", "Mids" and "Highs" frequency bands can be adjusted independently by repeating step 3 for each of them.

4 Establish the 3D surround level.

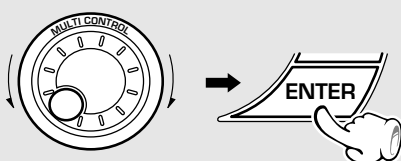

The following items can be selected by turning the MULTI CONTROL jog dial.

- "3D Lev. off" 3D surround off
- "3D Lev. 1" 3D surround level 1
- "3D Lev. 2" 3D surround level 2



This unit incorporates a clock function. Be sure to adjust the correct time before using the timer function. The time is displayed only while the power is off.

1 Select "Clock Options".

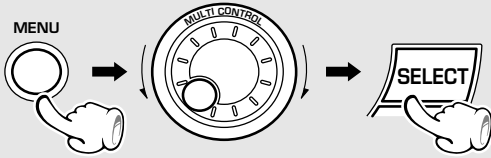

2 Select "Adjust Time".

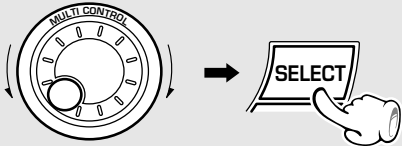

3 Enter the figure of hour.

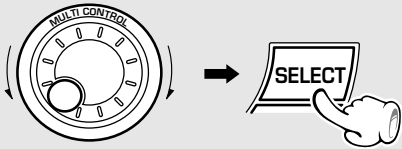

To decrease
the figure

To increase
the figure

4 Enter the figure of minute.

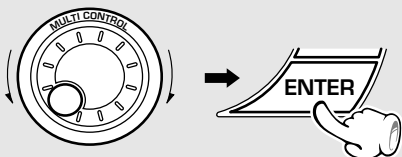

To decrease
the figure

To increase
the figure

The following items can be selected by turning the MULTI CONTROL jog dial.

- ("CD Program Play")
- ("Recording Options")
- ("Tape Dubbing")
- "Audio Options"
- "Clock Options"

← Scrolled display (Clock Options)

Clock Opti

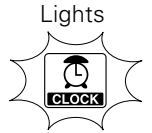

The following items can be selected by turning the MULTI CONTROL jog dial.

- "Sleep Time"
- "Adjust Time"
- "O.T.T."
- "Timer Play"
- "Auto Power Save"

Example: Adjustment to 8:45

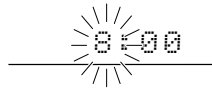

For U.K., Europe and Russia
0 ↔ 1 ↔ 2 ... 13 ↔ 14 ... ↔ 0 ...

Other countries
AM12 ↔ AM1 ↔ AM2 ...
PM1 ↔ PM2 ... ↔ AM12 ...

- The time display starts to blink.
- Press the **SELECT** key. The hour is entered and the minute display starts to blink.

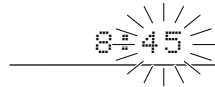

For U.K., Europe and Russia Other countries

00 ↔ 01 ↔ 02 ... 59 ↔ 00 ↔ 01 ...

- Press the **BACK** key to return to the previous step and restart operation from there.
- To adjust correct time, press the **ENTER** key at the same moment as a time announcement.

To display the time

(In standby mode)



(Displayed for approx. 5 sec.)

- When the key is pressed while the "**TIMER**" indicator is lit, the timer setup mode is displayed after the clock display.
- The clock display blinks after the power cord has been unplugged from the AC power outlet and plugged in again or after a power failure. In this case, set the time of the day again.

Sleep timer (SLEEP)

The power is turned OFF automatically after the specified period has elapsed.

Operate easy To use Timer (O.T.T.)

Playback of the selected input source starts at the specified time, and the power is switched off after one hour. This timer operates only once directly after setting.

Timer programming

Timer playback : Plays (or receives) the selected source in the set time range.

AI timer playback (When timer playback starts, the volume increases gradually.)

Timer recording : Records the selected source in the set time range.

Auto Power Save

When the power is ON and neither recording nor playback is executed for 30 minutes or more, the power is switched off automatically by this function.

Adjust the clock before setting the timer.



Sleep timer (SLEEP)

Set the number of minutes after which the power is to be turned OFF.

1 Select "Clock Options".

2 Select "Sleep Timer".

3 Set the time

The following items can be selected by turning the MULTI CONTROL jog dial.

- ["CD Program Play"]
- ["Recording Options"]
- ["Tape Dubbing"]
- ["Audio Options"]
- ["Clock Options"]**

← Scrolled display (Clock Options)

Lights

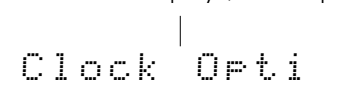

The following items can be selected by turning the MULTI CONTROL jog dial.

- ["Sleep Time"]**
- ["Adjust Time"]
- ["O.T.T."]
- ["Timer Play"]
- ["Auto Power Save"]

Lights



Blinks

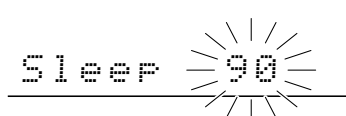

10 ↔ 20 ↔ 30...80 ↔ 90 ↔ "Sleep off" ↔ 10 ↔ 20...

- The displayed time changes in 10-minute steps. The maximum time that can be set is 90 minutes.
- The power is turned OFF automatically after the set time has elapsed.
- To cancel the sleep timer, turn the power off or select "Sleep off".
- The sleep timer does not operate until O.T.T. operation or program timer operation has ended.

Operate easy To use Timer (O.T.T.)

Timer playback can be set with a simple operation of just setting the time. With this function, the last source selected before turning power off can be played by the timer. The power turned ON by the timer is switched off automatically in an hour after the timer playback starts.

Adjust the clock before setting the timer.



1 Select the desired source and adjust the volume.

2 Select "Clock Options".

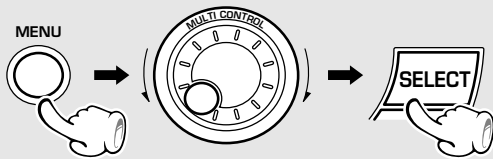

3 Select "O.T.T.".

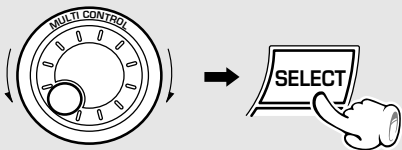

4 Select "O.T.T. on".

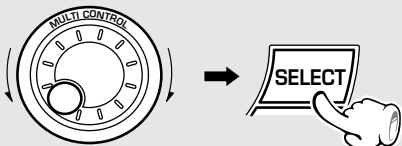

5 Enter the ON time

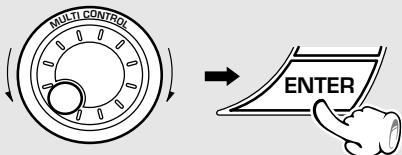

The time is returned

The time is advanced.

6 Put the unit in standby mode.

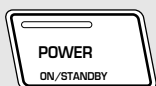

or

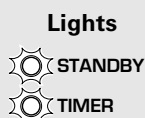
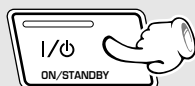

The following items can be selected by turning the MULTI CONTROL jog dial.

("CD Program Play")
 ("Recording Options")
 ("Tape Dubbing")
 "Audio Options"
"Clock Options"

← Scrolled display (Clock Options)

Clock Opti

Lights



The following items can be selected by turning the MULTI CONTROL jog dial.

"Sleep Time"
 "Adjust Time"
"O.T.T."
 "Timer Play"
 "Auto Power Save"

Lights



The following items can be selected by turning the MULTI CONTROL jog dial.

"O.T.T. off" (Canceled)
 "O.T.T. on"

● To cancel the O.T.T. timer, select "O.T.T. off".

← Scrolled display (Set on time)

Set on tim

7:20

7:20 on

For U.K., Europe and Russia

Other countries

● The ON time can be set in steps of 5 minutes.

● If the "TIMER" indicator is blinking now, set the time of the day again.



The program timer does not operate until "O.T.T." operation has ended.

Timer programming

The program timer can set timer playback and timer recording and both of these functions can be reserved concurrently. Either "Everyday" (executing a timer program once every day) or "One Time" (executing it only once) can be selected for each timer program. Once the time range and content of a timer program has been set, it can be activated or deactivated as desired.

● If you made a mistake during timer setting:

Press the **BACK** key to return to the previous step and restart operation from there.

Adjust the clock before setting the timer.



1 Make preparations for the play (recording).

To listen to radio

The station should be preset prior to the above. → 27

To listen to CD

Insert a disc. (Program playback is not possible.)
Select the disc to be played (1, 2 or 3). → 20 → 21

To listen to tape

Set a tape in the deck you want to play back the tape. → 22

Playing or recording the auxiliary input source

Make timer setting of the component connected to the MD/DVD INPUT jacks.

For recording

Make preparations for recording. → 28

2 Adjust the listening volume.

3 Select the timer operation.

For timer playback or AI timer playback

1 Select "Clock Options".



2 Select "Timer Play".



- When the timer function is used for timer recording of an input source, the speakers do not output the audio even after the unit is turned on by the timer.

For timer recording

1 Select "Recording Options".

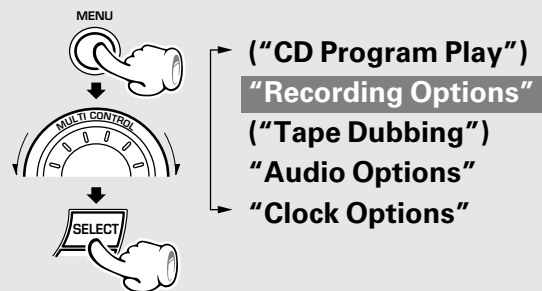

2 Select "Timer Recording".



Continued on next page...

4 Select "Everyday" or "One Time".

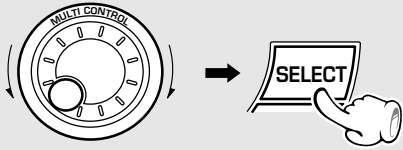

The reservation contents cannot be cleared. The contents are cleared only when they are changed.

5 Enter the ON time.

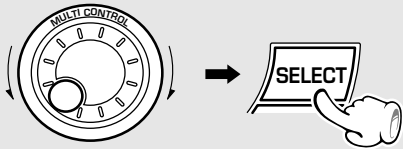

The time is returned.

The time is advanced.

6 Enter the OFF time.

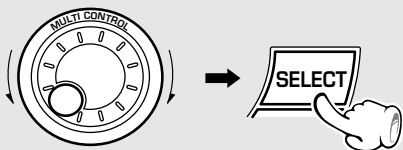

The time is returned.

The time is advanced.

The following items can be selected by turning the MULTI CONTROL jog dial.

- ← "Timer off" (Canceled)
- "Everyday"
- "One Time"

- To cancel a timer operation, select "Timer off" under "Timer Play" (in case of timer playback) or "Timer Recording" (in case of timer recording).

← Scrolled display (Select on time)

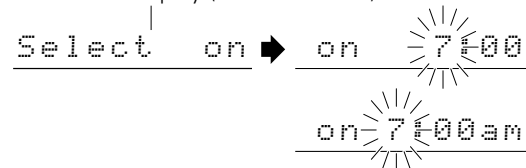

- After entering the "hour", enter the "minute" with the same procedure.

← Scrolled display (Select off time)

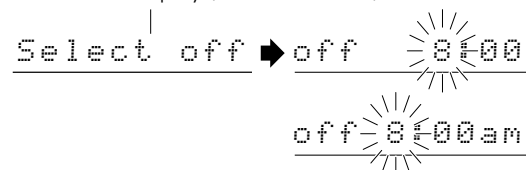

- After entering the "hour", enter the "minute" with the same procedure.
- Reserve the timer recording program and timer playback program by leaving an interval of 1 minute or more so that their time ranges do not overlap.

AUTO POWER SAVE

When the power is ON and neither recording nor playback is executed for 30 minutes or more, the power is switched off automatically by this function.

1 Select "Clock Options".

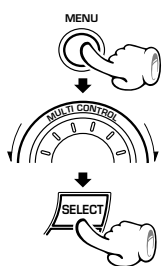

- ("CD Program Play")
- ("Recording Options")
- ("Tape Dubbing")
- "Audio Options"
- "Clock Options"**

- The auto power save operation does not occur unless the O.T.T. or program timer operation has completed.
- When the TUNER or MD/DVD input is selected, this function operates only when the volume is set to zero.

2 Select "Auto Power Save".

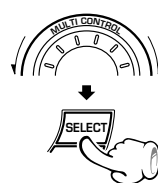

- "Sleep Timer"
- "Adjust Time"
- "O.T.T."
- "Timer Play"
- "Auto Power Save"**

3 Select "A.P.S. on" or "A.P.S. off".



- ← "A.P.S. off"
- Auto power save is not used.
- "A.P.S. on"
- Auto power save is used.

7 Make the desired reservation.

For timer playback or AI timer playback

1 Select the mode.

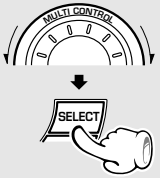

Select "Play" or "AI Play".

- ① "Play" Timer play
- ② "AI Play" .. Timer play with gradually increasing volume

2 Select the input source.

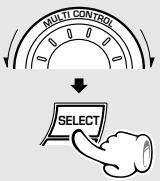

Select the source to be played.

- ① TUNER Radio
- ② CD
- ③ TAPE
- ④ MD/DVD External input

3 Select the broadcast station (only when TUNER is selected above).

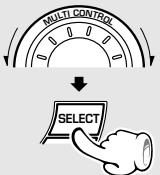

Select the preset station No.



For timer recording

1 Select the input source.



Select the recorded input source.

- ① TUNER Radio
- ② MD/DVD ... External input

2 Select the broadcast station (only when TUNER is selected above).



Select the preset station No.



8 Press the ENTER key.



← Scrolled display (Press 'ENTER' to Save)



- The set program content items are displayed one after another.
("Everyday" or "One Time" → On time → Off time → Mode → Input source → Preset channel)

Lights



- If the "TIMER" indicator is blinking now, set the time of the day again.

9 Put the unit in standby mode.



Maintenance

Cleaning the head section

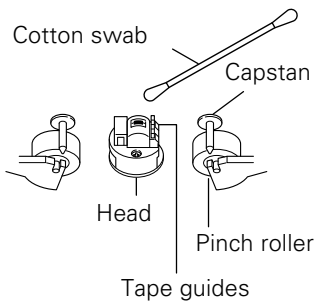

Cleaning the heads and peripheral components

For maintaining the best condition of the deck and for longer service life, always keep the heads (recording / playback / erase), capstan and pinch roller clean.

To clean them, perform the following:

1. Open the cassette holder.
2. Using a cotton swab dipped in alcohol, clean the head (recording / playback / erase), capstan and pinch roller carefully.

Demagnetizing the head

When the recording / playback head is magnetized, the sound quality will deteriorate. In such a case, demagnetize the head using a commercially available demagnetizer (head eraser).



There are precisely aligned parts around the heads, including the tape guides. When cleaning, pay special attention so as not to apply shock to them.

Maintenance of the unit

When the front panel or case becomes dirty, wipe with a soft, dry cloth. Do not use thinner, benzene, alcohol, etc. for these agents may cause discoloration.

In regard to contact cleaner

Do not use contact cleaners because it could cause a malfunction. Be specially careful not to use contact cleaners containing oil, for they may deform the plastic component.

Reference

Caution on condensation

Condensation (of dew) may occur inside the unit when there is a great difference in temperature between this unit and the outside.

This unit may not function properly if condensation occurs. In this case, leave the unit for a few hours with the power left ON, and restart the operation after the condensation has dried up.

Be specially cautious against condensation in a following circumstance:

When this unit is carried from a place to another across a large difference in temperature, when the humidity in the room where this unit is installed increases, etc.

Note related to transportation and movement

Before transporting or moving this unit, carry out the following operations.

- 1 Turn the power ON but do not load a disc.
- 2 Press the ►/II key.
- 3 Wait a few seconds, and ensure that the display is as shown below.

CD No Disc

- 4 Wait for a few seconds then turn power off.

Memory backup function

Stored contents which are cleared immediately when power plug is unplugged from power outlet	Clock display
Stored contents which are cleared in at least a day after power plug is unplugged from power outlet	Amplifier POWER status (ON or OFF) Input selection Volume control value Balance level Equalizer's manual memory created by the user 3D surround level Tuner unit Receiving band Frequency Preset stations Program timer setting contents Cassette deck unit Transport direction DOLBY NR Tape Equalizer Reverse mode

WARNING NOTICE:

IN MOST CASES IT IS AN INFRINGEMENT OF COPYRIGHT TO MAKE COPIES OF TAPES OR DISCS WITHOUT THE PERMISSION OF THE COPYRIGHT OWNERS. ANYONE WISHING TO COPY COMMERCIALY AVAILABLE TAPES OR DISC SHOULD CONTACT THE MECHANICAL COPYRIGHT PROTECTION SOCIETY LIMITED OR THE PERFORMING RIGHTS SOCIETY LIMITED.

What seems to be a malfunction is not always so. Before calling for service, check the following table according to the symptom of your trouble.

Operation to reset

The microcomputer may fall into malfunction (impossibility to operate, erroneous display, etc.) when the power cord is unplugged while power is ON or due to an external factor. In this case, execute the following procedure to reset the microcomputer and return it to normal condition.

Unplug the power cord from the power outlet then, while holding the ENTER key depressed, plug the power cord again.





(Main unit only)











- Please note that resetting the microcomputer clears the contents stored in and returns and to condition when it left the factory.

Receiver, speakers

Symptom	Cause	Remedy
Sound is not produced.	<ul style="list-style-type: none"> ● The speaker cords are disconnected. ● The MUTE switch of remote control unit is switched ON. ● The headphone plug is inserted into the jack. 	<ul style="list-style-type: none"> ● Connect properly referring to "System connection". → 9 ● Switch MUTE OFF. → 19 ● Unplug the headphone plug. → 18
"STANDBY" and "TIMER" indicators blink alternately and no sound is output.	<ul style="list-style-type: none"> ● The speaker cords are short-circuited. 	<ul style="list-style-type: none"> ● Turn the power OFF, remove the short-circuit and turn the power ON again.
Sound is not produced from the left or right speakers.	<ul style="list-style-type: none"> ● The speaker cords are disconnected. ● The left and right volumes are not balanced. 	<ul style="list-style-type: none"> ● Connect properly referring to "System connection". → 9 ● Adjust the left and right volume balance. → 46
The clock display blinks.	<ul style="list-style-type: none"> ● There was a power failure. ● The power cord was unplugged from the outlet. 	<ul style="list-style-type: none"> ● Adjust the present time again. → 50 ● Adjust the present time again. → 50
Timer operation is not possible.	<ul style="list-style-type: none"> ● The present time has not been adjusted or there was a power failure. ● The timer program or the timer ON/OFF time has not been set properly. 	<ul style="list-style-type: none"> ● Adjust the present time referring to "Clock adjustment". → 50 ● Check the timer program and set its ON/OFF time properly. Note that "Everyday" and "One Time" cannot be set simultaneously for a single timer program. → 53
Radio stations cannot be received.	<ul style="list-style-type: none"> ● The antennas have not been connected. ● A proper broadcasting band has not been selected. ● The frequency of the station to be received is not tuned. 	<ul style="list-style-type: none"> ● Connect antennas. → 8 ● Select a band. → 26 ● Tune to the frequency of the desired station. → 26
Noise interferes.	<ul style="list-style-type: none"> ● Car ignition noise. ● Influence of an electric appliance. ● A TV set is installed near the system. 	<ul style="list-style-type: none"> ● Install the outdoor antenna in an apart position from the road. ● Switch the suspected electric appliance OFF. ● Install the TV or the system at an increased distance between them. → 9

No station can be received by preset call operation.	<ul style="list-style-type: none"> ● The frequency of the preset station is not tunable. ● The preset memory has been cleared because the power cord has been unplugged for a long period. 	<ul style="list-style-type: none"> ● Preset stations with tunable frequencies. →  27 ● Preset stations again. →  27
Demonstration starts suddenly.	<ul style="list-style-type: none"> ● The power plug was unplugged from the outlet while the power switch was ON, or there was a power failure. 	<ul style="list-style-type: none"> ● This is not malfunction. Press the DISPLAY/DEMO key to cancel the demonstration. →  6
Power turns OFF in the middle of operation.	<ul style="list-style-type: none"> ● "A.P.S. on" is set. 	<ul style="list-style-type: none"> ● Set the "A.P.S. off". →  54

Cassette deck

Symptom	Cause	Remedy
Sound cannot be produced by pressing the play key.	<ul style="list-style-type: none"> ● The head is dirty. ● The tape is wound too tight due to irregular winding. ● A nonrecorded tape is played. 	<ul style="list-style-type: none"> ● Clean the head referring to "Maintenance". →  56 ● Try another tape. ● Play a recorded tape.
No operation occurs even when an operation key is pressed.	<ul style="list-style-type: none"> ● The cassette holder is not closed completely. ● The operation key is pressed immediately after closing the cassette holder. ● The operation key is pressed in less than 4 seconds after turning the power ON. ● A tape is not inserted in the unit. ● The tape is wound too tight due to irregular winding. ● The tape is fully wound to one of the reels. 	<ul style="list-style-type: none"> ● Close the holder completely. →  22 ● Press operations keys in more than a few seconds after closing the holder. ● Press operation keys after waiting for more than 4 seconds. ● Insert a tape. →  22 ● Try another tape. ● Change the tape transport direction or reverse the tape insertion orientation. →  22
The DPSS malfunctions. (XD-5....series only)	<ul style="list-style-type: none"> ● The tape used is not suitable for DPSS, for example the spaces between tunes may be too short. 	<ul style="list-style-type: none"> ● Refer to "Searching for the desired music program (DPSS)". →  25
In dubbing, the tape stops at different moments in decks A and B.	<ul style="list-style-type: none"> ● This is due to the difference in the tape length or characteristics of the mechanisms of two cassette decks. 	<ul style="list-style-type: none"> ● Small time difference does not mean a malfunction.
The cassette holders cannot be opened by pressing the  PUSH OPEN area.	<ul style="list-style-type: none"> ● The key is pressed during recording or playback. ● The microcomputer is malfunctioning due to external noise. 	<ul style="list-style-type: none"> ● Press in stop mode. ● Reset the microcomputer. →  57
Sound is harsh or high frequencies are not reproduced.	<ul style="list-style-type: none"> ● The head is dirty. ● The tape is stretched or shrunk. 	<ul style="list-style-type: none"> ● Clean the head referring to "Maintenance". →  56 ● Try another tape.



1. With some tapes, a squeaky noise is produced when the tape is stopped automatically. This is due to the tape protection function, and not a malfunction.
2. Do not use longer tape than 110 minutes tapes, for the tape is too thin and gets easily tangled.

<p>Sound is distorted.</p>	<ul style="list-style-type: none"> ● The tape being played was recorded with distorted sound. ● A tape which has been recorded with the equalizer and/or 3D surround effects is being played back by applying the equalizer effect. 	<ul style="list-style-type: none"> ● Try another tape. ● Switch off the equalizer and 3D surround effects before starting playback. <p style="text-align: right;">→ 48</p>
<p>Sound from the MD/DVD INPUT (external input) is distorted.</p>	<ul style="list-style-type: none"> ● The input level is too high. 	<ul style="list-style-type: none"> ● Decrease the input level. <p style="text-align: right;">→ 47</p>
<p>Noise is noticeable.</p>	<ul style="list-style-type: none"> ● The tape head is magnetized. ● External noise is induced. ● A tape which has been recorded with Dolby NR is being played back without switching the Tape Equalizer or Dolby NR on. 	<ul style="list-style-type: none"> ● Demagnetize the head referring to "Maintenance". ● Install the system at a distance from other electric appliances and TV. ● Switch on the Tape Equalizer or Dolby NR. <p style="text-align: right;">→ 56</p> <p style="text-align: right;">→ 23</p> <p style="text-align: right;">→ 29</p>
<p>Sound vibrates.</p>	<ul style="list-style-type: none"> ● The capstans or pinch rollers are dirty. ● The tape is wound irregularly. 	<ul style="list-style-type: none"> ● Clean the head referring to "Maintenance". ● Wind the tape again by fast forwarding, rewinding or playing from an end to the other. <p style="text-align: right;">→ 56</p> <p style="text-align: right;">→ 23</p>
<p>Recording cannot be started by pressing the record key.</p>	<ul style="list-style-type: none"> ● The recording protect tab of the cassette has been broken. ● The cassette holder is not closed completely. ● The TAPE input is selected. ● The tape is fully wound to one of the reels. 	<ul style="list-style-type: none"> ● Use a cassette with an unbroken recording protect tab or block the hole. ● Close the holder completely. ● Select the source to be recorded with the input selector key. ● Change the tape transport direction of deck B or reverse the tape insertion orientation. <p style="text-align: right;">→ 7</p> <p style="text-align: right;">→ 22</p> <p style="text-align: right;">→ 29</p> <p style="text-align: right;">→ 28</p>

CD player

Symptom	Cause	Remedy
<p>A CD is placed in the player but it cannot be played.</p>	<ul style="list-style-type: none"> ● The disc is placed upside down. ● The disc position is displaced. ● The disc is extremely dirty. ● The disc is scratched. ● Dew is condensed on the optics lens. 	<ul style="list-style-type: none"> ● Place the disc properly, with the label side facing upward. ● Place the disc properly. ● Clean the disc referring to "Handling of discs and tapes". ● Try another disc. ● Refer to "Caution on condensation" and remove the condensation by evaporation. <p style="text-align: right;">→ 20</p> <p style="text-align: right;">→ 20</p> <p style="text-align: right;">→ 7</p> <p style="text-align: right;">→ 56</p>
<p>Sound is not produced.</p>	<ul style="list-style-type: none"> ● The disc has not been placed. ● The player is not put to the play mode. ● The disc is extremely dirty. ● The disc is scratched. 	<ul style="list-style-type: none"> ● Place a disc in the CD player. ● Press the play key. ● Clean the disc referring to "Handling of discs and tapes". ● Try another disc. <p style="text-align: right;">→ 20</p> <p style="text-align: right;">→ 20</p> <p style="text-align: right;">→ 7</p>
<p>Sound skips.</p>	<ul style="list-style-type: none"> ● The disc is dirty. ● The disc is scratched. ● The player is subject to vibration. 	<ul style="list-style-type: none"> ● Clean the disc referring to "Handling of discs and tapes". ● Try another disc. ● Install the unit in a place not subject to vibrations. <p style="text-align: right;">→ 7</p>

Remote control unit

Symptom	Cause	Remedy
Remote control operation is not possible.	<ul style="list-style-type: none"> ● Batteries are exhausted. ● The remote control is too far away from the system, the controlling angle is deviated or there is an obstacle in between. ● There is no tape or CD set in the component to be played. ● An attempt is made to play the cassette deck which is recording something. ● The MULTI CONTROL setting mode is activated. 	<ul style="list-style-type: none"> ● Replace with new batteries. → 16 ● Operate the unit inside the remote controllable range. → 16 ● Set a tape or CD in the component to be played. ● Wait until the recording ends. ● Cancel the MULTI CONTROL setting mode. → 17

General

Symptom	Cause	Remedy
No operation occurs when an operation key is pressed.	<ul style="list-style-type: none"> ● The MULTI CONTROL setting mode is activated. 	<ul style="list-style-type: none"> ● Cancel the MULTI CONTROL setting mode. → 17

For the U.S.A.**CAUTION :**

Use of controls or adjustments or performance of procedures other than those specified herein may result in hazardous radiation exposure.

In compliance with Federal Regulations, following are reproductions of labels on, or inside the product relating to laser product safety.

KENWOOD CORPORATION
2967-3, ISHIKAWA-CHO,
HACHIOJI-SHI, TOKYO, JAPAN

KENWOOD CORP. CERTIFIES THIS EQUIPMENT
CONFORMS TO DHHS REGULATIONS NO. 21 CFR
1040.10, CHAPTER 1, SUBCHAPTER J.

Location: Back Panel

Note to CATV system installer

This reminder is provided to call the CATV system installer's attention to Article 820-40 of the NEC that provides guidelines for proper grounding and, in particular, specifies that the cable ground shall be connected to the grounding system of the building, as close to the point of cable entry as practical

FCC WARNING

This equipment may generate or use radio frequency energy. Changes or modifications to this equipment may cause harmful interference unless the modifications are expressly approved in the instruction manual. The user could lose the authority to operate this equipment if an unauthorized change or modification is made.

NOTE:

This equipment has been tested and found to comply with the limits for a Class B digital device, pursuant to Part 15 of the FCC Rules. These limits are designed to provide reasonable protection against harmful interference in a residential installation. This equipment may cause harmful interference to radio communications, if it is not installed and used in accordance with the instructions. However, there is no guarantee that interference will not occur in a particular installation. If this equipment does cause harmful interference to radio or television reception, which can be determined by turning the equipment off and on, the user is encouraged to try to correct the interference by one or more of the following measures:

- Reorient or relocate the receiving antenna.
- Increase the separation between the equipment and receiver.
- Connect the equipment into an outlet on a circuit different from that to which the receiver is connected.
- Consult the dealer or an experienced radio / TV technician for help.

Main unit

[Amplifier section]

(XD-5...Series)

Rated power output (For U.S.A. and Canada)

80 watts per channel minimum RMS, both channels driven, at 6 Ω form 40 Hz to 15 kHz with no more than 0.9 % total harmonic distortion. (FTC)

Effective output power during STEREO operation
(Except for U.S.A. and Canada)

1 kHz, 10 % T.H.D., 6 Ω 100 W + 100 W

Rated output power during STEREO operation

(For U.K., Europe and Russia)

(DIN) 1 kHz, 0.7 % T.H.D., 6 Ω 70 W + 70 W

(Other countries)

1 kHz, 1.0 % T.H.D., 6 Ω 80 W + 80 W

(XD-4...Series)

Rated power output (For U.S.A. and Canada)

50 watts per channel minimum RMS, both channels driven, at 6 Ω form 40 Hz to 15 kHz with no more than 0.9 % total harmonic distortion. (FTC)

Effective output power during STEREO operation
(Except for U.S.A. and Canada)

1 kHz, 10 % T.H.D., 6 Ω 70 W + 70 W

Rated output power during STEREO operation

(For U.K., Europe and Russia)

(DIN) 1 kHz, 0.7 % T.H.D., 6 Ω 50 W + 50 W

(Other countries)

1 kHz, 1.0 % T.H.D., 6 Ω 55 W + 55 W

Signal to noise ratio

MD/DVD INPUT 90 dB (IHF' 66)

Input sensitivity / impedance

MD/DVD INPUT (XD-5...Series) 270 mV / 47 kΩ

(XD-4...Series) 300 mV / 47 kΩ

Output level / impedance

SUPER WOOFER PREOUT (XD-5...Series) 1.3 V / 620 Ω

(XD-4...Series) 1.0 V / 620 Ω

[Tuner section]

FM tuner section

Tuning frequency range 87.5 MHz ~ 108 MHz

(For Russia) 65.0 MHz ~ 74.0 MHz

MW (AM) Tuner section

Tuning frequency range

For U.K., Europe and Russia 531 kHz ~ 1,602 kHz

Other countries

9 kHz step 531 kHz ~ 1,602 kHz

10 kHz step 530 kHz ~ 1,610 kHz

For U.S.A. and Canada 530 kHz ~ 1,700 kHz

LW Tuner section (For U.K. and Russia)

Tuning frequency range 153 kHz ~ 279 kHz

SW Tuner section (XD-572S only)

Tuning frequency range 5.9 MHz ~ 17.9 MHz

[Cassette deck section]

Track 4-track, 2-channel stereo

Recording system AC bias system
(Frequency: 105 kHz)

Heads

A deck Playback head 1

B deck Playback / recording head 1

Erasing head 1

Fast winding time Approx. 115 seconds
(C-60 tape)

[CD player section]

Laser Semiconductor laser

Wow & Flutter Less than unmeasurable Limit
(Except for U.S.A. and Canada)

Digital output (Optical) - 15 dBm ~ - 21 dBm
(Wave length 660 nm)

[General]

Power consumption (XD-5...Series) 200 W
(XD-4...Series) 150 W

Dimensions W : 280 mm (11")

H : 330 mm (13")

D : 390 mm (15-3/8")

Weight (net) (XD-5...Series) 9.9 kg (21.8 lb)

(XD-4...Series) 9.2 kg (20.2 lb)

Speakers (LS-N552/LS-N502) XD-5...Series

Enclosure Bass-reflex type (magnetically shielded)

Speaker configuration

Woofers 160 mm, cone type

Tweeter 50 mm, cone type

Super-tweeter 25 mm, dome type

Impedance 6 Ω

Maximum input level 120 W

Dimensions W : 220 mm (8-11/16")

H : 330 mm (13")

D : 297 mm (11-11/16")

Weight (net) 4.2 kg (9.2 lb) (1 piece)

Speakers (LS-N452/LS-N402) XD-4...Series

Enclosure Bass-reflex type (magnetically shielded)

Speaker configuration

Woofers 160 mm, cone type

Tweeter 50 mm, cone type

Impedance 6 Ω

Maximum input level 70 W

Dimensions W : 220 mm (8-11/16")

H : 330 mm (13")

D : 284 mm (11-3/16")

Weight (net) 4.0 kg (8.8 lb) (1 piece)



1. KENWOOD follows a policy of continuous advancements in development. For this reason specifications may be changed without notice.
2. Sufficient performance may not be possible at very low temperatures (0°C or less).

MEMO:

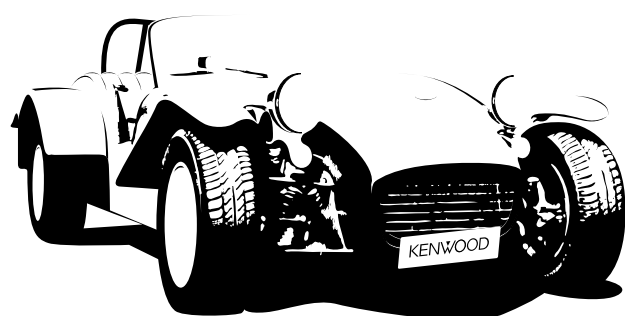

This instruction manual is used to describe multiple models.
 Model availability and features (functions) may differ depending on the country and sales area.



	XD-402/XD-452	XD-502/XD-552	XD-572S
DIGITAL OUT jack (OPTICAL) →	YES (Except for U.S.A. and Canada)	YES (Except for U.S.A. and Canada)	YES
SURROUND switch/ SPEAKERS terminals →	YES (Except for U.S.A., Canada, U.K., Europe and Russia)	YES (Except for U.S.A. and Canada)	YES
DPSS →	—————	YES	YES
Tape Equalizer →	YES	—————	—————
DOLBY NR →	—————	YES	YES
R.D.S. →	YES (For U.K., Europe and Russia)	YES (For U.K., Europe and Russia)	—————
Beat cancel function →	YES (For Russia)	YES (For Russia)	—————

KENWOOD

For your records

Record the serial number, found on the back of the unit, in the spaces designated on the warranty card, and in the space provided below. Refer to the model and serial numbers whenever you call upon your dealer for information or service on this product.

Model _____ Serial Number _____