

# **jWIN<sup>®</sup>**

***PORTABLE CD PLAYER with MP3  
DIGITAL RADIO CASSETTE RECORDER  
MODEL JX-CD492***

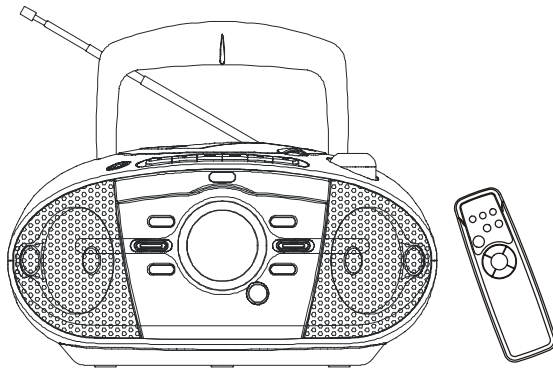



***OWNER'S MANUAL***

Visit our Web Site: <http://www.jwin.com>

# **IMPORTANT SAFETY INSTRUCTIONS**

## **WARNING:**

TO PREVENT FIRE OR SHOCK HAZARD, DO NOT USE THIS PLUG WITH AN EXTENSION CORD, RECEPTACLE OR OTHER OUTLET UNLESS THE BLADES CAN BE FULLY INSERTED TO PREVENT BLADE EXPOSURE. TO PREVENT FIRE OR SHOCK HAZARD. DO NOT EXPOSE THIS APPLIANCE TO RAIN OR MOISTURE.

 <p>This lightning flash with arrowhead symbol, within an equilateral triangle, is intended to alert the user to the presence of uninsulated "dangerous voltage" within the product's enclosure that may be of sufficient magnitude to constitute a risk of electric shock persons.</p>	<p style="text-align: center;"><b>CAUTION</b> RISK OF ELECTRIC SHOCK DO NOT OPEN</p> <p>Warning: to reduce the risk of electric shock, do not remove cover (or back) no user-serviceable parts inside. Refer servicing to qualified service personnel.</p>	 <p>The exclamation point within an equilateral triangle is intended to alert the user to the presence of important operating and maintenance (servicing) instructions in the literature accompanying the appliance.</p>
--------------------------------------------------------------------------------------------------------------------------------------------------------------------------------------------------------------------------------------------------------------------------------------------------------------------------------------------------------------------------	--------------------------------------------------------------------------------------------------------------------------------------------------------------------------------------------------------------------------------------------------------------------	-------------------------------------------------------------------------------------------------------------------------------------------------------------------------------------------------------------------------------------------------------------------------------------------------------------

1. Read these instructions.
2. Keep these instructions.
3. Heed all warnings.
4. Follow all instructions.
5. Do not use this apparatus near water.
6. Clean only with dry cloth.
7. Do not block any ventilation openings. Install in accordance with the manufacturer's instructions.
8. Do not install near any heat sources such as radiators, heat registers, stoves, or other apparatus (including amplifiers) that produce heat.
9. Do not defeat the safety purpose of the polarized or grounding type plug. A polarized plug has two blades with one wider than the other. A grounding type plug has two blades and a third grounding prong. The wide blade or the third prong are provided for your safety. If the provided plug does not fit into your outlet, consult an electrician for replacement of the obsolete outlet.
10. Protect the power cord from being walked on or pinched particularly at the plugs, convenience receptacles, and at the point where they exit from the apparatus.
11. Only use attachments/accessories specified by the manufacturer.
12. Unplug the apparatus during lightning storms or when unused for long periods of time.
13. Refer all servicing to qualified personnel. Servicing is required when the apparatus has been damaged in any way, such as power supply cord or plug is damaged, liquid has been spilled or objects have fallen into the apparatus, the apparatus has been exposed to rain or moisture, does not operate normally, or has been dropped.
14. This appliance shall not be exposed to dripping or splashing water and objects filled with liquids such as vases must not be placed on apparatus.

CAUTION: TO PREVENT ELECTRICAL SHOCK, MATCH WIDE BLADE PLUG TO WIDE SLOT AND FULLY INSERT.

## PRECAUTIONS

### CAUTION:

- To avoid electric shock, this unit must not be exposed to dripping or splashing water
- Minimum distances around the apparatus for sufficient ventilation;
- The ventilation should not be impeded by covering the ventilation openings with items, such as newspapers, table-cloths curtains, etc.
- No naked flame sources, such as lighted candles, should be placed on the apparatus;
- Before scrapping the appliance, remove the batteries and place them in the appropriate battery collection container.

### CAUTION

#### CLASS 1 LASER PRODUCT

Use of Controls or adjustments or performance of procedures other than those specified herein may result in hazardous radiation exposure.

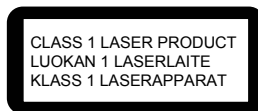

### CAUTION

**CLEANING:** Always disconnect unit from power supply before attempting to clean it.  
Use soft cloth moistened with soapy water, wipe gently.  
Do not use solvents or abrasive materials.

### LASER SAFETY

This unit employs a laser. Only qualified service personnel should attempt repair.

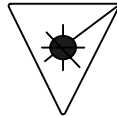

**DANGER:** INVISIBLE LASER RADIATION WHEN OPEN AND INTERLOCK FAILED OR DEFEATED. AVOID DIRECT EXPOSURE TO BEAM.  
**CAUTION:** HAZARDOUS LASER RADIATION WHEN OPEN AND INTERLOCK DEFEATED.

## LOCATION OF CONTROLS

### TOP VIEW

1. DBBS ON/OFF Button
2. FM Antenna
3. Handle
4. CD Door
5. Cassette Control Buttons (PAUSE/STOP-EJECT/FFW/REW/PLAY/RECORD)
6. CD Door Open Lid
7. Volume Control
8. FUNCTION Selector (TAPE -"CD/Radio Off" /RADIO/CD)
9. FM STEREO/MONO Selector

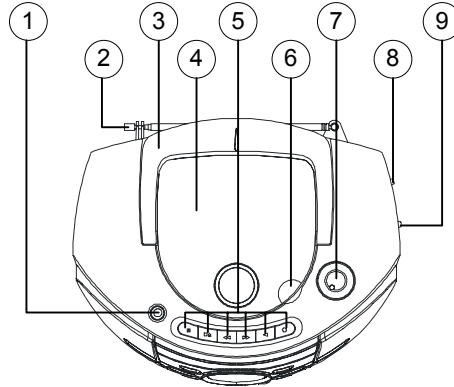

### FRONT VIEW

10. Cassette Door/Compartment
11. Speakers
12. FOLDER DN/M-DN Button
13. STOP/BAND Button
14. TUNING/CD SKIP DN/Backward Button
15. CD/TUNER LCD Display
16. Remote Sensor
17. TUNING/CD SKIP UP/Forward Button
18. PLAY/PAUSE Button
19. Built-in Microphone
20. FOLDER UP/M-UP Button
21. PROG./MEM. Button

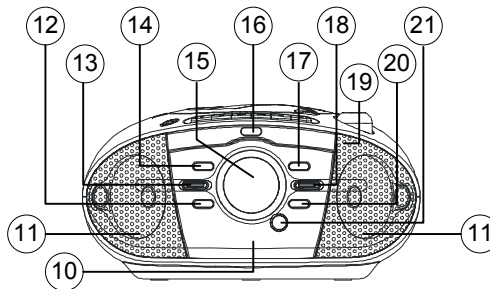

### REAR VIEW

22. Battery Door/Compartment
23. Headphones
24. AC Input Socket
25. RESET Switch - If the set locked up, or does not display information, or the data displayed is wrong, press the "RESET" switch with a sharp object, e.g. needle etc. The data must then be re-entered.

**Note: Tuner memory would be lost when "RESET" switch pressed.**

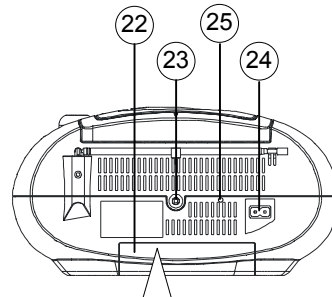

### Headphone Jack

Headphone Jack "PHONES" (23) for headphones with 16-32 Ohm impedance (3.5mm jack). Use corresponding adaptors (Electronics shops) if you have different plugs. The speakers are automatically switched off when the headphones are being used.

1.5V x 8 UM 2 or "C" size or LR14

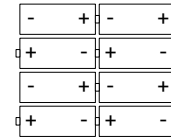

### CAUTION:

Listening at high power for long periods of time can damage users' ears.

## REMOTE CONTROLS

- 26. FOLDER UP/M-UP and FOLDER DN/M-CN Button
- 27. PROG./MEM. Button
- 28. CD PLAY/PAUSE Button
- 29. PLAY MODE Button
- 30. TUNER/CD SKIP DN/Backward Button
- 31. TUNER/CD SKIP UP/Forward Button
- 32. CD STOP/BAND Button

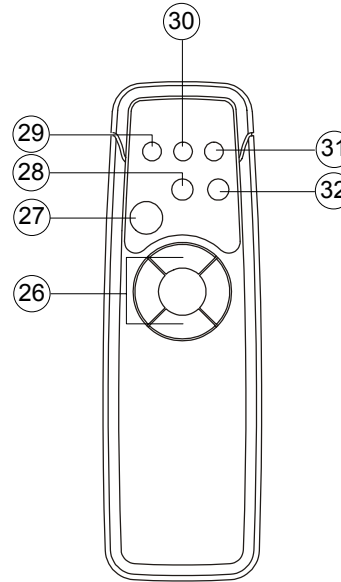

### BATTERY REPLACEMENT

1. Remove the battery compartment cover.
2. Insert two "AA" size / LR6 / UM-3 batteries (not included) into the battery compartment and ensure the proper polarities are maintained.
3. Replace the battery compartment cover.

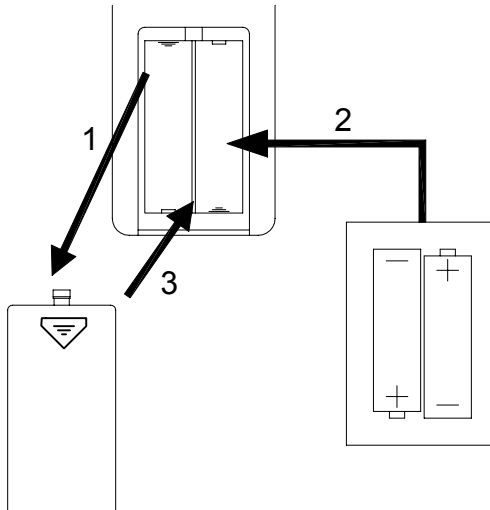

### Battery Life

To prevent damage due to battery leakage, the remote should be checked periodically as required.

Damage due to battery leakage is not covered by the warranty.

When the battery becomes weak, the remote control will not work, be sure to replace both batteries at the same time. We recommend ALKALINE batteries for longer usable life.

## OPERATING INSTRUCTION

### POWER ON/OFF

1. To turn on the power, slide the FUNCTION selector (8) to your desired mode (RADIO, CD or TAPE with Play button pressed).

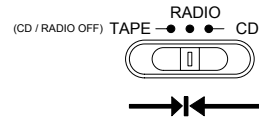

2. To turn off the power, slide the FUNCTION selector (8) to TAPE position.

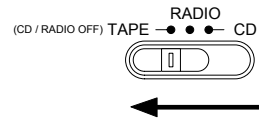

---

### BASIC OPERATION

#### Volume Control

Once the required station has been located, adjust the VOLUME controls (7) to the desired level.

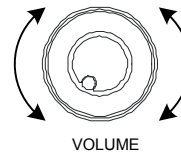

#### DBBS Control

Press the DBBS button (1) once to get a rich bass sound,

## LISTENING TO THE RADIO

1. Set the FUNCTION selector (8) to RADIO mode

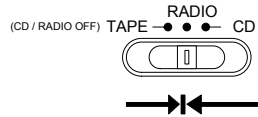

2. Press the BAND button (13) or (32) for AM or FM band.

Example : FM mode



3. Press the TUNING Up or Down button (14)/(17) or (30)/(31) to tune to the desired station.

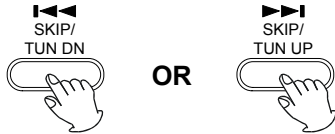

Manual Tuning - Press and hold the TUNING UP or DOWN buttons (14)/(17) or (30)/(31) until the display approaches your desired station. Then tap the buttons repeatedly until the display shows the exact frequency.

Auto tuning - Press the TUNING forward or backward buttons momentarily and release. The tuner will move up or down to the next available station.

4. When finished listening, slide the FUNCTION selector (8) to TAPE (RADIO/CD OFF) position.

## STORING PRESET STATIONS

1. Tune to the station you wish to store by pressing TUNING UP or DOWN button (14)/(17) or (30)/(31)

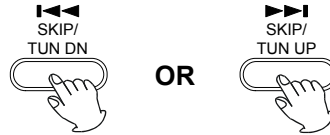

The unit enables you to program 10 stations of FM and 10 stations of AM band.

2. Press the PROGRAM button (21) or (27) once. ("MEMORY" flashing)

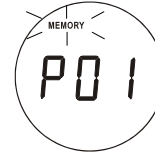

3. Press the FOLDER/M-UP or FLDER-DN button (20)/(12) or (26) repeatedly to set the desired preset station number. ("MEMORY" still flashing)

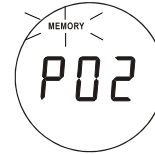

4. Press the PROGRAM button (21) or (27) again. The station is stored. ("MEMORY" steady on)

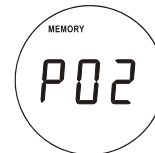

5. To store other stations, repeat above steps.

## RECALLING PRESET STATION

Press the FOLDER/M-UP or FOLDER/M-DN (20)/(12) or (26) button on main unit or remote control repeatedly to select the desired station.

### PLAYING COMPACT DISCS

1. Set the FUNCTION selector (8) to CD mode

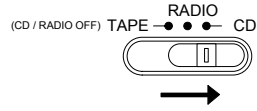

2. If there is no CD inside or disc damaged, a "--" display will be appear.

*When there is no disc*

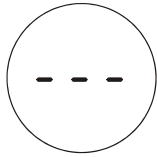

### Loading a disc

1. Lift the CD door lid (6) to open the CD door.
2. Put a disc inside and then close the CD door. After that, reading TOC will start.

Note: Ensure the disc is pushed fully and locked in place.

*After reading TOC*



Note: This unit is CD-R / -RW compatible.

### To play the disc

Press the PLAY/PAUSE button (18) or (28) to play the CD.

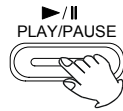

*Playing track 1*



### To pause the CD

Press the PLAY/PAUSE button while the disc is playing. Press it again to resume playing.

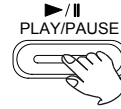

*While paused*



### To stop the disc

Press the STOP button (13) or (32).

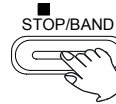

*Stop condition (TOC display)*

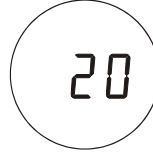



**Skip and Search Function**

Press the SKIP Next or Back buttons (14)/(17) or (30)/(31) briefly.

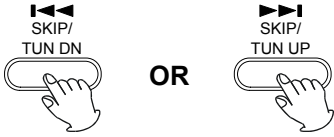

	IN PLAY MODE		IN STOP MODE
	PRESS ONCE	PRESS TWICE	PRESS ONCE
	BACK TO THE BEGINNING OF THE CURRENT TRACK	PREVIOUS TRACK	PREVIOUS TRACK
	NEXT TRACK		NEXT TRACK

Press and hold the SKIP button during playback :



NOTE : During search mode low level audio will be heard to assist in locating the correct point in the track.

**To repeat a track or disc**

Press the PLAY MODE button (29) on the remote control one time, "one track repeat" will be active.(REPEAT Flashes)



One track repeat (flashing)

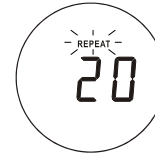

With one more press, "all track repeat" will be active. (REPEAT ALL will show steadily)

All track repeat (steady)

With one additional press, the repeat mode is cancelled.

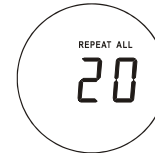

**Random play function**

In CD stop mode, press the PLAY MODE button (29) on remote control three times (RANDOM displayed), then press PLAY/PAUSE button (18) or (28) to start random play. Press PLAY MODE button (29) once again to change normal playing mode.



Random playing start

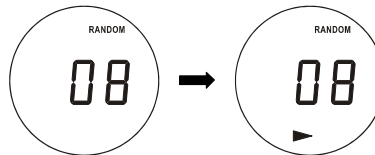

## PROGRAMMED PLAYBACK

This CD player enables you to program up to 20 tracks in the sequence of your choice. First select CD stop mode.

1. Press the PROGRAM button (21) or (27) one time. ("MEMORY" flashes)

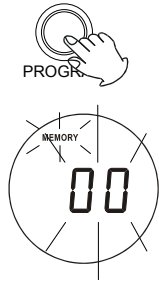

2. Press the SKIP Forward or Backward button (14)/(17) or (30)/(31) to select the desired track to be programmed.

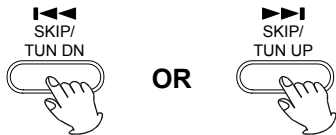

Choose track 4

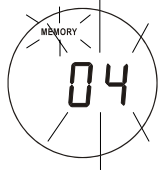

3. Press the PROGRAM button (21) or (27) one time, then the selected track, e.g., track 4 is stored.

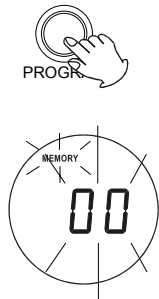

4. Continue to program, repeat steps 2 and 3 for each selection.

When program is full

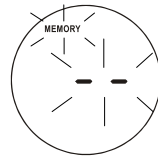

### Reviewing programs

Press the PROGRAM button (21) or (27) repeatedly. The track number programmed on each program number will be displayed.

5. Press PLAY/PAUSE button (18) or (28) to play the programmed tracks.

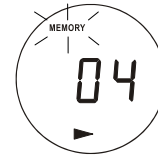

### Clear the program

Press the PROGRAM button (21) or (27) to recall previously programmed track ("MEMORY" icon flashes), then press CD stop button to cancel the preset programs or change function mode or open the CD door.

**PLAYING MP3 DISCS**

1. Set the FUNCTION selector (8) to CD mode

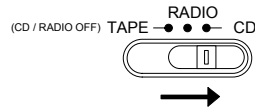

2. If there is no disc inside or disc damaged, a "--" display will be appear.

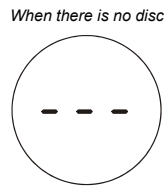

2. Press CD SKIP ►►► / ◄◄◄ buttons (14)/(17) or (30)/(31) to select desired track.

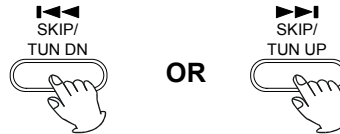

Folder 2 track 3 selected

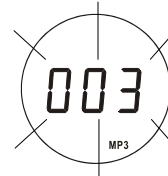

**Loading a disc**

1. Lift up the CD door lid (6) to open the CD door.
2. Put a disc inside and then close the CD door. After that, reading TOC will start.

Note: Ensure the disc is pushed fully and locked in place.

After reading TOC



3. Press the PLAY/PAUSE button (18) or (28) to start playing.

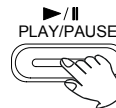

Playing track 3 of folder 2



Note: This unit is CD-R / -RW compatible.

**To play the disc**

1. Press the FOLDER UP or DN button (20)/(12) or (26) to select desired folder. Total tracks of select folder will then be shown.

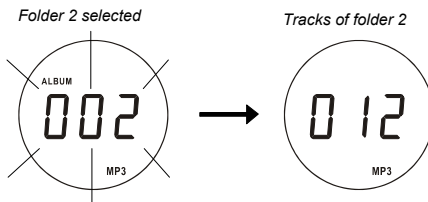

**To pause the CD**

Press the PLAY/PAUSE button (18) or (28) while the disc is playing. Press it again to resume playing.



While paused



### To stop the disc playing

Press STOP button (13) or (32).

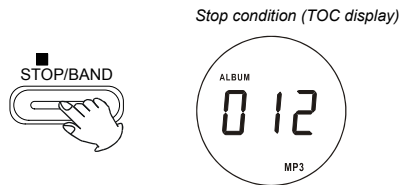

### PLAY MODE for Repeat Track/Folder and Random Play Operation

1. Press the PLAY MODE button (29) on the remote control once for current track repeat.

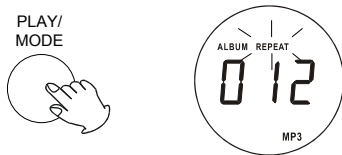

2. Press the PLAY MODE button (29) on the remote control twice for tracks in current folder repeat.



3. Press the PLAY MODE button (29) on the remote control third for tracks in all folder repeat.



4. Press the PLAY MODE button (29) on the remote control fourth for tracks in random play mode.



Note: Once your desired mode selected, press the PLAY/PAUSE button (18) or (28) to start playback from stop mode.

5. Press the PLAY MODE button (29) on the remote control fifth for cancel above modes.

### PROGRAMMED PLAYBACK

This CD player enables you to program up to 20 tracks in the sequence of your choice. First select CD stop mode.

1. Press the PROG./MEM. Button (21) or (27) one time.

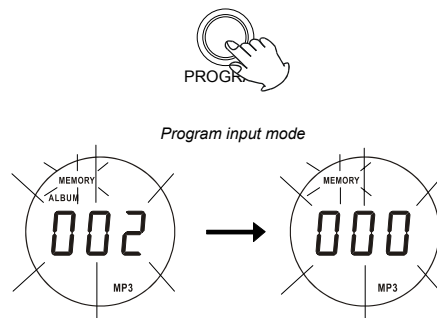

2. Press the FOLDER UP or DN button (20)/(12) or (26) to select desired folder.

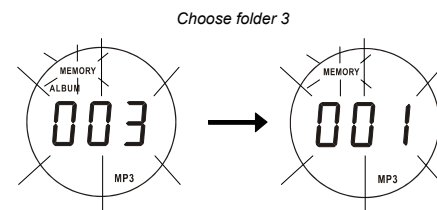

3. Press the CD SKIP ◀◀ or ▶▶ button (14)/(17) or (30)/(31) to select the desired track to be programmed.

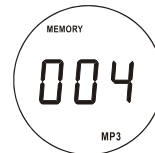
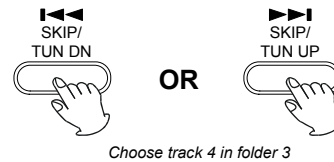

4. Press the PROG./MEM. button again, then track 4 of folder 3 is stored.

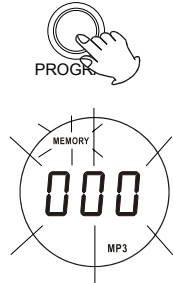

5. Continue to program, repeat steps 2 to 4 for each selection.

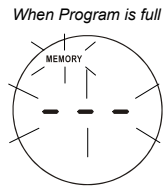

#### Reviewing programs

Press the PROG./MEM. button (21) or (27) repeatedly. The track number programmed on each program number will be displayed.

6. Press the PLAY/PAUSE button (18) or (28) to play the programmed tracks.

*Playing track 4 of folder 3*

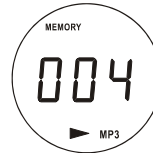

Note: Press the PROG./MEM. Button (if programmed tracks still exist) then PLAY/PAUSE button, the program play will start again.

#### Clear the program

Press the PROGRAM button (21) or (27) to recall previously programmed track ("MEMORY" icon flashes), then press CD stop button to cancel the preset programs or change function mode or open the CD door.

### PLAYING CASSETTE TAPE

1. Set the FUNCTION selector (8) to TAPE mode

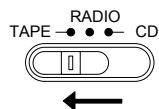

2. Press STOP/EJECT button (5) to open the cassette door. Insert a prerecorded tape to the cassette compartment, close the cassette door.

3. To playback, press the PLAY button (5).

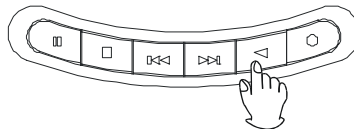

4. To stop Playback, press the STOP/EJECT button (5).

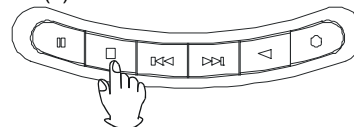

### To suspend playback

Press PAUSE button (5).

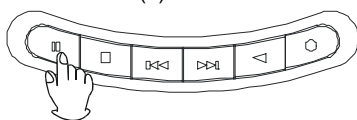

To resume playback, press the PAUSE button again.

### To Fast Forward or Rewind tape

Press REW or F.FWD button (5).

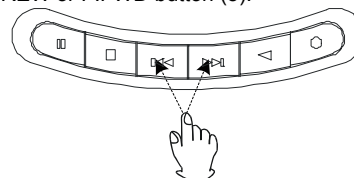

### TAPE RECORDING From TUNER

1. Set the FUNCTION selector (8) to the TUNER mode.
2. Follow steps 2 and 3 in "LISTENING TO THE RADIO" to tune in the station you wish to record.
3. Insert a blank tape to cassette compartment then close the cassette door.
4. Press the RECORD and PLAY buttons (5) at same time to start recording.

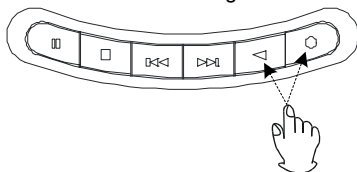

5. Press STOP/EJECT (5) to stop recording.

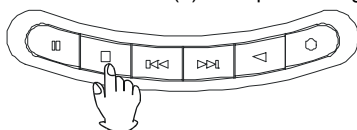

- Note:
1. Return to Tape mode, rewind the tape to listen to recorded materials.
  2. Recording through built-in microphone (Tape mode): similar to above instructions.

### TAPE RECORDING From CD or MP3

1. Select the FUNCTION selector (8) to CD mode then open the CD door by lift up door lid (6).
2. Put a disc inside CD compartment and then close the CD door
3. Insert a blank tape to cassette compartment then close the cassette door.
4. Press the RECORD and PLAY buttons (5).

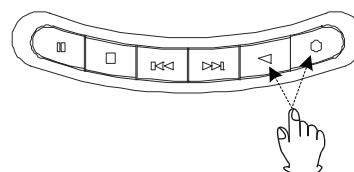

5. Press PLAY/PAUSE (18) or (28) to start CD playing for recording.
6. Press STOP/EJECT (5) to stop recording.
7. Press the STOP/BAND button (13) or (32) to stop CD playing.

## CARE AND MAINTENANCE

### COMPACT DISC CARE

- Treat the disc carefully. Handle the disc only by its edges. Never allow your fingers to come in contact with the shiny, unprinted side of the disc.
- Do not attach adhesive tape, stickers etc., to the disc label.
- Clean the disc periodically with soft, lint-free, dry cloth. Never use detergents or adhesive cleaners to clean the disc. If necessary, use a CD cleaning kit.
- If disc skips or gets stuck on a section of the disc, it is probably dirty or damaged (scratched).
- When cleaning the disc, wipe in straight lines from the center of the disc to the edge of the disc. Never wipe in circular motions.
- To remove a disc from its storage case, press down on the center of the case and lift the disc out, holding it carefully by the edges.
- Fingerprints and dust should be carefully wiped off the disc's recorded surface with a soft cloth. Unlike conventional records, compact discs have no grooves to collect dust and microscopic debris so gently wiping with a soft cloth should remove most particles.

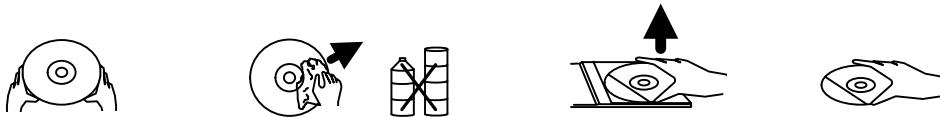

### TAPE HEAD CLEANING

The tape heads, pinch roller and capstan require periodic cleaning. This removes particles of the metal oxide coating that wear off the tape and accumulate on these parts and impair performance. Switch off the power, press the Stop/Eject Key to open the cassette door, and press the Play Key. Clean the tape heads, pinch roller and capstan with a soft cloth or cotton swab dampened in isopropyl alcohol or special tape head cleaner. NOTE: Never use any metal objects on or near the tape heads. Do not allow any cleaning material to fall into the tape assembly.

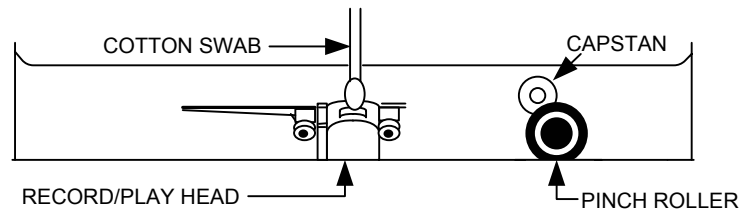

### CLEANING THE UNIT

- To prevent fire or shock hazard, disconnect your unit from the AC power source when cleaning.
- The finish on the unit may be cleaned with a dust cloth and cared for as other furniture, Use caution when cleaning and wiping the plastic parts.
- If the cabinet becomes dusty wipe it with a soft dry dust cloth. Do not use any wax or polish sprays on the cabinet.
- If the front panel becomes dirty or smudged with fingerprints it may be cleaned with a soft cloth slightly dampened with a mild soap and water solution. Never use abrasive cloths or polishes as these will damage the finish of your unit.

Caution: never allow any water or other liquids to get inside the unit while cleaning.

## TROUBLESHOOTING GUIDE

Should this unit exhibit a problem, check the following before seeking service.

Symptom	Possible cause	Solution
---------	----------------	----------

### Radio

Noise or sound distorted on AM or FM broadcasts.	Station not tuned properly for AM or FM	Retune the AM or FM broadcast station.
	FM : Antenna is not extended.	Extend FM antenna.
	AM : Unit is not positioned correctly.	Rotate unit until best reception is obtained.
AM or FM, no sound.	FUNCTION Selector not set to RADIO position.	Set FUNCTION Selector to RADIO position.
	Volume at minimum	Increase Volume.

### Cassette Player

No sound.	FUNCTION selector not set to TAPE position.	Set FUNCTION selector to TAPE position.
	Volume at minimum	Increase Volume
Sound distorted.	Dirty Record/Play head.	Clean the Record/Play head.
Speed varies	Tape old or worn.	Replace the tape.
	Dirty roller and capstan.	Clean roller and capstan.

### Cassette Recorder

Will not record.	Press prevention tab removed	Cover hole with tape
Distorted sound on playback.	Defective tape or dirty tapehead.	Replace tape or clean tape head.

### Compact Disc Player

CD Player will not play.	FUNCTION selector not set to CD position.	Set FUNCTION selector to CD position.
	CD is not installed or installed incorrectly.	Insert CD with label side up.
CD skips while playing.	Disc is dirty or scratched.	Wipe disc with cloth or use another disc.
Disc is inserted but CD player skips over spot and will not play,	Disc inserted upside down.	Insert disc properly.
	Disc is dirty.	Clean disc.
	Disc is non-standard.	Use correct disc.

## SPECIFICATIONS

Power Supply	AC 120Volts ~ 60Hz DC 12V (1.5V x 8 UM2 or "C" size or LR14)	Tape Section:	Built-in ALC DC Bias/Magnet Erase
Power Output	1.2W/CH with 10% THD	CD Section	Top Loading CD
Dimension of Unit	290(W)x233(D)x150(H)mm	Speaker	3", 8 ohms
Radio Section	Tuning : PLL with 20 Presets (FM 10, AM 10) Freq. Range : AM 520 - 1710KHz FM 87.5 - 108MHz	Remote Control	8 Keys, Battery size "AA" x 2

Model No. \_\_\_\_\_

Serial No. \_\_\_\_\_