

# MICRO HI-FI CD PLAYER AND AM/FM STEREO RADIO

## JX-CD3150D

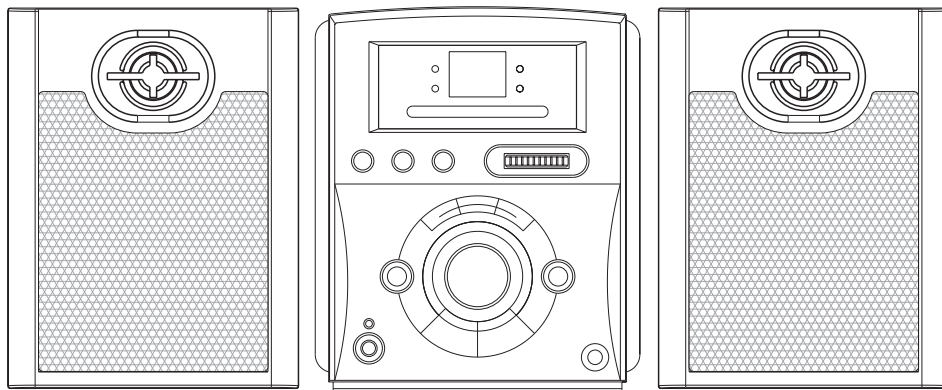

# jWIN<sup>®</sup>

visit our web site at <http://www.jwin.com>



## CAUTION

TO PREVENT FIRE OR SHOCK HAZARD, DO NOT USE THIS PLUG WITH AN EXTENSION CORD, RECEPTACLE OR OTHER OUTLET UNLESS THE BLADES CAN BE FULLY INSERTED TO PREVENT BLADE EXPOSURE. TO PREVENT FIRE OR SHOCK HAZARD, DO NOT EXPOSE THIS APPLIANCE TO RAIN OR MOISTURE.



The lightning flash with arrow-head symbol, within an equilateral triangle is intended to alert the user to the presence of uninsulated 'dangerous voltage' within the product's enclosure that may be of sufficient magnitude to constitute a risk of electric shock to persons.

### CAUTION

RISK OF ELECTRIC SHOCK  
DO NOT OPEN

WARNING: TO REDUCE THE RISK OF ELECTRIC SHOCK DO NOT REMOVE COVER (OR BACK), NO USER SERVICEABLE PARTS INSIDE REFER SERVICING TO QUALIFIED SERVICE PERSONNEL.



The exclamation point within an equilateral triangle is intended to alert the user to the presence of important operating and maintenance (servicing) instructions in the literature accompanying the appliance.

## IMPORTANT NOTES

- Avoid installing this unit in places exposed to direct sunlight or close to heat radiating appliances such as electric heaters, on top of other stereo equipment that radiates too much heat, places lacking ventilation or dusty areas, places subject to constant vibration and/or humid or moist areas.
- Do not attempt to clean this unit with chemical solvents as this might damage the finish. Use a clean dry cloth.
- Operate controls and switches as described in the manual.
- Before turning 'On' the power, make certain that power cord is properly installed.
- Store your CDs in a cool area to avoid damage from heat.
- When moving the set, be sure to first disconnect the power cord.

### CLASS 1 LASER PRODUCT

CLASS 1 LASER PRODUCT  
APPAREIL À LASER DE CLASSE 1  
PRODUCTO LASER DE CLASE 1

CAUTION  
INVISIBLE LASER RADIATION  
WHEN OPEN AND INTERLOCKS  
DEFEATED.  
AVOID EXPOSURE TO BEAM



**This product contains a low power Laser Device.**



## PREPARATION FOR USE

### UNPACKING AND SET UP

- Carefully remove the unit from the carton and remove all packing materials from the unit.
- Carefully remove any small strips of tape which may have been used to keep the CD door closed during shipment.
- Open the CD compartment by lifting the “**OPEN**” tab on right side of CD door. Inside the CD compartment you will see a card which is used to prevent the laser pick-up from moving during shipment. Carefully remove this card and close the CD compartment door.
- Please save the carton and packing materials in the event that your unit ever needs to be returned for service. The original carton and packing materials are the only way to protect the unit from damage during shipment.
- Unwind the FM lead wire antenna and extend it to its full length.
- Remove the twist-tie from the AC power cord and extend it to its full length.

### PROTECT YOUR FURNITURE

This model is equipped with non-skid rubber 'feet' to prevent the product from moving when you operate the controls. These 'feet' are made from non-migrating rubber material specially formulated to avoid leaving any marks or stains on your furniture. However certain types of oil based furniture polishes, wood preservatives, or cleaning sprays may cause the rubber 'feet' to soften, and leave marks or a rubber residue on the furniture. To prevent any damage to your furniture we strongly recommend that you purchase small self-adhesive felt pads, available at hardware stores and home improvement centers everywhere, and apply these pads to the bottom of the rubber 'feet' before you place the product on fine wooden furniture.



## SPEAKER CONNECTION

Connect each speaker to the corresponding speaker terminals on the back panel of the main unit. Make sure that:

- The left speaker is connected to the (L) left pair of speaker terminals, and the right speaker to the (R) right pair of speaker terminals.

Also make sure that the speaker wires are correctly connected:

- That the red wires are connected to the red (+) terminals, and the black wires to the black (-) terminals.

Depress the plastic lever to open the terminal, insert the bare end of the speaker wire into the opening and release.

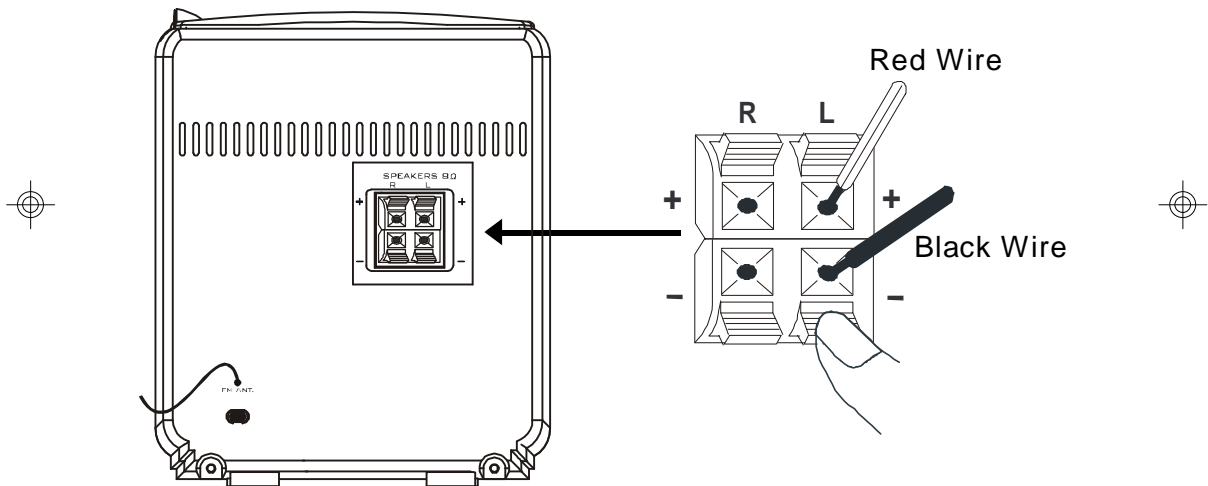

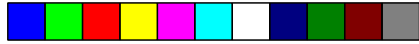

## POWER SOURCE

This system is designed to operate on normal 110/220V 60/50Hz AC house current only. Attempting to operate this system from any other power source may cause damage to the system, and such damage is not covered by your warranty. Unwind the AC power cord and connect the AC plug to your AC outlet.

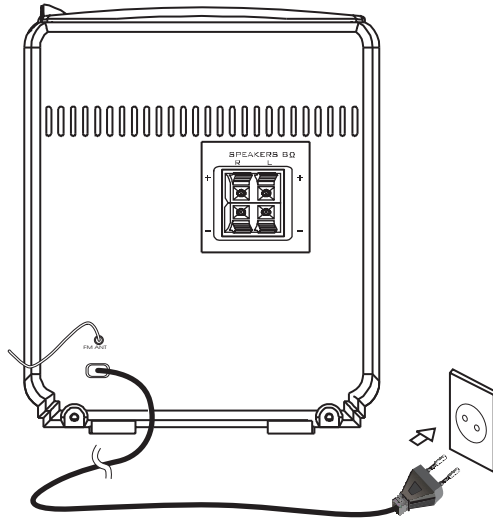





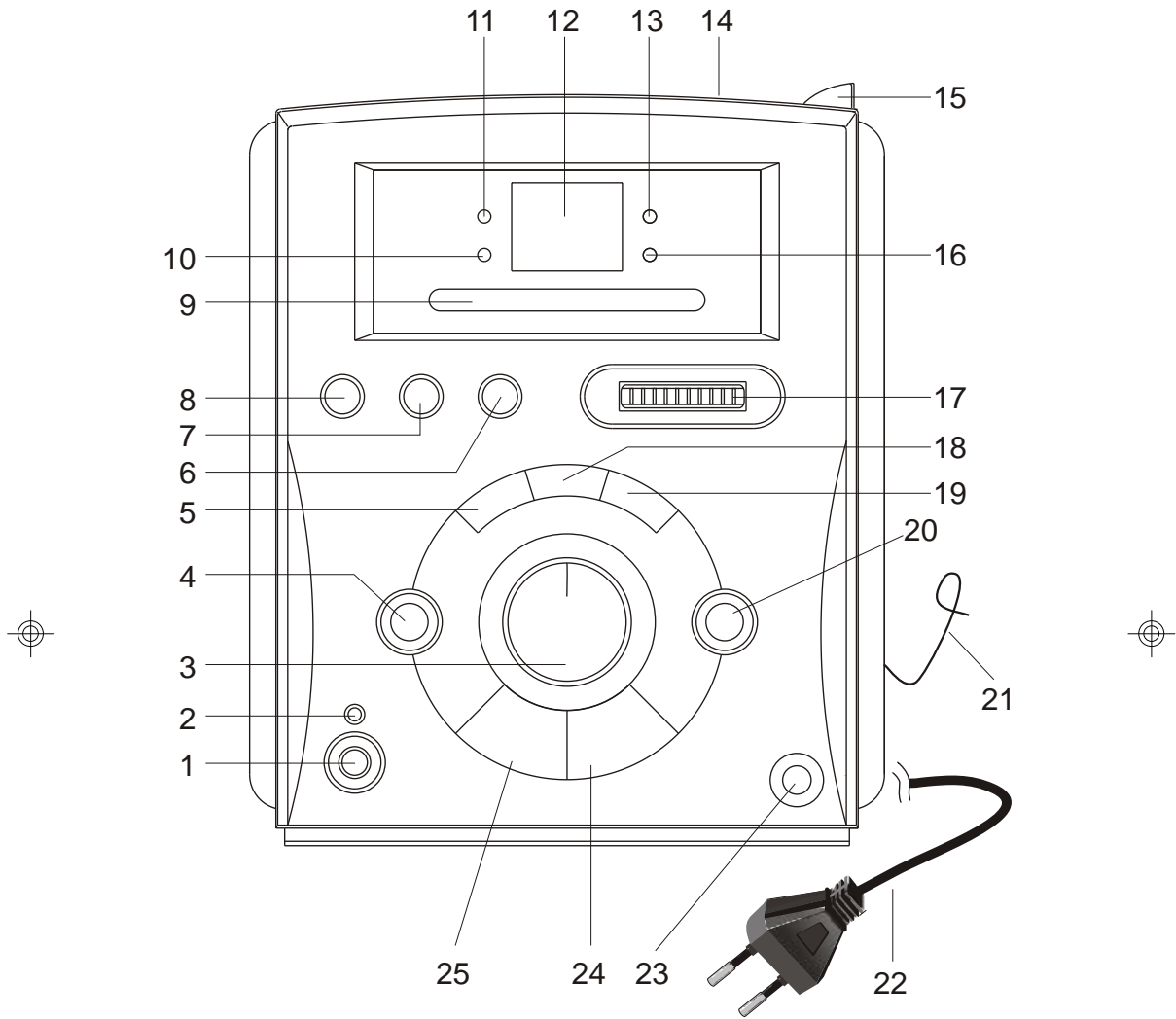









## LOCATION OF CONTROLS AND INDICATORS





- 1.) **POWER ON**  / **OFF**  Button.
- 2.) **POWER** 'On' Indicator.
- 3.) **VOLUME** Control.
- 4.) **STOP**  Button.
- 5.) **PROGRAM** Button.
- 6.) **MONO**  / **STEREO**  Selector Button.
- 7.) Band **AM**  / **FM**  Selector Button.
- 8.) Function **CD**  / **TUNER**  Selector Button.
- 9.) Tuning Dial.
- 10.) **PLAY / PAUSE** Indicator.
- 11.) **FM STEREO** Indicator.
- 12.) CD Track Number Display.
- 13.) **PROGRAM** Indicator.
- 14.) CD Door.
- 15.) **OPEN** Button.
- 16.) **REPEAT** Indicator.
- 17.) **TUNING** Control.
- 18.) **REPEAT** Button.
- 19.) **RANDOM** Button.
- 20.) **PLAY/PAUSE**  Button.
- 21.) External FM Wire Antenna.
- 22.) AC Power Cord .
- 23.) **PHONES** Jack.
- 24.) **FWD SKIP/SEARCH**  Button.
- 25.) **REV SKIP/SEARCH**  Button.









## OPERATING INSTRUCTIONS

### LISTENING TO THE RADIO

- Make sure that the FM Lead Wire antenna is extended to its full length.

- 1.) Press the **POWER** button to turn the unit “**ON** ”. The **POWER** indicator comes ‘On’.
- 2.) Press the **CD / TUNER** button to **TUNER**  position.
- 3.) Press the **AM**  / **FM**  button to select the radio band as desired.
- 4.) Turn the **TUNING** control to tune to the desired radio station.

**Note:**

If you tune to a FM Stereo station and the **MONO / STEREO** button is set to **STEREO**  position, the **FM STEREO** indicator will light.

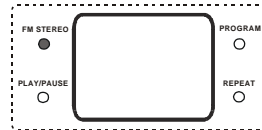

If the FM reception is noisy or weak you may be able to improve it by pressing the button to the **MONO**  position, however the sound will no longer be in stereo.

- 5.) Adjust the **VOLUME** control as desired.
- 6.) When you are finished listening press the **POWER** button to the “**OFF** ” position. All indicators go ‘off’.





## HINTS FOR BETTER RECEPTION

**FM:** The FM lead wire antenna on the back panel should be extended to its full length. You may also have to vary the direction of this antenna until you find the position that provides the best reception.

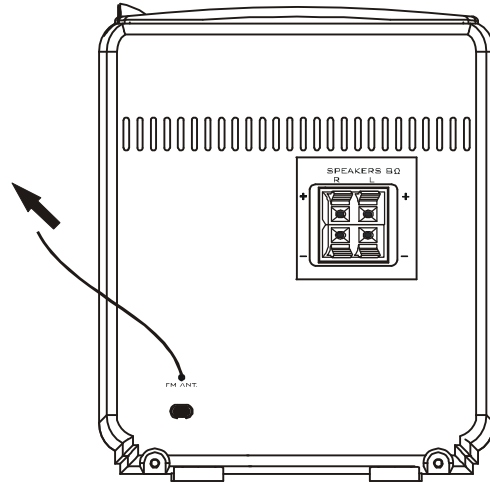

**AM:** The AM bar antenna is inside the cabinet of the main unit. You may need to change the position of the main unit until you find the position that provides the best reception for your favorite AM stations.

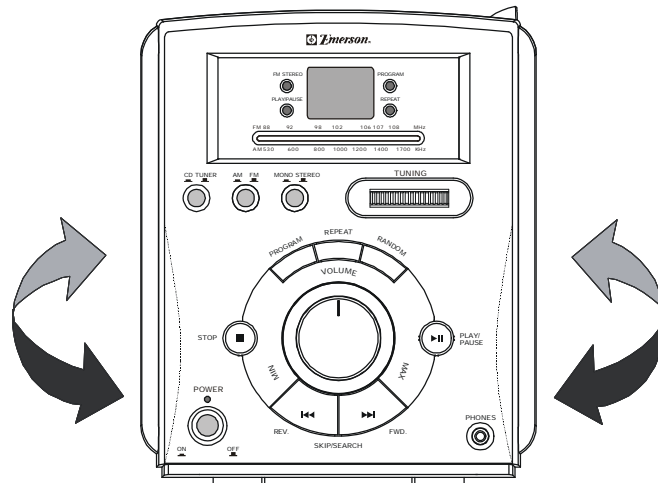



## PLAYING COMPACT DISCS

**NOTE:** Although this CD player can read CD-R and CD-RW discs, in addition to normal CDs, the playability of CD-R/RW discs may be effected by the type of software that was used to create the discs, as well as the quality and condition of the blank media you are using. 100% playability cannot be guaranteed.

This is not an indication of a problem with the player.

### NORMAL Playback

1.) Press the **POWER** button to turn the unit “**ON** ”. The **POWER** indicator comes ‘On’.

2.) Press the **CD / TUNER** button to **CD**  position.

The two dashes “--” light up on LED display.

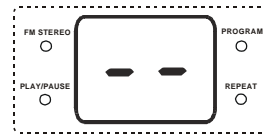

3.) Open the CD door by lifting the **OPEN** tab on right side of CD door. If you have not already removed the card from the CD player, please remove it now.

4.) Place your CD on the center spindle with the printed label side facing up. Make sure the CD is seated properly.

Close the CD door.

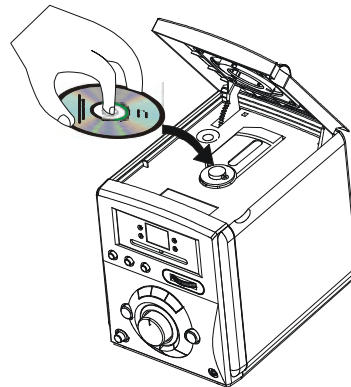

The player will read the Table of Contents and the display will show the total number of tracks on the disc.



If the disc is damaged or up side down, display will show “--”.



5.) Press the **PLAY/PAUSE ►II** button to begin playback on Track 1.

The **PLAY/PAUSE** indicator lights up.

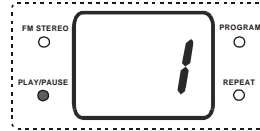

6.) Adjust the **VOLUME** control as desired.

7.) Playback will continue until the end of the disc. When the disc ends the display again shows the total number of tracks on the disc.

You may also stop playback at any time by pressing the **STOP ■** button.

### PAUSE Control

To pause momentarily during playback press the **PLAY/PAUSE ►II** button again.

Playback stops but the disc continues to spin and the **PLAY/PAUSE** indicator flashes.

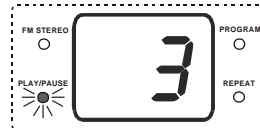

Press the **PLAY/PAUSE ►II** button once more to cancel Pause and resume playback. The **PLAY/PAUSE** indicator stops flashing.

### Skipping Tracks and High Speed Music Search

During CD Playback, repeatedly press the **SKIP FWD ►►** or **SKIP REV ◀◀** button to skip to higher or lower number tracks. When the desired track number appears on the display release the button and playback will begin on the desired track.

To rapidly search forward or back within a track to locate a specific musical passage, depress and hold either the **►► / ◀◀** buttons.

The player will move forward or backward at high speed as long as the buttons are depressed. When you hear the desired passage release the buttons. Normal playback will resume at that point.



## REPEAT Playback

This feature allows you to continuously repeat a single track or the entire disc.

### To Repeat A Single Track

Press the **REPEAT** button once. The **REPEAT** indicator flashes.

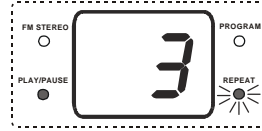

Press the **▶▶** or **◀◀** buttons to select the desired track. Press the **PLAY/PAUSE ▶||** button to begin Repeat Playback of the selected track.

### To Repeat The Entire Disc

Press the **REPEAT** button twice. The **REPEAT** indicator remains 'on'.

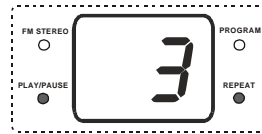

Press the **PLAY/PAUSE ▶||** button to begin Repeat Playback of the entire disc.

To cancel Repeat Playback press the **REPEAT** button until the **REPEAT** Indicator goes 'off'.

Repeat Playback is also canceled by pressing the **STOP ■** button, or setting to the **TUNER ■** position.



## PROGRAMMED Playback

This feature allows you to program up to **20** tracks on a disc for playback in any desired order.

**Note:** You cannot program tracks while a disc is playing. If the disc is playing press the **STOP** ■ button first before beginning the programming steps below:

- 1.) Press the **PROGRAM** button to enter the Program Mode. The **PROGRAM** indicator and Program Number '0' flash.

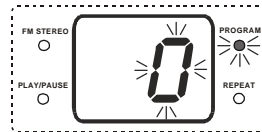

- 2.) Press the **SKIP** ►► or ◀◀ button to select the first track number you wish to enter in the program memory.

Example: Track Number 8.

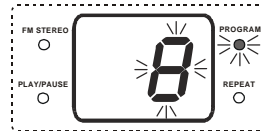

- 3.) When the desired track number appears on the display, press the **PROGRAM** button again to enter that track in memory.

The Program Number display returns to flashing "0".

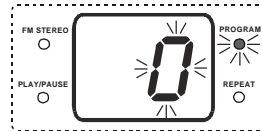

- 4.) Repeat Steps 2-3, selecting a different track number each time until you have entered up to 20 tracks in the program memory.

**Note:** You may program the same track number to play multiple times in the program sequence if desired. When programmed track is full, " -- " flashes in the display.

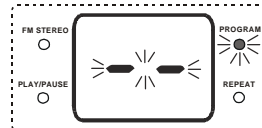

- 5.) Press the **PLAY/PAUSE** ►|| button to begin Programmed Playback. The **PROGRAM** indicator flashes. Playback will begin with the first track you programmed and will continue until the last programmed track has played.

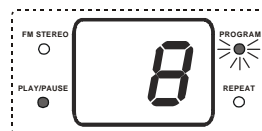



6.) After the last track has played the player stops and the display shows the total number of tracks on the disc. However the program sequence remains in the memory.

Press the **PROGRAM** button, then the **PLAY/PAUSE ►II** button to play the programmed sequence again.

7.) To cancel the programmed sequence from the memory press the **STOP ■** button while in programming mode.

The programmed sequence may also be canceled by removing the disc, changing function to **TUNER ■**, or shutting the system 'off'.

### Program Repeat Playback

You can use the Program and Repeat features together to continuously repeat a programmed sequence of tracks.

First, program the desired tracks according to Steps 1 through 5 on page 14.

When Programmed Playback begins press the **REPEAT** button twice to activate the All Tracks Repeat feature.

The **REPEAT** Indicator lights and all the tracks in your programmed sequence will be repeated continuously.

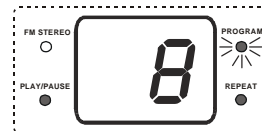

To cancel Programmed Repeat Playback press the **STOP ■** button until both the **PROGRAM** and **REPEAT** Indicators go 'Off'.

### RANDOM Playback

This feature allows you to play all the tracks on a disc in random order.

Load the disc as usual and wait until the display shows the total playing time and number of tracks.

Press the **RANDOM** button on front panel. The tracks will be played in random order. After all tracks have played the player stops and the display again shows the total playing time and number of tracks.

To cancel Random playback, press the **STOP ■** button.



## PHONES Jack

Connect a set of stereo headphones (not included) with a 3.5mm mini plug to the **PHONES** jack on front panel, for private listening without disturbing others.

Before putting on the headphones reduce the **VOLUME** control to a low level, then put the headphones on and gradually increase the **VOLUME** control to a comfortable listening level.

The speakers are automatically disconnected when headphones are connected to the **PHONES** jack.





## CARE AND MAINTENANCE

### COMPACT DISC CARE

- To remove a disc from its storage case, press down on the center of the case and lift the disc out, holding it carefully by the edges.

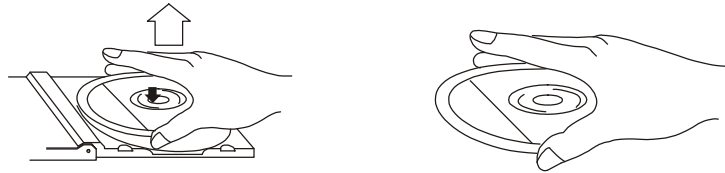

- Fingerprints and dust should be carefully wiped off the disc's recorded surface with a soft cloth. Unlike conventional records, compact discs have no grooves to collect dust and microscopic debris, so gently wiping with a soft cloth should remove most particles. Wipe in a straight line from the inside to the outside of the disc. Small dust particles and light stains will have absolutely no effect on reproduction quality.

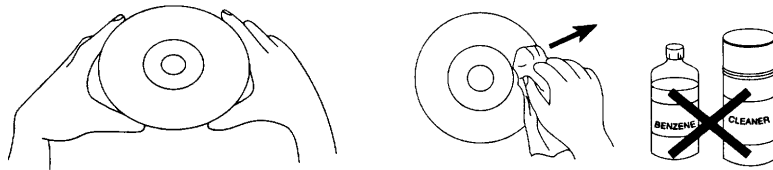

- Clean the disc periodically with a soft, lint-free, dry cloth. Never use detergents or abrasive cleaners to clean the disc. If necessary, use a CD cleaning kit.
- Never write on or affix labels to the surface of compact discs.

### CARE OF THE CABINET

If the cabinet becomes dusty wipe it with a soft dry dust cloth. Do not use any wax, polish sprays, or abrasive cleaners on the cabinet.

### CAUTION

Never allow any water or other liquids to get inside the unit while cleaning.

820-M31600050-J25