



www.johnsonhardware.com

INSTRUCTIONS

1718-1734-1738-1770 Series Folding Door Hardware

1718—1 1/8" doors to 35 lbs. each
 1734—3/4" doors to 35 lbs. each
 1738—1 3/8" doors to 35 lbs. each
 1770—3/4" doors to 40 lbs. each

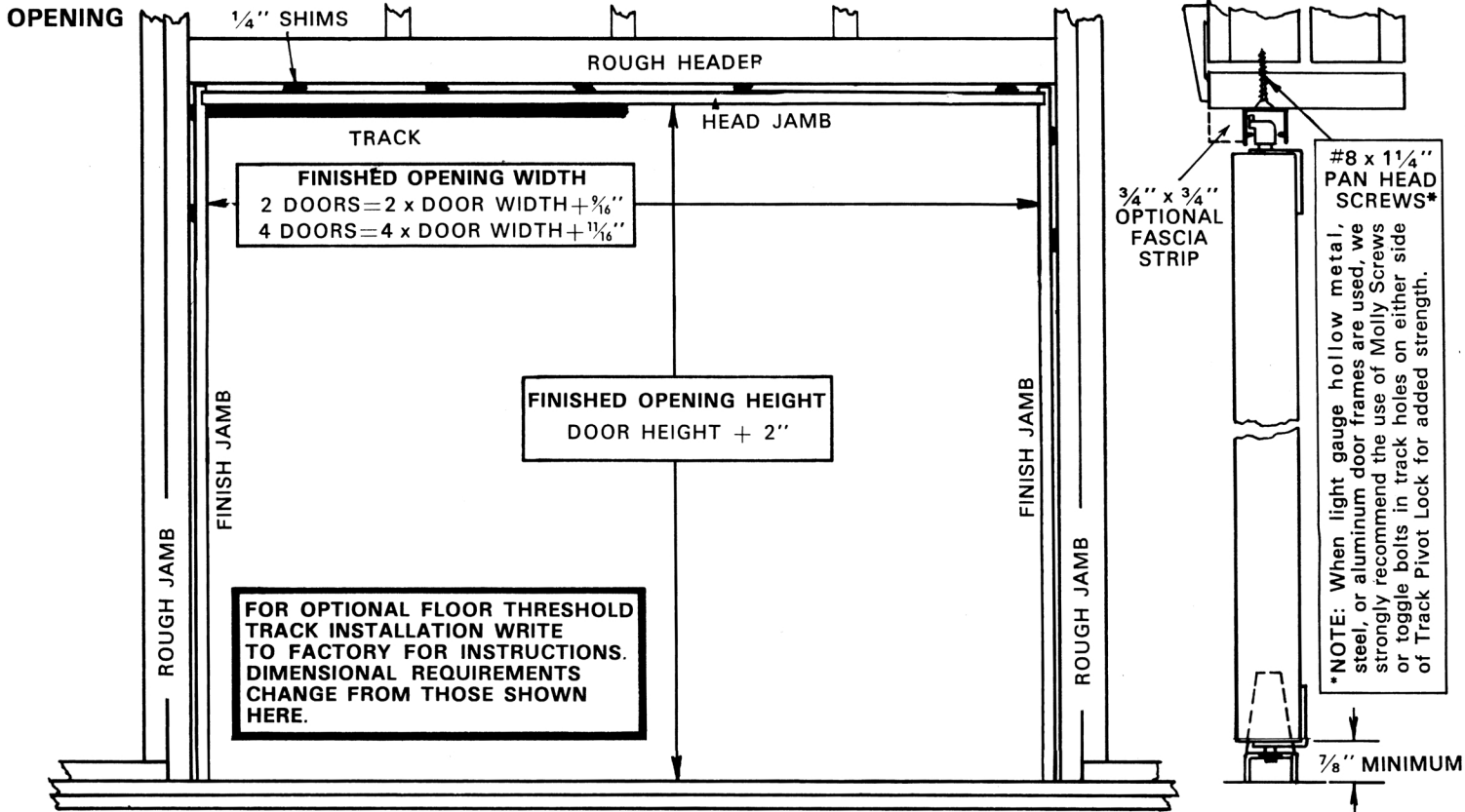

DOORS

FRONT SIDE

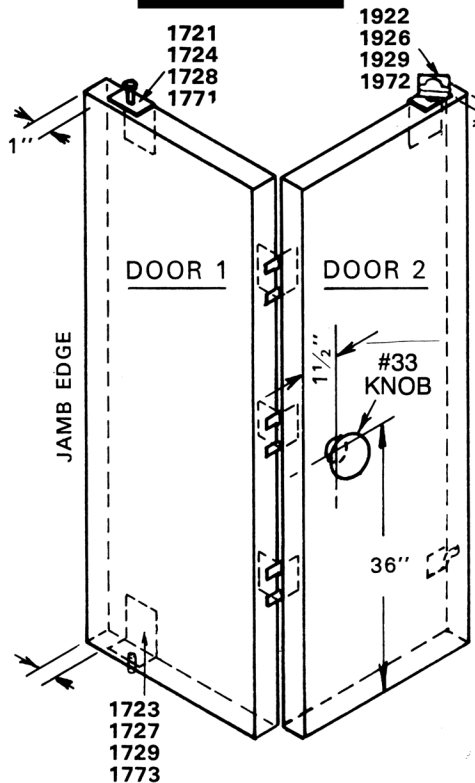

USE #8 x 5/8" SCREWS IN TOP OF SLOT ONLY UNTIL FINAL ADJUSTMENTS ARE MADE.

BACK SIDE

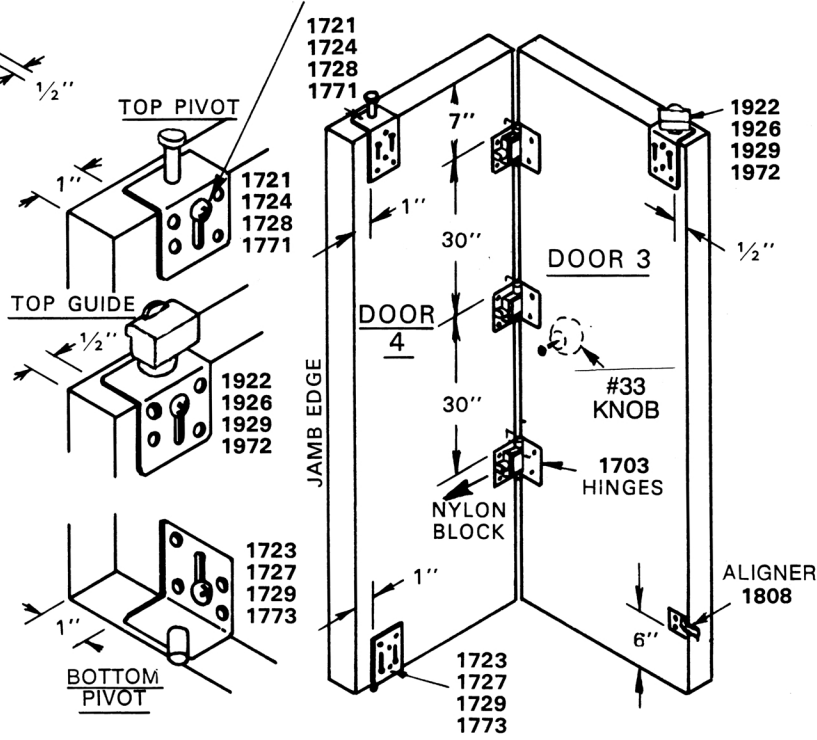

INSTALLATION OF 1700 SERIES SIDEMOUNTED FOLDING DOOR HARDWARE SETS

Measure door panels carefully and prepare finished opening accurately according to dimensions derived from formulas. Header and side jambs must be square, level and plumb for proper door operation and appearance.

SNUBBER — Install in track with rubber end facing intended pivot jamb. Slide to opposite end of track (2 DOOR SETS) from pivot lock. (4 door sets have two snubbers — one facing each direction and located in center of track).

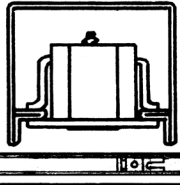

TRACK — Fasten track $\frac{3}{4}$ " from front edge of level head jamb, with pivot socket located on desired side. Use #8 x $1\frac{1}{4}$ " pan head screws. A $\frac{3}{4}$ " x $\frac{3}{4}$ " wood fascia strip, or quarter-round, may be placed at front edge of head jamb and track snugged against it.

HINGES — Lay doors GOOD SIDE DOWN, flat and even. Fasten #1703 hinges as shown on drawing with hinge fingers separating doors and long leg of nylon block pointing toward intended pivot jamb edge. Use #8 x $\frac{5}{8}$ " pan head screws.

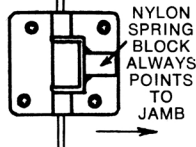

TOP PIVOT — Mount on back side of door #1

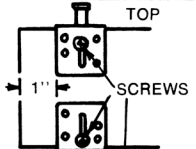

BOTTOM PIVOT — Mount on back side of doors directly below top pivot.

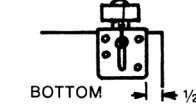

TOP GUIDE — Mount on back side of guide door (#2 and/or #3) $\frac{1}{2}$ " from edge of door.



ALIGNERS—(USED ON 4 DOOR SETS ONLY) Install on back side of doors #2 and #3 6" from bottom so that fingers mesh when doors are closed. Use #8 x $\frac{5}{8}$ " pan head screws.

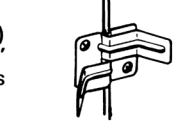

KNOB — On flush doors, drill $\frac{3}{16}$ " hole 36" from bottom and $1\frac{1}{2}$ " from hinge edge of #2 and/or #3 doors. On louvered doors, place to suit design. Fasten knob to front side of panel. For $1\frac{1}{8}$ " doors break off screw at groove.

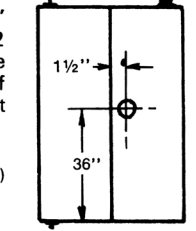

BREAK OFF FOR $1\frac{1}{8}$ " DOORS (SPECIAL SCREW FURNISHED FOR $\frac{3}{4}$ " DOORS)



HANG DOORS — Fold door pairs together and turn nylon guide block at right angles to door as shown. Tilt doors back at top and place guide block into track so that lip of block rests on ledge in track. Swing doors to vertical position and slip top pivot pin into track pivot socket. (Make sure pivot socket tab is in "unlocked" position to allow insertion of pin.) When pin is firmly seated, slide lock tab over top of pin.

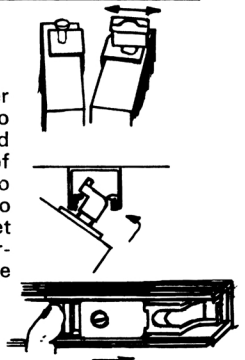

JAMB BRACKET — Place a mark on jamb at bottom edge of doors. Fold template as directed below and position on jamb. Use nail or punch to mark location of three holes for screws. Fasten jamb bracket to jamb with #8 x $1\frac{1}{4}$ " flat head screws. Press down on bracket pivot socket and position bottom door pivot pin over socket. Releasing socket locks onto pin.

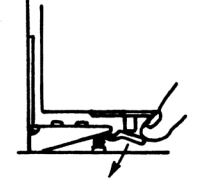

ALIGN DOORS — To maintain proper clearances ($\frac{1}{4}$ " at jamb, $\frac{1}{16}$ " between doors) it may be necessary to loosen and move track or jamb bracket pivot sockets. Use wrench provided. When doors are aligned and working smoothly, lock door pivots in place with screws in holes of plates.

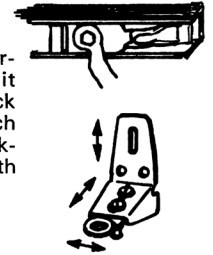

ADJUST SNUBBER — Close doors and slide snubber until rubber touched nylon guide block. Open doors and move snubber $\frac{1}{8}$ " nearer pivot jamb and tighten. Doors should "snap" shut yet open easily by a slight pull on the knob. Always open and shut doors with knob.

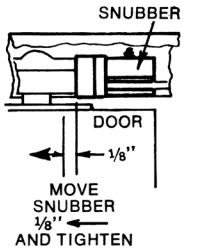

- #8 x $1\frac{1}{4}$ " PAN HEAD SCREW TRACK
- #8 x $1\frac{1}{4}$ " FLAT HEAD SCREW JAMB BRACKET
- #8 x $\frac{5}{8}$ " PAN HEAD SCREW HINGES, ALIGNER

OPTIONAL ACCESSORIES

- | | | |
|-------------------------------------|--|---|
| 1775
DOOR KEEPER | 1704
$\frac{3}{4}$ " FLOOR MOUNT BRACKET | 1714
$1\frac{1}{4}$ " FLOOR MOUNT BRACKET |
| 1606
NON MORTISE LIFT OFF HINGES | 1744
$\frac{3}{4}$ " DOUBLE FLOOR MOUNT BRACKET | 1754
$1\frac{1}{4}$ " DOUBLE FLOOR MOUNT BRACKET |

