

Digital Light Processing Projector

DLV-100

Instruction Manual

Integra

IMPORTANT INFORMATION



Precautions

Please read this manual carefully before using your Integra Projector DLV-100 and keep the manual handy for future reference.

Your serial number is located on the bottom of your DLV-100. Record it here:

CAUTION	
	To turn off main power, be sure to remove the plug from power outlet. The power outlet socket should be installed as near to the equipment as possible, and should be easily accessible.

CAUTION	
	TO PREVENT SHOCK, DO NOT OPEN THE CABINET. NO USER-SERVICEABLE PARTS INSIDE. REFER SERVICING TO QUALIFIED SERVICE PERSONNEL.

	This symbol warns the user that uninsulated voltage within the unit may be sufficient to cause electrical shock. Therefore, it is dangerous to make any kind of contact with any part inside of the unit.
	This symbol alerts the user that important information concerning the operation and maintenance of this unit has been provided. The information should be read carefully to avoid problems.

WARNING	
TO PREVENT FIRE OR SHOCK, DO NOT EXPOSE THIS UNIT TO RAIN OR MOISTURE. DO NOT USE THIS UNIT'S GROUNDED PLUG WITH AN EXTENSION CORD OR IN AN OUTLET UNLESS ALL THREE PRONGS CAN BE FULLY INSERTED. DO NOT OPEN THE CABINET. THERE ARE HIGH-VOLTAGE COMPONENTS INSIDE. ALL SERVICING MUST BE DONE BY QUALIFIED SERVICE PERSONNEL.	

DOC Compliance Notice

This Class B digital apparatus meets all requirements of the Canadian Interference-Causing Equipment Regulations.

RF Interference

WARNING
The Federal Communications Commission does not allow any modifications or changes to the unit EXCEPT those specified by Integra Technologies in this manual. Failure to comply with this government regulation could void your right to operate this equipment. This equipment has been tested and found to comply with the limits for a Class B digital device, pursuant to Part 15 of the FCC Rules. These limits are designed to provide reasonable protection against harmful interference in a residential installation. This equipment generates, uses, and can radiate radio frequency energy and, if not installed and used in accordance with the instructions, may cause harmful interference to radio communications. However, there is no guarantee that interference will not occur in a particular installation. If this equipment does cause harmful interference to radio or television reception, which can be determined by turning the equipment off and on, the user is encouraged to try to correct the interference by one or more of the following measures:
<ul style="list-style-type: none">• Reorient or relocate the receiving antenna.• Increase the separation between the equipment and receiver.• Connect the equipment into an outlet on a circuit different from that to which the receiver is connected.• Consult the dealer or an experienced radio / TV technician for help.

- IBM is a registered trademark of International Business Machines Corporation.
- Macintosh and PowerBook are registered trademarks of Apple Computer, Inc.
- Other product and company names mentioned in this instruction manual may be the trademarks of their respective holders.

Important Safeguards

These safety instructions are to ensure the long life of your projector and to prevent fire and shock. Please read them carefully and heed all warnings.

Installation

1. For best results, use your projector in a darkened room.
2. Place the projector on a flat, level surface in a dry area away from dust and moisture.
3. Do not place your projector in direct sunlight, near heaters or heat radiating appliances.
4. Exposure to direct sunlight, smoke or steam can harm internal components.
5. Handle your projector carefully. Dropping or jarring can damage internal components.
6. Do not place heavy objects on top of the projector.
7. **If you wish to have the projector installed on the ceiling:**
 - a. Do not attempt to install the projector yourself.
 - b. The projector must be installed by qualified technicians in order to ensure proper operation and reduce the risk of bodily injury.
 - c. In addition, the ceiling must be strong enough to support the projector and the installation must be in accordance with any local building codes.
 - d. Please consult your dealer for more information.

Power Supply

1. The projector is designed to operate on a power supply of 100-120 or 200-240 V 50/60 Hz AC. Ensure that your power supply fits this requirement before attempting to use your projector.
2. Handle the power cable carefully and avoid excessive bending. A damaged cord can cause electric shock or fire.
3. If the projector is not to be used for an extended period of time, disconnect the plug from the power outlet.

CAUTION

Do not unplug the power cable from the wall outlet under any one of the following circumstances. Doing so can cause damage to the projector:

- * While the Hour Glass icon appears.
- * While the message "Please wait a moment." appears. This message will be displayed after the projector is turned off.
- * Immediately after the power cable is plugged into the wall outlet (the POWER indicator has not changed to a steady orange glow).
- * Immediately after the cooling fan stops working (The cooling fan continues to work for 90 seconds after the projector is turned off with the POWER button).
- * While the POWER and the STATUS indicators are alternately flashing.

Cleaning

1. Unplug the projector before cleaning.
2. Clean the cabinet periodically with a damp cloth. If heavily soiled, use a mild detergent. Never use strong detergents or solvents such as alcohol or thinner.
3. Use a blower or lens paper to clean the lens, and be careful not to scratch or mar the lens.

Lamp Replacement

- To replace the lamp, follow all instructions provided on page 44.
- Be sure to replace the lamp when the message "**The lamp has reached the end of its usable life. Please replace the lamp.!!**" appears. If you continue to use the lamp after the lamp has reached the end of its usable life, the lamp bulb may shatter, and pieces of glass may be scattered in the lamp case. Do not touch them as the pieces of glass may cause injury. If this happens, contact your Integra dealer for lamp replacement.
- Allow a minimum of 90 seconds to elapse after turning off the projector. Then disconnect the power cable and allow 60 minutes to cool the projector before replacing the lamp.

Fire and Shock Precautions

1. Ensure that there is sufficient ventilation and that vents are unobstructed to prevent the build-up of heat inside your projector. Allow at least 3 inches (10 cm) of space between your projector and a wall.
 2. Prevent foreign objects such as paper clips and bits of paper from falling into your projector. Do not attempt to retrieve any objects that might fall into your projector. Do not insert any metal objects such as a wire or screwdriver into your projector. If something should fall into your projector, disconnect it immediately and have the object removed by a qualified Integra service personnel.
 3. Do not place any liquids on top of your projector.
- Do not look into the lens while the projector is on. Serious damage to your eyes could result.
 - Keep any items such as magnifying glass out of the light path of the projector. The light being projected from the lens is extensive, therefore any kind of abnormal objects that can redirect light coming out of the lens, can cause unpredictable outcome such as fire or injury to the eyes.
 - Do not cover the lens with the supplied lens cap or equivalent while the projector is on. Doing so can lead to melting of the cap and possibly burning your hands due to the heat emitted from the light output.

TABLE OF CONTENTS

1. INTRODUCTION	
Introduction to the Projector DLV-100	6
Getting Started	6
What's in the Box	7
Getting to Know Your Projector DLV-100	8
Front / Side Features	8
Attaching the lens cap	8
Rear / Side Features	9
Top Features	10
Terminal Panel Features	11
Remote Control Features	12
Remote Control Battery Installation	13
Operating Range	13
Remote Control Precautions	13
2. INSTALLATION	
Setting Up Your Projector	14
Selecting a Location	14
Screen and Projection Distance	14
Distance Chart	15
Reflecting the Image	15
Wiring Diagram	16
Connecting Your PC	17
Connecting Your Macintosh Computer	18
Connecting Your DVD Player	19
Connecting Your VCR or Laser Disc Player	20
About Startup screen (Menu Language Select screen)	21
3. OPERATION	
Connecting the Power Cable and Turn on the Projector	22
Basic Operation	25
Using the Menus	27
Menu Tree	29
Menu Elements	30
Menu Descriptions & Functions	31
Source Select	31
RGB/Video/S-Video/PC Card Viewer	
Picture	31
Brightness/Contrast/Color/Hue/Sharpness	
Volume	31
Image Options	32
Keystone	32
Lamp Mode	32
Aspect Ratio	32
Noise Reduction	33
Position/Clock	33
Resolution	33
Video Filter	33
Factory Default	33
Color Management	34
Gamma Correction	34
Color Matrix	34
White Balance	34
Projector Options	34
Menu	34
Menu Mode	35
Advanced Menu, Basic/Custom Menu	35
Language	35
Projector Pointer	35
Menu Display Time	35
Source Display	35
Direct Button (Volume Bar)	35
Setup	35
Orientation	35
Cinema position	35
Background	35
Mouse	36
Button/Sensitivity	36
PC Card Viewer Options	36
Capture Options	36
Signal Select	36
Auto Adjust (RGB only)	36
Auto Start	37
Power Management	37
Power Off Confirmation	37
Keystone Save	37
White Segment	37
Clear Lamp Hour Meter	37
Communication Speed	37
Default Source Select	37
Control Panel Key Lock	37
Tools	38
Capture	38
PC Card Files	38
Changing Background Logo	38
Chalk Board	39
Information	39
Using the PC Card Viewer Function	40
Features	40
Inserting and Ejecting a CompactFlash™ Card	40
Operating the PC Card Viewer Function	
from the Projector (playback)	41
Capturing Images Displayed on the Projector	42
Viewing Digital Images	42
Terminology	43
4. MAINTENANCE	
Replacing the Lamp	44
5. TROUBLESHOOTING	
Status Light Messages	45
Common Problems & Solutions	45
When using the PC Card Viewer function	46
6. SPECIFICATIONS	
Optical/Electrical/Mechanical	47
Cabinet Dimensions	48
D-Sub Pin Assignments	49
Timing Chart	50
PC Control Codes	51
Cable Connection	51

CompactFlash is a trademark of San Disk Corporation.

1. INTRODUCTION

Introduction to the Projector DLV-100

This section introduces you to your new Projector and describes the features and controls.

Congratulations on Your Purchase of The Projector DLV-100

The DLV-100 is one of the very best projectors available today. The DLV-100 enables you to project precise images up to 200 inches across (measured diagonally) from your PC or Macintosh computer (desktop or notebook), VCR, DVD player, document camera, a laser disc player or PC Card Viewer.

You can use the projector on a tabletop or cart, you can use the projector to project images from behind the screen, and the projector can be permanently mounted on a ceiling*¹. The remote control can be used wirelessly.

Features you'll enjoy:

- Simple set up and operation.
- A high-performance 135 watt NSH lamp.
- The supplied wireless remote control that operates the projector from the front or rear.
- The image can be projected between 30 and 200 inches (measured diagonally).
- Keystone correction allows you to correct trapezoidal distortion so that the image is square.
- You can choose between video modes depending on your source: "normal" for a typical picture, "natural" for true color reproduction.
- The built-in PC Card Viewer allows you to start your presentation even when a PC is not available at the site.
- The "Capture" enables you to capture the current projected image.
- An image can be projected from in front or behind a screen, and the projector can even be installed on the ceiling.
- An exclusive Advanced AccuBlend intelligent pixel blending technology - an extremely accurate image compression technology - offers a crisp image with UXGA (1600×1200) resolution*².
- Supports most IBM VGA, SVGA, XGA, SXGA/UXGA (with Advanced AccuBlend)*², Macintosh, component signal (YCbCr /YPbPr) or any other RGB signals within a horizontal frequency range of 15 to 100 kHz and a vertical frequency range of 50 to 120 Hz. This includes NTSC, PAL, PAL-N, PAL-M, PAL60, SECAM and NTSC4.43 standard video signals.

NOTE: Composite video standards are as follows:

NTSC: U.S. TV standard for video in U.S. and Canada.

PAL: TV standard used in Western Europe.

PAL-N: TV standard used in Argentine, Paraguay and Uruguay.

PAL-M: TV standard used in Brazil.

PAL60: TV standard used for NTSC playback on PAL TVs.

SECAM: TV standard used in France and Eastern Europe.

NTSC4.43: TV standard used in Middle East countries.

- The supplied remote control can be used without a cable.
- You can control the projector with a PC using the PC Control port.
- USB terminal allows USB mouse operation*³.
- The contemporary cabinet design is light, compact, easy to carry, and complements any office, boardroom or auditorium.

*1 Do not attempt to mount the projector on a ceiling yourself.

The projector must be installed by qualified technicians in order to ensure proper operation and reduce the risk of bodily injury. In addition, the ceiling must be strong enough to support the projector and the installation must be in accordance with any local building codes. Please consult your dealer for more information.

*2 A UXGA (1600×1200) and SXGA image (1280×1024) are displayed.

*3 The USB terminal meets the USB1.1 specification and accepts a USB mouse only.

Getting Started

The fastest way to get started is to take your time and do everything right the first time. Take a few minutes now to review the instruction manual. This may save you time later on. At the beginning of each section of the manual you'll find an overview. If the section doesn't apply, you can skip it.

What's in the Box?

Make sure your box contains everything listed. If any pieces are missing, contact your dealer.
Please save the original box and packing materials if you ever need to ship your Projector DLV-100.

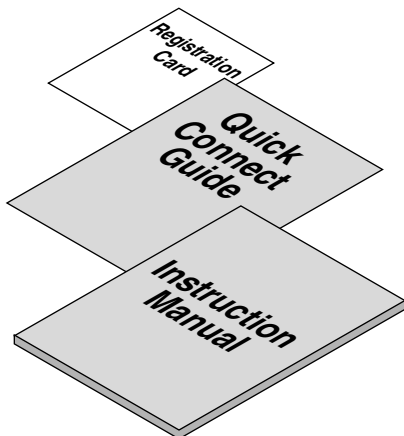
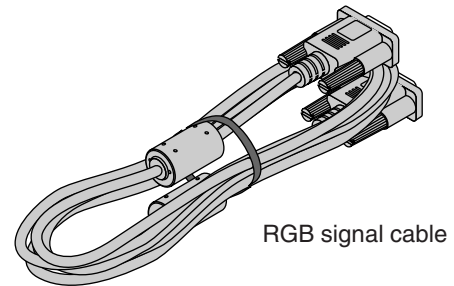
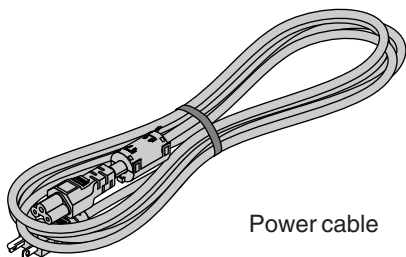
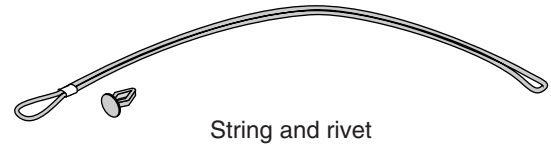
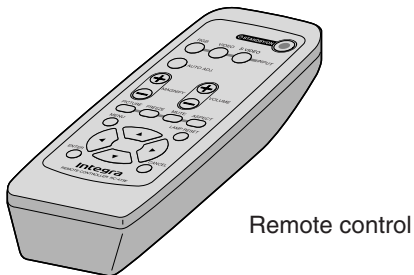
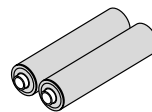
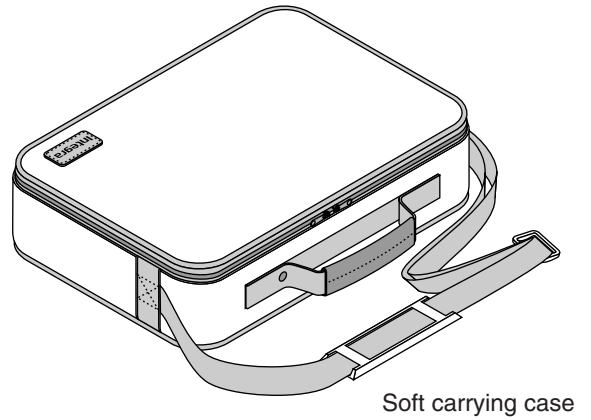
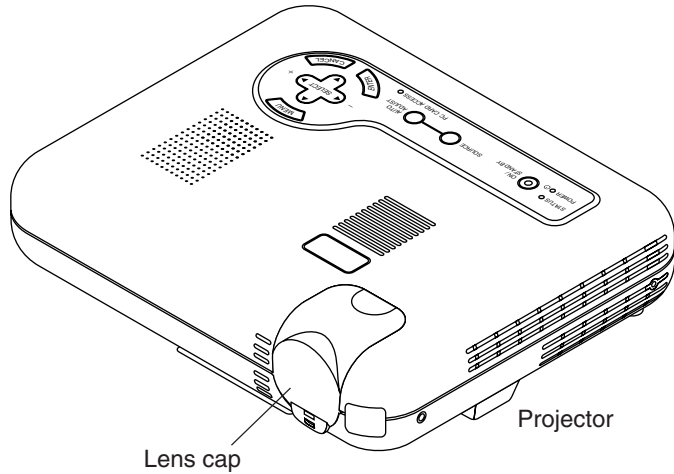

Getting to Know Your Projector DLV-100

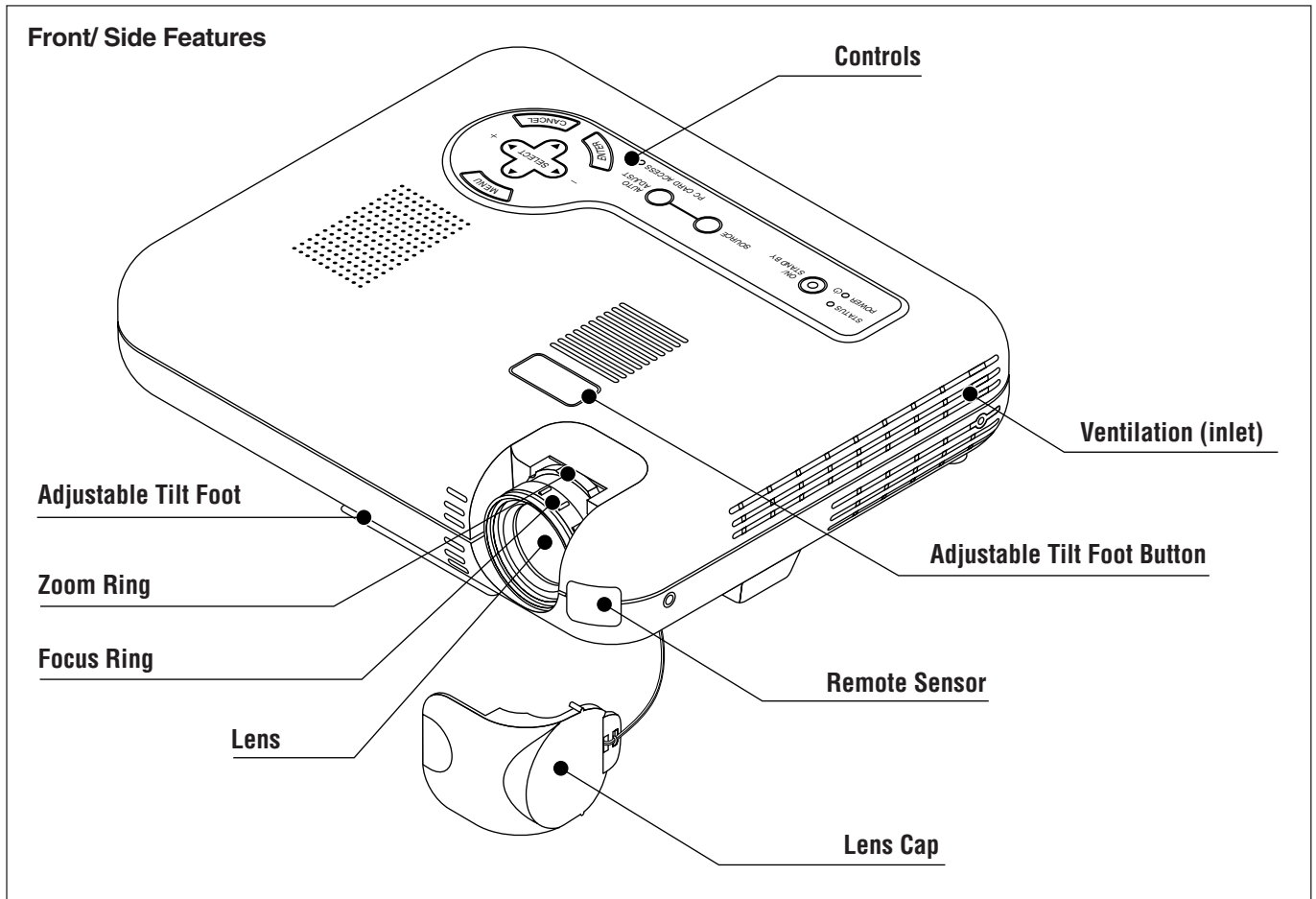

Attaching the lens cap to the lens hood with the supplied string and rivet

1. Thread the string through the hole on the lens cap and then tie a knot in the string.
2. Use the rivet to attach the string to the bottom of the lens hood.

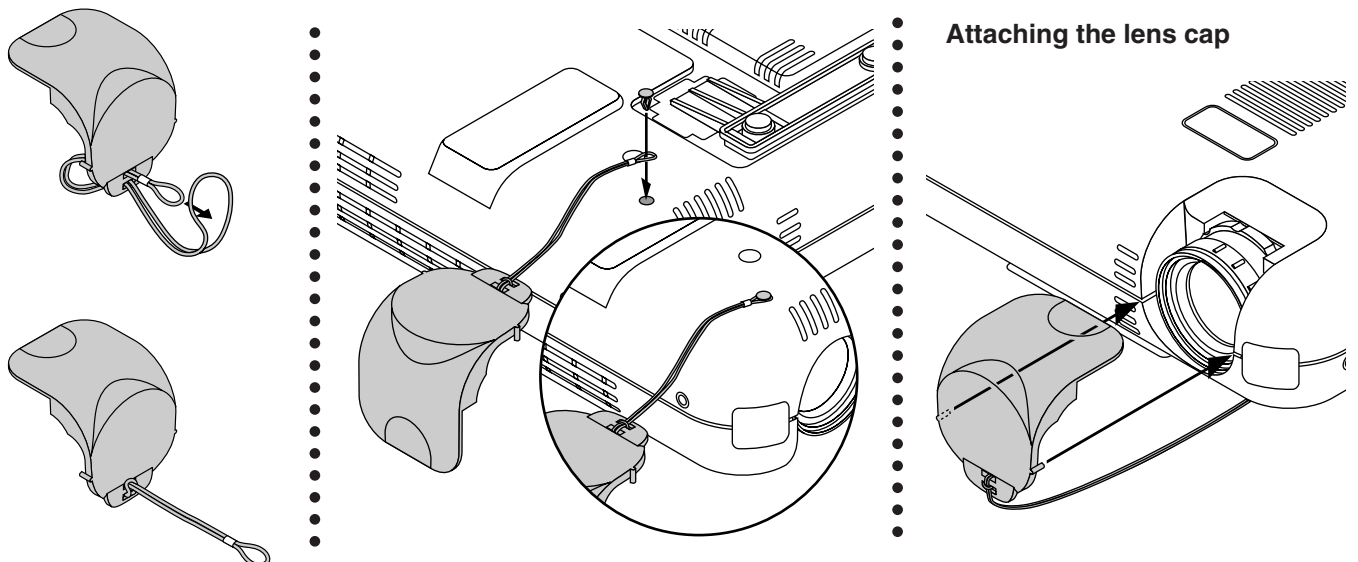

Rear/ Side Features

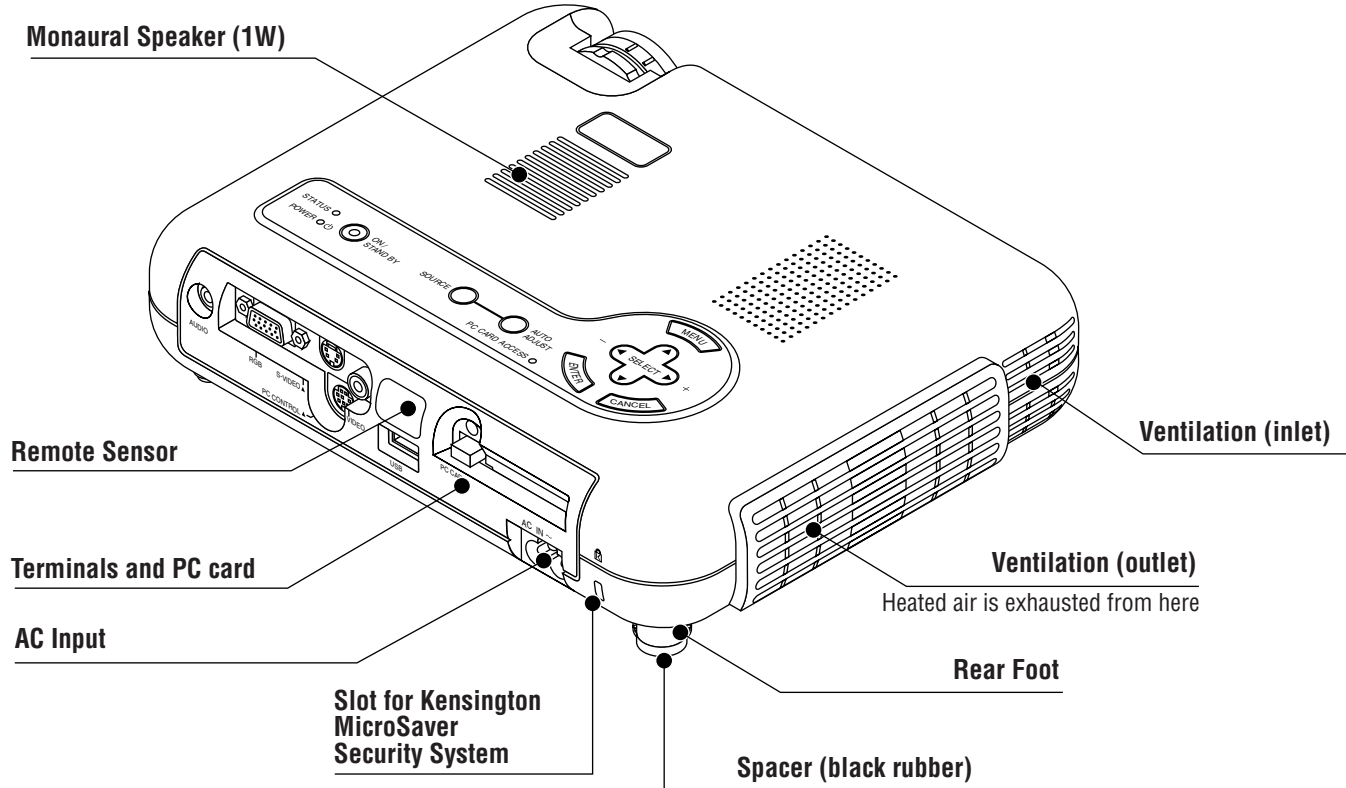

Bottom

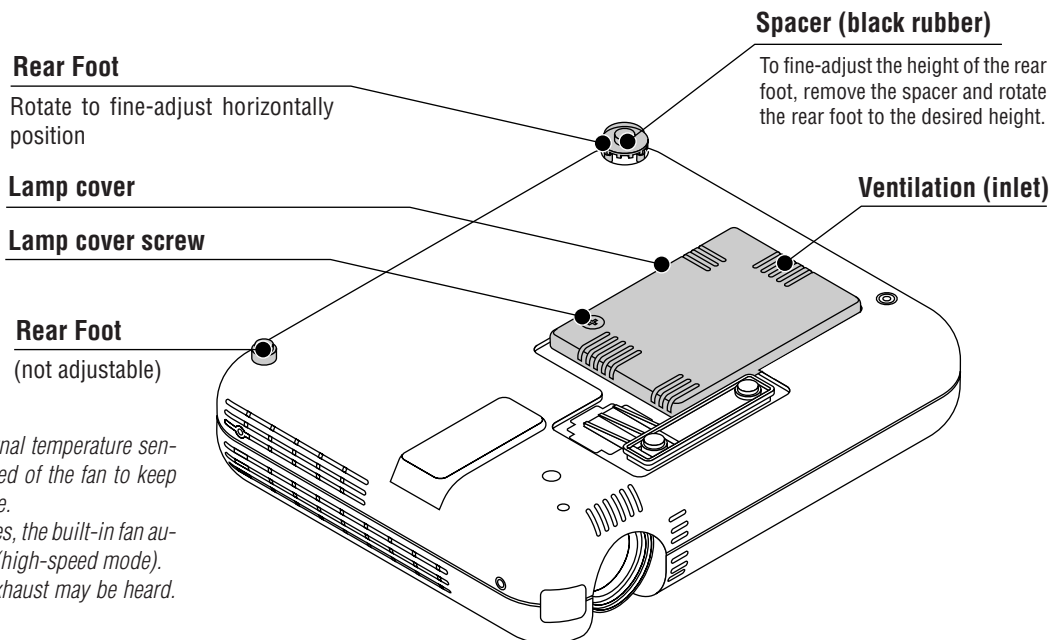

Top Features

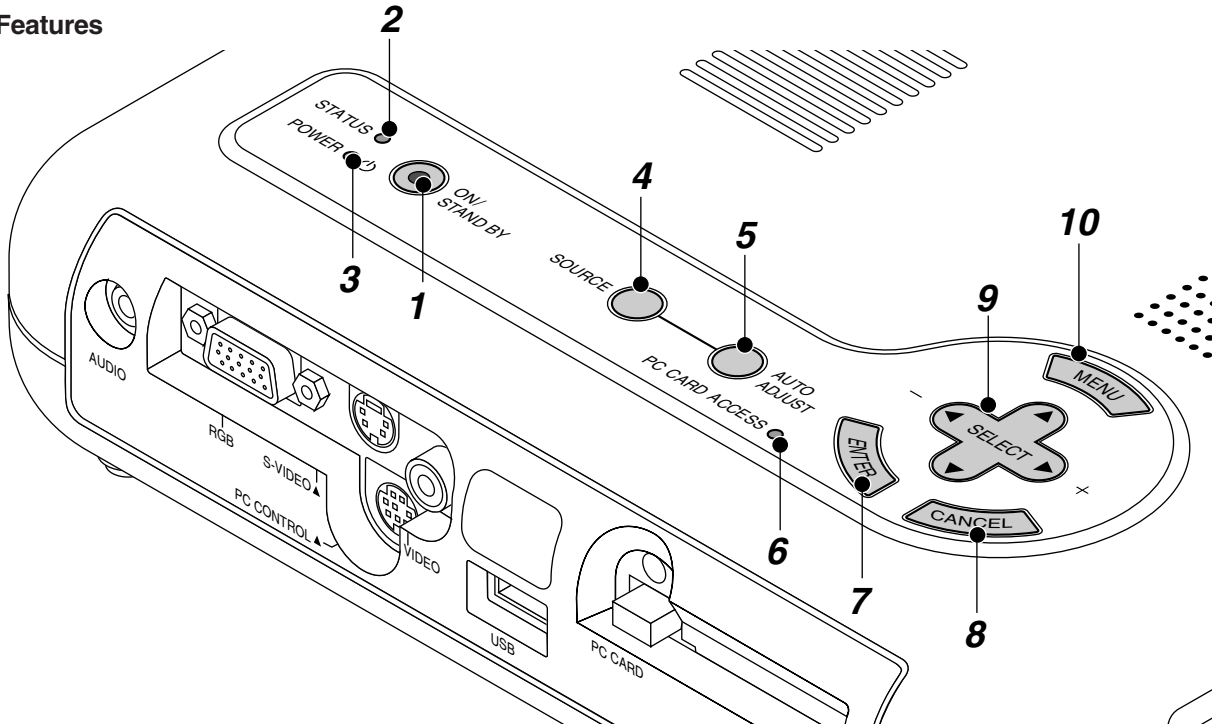

1. Power Button (ON / STAND BY)

Use this button to turn the power on and off when the power is supplied and the projector is in standby mode.

2. Status Indicator

When this is lit red continually, it's warning you that the projection lamp has exceeded 1500 hours (1000 hours in High-Bright mode) of service. After this light appears, it is advisable to replace the projection lamp as soon as possible. (See page 44). In addition the message **"The lamp has reached the end of its usable life. Please replace the lamp!!."** appears continually until the lamp is replaced. If this light blinks red rapidly, it indicates that the lamp cover is not attached properly or the projector is overheated. See the Power/Status Light Messages on page 45 for more details.

3. Power Indicator (⏻)

When this indicator is green, the projector is on; when the indicator is orange, it is in standby mode.

4. Source Button

Use this button to select a video source such as a PC, VCR, DVD player or PC Card Viewer (CompactFlash card). Each time this button is pressed, the input source will change as follows:

→ RGB → Video → S-Video → PC Card Viewer →

If no input signal is present, the input will be skipped.

5. Auto Adjust Button (RGB only)

Use this button to adjust Position-H/V and Pixel Clock/Phase for an optimal picture. Some signals may not be displayed correctly or take time to switch between sources.

6. PC Card Access Indicator

Lights while accessing a CompactFlash memory card.

7. Enter Button

Executes your menu selection and activates items selected from the menu.

8. Cancel Button

Press this button to exit "Menus". Press this button to return the adjustments to the last condition while you are in the adjustment or setting menu.

9. Select (▲▼◀▶) / Volume (+) (-) Buttons

▲▼: Use these buttons to select the menu of the item you wish to adjust.

When no menus appear, these buttons work as a volume control.

◀▶: Use these buttons to change the level of a selected menu item.

A press of the ▶ button executes the selection.

When the menus or the Viewer tool bar is not displayed, these buttons can be used to select a slide, or to move the cursor in Folder List or Slide List.

When the magnifying glass is displayed, these ▲▼◀▶ buttons move the magnifying glass.

10. Menu Button

Displays the menu.

Terminal Panel Features

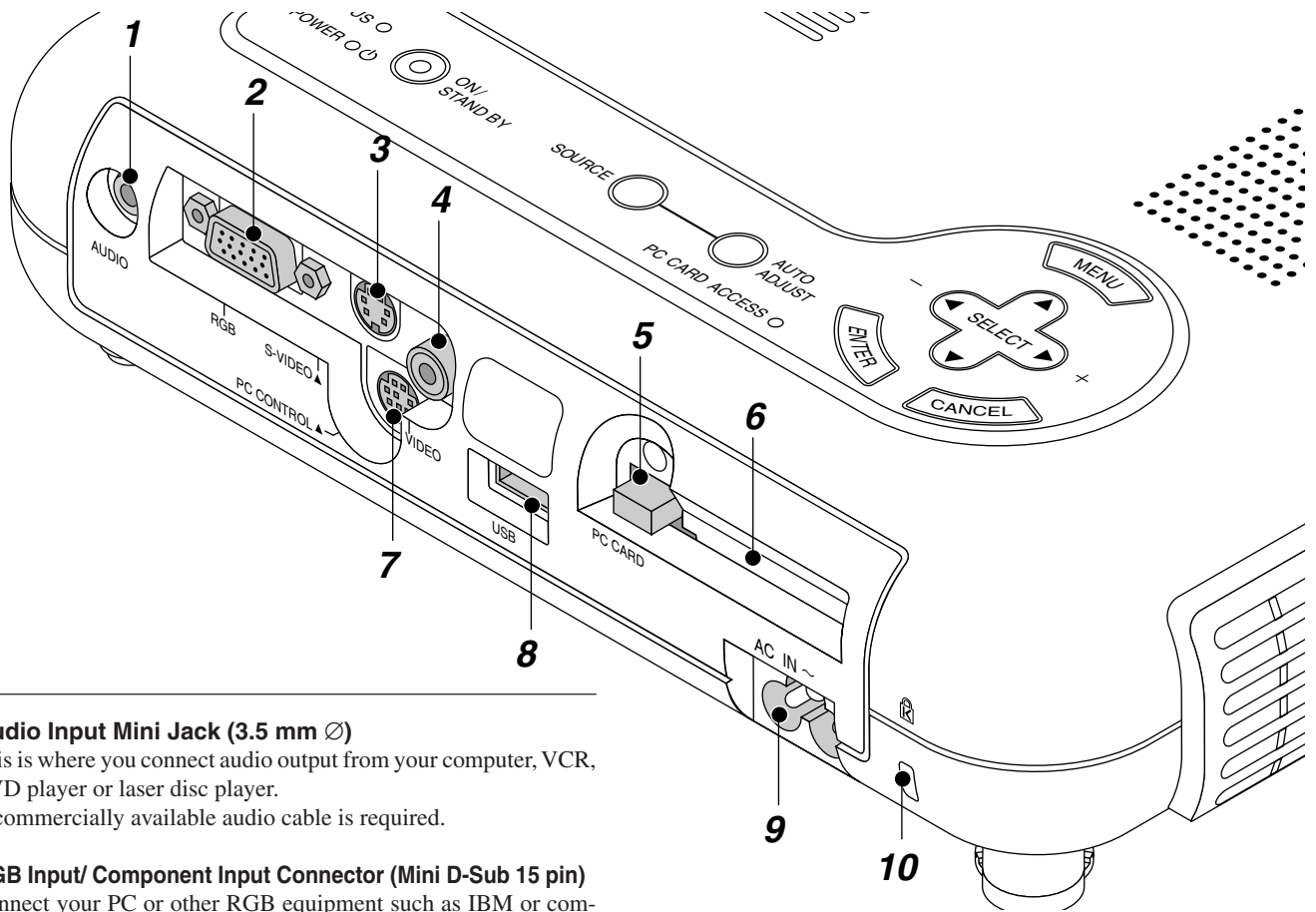

1. Audio Input Mini Jack (3.5 mm Ø)

This is where you connect audio output from your computer, VCR, DVD player or laser disc player. A commercially available audio cable is required.

2. RGB Input/ Component Input Connector (Mini D-Sub 15 pin)

Connect your PC or other RGB equipment such as IBM or compatible computers. Use the supplied RGB cable to connect to a PC. Or connect a Macintosh computer here using the supplied RGB cable. This also serves as a component input connector that allows you to connect a component video output of component equipment such as a DVD player.

3. S-Video Input (Mini DIN 4 Pin)

Here is where you connect the S-Video input from an external source like a VCR.

NOTE: S-Video provides more vivid color and higher resolution than the traditional composite video format.

4. Video Input (RCA)

Connect a VCR, DVD player, laser disc player, or document camera here to project video.

5. PC Card Eject Button

Press to eject a CompactFlash memory card.

6. PC Card Slot

Insert a CompactFlash memory card here.

7. PC Control Port (Mini DIN 8 Pin)

Use this port to connect your PC to control your projector via a serial cable. This enables you to use your PC and serial communication protocol to control the projector.

If you are writing your own program, typical PC control codes are on the back cover page.

A cap is put on the port at the factory. Remove the cap when using the port.

8. USB Terminal

Connect a commercially available mouse that supports USB. You can operate the menu or PC Card Viewer with the USB mouse via this terminal.

Note that this terminal is not used with a computer and that there may be some brands of USB mouse that the projector does not support.

9. AC Input

Connect the supplied power cable's three-pin plug here. When you plug the other end into an active wall outlet, the POWER indicator turns orange and the projector is in standby mode.

10. Built-in Security Slot (K)

This security slot supports the MicroSaver® Security System. MicroSaver® is a registered trademark of Kensington Microware Inc.

The logo is trademarked and owned by Kensington Microware Inc.

Remote Control Features

1. Infrared Transmitter

Direct the remote control toward the remote sensor on the projector cabinet.

2. Standby/On Button

If the main power is applied, you can use this button to turn your projector on or put it in standby.

3. S-Video Button

Press this button to select an S-Video source from a VCR.

4. Video Button

Press this button to select an NTSC, PAL, SECAM or NTSC4.43 compatible video source from a VCR, DVD player, laser disc player or document camera.

5. RGB Button

Press this button to select a video source from computer or component equipment connected to your RGB port.

6. Auto Adjust Button

Use this button to adjust an RGB source for an optimal picture. Some signals may not be displayed correctly or take time to switch between sources.

7. Magnify \oplus \ominus Buttons

Use this button to adjust the image size up to 400%. To change the position of the magnified screen, press one of the \blacktriangle \blacktriangledown \blacktriangleleft \blacktriangleright buttons to recall the magnifying glass, then use the \blacktriangle \blacktriangledown \blacktriangleleft \blacktriangleright buttons to move the screen.

8. Volume \oplus \ominus Buttons

Press \oplus button to increase the volume and \ominus button to decrease it.

9. ASPECT Button

Press this button to select the screen size.

10. Mute Button

This button turns off an image and sound for a short period of time. Press again to restore the image and sound.

NOTE: When the menu is displayed, a press of this button mutes an image and sound without turning off the menu.

11. PICTURE Button

Press this button to recall and display the screen-related menu.

12. Freeze Button

This button will freeze a picture. Press again to resume motion.

13. Menu Button

Displays the menu for various settings and adjustments.

14. LAMP RESET Button

If the lamp has been turned on for more than 1,600 hours (Normal mode), the power to the unit will be cut off and no messages will be displayed. Press and hold down this button for 10 seconds or more while the unit is in stand-by mode to clear the lamp available time and the lamp usage time.

Supplied Remote Control

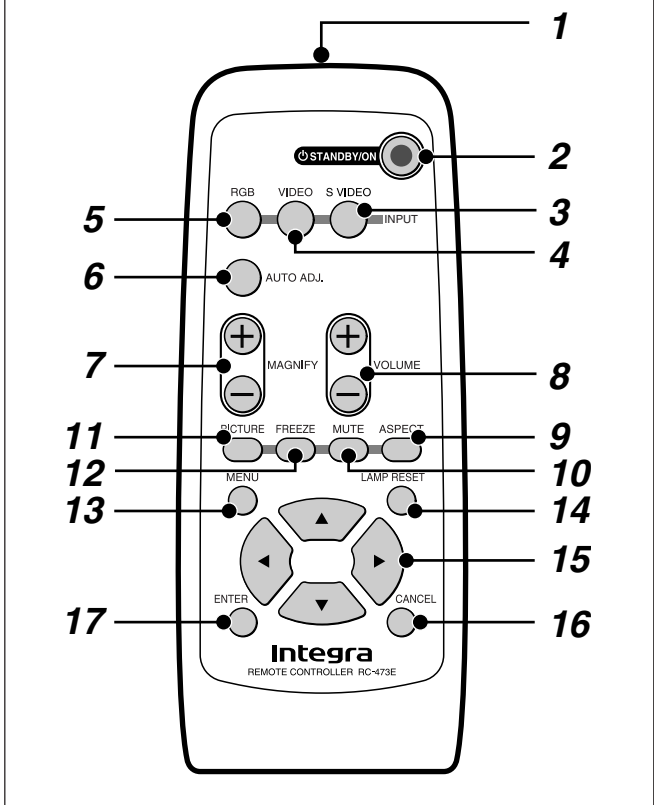

15. \blacktriangle \blacktriangledown \blacktriangleleft \blacktriangleright (Select) Buttons

\blacktriangle , \blacktriangledown : Use these buttons to select the menu of the item you wish to adjust.

\blacktriangleleft , \blacktriangleright : Use these buttons to change the level of a selected menu item.

A press of the \blacktriangleright button executes the selection.

When the magnifying glass is displayed, these \blacktriangle \blacktriangledown \blacktriangleleft \blacktriangleright buttons move the magnifying glass.

16. Cancel Button

Press this button to exit "Menus". Press this button to return to the previous menu without storing the current settings or adjustments when you are in the submenu or adjustment screen.

17. Enter Button

Press this button to execute the selected item. When this is pressed, the adjustments and settings are saved, and the display is returned to the menu.

Operating Range

The infrared signal operates by line-of-sight up to a distance of approximately 22 feet (7m) and within a 60-degree angle of the remote sensor. The projector will not function if there are objects between the remote control and the remote sensor on the projector or if strong light falls on the remote sensor. A weak battery will also prevent the projector from operating

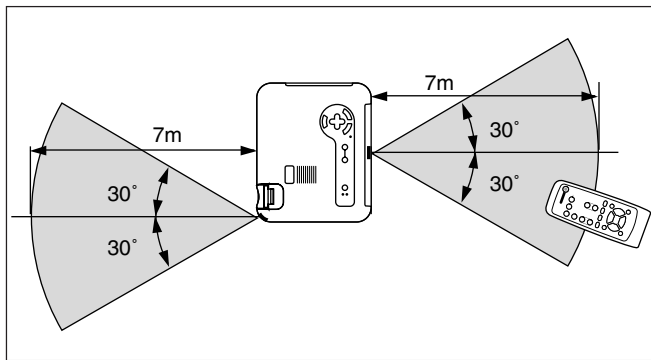

This sample may be slightly different from actual range

Remote Control Battery Installation

- 1** Remove the battery compartment cover by pressing the tab and lifting up the cover.

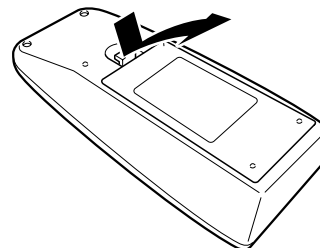

- 2** Insert two AA-size batteries into the battery compartment. Carefully follow the polarity diagram (positive ⊕ and negative ⊖ symbols) inside the battery compartment.

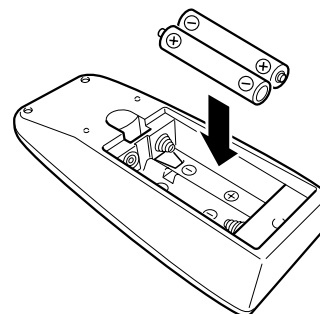

- 3** Replace the compartment cover.

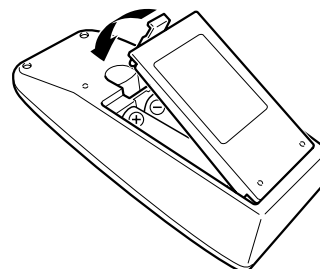

Do not mix different types of batteries or new and old batteries.

Remote Control Precautions

- Handle the remote control carefully.
- If the remote control gets wet, wipe it dry immediately.
- Avoid excessive heat and humidity.
- If you will not be using the remote control for a long time, remove the batteries.
- Do not place the batteries upside-down.

2. INSTALLATION

This section describes how to set up your projector DLV-100 and how to connect video and audio sources.

Setting up Your Projector

Your Projector DLV-100 is simple to set up and use. But before you get started, you must first:

1. Determine the image size.
 2. Set up a screen or select a non-glossy white wall onto which you can project your image.
- Ensure that the power cable and any other cables connecting to video sources are disconnected before moving the projector. When moving the projector or when it is not in use, cover the lens with the lens cap.

Selecting a Location

The further your projector is from the screen or wall, the larger the image. The minimum size the image can be is approximately 30" (0.8 m) measured diagonally when the projector is roughly 4 feet (1.3 m) from the wall or screen. The largest the image can be is 200" (5.1 m) when the projector is about 29 feet (8.8 m) from the wall or screen.

Screen and Projection Distance

The following shows the proper relative positions of the projector and screen. Refer to the table to determine the position of installation.

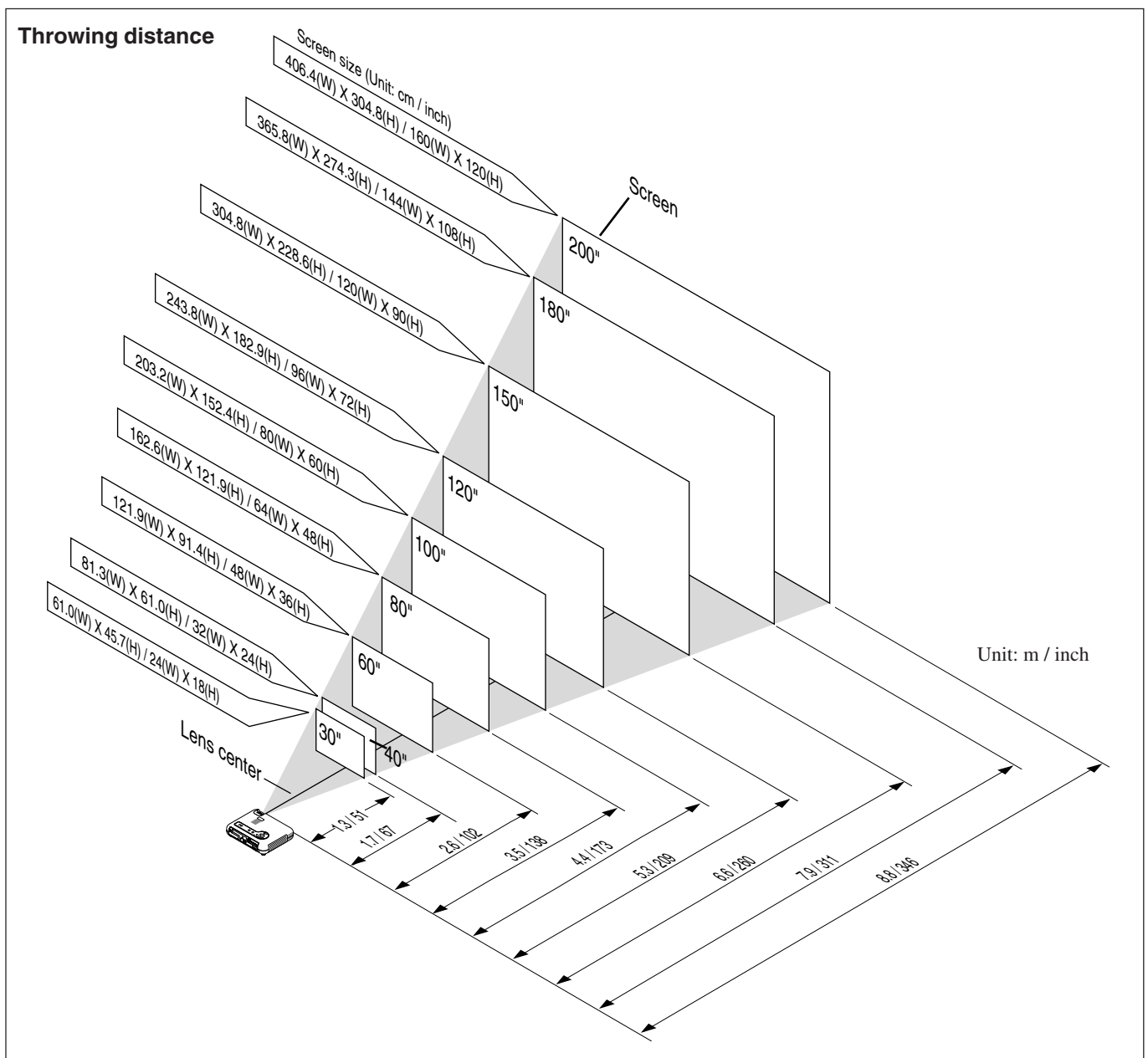

Distance Chart

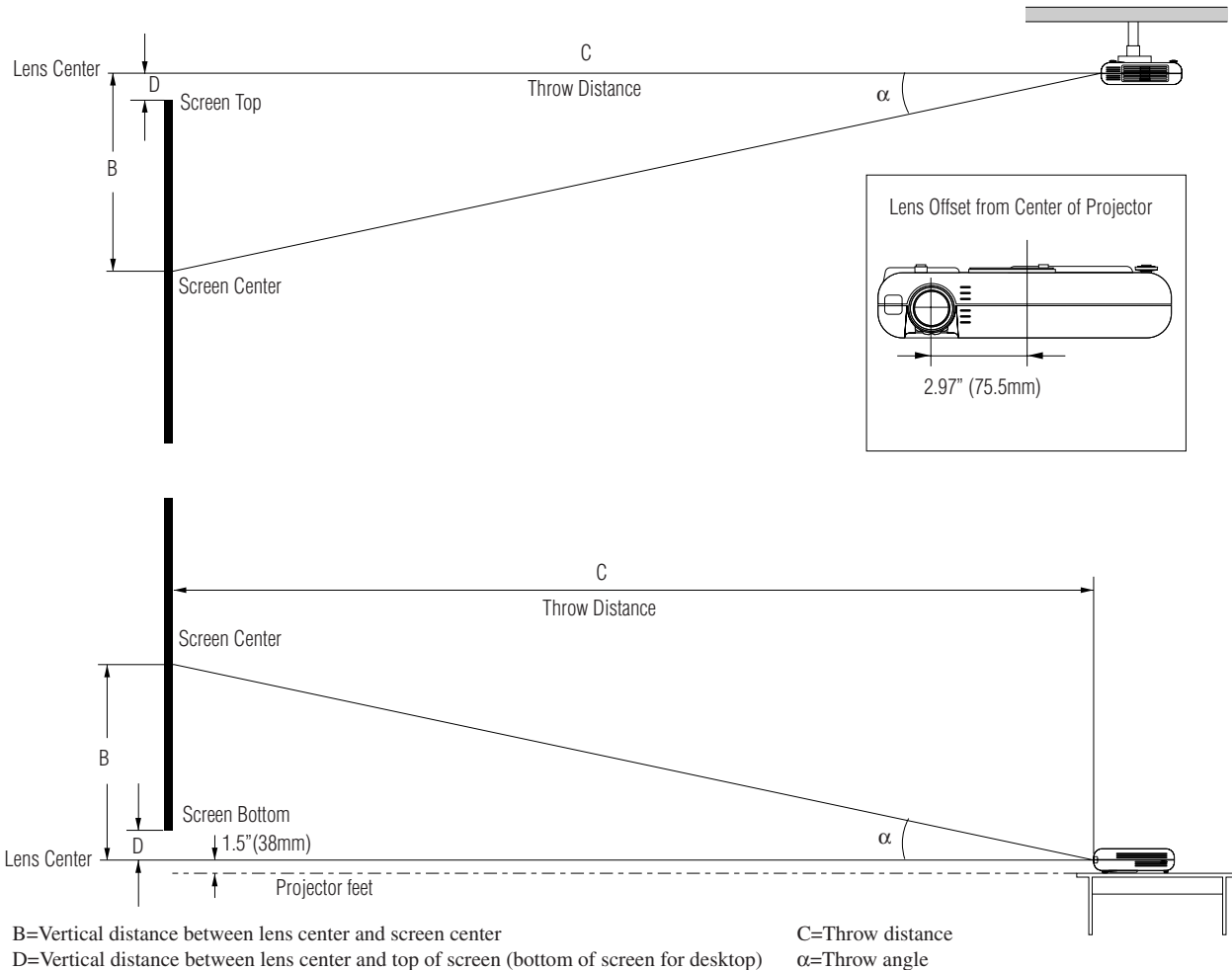

NOTE: Distances may vary +/-5%.

Screen Size			B	C		D	α	
Diagonal	Width	Height		Wide	Tele		Wide	Tele
30	762	24 610	18 457	12 307	46 1160	56 1410	3 78	14.8 - 12.3
40	1016	32 813	24 610	16 409	61 1560	75 1900	4 104	14.7 - 12.1
60	1524	48 1219	36 914	24 613	93 2360	113 2870	6 156	14.6 - 12.1
67	1702	54 1361	40 1021	27 685	104 2640	126 3210	7 174	14.5 - 12.0
72	1829	58 1463	43 1097	29 736	112 2850	136 3450	7 187	14.5 - 12.0
80	2032	64 1626	48 1219	32 818	125 3170	151 3840	8 208	14.5 - 12.0
84	2134	67 1707	50 1280	34 859	131 3330	159 4040	9 219	14.5 - 12.0
90	2286	72 1829	54 1372	36 920	141 3570	170 4330	9 234	14.5 - 12.0
100	2540	80 2032	60 1524	40 1022	156 3970	189 4810	10 260	14.4 - 12.0
120	3048	96 2438	72 1829	48 1227	188 4770	228 5790	12 312	14.4 - 12.0
150	3810	120 3048	90 2286	60 1533	235 5980	285 7240	15 390	14.4 - 12.0
180	4572	144 3658	108 2743	72 1840	283 7190	343 8700	18 469	14.4 - 11.9
200	5080	160 4064	120 3048	80 2045	315 7990	381 9670	20 521	14.4 - 11.9

Ceiling Installation

WARNING

- * Do not attempt to install the projector yourself.
- Only use your projector on a solid, level surface. If the projector falls to the ground, you can be injured and the projector severely damaged.
- Do not use the projector where temperatures vary greatly. The projector must be used at temperatures between 41°F (5°C) and 95°F (35°C).
- Do not expose the projector to moisture, dust, or smoke. This will harm the screen image.
- Ensure that you have adequate ventilation around your projector so heat can dissipate. Do not cover the vents on the side or the front of the projector.

Reflecting the Image

Using a mirror to reflect your projector's image enables you to enjoy a much larger image. Contact your Integra dealer if you need a mirror. If you're using a mirror and your image is inverted, use the "Menu" and "Select" buttons on your projector cabinet or ▲▼ buttons on your remote control to correct the orientation. (See page 35.)

Wiring Diagram

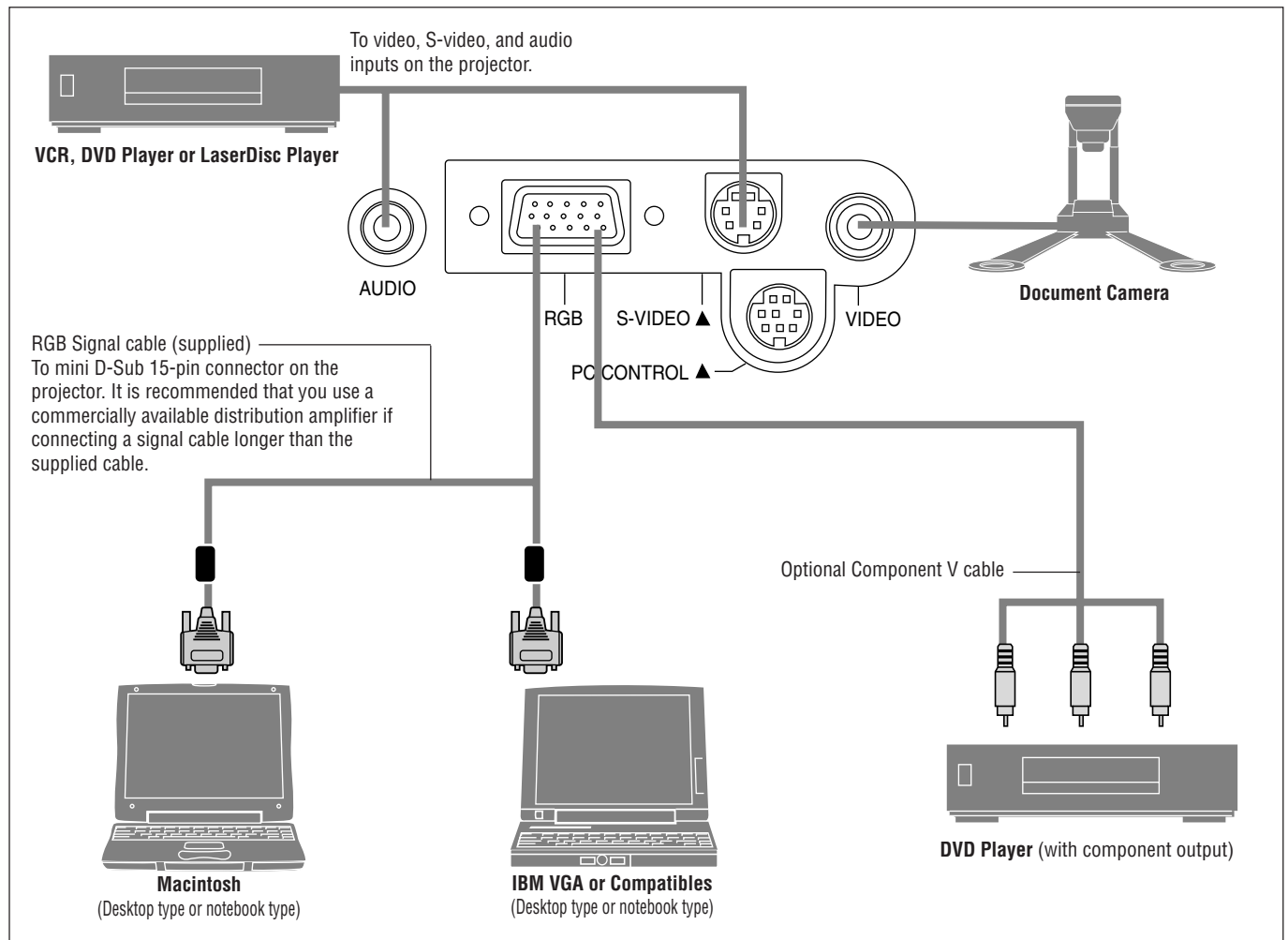

NOTE: When using with a notebook PC, be sure to connect between the projector and the notebook PC before turning on the power to the notebook PC. In most cases signal cannot be output from RGB output unless the notebook PC is turned on after connecting with the projector.

NOTE:

* If the screen goes blank while using your remote control, it may be the result of the computer's screen-saver or power management software.

* If you accidentally hit the POWER button on the remote control, wait 90 seconds and then press the POWER button again to resume.

NOTE: If using video, S-video, or audio cables, the cables should be 3 m (9.8 feet) or shorter.

Connecting Your PC

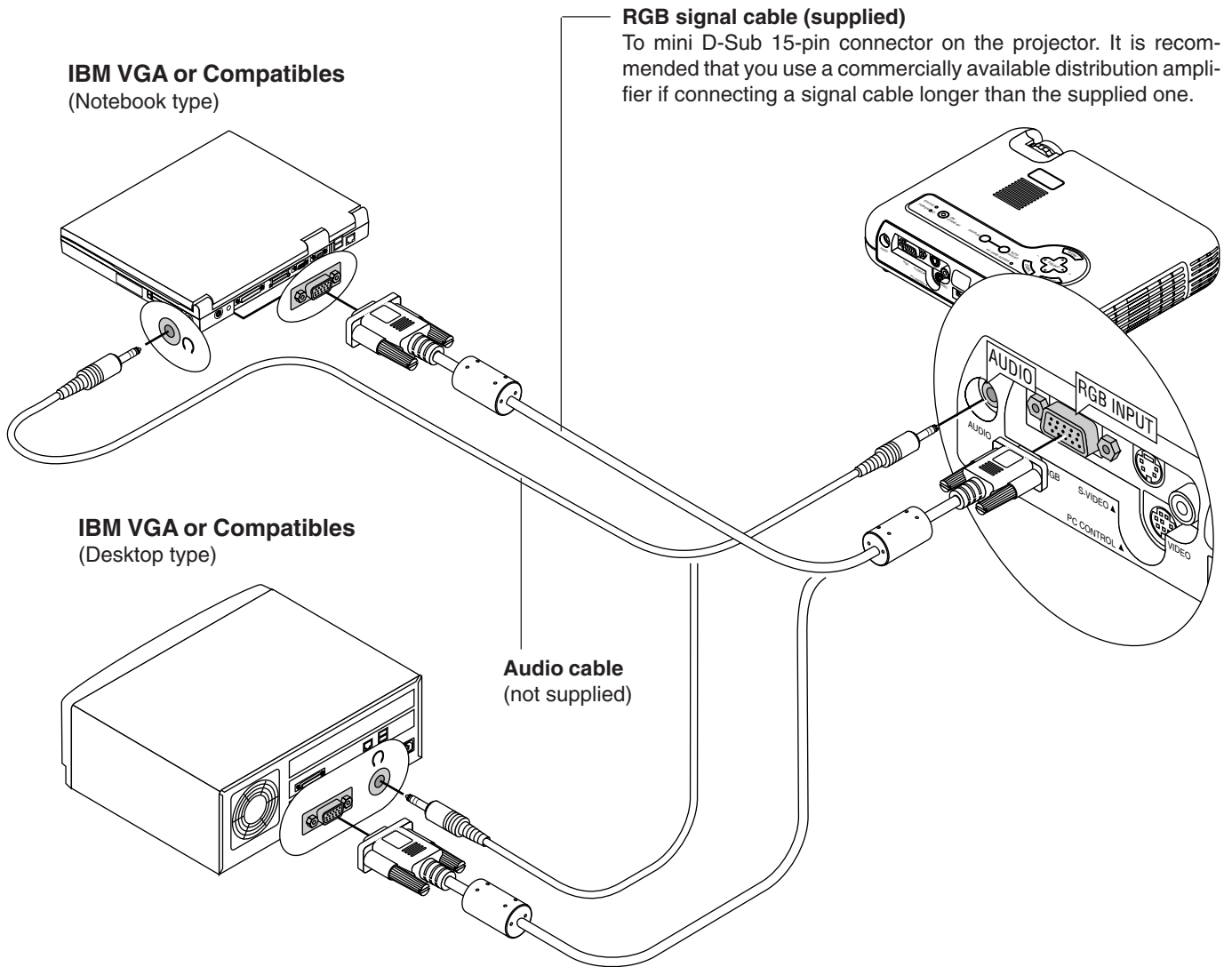

Connecting your PC to your projector DLV-100 will enable you to project your computer's screen image for an impressive presentation. To connect to a PC, simply:

1. Turn off the power to your projector and computer.
2. Use the supplied signal cable to connect your PC to the projector.
3. Turn on the projector and the computer.
4. If the projector goes blank after a period of inactivity, it may be caused by a screen saver installed on the computer you've connected to the projector.

Connecting Your Macintosh Computer

Macintosh (Notebook type)

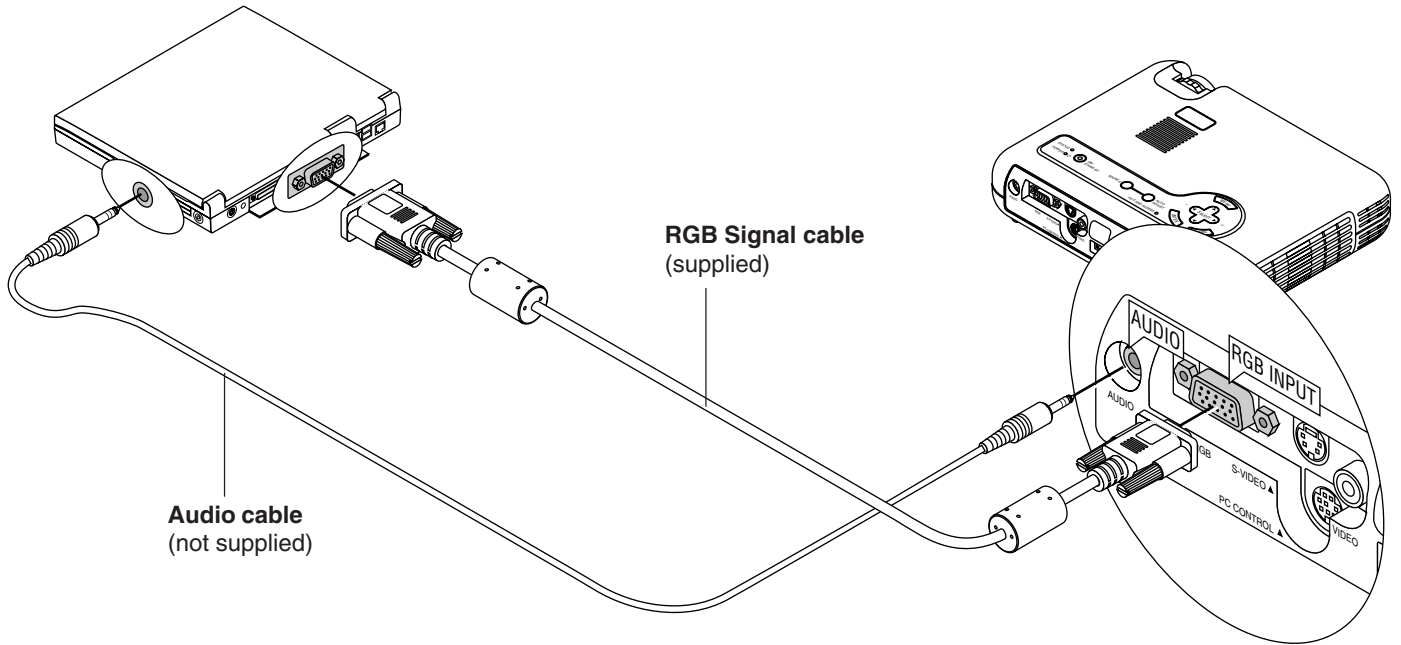

Macintosh (Desktop type)

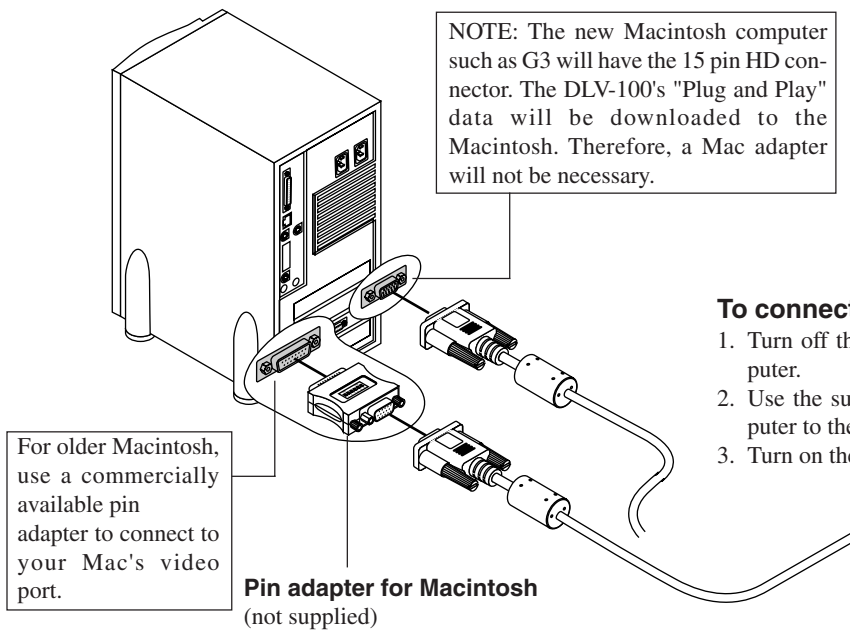

To connect to a Macintosh, simply:

1. Turn off the power to your projector and your Macintosh computer.
2. Use the supplied signal cable to connect your Macintosh computer to the projector.
3. Turn on the projector and the Macintosh computer.

Connecting Your DVD Player

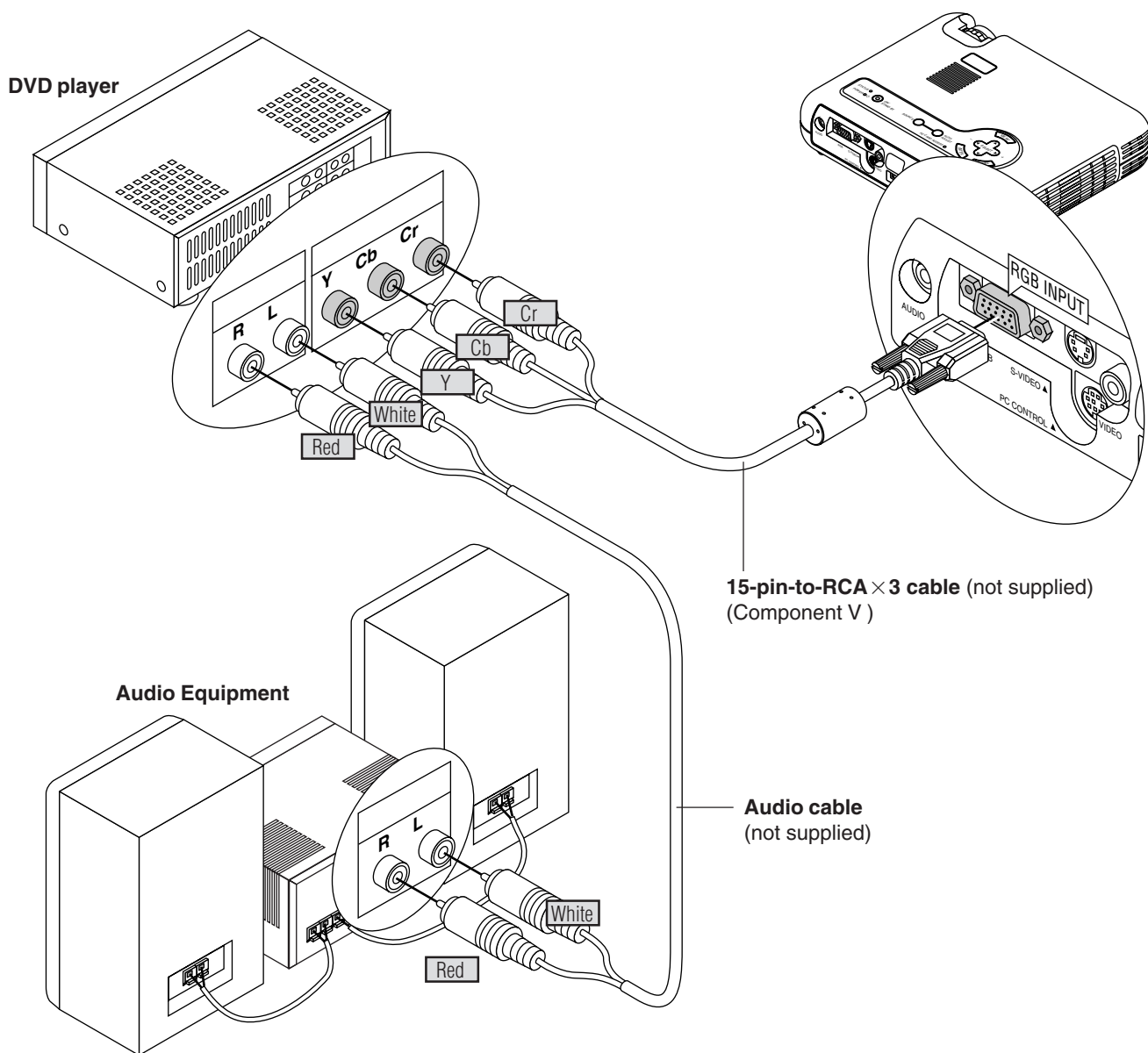

You can connect your projector to a DVD player with component outputs or Video output. To do so, simply:

1. Turn off the power to your projector and DVD player.
2. If your DVD player has the component video (Y,Cb,Cr) output, use the 15-pin-to-RCA x3 cable (not supplied) to connect your DVD player to the RGB INPUT connector on the projector.
For a DVD player without component video (Y,Cb,Cr) outputs, use common RCA cables (not provided) to connect a composite VIDEO output of the DVD player to the Video Input of the projector.
3. Turn on the projector and DVD player.

NOTE: Refer to your DVD player's instruction manual for more information about your DVD player's video output requirements,

Connecting Your VCR or Laser Disc Player

VCR/ Laser disc player

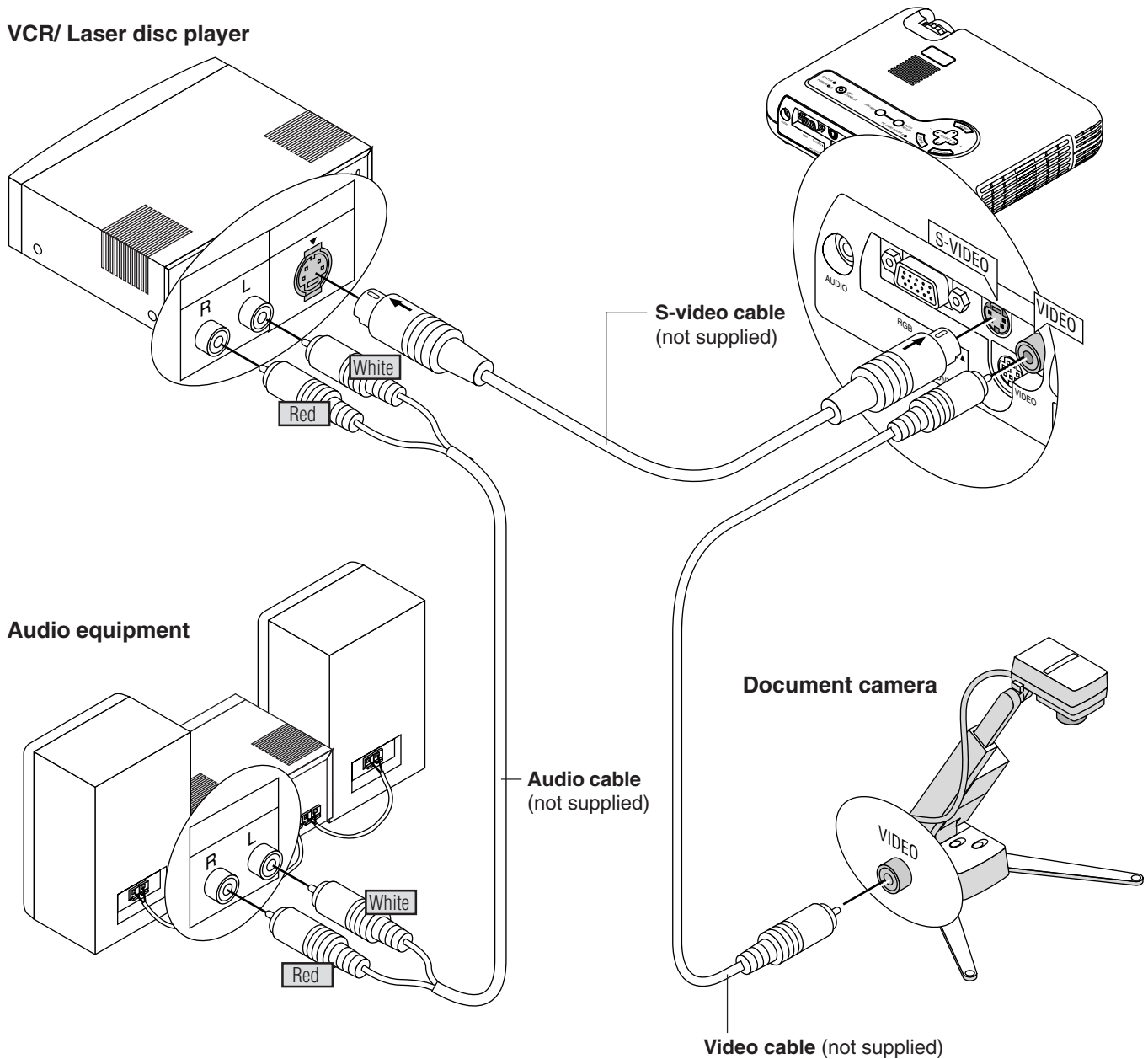

Use common RCA cables (not provided) to connect your VCR, laser disc player or document camera to your projector.

To make these connections, simply:

1. Turn off the power to the projector and VCR, laser disc player or document camera.
2. Connect one end of your RCA cable to the video output connector on the back of your VCR or laser disc player, connect the other end to the Video input on your projector. Use an audio cable (not supplied) to connect the audio from your VCR or laser disc player to your audio equipment (if your VCR or laser disc player has this capability). Be careful to keep your right and left channel connections correct for stereo sound.
3. Turn on the projector and the VCR or laser disc player.

NOTE: Refer to your VCR or laser disc player instruction manual for more information about your equipment's video output requirements.

NOTE:

- The image from a video playback deck may not be correctly displayed when used with a scan converter before being input to the projector.

About Startup screen (Menu Language Select screen)

When you first turn on the projector, you will get the Startup screen. This screen gives you the opportunity to select one of the seven menu languages: English, German, French, Italian, Spanish, Swedish and Japanese.

To select a menu language, follow these steps:

1. Use the Select ▲ or ▼ button to select one of the seven languages for the menu.



2. Press the Enter button to execute the selection.
3. The Basic/Custom menu will be displayed in the language you have selected.



To close the menu, press the Cancel button.

After this has been done, you can proceed to the advanced menu operation.

If you want, you can select the menu language later. See "Language" on page 34.

3. OPERATION

Connecting the Power Cable and Turn on the Projector

Before you turn on your projector, ensure that the computer or video source is turned on and that your lens cap is removed.

1 Connect the supplied power cable to the projector.

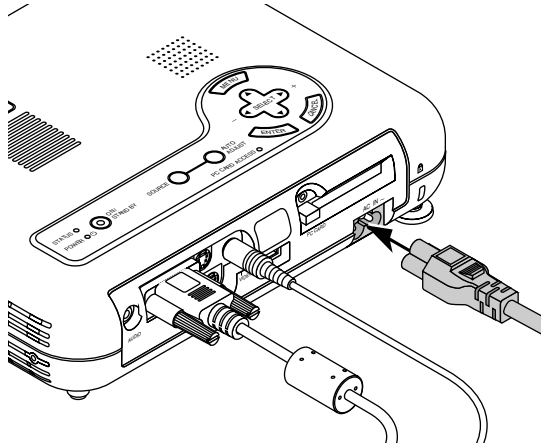

Plug the supplied power cable in the wall outlet. The projector will go into its standby mode and the power indicator will glow orange.

2 Turn on and off the Projector

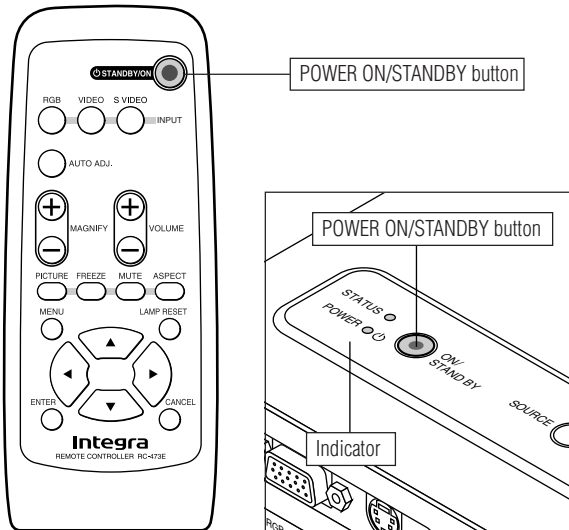

To turn on the projector:

Only after you press the POWER (ON/STANDBY) button on the projector cabinet or the remote control will the power indicator turn to green and the projector become ready to use.

NOTE: To turn the projector on by plugging in the power cable, use the menu and enable the "Auto Start" feature. (See page 37.)

NOTE: Immediately after turning on the projector, screen flicker may occur. This is not a fault. Wait 3 to 5 minutes until the lamp lighting is stabilized.

To turn off the projector:

First press the POWER (ON/STANDBY) button on the projector cabinet or the remote control. The power indicator will glow orange. After the projector turns off, the cooling fans keep operating for 90 seconds.

NOTE: Do not disconnect the power cable during this time. Then, unplug the power cable. The power indicator will go out.

Status of indicator light: turn on

Normal mode:

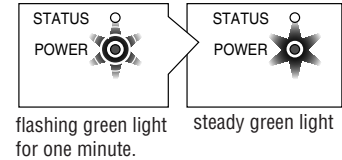
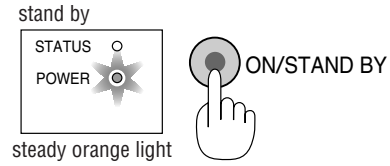

High-Bright mode:

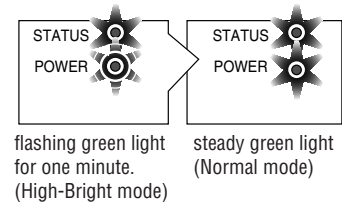
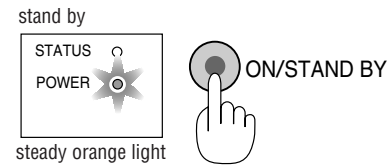

Status of indicator light: turn off

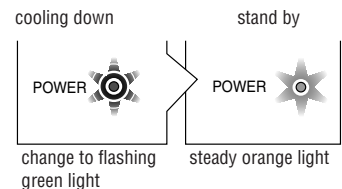
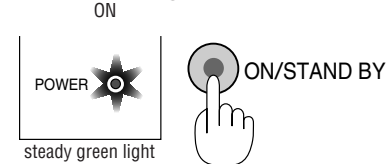

3 Adjust a Projected Image

Select the Computer or Video Source

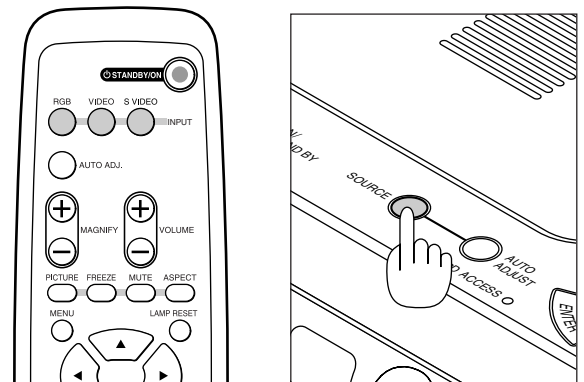

Press the RGB, VIDEO or S VIDEO button on the remote control, or the Source button on the projector cabinet to select "Video" (VCR, document camera, or laser disc player), "S-Video", "RGB" (computer or DVD with component output) or "PC Card Viewer" (slides on a CompactFlash card) to display the image.

Or press the "Menu" button on the remote control or the cabinet and use the menu to select your video source: "Video", "S-Video", "RGB" or "PC Card Viewer".

NOTE: If no input signal is available, the projector will display an Integra logo (factory preset).

Adjust the Image Size and the Focus

Use the Zoom ring to fine adjust the image size on the screen

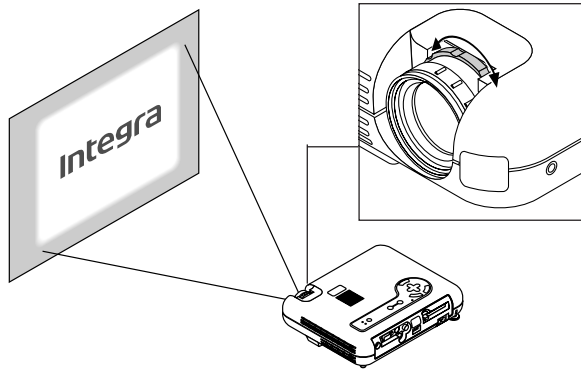

Use the Focus ring to obtain the best focus.

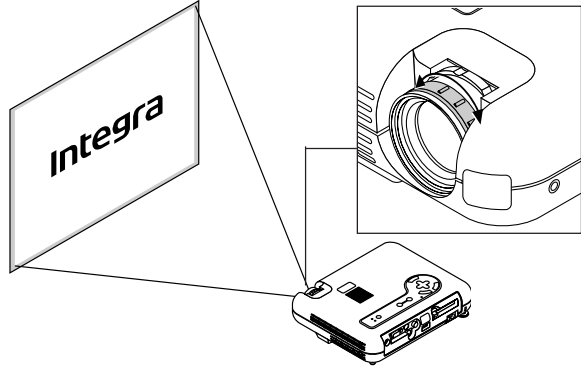

Place your projector on a flat level surface and Ensure that the projector is square to the screen.

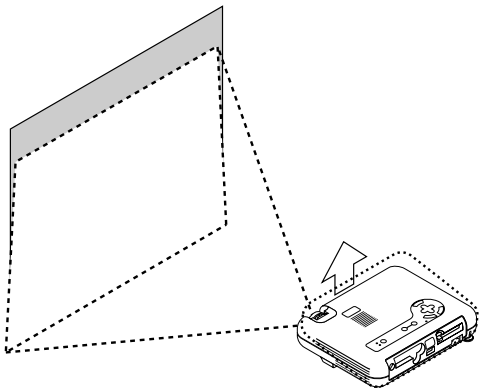

Lift the front edge of the projector to center the image vertically.

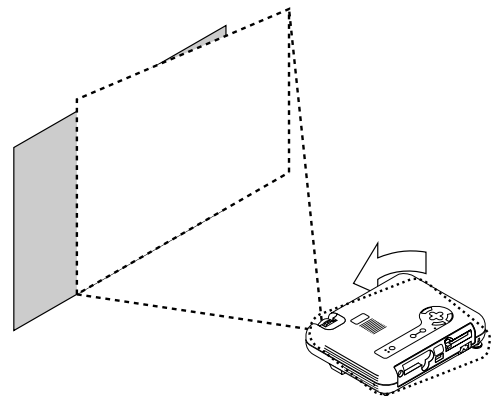

Move the projector left to center the image horizontally on the screen.

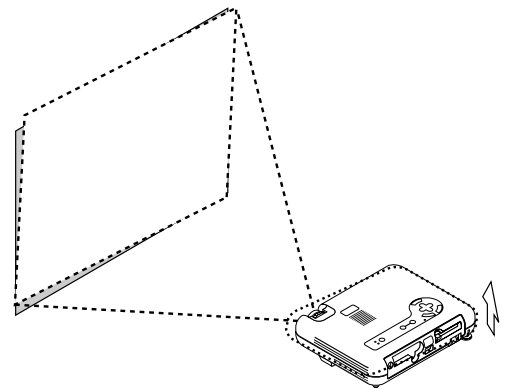

Rotate the rear foot to make the image square to the screen.

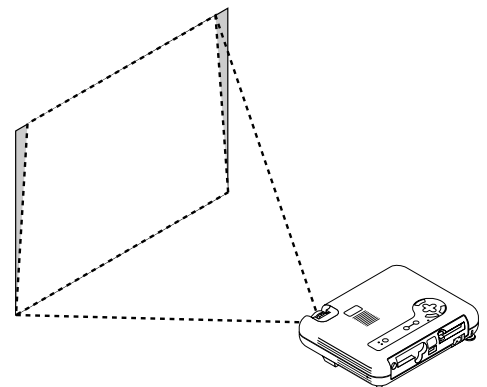

Use keystone correction for proper adjustment.

Adjust the Tilt Foot

- 1) Lift the front edge of the projector.
- 2) Press the Tilt button on the top of the projector to extend the adjustable tilt foot (maximum height).

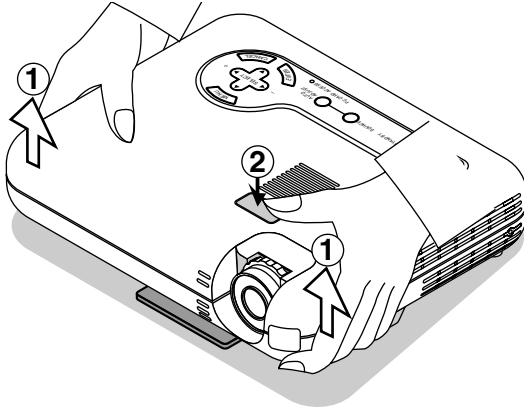

- 3) Press and hold the Tilt button.
- 4) Lower the front of the projector to the desired height and release the button to lock the Adjustable tilt foot.

There is approximately 5 degrees of up and down adjustment for the front of the projector. The rear foot height can be changed, but the vertical distance from the bottom to the desk or floor should be 0.14" (3.5mm) to make the projector horizontal on the flat surface. To fine-adjust the height of the rear foot, remove the spacer (black rubber) and rotate the rear foot to the desired height.

* If the projected image does not appear square to the screen then use keystone correction for proper adjustment.

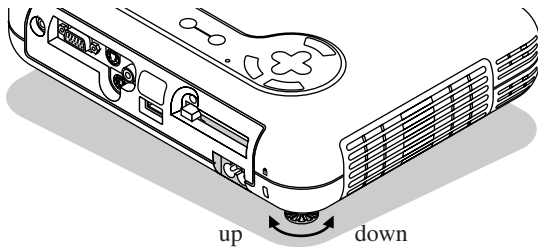
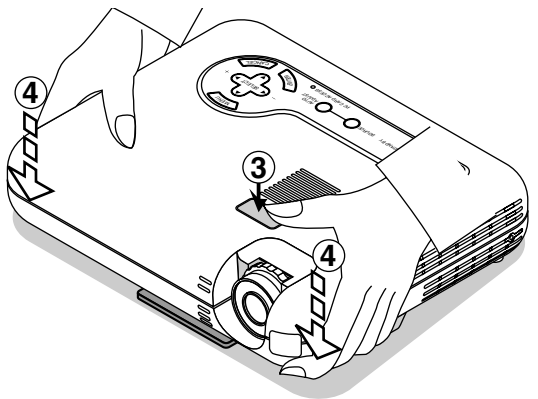

Do not use the tilt-foot for purposes other than originally intended. Misuses such as gripping the tilt-foot or hanging on the wall can cause damage to the projector.

Adjust the Image Using Auto Adjust

The Auto Adjust function automatically optimizes the image in RGB mode.

[Poor picture]

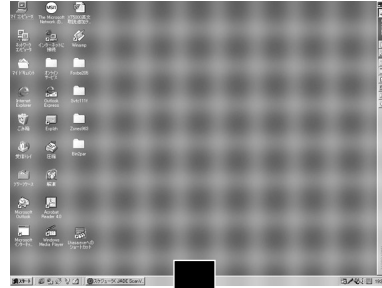

[Normal picture]

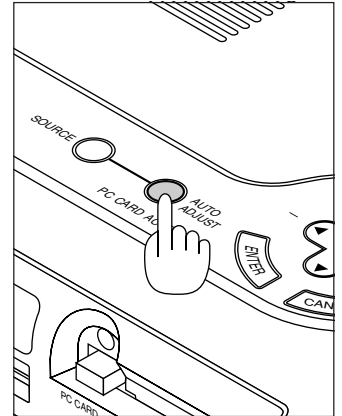
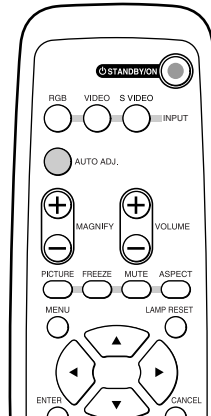
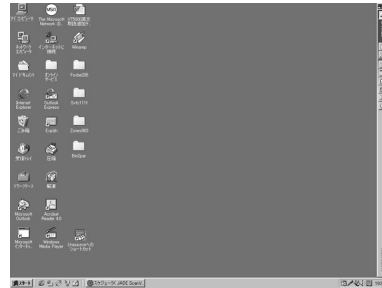

Press the Auto Adjust button to adjust Position-H/V and Pixel Clock/Phase for an optimal picture. Some signals may not be displayed correctly or take time to switch between sources.

Basic Operation

Selecting the computer or video source

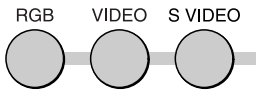

If the projector cabinet is used, each time the Source button is pressed, the input source will change as follows:

→ RGB → Video → S-Video → PC Card Viewer →

If no input signal is present, the input will be skipped.

Optimizing RGB image automatically

Press the Auto Adjust button to optimize an RGB image automatically.

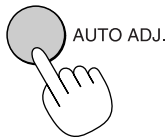

Press the Auto Adjust button to fine-tune the computer image or to remove any vertical banding that might appear and to reduce video noise, dot interference or cross talk (this is evident when part of your image appears to be shimmering). This function adjusts the clock frequencies that eliminate the horizontal banding in the image. This function also adjusts the clock phase to reduce video noise, dot interference or cross talk. (This is evident when part of your image appears to be shimmering.)

This adjustment may be necessary when you connect your computer for the first time.

NOTE: The Auto Adjust function does not work for component signal.

Volume control

Sound level from the speaker on the projector can be adjusted.

NOTE: When the menu or the magnifying glass appears, you cannot adjust the volume.

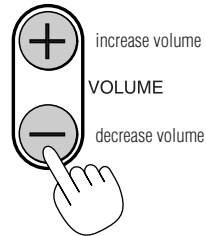

Turning off picture and sound

Press the Mute button to turn off the image and sound for a short period of time. Press again to restore the image and sound.

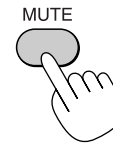

Using Magnify button

You can use Magnify button to draw your audience's attention to the portion of a projected image you want.

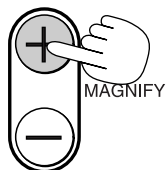

Press the Magnify button.

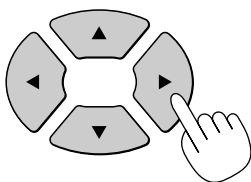

Use the Select button to move the magnifying glass.



4. Return the image to the original size.

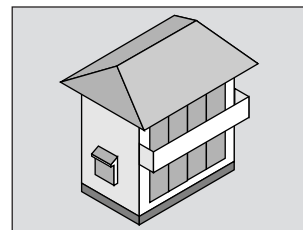
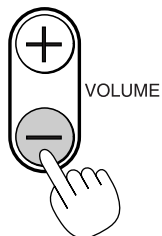

Freezing a picture

Press the Freeze button to freeze a picture. Press again to resume motion.



Enlarging and Moving a Picture

You can enlarge the area you want up to 400 percent.

To do so:

1. Press the Magnify button.

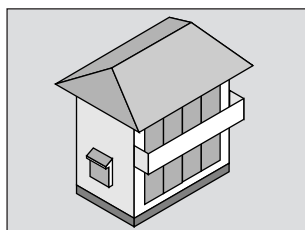
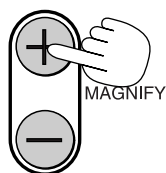

2. Move the magnifying glass to the area you want to enlarge.

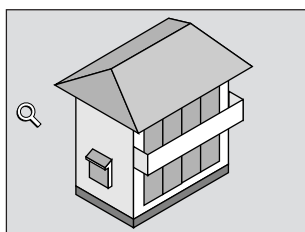
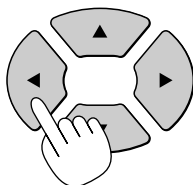

3. Enlarge the selected area.

When the Magnify \oplus button is pressed, you can enlarge the area up to 400 percent.

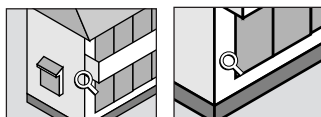
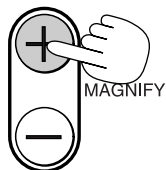

Using the Menus

NOTE: The on-screen menu may not be displayed correctly while interlaced motion video image is projected.

1. Press the "Menu" button on the remote control or projector cabinet to display the Advanced Menu or Basic/Custom Menu.
NOTE: When using a USB mouse, click the mouse button to display the menu. For other operations, do the same way as you use your PC mouse.
2. Press the ▲ or ▼ button on the remote control or the projector cabinet to highlight the menu for the item you want to adjust or set.
3. Press the ► button or the "Enter" button on the remote control or the projector cabinet to select a submenu or item.
4. Adjust the level or turn the selected item on or off by using ◀ or ▶ button on the remote control or the projector cabinet. The on-screen slide bar will show you the amount of increase or decrease.
5. Changes are stored until you adjust it again.
ENTER Stores the setting or adjustments.
CANCEL ... Return to the previous screen without storing settings or adjustments.
6. Repeat steps 2-5 to adjust an additional item, or press "Cancel" on the projector cabinet or the remote control to quit the menu display.

Customizing Basic/Custom Menu

The Basic/Custom menu can be customized to meet your requirements. Selecting a menu item from the "Basic/Custom Menu Edit" list, allows you to custom tailor the menu items to your needs.

1. Select "Basic/Custom Menu Edit" to display the "Basic/Custom Menu Edit" screen.

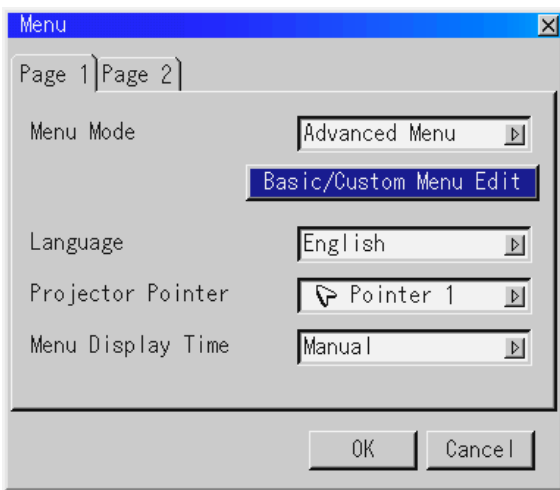

2. Use the ▲ or ▼ button to highlight your selection and press the Enter button to place a check mark next to an option. This action enables that feature.
Press the Enter button again to clear the check box.

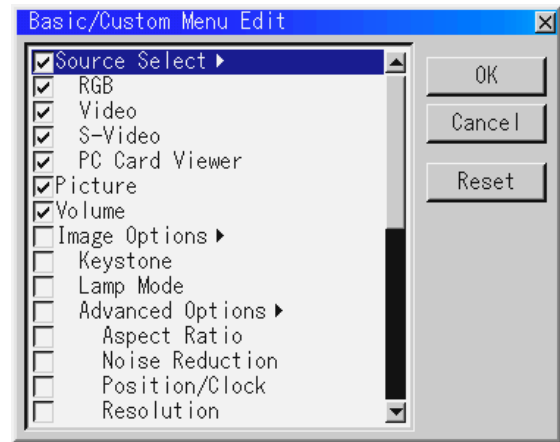

If you select an item with a solid triangle ► and press the Enter button on the remote control or the projector cabinet, you can enable all the items within that submenu.

Also you can turn on an item within the submenu without placing a check mark on the main menu item.

NOTE: Up to 12 main menu items (within Basic/Custom Menu Edit, not including submenu items) can be selected.

3. In order for the changes to take effect, use the ◀ or ▶ button on the remote control or the projector cabinet to highlight "OK", then press the Enter button. To cancel the changes, use the ▲ or ▼ button to highlight "Cancel" and press the "Enter" button. To return to the factory default, select "Reset" then press the "Enter" button.

The default Basic/Custom Menu items are:

Source Select (RGB, Video, S-Video and PC Card Viewer), Picture, Volume, Image Options (Keystone), Projector Options (Menu and Setup) and Tools (Capture, PC Card Files and ChalkBoard).

NOTE: Once you have selected OK on the Basic/Custom Menu Edit screen, you cannot cancel the changes on the Menu screen. However, you can re-edit the menu items over again as described in the steps above.

NOTE: If the "Advanced Menu" item has been selected on the Menu mode, you get the "Confirmation Change Menu" upon completion of "Basic/Custom Menu" editing. In this case, selecting "Yes" then "Enter" will close all the menus and apply the changes from the Advanced menu to the Basic/Custom Menu.

If you select "No" then "Enter" functions, then all menu items will return to the Advanced menu, but your changes will still be available within the "Basic/Custom Menu" selection. To display the previously tailored Basic/Custom Menu, select "Basic/Custom Menu" from the "Menu Mode".

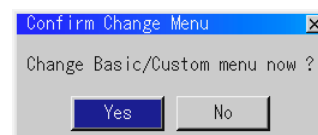

An item "To Advanced Menu" will be added to the bottom of the Basic/Custom Menu.

Selecting this item and pressing the "Enter" button will display the "Advanced Menu" features.

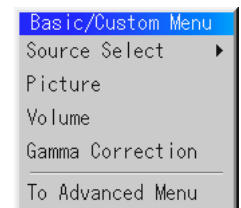

Using a USB Mouse

Using a USB mouse gives you a smooth operation. A commercially available USB mouse is required.

NOTE: There may be some brands of USB mouse that the projector does not support.

Operate the Menu using the USB mouse

Mouse Cursor

When connecting a USB mouse to the projector, you get a mouse cursor on the screen.

Unless you use your USB mouse within 10 seconds, the mouse cursor disappears.

Menu Display

Clicking with a mouse button displays the menu.



Clicking  displays the pull-down menu.

To close the menu, click anywhere in the background.

Adjusting and Setting Display

You can select a menu item and click with a mouse button to make adjustments and setting.

Examples

Click (or press and hold) the mouse button  or  to adjust the brightness.

Or click and drag the mouse button on the slide bar horizontally to adjust it.

To save the adjustments, click . The display is closed.

If you click anywhere in the background while displaying adjustment and setting menu or dialog box, you will get the main menu at the clicking point.

Menu Tree

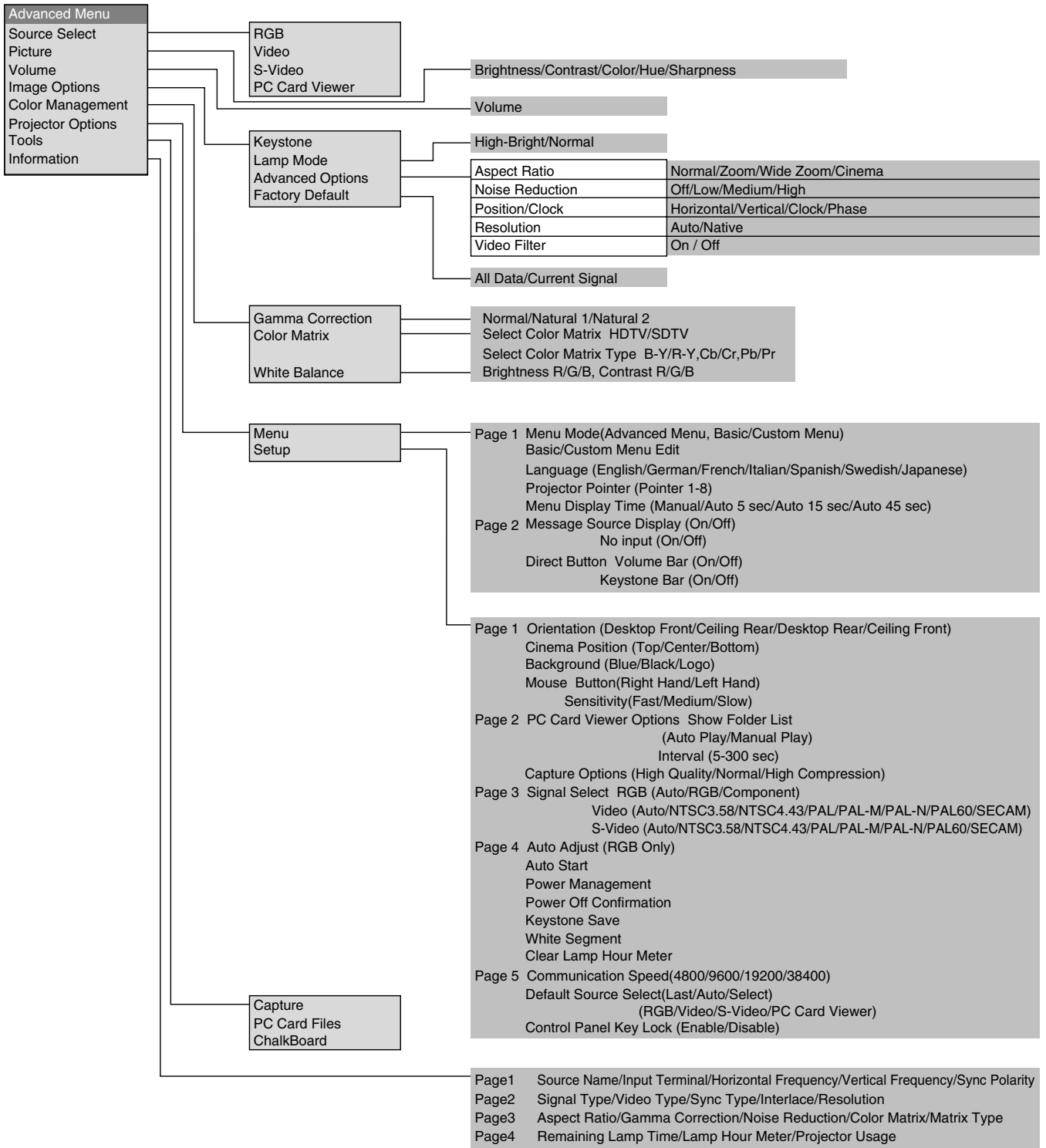

Menu Elements

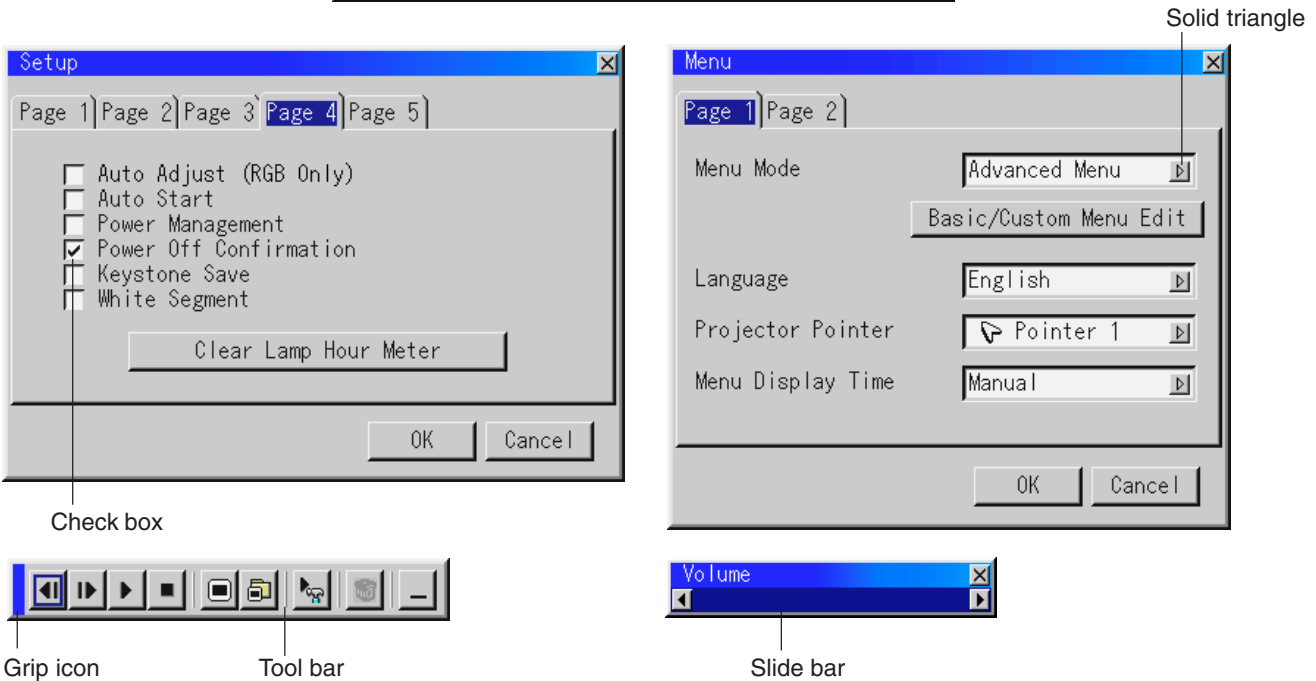
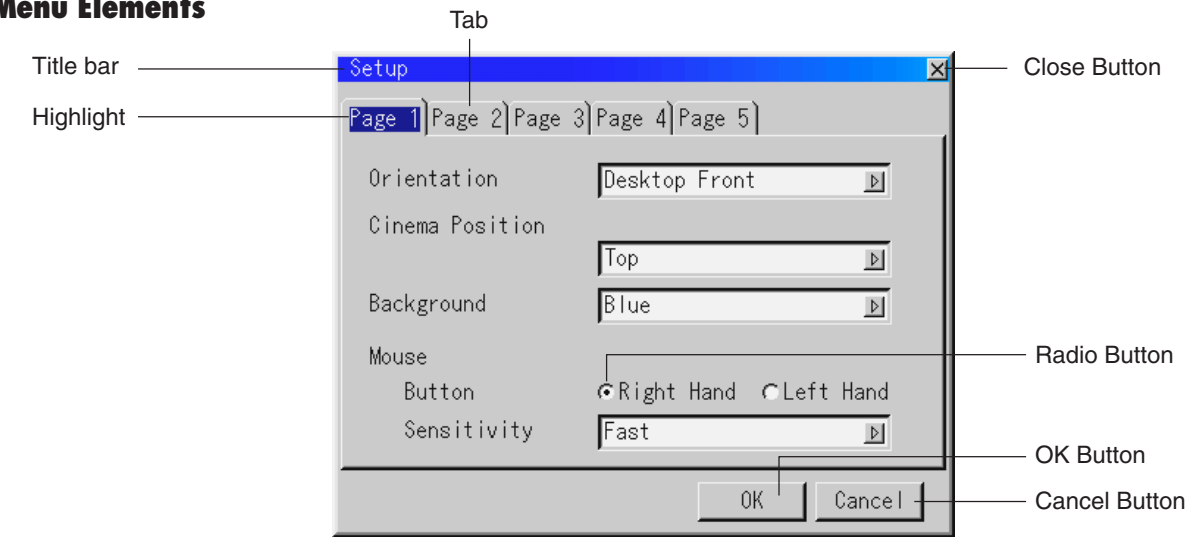

Menu windows or dialog boxes typically have the following elements:

- Title bar:** Indicates the menu title.
- Highlight:** Indicates the selected menu or item.
- Solid triangle:** Indicates further choices are available. A highlighted triangle indicates the item is active.
- Tab:** Indicates a group of features in a dialog box. Selecting on any tab brings its page to the front.
- Radio button:** Use this round button to select an option in a dialog box.
- Check box:** Place a checkmark in the square box to turn the option On.
- Slide bar:** Indicates settings or the direction of adjustment.
- OK button:** Press to confirm your setting. You will return to the previous menu.
- Cancel button:** Press to cancel your setting. You will return to the previous menu.
- Close button:** Click to close the window with saving changes. (USB mouse only)
- Toolbar:** Contains several icons for specific tasks. It is also referred to as "launcher".
- Grip icon:** Point the mouse here, and click and drag to move a toolbar.

Menu Descriptions & Functions

Source Select

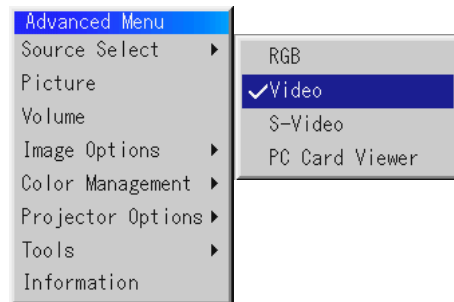

Enables you to select a video source such as a VCR, DVD player, laser disc player, computer or document camera depending on what is connected to your inputs.

Press the "Select" button on the projector cabinet or ▲▼ buttons on your remote control to highlight the menu for the item you want to adjust.

RGB

Selects the computer connected to your RGB or component signal.

Video

Selects what is connected to your Video input-VCR, laser disc player, DVD player or document camera.

S-Video

Selects what is connected to your S-Video input-VCR, DVD player, or laser disc player.

NOTE: A frame may freeze for a brief period of time when a video is played back in fast-forward or fast-rewind with a Video or S-Video source.

PC Card Viewer

This feature enables you to make presentations using a CompactFlash card that contains captured images.

NOTE: Even if you switch the current PC Card Viewer source to another source, the current slide is retained. When you return back to the PC Card Viewer, you will get the slide that has been retained.

A launcher will appear when you press the MENU button.

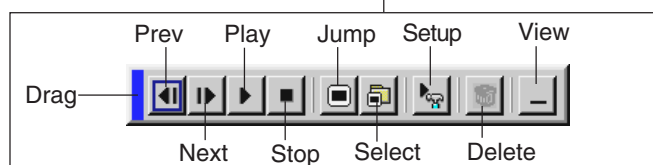
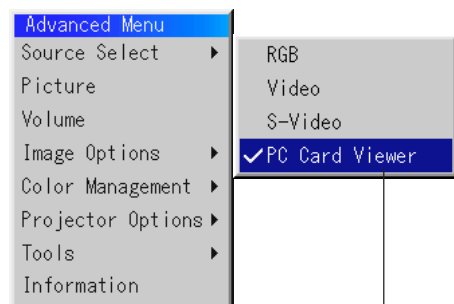

A press of the MENU button displays the toolbar; a press of the MENU button again displays the Menu and hereafter each press of the MENU button switches displaying between the Menu and the toolbar.

The launcher is a tool bar including the following buttons:

- Drag Drags to move the tool bar. (for USB mouse operation only)
- Prev Returns to the previous slide or folder.
- Next Advances to the next slide or folder.
- Play Plays back automatically or manually depending on the setting on PC Card Viewer Options of the menu. This allows you to move on to the next slide when "Manual Play" is selected.
- Stop Stops Auto Play while you are playing back and to resume playing from the selected slide or folder when "Auto Play" is selected.
- Jump Displays a list of slides while you are playing back.
- Select Displays a list of folders while you are playing back.
- Setup Displays the PC Card Viewer Options dialog box on Page 2 of the Setup dialog box.
- Delete Deletes a captured slide(s) or all the captured slides in the selected folder.
- View Hides the tool bar while you are playing back. Clicking with the right button of a mouse shows it again.

Picture (not available for PC Card Viewer)

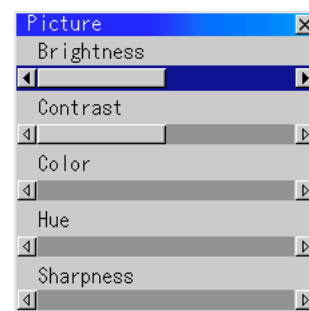

Provides access to controls for your image. Use the "Select" button on the projector cabinet or ◀▶ buttons on the remote control to highlight the menu for the item you want to adjust.

- Brightness .. Adjusts the brightness level or the back raster intensity.
- Contrast Adjusts the intensity of the image according to the incoming signal.
- Color Increases or decreases the color saturation level (not valid for RGB).
- Hue Varies the color level from +/- green to +/-blue. The red level is used as reference. This adjustment is only valid for Video and Component inputs (not valid for RGB).
- Sharpness .. Controls the detail of the image for Video (Not valid for RGB and Component).

Volume (not available for PC Card Viewer)



Adjusts the sound level of the projector.

NOTE: You can also display the volume bar without opening the menu. See "Volume Bar (Direct Button)" on page 35 for more details.

Image Options

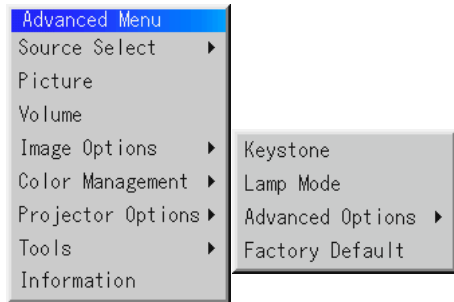

Keystone



This feature corrects the keystone (trapezoidal) distortion to make the top of the screen longer or shorter to be the same as the bottom. Use the ◀ or ▶ buttons on the slide bar to correct the keystone (trapezoidal) distortion.

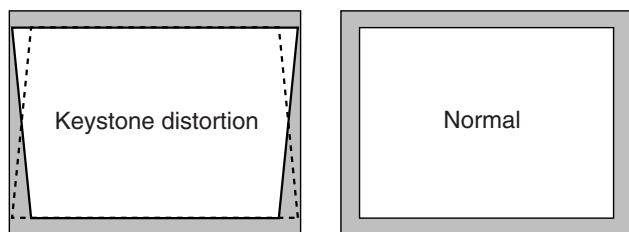

NOTE: The keystone angle can be corrected between 30 degrees upward and 30 degrees downward at a 0 degree-projection angle.

Depending on the type of graphics being used, the picture may get blurred or keystone correction may not be possible when excessive keystone correction is used.

The idea is, the closer you are to native resolution, the better image you will see.

Lamp Mode

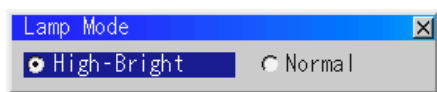

This feature enables you to select two the brightness modes of the lamp: High-Bright and Normal modes. The lamp life can be extended up to 1500 hours by using the Normal mode.

Normal Mode This is the default setting.

High-Bright Mode Select this mode to make the image brighter than in Normal mode.

NOTE: If you have selected the Normal mode, the lamp lights in High-Bright mode for one minute after the projector is turned on. After one minute the lamp will change to Normal mode.

Aspect Ratio (not available for RGB and PC Card Viewer)

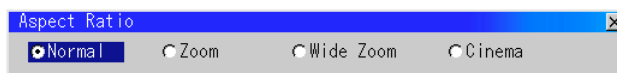

Aspect Ratio allows you to select the best Aspect mode to display your source image.

When 4:3 is selected from the source (i.e. DVD player), the following selections will display:

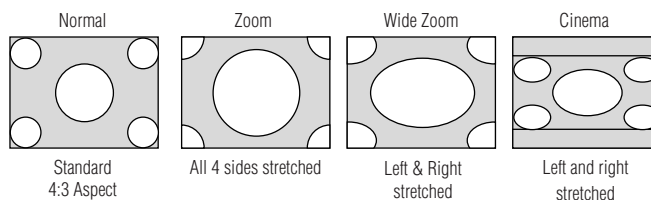

When 16:9 is selected from the source (i.e. DVD player), the following selections will display:

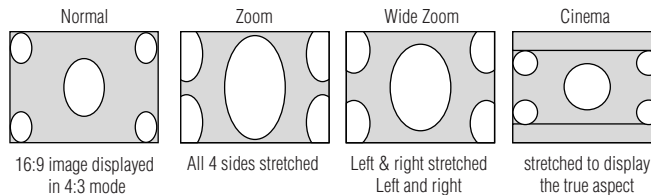

NOTE: You can select three image positions for Cinema: Top, center, and bottom.

See page 35 for setting image positions.

Noise Reduction (not available for RGB and PC Card Viewer)

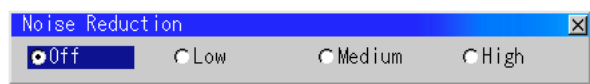

You can select three levels video noise reduction.

NOTE: The lower the Noise Reduction level, the better the image quality by way of higher video bandwidth.

Position/ Clock (when Auto Adjust is off)

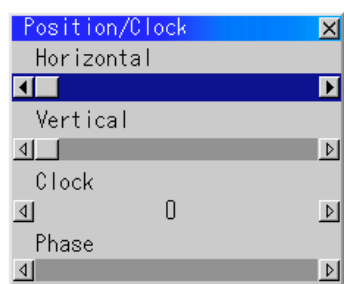

This allows you to manually adjust the image horizontally and vertically, and adjust Clock and Phase.

Horizontal/Vertical Position:

Adjusts the image location horizontally and vertically using the ◀ and ▶ buttons.

This adjustment is made automatically when the Auto Adjust is turned on. See "Auto Adjust (RGB Only)" on page 36 for turning on or off the Auto Adjust feature.

Clock Use this item to fine tune the computer image or to remove any vertical banding that might appear. This function adjusts the clock frequencies that eliminate the horizontal banding in the image. Press the ◀ and ▶ buttons until the banding disappears. This adjustment may be necessary when you connect your computer for the first time. This adjustment is made automatically when the Auto Adjust is turned on.

Phase Use this item to adjust the clock phase or to reduce video noise, dot interference or cross talk. (This is evident when part of your image appears to be shimmering.) Use the ◀ and ▶ buttons to adjust the image. Use "Phase" only after the "Clock" is complete. This adjustment is made automatically when the Auto Adjust is turned on.

Resolution (when Auto Adjust is off)



This allows you to activate or deactivate the Advanced AccuBlend feature.

Auto Turns on the Advanced AccuBlend feature. The projector automatically reduces or enlarges the current image to fit the full screen.

Native Turns off the Advanced AccuBlend feature. The projector displays the current image in its true resolution.

See "Auto Adjust (RGB Only)" on page 36 for turning on or off the Auto Adjust feature.

NOTE: While you are displaying an image with higher resolution than the projector's native resolution, even when you are in the Native mode, the image is displayed full screen using the Advanced AccuBlend feature.

Video Filter (when Auto Adjust is off)

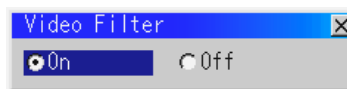

This function reduces video noise.

On The low-pass filter is applied.

Off The filter is removed.

Screen adjustments are possible even when the filter is On.

Factory Default

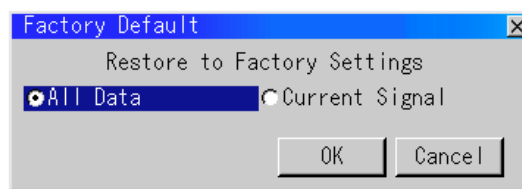

Changes all adjustments and setting to the factory preset.

All Data Resets all the adjustments and settings for all the signals to the factory preset.

The items can be reset except Language, Communication Speed, Remaining Lamp Time, Lamp Hour Meter and Projector Usage. (To reset the lamp usage time, see "Clear Lamp Hour Meter" on page 37.)

Current Signal . Resets the adjustments for the current signal to the factory preset levels.

The items that can be reset for the currently projected image are: Picture (Brightness, Contrast, Color, Hue and Sharpness), Image Options (Aspect Ratio, Noise Reduction, Position/Clock, Resolution and Video Filter) and Color Management (Gamma Correction, Color Matrix and White Balance).

NOTE: The Volume, Keystone and all the items in the Projector Options can be reset only when "All Data" is selected.

Color Management

Gamma Correction (not available for PC Card Viewer)

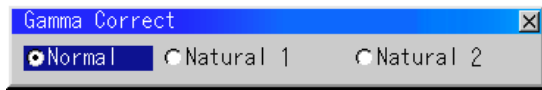

Use the ◀ or ▶ button to choose "Normal" when in a lighted room and "Natural 1&2" when in a darkened room. "Natural 1" for better flesh tone; "Natural 2" for true reproduction of middle tones.

Each mode is recommended for :

Normal For the regular picture

Natural 1 For true color reproduction of natural tones

Natural 2 For dark portions of a picture

Color Matrix (available for component video signal only)

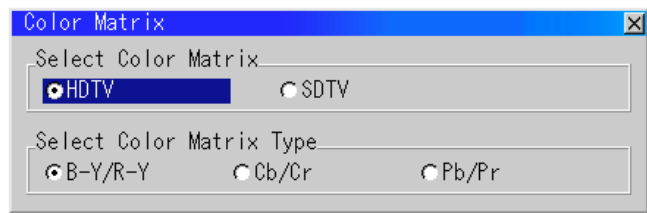

First select an appropriate color matrix to fit your component signal for HDTV or SDTV. Then select an appropriate matrix type from B-Y/R-Y, Cb/Cr or Pb/Pr.

White Balance (not available for PC Card Viewer)



This allows you to adjust the white balance. Brightness for each color (RGB) is used to adjust the black level of the screen;

Contrast for each color (RGB) to adjust the white level of the screen.

First use the ▲ or ▼ buttons to select R, G, or B for the brightness and the contrast. Next use the ◀ or ▶ buttons to adjust the level.

Projector Options

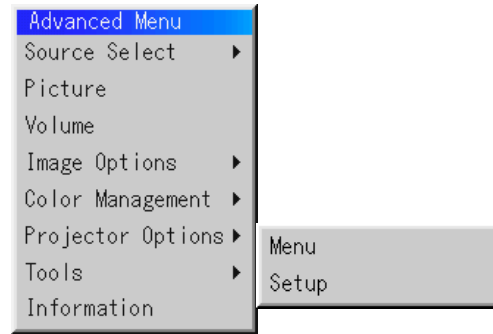

Menu

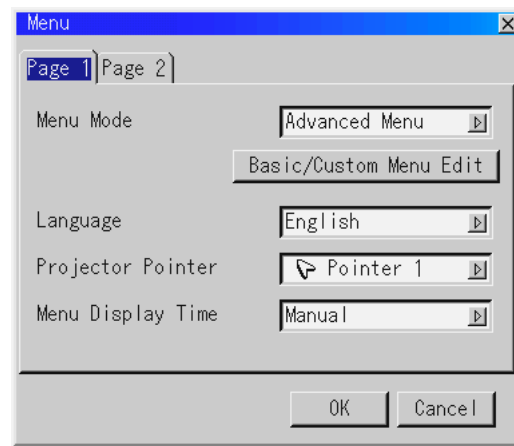

Allows you to set preferences for the on-screen menu.

Press "OK" to save your changes for all the features of Page 1 and Page 2.

[Page1]

Menu Mode:

This feature allows you to select two menu modes: Advanced Menu and Basic/Custom Menu.

Advanced Menu This is the menu that contains all the available menus and commands.

Basic/Custom Menu . This is the menu that you can customize using the Basic/Custom Menu Edit to fit your needs.

The factory default Basic/Custom menu includes:

Source Select (RGB, Video, S-Video and PC Card Viewer), Picture, Volume, Image Options (Keystone), Projector Options (Menu and Setup) and Tools (Capture, PC Card Files and ChalkBoard).

See page 27 for instructions about how to customize the Basic/Custom Menu.

Language:

You can choose one of seven languages for on-screen instructions.

The options are: English, German, French, Italian, Spanish, Swedish and Japanese.

Projector Pointer:

This option is not available on this model.

Menu Display Time :

This option allows you to select how long the projector waits after the last touch of a button to turn off the menu.

The preset choices are "Manual", "Auto 5 sec", "Auto 15 sec", and "Auto 45 sec". The "Auto 45 sec" is the factory preset.

Manual The menu can be turned off manually.

Auto 5 sec .. The menu will automatically be turned off in 5 seconds if no buttons are pressed within 5 seconds.

Auto 15 sec ... The menu will automatically be turned off in 15 seconds if no buttons are pressed within 15 seconds.

Auto 45 sec ... The menu will automatically be turned off in 45 seconds if no buttons are pressed within 45 seconds.

[Page2]

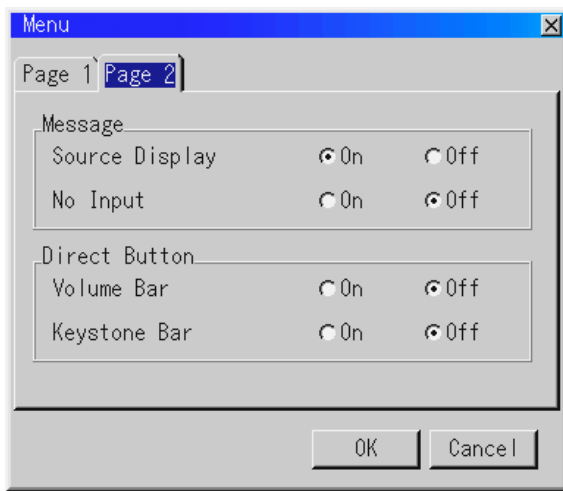

Message:

You can choose the desired information to be displayed on the screen.

On The message will be displayed.

Off The message will not be displayed.

Source Display: You can turn on and off the information for input name such as VIDEO and RGB.

When this option is on, the current input will be displayed each time you switch sources or turn on the projector.

No Input: This option turns on or off the "No Input" message to be displayed in the top right corner on the screen.

Direct Button:

Volume Bar:

This option turns on or off the volume bar when you adjust the sound volume using VOLUME ⊕/⊖ (up and down) button.

On You can increase or decrease the sound volume with the volume bar on screen.

Off You can increase or decrease the sound volume without having to use the volume bar.

Keystone Bar:

This option is not available on this model.

Setup

Enables you to set operating options.

Press "OK" to save your changes for all the features of Page 1, Page 2, Page 3, Page 4 and Page 5.

[Page1]

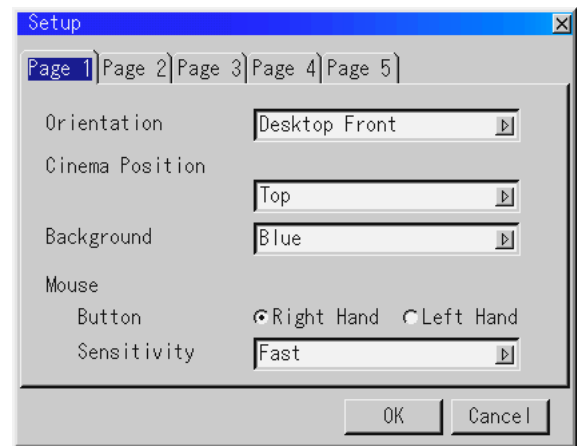

Orientation:

This reorients your image for your type of projection.

The options are: desktop front projection, ceiling rear projection, desktop rear projection, and ceiling front projection.

Cinema Position:

This feature selects the vertical position of the image when viewing video with Cinema aspect ratio selected.

When Cinema aspect ratio is selected on earlier models, the image is displayed with black borders on the top and bottom.

You can select the vertical position among three options:

Top Image position is at the top with a black border on bottom.

Center Image position is at the center with black borders on top and bottom.

Bottom Image position is at the bottom with a black border on top.

Background:

Use this feature to display a blue/ black screen or logo when no signal is available. The default background is Integra. You can change the logo screen using the PC Card Files feature. See page 38.

Mouse Settings:

This option lets you to change your USB mouse settings. The mouse settings feature is available for USB mouse only. Choose the settings you want:

- Mouse Button "Right Hand" or "Left Hand"
- Mouse Sensitivity "Fast", "Medium" or "Slow"

[Page 2]

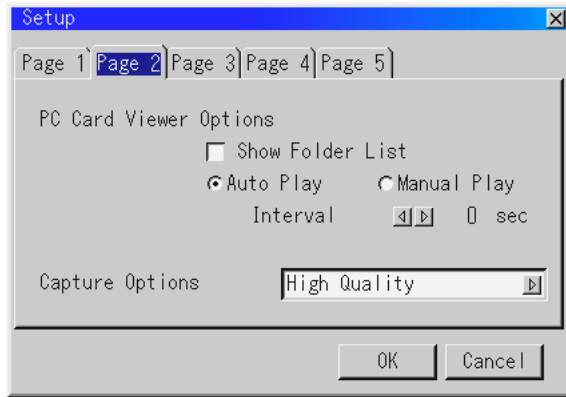

PC Card Viewer Options

Show Folder List:

If this option is checked, when PC Card Viewer input is selected on the projector, the folder lists will be displayed and allows you to select the presentation from a CompactFlash card.

Auto Play:

If this option is checked, any given slide will start to play automatically.

Auto Play Interval:

You can specify interval time between 5 and 300 seconds.

NOTE: The Auto Play Interval time set on the PC Card Viewer Utility overrides the one set here.

Manual Play:

Views a slide manually when PC Card Viewer input is selected.

NOTE: The Auto Play and Manual Play options determine the behavior of the Play/Stop [▶ / ■] icon on the Viewer toolbar.

NOTE: If you check "Auto Play" and select "PC Card Viewer" on the projector, the slides will automatically start to play back from any given slide.

Capture Options: (available for JPEG only)

These options are used for the Capture function that you can select from Tools. You have three options for JPEG compression quality: High quality, Normal and High Compression.

- High Quality Gives quality of JPEG a priority.
- Normal Gives normal JPEG quality.
- High Compression Gives compression a priority.

[Page 3]

Signal Select

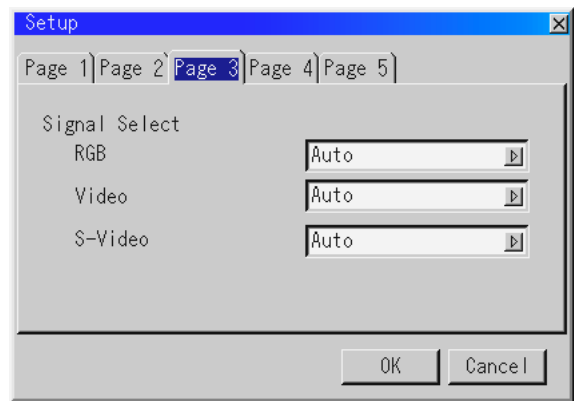

RGB:

Allows you to choose "RGB" for an RGB source such as a computer, or "Component" for a component video source such as a DVD player. Normally select "Auto" and the projector automatically detects a component signal. However there may be some component signals that the projector is unable to detect. If this is the case, select "Component".

VIDEO and S-VIDEO:

This feature enables you to select composite video standards manually. Normally select "Auto".

Select the video standard from the pull-down menu.

This must be done for Video and S-Video separately.

[Page 4]

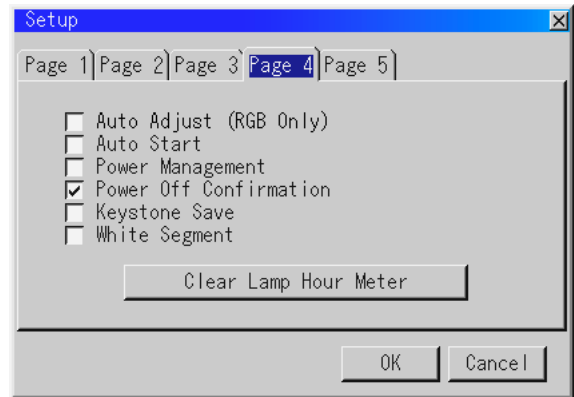

Auto Adjust (RGB Only):

When "Auto Adjust" is set to "On", the projector automatically determines the best resolution for the current RGB input signal to project an image using the Advanced AccuBlend Intelligent Pixel Blending Technology.

The image can be automatically adjusted for position and stability; "Horizontal Position", "Vertical Position", "Clock", "Phase", and "Resolution."

On Automatically adjusts image "Horizontal Position", "Vertical Position", "Clock", "Phase" and "Resolution".

Off User can adjust the image display functions ("Horizontal Position", "Vertical Position", "Clock", "Phase" and "Resolution") manually.

Auto Start:

Turns the projector on automatically when the power cable is inserted into an active power outlet. This eliminates the need to always use the "Power" button on the projector cabinet or remote control.

Power Management:

When this option is on and there is no RGB input for five minutes or more, the projector will automatically turn itself off.

Power Off Confirmation:

This option determines whether a confirmation dialog for turning off the projector will appear or not.

Keystone Save:

This option enables you to save your current keystone settings. Saving your change once affects all sources. The changes are saved when you turn off the projector.

White Segment:

You can put emphasis on either brightness or color for a projected image.

If you prefer putting emphasis on brightness, place a checkmark in the box to turn the option on. If you prefer an image in truer color, turn off this option.

Clear Lamp Hour Meter:

Resets the lamp clock back to zero. Pressing this button appears a confirmation dialog box. To reset the lamp usage hour, press "OK".

NOTE: The projector will turn off and go into standby mode after 1100 hours (up to 1600 hours in Normal mode) of service. If this happens, press the "Lamp Reset" button on the remote control for ten seconds to reset the lamp clock back to zero. Do this only after replacing the lamp.

[Page 5]

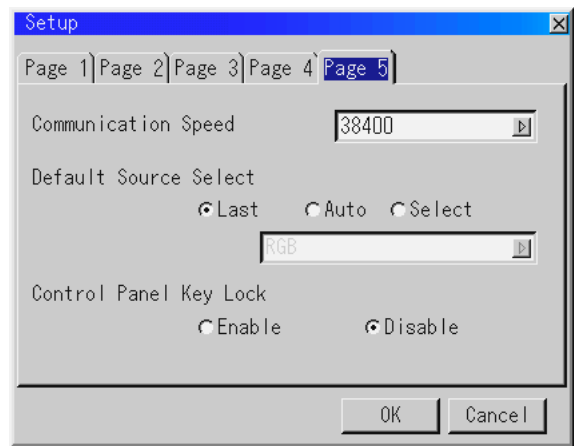

Communication Speed:

This feature sets the baud rate of the PC Control port (Mini DIN 8 Pin).

It supports data rates from 4800 to 38400 bps.

The default is 38400 bps. Select the appropriate baud rate for your equipment to be connected.

Default Source Select:

You can set the projector to default to any one of its inputs each time the projector is turned on.

Last Sets the projector to default to the previous or last active input each time the projector is turned on.

Auto Searches for an active source in order of RGB → Video → S-Video → PC Card Viewer → RGB and displays the first found source.

Select Displays the selected source input every time the projector is started up. Select an input from the pull-down menu.

Control Panel Key Lock:

This option turns on or off the Control Panel Key Lock function.

NOTE:

* This Control Panel Key Lock does not affect the remote control and the PC Control functions.

* When the cabinet buttons are disabled, pressing and holding the CANCEL button for about 10 seconds will change the setting to enabled.

Tools

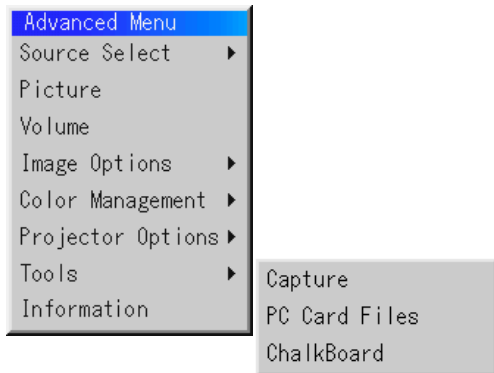

Provides tools for capturing images, displaying files in a CompactFlash Card and drawing.

NOTE: The "Capture" and "PC Card Files" features are required for a CompactFlash card.

Capture:

Allows you to capture an image from a source that is currently being displayed. The image is saved as JPEG in the CompactFlash card.

When you select Capture from the menu, you will get a tool bar. You can capture an image directly using the tool bar when the menu is not displayed.

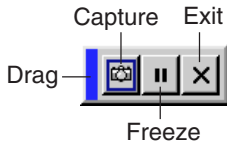

The tool bar includes the following buttons:

- Drag Drags to move the tool bar. (for USB mouse operation only)
- Capture Captures an image and save it as a JPEG file in a CompactFlash card.
- Freeze Freezes and unfreezes images.
- Exit Exits the Capture function.

Unless a CompactFlash card is inserted into the PC Card slot of the projector, the Capture feature is not available.

The "Card Error" display means that the free space of the CompactFlash card is insufficient for saving images. Make more space available on the card by erasing unwanted images with your PC. The number of images that can be captured depends on the size of the CompactFlash card.

NOTE: Be sure not to turn off the power or remove the CompactFlash card while capturing an image. Doing so could cause a loss of the data in the CompactFlash card or damage to the card itself.

NOTE: Captured images with higher resolution than the projector's native resolution cannot be displayed correctly.

PC Card Files:

Displays a list of all the files stored in the CompactFlash card so that you can select a file you want to display. You can also sort files by file name or date, or display the file.

Although a list of all the files in the CompactFlash card is displayed, you can view files in idx, text, HTML, JPEG and BMP format only. Selecting BMP and JPEG files automatically switches to the PC Card Viewer source.

NOTE: When an image with a resolution of XGA(1024×768) or higher is projected, the PC Card Files screen may not be correctly displayed.

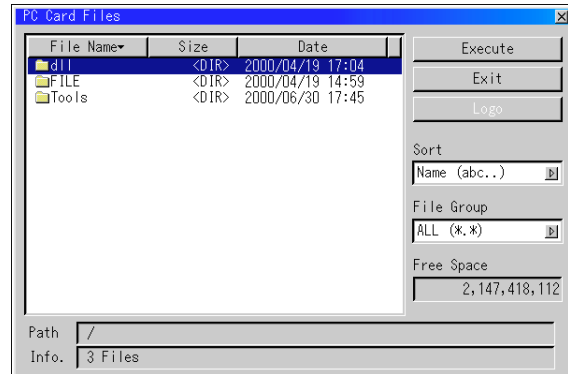

Selecting "Execute" displays the file you selected.

When you select a JPEG or BMP file and press the Enter button on the remote control or the cabinet, or "Execute" on the above, you will get a toolbar. This toolbar is used to return to the PC Card Files screen.



- Drag Drags to move the tool bar. (for USB mouse operation only)
- Return Returns to the PC Card Files screen.
- Close Close the toolbar.

Changing Background Logo

The Logo button allows you to select a background logo from graphic files on a CompactFlash card and change to it as the background logo.

NOTE: File size must be 64KB or less. Other file formats than JPEG and BMP are not available.

1. Use the ▲ or ▼ button to select a JPEG or BMP file for your background logo.

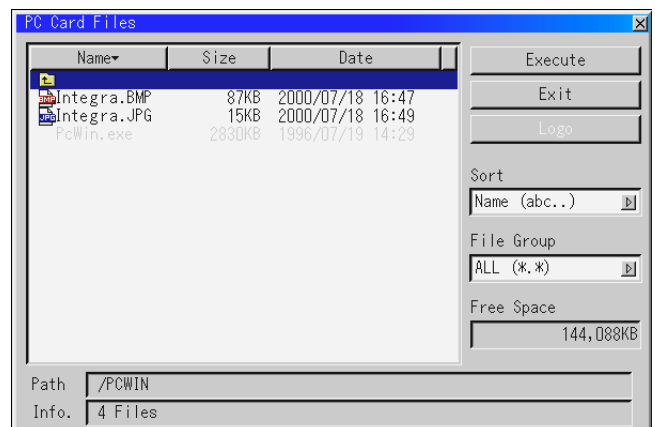

2. Use the ► button and then ▼ button to select “Logo”.
3. Press the Enter on the remote control or the cabinet. You will get the confirmation dialog box.

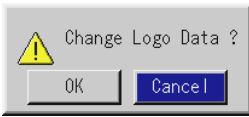

4. Select “OK” and press the Enter button. This completes changing a logo for the background.
- * Once you have changed the background from the Integra logo to another, you cannot return the logo to background even by using Factory Default. To do so, repeat the above steps.

ChalkBoard: (available only when using with USB mouse)
Provides the tool bar for producing freehand drawings.

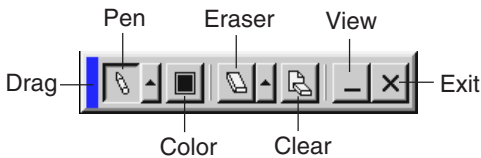

- Drag Drags to move the tool bar. (for USB mouse operation only)
- Pen Left-click and drag to draw. Left-click [▲] or right-click the pen icon to display the pen palette containing four lines of different thickness from which you can select a line you prefer by left-clicking.
- Color Selects a color. Left-click to display the color palette from which you can select a color you prefer by left-clicking.
- Eraser Left-click and drag to erase part of a drawing. Left-click [▲] or right-click the eraser icon to display the eraser palette containing four eraser of different thickness from which you can select an eraser you prefer by left-clicking.
- Clear Left-click to clear the drawing completely from the ChalkBoard screen.
- View Hides the tool bar by left-clicking. Right-clicking anywhere on the screen displays the ChalkBoard tool bar again.
- Exit Clears the complete drawing and exits the ChalkBoard.

NOTE:

- * The ChalkBoard feature is available only when a USB mouse is used. Free-hand drawings cannot be saved or captured.
- * The menu is not available while you display the ChalkBoard screen.
- * The Capture and the Source Display function are not available on ChalkBoard screen.
- * Switching slides clears a drawing completely.

Information

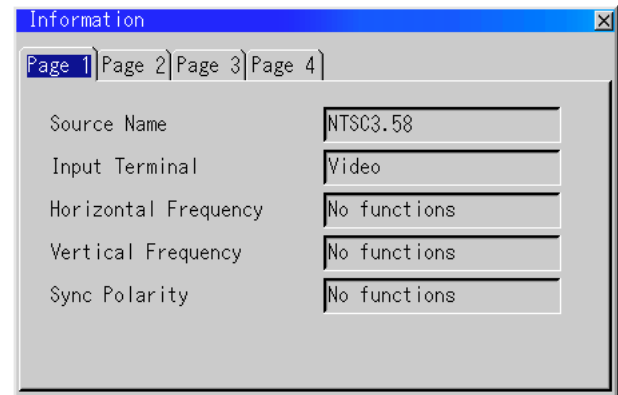

Displays the status of the current signal, and the lamp and the projector usage hours.
This dialog box has four pages.

The information included are as follows:

[Page 1]	[Page 2]
Source Name	Signal Type
Input Terminal	Video Type
Horizontal Frequency	Sync Type
Vertical Frequency	Interlace
Sync Polarity	Resolution
[Page 3]	[Page 4]
Aspect Ratio	Remaining Lamp Time (%)
Gamma Correction	Lamp Hour Meter (H)
Noise Reduction	Projector Usage (H)
Color Matrix	
Matrix Type	

NOTE: The progress indicator shows the percentage of remaining bulb life. The value informs you of the amount of lamp and projector usage respectively.

Remaining Lamp Time Display:

When the remaining lamp time reaches 0, the Remaining Lamp Time bar indicator changes from 0% to 100 Hours and starts counting down. If the remaining lamp time reaches 0 hours, the projector will not turn on regardless of whether the lamp mode is set to Normal or High-Bright.

Using the PC Card Viewer function

Features

The Viewer feature allows slides stored on a CompactFlash memory card (referred to as CompactFlash card in this manual) to be displayed on the projector. Even if no computer is available, presentations can be conducted simply with the projector. This feature is convenient for holding presentations at meetings and in offices, as well as for playing images taken on digital cameras.

Easy to use

- Presentations can be started immediately simply by inserting a CompactFlash card (not supplied)
- Easy slide switching
- Remote control operation
- Jumping to list of slides or any specific slide

High quality images

- High resolution up to 1024 × 768 dots
- 24-bit full color playback
- Viewing of digital camera images

Inserting and Ejecting a CompactFlash Card

A CompactFlash card is used to view presentation data prepared on the computer and to capture and play images projected with the projector.

Inserting the CompactFlash Card

- Hold the CompactFlash card horizontally and insert it slowly into card slot with its top facing up.
- The eject button pops out once the CompactFlash card is fully inserted.

Check that the CompactFlash card is fully inserted.

NOTE: Do not try to force the CompactFlash card into the slot.

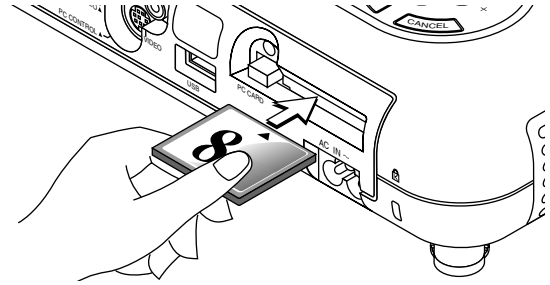

Ejecting the CompactFlash Card

Press the eject button. The CompactFlash card pops out a little. Grasp the edges of the CompactFlash card and pull it out. Do not eject the CompactFlash card while its data is being accessed.

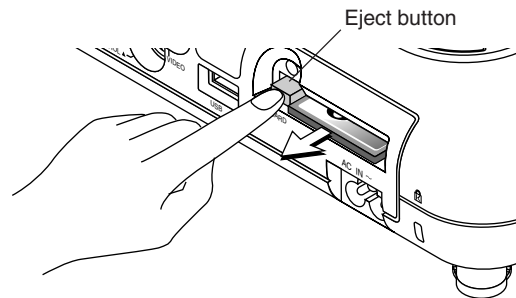

Install the CompactFlash card on a PC card adapter when using on your PC.

- Set the CompactFlash card in the direction shown in the diagram and insert it into the card adapter.

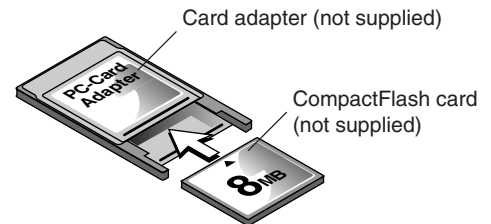

Direction for Inserting the CompactFlash Card

The CompactFlash card has a top and bottom and must be inserted into the PC card slot in a specific direction. It cannot be inserted backwards or upside-down. Attempting to force it into the slot in the wrong direction may break the internal pin and damage the card slot. Refer to the CompactFlash card's operating instructions for the proper direction of insertion.

CompactFlash Card Type

The PC Card slot accepts CompactFlash only.

Operating the PC Card Viewer Function from the Projector (playback)

This section describes the operation for showing slides of presentation documents created using the PC Card Viewer function with the projector.

It is also possible to make slides directly from the images projected with the projector.

Projecting slides

1. Insert a CompactFlash card into the card slot.
Insert the CompactFlash card with the side with the insertion direction arrow on the top.
* Press the eject button to eject the card.
2. Select the "PC Card Viewer" from the Source Select menu.

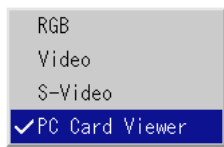







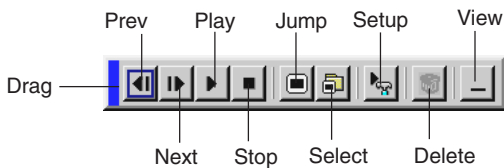



3. Project slides.

Checking "Show Folder List", means that selecting PC Card Viewer input displays a list of the folders in the CompactFlash card and if "Auto Play" is checked the projector automatically starts to play slides at the first slide of the folder you have selected.

A tool bar will appear when you press the MENU button on the remote control or the projector cabinet or clicking with the right button of a mouse.



The tool bar includes the following buttons:

-  Drag: Drags to move the tool bar. This is available for USB mouse operation only.
-  Prev: Returns to the previous slide or folder. Or this lets you play slides back in reverse.
-  Next: Advances to the next slide or folder. Or this lets you play slides back.
-  Play: Plays back automatically or manually depending on the setting on PC Card Viewer Options of the menu. This allows you to move on to the next slide when "Manual Play" is selected.
-  Stop: This allows you to stop Auto Play while you are playing back and to resume playing from the selected slide or folder when "Auto Play" is selected.
-  Jump: Displays a list of slides while you are playing back.
-  Select: Displays a list of folders while you are playing back.
-  Setup: Displays the PC Card Viewer Options dialog box on Page 2 of the Setup dialog box.
-  Delete: Deletes a captured slide(s) or all the captured slides in the Capture – specific folder.
-  View: Hides the tool bar while you are playing back. Pressing the MENU button or clicking with the right button of a mouse shows it again.

NOTE: If no memory card is inserted in the PC CARD slot, there is no signal, and a black, blue or logo background is displayed, depending on the setting.

Playback is stopped when ◀ or ▶ on the remote control or the cabinet is pressed in Auto Play mode.

Capturing Images Displayed on the Projector

Storing images displayed on the projector on the CompactFlash card

Preparations:

Insert the CompactFlash card into the card slot.

Insert the CompactFlash card with the side with the insertion direction arrow on the top.

* Press the eject button to eject the card.

1. Project the image you wish to store on the projector.
2. Select the "Capture" from the Tools menu.

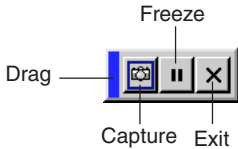
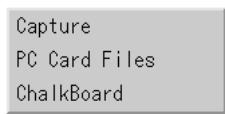

3. A tool bar will appear.

The tool bar includes the following buttons:

Drag: Drags to move the tool bar (for USB mouse operation only).

Capture: Captures an image and save it as a JPEG file in a CompactFlash card.

Freeze: Freezes and unfreezes images.

Exit: Exits the Capture function. Another option to exit the Capture function is to press MENU or CANCEL button on the remote control or projector cabinet.

NOTE: You can compress a captured file (JPEG) using the Capture Options in the Setup dialog. See page 36.

NOTE: Captured images with higher resolution than the projector's native resolution cannot be displayed correctly.

NOTE:

- File size of the captured image varies depending on the resolution of an input signal.
- Since an image data is compressed with the JPEG format, the image is slightly degraded.

NOTE: An hourglass indicating that an image is being captured appears on the projector's display. Do not eject the CompactFlash card or turn off the projector's power while this icon is displayed. Doing so will damage the CompactFlash card data.

If the CompactFlash card data is damaged, use a computer to repair the data.

Deleting Captured Images

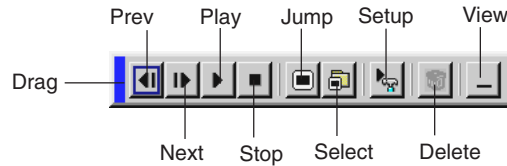

Using the Delete button on the tool bar for PC Card Viewer can delete captured images.

To delete captured images:

- 1) Select PC Card Viewer.
- 2) Use ► button to select the Capture folder in the right bottom of the screen.
- 3) Press the MENU button to display the tool bar.
- 4) Use the ◀ or ▶ button to select the Delete icon and press the ENTER button or click with a mouse button.

Viewing Digital Images

Digital images can be played with the PC Card Viewer if the following conditions are met:

- If the image can be stored on an MS-DOS format CompactFlash card
- If the image can be stored in a format supported by the PC Card Viewer.

With the PC Card Viewer, images on the card are searched for in directories and images in JPEG or BMP format are recognized as slides.

Searchable directories are directories within two steps from the root directory, and searchable images are images within the first 12 files in the directory. Only file and slide switching are possible.

NOTE: The maximum number of images recognized as slides within one directory is 128.

Terminology

PC card	This is the name of a card currently being standardized by the Japan Electronic Industry Association (JEIDA) and PCMCIA (Personal Computer Memory Card Interface Association) of the United States.
ATA card	A type of PC card. ATA was originally a type of interface between computers and fixed disk devices. The ATA card is a standard card-type recording medium.
CompactFlash	CompactFlash card is a small removable card conforming to ATA specifications. It is one-fourth the volume of a PCMCIA card.
TYPE (I, II and III)	PCMCIA 2.1 PC cards are divided into three types according to their thickness: Type I (3.3 mm), Type II (5.0 mm) and Type III (10.5 mm).
BMP	A type of image format. The standard Windows Bit Map format used for MS-DOS/Windows-compatible computers.
JPEG	A type of image format. "JPEG" is the abbreviation of Joint Photographic Experts Group. JPEG compression offers efficient data storage. The data not required for displaying the image is identified and deleted. Since the data is deleted, JPEG algorithms are said to be irreversible. This means that once the image is compressed, the decompressed image it is not the same as the original image.

4. MAINTENANCE

This section describes the simple maintenance procedures you should follow to replace the lamp.

Replacing the Lamp

After your lamp has been operating for 1500 hours (1000 hours in High-Bright mode) or longer, the “Status” light in the cabinet will go on and the message will appear. Even though the lamp may still be working, replace it at 1500 hours (1000 hours in High-Bright mode) to maintain optimal projector performance.

CAUTION

- DO NOT TOUCH THE LAMP immediately after it has been used. It will be extremely hot. Turn the projector off, wait 90 seconds, and then disconnect the power cable. Allow at least one hour for the lamp to cool before handling.
- DO NOT REMOVE ANY SCREWS except the lamp cover screw and three lamp case screws. You could receive an electric shock.
- The projector will turn off and go into stand by mode after 1600 hours (1100 hours in High-Bright mode) of service. If this happens, be sure to replace the lamp. If you continue to use the lamp after 1500 hours (1000 hours in High-Bright mode) of use, the lamp bulb may shatter, and pieces of glass may be scattered in the lamp case. Do not touch them as the pieces of glass may cause injury. If this happens, contact your Integra dealer for lamp replacement.

To replace the lamp:

- 1 Loosen the lamp cover screw until the screwdriver goes into a freewheeling condition and remove the lamp cover. The lamp cover screw is not removable.

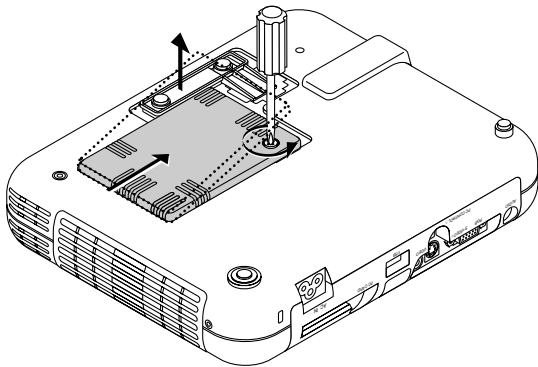

- 2 Loosen the three screws securing the lamp housing until the screwdriver goes into a freewheeling condition. The three screws are not removable.

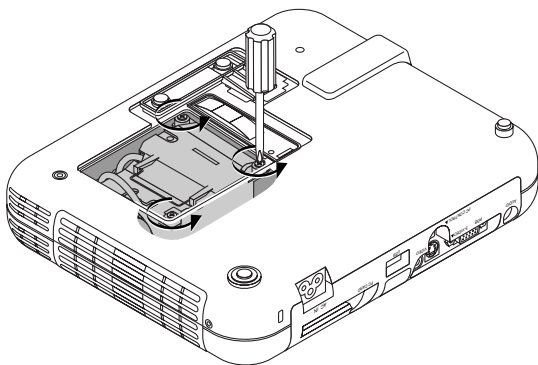

- 3 Remove the lamp housing by pulling out the handle.

NOTE: There is an interlock on this case to prevent the risk of electrical shock. Do not attempt to circumvent this interlock.

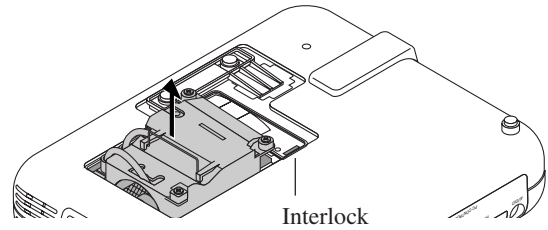

- 4 Insert a new lamp housing until the lamp housing is plugged into the socket.

CAUTION: Do not use a lamp other than the Integra replacement lamp. Order this from your Integra dealer.

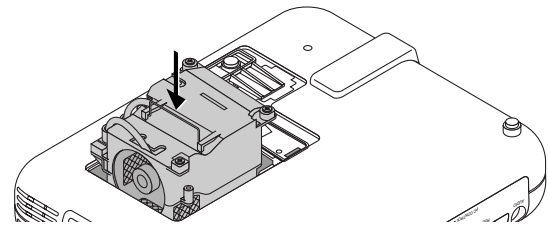

- 5 Secure it in place with the three screws.

Be sure to tighten the screws.

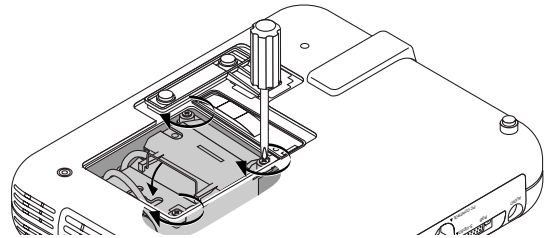

- 6 Reattach the lamp cover.

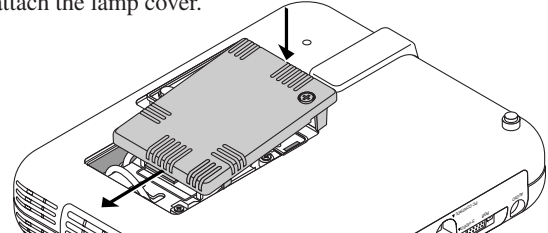

- 7 Tighten the lamp cover screw.

Be sure to tighten the screw.

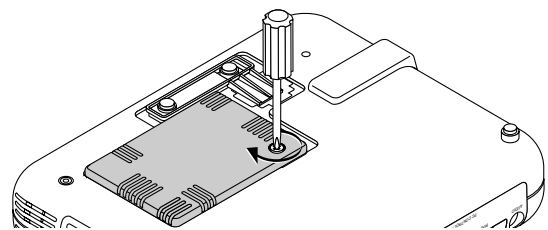

- 8 After you install a new lamp, select the Main menu → [Projector Options] → [Setup] → [Page 4] → [Clear Lamp Hour Meter] to reset the lamp usage hours. If the projector will not be turned on after using 1600 hours (1100 hours in High-Bright mode) of service, press and hold the “Lamp Reset” button on the remote control for ten seconds or longer to reset the lamp time clock to zero.

5. TROUBLESHOOTING

This section helps you resolve problems you may encounter while setting up or using the projector.

Power/Status Light Messages

Condition	Power Indicator	Status Indicator	Note
Standby	Steady orange	–	–
Cooling down	Blinking green	–	Blinks green for 90 seconds
Lamp in Normal mode	Steady green	–	–
Lamp in High-Bright mode	Steady green	Steady green	–
Retrying to turn on lamp	Steady green	Blinking orange	The projector retries 3 times at an interval of 15 sec for max. 45 sec)
One minute after lamp is turned on	Blinking green	No light in Normal mode / Steady green in High-Bright mode	–
Lamp has reached its end of life (High-Bright: 1000 hours or over) (Normal: 1500 hours or over)	Steady green	Steady red	Message appears on screen during 1500-1600 hours (1000-1100 hours: High-Bright mode) of lamp usage. The projector reaches its end of life. Please replace the lamp as soon as possible
Lamp life has reached its end of life (High-Bright: 1100 hours or over) (Normal: 1600 hours or over)	Steady orange	Steady red	The projector is in standby mode and cannot be turned on.
Lamp cover error	Steady orange	Blinking red (1 sec interval)	The projector is in standby mode and cannot be turned on.
Temperature error	Steady orange	Blinking red (4 sec interval)	The projector is in standby mode and cannot be turned on.
Fan error	Steady orange	Blinking red (8 sec interval)	The projector is in standby mode and cannot be turned on.
Lamp error	Steady orange	Blinking red (12 sec interval)	The projector is in standby mode and cannot be turned on.

Common Problems & Solutions

Problem	Check These Items
Does not turn on	<ul style="list-style-type: none"> • Check that the power cable is plugged in and that the power button on the projector cabinet or the remote control is on. • Ensure that the lamp cover is installed correctly. See page 44. • Check to see if the projector has overheated or the lamp usage exceeds 1100 hours (up to 1600 hours : Normal mode). If there is insufficient ventilation around the projector or if the room where you're presenting is particularly warm, move the projector to a cooler location.
No picture	<ul style="list-style-type: none"> • Use the menu to select your source (Video, S-Video, RGB or PC Card Viewer). See page 31. • Ensure your cables are connected properly. • Use menus to adjust the brightness and contrast. See page 31. • Remove the lens cap. • Reset the settings or adjustments to factory preset levels using the Factory Default in the Adjustment Menu. See page 33.
Image isn't square to the screen	<ul style="list-style-type: none"> • Reposition the projector to improve its angle to the screen. See page 23. • Use the Keystone in the Adjustment Menu to correct the trapezoid distortion. See page 32.
Picture is blurred	<ul style="list-style-type: none"> • Adjust the focus. See page 23. • Reposition the projector to improve its angle to the screen. See page 23. • Ensure that the distance between the projector and screen is within the adjustment range of the lens. See page 14.
Image is scrolling vertically, horizontally or both	<ul style="list-style-type: none"> • Use menus or Source button on the remote control or the cabinet to select the source you want to input.
Remote control does not work	<ul style="list-style-type: none"> • Install new batteries. See page 13. • Make sure there are no obstacles between you and the projector. • Stand within 22 feet (7 m) of the projector. See page 13.
Status indicator is lit or blinking	<ul style="list-style-type: none"> • See the Status Light messages above.
Cross color in RGB mode	<ul style="list-style-type: none"> • If Auto Adjust is off, turn it on. If Auto Adjust is on, turn it off and balance the image with the Position/Clock in the Image Options. See page 33 or 36.

When using the PC Card Viewer function

Problem	Check These Items
No picture	<ul style="list-style-type: none"> • Is "PC Card Viewer" selected from the Source menu? • Is the CompactFlash memory card seated in the PC CARD slot completely? • Are slide data stored in the CompactFlash memory card? • Have the contents of the CompactFlash memory card been destroyed?
Part of a slide is not displayed	<ul style="list-style-type: none"> • While an image with over 1024×768 dots is projected, several lines of information will be lost.
Contents of CompactFlash Card are damaged	<ul style="list-style-type: none"> • Use a computer, etc., to repair the data.

For more information contact your dealer.

6. SPECIFICATIONS

This section provides technical information about the DLV-100 Projector's performance

Model Number DLV-100

Optical

DMD™ Single Chip Digital Micromirror Device(DMD™), 1024x768 dots
Lens Manual zoom, Manual focus: F2.6 – 2.8 f= 28.3 – 34.0mm
Lamp 135 W NSH lamp
(The lamp is warranted for 1000 hours of operation time within 6 months.)
Image Size 30 - 200 inches (0.8 - 5.1 m) diagonal
Projection Distance 3.8 – 31.7ft (1.16 – 9.67m)

Electrical

Inputs Video (NTSC / PAL / PAL-N / PAL-M / PAL60 / SECAM / NTSC4.43)
Horizontal Frequency : 15 -100 kHz (RGB : 24 kHz or over)
Vertical Frequency : 50 -120 Hz
Video Bandwidth RGB: 80 MHz (-3dB)
Color Reproduction Full color, 16.7 million colors simultaneously.
Horizontal Resolution 550 TV lines : NTSC / PAL / YCbCr
300 TV lines : SECAM
RGB 1024 dots horizontal, 768 dots vertical
Power Requirement 100 - 120 / 200 - 240 V AC, 50 / 60 Hz
Input Current 2.2 A (100 -120 V AC) / 1.1A (200 -240 V AC)

Mechanical

Dimensions 9.6" (W) x 2.1" (H) x 7.7" (D) / 243mm (W) x 53mm (H) x 196mm (D) (not including protrusions)
Net Weight 3.3 lbs / 1.5 kg
Environmental Considerations Operational Temperatures : 41° to 95°F (5° to 35°C), 20 to 80% humidity
Storage Temperatures :14° to 122°F (-10° to 50°C), 20 to 80% humidity
Regulations UL Approved (UL 1950, CSA 950)
Meets DOC Canada Class B requirements
Meets FCC Class B requirements

Digital Light Processing, DLP, Digital Micromirror Device and DMD are trademarks of Texas Instruments.

The specifications are subject to change without notice.

Cabinet Dimensions

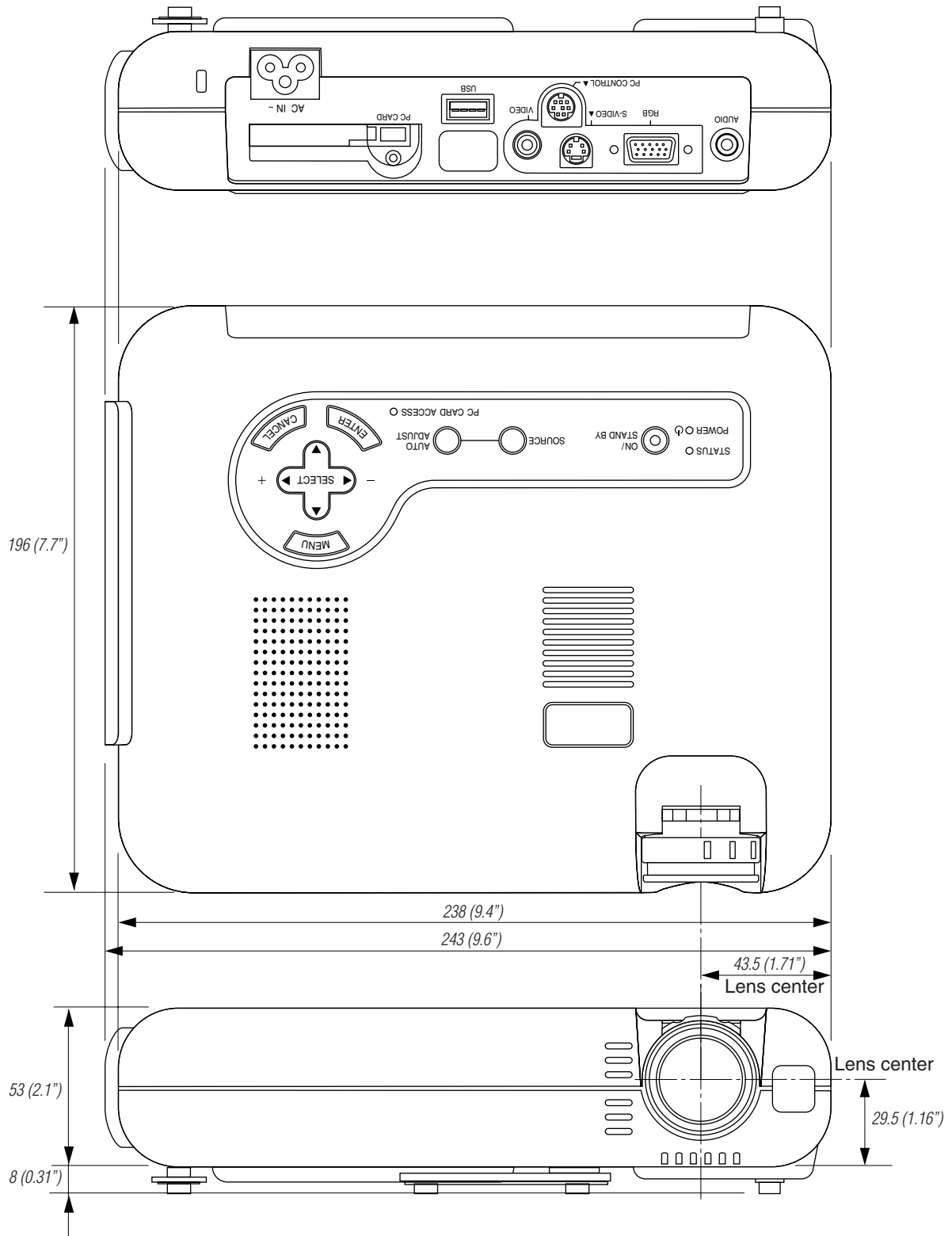

Unit = mm (inch)

D-Sub Pin Assignments

Mini D-Sub 15 Pin Connector

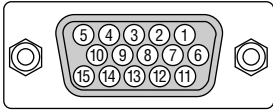

Signal Level
Video signal : 0.7Vp-p (Analog)
Sync signal : TTL level

Pin No.	RGB Signal (Analog)	YCbCr Signal
1	Red	Cr
2	Green or Sync on Green	Y
3	Blue	Cb
4	Ground	
5	Ground	
6	Red Ground	Cr Ground
7	Green Ground	Y Ground
8	Blue Ground	Cb Ground
9	No Connection	
10	Sync Signal Ground	
11		
12	Bi-directional DATA (SDA)	
13	Horizontal Sync or Composite Sync	
14	Vertical Sync	
15	Data Clock	

Compatible Input Signal List

Signal	Resolution (Dots)	Frequency H. (kHz)	Refresh Rate (Hz)	Dot Clock (MHz)
NTSC	–	15.734	60	-
PAL	–	15.625	50	-
SECAM	–	15.625	50	-
VESA	640 × 480	31.47	59.94	25.175
IBM	640 × 480	31.47	60	25.175
MAC	640 × 480	31.47	60	25.175
MAC	640 × 480	34.97	66.67	31.334
MAC	640 × 480	35	66.67	30.24
VESA	640 × 480	37.86	72.81	31.5
VESA	640 × 480	37.5	75	31.5
IBM	640 × 480	39.375	75	31.49
VESA	640 × 480	43.269	85.01	36
IBM	720 × 350	31.469	70.09	28.322
VESA	720 × 400	37.927	85.04	40
IBM	720 × 350	39.44	87.85	35.5
IBM	720 × 400	39.44	87.85	35.5
VESA	800 × 600	35.16	56.25	36
VESA	800 × 600	37.879	60.32	40
VESA	800 × 600	48.077	72.19	50
VESA	800 × 600	46.88	75	49.5
VESA	800 × 600	53.674	85.06	56.25
MAC	832 × 624	49.725	74.55	57.283
VESA	1024 × 768	35.5	43 Interlaced	44.9
VESA	1024 × 768	48.363	60	65
VESA	1024 × 768	57.476	70.07	75
MAC	1024 × 768	60.241	74.93	80
VESA	1024 × 768	60.023	75.03	78.75
VESA	1024 × 768	68.677	85	94.5
# VESA	1152 × 864	67.5	75	108
# MAC	1152 × 870	68.681	75.6	100
# SUN	1152 × 900	61.796	65.95	92.94
# SGI	1152 × 900	71.736	76.05	105.6
# VESA	1280 × 960	60	60	108
# VESA	1280 × 1024	64.286	60.02	108
# MAC	1280 × 1024	65.2	69.89	118.5
# HP	1280 × 1024	78.125	72.01	135
# SUN	1280 × 1024	81.13	76.11	135
# VESA	1280 × 1024	79.976	75.03	135
# VESA	1280 × 1024	91.146	85.02	157.5
# HDTV (1080i)(1125i)	1920 × 1080	33.75	60 Interlace	74.25
# HDTV (1080i)(1125i)	1920 × 1080	28.13	50 Interlace	74.25
# HDTV (720p)(750p)	1280 × 720	45	60 Progressive	74.25
# SDTV (480p)(525p)	–	31.47	59.94 Progressive	27
# SDTV (480i)(525i)	–	15.73	59.9 Interlace	–
# VESA	1600 × 1200	75.0	60	162
# VESA	1600 × 1200	81.3	65	175.5
# VESA	1600 × 1200	87.5	70	189
# VESA	1600 × 1200	93.75	75	202.5

#: Images in above flagged with # are compressed with Advanced AccuBlend.

NOTE1: Some composite sync signals may not be displayed correctly.

NOTE2: Signals other than those specified in the table above may not be displayed correctly. If this should happen, change the refresh rate or resolution on your PC. Refer to Display Properties help section of your PC for procedures.

NOTE3: UXGA (1600×1200) is supported for separate sync signal only.

PC Control Codes

Function	Code Data
POWER ON	02H 00H 00H 00H 00H 02H
POWER OFF	02H 01H 00H 00H 00H 03H
INPUT SELECT RGB	02H 03H 00H 00H 02H 01H 01H 09H
INPUT SELECT VIDEO	02H 03H 00H 00H 02H 01H 06H 0EH
INPUT SELECT S-VIDEO	02H 03H 00H 00H 02H 01H 0BH 13H
INPUT SELECT PC CARD VIEWER	02H 03H 00H 00H 02H 01H 1FH 27H
PICTURE MUTE ON	02H 10H 00H 00H 00H 12H
PICTURE MUTE OFF	02H 11H 00H 00H 00H 13H
SOUND MUTE ON	02H 12H 00H 00H 00H 14H
SOUND MUTE OFF	02H 13H 00H 00H 00H 15H
ON SCREEN MUTE ON	02H 14H 00H 00H 00H 16H
ON SCREEN MUTE OFF	02H 15H 00H 00H 00H 17H

NOTE: Contact your local dealer for a full list of PC Control Codes if needed.

Cable Connection

Communication Protocol

Baud rate:	38400 bps
Data length:	8 bits
Parity:	No parity
Stop bit:	One bit
X on/off:	None
Communications procedure:	Full duplex

PC Control Connector (DIN-8P)

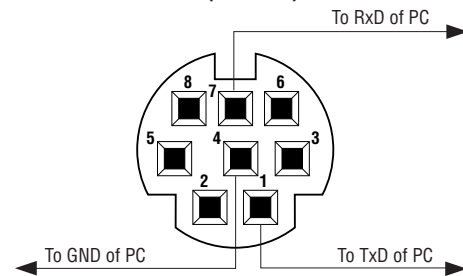

NOTE: Pins 2, 3, 5, 6 and 8 are used inside the projector.

Integra Division of

ONKYO U.S.A. CORPORATION

18 Park Way, Upper Saddle River, N.J. 07458, U.S.A.

Tel: 201-785-2600 Fax: 201-785-2650 <http://www.integrahometheater.com>

Integra Division of

ONKYO CORPORATION

Sales & Product Planning Div. : 2-1, Nisshin-cho, Neyagawa-shi, OSAKA 572-8540, JAPAN

Tel: 072-831-8111 Fax: 072-833-5222

SN 29343259A

W0109-1

