

in sink erator®

Series 2200
Series 1100

Instant Hot Water Dispenser Owner's Manual

Installation, Care & Use

Instalacion, cuidado & uso

Installation, soin et utilisation



EMERSON
Appliance Solutions



We are delighted that you have chosen the InSinkErator® Instant Hot Water Dispenser to be a part of your home. This unique appliance will save you time and effort in the kitchen, and you'll enjoy discovering new uses for it each day. That's exactly why millions of people are now using an InSinkErator Instant Hot Water Dispenser.

We are confident that by following our step-by-step instructions, you'll soon be enjoying the convenience of instant hot water.

WHAT YOU SHOULD KNOW BEFORE YOU BEGIN

- For your satisfaction and safety, read all instructions, cautions, warnings and dangers before installing or using this instant hot water dispenser.
- This particular unit is not intended for commercial use.
- Make sure that all electrical wiring and connections conform to local codes.
- A standard 120-volt grounded electrical outlet is required under the sink for the dispenser's electrical power.
- The wall outlet powering your dispenser must have power supplied to it continuously.
- This outlet must be fused and should not be controlled by the same wall switch that operates the disposer, unless you have a SinkTop Switch™ from InSinkErator®.
- It is recommended that a dedicated control valve be installed on the cold water line supplying water to this system.
- If you suspect elevated levels of chlorine in your water, it is recommended to use our water filtration system.
- The use of a water filter should NOT result in the water pressure to drop below 30 psi (207kPa). If it does, this will prevent your unit from operating properly.
- Moving parts inside the tank causing a rattling noise is normal.

WHAT YOU NEED TO GET STARTED

Equipment Required:

- | | |
|--|---|
| <input type="checkbox"/> Drill | <input type="checkbox"/> Phillips and flat blade screwdrivers |
| <input type="checkbox"/> T-fitting | <input type="checkbox"/> Pencil |
| <input type="checkbox"/> Dedicated control valve | <input type="checkbox"/> Tape measure |
| <input type="checkbox"/> Adjustable wrench | <input type="checkbox"/> Level |

Equipment You May Need:

- | | |
|--|---------------------------------------|
| <input type="checkbox"/> Anchors for drywall | <input type="checkbox"/> Basin wrench |
| <input type="checkbox"/> Hole saw | <input type="checkbox"/> Hole punch |

If you intend to use the sprayer hole in your sink for your dispenser, you may need a basin wrench and a 1/8" plug or a 1/4" cap (**not supplied**) for the faucet spray hose line. **See Step 1-B.**

If you need to cut a mounting hole in your stainless steel sink, you may need a 1¼" - 1½" hole saw made for cutting stainless steel or a hole punch. Consult a professional if you are drilling into a surface other than stainless steel.

Identify the model of your instant hot water dispenser and record it here: _____

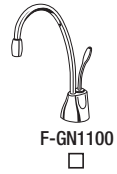
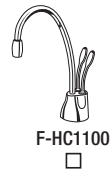
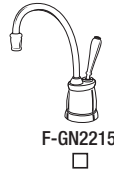
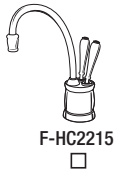

HOW TO USE THIS INSTRUCTION MANUAL

These instructions are separated into main sections, indicated by numbers, and subsections, indicated by capital letters. The manual is setup this way to allow you to take a break at any point after completing a section or subsection without affecting the installation process.

What you'll see in the instruction manual:

INSTALLING THE FAUCET

A

Unpack dispenser components.
 On a firm, flat surface, carefully straighten the copper tubing.

CAUTION
Property Damage: Do not pinch or break copper tubing. Do not distort the last 1 inch of tubing.

- 1 Provides a step-by-step narrative describing the installation step, with check boxes that can be marked as you progress through the installation.
- 2 Contains simple illustrations that provide visual instruction to support the narrative.
- 3 CAUTIONS, WARNINGS and DANGERS that will require your attention during the step.

⚠ DANGER An imminently hazardous situation, which, if not avoided, will result in death or serious injury.

⚠ WARNING A potentially hazardous situation, which, if not avoided, could result in death or serious injury.

⚠ CAUTION A potentially hazardous situation, which, if not avoided, may result in minor or moderate injury.

OVERVIEW OF A COMPLETED SETUP

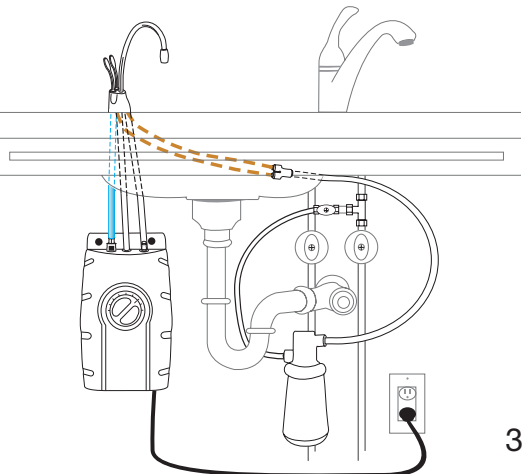

COMPONENTS IN THIS PACKAGE

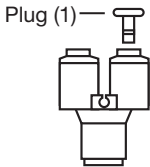
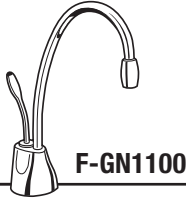
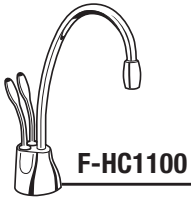
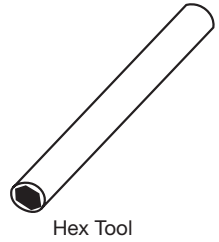
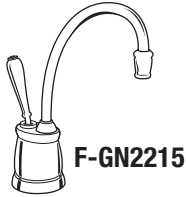
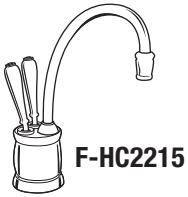
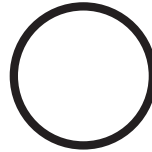
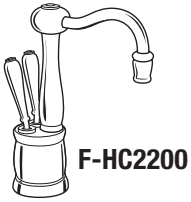

Quick Connector

Filter Head

Filter Cartridge

Snap-Connect Fitting (3 pieces)

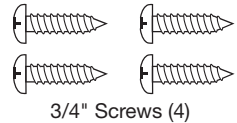
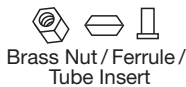
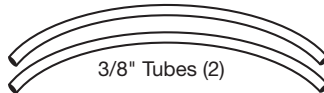
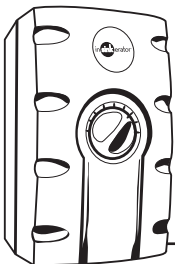

IF INSTALLING ONLY NEW FAUCET

A

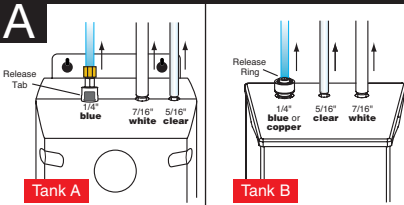

- Determine if your existing tank is **A**, gray plastic shell, or **B**, white metal shell.
- At tank top, depress gray release tab (if A) or release ring (if B) into quick-connect fitting securing **blue or copper** 1/4" tube and gently pull line out of fitting. Pull **white** 7/16" tube and **clear** 5/16" tube off fittings.
- Remove existing faucet.

CAUTION

Property Damage: Do not pinch or break copper tubing. Do not distort the last 1 inch of tubing.

B

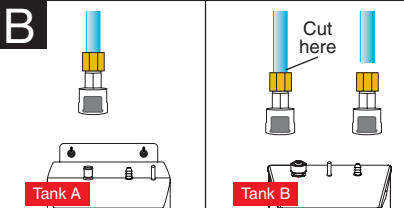

Tank A

- The snap-connect fitting will be attached directly to the tank.

Tank B

- Cut off snap-connect fitting at the end of the **blue** 1/4" tube.
- Insert blue tube into fitting on tank.
- Skip to Step 2 (pages 7-11) for complete installation instructions.

CAUTION

Property Damage:
Turn off water & unplug tank.

IF INSTALLING ONLY NEW TANK

A

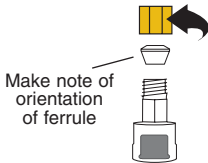

- At tank top, depress release ring or gray release tab into quick-connect fitting securing **blue** 1/4" tube and gently pull line off tank fitting. Pull **white** 7/16" tube and **clear** 5/16" tube off fittings.
- If not already equipped, the included snap-connect fitting must be installed.
- To install snap-connect fitting, unscrew brass mounting nut and remove snap-connect fitting, brass ferrule and nut.

CAUTION

Property Damage:
Unplug tank before connecting faucet.

B

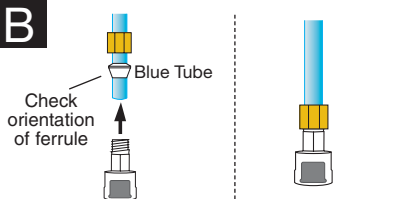

- Slide brass nut and ferrule on to the 1/4" **blue or copper** tube running from the faucet.
- Insert **blue or copper** tube into snap-connect fitting and tighten brass nut with a wrench, 1 to 2 turns clockwise.
- You may elect to use existing tank mounting bracket.
- Skip to Steps 3-4 (page 8) for complete installation instructions.

CAUTION

Property Damage:
Do not over tighten brass nut.

START HERE PROPER INSTALLATION SHOULD TAKE ABOUT 2-4 HOURS

1

PREPARATION

A

Required minimum from center of hole to wall

F-HC2215	3 ³ / ₈ "
F-GN2215	3 ³ / ₈ "
F-HC2200	3 ³ / ₈ "
F-GN2200	3 ³ / ₈ "
F-HC1100	3 ³ / ₈ "
F-GN1100	4 ¹ / ₂ "

Maximum counter thickness is 3".

- Identify locations for the dispenser faucet, tank and filter.
- Check to make sure there is proper clearance for dispenser handles to be fully opened.
- Check to make sure counter is 3" thick or less.
- Make sure there is a grounded electrical outlet under the sink.

The wall outlet for your dispenser must have power supplied to it continuously and must be fused. It should not be controlled by the same wall switch that operates your disposer.

B

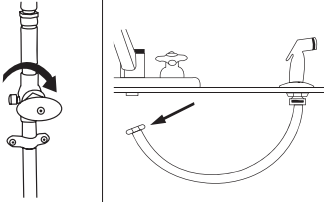

If you have to drill through sink or countertop, you may need to rent or purchase the appropriate tools.

- Turn off water supply.
- If using the sink sprayer hose hole, remove nut that connects sprayer hose at bottom of faucet.
- Using adjustable wrench, remove nut connecting sprayer washer flange in sprayer hole.
- Plug hose opening with either a 1/8" plug or a 1/4" cap (**not supplied**).

C

Required Hole Size

Hot & Cool Models	1 ³ / ₈ " - 1 ¹ / ₂ "
Hot Only Models	1 ¹ / ₄ " - 1 ¹ / ₂ "

Consult a professional before drilling into a surface other than stainless steel.

What if you don't have a sprayer hole or don't want to use it?

- Many homeowners replace the soap dispenser in their sink with an instant hot water dispenser.
- If drilling a hole into a stainless steel sink or counter top, you can cut a mounting hole for the dispenser with a hole saw for stainless steel, or you can use a hole punch.

2

INSTALLING THE FAUCET

A

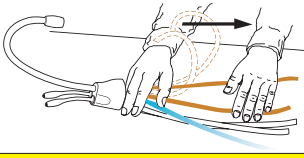

- Unpack dispenser components.
- On a firm, flat surface, carefully straighten the copper tubing.

⚠ CAUTION

Property Damage: Do not pinch or break copper tubing. Do not distort the last 1 inch of tubing.

B



- Ensure that the black O-ring is properly seated in the base of the dispenser head (the groove on the underside of the dispenser).

Make sure to use rubber O-ring to ensure proper seal.

C

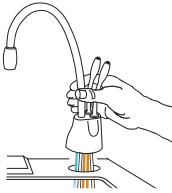

- Feed tubes down through the hole in the sink or countertop until the base is at rest on the sink or countertop surface.

An assistant may be needed to hold the dispenser head in place while securing the dispenser.

D

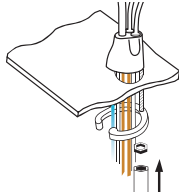

- From under the sink, place the semi-circular mounting plate onto the threaded stud.
- Place hex nut onto the threaded stud. Ensure faucet head is at desired angle.
- Insert screwdriver into hole on side of hex tool (creating a "T"), and use tool to tighten nut and secure faucet.

Semi-circular mounting plate should encircle all descending tubes and extend beyond sink hole when tight.

3

MOUNTING THE TANK

A



Tank must be mounted level to ensure proper operation.

- Select a spot under the sink to mount tank vertically within reach of both plumbing and electrical connections. The tank should be within 16" or less of faucet water lines and within 30" or less of a standard grounded outlet.
- While holding tank in place on the spot selected for installation, use a pencil to mark locations for 2 hanging screws.

⚠ WARNING

Property Damage: Tank must be located within 16" of faucet and within 30" or less of a standard grounded outlet. DO NOT extend plumbing or electrical lines.

B

Leave 1/4" for hanging tank.

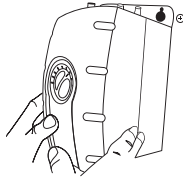
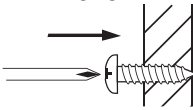

Screws provided are for use in wood studs or cabinets only. Use wall anchors (not supplied) for installation into drywall.

- Pre-drill 1/8" pilot holes at marks.
- Turn screws into pre-drilled holes, leaving 1/4" exposed.
- Hang the tank on the screws.
- Tighten the screws with only 1/2 turn clockwise.

Mount tank vertically in an area that allows clearance on the underside of the tank for drainage, if necessary. DO NOT over tighten screws.

4

CONNECTING FAUCET TO TANK

A

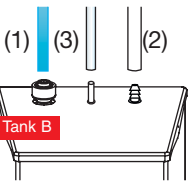
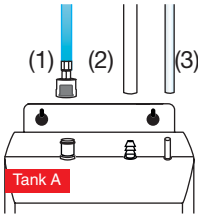

Tank A

- Without depressing the gray button, place the snap-connect fitting at the end of the **blue** 1/4" tube onto the left fitting on the tank, pushing until it clicks into place. (1)

Tank B

- Insert **blue** 1/4" tube into quick-connect fitting at left. (1)

Both Tanks

- Slip the flexible **white** 7/16" tube over barbed steel fitting and slide down approximately 1/2". (2)
- Slip the **clear** 5/16" tube over the smooth plastic fitting and slide down approximately 1/2". (3)
- Check for pinched or crimped tubes.

Hose clamps are not needed for any of the connections.

⚠ CAUTION

Property Damage: Pinched or blocked water lines may cause damage to the dispenser tank.

Property Damage: Check to make sure tubes are connected properly and are pushed down as far as possible.

5

INSTALLING FILTRATION SYSTEM

A

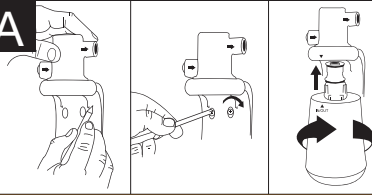

- Mark hole locations for filter head and bracket in a spot that allows for filter replacement.
- Drill 1/8" starter holes and attach bracket to wall with wood screws, turning until snug.
- Remove red filter cap, insert filter cartridge into filter head and twist clockwise until "LOCK" arrow on the filter aligns with arrow on bracket.

⚠ WARNING

Personal Injury: Do not locate filter above an outlet or other electrical device. Install head and bracket so that connections require no stretching, kinking or pinching of tubing.

B

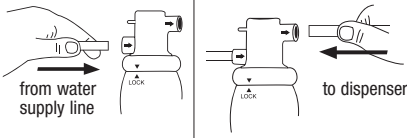

- Determine length of tubing required, then cut to length making sure the cut is perpendicular and burr-free.
- Insert a **white** 3/8" tube into inlet side of filter head until it stops. **Press in again to ensure a secure fit.**
- Insert the other **white** 3/8" tube into outlet side of filter head until it stops. **Press in again to ensure a secure fit.**

⚠ CAUTION

Property Damage: Tube runs need to form to the cabinet's contours to allow storage space with no sharp bends. Tubes need clean, perpendicular, burr-free cuts to ensure a true fit.

C

Hot & cool models

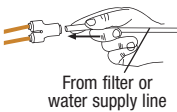

Hot only models

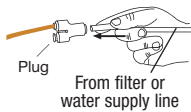

- Insert the copper tube(s) from the dispenser into the 3/8" to 1/4" quick-connect fitting.
- Connect the **white** 3/8" tube from the right outlet on the filter head into the quick-connect fitting until it stops. **Press in again to ensure a secure fit.**

⚠ CAUTION

Property Damage: Do not extend the copper lines farther than the 16" provided.

To remove tube(s) or plug from quick-connector, depress the release ring and gently pull away.

D

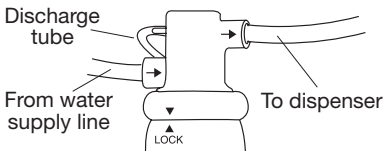

- To redirect filter replacement water discharge, place 6" clear tube over vent hole on the left side of filter head. **Note:** 3/8" fitting is required to make connection to water supply.
- Connect remaining **white** 3/8" tube to incoming water supply line. (See Step 6.)

It is normal for approximately 2 oz. of water to discharge when filter is removed.

6

FINAL WATER CONNECTION

A

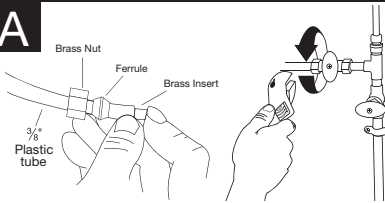

- Install a T-fitting (*not included*) onto the cold water supply line.
- Install dedicated water control valve with 3/8" compression fitting.
- At the end of the **white** 3/8" tube from the filter or quick-connector, slide the supplied brass nut and ferrule over the tube and then push in the brass tube insert.
- Insert the **white** 3/8" tube into the 3/8" compression fitting and tighten.

⚠ CAUTION

Property Damage: Join remaining tube to cold water supply only.

B

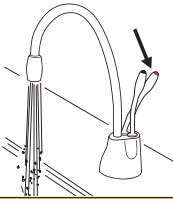

- Turn on the cold water supply.
- Depress the dispenser's **HOT** handle and hold it until water flows from the spout.
- Run the water for at least 2 minutes to flush lines (both the hot and cold handles independently if applicable).

⚠ WARNING

Scalding Hazard: The faucet dispenses near-boiling (212°F) water which can instantly cause scalds or burns. Use care when operating this appliance.

C

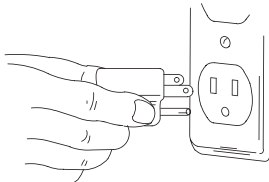

- Check all connections to ensure they are tight and that there are no leaks.
- Plug in instant hot water tank.

Water will be cold at first.

Allow 12-15 minutes for water to reach target temperature.

Gurgling or hissing is normal during the initial heating cycle.

⚠ WARNING

Property Damage: A standard grounded outlet within 30" of the dispenser is required under the sink. Do not use an extension cord set with the dispenser.

If the water coming from the faucet is not hot 15 minutes after the unit has been plugged in – or for other issues related to the operation of your instant hot water dispenser – refer to the "Troubleshooting" section on Page 14.

⚠ DANGER

Electric Shock Hazard: Using an ungrounded or improperly connected appliance can result in serious injury or death from electrical shock.

This appliance must be grounded. This instant hot water dispenser is equipped with a cord that has a grounding conductor and a grounding pin. The plug must be connected to an appropriate outlet that is properly installed and grounded in accordance with all local codes and ordinances. Do not modify the plug provided with the appliance – if it will not fit the outlet, have a proper outlet installed by a qualified electrician. Check with a qualified electrician or serviceman if you are in doubt as to whether the instant hot water dispenser is properly grounded.

⚠ CAUTION

Personal Injury: This tank is a non-pressurized tank. DO NOT modify this system. DO NOT close vent tube or connect other type dispensers or valves to the tank. Use only the InSinkEratator dispenser faucet supplied. Use only parts provided. Contact an authorized InSinkEratator Service agent for repairs or replacement components.

⚠ WARNING

Fire Hazard: To minimize possibility of fire, DO NOT store flammable items such as rags, paper or aerosol cans near the tank. DO NOT store or use gasoline or other flammable vapors and liquids in the vicinity of this or any other appliance.

⚠ CAUTION

Property Damage: To avoid water damage, replace any loose or split tubing. Periodically inspect the unit for any signs of leakage and immediately remove from service any unit suspected of leaking.

An instant hot water dispenser, like any water heater, has a limited life and will eventually fail. To avoid possible property damage, this instant hot water dispenser should be regularly examined for leakage and replaced when necessary. A drain pan, plumbed to an appropriate drain or outfitted with a leak detector, should be used in those applications where any leakage could cause property damage.

WARRANTY INFORMATION

Dispenser: 5-year warranty

Stainless Steel Tank: 3-year warranty

Filtration System: 1-year warranty (excluding replaceable filter cartridge)

Covers all replacement parts and labor to correct defects in material or workmanship in the dispenser system, excluding the replaceable filter cartridge, for the full warranty period from the date of installation in your home. If warranty service is required during the warranty period, contact an authorized InSinkEratator service agent to replace or repair the unit in your home at no cost to you. If your dispenser is replaced rather than repaired, the warranty on the new unit shall be for the duration of the remaining portion of the original dispenser's warranty. *Note: Warranty is determined by unit serial number and/or date of installation. Purchase or installation receipt may be required to verify warranty status. When service is required, and for the location of your nearest factory authorized service center, call toll free 1-800-558-5700.*

The foregoing warranty does not apply to damage or inoperation resulting from accident, alteration, misuse, abuse, improper installation, installation not in accordance with these instructions or local electrical and/or plumbing codes. We do not assume any responsibility for consequential damage. Install using genuine InSinkEratator® manufactured components only. Use of non InSinkEratator components will void your warranty.

Some states do not allow limitations on how long an implied warranty lasts, or the exclusion or limitations of incidental or consequential damages, so the above limitations or exclusion may not apply to you. This warranty gives you specific legal rights, and you may also have other rights which vary from state to state.

CARE AND USE

⚠ DANGER

Electric Shock Hazard: To prevent electrical shock, disconnect power before servicing unit. Use only a properly grounded and polarized electric outlet.

ADJUSTING THE THERMOSTAT

Factory temperature pre-set is 200°F.

To reset the thermostat to 200°, turn the indicator one notch to the right of vertical.

- Adjust the thermostat slowly, turning the dial clockwise to increase temperature or counter clockwise to decrease temperature, then activate faucet handle for 20 seconds to bring in fresh water to be heated at the new setting. Allow 5-7 minutes for water to reach new temperature.

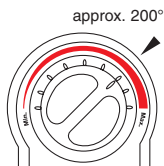

⚠ WARNING

Scalding Hazard: Do not allow water to boil. May result in severe burns.

SEASONAL STORAGE/DRAINAGE

Anytime the instant hot water dispenser is not used for extended periods of time, unplug and drain unit. If it is below freezing you will need to unplug the unit and drain it.

- Disconnect power from unit.
- Push hot water dispenser faucet lever and allow water to flow until it is cool.
- Shut the cold water supply off at the valve.
- If drain screw equipped**, locate and remove from bottom center of water tank and drain the water into empty pail.
 - Empty the tank and then reinstall drain screw onto the bottom of tank, turning until snug. Do NOT over tighten.
- If drain screw not equipped**, disconnect water supply tubes, remove tank and invert to drain. Remount tank.
- Remove and drain filter cartridge. Reinstall.
- To place back in working order, fill tank with water and re-connect the plug.

CLEANING THE FAUCET AND TANK

- Only use mild cleaners to clean the faucet and plastic components.
- Cleaners with acids, abrasives, alkaline or organic solvents will result in deterioration of the plastic components and void the warranty.

FILTER GUIDE AND REPLACEMENT

Replace filter cartridge when there is an obvious decrease in water flow to the faucet or if there is an objectionable taste or odor to the water.

When the inlet and outlet ports have been closed and the filter's internal pressure has been relieved, water (about 2 oz) will discharge from vent line.

If the new filter cartridge cannot be inserted, insert the old one and turn until it stops, remove it and then retry the new cartridge.

Carbon filters should be replaced within 12 months.

Filter replacement instructions:

- Replace with an InSinkErator® filter.
- Place pan or dish towel under the filter to catch water drainage during change.
- Slowly turn the cartridge counter-clockwise completely until it stops (1/4 turn).
- Pull cartridge straight down and discard.
- Insert new cartridge into filter head.
- Top surface of cartridge will become flush with the bottom of the filter head when fully engaged.
- Turn the cartridge clockwise until it stops (1/4 turn).
- Align the in/out arrow on the head and bracket assembly to the in/out arrow on the cartridge.
- Open faucet to expel trapped air.
- Run water for 3 minutes before usage.

PROPERTY DAMAGE

- Regularly inspect the unit for any signs of leakage. If there are signs of water damage, immediately remove the unit from service.
- To avoid water damage from leakage, replace all cut, loose or split tubing.
- A drain pan, plumbed to an appropriate drain or outfitted with a leak detector, should be used in those applications where any leakage could cause property damage.

FILTRATION INFORMATION

The InSinkErator® Instant Hot Water Dispenser Filtration System is intended for use in filtering sediment, chlorine taste and odor from drinking water, and has not been evaluated for other uses. The system is typically installed (near or beneath a sink) where filtered drinking water is desired, and must be installed, operated and maintained as specified in the installation and use instructions.

⚠ CAUTION

To reduce the risk associated with property damage due to water leakage:

- Protect filter from freezing. Drain filter when temperatures drop below 40°F (4.4°C).
- Do not install if water pressure exceeds 120 psi (828 kPa). If your water pressure exceeds 120 psi, you must install a pressure limiting valve. Contact a plumbing professional if you are uncertain how to check your water pressure.
- Do not install where water hammer conditions may occur. If water hammer conditions exist you must install a water hammer arrester. Contact a plumbing professional if you are uncertain how to check for this condition.
- Do not install on hot water supply lines. The maximum operating water temperature of this filter system is 100°F (38°C).
- The disposable filter cartridge must be replaced every twelve months or at the specified service cycle.
- Read and follow instructions before installation and use of this system.

⚠ WARNING

To reduce the risk associated with ingestion of contaminants due to use with water that is microbiologically unsafe or of unknown quality, do not use with water that is microbiologically unsafe or of unknown quality without adequate disinfection before or after the system.

F-201R Cartridge (included with this system) Chemical & Mechanical Reduction Filter Specifications:

This cartridge provides mechanical and chemical reduction of dirt/rust, chlorine taste and odor, and particulates.



System Tested and Certified by NSF International against NSF/ANSI Standard 42 for the reduction of Chlorine, taste and odor and Nominal Particulate Class 1.

Pressure: 30-125 psi
 Temperature: 33°F - 100°F
 Flow Rate: 0.75 gpm
 Capacity: 500 gallons

Filter Capacity: 500 gallons, depending on local water conditions. Note that while the testing was performed under standard laboratory conditions, actual performance may vary. Do not use with water that is microbiologically unsafe or of unknown quality without adequate disinfection before or after the system. For cold water use only. Systems must be installed and operated in accordance with the Manufacturer's recommended procedures and guidelines. See warranty card for warranty. For service and parts, contact your local dealer or InSinkErator® directly at 1-800-558-5700.

Contaminant Reduction	Average Influent ppm	Influent Challenge Concentration, Except As Noted, Units Apply to Each Row.	Avg. Product Water ppm	Average % Reduction	NSF Red. Requirements	NSF Test
Chlorine, Taste & Odor	2.1	2.0 mg/L ± 10%	0.07	96.6	> 50%	516345-05
Nominal Particulate Class 1 Particle Size: = 0.5 to 1 um	12666667	At least 10,000 particles/ml	790666	93.7	> 85%	J-00025192

Application guidelines/Water Supply Parameters for NSF Testing: Service flow of 0.75 gpm, community or private well water supply, water pressure of 30-125 psi, water temperature of 33°F-100°F. Except as noted, all testing performed at pH = 7.5 ± 0.5, Flow: 0.75 gpm, Pressure: 60 psi, Temp: 20°±3°C.

Contact an authorized InSinkErator service agent for repairs or replacement components.



TROUBLESHOOTING

PROBLEM	POSSIBLE CAUSE	WHAT TO DO
Water and steam spits forcefully from spout without turning on the dispenser faucet.	<ul style="list-style-type: none"> Unit is boiling. <p><i>May be normal during initial setup.</i></p>	<ul style="list-style-type: none"> Activate faucet lever to release some water from the tank. Adjust water temperature using dial on tank front. <p><i>Remember that at higher altitudes, water boils at lower temperatures.</i></p>
Water is not hot.	<ul style="list-style-type: none"> The unit is unplugged. The electric outlet is inoperative. 	<ul style="list-style-type: none"> Make sure the unit is connected to a properly grounded electric outlet. Make sure the circuit breaker or fuses are functioning properly. Check that the outlet is not switched off.
Water is too hot or not hot enough.	<ul style="list-style-type: none"> Thermostat is not adjusted to your needs. 	<ul style="list-style-type: none"> Adjust the thermostat slowly, then activate faucet lever for 20 seconds to bring in fresh water to be heated at the new setting. Allow 5-7 minutes for water to reach new temperature.
Water comes out the vent instead of spout.	<ul style="list-style-type: none"> Outlet tube is blocked. 	<ul style="list-style-type: none"> Check that outlet tube is not kinked, twisted or pinched. Unscrew spout end piece and clean out any debris.
Water is dripping from the spout/vent intermittently.	<ul style="list-style-type: none"> The expansion chamber isn't draining properly due to low water pressure. The spout is blocked. 	<ul style="list-style-type: none"> Unplug the unit. If the dripping doesn't stop after a few minutes, check the supply valve to ensure that is fully open and there are no obstructions in the water line reducing the pressure below 30 psi (i.e., a poorly mounted saddle valve, a clogged water filter, or a partially opened shut-off valve). Unscrew spout end piece and clean out any debris.
Water is dripping from the spout/vent constantly.	<ul style="list-style-type: none"> Debris in the water line may be in the faucet valve seat causing a slow water leak. 	<ul style="list-style-type: none"> Unscrew spout end piece and clean out any debris. Activate faucet lever 7-10 times to flush faucet & lines.
Divided stream.	<ul style="list-style-type: none"> Debris in the end piece. 	<ul style="list-style-type: none"> Unscrew spout end piece and clean out any debris.

FILTRATION ISSUES

Water taste or odor	<ul style="list-style-type: none"> Filter needs to be flushed out Life of filter has expired 	<ul style="list-style-type: none"> Activate the faucet lever and run until the water is cold. If there is no change, replace filter cartridge.
New filter leaks or doesn't fit	<ul style="list-style-type: none"> Head and bracket not fully rotated Filter O-ring breach 	<ul style="list-style-type: none"> Remove, inspect, reinstall filter cartridge. Remove new filter, replace with old filter. Check operation. If OK, reinstall new filter and recheck operation.
No water flow or low water flow	<ul style="list-style-type: none"> Life of filter has expired 	<ul style="list-style-type: none"> Replace filter cartridge. See page 12.



1.800.558.5700
www.insinkerator.com

44069 REV. A



EMERSON
Appliance Solutions

The Emerson logo is a trademark and service mark of Emerson Electric Co.

Printed in USA

© 2007 InSinkErator, a division of Emerson Electric Co. All Rights Reserved.