

# iLuv

THANK YOU FOR YOUR PURCHASE  
Visit our website at [www.i-Luv.com](http://www.i-Luv.com)

# iLuv®

Model : IMM9400/9500  
**Instruction Manual**

©2009 [www.i-Luv.com](http://www.i-Luv.com)

iLuv is a trademark of jWIN Electronics Corp. iPod is a trademark of Apple Inc. registered in the U.S. and other countries. iPhone is a trademark of Apple Inc. All logos and brands are property of their respective owners. iPod not included in this package. Features and specifications are subject to change without prior notification.

© 2009 jWIN Electronics Corp. All rights reserved. No portion of this printed material or product enclosed herewith including design, shape or graphics, may be reproduced or transmitted in any form without the expressed written consent of jWIN Electronics Corp. by any means, electronic or mechanical, including photocopying, recording or use of an information storage and retrieval system. Any unauthorized distribution or reproduction of this printed material or product, or any portion thereof, will be prosecuted to the fullest possible extent of the law.

Designed in New York, USA / Printed in China

Mini Audio System for your iPhone® or iPod®

## INTRODUCTION

Thank you for purchasing iMM9400/9500. Unpack the unit and make sure all the accessories are put aside so they will not be lost. We recommend that you retain the original carton and packaging materials for future use, should you transport or ship the unit in the future.

- 4-MP3 CD / Audio CD playback system with integrated universal dock for your iPhone or iPod
- 2.1 channel speakers (with subwoofer only for iMM9500 ) deliver the rich and powerful sound of your favorite songs from CDs and your iPhone or iPod
- Provides a variety of convenient functions, such as Mute, Sleep, Timer, and more
- Clock display with sleep function
- Timer function (auto on/off)
- Supports subwoofer output jack
- Synchronize time from your iPhone and iPod
- Capable of playing MP3, WMA files on SD/MMC cards and USB flash memory stick
- Listen to slotMusic through SD card slot or USB port

### 4-CD Player

- Supports Random, Repeat, Intro, and Program functions
- Programmable memory for 40 audio tracks
- Sliding motorized CD door mechanism

### iPhone / iPod\*

- Plays and charges your iPhone or iPod

### Radio

- Enjoy AM / FM radio with PLL digital tuning technology
- Programmable presets for 40 radio stations (10 for AM / 30 for FM)

### What's included

- High-fidelity mini audio system
- Remote control (battery included)
- Wall-mounting kit
- iPhone/iPod dock adapters
- Pedestal stands
- AC power cord
- Warranty card

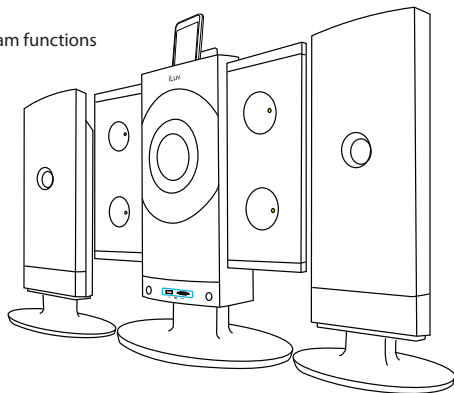

\* iPhone, iPhone 3G, iPhone 3G S, iPod touch 2nd generation, iPod nano 4th generation, iPod touch, iPod nano 3rd generation, iPod classic, iPod nano 2nd generation, iPod with video, iPod nano 1st generation, iPod 4th generation, iPod mini

## TABLE OF CONTENTS

### Getting Started

Compatibility	4
Main Unit Assembly and Disassembly	5
Speaker Assembly and Disassembly	5
Wall-mounting Installation	6
Location of Controls	7
Location of Controls (Rear View of Main Unit)	8
Antenna Connection	10
Speaker Connection	10
Subwoofer Connection	10
AC Power Connection	10
Location of Controls (Remote Control)	11
First Time Use of Remote Control	12
Battery Installation (Remote Control)	12

### Operational Instructions

<b>Setting the Clock</b>	13
Setting the time using the Time Sync function	13
Setting the time manually	13
<b>Timer</b>	14
Setting the timer	14
Setting the sleep timer	14
<b>Basic Operation with iPhone or iPod</b>	15
Installing the dock adapter	15
Playing your iPhone or iPod	15
Pause	15
Repeat	15
Shuffle	15
Charging your iPhone or iPod	15
<b>Amplifier and Radio Operation</b>	16
Switching the unit ON	16
Selecting the mode	16
Adjusting the volume	16
Dimmer control	16
Headphone jack	16
AM / FM radio operation	16
Manual station selection	16
Station search (seek) operation	17
Stereo / Mono	17
Programming preset stations	17

## TABLE OF CONTENTS

### Operational Instructions - continued

Changing a program position	17
Setting the Bass and Treble	17
<b>CD and MP3 CD Operation</b>	17
Safety notes for operation of the CD changer	18
CD changer operation	18
Inserting and ejecting a CD	18
Playing the entire CD	19
Pause / Stop	19
Random play	19
Repeat Play	20
Track Selection	20
Search operation	20
Track intro-scan	20
Mute function	20
Program memory for Audio CDs	20
To clear the programming and resume normal playback	21
Program memory for MP3 CDs	22
To clear the programming and resume normal playback	22
ID3 TAG (Artist / Title)	23
<b>Memory Card and USB Operation</b>	23
Playing MP3 / WMA audio files SD / MMC memory cards or USB devices	23
<b>Care and Maintenance Guide</b>	24
<b>User Safety Guide</b>	25
<b>Specifications</b>	32

## GETTING STARTED

### COMPATIBILITY



#### AUDIO CD

1. Disc Size: 12cm / 8cm
2. Disc Type: CD



#### MP3 CD

1. File Format: MP3 (MPEG 1/2/2.5 Layer 3)
2. Bit Rate: 32Kbps ~ 320Kbps



#### DIGITAL AUDIO PLAYER

1. Compatible with most iPod models with dock connector.
2. iPod is a trademark of Apple Inc. registered in the U.S. and other countries.
3. iPhone is a trademark of Apple Inc.

#### DISC ERROR

This compact disc player has built-in error compensation circuits to correct for minor defects in a disc. There are limits, however, to the amount of correction available. In some cases, the CD player may skip some tracks, or parts of tracks, on a disc during disc play. This problem may be caused by defects (such as scratches) in the disc being played, which are too large for the error compensation circuits to handle. If you encounter this problem, try a new disc before having the unit serviced. If the CD player operates normally, the skipping problem is probably due to a defective disc.

**Note:** Only the above types of discs can be played on this unit. Some CD-R, CD-RW discs cannot be played depending on the condition of the player and the disc.

### MP3 (MPEG 1 Audio Layer 3)

MP3, technically referred to as MPEG 1 Audio Layer 3, is one of the popular digital audio encoding and lossy compression formats. This encoding format was developed to reduce the amount of data (or audio information) required to represent audio, yet to still reproduce audio as same as the original uncompressed audio for most listeners.

## GETTING STARTED

**CAUTION** This product may be used only with iLuv IMM9400/9500 stand.  
Use with other stands may result in instability causing possible injury.

### Main Unit Assembly and Disassembly

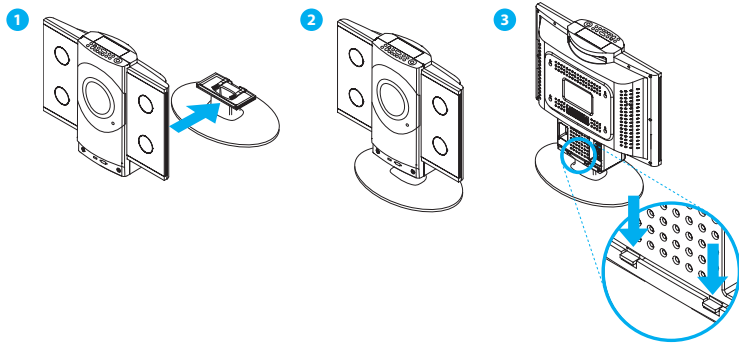

### Speaker Assembly and Disassembly

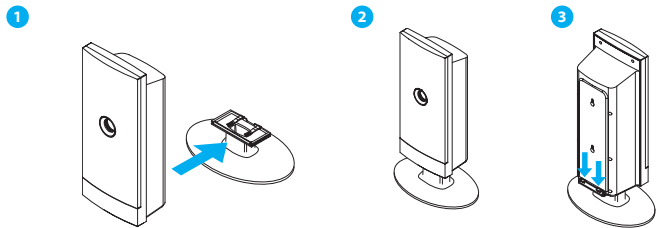

## GETTING STARTED

### Wall-mounting Installation

Secure the center unit and speakers on the wall (Solid concrete wall or wooden wall should be used) using 8 dowels and 8 screws (supplied) as shown below:

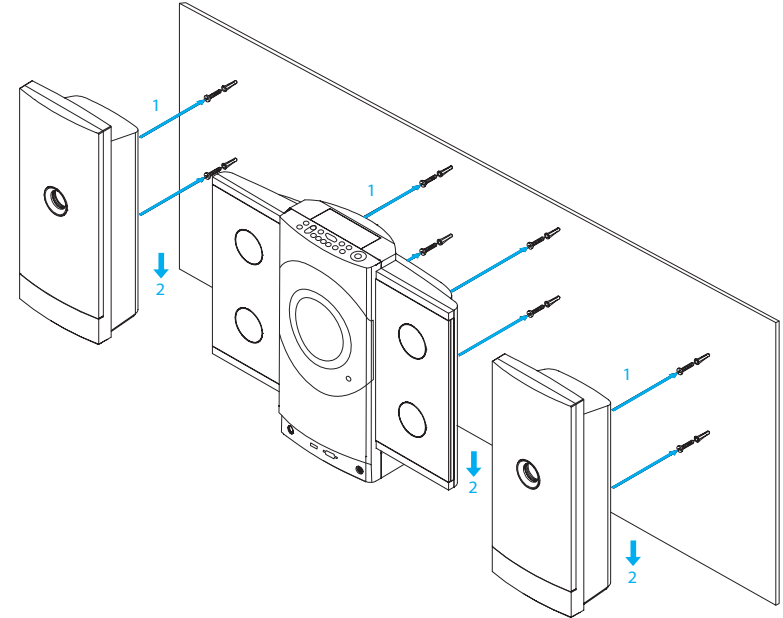

## GETTING STARTED

### Location of Controls (Top View of Main Unit)

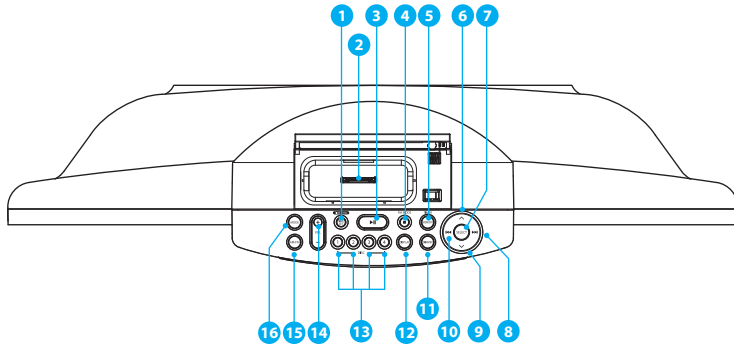

- |                       |                      |
|-----------------------|----------------------|
| 1. TIME SYNC/TIME SET | 9. DOWN (∨)          |
| 2. iPod / iPhone dock | 10. PREV (⏮)         |
| 3. PLAY / PAUSE (▶  ) | 11. DIMMER           |
| 4. FM MODE / STOP (■) | 12. DISPLAY          |
| 5. TIMER/MEMORY       | 13. CD SELECTION 1-4 |
| 6. UP (∧)             | 14. VOLUME + / -     |
| 7. SELECT             | 15. AM/FM            |
| 8. NEXT (▶▶)          | 16. MODE             |

## GETTING STARTED

### Location of Controls (Front View of Main Unit) - continued

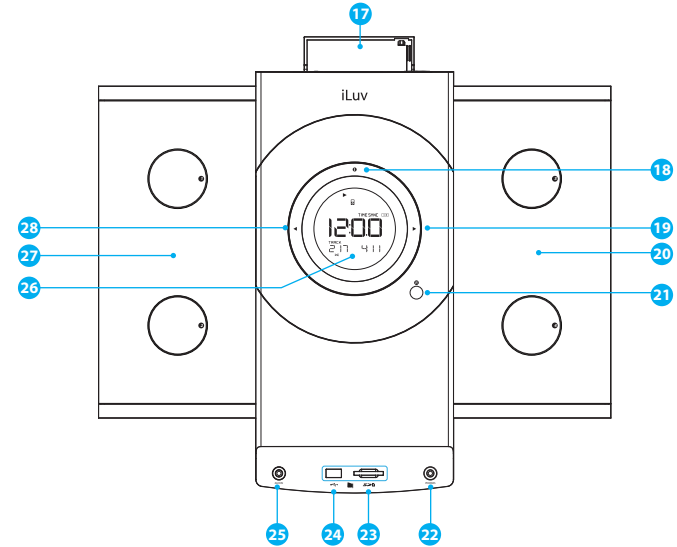

- |                           |                  |
|---------------------------|------------------|
| 17. iPod Dock Cover       | 23. SD Slot      |
| 18. POWER (●)             | 24. USB Port     |
| 19. OPEN/CLOSE R          | 25. AUX IN Jack  |
| 20. Right CD door         | 26. LCD screen   |
| 21. Remote control sensor | 27. Left CD door |
| 22. Headphone Jack        | 28. OPEN/CLOSE L |

## GETTING STARTED

### Location of Controls (Rear View of Main Unit)

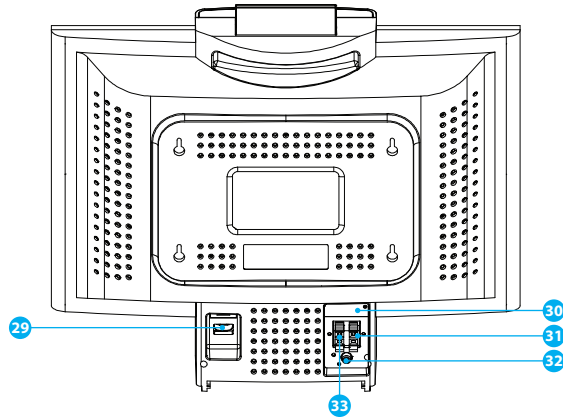

- 29. AC Power Socket
- 30. FM antenna
- 31. Left speaker output
- 32. Subwoofer output
- 33. Right speaker output

## GETTING STARTED

### Antenna Connection

You can achieve acceptable reception if you use the supplied FM pigtail antenna. If so, the antenna should be elongated and not coiled or bunched up. If it hangs freely, it can be quite effective.

### Speaker Connection

Insert LEFT speaker's striped wire into LEFT channel's speaker block by pressing the RED lever and inserting the striped wire into the open hole. Do the same with the LEFT speaker's non-stripped wire and the BLACK lever. Repeat for the RIGHT channel SPEAKER block and the RIGHT speaker's wire.

### Subwoofer Connection

This unit includes a subwoofer output jack on the rear panel labeled "SUBWOOFER". You may connect an external, powered subwoofer (included with iMM9500 only) using a single RCA-type cable as shown below.

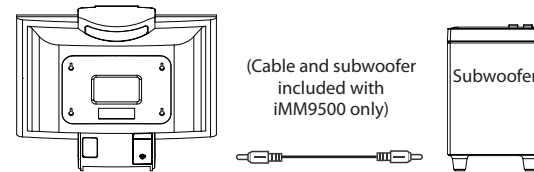

### AC Power Connection

Connect the power cable (included in the accessories) first to the power socket at the unit and then insert the power plug into the wall outlet. When you disconnect the plug from a socket, do not pull the cable, always pull the plug.

**Note:** When the unit is connected to AC power, it is in Standby mode. To switch off the unit completely, remove the plug from the AC outlet.

Once the unit is plugged in, its time display will start flashing. Refer to "Setting the clock" on P. 13, to set the current time

## GETTING STARTED

### Location of Controls (Remote Control)

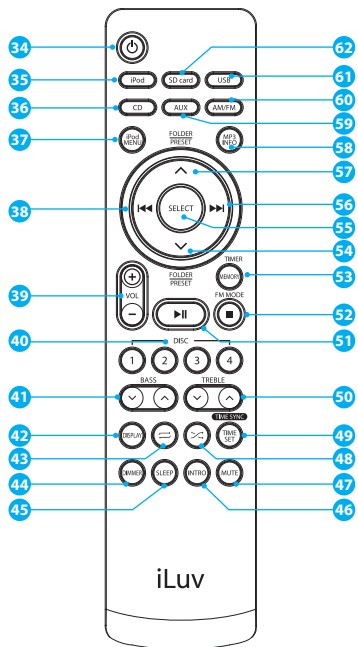

- 34. POWER (⏻)
- 35. iPod
- 36. CD
- 37. iPod MENU
- 38. PREV (⏮)
- 39. VOL +/-
- 40. DISC 1 - 4
- 41. BASS √ / ^
- 42. DISPLAY
- 43. REPEAT (⏮)
- 44. DIMMER
- 45. SLEEP
- 46. INTRO
- 47. MUTE
- 48. RANDOM (SHUFFLE) (⏮)
- 49. TIME SYNC/TIME SET
- 50. TREBLE √ / ^
- 51. PLAY / PAUSE (▶||)
- 52. FM MODE/■
- 53. TIMER/MEMORY
- 54. DOWN (∇)
- 55. SELECT
- 56. NEXT (▶▶)
- 57. UP (∧)
- 58. MP3 INFO
- 59. AUX
- 60. AM/FM
- 61. USB
- 62. SD Card

## GETTING STARTED

### First Time Use of Remote Control

For the first time use, the battery is pre-installed for your convenience. Pull out the insulation tag from the button battery tray before operating the remote control as shown below.

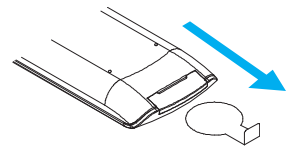

### Battery Installation

1. Remove the battery tray by pressing point inside, then sliding at the same time.

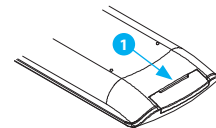

2. Pull out the battery tray.

3. Install or replace the button-type battery "CR2032" (supplied).

4. Close the battery tray.

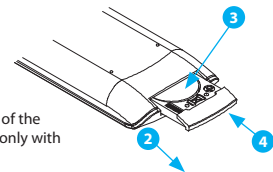

**Warning:** Incorrect placement of the battery may cause malfunction of the remote control and/or personal injury to the user. Replace only with or equivalent batteries. Please note the polarity when you install the battery.

## OPERATIONAL INSTRUCTIONS

### Setting the Clock

#### Setting the time using the Time Sync function

The easiest way to set the clock on the iMM9400/9500 is to synchronize it with the atomic clock function on your iPhone or iPod. This unit is equipped with a Time Sync function which automatically sets the time by synchronizing it with your iPhone or iPod, when it is placed in the dock.

- With the power turned ON and the power connected, the Time Sync function is automatically enabled as indicated by "TIME SYNC" on the display.
- When your iPhone or iPod is placed in the dock, the unit will begin authentication.
- During authentication, the unit will update the time according to your iPhone or iPod.

To turn off the Time Sync Function, follow these instructions:

- Press **TIME SYNC/TIME SET** to turn OFF/ON the Time Sync function. If the Time Sync function is turned off, the unit will not sync the time from your iPhone or iPod.

**Notes:** The unit takes about 2 minutes (max) to synchronize the time from iPhone or iPod while "TIME SYNC" flashes on LCD. Time Sync is complete will when "TIME SYNC" shows steadily on the display. When the Time Sync function is ON, the iMM9400/9500 will always synchronize the time when your iPhone or iPod is docked. To disable this function, turn off the Time Sync function once the correct time has been set.

#### Setting the time manually

When you first plug in the unit, the display shows:



**Note:** To set the clock to the current time, proceed as follows:

1. Press and hold **TIME SYNC/TIME SET** for three seconds. The hour flashes.
2. Enter the hour by pressing **▲** or **▼**.
3. Confirm the entry by pressing **SELECT**. The minutes will flash.
4. Enter the minutes by pressing **▲** or **▼** and confirm with **SELECT**.

The time will always show in the display while in any mode (Tuner, CD, iPod, SD Card, USB and AUX).

The time is also displayed when the unit is turned off.

Press **TIME SYNC/TIME SET** repeatedly, the display will show, "TIME SYNC ON" or "TIME SYNC OFF."

## OPERATIONAL INSTRUCTIONS

### Timer

#### Setting the timer

You can set automatic switch-on and switch-off times with the built-in timer. Before you do this, be sure the clock is set correctly.

1. With the unit on, press **DISPLAY** until "TIMER ON" appears on the display.
2. Press **TIME SYNC/TIME SET** and the hour will begin to flash. Use **▲** or **▼** to set the hour of the desired switch-on time. Press **SELECT** to confirm and go to minute setting.
3. To set the minutes, press **▲** or **▼** to adjust. Confirm by pressing **SELECT**.
4. Press **DISPLAY** to proceed to setting the switch-off time.
5. Set the switch-off time using the same procedure as switch-on time setting.
6. Press **DISPLAY**, as necessary to check the current time, Timer On, and Timer Off.
7. Press and hold **TIMER/MEMORY** for three (3) seconds to activate the timer.

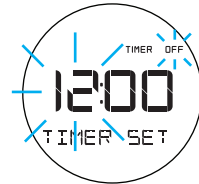
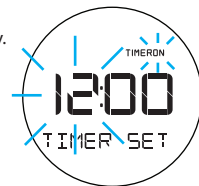

When the unit is in Standby mode, the programmed length of time from the last operating mode (CD, iPod, TUNER, SD, or USB), before it was last switched off remains in effect. Make sure the tuner is tuned to a radio station, or is in CD, iPod, SD or USB operation, a CD, iPod, SD card or USB must be inserted.

#### Setting the sleep timer

When the unit is in operation it can be set to automatically switch-off 5 to 120 minutes later. Press **SLEEP**, as necessary, until the desired delay time appears on the display. The sleep timer can be set for: 5, 10, 15, 20, 30, 60, 90, and 120 minute intervals. The unit automatically turns off after the entered time has elapsed.



## OPERATIONAL INSTRUCTIONS

### Basic Operation with iPhone or iPod

#### Installing the dock adapter

Before docking your iPhone or iPod on iMM9400/9500, a dock adapter must be properly installed. Please make sure you are using a correct dock adapter for your iPhone or iPod and that it is properly inserted into the universal adapter of iMM9400/9500. Failure to do so may damage your iPhone or iPod.

#### Playing your iPhone or iPod

1. Carefully dock your iPhone or iPod.
2. Press  $\phi$  to turn on the unit. Repeatedly press **MODE** until "iPod" shows on the display. If not in already in iPod mode, press  $\blacktriangleright$  to begin playback of your iPhone or iPod.
3. Press the  $\blacktriangleleft$  or  $\blacktriangleright$  to select desired track.
4. Press and hold the  $\blacktriangleleft$  or  $\blacktriangleright$  to search track.

#### Pause

To briefly interrupt playback, press  $\blacktriangleright$ .

1. Press  $\blacktriangleright$  again to restart play.
2. To end the iPod playback, select another mode, or press  $\phi$  to turn OFF the unit.

#### Repeat

Press  $\text{=}$  while your iPhone/iPod music is playing.

1. Press  $\text{=}$  once during iPhone/iPod music is playing. Current track will repeat.
2. Press  $\text{=}$  twice during iPhone/iPod music is playing. All tracks will repeat.

#### Shuffle

Press  $\text{><}$  while your iPhone/iPod music is playing.

- Press  $\text{><}$  while iPhone/iPod music is playing. iPod will start random playing. Press again to change normal playing mode.

#### Charging your iPhone or iPod

To charge your iPhone or iPod, insert your iPhone or iPod into the built-in universal dock. Ensure that iMM9400/9500 is connected to an outlet.

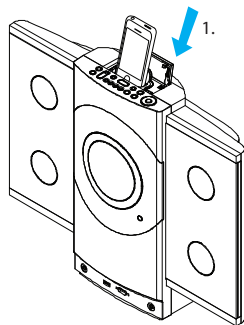

## OPERATIONAL INSTRUCTIONS

### Amplifier and Radio Operation

#### Switching the unit ON

Press  $\phi$  to turn on the system.

#### Selecting the mode

The different operating modes can be directly selected by repeatedly pressing **MODE** on the top panel or **iPod, SD Card, USB, CD, AUX** or **AM/FM** on the remote control.

#### Adjusting the volume

To adjust the volume, press **VOLUME +/-**.

To turn the sound off, press **MUTE**. This function is indicated when the word, **(MUTE)** appears in the display.

By pressing **MUTE** or **VOLUME +/-** again, the sound will turn back on.

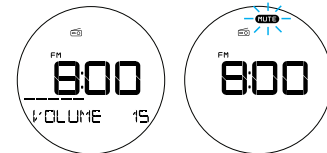

#### Dimmer control

1. Press **DIMMER** to adjust the brightness of LCD backlight.
2. There are three steps including "Off", "Low", "High"

#### Headphone jack

The headphone jack is for headphones equipped with a 3.5mm jack. Use an adapter (sold separately) if your headphone has a different plug. The speakers are automatically switched off when the headphones are being used.

#### AM/FM radio operation

1. Turn the unit on by pressing  $\phi$ .
2. Switch to the Tuner operating mode by pressing **AM/FM**.



#### Manual station selection

1. Press **AM/FM** to switch between AM and FM.
2. Press  $\blacktriangleleft$  or  $\blacktriangleright$  to tune to the desired radio station.

## OPERATIONAL INSTRUCTIONS

### Amplifier and Radio Operation - continued

#### Station search (seek) operation

- Holding down **◀◀** or **▶▶** for approximately 1 second starts the search operation and determines the direction of the search. The search operation simply finds stations with strong signals. Stations with weak reception can only be tuned in manually.

#### Stereo / Mono

Repeatedly pressing **FM MODE/■** switches between stereo and mono reception. The stereo reception of a station in the FM band is indicated on the display.

In the case of stereo stations with a bad (noisy) reception, we recommend switching tuner to mono reception. Press **FM MODE/■**. In the display, the message "ST" will disappear in mono mode.



#### Programming preset stations

The program memory allows you store 40 stations (10 AM / 30 FM).

1. Tune to the desired station.
2. Press **TIMER/MEMORY**. "MEMORY" will show on the display. Then press **▲** or **▼** until the desired memory preset number appears.
3. Press **TIMER/MEMORY** again to store the station along with its preset. Repeat as necessary.
4. Press **▲** or **▼** to switch between programmed preset stations.

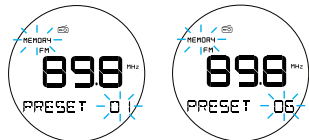

#### Changing a program position

If a memory position needs to be replaced by a station other than the current one, the new station can be programmed as described above, and this will automatically replace the original station.

#### Setting the Bass and Treble

- Press **BASS ▲** or **▼** to adjust the bass sound up or down (the bass sound level from +5 to -5).
- Press **TREBLE ▲** or **▼** to adjust the treble sound up or down (the treble sound level from +5 to -5).

## OPERATIONAL INSTRUCTIONS

### CD and MP3 CD Operation

#### Safety notes for operation of the CD changer

Press **OPEN/CLOSE** to open the right or left CD cover. The right and left CD cover do not open or close at the same time. Make sure the cover is not obstructed by any objects. This must also be ensured when closing the CD cover. The disc loader may only be opened or closed only by pressing **OPEN/CLOSE**. Be careful that no foreign objects fall into the unit when the disc compartment is open.

**Under no circumstance should the laser pick-up lens be touched. Never look directly at the beam.**

#### CD changer operation

Switch the unit on by pressing **⏻**. To turn on the CD mode, repeatedly press **MODE** on unit or press CD on the remote control. The unit will read the disc after selecting the CD mode.

If there is no CD inside, the following will appear after a few seconds:

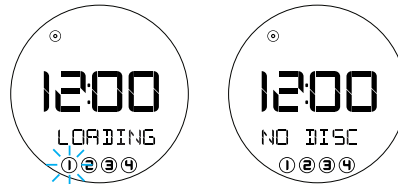

#### Inserting and ejecting a CD

The CD compartment is opened by pressing **OPEN/CLOSE**.

1. Insert the disc with the unlabelled side facing the unit. Press the center of the disc until it clicks into place in the tray.
2. To remove the CD, hold it by the edges and lightly press on the holder to remove it.
3. Then close the disc compartment by pressing **OPEN/CLOSE**.

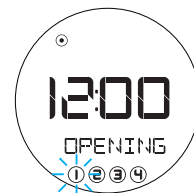

After closing the disc cover, the CD system immediately begins to scan the content of the compact disc.

## OPERATIONAL INSTRUCTIONS

### CD and MP3 CD Operation - continued

#### Playing the entire CD

Press **▶** to play all CDs.

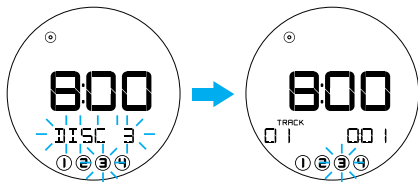

Once the playback of one CD has finished, the next inserted CD begins, and so on.

Note: If the CD player is in the stop position, you can start the currently indicated CD by pressing **▶**.

If you select a different CD by pressing **CD SELECTION 1 - 4**. Playback will start automatically.

For MP3 CD, change folder (album) by pressing **▲** or **▼**.

#### Pause / Stop

To pause playback, press **⏸**. The display indicates:

1. Press **▶** again to restart play.
2. To end the playback, press **FM MODE/■**.

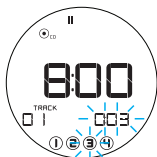

#### Random play

1. Press **⏮** before or during CD play. The tracks in the CD will be played in random sequence.
2. To cancel random play, press **FM MODE/■**, or press **⏮** again. "⏮" will disappear from the display.



## OPERATIONAL INSTRUCTIONS

### CD and MP3 CD Operation - continued

#### Repeat play

1. Press **⏮** once and the track being played will replay continuously. "1" will appear on the display.
2. Press **⏮** twice to play the current CD continuously. "ALL" will display.
3. Press **⏮** three times to have the all CDs played continuously.



#### Track selection

Press **⏮** or **⏭** to select the desired tracks.

#### Search operation

While the CD is in play mode you can scan tracks by holding down **⏮** or **⏭**. The CD will continue to play until you find the track you want. When you release the button the unit will resume normal play mode.

#### Track intro-scan

1. Press **INTRO** while in stop mode to play the first 10 seconds of each track on all inserted CDs.
2. Press **INTRO** again and the selected track will play.

#### Mute function

If **MUTE** is pressed, the audio output will be muted, and the "MUTE" indicator will be displayed.

To cancel "MUTE" press **MUTE** once more or press **VOLUME +/-**.

#### Program memory for Audio CDs

The built-in program memory lets you play up to 40 tracks in the order of your choice. A track can be stored more than once within the program.

1. Load the CDs.
2. Press **TIMER/MEMORY** in the stop mode to switch to programming mode. "MEMORY" will blink on the display.

## OPERATIONAL INSTRUCTIONS

### CD and MP3 CD Operation - continued

- Press **◀▶** or **▶▶** to select the track to be programmed.
- Press **TIMER/MEMORY** to save the track in the first program location. For example, if you selected track number 14, it will appear in Program position 1 as shown below.
- For the next program position, select another desired track (It is not necessary to select CD if the track is in the same CD).

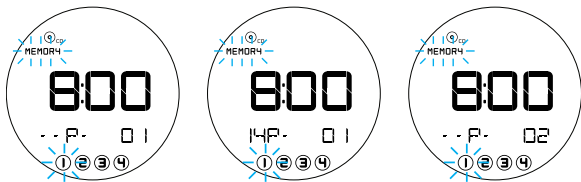

- Confirm the selection using the **TIMER/MEMORY**.
- To program other tracks in the memory, repeat steps 3 - 6.

To play the program, press **▶▶**. The program can be played back again as long as “MEMORY” appears on the display.

#### To clear the programming and resume normal playback

The programming is erased by pressing **FM MODE/■** until the “MEMORY” display disappears, or by opening the CD changer door. If the unit is switched off, the program is erased.

#### Notes

- RANDOM will not function in programmed play.
- This unit counts all the folders on an MP3 disc, even if a folder doesn't contain any MP3 file(s). If you select a folder which doesn't contain any MP3 file(s), the unit will automatically skip to the next folder until it finds one containing an MP3 file(s).

## OPERATIONAL INSTRUCTIONS

### CD and MP3 CD Operation - continued

#### Program memory for MP3 CDs

The built-in program memory enables up to 40 titles to be played from one disc in the order of your choice. Any title can be stored more than once within one program.

- Load the CDs.
- Press **TIMER/MEMORY** in the stop mode to switch to programming mode.
- Select the desired folder (album) by repeatedly pressing **▲** or **▼**.
- Select the desired track by pressing **◀▶** or **▶▶** to select:

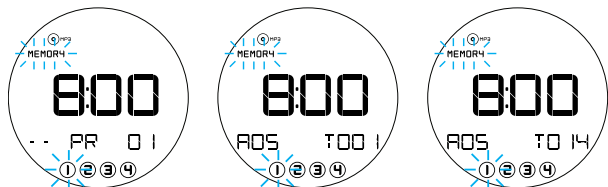

- Confirm selection using **TIMER/MEMORY** to save the track in the first location.
- To store the remaining titles in the memory, repeat Steps 3-5.

To play back the program, press **▶▶**. When **▶▶** is pressed, the program can be played back again as long as “MEMORY” appears on the display.

#### To clear the programming and resume normal playback

The programming is erased by pressing **FM MODE/■** in the programming mode (until “MEMORY” display disappears), or by opening the disc compartment.

**Note:** **><** is not used for programming.

#### ID3 TAG (Artist/Title)

- When an MP3 disc is playing, **MP3 INFO** repeatedly. The track no., title and artist information will be shown in the display if disc information is available.
- To resume normal play display, press **MP3 INFO** repeatedly until playing time reappears.

## Memory Card and USB Operation

### Playing MP3/WMA audio files from SD/MMC memory cards or USB Devices

1. Press **MODE** repeatedly or **SD Card** or **USB** until the main display shows "□", for SD card or "🔌" for USB.
2. Insert the **SD** or **MMC** flash memory card or **USB** flash containing MP3/WMA audio files into the card slot by gently pressing into position until it locks in place. Cards and USB devices can only be inserted one way.
3. After reading the card or USB, the unit will play automatically.



4. Press **▶||** to pause playback.
5. Press **⏮** or **⏭** to skip tracks.
6. Press **▲** or **▼** to skip folders (albums).
7. Press **MP3 INFO** to display title, album and artist information.
  - Playback will continue until the last track has played and then the display will again show the total number of tracks, albums on the card.
8. Press **FM MODE/■** to stop playback at any time, the display will show the total number of files tracks and directories albums on the card. For example "08" folders (albums), "49" tracks.

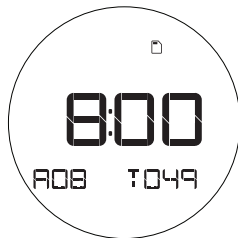
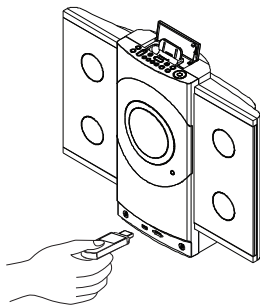

## CARE AND MAINTENANCE GUIDE

- Treat the disc carefully. Handle the disc only by its edges. Never allow your fingers to contact with the shiny, unprinted side of the disc.
- Do not attach adhesive tape, stickers etc., to the disc label.
- Clean the disc periodically with soft, lint-free, dry cloth. Never use detergents or adhesive cleaners to clean the disc. If necessary, use a CD cleaning kit.
- If disc skips or gets stuck on a section of the disc, it is probably dirty or damaged (scratched).
- When cleaning the disc, wipe in straight lines from the centre of the disc to the edge of the disc. Never wipe in circular motions.
- To remove a disc from its storage case, press down on the centre of the case and lift the disc out, holding it carefully by the edges.
- Fingerprints and dust should be carefully wiped off the disc's recorded surface with a soft cloth. Unlike conventional records, compact disc have no groove to collect dust and microscopic debris, so gently wiping with a soft cloth should remove most particles.

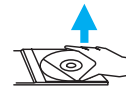

### CLEANING THE UNIT

- To prevent fire or shock hazard, disconnect your unit from the AC power source when cleaning.
- The finish on the unit may be cleaned with a dust cloth and cared for as other furniture, Use caution when cleaning and wiping the plastic parts.
- If the cabinets become dusty wipe them with a soft dry dust cloth. Do not use any wax or polish sprays on the cabinets.
- If the front panel becomes dirty or smudged with fingerprints it may be cleaned with a soft cloth slightly dampened with a mild soap and water solution. Never use abrasive cloths or polishes as these will damage the finish of your unit.

**Caution:** Never allow any water or other liquids to get inside the unit while cleaning.

### WARNING

- TO PREVENT FIRE OR SHOCK HAZARD. DO NOT EXPOSE THIS APPLIANCE TO RAIN OR MOISTURE.
- THIS APPLIANCE SHALL NOT BE EXPOSED TO DRIPPING OR SPLASHING WATER AND THAT NO OBJECT FILLED WITH LIQUIDS SUCH AS VASES SHALL BE PLACED ON APPARATUS.



The lightning flash with an arrowhead symbol within an equilateral triangle is intended to alert the user of the presence of un-insulated “dangerous voltage” within the product’s enclosure that may be of sufficient magnitude to constitute a risk of electric shock to people.

#### CAUTION

RISK OF ELECTRIC SHOCK DO NOT OPEN

WARNING: To reduce the risk of electric shock, do not remove cover (or back). No user-service-able parts inside. Refer servicing to qualified service personnel.



The exclamation point within an equilateral triangle is intended to alert the user of the presence of important operating and maintenance (servicing) instruction in the literature accompanying the appliance.

### IMPORTANT SAFETY INSTRUCTIONS

1. Read these instructions
2. Keep these instructions
3. Heed all warnings
4. Follow all instructions
5. Do not use this apparatus near water
6. Clean only with dry cloth
7. Do not block any ventilation openings. Install in accordance with the manufacturer’s instructions
8. Do not install near any heat sources such as radiators, heat registers, stoves, or other apparatus (including amplifiers) that produce heat
9. Do not defeat the safety purpose of the polarized or grounding-type plug. A polarized plug has two blades with one wider than the other. A grounding type plug has two blades and a third grounding prong. The wide blade or the third prong are provided for your safety. If the

### IMPORTANT SAFETY INSTRUCTIONS - continued

- provided plug does not fit into your outlet, consult an electrician for replacement of the obsolete outlet.
10. Protect the power cord from being walked on or pinched particularly at plugs, convenience receptacles, and the point where they exit from the apparatus.
  11. Only use attachments/accessories specified by the manufacturer.
  12. Use only with the cart, stand, tripod, bracket, or table specified by the manufacturer, or sold with the apparatus. When a cart is used, use caution when moving the cart/apparatus combination to avoid injury from tip-over.
  13. Unplug this apparatus during lightning storms or when unused for long periods of time.
  14. Refer all servicing to qualified service personnel. Servicing is required when the apparatus has been damaged in any way, such as power-supply cord or plug is damaged, liquid has been spilled or objects have fallen into the apparatus, the apparatus has been exposed to rain or moisture, does not operate normally, or has been dropped.
  15. Grounding or Polarization – This product may be equipped with a polarized alternating-current line plug (a plug having one blade wider than the other). This plug will fit into the power outlet only one way. This is a safety feature. If you are unable to insert the plug fully into the outlet, try reversing the plug. If the plug should still fail to fit, contact your electrician to replace your obsolete outlet. Do not defeat the safety purpose of the polarized plug.  
Alternate Warnings – This product is equipped with a three-wire grounding-type plug, a plug having a third (grounding) pin. This plug will only fit into a grounding-type power outlet. This is a safety feature. If you are unable to insert the plug into the outlet, contact your electrician to replace your obsolete outlet. Do not defeat the safety purpose of the grounding-type plug.
  16. Ventilation – Slots and openings in the cabinet are provided for ventilation and to ensure reliable operation of the product and to protect it from overheating, and these openings must not be blocked or covered. The openings should never be blocked by placing the product on a bed, sofa, rug, or other similar surface. This product should not be placed in a built-in installation such as a bookcase or rack unless proper ventilation is provided or the manufacturer’s instructions have been adhered to.
  17. The MAINS plug or an appliance coupler is used as the disconnect device, the disconnect device shall remain readily operable.



## USER SAFETY GUIDE

### IMPORTANT SAFETY INSTRUCTIONS - continued



#### CLEANING

Always disconnect unit from power supply before attempting to clean it. Use soft clothmoistened with soapy water, and wipe gently. Do not use solvents or abrasive materials.

#### LASER SAFETY

This unit uses laser technology. Only a qualified professional should remove the cover or attempt to service this device, due to possible eye injury.



#### CAUTION – CLASS 1 LASER PRODUCT

Use of controls adjustments and/or performance of procedure other than specified herein may result in hazardous radiation exposure.



#### DANGER

Invisible laser radiation when open and interlock failed or defeated. Avoid direct exposure to beam. CAUTION: HAZAROUS LASER RADIATION WHEN OPEN AND INTERLOCK DEFEATED.



#### YOU CAN HELP TO PROTECT THE ENVIRONMENT!

Please remember to respect the local regulations: Hand in the non-working electrical equipment to an appropriate waste disposal center.

#### FOR USED BATTERIES

Disposed of the used batteries properly. Please follow the local regulations for the battery disposal.

## USER SAFETY GUIDE

### FCC NOTICE TO A USER IN USA

This equipment has been tested and found to comply with the limits for a Class B digital device, pursuant to Part 15 of the FCC Rules. These limits are designed to provide reasonable protection against harmful interference in a residential installation. This equipment generates, uses, and can radiate radio frequency energy and, if not installed and used in accordance with the instructions, may cause harmful interference to radio communications. However, there is no guarantee that interference will not occur in a particular installation. If this equipment does cause harmful interference to radio or television reception, which can be determined by turning the equipment off and on, the user is encouraged to try to correct the interference by one or more of the following measures:

1. Reorient or relocate the receiving antenna.
2. Increase the separation between the equipment and receiver.
3. Connect the equipment into an outlet on a circuit different from that to which the receiver is connected.
4. Consult the dealer or an experienced radio/TV technician for help.

#### FCC RULES

This device complies with Part 15 of the FCC Rules. Operation is subject to the condition that this device does not cause harmful interference.

**Note:** Do not make changes or modify the device in any way. Changes or modifications not expressly approved by the party responsible for compliance could void the user's authority to operate the equipment.

## USER SAFETY GUIDE

### FCC NOTICE TO A USER IN USA - continued

#### IMPORTANT NOTES ON HEARING

Your hearing is very important to you and to us, so please take care when operating this equipment. We strongly recommend you to follow the guideline below in order to prevent possible damage or loss of hearing.

If you continuously listen to the loud sounds, your hearing will adapt to continuous loud sounds and will give you the impression that the volume has been reduced. What seems normal to you may in fact be harmful. To guard against this **BEFORE YOUR HEARING ADAPTS**, set the volume at a low level and slowly increase the volume level until you can hear comfortably and clearly without distortion. Damage to your hearing is accumulative and is irreversible. Any ringing or discomfort in the ears indicates that the volume is too loud. Once you have established a comfortable listening level, **DO NOT INCREASE THE VOLUME LEVEL FURTHER.**

In the use of headphones, please take more attention. Hearing experts say that listening to a loud music can damage your hearing, especially when listening to music with headphones.

## USER SAFETY GUIDE

### IC NOTICE TO A USER IN CANADA

Since digital circuitry may cause interference to other radio or television tuners nearby, switch this unit off when not in use or move it away from the affected radio/television tuner.

**NOTE:** This digital apparatus does not exceed the Class B limits for radio noise emissions from digital apparatus as set out in the Radio Interference Regulations of Industry Canada. These limits are designed to provide reasonable protection against harmful interference in a residential installation. This equipment generates, uses and can radiate radio frequency energy and, if not installed and used in accordance with the instructions, may cause harmful interference to radio communications. However, there is no guarantee that interference will not occur in a particular installation. If this equipment does cause harmful interference to radio or television operation (which can be determined by turning the equipment off), the user is encouraged to try to correct the interference by one or more of the following measures:

- Reorient or relocate the receiving antenna.
- Increase the separation between the equipment and receiver.
- Connect the equipment into an outlet on a circuit different from that to which the receiver is connected.
- Consult the dealer or an experienced radio / TV technician for help.

#### WARNING!

- The apparatus shall not be exposed to dripping or splashing and that no objects filled with liquids, such as vases, shall be placed on apparatus.
- Mains plug is used as the disconnect device. It shall remain readily operable and should not be obstructed during intended use. To be completely disconnected, the apparatus from supply mains, the mains plug of the apparatus shall be disconnected from the mains socket outlet completely.



### ADDITIONAL IMPORTANT INSTRUCTIONS

- Place the apparatus with some distances from the nearby objects or walls for sufficient ventilations. The ventilation should not be impeded by covering the ventilation openings with items such as newspapers, table-cloths, curtains, etc.
- No naked flame sources such as lighted candles should be placed on the apparatus.
- Dispose of used batteries properly. Follow the local regulation for the battery disposal.
- Use this apparatus in the moderate climates. It is recommended not to use this apparatus such in a lighting storm.

### • GENERAL

1. Power requirement
  - a. Main unit:
    - i. AC: 120V 60Hz (iMM9400)  
110V / 220V, 60Hz/50Hz (iMM9400D)  
230V, 50Hz (Europe only)
    - ii. DC: 1 x CR2032 for Remote Control
  - b. Subwoofer: AC 100-240V, 50/60Hz (only for iMM9500)
2. Power consumption:
  - a. Main unit: 50 Watts max.
  - b. Subwoofer: 70 Watts (iMM9500) max.
3. Unit Dimension (w/ stand)
  - a. Unit: 440 (W) x 110 (D) x 428 (H) mm (17.3" x 4.5" x 16.9")
  - b. Speakers: 148 (W) x 108 (D) x 415 (H) mm (5.8" x 4.3" x 16.3")
  - c. Subwoofer: 170 (W) x 240 (D) x 260 (H) mm (6.7" x 9.5" x 10.2")

### • RECEIVER SECTION

1. Receiving bands: AM/FM
2. Tuning range
  - a. AM: 530-1710kHz ; 522-1620kHz (Europe only)
  - b. FM: 87.5 - 108MHz

### • CD PLAYER SECTION

1. Playback system: 4 CD front loading changer
2. Frequency response: 60 - 20,000 Hz

### • AUDIO SECTION

1. Power output:
  - a. Satellite speaker: 10 Watts (RMS) per channel
  - b. Subwoofer: 30 Watts RMS (only for iMM9500)
2. Speaker impedance:
  - a. Satellite: 3 ohms
  - b. Subwoofer: 8 ohms (only for iMM9500)
3. Headphone impedance: 8 - 32 ohms

MEMO

MEMO