

IFB

MODEL: 22DGSC1

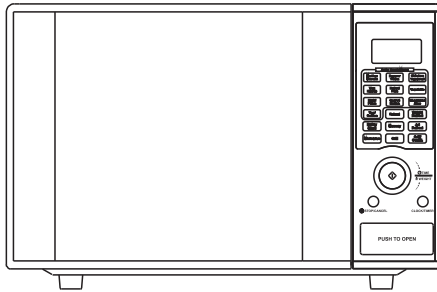

Microwave Oven Owner's Manual

Please read these instructions carefully before installing and operating the oven. Record in the space below the SERIAL NO. found on the nameplate on your oven and retain this information for future reference.
SERIAL NO.

PRECAUTIONS TO AVOID POSSIBLE EXPOSURE TO EXCESSIVE MICROWAVE ENERGY

1. Do not attempt to operate this oven with the door open since open door operation can result in harmful exposure to microwave energy. It is important not to defeat or tamper with the safety interlocks.
2. Do not place any object between the oven front face and the door or allow soil or cleaner residue to accumulate on sealing surfaces.
3. Do not operate the oven if it is damaged. It is particularly important that the oven door close properly and that there is no damage to the
 - a. Door (bent),
 - b. Hinges and latches (broken or loosened),
 - c. Door seals and sealing surfaces.
4. The oven should not be adjusted or repaired by anyone except properly qualified service personnel.

CONTENTS

PRECAUTIONS TO AVOID POSSIBLE EXPOSURE TO EXCESSIVE MICROWAVE ENERGY	1
IMPORTANT SAFETY INSTRUCTIONS	2
SPECIFICATIONS*	3
INSTALLATION	3
RADIO INTERFERENCE	3
GROUNDING INSTRUCTIONS	4
MICROWAVE COOKING PRINCIPLES	4
BEFORE YOU CALL FOR SERVICE	4
UTENSILS GUIDE	5
PART NAMES	5
CONTROL PANEL	6
HOW TO SET THE OVEN CONTROLS	7
Setting the clock	7
Timer	7
Energy-saving mode	8
Quick start	8
Microwave cooking	8
Grill cooking	8
Combination cooking	9
Defrost by weight	9
Jet Defrost	10
Auto Cook	11
Delay start	12
Multi-stage Cooking	13
Child Lock	13
CLEANING AND CARE	14

IMPORTANT SAFETY INSTRUCTIONS

When using electrical appliance basic safety precautions should be followed, including the following:

WARNING: To reduce the risk of burns, electric shock, fire, injury to persons or exposure to excessive microwave energy:

1. Read all instructions before using the appliance.
2. Use this appliance only for its intended use as described in this manual. Do not use corrosive chemicals or vapors in this appliance. This type of oven is specifically designed to heat, cook or dry food. It is not designed for industrial or laboratory use.
3. Do not operate the oven when empty.
4. Do not operate this appliance if it has a damaged cord or plug, if it is not working properly or if it has been damaged or dropped. If the supply cord is damaged, it must be replaced by the manufacturer or its service agent or a similarly qualified person in order to avoid a hazard.
5. **WARNING:** Only allow children to use the oven without supervision when adequate instructions have been given so that the child is able to use the oven in a safe way and understands the hazards of improper use.
6. Warning: When the appliance is operated in the combination mode, children should only use the oven under adult supervision due to the temperatures generated.
7. To reduce the risk of fire in the oven cavity:
 - a. When heating food in plastic or paper container, keep an eye on the oven due to the possibility of ignition.
 - b. Remove wire twist-ties from paper or plastic bags before placing bag in oven.
 - c. If smoke is observed, switch off or unplug the appliance and keep the door closed in order to stifle any flames.
 - d. Do not use the cavity for storage purposes. Do not leave paper products, cooking utensils or food in the cavity when not in use.
8. **WARNING:** Liquid or other food must not be heated in sealed containers since they are liable to explode.
9. Microwave heating of beverage can result in delayed eruptive boiling, therefore care has to be taken when handling the container.
10. Do not fry food in the oven. Hot oil can damage oven parts and utensils and even result in skin burns.
11. Eggs in their shell and whole hard-boiled eggs should not be heated in microwave ovens since they may explode even after microwave heating has ended.
12. Pierce foods with heavy skins such as potatoes, whole squashes, apples and chestnuts before cooking.
13. The contents of feeding bottles and baby jars should be stirred or shaken and the temperature should be checked before serving in order to avoid burns.
14. Cooking utensils may become hot because of heat transferred from the heated food. Potholders may be needed to handle the utensil.
15. Utensils should be checked to ensure that they are suitable for use in microwave oven.
16. **WARNING:** It is hazardous for anyone other than a trained person to carry out any service or repair operation which involves the removal of any cover which gives protection against exposure to microwave energy.
17. This product is a Group 2 Class B ISM equipment. The definition of Group 2 which contains all ISM (Industrial, Scientific and Medical) equipment in which radio-frequency energy is intentionally generated and/or used in the form of electromagnetic radiation for the treatment of material, and spark erosion equipment. For Class B equipment is equipment suitable for use in domestic establishments and in establishments directly connected to a low voltage power supply network which supplies buildings used for domestic purpose.
18. This appliance is not intended for use by persons (including children) with reduced

physical, sensory or mental capabilities, or lack of experience and knowledge, unless they have been given supervision or instruction concerning use of the appliance

by a person responsible for their safety.

19. Children should be supervised to ensure that they do not play with the appliance.

SPECIFICATIONS*

Power Consumption	230V~50Hz, 1200W(Microwave) 230V, 1350W (Grill)
Rated Microwave Power Output:	800W
Operation Frequency:	2450MHz
Outside Dimensions:	295mm(H)×458mm(W)×403mm(D)
Oven Cavity Dimensions:	206mm(H)×344mm(W)×309mm(D)
Oven Capacity:	22 Litres
Cooking Uniformity:	Turntable System
Net Weight:	Approx.16.7 kg

*The data quoted here are no guarantee of truth, if they are important for you, please checks the available data on the nameplate of the oven.

INSTALLATION

1. Make sure that all the packing materials are removed from the inside of the door.
2. **WARNING:** Check the oven for any damage, such as misaligned or bent door, damaged door seals and sealing surface, broken or loose door hinges and latches and dents inside the cavity or on the door. If there is any damage, do not operate the oven and contact qualified service personnel.
3. This microwave oven must be placed on a flat, stable surface to hold its weight and the heaviest food likely to be cooked in the oven.
4. Do not place the oven where heat, moisture, or high humidity are generated, or near combustible materials.
5. For correct operation, the oven must have sufficient airflow. Allow 20cm of space above the oven, 10cm at back and 5cm at both sides. Do not cover or block any openings on the appliance. Do not remove feet.
6. Do not operate the oven without glass tray, roller support, and shaft in their proper positions.
7. Make sure that the power supply cord is undamaged and does not run under the oven or over any hot or sharp surface.
8. The socket must be readily accessible so that it can be easily unplugged in an emergency.
9. Do not use the oven outdoors.

RADIO INTERFERENCE

Operation of the microwave oven can cause interference to your radio, TV, or similar equipment.

When there is interference, it may be reduced or eliminated by taking the following measures:

1. Clean door and sealing surface of the oven.
2. Reorient the receiving antenna of radio or television.
3. Relocate the microwave oven with respect to the receiver.
4. Move the microwave oven away from the receiver.
5. Plug the microwave oven into a different outlet so that microwave oven and receiver are on different branch circuits.

GROUNDING INSTRUCTIONS

This appliance must be grounded. This oven is equipped with a cord having a grounding wire with a grounding plug. It must be plugged into a wall receptacle that is properly installed and grounded. In the event of an electrical short circuit, grounding reduces risk of electric shock by providing an escape wire for the electric current. It is recommended that a separate circuit serving only the oven be provided. Using a high voltage is dangerous and may result in a fire or other accident causing oven damage.

WARNING Improper use of the grounding plug can result in a risk of electric shock.

Note:

1. If you have any questions about the grounding or electrical instructions, consult a qualified electrician or service person.
2. Neither the manufacturer nor the dealer can accept any liability for damage to the oven or personal injury resulting from failure to observe the electrical connection procedures.

The wires in this cable main are colored in accordance with the following code:

Green and Yellow = EARTH

Blue = NEUTRAL

Brown = LIVE

MICROWAVE COOKING PRINCIPLES

1. Arrange food carefully. Place thickest areas towards outside of dish.
2. Watch cooking time. Cook for the shortest amount of time indicated and add more as needed. Food severely overcooked can smoke or ignite.
3. Cover foods while cooking. Covers prevent spattering and help foods to cook evenly.
4. Turn foods over once during microwaving to speed cooking of such foods as chicken and hamburgers. Large items like roasts must be turned over at least once.
5. Rearrange foods such as meatballs halfway through cooking both from top to bottom and from the center of the dish to the outside.

BEFORE YOU CALL FOR SERVICE

If the oven fails to operate:

1. Check to ensure that the oven is plugged in securely. If it is not, remove the plug from the outlet, wait 10 seconds, and plug it in again securely.
2. Check for a blown circuit fuse or a tripped main circuit breaker. If these seem to be operating properly, test the outlet with another appliance.
3. Check to ensure that the control panel is programmed correctly and the timer is set.
4. Check to ensure that the door is securely closed engaging the door safety lock system. Otherwise, the microwave energy will not flow into the oven.

IF NONE OF THE ABOVE RECTIFIES THE SITUATION, THEN CONTACT A QUALIFIED TECHNICIAN. DO NOT TRY TO ADJUST OR REPAIR THE OVEN YOURSELF.

UTENSILS GUIDE

1. The ideal material for a microwave utensil is transparent to microwave, it allows energy to pass through the container and heat the food.
2. Microwave cannot penetrate metal, so metal utensils or dishes with metallic trim should not be used.
3. Do not use recycled paper products when microwave cooking, as they may contain small metal fragments which may cause sparks and/or fires.
4. Round /oval dishes rather than square/oblong ones are recommend, as food in corners tends to overcook.
5. Narrow strips of aluminum foil may be used to prevent overcooking of exposed areas. But be careful don't use too much and keep a distance of 1 inch (2.54cm) between foil and cavity.

The list below is a general guide to help you select the correct utensils.

COOKWARE	MICROWAVE	GRILL	COMBINATION
Heat-Resistant Glass	Yes	Yes	Yes
Non Heat-Resistant Glass	No	No	No
Heat-Resistant Ceramics	Yes	Yes	Yes
Microwave-Safe Plastic Dish	Yes	No	No
Kitchen Paper	Yes	No	No
Metal Tray	No	Yes	No
Metal Rack	No	Yes	No
Aluminum Foil & Foil Containers	No	Yes	No

PART NAMES

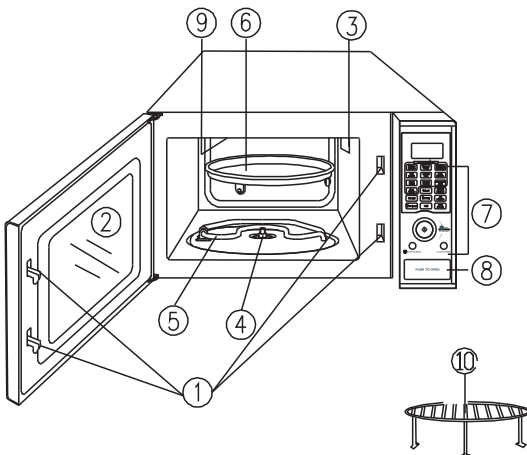

1. Door Safety Lock System
2. Oven Window
3. Oven Air Vent
4. Shaft
5. Bottom Heater
6. Grill Tray
7. Control Panel
8. Door Release Button
9. Top Heater
10. Metal Rack

CONTROL PANEL

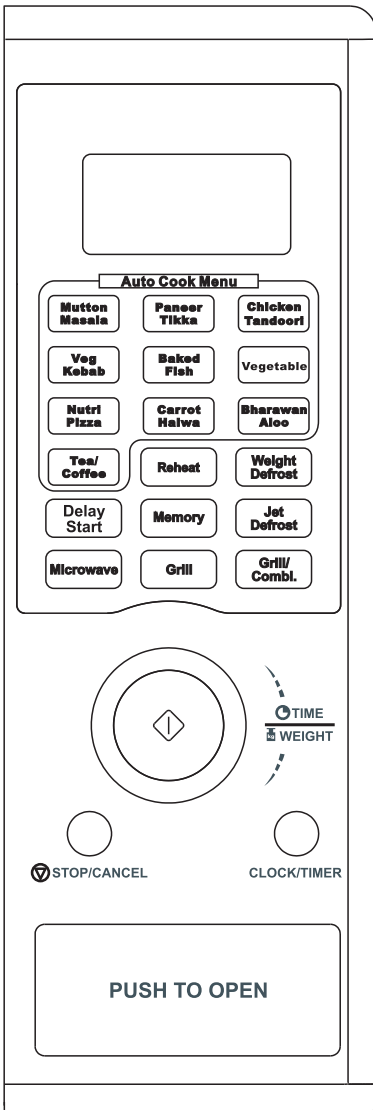

- **MENU ACTION SCREEN**

Cooking time, power, action indicators, and clock time are displayed.

- **TIME/WEIGHT(START)**

Rotate to set clock, cooking time or enter food weight. Press to start cooking program.

- **QUICK COOK BUTTONS**

Instant settings to cook popular foods.

- **CLOCK/TIMER**

Touch to set clock or timer.

- **MICROWAVE**

Touch once or repeatedly to set microwave cooking power.

- **GRILL**

Press up to three times to choose a cooking mode.

- **GRILL/COMBI.**

Press to set a combination cooking program.

- **WEIGHT DEFROST**

Programmed defrosting based on the weight of the foods to be defrosted.

- **JET DEFROST**

Quick defrost function that alternates defrost and stand times to quickly and effectively defrost foods.

- **DELAY START**

Delay start control allows you to put food into the oven and program it to start cooking at a later time.

- **MEMORY**

Used for setting a multistage cooking program

- **STOP/CANCEL**

Touch to clear entry before setting a cooking program

Touch once to temporarily stop cooking or twice to cancel cooking.

Touch and hold to set child lock.



HOW TO SET THE OVEN CONTROLS

When the microwave oven is electrified, "1:00" and the clock symbol display, the system enter safe mode (**safe mode**: the system can't run normally until open the door, and then close the door). Pressing STOP/CANCEL button once during the cooking mode can suspend the program, and press twice will cancel it. Each time a button is touched, a beep will sound to acknowledge the touch. When a program is finished, 5 beeps sound to remind you, the "END" and "HOT" display alternately.

SETTING THE CLOCK

This is a 24-hour or 12-hour cycle clock. It must be set in waiting mode.

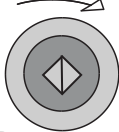

For example: to set the time of 6: 35

STEP 4	STEP 5
 <p>Rotate TIME/WEIGHT to set the minute digits.</p>	 <p>Press CLOCK/TIMER button again to confirm.</p>

TIMER

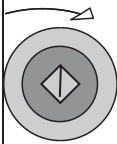
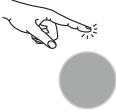
It can be set in waiting or cooking mode. User can press CLOCK/TIMER to check the remnant time during the cooking.

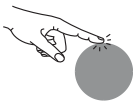
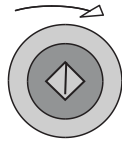
STEP 1	STEP 2	STEP 3
 <p>Press CLOCK/TIMER Button for 3 seconds."Hr 24" displays.OR Press CLOCK/TIME Button again "Hr 12" displays.</p>	 <p>Rotate TIME/WEI GHT to set the hour digits.</p>	 <p>Press CLOCK/TIMER button again to confirm.</p>

STEP 1	STEP 2	STEP 3
 <p>CLOCK/TIMER Press CLOCK/TIMER once.</p>	 <p>Rotate the TIME/WEIGHT to enter the time.</p>	 <p>Press START button.</p>

NOTE:Select either 24 or 12 hr setting.

ENERGY-SAVING MODE

STEP 1	STEP 2
 <p>Press Delay Start for one second in waiting mode, the screen stop displaying, and the system enter energy-saving mode.</p>	<p>Press any key or open the door, the system will return to waiting mode.</p>

QUICK START

To cook with less time and high power.

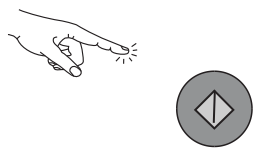
STEP 1
 <p>Press Start button continuously when the oven is in waiting mode to select the time, and the system will run automatically.</p>

MICROWAVE COOKING

To cook with microwave, time and power level should be set.

-----POWER BUTTON-----

By pressing the Microwave button a number of times, you are selecting one of the following microwave power levels:

Press	Power Level	Description
Once	800W	High
Twice	700W	M. High
Thrice	600W	
4 times	500W	
5 times	400W	Medium
6 times	300W	M. Low
7 times	200W	
8 times	100W	

Suppose you want to cook for 5 minutes at 600W.

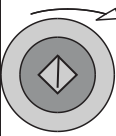
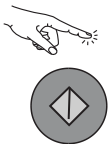
STEP 1	STEP 2	STEP 3
 <p>Press Microwave button 3 times.</p>	 <p>Rotate TIME/WEIGHT to set the cooking time (5 minutes).</p>	 <p>Press Start button</p>





Note: During cooking, press Microwave for 4 sec to check the cooking power level. The max cooking time that can be set is 95 minutes.

GRILL COOKING

Grill cooking is particularly useful for thin slices of meat, steaks, chops, kebabs, sausages and pieces of chicken. It is also suitable for hot sandwiches and au gratin dishes.

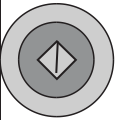
Press grill		
	Press once	Top grill
	Press twice	Top & bottom grill
	Press 3 times	Bottom grill

Suppose you want to program grill cooking for 12 minutes use the top & bottom heaters,

STEP 1	STEP 2	STEP 3
		
		
Press GRILL pad twice.	Rotate TIME/WEIGHT to set cooking time.	Press START button

NOTE:





The max cooking time that can be set is 95 minutes. Grill cooking power is set at full power level by the system.

COMBINATION COOKING

Combination cooking combines microwave and grill power to cook food with desired effects. Recommended for fish, potatoes or au gratin, puddings omelets, baked potatoes and poultry and so on. The max cooking time can be set is 95 minutes.

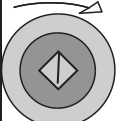
Press once	Top grill & microwave
Press twice	Top & bottom grill & microwave
Press 3 times	Bottom grill & microwave

Suppose you want to set the oven to combination cooking for 25 minutes.

STEP 1	STEP 2	STEP 3
		
		
Press GRILL/COMBI. pad continually to select one of the combination settings.	Rotate TIME/WEIGHT Dial to set cooking time (25 minutes).	Press START button.

DEFROST BY WEIGHT

To use this function, the time and the defrosting power are adjusted automatically once the weight of food is programmed. Used for defrosting Bharawan Aloo, Veg Masala, Chicken Tandoori; Baked Fish, Veg Kebab, Paneer Tikka, Mutton Masala.

FOR EXAMPLE: Suppose you want to defrost fish.

STEP 1	STEP 2	STEP 3
Place the fish to be defrosted into the oven.	Press WEIGHT DEFROST button once.	Press the FISH key once.

STEP 4	STEP 5
Rotate the TIME/WEIGHT dial to select weight.	Press START button.

NOTE:

1. If you try to completely defrost frozen foods in the microwave oven, uneven defrosting may occur due to the differences in the thickness and shape of the food. Drippings may also result, and sometimes a part of the food cooks although other parts still remain frozen. In actual usage of frozen foods, you should not normally completely defrost food, but 70% defrosting in the oven is quite good for the next step of preparing the food for cooking.
2. At the middle of the cooking, “turn” displays on the LED, and emit 5 beeps to remind you to turn the food over. If the user has not operated, 30 seconds later, the display screen reveals surplus time, the procedure does not suspend. If opened the stove and turn the food, must press START key after closing the door, the system could continue running.
3. To defrost fatty meat, heat the food for a short time in the oven and leave it to stand at room temperature, or heat it intermittently until defrosted.
4. When you defrost a whole chicken, or any frozen food of irregular shape, wrap legs or thin parts with aluminum foil. Otherwise thin parts will be defrosted faster and sometimes cooked before other parts have properly defrosted. For big pieces of meat, wrap the sides with aluminum foil so that they will be



uniformly thawed by vertical microwaves only.

5. Ice should be removed at times during defrosting.

JET DEFROST

With JET DEFROST, you need to input defrosting time,

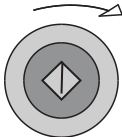
Suppose you want to set the oven to JET DEFROST for 5 minutes.

STEP 1	STEP 2	STEP 3
 <p>Jet Defrost</p> <p>Press JET DEFROST button.</p>	 <p>Rotate TIME/WEIGHT to set the defrosting time(5 minutes).</p>	 <p>Press Start</p>

NOTE: at the middle of the cooking, “turn” displays on the LED, and emit 5 beeps to remind you to turn the food over. If the user does'nt operate the microwave oven, 30 seconds later, the display screen reveals surplus time, the procedure does not suspend. If the oven is opened to turn the food, the user must press START key after closing the door, to resume the defrosting programme.

AUTO COOK

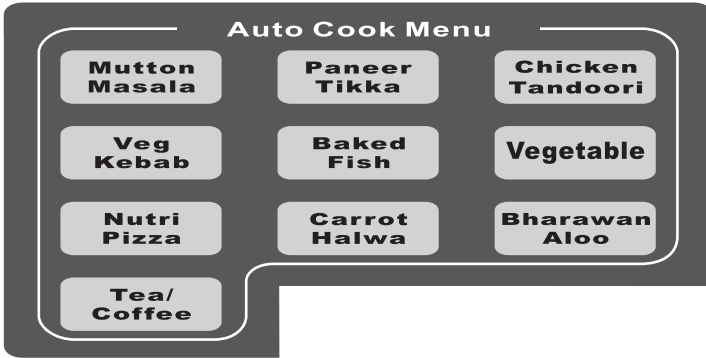





For food or the following cooking mode, it is not necessary to program the duration and the cooking power. It is sufficient to indicate the type of food that you wish to cook.

In order to do this,

STEP 1	STEP 2	STEP 3
Press the individual icon pad of the food you are going to cook	Rotate the TIME/WEIGHT dial to select the weight	Press start.

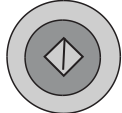
For example: to bake 400g of fish.

STEP 1	STEP 2	STEP 3
<p>Press</p>   <p>Press BAKED FISH button once.</p>	  <p>Rotate the TIME/WEIGHT dial to set 400g.</p>	  <p>Press START button</p>

Auto Cook Menu

Food/cooking mode	Press to indicate weight of food
MUTTON MASALA	1) Weight parameters are used to determine the time needed to do the job. 2) As you press the icon pads once or repeatedly, a number of pre-set weight (Vegetable, number of servings) display, when it comes up of the right figure which matches the weight of the food you have placed into the oven, push START button. 3) NUTRI PIZZA has three cooking modes: p-1, p-2, p-3. p-1 is used for baking refrigerated PIZZA (-18°C), p-2 is used for baking chilled PIZZA (5°C), and p-3 is used for baking PIZZA at normal temperature(+20°C).
PANEER TIKKA	
CHICKEN TANDOORI	
VEG KEBAB	
BAKED FISH	
VEG MASALA	
NUTRI PIZZA	
CARROT HALWA	
BHARAWAN ALOO	
TEA/COFFEE	

NOTE:



For some food, at the middle of cooking time, you may need to open the door to check its doneness and turn food over to obtain uniform cooking; but be careful to handle with care very hot food in the oven. To resume cooking, just close the door, and press start the oven will cook for the remaining time.

- ※ **Solid/dense foods** should not be cooked from frozen as they will be overcooked round the edges before the centre has reached the required temperature.
- ※ **Cover** dishes where appropriate during cooking/reheating. This will retain moisture and prevent splashing/spillages.
- ※ Loosen lids/pierce cling film before cooking / reheating covered foods.
- ※ **Stir** foods halfway while cooking / defrosting time for even distribution of energy

DELAY START

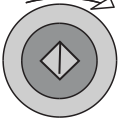
Delay start function allows the oven to start up in a later time. Suppose now the clock running at 11:10 and you want the oven to start cooking at 11:30.

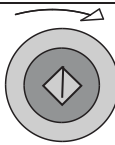
STEP 1	STEP 2	STEP 3
Set cooking program.	 Press Pre-set pad.	 Rotate the TIME/WEIGHT to set 11.

STEP 4	STEP 5	STEP 6
 Press Pre-set pad	 Rotate the TIME/WEIGHT to set 30.	 Press START pad.

NOTE: Make sure that food is placed into the oven in advance before any cooking starts.

MULTI-STAGE COOKING

The oven can be programmed to do several consecutive functions.

Suppose you want to set the following cooking program:

- ① Jet Defrost;
- ② Microwave cooking;
- ③ Grill cooking.

Steps:

If necessary, press STOP/CANCEL pad once to reset the oven.

STEP 1	STEP 2	STEP 3
Input jet defrost program.	Press MEMORY pad.	Input microwave or power level cooking program.

STEP 4	STEP 5	STEP 6
Press MEMORY pad	Input a grill cooking program.	Press START pad.

NOTE: JET DEFROST should be included only when it is set foremost in a multistage



cooking program.

WEIGHT DEFROST and AUTO MENU cannot be set in a multistage cooking program.

The respective lights will come on to indicate which stage the oven is operating in. After total time has elapsed, 5 beeps sound, "END" and "HOT" display alternately.

CHILD LOCK

Use to prevent unsupervised operation of the oven by little children. The CHILD LOCK indicator will show up on display screen, and the oven cannot be operated while the CHILD LOCK is set.

To set the CHILD LOCK	To cancel the CHILD LOCK
 <p>STOP/CANCEL</p> <p>Press and hold STOP/CANCEL button for 3 seconds, a beep sounds and LOCK indicator lights.</p>	 <p>STOP/CANCEL</p> <p>Press and hold the STOP/CANCEL button for 3 seconds until lock indicator on display goes off.</p>

CLEANING AND CARE

1. Turn off the oven and remove the power plug from the wall socket before cleaning.
2. Keep the inside of the oven clean. When food splatters or spilled liquids adhere to oven walls, wipe with a damp cloth. Mild detergent may be used if the oven gets very dirty. Avoid the use of spray and other harsh cleaners as they may stain, streak or dull the door surface.
3. The outside surfaces should be cleaned with a damp cloth. To prevent damage to the operating parts inside the oven, water should not be allowed to seep into the ventilation openings.
4. Wipe the door and window on both sides, the door seals and adjacent parts frequently with a damp cloth to remove any spills or splatters. Do not use abrasive cleaner.
5. Do not allow the control panel to become wet. Clean with a soft, damp cloth. When cleaning the control panel, leave oven door open to prevent oven from accidentally turning on.
6. If steam accumulates inside or around the outside of the oven door, wipe with a soft cloth. This may occur when the microwave oven is operated under high humidity condition. And it is normal.
7. It is occasionally necessary to remove the glass tray for cleaning. Wash the tray in warm sudsy water or in a dishwasher.
8. The roller ring and oven floor should be cleaned regularly to avoid excessive noise. Simply wipe the bottom surface of the oven with mild detergent. The roller ring may be washed in mild sudsy water or dishwasher. When removing the roller ring from cavity floor for cleaning, be sure to replace in the proper position.
9. Remove odors from your oven by combining a cup of water with the juice and skin of one lemon in a deep microwaveable bowl, microwave for 5 minutes. Wipe thoroughly and dry with a soft cloth.
10. When it becomes necessary to replace the oven light, please consult a dealer to have it replaced.
11. The oven should be cleaned regularly and any food deposits removed. Failure to maintain the oven in a clean condition could lead to deterioration of the surface that could adversely affect the life of the appliance and possibly result in a hazardous.
12. Please do not dispose this appliance into the domestic rubbish bin; it should be disposed to the particular disposal center provided by the municipalities.

WARRANTY

IFB Industries Limited, (" The Company") warrants to the original domestic purchase of this Microwave Oven. ("Appliances") that it is free from defects in workmanship & materials. During 12 months from the date of purchase of the new Microwave Oven, all the parts of the Microwave Oven which prove to be defective in workmanship and/or materials shall be replaced or repaired free of charge subject to Limitations of Warranty.

LIMITATIONS OF WARRANTY

1. This warranty is not valid in case of the following events.
 - a) If the warranty card is not fully and properly filled in and signed at the time of purchase / installation by the company's authorised dealer / service engineer.
 - b) If the completed warranty card is not presented to the authorised personnel at the time of service / repair.
 - c) If the appliance is not used in accordance with manufacturer's instructions given in the Operating Manual.
 - d) If the appliance has been serviced, repaired, opened or tampered by any unauthorized personnel.
 - e) If defects arise / caused by accidents, alteration, misuse, neglect, abuse, substitution of original components with spurious / non-genuine components, attack by household pests / rodents, fire, flood, earth-quake, lightning and / or any other acts of God / natural calamities.
 - f) If damages occur by improper electrical, circuit outside the appliance or by any defective electrical supply thereof.
 - g) If the machine serial number on the appliance is defaced, missing or altered.
 - h) If the appliance is taken out of India.
2. This warranty does not cover any type of painting, plating including rusting etc or defects thereof.
3. This warranty does not cover normal wear and tear of parts.
4. Liability for consequential damages is neither accepted nor implied.
5. Parts replaced or repaired under this warranty are warranted throughout the remaining of the original warranty period.
6. The company is not liable for any delay in servicing due to reasons beyond the control of the company or any of its authorised service center.
7. This warranty is not applicable, if the Microwave Oven is used for commercial purpose of at places like Institutions, Hotels, Hostels, Hospitals, Community Halls and other similar applications.
8. This warranty is issued subject to the jurisdiction of Kolkata courts.
9. This is the **ONLY WARRANTY** covering the appliance given by the Company.

Note: For all types of repairs / maintenance under warranty, the appliance shall be brought to the nearest Company service centre or its authorised service agent.

=====

IFB Industries Limited
Regd.off.:14 Taratolla Road
Kolkata - 700088