



## Owner's Manual

Hustler Mini Z™

FasTrak™ Super Duty 36/42



**HUSTLER** 

# GENERAL INFORMATION

This manual applies to the following Hustler equipment lines:

**Hustler Mini Z 36/42**  
**FasTrak Super Duty 36/42**

## To the new owner

The purpose of this manual is to assist owners and operators in maintaining and operating the Hustler Mini Z tractor and deck. Please read it carefully; information and instructions furnished can help you achieve years of dependable performance.

A separate Engine Owner's Manual is included with your owner's packet which contains additional engine information that will not be repeated in this manual. You are urged to read it before attempting any operation or repair of the engine.

The Quick Reference Decals are designed to give the operator brief information needed in the daily operation of the machine. These decals are not intended to be used in place of this manual but instead are to be used as an extension of this manual. These decals should not be removed or obliterated. Replace these decals if they become unreadable.

It is the **owner's responsibility** to make certain that the operators and mechanics read and understand this manual and the Quick Reference Decals before operating this machine. It is also the **owner's responsibility** to make certain that the operators and mechanics are qualified and physically able individuals, properly trained in the operation of this equipment. All operators and mechanics must become familiar with the safe operation of its equipment, operator controls and safety signs before operating the equipment.

Never let children or untrained people operate or service the equipment. Local regulations may restrict the age of the operator.

The owner/user can prevent and is responsible accidents or injuries occurring to themselves, other people or property.

**IMPORTANT:** For more detailed maintenance and adjustment information refer to the proper parts manual for your machine. Refer to the Product Literature section of this manual for ordering information.

## Using this manual

General operation, adjustment and maintenance guidance is outlined for both the experienced and novice Hustler user. Operating conditions vary considerably and cannot all be addressed individually. Through experience, however, operators should find no difficulty in developing good operating skills suitable to most conditions.

Directions used in this manual, for example RIGHT or LEFT, refer to directions when seated on tractor facing forward, unless otherwise stated.

Photographs and illustrations used were current at the time of printing, but subsequent production changes may cause your machine to vary slightly in detail. Hustler Turf Equipment reserves the right to redesign and change the machine as deemed necessary, without notification. If a change has been made to your machine which is not reflected in this owner's manual, or the parts manual, see your Hustler dealer for current information and parts.

## Warranty registration

The Delivery and Warranty Registration form must be completed and signed to validate your warranty protection. As the new equipment owner, you are expected to see that the form is completed and forwarded to Hustler Turf Equipment at time of delivery.

Be sure to register the tractor plus each attachment that displays a model and serial identification number plate with Hustler Turf Equipment.

**IMPORTANT:** Any unauthorized modification, alteration, or use of non-approved attachments voids the warranty and releases Hustler Turf Equipment from any liability arising from subsequent use of this equipment.

## Model and serial number

Tractor model and serial numbers are found on the serial identification plate, located on the frame directly below and to the right of the operator's platform.

These numbers are required on the Warranty Registration form. They will also assure you of the correct service parts when replacement becomes necessary.

## Parts and service

Use original Hustler replacement parts only. These parts are available through your local Hustler dealer. To obtain prompt, efficient service, always provide the following information when ordering parts:

1. Correct part description
2. Correct model number.
3. Correct serial number.

All warranty repair and service must be handled through an authorized Hustler dealer. Arrangements should be made through your local service center.

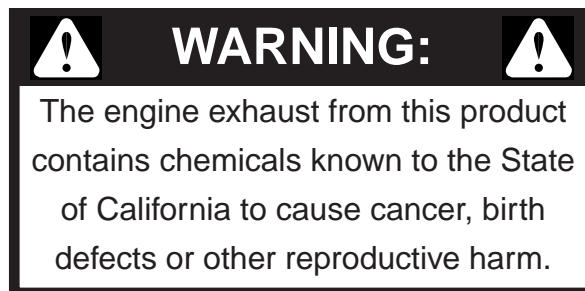

**IMPORTANT:** This engine is not equipped with a spark arrester muffler. It is a violation of California Public Resource Code Section 4442 to use or operate this engine on any forest-covered, brush-covered, or grass-covered unimproved land. Other states or federal areas may have similar laws.

This spark ignition system complies with Canadian ICES-002.

**The enclosed Engine Owner's Manual is supplied for information regarding the U.S. Environmental Protection Agency (EPA) and the California Emission Control Regulation of emission systems, maintenance and warranty.**

**Keep this Engine Owner's Manual with your unit. Should the Engine Owner's Manual become damaged or illegible, replace immediately. Replacements may be ordered per the information found in the Product Information section of this manual.**



**HUSTLER MINI Z 36/42**  
**TWO YEAR LIMITED WARRANTY FOR TRACTORS AND DECKS**  
**(THREE YEAR LIMITED WARRANTY ON DECK**  
**SPINDLE BEARING & DECK GAUGE FORK BEARING)**

**WHAT IS COVERED BY THIS WARRANTY**

Hustler Turf Equipment, makes the following warranty to the original purchaser only:

- a. First and Second Year:** Hustler Turf Equipment Tractors and Power Units are warranted for **two (2) years from date of delivery** on all materials and workmanship.

If the Purchaser discovers within this warranty period a defect in materials or workmanship:

- He must promptly notify Hustler Turf Equipment, or an authorized dealer, in writing of the defect. In no event shall such notification be received by Hustler Turf Equipment, or an authorized dealer later than twenty-five (25) months from date of delivery.
- Within a reasonable time after such notification, Hustler Turf Equipment, will correct any defect in material or workmanship on the Hustler Turf Equipment, by repairing or replacing part(s) with either new or used replacement parts.
- Such repair, including parts and labor shall be at the expense of Hustler Turf Equipment, and,

- b. Third Year:** At the conclusion of the two year limited warranty described in paragraph (a) above, there shall be an additional one year limited warranty on deck gauge fork bearings and deck spindle bearings only, **no labor**.

If the Purchaser discovers within this warranty period a defect in either of these bearings:

- He must promptly notify Hustler Turf Equipment, or an authorized dealer, in writing of the defect. In no event shall such notification be received by Hustler Turf Equipment, or an authorized dealer later than thirty-seven (37) months from date of delivery.
- Within a reasonable time after such notification, Hustler Turf Equipment, will provide new replacement bearing to install on the Hustler Turf Equipment.
- The installation of the deck gauge fork bearing and deck spindle bearing shall be at the expense of the owner, and,

- c. Rental Units (90 days):** Within 90 days of date of delivery Hustler Turf Equipment, provides a limited warranty on all materials and workmanship for units used for rental purposes.

If the Purchaser discovers within this warranty period a defect in materials or workmanship:

- He must promptly notify Hustler Turf Equipment, or an authorized dealer, in writing of the defect. In no event shall such notification be received by Hustler Turf Equipment, or an authorized dealer later than 120 days from date of delivery.
- Within a reasonable time after such notification, Hustler Turf Equipment, will correct any defect in material or workmanship on the Hustler Turf Equipment, by repairing or replacing part(s) with either new or used replacement parts.
- Such repair, including parts and labor shall be at the expense of Hustler Turf Equipment, and,

- d. Hustler Turf Equipment** provides a limited warranty **for the entire length of ownership by the original purchaser** for the following items:

- Against all defects in the frame resulting from frame breakage.
- Against all defects in the mowing deck which results in the **front edge of the deck** being bent into the blades.

If the original Purchaser discovers within this warranty period such a defect:

- He must promptly notify Hustler Turf Equipment or an authorized dealer, in writing of the defect. Such notification must be received by Hustler Turf Equipment or an authorized dealer during the period when the equipment is owned by the original purchaser.

- Hustler Turf Equipment will correct any defect in the frame resulting in frame breakage by repairing or replacing part(s) with new or used replacement parts.
  - Hustler Turf Equipment will correct any defect in the deck resulting in the front edge of the deck being bent into the blades by repairing or replacing part(s) with either new or used replacement parts.
  - Such repair, including parts and labor, shall be at the expense of Hustler Turf Equipment, and,
- e. The engines** are covered by a two (2) year limited warranty, by the engine manufacturer, to the original owner (commercial or residential) only, and,
- f. The battery** is covered by a one (1) year limited warranty to the original owner only.

**WHO MUST PERFORM THE WARRANTY SERVICE**

All warranty service will be performed by dealers authorized by Hustler Turf Equipment. **Service calls and/or transportation expense** of the product to and from the authorized dealer, for warranty work, will be paid by the owner of the product. For warranty service you can contact an authorized dealer or write Hustler Turf Equipment, 200 South Ridge Road, Hesston, Kansas 67062, or call 1-620-327-4911.

**WHAT IS NOT COVERED BY THIS WARRANTY**

Hustler Turf Equipment, does not warranty:

- Some product, components or parts not manufactured by Hustler Turf Equipment
- Repairs made by unauthorized persons
- Damage caused by use of the Hustler Turf Equipment for purposes other than those for which it was designed
- Damages caused by disasters such as fire, flood, wind, and lightning
- Damages caused by neglect, abuse, abnormal use, improper or unreasonable use, accident, negligence or misuse
- Repairs or replacement resulting from the use of unauthorized parts, accessories or attachments
- Repairs or replacement as the result of any alterations or modifications, in the determination of Hustler Turf Equipment, which adversely affects the operation, performance or durability of the equipment.
- Hustler Turf Equipment which has the serial number removed or made illegible
- Depreciation or damage caused by normal wear, lack of reasonable and proper maintenance, failure to follow the product's owner's manual operating, maintenance and adjustment instructions or other operational instructions provided by Hustler Turf Equipment.
- Normal maintenance parts and service including, but not limited to, filters, fuel, lubricants, tune-up parts, belts, blades, blade sharpening, bearings, brake or steering adjustments
- Repairs necessary due to improper fuel, contaminants in the fuel system, or failure to properly prepare the fuel system prior to any period of non-use over three months

**DISCLAIMER OF WARRANTY**

The foregoing warranties are in lieu of all other warranties, expressed or implied, including but not limited to the implied warranties of merchantability and fitness for a particular purpose. However, if the Hustler Turf Equipment is purchased as a consumer product, any implied warranty of merchantability or fitness for a particular purpose is limited to the duration of this limited warranty. Some states do not allow limitations on how long an implied warranty lasts, so the above limitation may not apply to you. This warranty gives you specific legal rights, and you may also have other rights which vary from state to state.

## LIMITATION OF REMEDIES

In no case shall Hustler Turf Equipment, be liable for any special, incidental, or consequential damages based upon breach of warranty, breach of contract, negligence, strict liability in tort, or any other legal theory.

Such damages include, but are not limited to:

- Loss of profits
- Loss of savings or revenue
- Loss of use of Hustler Turf Equipment or any associated equipment
- Cost of capital
- Cost of any substitute equipment, facilities, services or downtime
- The claims of third parties including customers, and injury to property

Some states do not allow the exclusion or limitation of incidental or consequential damages, so the above limitation or exclusion may not apply to you.

## TIME LIMIT

Any action for breach of warranty must be commenced within twenty-five (25) months following delivery of the goods in a non-rental application. Any action for breach of warranty must be commenced within 120 days following delivery of the goods in a rental application.

## NO OTHER WARRANTIES

Unless modified in writing, signed by both parties, and approved by the President of Hustler Turf Equipment, this agreement is understood to be the complete and exclusive agreement between the parties, superseding all prior agreements, oral or written, and all other communications between the parties relating to the subject matter of this agreement. No employee of Hustler Turf Equipment, or any other party is authorized to make any warranty in addition to those made in this agreement.

## ALLOCATION OF RISKS

This agreement allocates the risks of product failure between Hustler Turf Equipment, and the purchaser. This allocation is recognized by both parties and is reflected in the price of the goods.

## OWNER'S RESPONSIBILITY

You must maintain your Hustler Turf Equipment product following the maintenance procedures described in your owner's manual. Such routine maintenance, whether performed by a dealer or by you, is at your expense.

**This machine like any other powered equipment is potentially dangerous unless properly operated.** Any operator **must** be cautious and keep safety in mind at all times. Any operator, prior to using the Hustler Turf Equipment, should thoroughly familiarize himself with the owner's manual regarding operation and safety of the machine, as well as all safety warnings on the machine itself.

## WARRANTY REGISTRATION

1. Register the unit on-line at [www.Hustlerdealer.com](http://www.Hustlerdealer.com) or by filling out the Warranty registration form, provided in the owner's packet. If using the Warranty registration form it **MUST** be completed and signed by the authorized dealer and original purchaser.
2. For validation, the completed Warranty registration form **MUST** be forwarded to Hustler Turf Equipment, within ten (10) days following date of purchase.
3. The date of purchase constitutes delivery.

**FASTRAK SUPER DUTY 36/42  
HUSTLER TURF CONSUMER PRODUCT  
FOUR YEAR OR 800 HOURS WARRANTY FOR RESIDENTIAL USE  
(TWO YEAR OR 800 HOURS WARRANTY FOR COMMERCIAL USE)  
UNITS WITH SERIAL NUMBER 0710 (FIRST 4 DIGITS) AND LATER**

**WHAT IS COVERED BY THIS WARRANTY**

Hustler Turf Equipment, makes the following warranty to the original purchaser only:

- a. Residential use:** Hustler Turf Consumer Products used for normal residential purposes\* are warranted for **four (4) years or 800 hours** whichever comes first, from date of delivery on all defects in materials and workmanship.

If the Purchaser discovers within this warranty period such a defect:

- He must promptly notify Hustler Turf Equipment, or an authorized dealer, in writing of the defect. In no event shall such notification be received by Hustler Turf Equipment, or an authorized dealer later than 30 days after expiration of warranty.
- He must promptly notify Hustler Turf Equipment, or an authorized dealer, in writing of the defect. In no event shall such notification be received by Hustler Turf Equipment, or an authorized dealer later than 30 days after expiration of warranty.
- Within a reasonable time after such notification, Hustler Turf Equipment, will correct any defect in material or workmanship on the Hustler Turf Equipment, by repairing or replacing part(s) with either new or used replacement parts.
- Such repair, including parts and labor shall be at the expense of Hustler Turf Equipment, and,

\* **Normal residential purpose means use of product on same lot as your home.** Use at more than one location is considered commercial use, and then the commercial use warranty would apply.

- b. Commercial use:** Hustler Turf Consumer Products used for commercial or institutional use are warranted for **two years or 800 hours** whichever comes first, from date of delivery on all defects in materials and workmanship. **(Rental use is warranted for 90 days)**

If the Purchaser discovers within this warranty period such a defect:

- He must promptly notify Hustler Turf Equipment, or an authorized dealer, in writing of the defect. In no event shall such notification be received by Hustler Turf Equipment, or an authorized dealer later than 30 days after expiration of warranty.
- Within a reasonable time after such notification, Hustler Turf Equipment, will correct any defect in material or workmanship on the Hustler Turf Equipment, by repairing or replacing part(s) with either new or used replacement parts.
- Such repair, including parts and labor shall be at the expense of Hustler Turf Equipment, and,

- c. Hustler Turf Equipment** provides a limited warranty for the entire length of ownership by the original purchaser only (commercial or residential) for the following items:

- Against all defects in the tractor frame resulting from frame breakage.
- Against all defects in the mowing deck which results in the front edge of the deck being bent into the blades.

If the original Purchaser discovers within this warranty period such a defect:

- He must promptly notify Hustler Turf Equipment or an authorized dealer, in writing of the defect. Such notification must be received by Hustler Turf Equipment or an authorized dealer during the period when the equipment is owned by the original purchaser.
- Hustler Turf Equipment will correct any defect in the frame resulting in frame breakage by repairing or replacing part(s) with new or used replacement parts.
- Hustler Turf Equipment will correct any defect in the deck resulting in the front edge of the deck being bent into the blades by repairing or replacing part(s) with either new or used replacement parts.

- Such repair, including parts and labor, shall be at the expense of Hustler Turf Equipment, and,

- d. The Kawasaki engine** is covered by a two (2) year limited warranty, by the engine manufacturer, to the original owner (commercial or residential) only, and,

- e. The battery** is covered by a one (1) year limited warranty to the original owner only.

**WHO MUST PERFORM THE WARRANTY SERVICE**

All warranty service will be performed by dealers authorized by Hustler Turf Equipment. **Service calls and/or transportation expense** of the product to and from the authorized dealer, for warranty work, will be paid by the owner of the product. For warranty service you can contact an authorized dealer or write Hustler Turf Equipment, 200 South Ridge Road, Hesston, Kansas 67062, or call 1-620-327-4911.

**WHAT IS NOT COVERED BY THIS WARRANTY**

Hustler Turf Equipment, does not warranty:

- Some product, components or parts not manufactured by Hustler Turf Equipment
- Repairs made by unauthorized persons
- Damage caused by use of the Hustler Turf Equipment for purposes other than those for which it was designed
- Damages caused by disasters such as fire, flood, wind, and lightning
- Damages caused by neglect, abuse, abnormal use, improper or unreasonable use, accident, negligence or misuse
- Repairs or replacement resulting from the use of unauthorized parts, accessories or attachments
- Repairs or replacement as the result if any alterations or modifications, in the determination of Hustler Turf Equipment, which adversely affects the operation, performance or durability of the equipment.
- Hustler Turf Equipment which has the serial number removed or made illegible.
- Depreciation or damage caused by normal wear, lack of reasonable and proper maintenance, failure to follow the product's owner's manual operating, maintenance and adjustment instructions or other operational instructions provided by Hustler Turf Equipment.
- Normal maintenance parts and service including, but not limited to, filters, fuel, lubricants, tune-up parts, belts, blades, blade sharpening, brake or steering adjustments.
- Repairs necessary due to improper fuel, contaminates in the fuel system, or failure to properly prepare the fuel system prior to any period of non-use over three months.

**DISCLAIMER OF WARRANTY**

**The foregoing warranties are in lieu of all other warranties, expressed or implied, including but not limited to the implied warranties of merchantability and fitness for a particular purpose. However, if the Hustler Turf Equipment is purchased as a consumer product, any implied warranty of merchantability or fitness for a particular purpose is limited to the duration of this limited warranty. Some states do not allow limitations on how long an implied warranty lasts, so the above limitation may not apply to you. This warranty gives you specific legal rights, and you may also have other rights which vary from state to state.**

**LIMITATION OF REMEDIES**

In no case shall Hustler Turf Equipment, be liable for any special,

incidental, or consequential damages based upon breach of warranty, breach of contract, negligence, strict liability in tort, or any other legal theory.

Such damages include, but are not limited to

- Loss of profits
- Loss of savings or revenue
- Loss of use of Hustler Turf Equipment or any associated equipment
- Cost of capital
- Cost of any substitute equipment, facilities, services, or downtime
- The claims of third parties including customers, and injury to property

Some states do not allow the exclusion or limitation of incidental or consequential damages, so the above limitation or exclusion may not apply to you.

### **TIME LIMITS**

Any action for breach of warranty must be commenced within 30 days after expiration of warranty in a residential application. Any action for breach of warranty must be commenced within 30 days after expiration of warranty in a commercial application.

### **NO OTHER WARRANTIES**

Unless modified in writing, signed by both parties, and approved by the President of Hustler Turf Equipment, this agreement is understood to be the complete and exclusive agreement between the parties, superseding all prior agreements, oral or written, and all other communications between the parties relating to the subject matter of this agreement. No employee of Hustler Turf Equipment, or any other party is authorized to make any warranty in addition to those made in this agreement.

### **ALLOCATION OF RISKS**

This agreement allocates the risks of product failure between Hustler Turf Equipment, and the purchaser. This allocation is recognized by both parties and is reflected in the price of the goods.

### **OWNER'S RESPONSIBILITY**

You must maintain your Hustler Turf Consumer Product following the maintenance procedures described in your owner's manual. Such routine maintenance, whether performed by a dealer or by you, is at your expense.

**This machine like any other powered equipment is potentially dangerous unless properly operated.** Any operator **must** be cautious and keep safety in mind at all times. Any operator, prior to using the Hustler Turf Equipment, should thoroughly familiarize himself with the owner's manual regarding operation and safety of the machine, as well as all safety warnings on the machine itself.

### **WARRANTY REGISTRATION**

1. Register the unit on-line at [www.hustlerdealer.com](http://www.hustlerdealer.com) or by filling out the Warranty registration form, provided in the owner's packet. If using the Warranty registration form it **MUST** be completed and signed by the authorized dealer and original purchaser.
2. For validation, the completed Warranty registration form **MUST** be forwarded to Hustler Turf Equipment, within ten (10) days following date of purchase.
3. The date of purchase constitutes delivery.

# SAFETY PRECAUTIONS



This safety alert symbol is used to call attention to a message intended to provide a reasonable degree of **PERSONAL SAFETY** for operators and other persons during the normal operation and servicing of this equipment.

**DANGER** – denotes immediate hazards which **WILL** result in severe personal injury or death.

**WARNING** - denotes a hazard or unsafe practice which **COULD** result in severe personal injury or death.

This manual uses two other words to highlight information. **IMPORTANT** calls attention to special mechanical information and **NOTE:** emphasizes general information worthy of special attention.

All operators and mechanics should read this manual and be instructed about safe operating and maintenance procedures. If the operators or mechanics cannot read or understand English, it is the owner's responsibility to explain this material to them.

**Improper use or maintenance by the operator or owner can result in injury. To reduce the potential for injury, comply with these safety instructions and always pay attention to the safety alert ▲ symbol, which means DANGER or WARNING - “personal safety instructions.” Failure to comply with the instructions may result in personal injury or death.**

**Incorrect usage of this machine may result in severe injury. Personnel operating and maintaining it should be trained in the proper use and should read the manuals completely and thoroughly before attempting to set-up, operate, adjust, or service this machine.**

The Quick Reference Decals are designed to give the operator brief information needed in the daily operation of the machine. These decals are not intended to be used in place of this manual but instead are to be used as an extension of this manual. These decals should not be removed or obliterated. Replace these decals if they become unreadable.

It is the **owner's responsibility** to make certain that the operators and mechanics read and understand this manual and the Quick Reference Decals before operating this machine. It is also the **owner's responsibility** to make certain that the operators and mechanics are qualified and physically able individuals, properly trained in the operation of this equipment. All operators and mechanics must become familiar with the safe operation of its equipment, operator controls and safety signs before operating the equipment.

Never let children or untrained people operate or service the equipment. Local regulations may restrict the age of the operator.

The owner/user can prevent and is responsible accidents or injuries occurring to themselves, other people or property.

The owner should also ensure that the operator/mechanic know that they are responsible for their own safety as well as the safety of other persons within the vicinity. **Remember**, the operator is responsible for accidents or hazards occurring to other people or their property.



## Safety and Instruction Decals

- ▲ Specific safety warning decals are located on the equipment near the immediate areas of potential hazards. These decals should not be removed or obliterated. Replace them if they become non-readable.

The following illustrations show the various **decals** that are located on the machine. A brief explanation, for those requiring one, is shown to help the operator understand the meanings of these decals.



Read Owner's Manual and Quick Reference Decal before attempting to operate this machine.

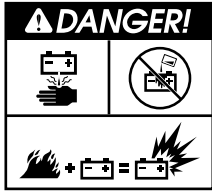

Part Number  
727016

Avoid skin contact with battery acid. Always wear eye protection when checking the battery, acid can cause serious injury to skin and eyes. If contact occurs, flush area with clean water and call physician immediately. Acid will also damage clothing. Do not allow open flame near the battery when charging. Hydrogen gas forms inside the battery. This gas is both toxic and flammable and may cause an explosion if exposed to flame. Always remove the negative ground first and replace it last. Do not overfill battery. Electrolyte may overflow and damage paint, wiring or structure. When cleaning the battery, use soap and water. Be careful not to get soap and water into the battery. Use soda mixed in water to clean corrosion off the terminals.



Part Number  
771436

Do not remove or modify stabilizer wheels or injury can result. Never stop suddenly while backing down slopes. This action may result in a reaction of the tractor that can cause serious physical injury.



Part Number  
788968

Keep engine and pump compartment(s) clean (especially in exhaust area) to prevent fire and provide maximum engine and hydraulic cooling.

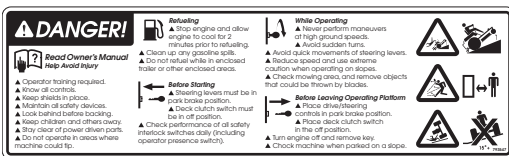

Part Number  
793547

Do not remove or modify stabilizer wheels or injury can occur. Keep a safe distance from machine. When operating on a slope (up to 15 degrees) be aware of any conditions that may cause the tractor drive tires to lose traction resulting in a possible loss of control of the machine.

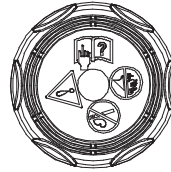

Do not smoke while refueling. Do not fill tank with engine running, or while the engine is hot. Allow engine to cool before storing machine inside a building. Store away from open flame or spark if there is fuel in tank. Clean up any gasoline spills. Do not refuel while in enclosed trailer or other enclosed areas.



Part Number  
600899

If you lose steering control while operating the machine, place the steering control levers in the park brake position immediately. Report the incident and advise your dealer to make the problem before continuing to operate. If pump belt fails, steering control will be lost. Refer to owner's manual for inspection and replacement intervals and refer to above paragraph for emergency procedures.

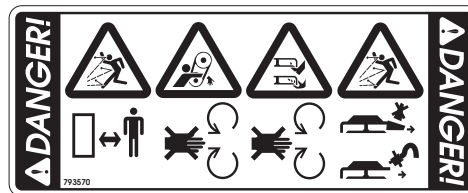

Part Number  
793570

Never operate the mower deck with side deflector damaged, altered, removed or in raised position, except when the entire grass catcher attachment or mulching system is being used.

Stay clear of mower blades as long as engine is running.

Keep a safe distance from machine.

Keep shields or covers in place while machine is in operation.

Keep hands away from rotating pulleys and belts.

Whirling blades! Keep hands and feet away.

Beware of thrown objects.



Part Number 794297

Never operate the mower deck with side deflector removed or in raised position, except when the grass catcher attachment is being used. Stay clear of mower blades as long as engine is running. Beware of thrown objects.

# SLOPE GUIDE

Use this diagram when determining the degree of slope to be mowed.

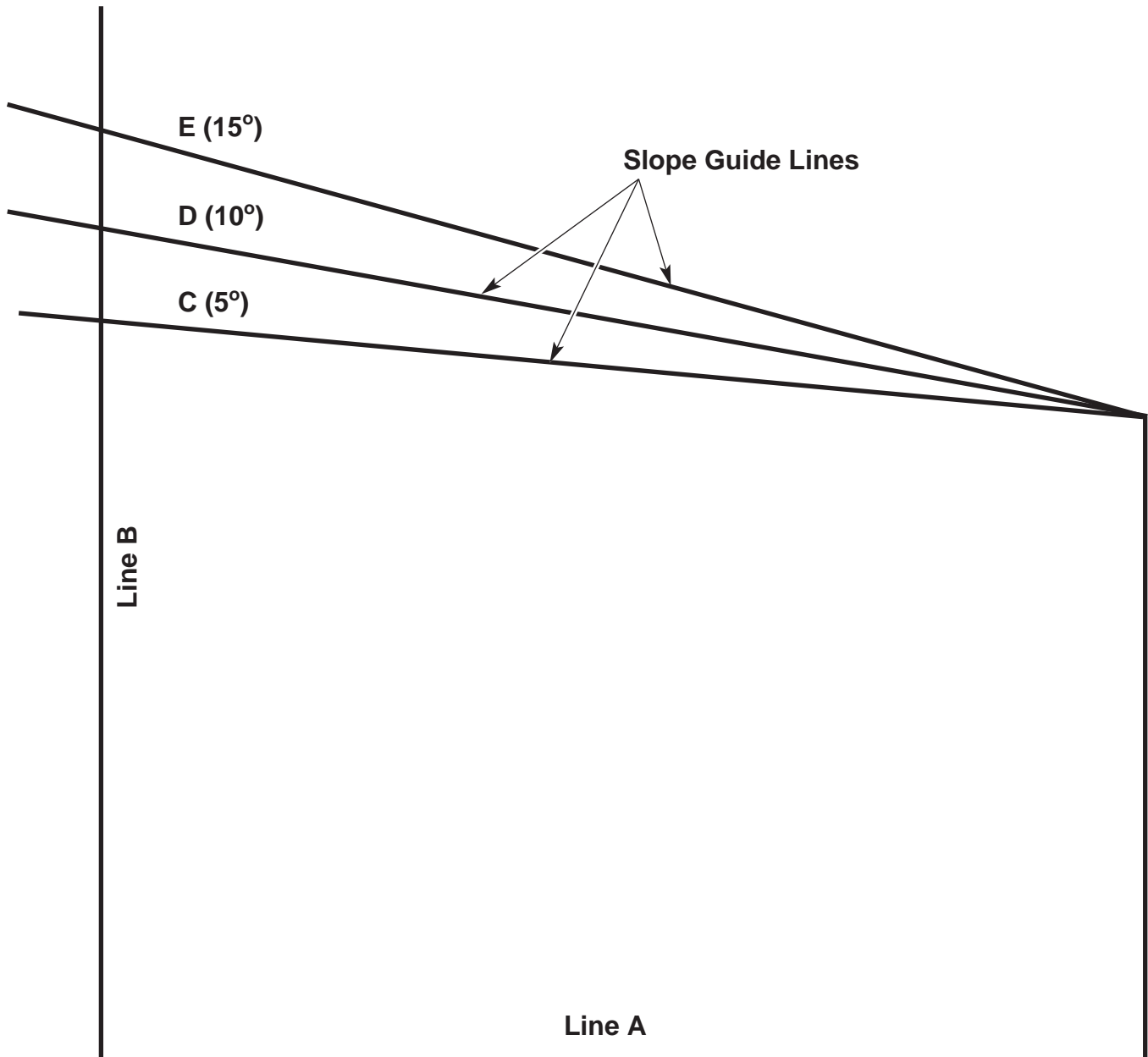

1. Hold this sheet of paper in front of you. Make sure that line A is horizontal.
2. Align line B with a vertical surface such as a pole, tree or building.
3. Fold the paper along the slope guide lines (C, D or E).
4. Align the closest slope guide line with the ground slope. This will give you a close estimation of the ground slope to be mowed.

Figure 2-1



# OPERATION

## Safe Operating Practices

This product is capable of amputating hands and feet and throwing objects. Always follow all safety instructions to avoid serious injury or death.

## Operation

- ▲ Evaluate the terrain to determine what accessories and attachments are needed to properly and safely perform the job. Only use accessories and attachments approved by the manufacturer.
- ▲ Never leave a running machine unattended. Always stop on level ground, disengage deck clutch, place steering control levers in park brake position, stop tractor engine, and remove ignition key before leaving operator's seat for any reason including emptying the catcher or unclogging the chute.
- ▲ Do not change the engine governor setting or overspeed the engine.
- ▲ Always remain seated while operating machine.
- ▲ Always keep safety shields and covers in place, except for servicing.
- ▲ Always maintain a safe distance from people and pets when mowing. Always stop machine if someone enters the area.
- ▲ Always operate machine in daylight or with adequate working lights.
- ▲ Follow daily and weekly checklists, making sure hoses are tightly secured and bolts are tightened.
- ▲ Always observe traffic laws while driving machine from one location to another. Watch for traffic when operating near or crossing roadways.
- ▲ Always be alert for hazards such as rocks, metal objects and other debris which may be thrown or entangled by mower blades. Watch out for holes or deep depressions.
- ▲ Inspect area to be mowed for hazards such as rocks, metal objects and other debris which may be thrown or entangled by mower blades. Remove these objects before mowing.
- ▲ Always inspect machine for damage after striking a foreign object. If damage is found, repair machine immediately. Be sure to stop on level ground, disengage deck clutch, place steering control levers in park brake position, stop tractor engine, and remove ignition key when leaving operator's seat to inspect damage.
- ▲ Always wear adequate ear protection, such as earplugs, when operating this equipment as prolonged exposure to uncomfortable or loud noises can cause impairment or loss of hearing. Do not wear radios or music headphones while operating the machinery. Safe operation requires your full attention.
- ▲ Do not operate the equipment while wearing sandals, tennis shoes, sneakers, shorts or any type of loose fitting clothing. Long hair, loose clothing or jewelry may get tangled in moving parts. Always wear long pants, safety glasses, ear protection and safety shoes when operating this machine.
- ▲ Always be aware of what is behind the machine before backing up. Do not mow in reverse unless absolutely necessary. Always look down and behind before and while backing up.
- ▲ Never push forward suddenly on your control levers while the machine is in rearward motion because machine may tip backwards.
- ▲ Never pull back suddenly on your control levers while the machine is in forward motion.
- ▲ When moving in reverse, push forward slowly on control levers and avoid sudden movement. Rapid movement of the control levers in either direction could result in a reaction of the tractor that can cause serious injury.
- ▲ Never operate a poorly maintained machine.
- ▲ Never attempt high speed maneuvering, especially in crowded or congested areas.
- ▲ Never allow persons to operate this machine without proper instruction or allow children to operate machine. Allow only responsible adults who are familiar with these instructions to operate this machine.
- ▲ Never put hands or feet under any part of the machine while it is running.
- ▲ Never carry passengers.
- ▲ Never direct discharged material toward anyone. Avoid discharging

material against a wall or obstruction. Material may ricochet back toward the operator. Always disengage the blades and wait for them to stop before crossing gravel drives, walks or roads.

- ▲ Always keep clear of the mower blades and attachments during their operation.
- ▲ Turn off blades when not mowing.
- ▲ Slow down before turning.
- ▲ Stop the engine before removing the grass catcher or unclogging the discharge chute. Never clear the discharge chute with the engine running. Turn off the engine and be sure the blades have stopped before cleaning. Use a stick to clear a plugged discharge area. **Never use your hand!**
- ▲ Do not operate the machine while under the influence of alcohol or drugs.
- ▲ Exercise caution when loading or unloading the machine onto a trailer or truck.
- ▲ Always wear safety goggles or safety glasses with side shields when operating the mower.
- ▲ Data indicates that operators, age 60 years and above, are involved in a large percentage of riding mower-related injuries. These operators should evaluate their ability to operate the mower safely enough to protect themselves and others from serious injury.
- ▲ Follow the manufacturer's recommendation for wheel weights or counterweights.
- ▲ If any attachment or additional weight is mounted on the rear of the unit, any rapid movement of the control levers in either direction could result in a reaction of the tractor that can cause serious injury.
- ▲ **Clean flammable material from machine. Prevent fires by keeping engine compartment, top of deck, battery, exhaust area, fuel line, fuel tank and operator's station clean of accumulated trash, grass clippings, and other debris. Always clean up spilled fuel and oil.**

## Using a ramp

- ▲ Use extreme caution when loading and unloading a unit onto a truck or trailer with a ramp.
- ▲ Use only a single, full width ramp; do not use individual ramps for each side of the unit. Having a full width ramp provides a surface for the tractor frame to contact if the unit starts to tip backwards. It also reduces the risk of a wheel going off and the machine tipping over.
- ▲ Do not exceed a 15 degree angle between the ramp and the ground or between the ramp and the trailer or truck.
- ▲ When on a ramp avoid sudden acceleration

## Slope Operation

**Slopes are a major factor in loss-of-control and tip-over accidents, which can result in severe injury or death. All slopes require extra caution. If you cannot back up the slope or if you feel uneasy on it; do not mow it. REMINDER: Only operate on slopes of 15 degrees or less.**

- ▲ Use extreme caution when operating on slopes.
  - Be extremely careful changing directions on a slope. Slow down.
  - Do not operate where the machine could slip or tip.
  - Turn slowly
  - Turn on the most level part of the slope
  - To maximize traction, it is better to turn the front of the machine uphill, rather than downhill. **If drive tires lose traction, steering control is lost which could cause serious injury or death.**
  - If it becomes necessary to turn downhill, turn slowly and gradually, if possible.
- ▲ Do not remove or modify the stabilizer wheels.
- ▲ Watch for holes, ruts, bumps, rocks or other hidden objects. Uneven terrain could overturn the machine. Tall grass can hide obstacles.
- ▲ Remove obstacles such as rocks, tree limbs, etc.
- ▲ Keep all movement on slopes slow and gradual. Do not make sudden changes in speed or direction.
- ▲ Avoid starting and stopping on a slope. If tires lose traction, disengage the blades and proceed slowly straight down the slope.

- ▲ Mow a safe distance (minimum of 10 feet) away from drop-offs, retaining walls, drainage ditches, embankments, water, and other types of hazards to avoid a wheel dropping over the edge or to avoid the ground from breaking away. This will reduce the risk of the machine suddenly rolling over causing serious injury or death.
- ▲ Use a walk behind, push mower or hand-held trimmer on slopes and near drop-offs, retaining walls, drainage ditches, embankments and water to avoid machine rollover and serious injury or death.
- ▲ Do not mow on wet grass. Slippery conditions reduce traction which could cause sliding and loss of control.
- ▲ Do not try to stabilize the machine by putting your foot on the ground.
- ▲ If the mower's tires lose traction when operating on slopes, disengage the blades, place the control levers in the park brake position, turn the engine off and get help.
- ▲ Never make sudden starts, stops, turns, or reverse direction, especially when maneuvering on slopes. The steering is designed for sensitive response. Rapid movement of the control levers in either direction could result in a reaction of the tractor that can cause serious injury.
- ▲ Never stop suddenly while backing down slopes. This action may result in a reaction of the tractor that can cause serious physical injury.
- ▲ The Hustler mower is capable of operating horizontally (traverse) on moderately steep slopes. When operating on slopes up to 15 degrees, be aware of any conditions that may cause the tractor drive tires to lose traction resulting in a possible loss of control of the machine. An operator should not operate on a slope until he is thoroughly familiar with the equipment.

**Do not operate on slopes greater than 15 degrees.**

Refer to Figure 2-1, page 9, when determining the degree of slope to be mowed.

It is strongly recommended that the operator drive the machine off of the slope, using extreme caution, if any sign of loss of traction is detected. Wait until the condition that caused the problem is resolved before attempting to operate on the slope again.

Terrain conditions can affect traction resulting in possible loss of control of the machine. Some of the conditions to be aware of are:

1. Wet terrain
2. Depressions in the ground; i.e. holes, ruts, washouts
3. Mounds of dirt
4. Soil type; i.e. sand, loose dirt, gravel, clay
5. Grass type, density, and height
6. Extremely dry conditions of grass
7. Tire pressure

The attachments mounted to the tractor will also affect the way it handles on a slope. Be aware that each attachment's characteristics

vary.

Another consideration to safe mowing on slopes is to be aware of what is located at the bottom of the slope. Extreme caution should be used when there is a hazard located at the bottom of the slope.

Some examples are:

1. Water; i.e. lake, river
2. Cliffs, retaining walls
3. Roads, highways
4. Buildings
5. Rocks

These are just a few examples of situations when caution must be used when operating on a slope. There are many other possibilities too numerous to mention. Just remember to always exercise extreme caution when operating on any slope.

## Children

**Tragic accidents can occur if the operator is not alert to the presence of children. Children are often attracted to the machine and the mowing activity. Never assume that children will remain where you last saw them.**

- ▲ Never leave machine unattended with ignition key in switch, especially with children present.
- ▲ Children or bystanders may be injured if they move or attempt to operate the tractor while it is unattended. Always disengage deck clutch, place control levers in park brake position, stop tractor engine, and remove ignition key when leaving operator's seat.
- ▲ Keep children out of the mowing area and under the watchful care of another responsible adult.
- ▲ Be alert and turn the machine off if children enter the area.
- ▲ Before and while backing, look behind and down for small children.
- ▲ Never carry children, even with the blades off. They may fall off and be seriously injured or interfere with safe machine operation. Children who have been given rides in the past may suddenly appear in the mowing area for another ride and be run over or backed over by the machine.
- ▲ Never allow children to operate the machine.
- ▲ Never allow children or others in or on towed equipment.
- ▲ Use care when approaching blind corners, shrubs, trees, the end of a fence or other objects that may obscure vision.

## Control Panel

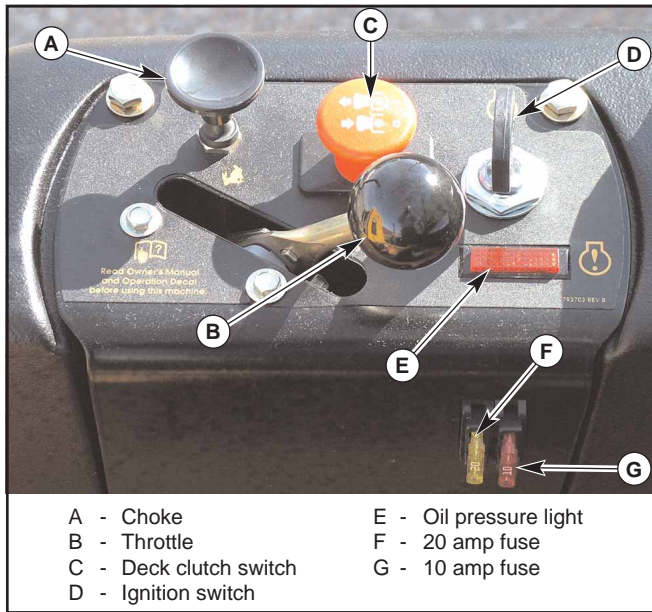

Figure 3-1

**IMPORTANT:** When access is required under the seat platform and the seat is equipped with the optional arm rests, make certain to place the control arms in the park brake position and pivot the arm rests upward before placing the seat platform in the full forward position to prevent arm rest damage.

### Control Panel

- A. Choke control (Fig. 3-1)** – a cable is linked to manually operate the engine choke. When the lever is in the down position, the choke is in the off (run) position. When the lever is pulled up, the choke is in the on (start) position. **Do not** operate the machine in the on (start) position.
- B. Throttle control (Fig. 3-1)** — a cable is linked to engine throttle for controlling engine speed. Move lever forward to increase engine rpm, move lever rearward to decrease engine rpm.
- C. Deck clutch switch (Fig. 3-1)** — this switch engages the deck. Pull the switch up to engage and push switch down to disengage the clutch.  
**IMPORTANT:** Never engage clutch with engine running at high rpm or when the deck is under load. Clutch, belts or deck could be damaged.
- D. Ignition switch (Fig. 3-1)** – a three position switch: off, run, and start. With key inserted, rotate it clockwise to START position; release key when engine starts, and switch will automatically return to the RUN position.
- E. Oil pressure light (Fig. 3-1)** — this light comes on when the ignition switch is placed in the RUN position and stays lit until the engine is running and a safe oil pressure is developed. If light comes on during operation, shut engine off immediately and locate and correct the problem.
- F. 20 amp fuse (Fig. 3-1)** — Main - 20 amp, blade-type
- G. 10 amp fuse (Fig. 3-1)** — Clutch/Aux - 10 amp, blade-type

### Controls

- A. Control levers (Fig. 3-2 & 3-3)** — these levers control the tractor's speed, direction, neutral lock, and park brake. Levers are used to steer, accelerate, decelerate and change direction. When the control levers are in the park brake position (3-3) the tractor will not move when the engine is on and drive pumps are operating.



**WARNING:** The parking brake may not hold the tractor if parked on a slope. Block or chock the machine when parked on a slope

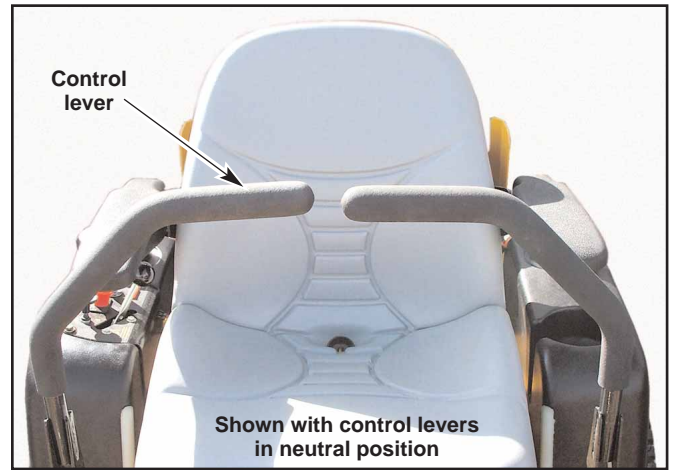

Figure 3-2

- B. Deck lift pedal (Fig. 3-4)** — the deck lift pedal is used to raise or lower the deck. Push on the pedal to raise the deck and then place the deck height locking pin into the desired cutting height hole. Push the deck lift pedal to raise the deck when going over obstructions.

### Safety start interlock system

The tractor is equipped with a safety start interlock system consisting of the park brake switches, seat switch, and deck clutch switch.

**Check tractor safety start interlock system daily, prior to operation.** This system is an important tractor safety feature. It should be repaired immediately if it malfunctions. The machine incorporates a separate seat switch which will stop the tractor engine when the operator is unseated for any reason while the tractor is operating. This is a safety feature designed to prevent runaway or accidental entanglement. To inspect the system:

1. The operator must be on the seat when testing the seat switch.
2. Set both control levers in the park brake position.
3. Start the engine and allow it to warm up to operating temperature.
4. With the deck clutch switch down and the control levers in the park brake position, slowly raise off of the seat. **The engine should continue to run.**



Figure 3-3

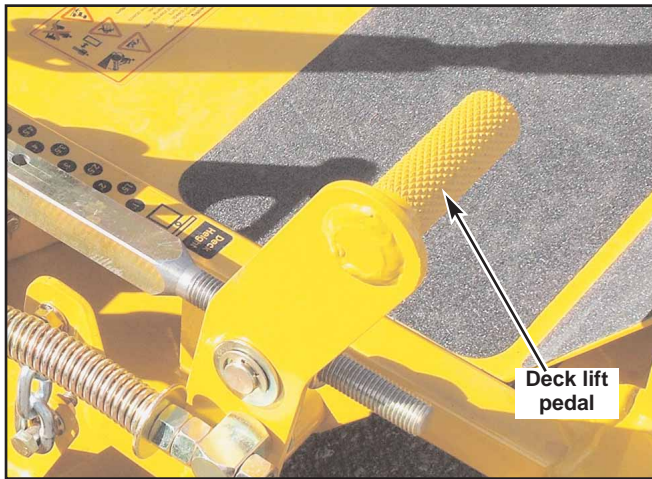

Figure 3-4

5. With the deck clutch switch up and/or the control levers in the neutral position, slowly raise off of the seat. **The engine should stop.**
6. **If the engine fails to stop** when the deck clutch switch is up or one or both of the control levers is up and the operator is off the seat, check the function of the seat switch. If the seat switch is not operating properly (**is not opening or closing**) and if the cause can not be determined, replace the seat switch.

If the problem can not be located, contact your Hustler Dealer.



**WARNING:** The safety interlock system should always function per steps 4 and 5. If it does not function properly, it should be corrected immediately. Do not operate machine without properly functioning seat safety switch.

### Engine starting

The tractor's safety start interlock system is also designed to protect the operator and others from accidental injury due to unintentional engine starting. The engine starting motor will not engage until:

- A. Control levers are in the park brake position.
- B. Deck clutch switch is in the down (OFF) position.



**WARNING:** The safety interlock system must not be disconnected or bypassed. Doing so could cause the machine to operate unexpectedly resulting in personal injury.

**NOTE:** The operator's seat is equipped with a separate safety switch. If for any reason the operator should become unseated when the control levers are not in the park brake position (park brake switches are disengaged) or the deck clutch switch is engaged the engine will stop.

The following steps are the correct procedures for starting the engine. If difficulty is encountered, contact the Hustler Dealer in your area.

1. Before starting tractor each day, perform daily pre-operation checking. (See Safety start interlock system section)
2. Make sure the control levers are in the park brake position and deck clutch switch is disengaged. Only start the engine from the operator's position.
3. Use choke, if unit is equipped with one, when engine is cold, or if warm engine fails to start within 5 seconds of cranking. Avoid flooding and operate engine without choking as soon as possible.
4. Set throttle at approximately 1/2 open position.
5. Insert key in ignition switch and rotate full clockwise to engage starting motor. Release key when engine starts.

**IMPORTANT:** The engine starter should not be operated for periods longer than 30 seconds at a time. An interval of at least two minutes should be allowed between such cranking periods to protect the starter from overheating and burn-out.

6. Perform test to make sure safety start interlock system is operating properly. Refer to Safety start interlock system section.
7. As soon as engine begins to run, check to make certain the oil warning light, check engine light and alternator warning light (if applicable) are off. If not, stop engine immediately and check for

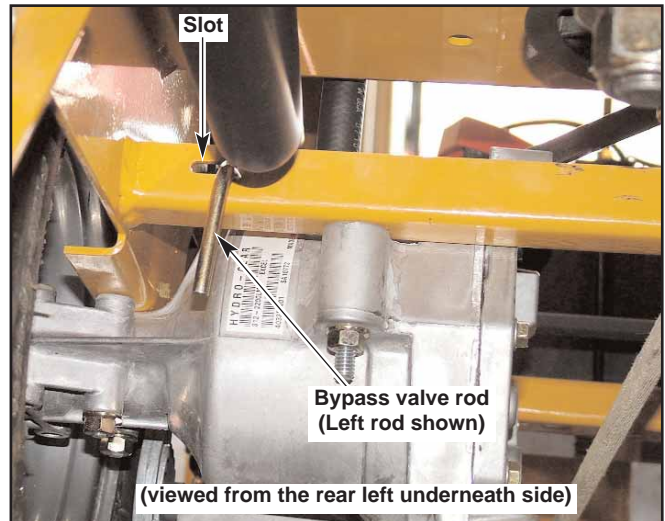

Figure 3-5A

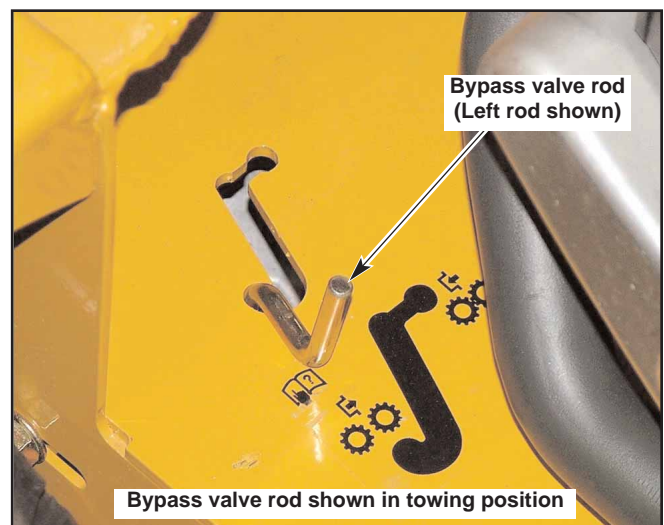

Figure 3-5B

the cause.

8. Allow the engine to idle a few minutes before advancing the throttle and/or engaging the deck clutch.

### Stopping the engine

Use the following procedure to shut off the engine after operating the equipment.

1. Place the control levers in the park brake position
2. Disengage the deck clutch
3. Throttle back to low idle for a couple of minutes
4. Rotate ignition key counter-clockwise to the OFF position. Remove the key from switch before leaving the tractor.

### Moving tractor with stalled engine

If it becomes necessary to move the tractor when the engine is inoperative, the transaxles are equipped with bypass valves.



**WARNING:** Allow engine exhaust manifold to cool before engaging or disengaging the bypass valves. The bypass valve rods are located close to the exhaust system.

**Mini Z 36/42 units produced prior to and including serial number 06120544** - Before moving the unit, pull out on the bypass valve rods and slide them into the slot to lock in position.

Both bypass valve rods are located underneath the rear of the tractor at the back of the transaxle. Fig. 3-5A

The control levers must be placed in the neutral position, to release the park brakes, so that the tractor can be moved.

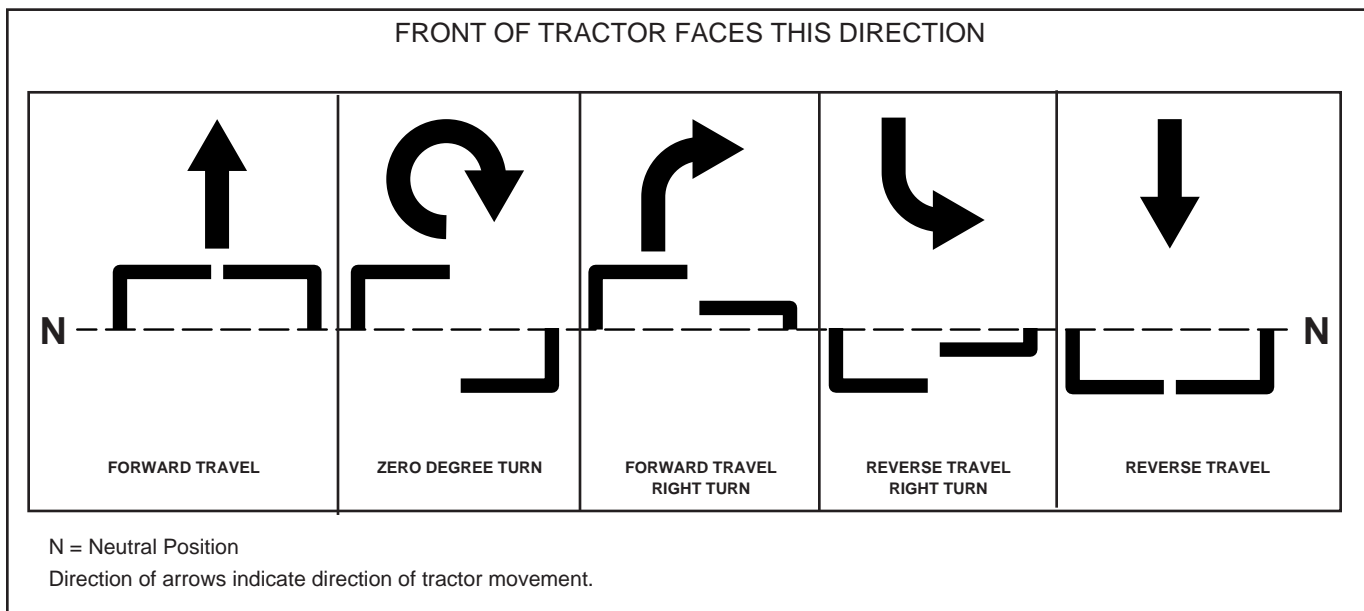

Figure 3-6

Do not tow the machine. Move it by hand or use a winch to load on a trailer for transporting.

When transporting on another vehicle, the tractor must be secured.

**IMPORTANT:** Always make certain the two bypass valves are returned to their operating position before running the tractor following repairs.

**Mini Z 36/42 and FasTrak Super Duty 36/42 units produced after serial number 06120544** - Before moving the unit, pull up on the bypass valve rod and slide it in the slot to the disengaged position.

Both bypass valve rods are located at the front corners of the engine on the engine platform. Fig. 3-5B

The steering control levers must be placed in the neutral position, to release the park brakes, so that the tractor can be moved.

Do not tow the machine. Move it by hand or use a winch to load on a trailer for transporting.

When transporting on another vehicle, the tractor must be secured.

**IMPORTANT:** Always make certain the two bypass valves are returned to their operating position before running the tractor following repairs.

### Driving the tractor



**DANGER:** Never make sudden stops or reverse direction, especially when maneuvering on a slope. The steering is designed for sensitive response. Rapid movement of the control levers in either direction could result in a reaction of the tractor that can cause serious injury.

After starting engine, engage the control levers and steer as follows:

**To go forward,** push control levers forward an equal distance (Fig. 3-6).

**To go in reverse,** pull control levers rearward an equal distance (Fig. 3-6).

**To turn left,** move the right control lever farther forward from neutral than the left control lever.(Fig. 3-6)

**To turn right,** move the left control lever farther forward from neutral than the right control lever. (Fig. 3-6)

**Zero degree turn,** move one control lever forward and the other control lever back of neutral. This will allow the drive wheels to counter-rotate. (Fig. 3-6)

**To stop or decrease speed,** move control levers to neutral. When going forward pull back gently on control levers. When going in reverse push forward gently on control levers.

**For emergency stop,** when traveling forward or rearward, place the steering control levers in the park brake position immediately.



**DANGER:** When moving in the rearward direction push forward gently on control levers and avoid sudden movement. Any sudden movement could cause the front of the mower to come off of the ground resulting in possible loss of control.

**To make a three point turn to the right,** move the left control lever farther forward from neutral than the right control lever and start the turn. Next, pull back on the control levers until they are past neutral and the machine starts to go rearward. Pull right control lever farther rearward from neutral than the left control lever until the rear of the machine has pivoted around. Then, push the control levers forward until they are both past neutral and the machine starts to go forward. Push the left control lever farther forward from neutral than the right control lever and finish the turn. (Fig. 3-8)

**IMPORTANT:** Rapid movement of control levers is not recommended as damage to the hydraulic system components may occur.

**To increase speed,** increase control lever's distance from neutral. The farther forward control levers are from neutral, the faster tractor will travel forward. The farther back control levers are from neutral, the faster tractor will go in reverse.

### Operating suggestions



**DANGER:** Prior to operating the tractor the operator should be thoroughly familiar with the proper use and operation of the equipment, should read the manual completely and thoroughly, and should have attempted slow moving



Figure 3-7



maneuvers to become familiar with the operation of the equipment before attempting normal speed operation. An inexperienced operator should not mow on slopes or on uneven terrain.



**WARNING:** If you lose steering control while operating the machine, place the steering control levers in the park brake position immediately. Inspect the machine and involve your Hustler dealer to resolve the problem before continuing to operate.



**WARNING:** The unit's steering control levers are very responsive: **Easy does it!** For smooth operation, move lever slowly, avoid sudden movement. Skill and ease of operation come with practice and experience. The machine can spin very rapidly. Use caution when making turns and slow down before making sharp turns.

Inexperienced operators may have a tendency to oversteer and lose control. Slow-moving practice maneuvers are recommended to become familiar with these characteristics before attempting normal speed operation.



**WARNING:** Sharp depressions or raised obstacles (such as gutters or curbs) should not be directly approached at high speed in an attempt to "jump" them as the operator could be thrown from the equipment. Approach at a slow speed and angle one drive wheel at the obstruction. Continue at an angle until the wheel clears and then pivot the opposite wheel around.

When turning on soft wet turf, keep both wheels rolling either forward or backward. Pivoting on one stopped wheel can damage turf. This is especially important when mowing.

Tractor performance is maximum when the throttle is set at full rpm. This gives maximum power to the drive wheels and deck when needed. Use the control levers to control ground speed rather than engine rpm.

**Keep blades sharp.** Many professional mowing companies have additional sets of blades and change blades twice a day: once in the morning and again at noon. **Many problems** with incorrect cutting patterns are due to **dull blades** or blades which have been **sharpened incorrectly**. Information on sharpening blades is listed in this manual's maintenance section. In addition, most communities have individuals or companies which specialize in sharpening mower blades. **Blade sharpness should be checked daily.**



**DANGER:** Never work with blades while engine is running or deck clutch switch is engaged (on). Always place deck clutch switch in the **disengaged** position, place control levers in the park brake position and turn engine off and disconnect negative battery cable. Block up mower when you **must** work under it. Wear gloves when handling blades. **Always check for blade damage** if mower strikes rock, branch or other foreign object during mowing!

Use **high blade speed**. Your mower is designed to operate at full throttle. The throttle setting directly controls blade speed. The highest blade speed generally gives best cut.

**Direct grass discharge to right,** away from unmown area. Select a mowing pattern that directs grass discharge towards the outside, not towards center, of mowing area. Generally, this means using a pattern utilizing **left turns** because side discharge is to **right**. In any case, avoid throwing grass discharge onto unmowed area because grass is then mowed "twice". Mowing twice puts an unnecessary load on the unit and reduces mowing efficiency.

**When mowing a lawn for the first time** cut grass slightly longer than normal to avoid scalping uneven terrain. When possible, it is best to use the cutting height that was used in the past. When cutting grass taller than six inches, you may want to mow the lawn twice to achieve a better quality of cut.

**During normal mowing cut only about 1/3 of the grass blade.**

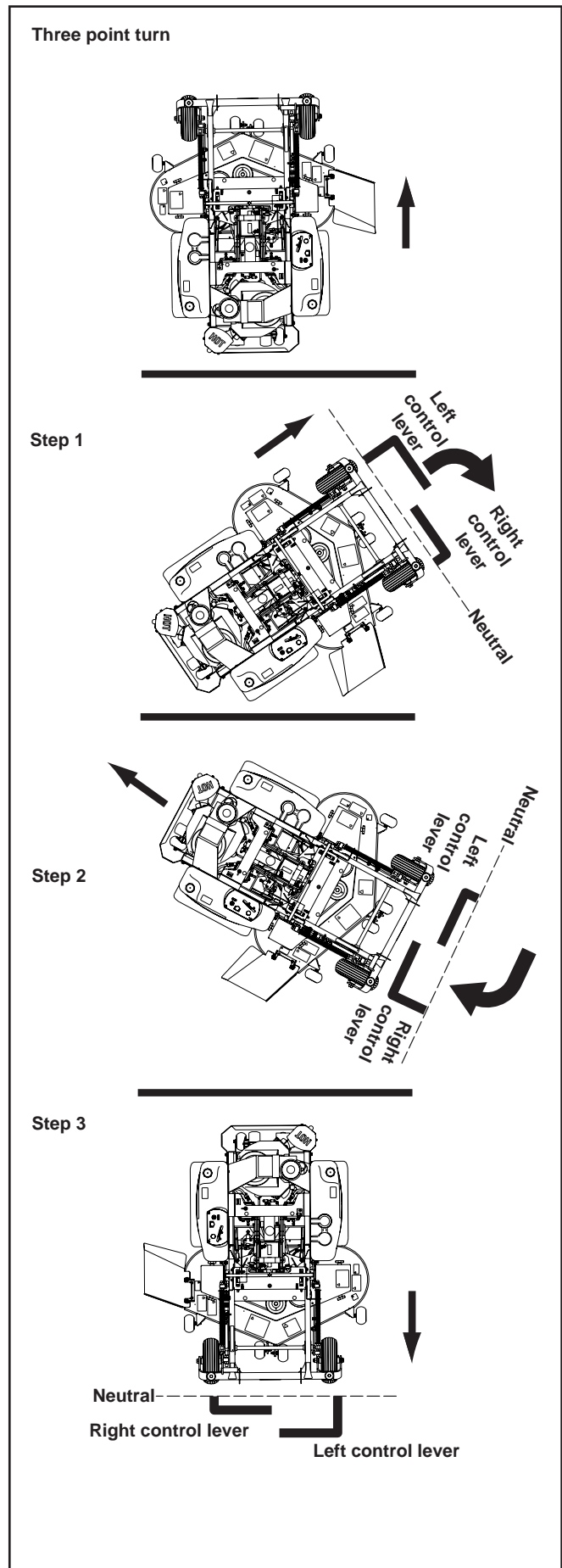

Figure 3-8

Cutting more than that is not recommended unless grass is sparse or it is the end of the mowing season.

**Alternate mowing direction** to keep the grass growing straight and better dispersion of the clippings.

**Remember, grass grows at different rates** at different time of the year. Mow more often in the early spring to maintain the same cutting height. As the growth rate slows in mid summer, mow less frequently. If you cannot mow at a regular interval, mow at a high cutting height; then mow again two days later at a lower cutting height.

**Raise the cutting height of the mower** if the cutting width of the mower is wider than the previous mower. This ensures that uneven turf is not cut too short.

**Raise the cutting height of the mower** if the grass is slightly taller than normal or if it contains a high degree of moisture. Then mow it again with the cutting height set lower.

**If the machine's forward motion** must be stopped while mowing, a clump of grass clippings may drop onto your lawn. To avoid this, move onto a previously cut area with the blades engaged.



**WARNING:** Never direct discharge of material from mower deck towards bystanders. Do not operate the mower without either the discharge chute or the entire grass collection system in place. Fig. 3-7

### Mower deck operation



**DANGER:** Never attempt to make any adjustments to the mower deck while the engine is running or with the deck drive clutch engaged. Mower blades cannot be seen and are located very close to deck housing. Fingers and toes can be cut off instantly.

With the engine running, engage the deck clutch switch (Fig. 3-1) and advance engine throttle to full rpm.

**NOTE:** Engaging the deck clutch at high engine rpm or when under heavy load (in tall grass for example) can cause belts and/or electric clutch to slip, resulting in premature wear or possible damage.

### Deck cutting height adjustment

Deck height is adjustable from 1" - 5" (2.54 CM - 12.7 CM) in 1/4" (.64 CM) increments. The holes in the height adjusting bar are spaced at 1/2" (1.27 CM) intervals. By turning the height adjusting stop around, 1/4" (.64 CM) increments can be attained due to the 1/4" (.64 CM) plate that is part of the stop. Fig. 3-9

**EXAMPLE:** When the height adjusting stop is placed in the 1" (2.54 CM) hole, **with the 1/4" (.64 CM) plate facing to the front of the unit**, the cutting height is at 1" (2.54 CM). When the height adjusting stop is placed in the 1" (2.54 CM) hole, **with the 1/4" (.64 CM) plate on the operator's side of the hole**, the cutting height is at 1-1/4" (3.18 CM).

**The notch located at the rear** of the height adjusting bar is to be used when the deck is placed in the **transport mode**.

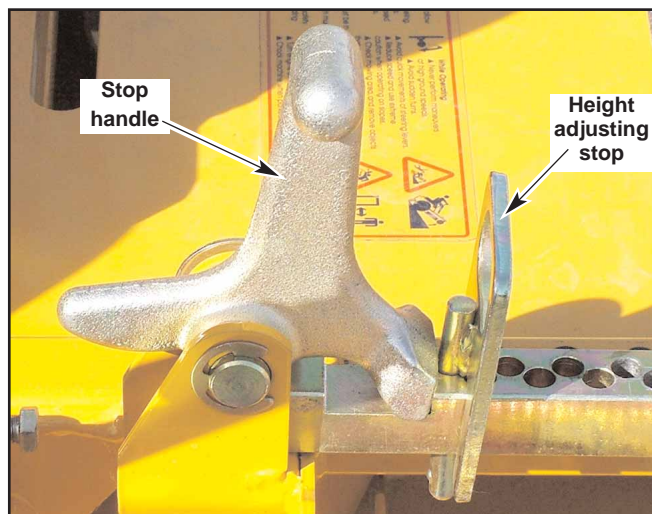

Figure 3-9

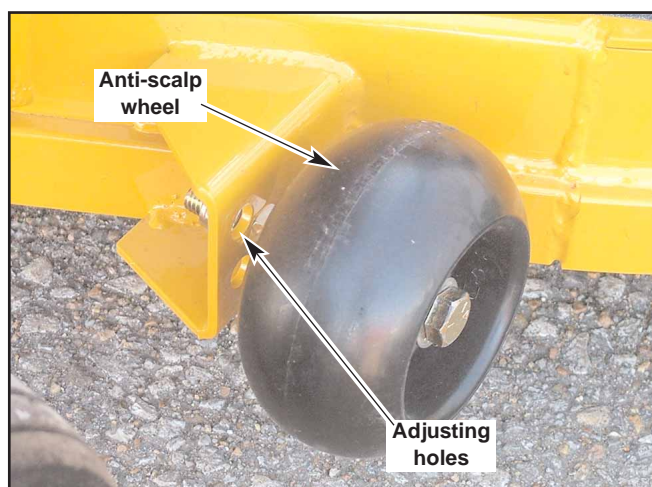

Figure 3-10

### Anti-scalp wheels

Anti-scalp wheel kits are standard on Hustler Mini Z 36/42 and FasTrak Super Duty 36/42 units. These anti-scalp wheels are designed to minimize scalping when mowing on rough uneven terrain.

After setting the cutting height, adjust the anti-scalp wheels so they extend below the deck but **do not contact the ground**. They should always be at least 1/4" to 3/4" (6.35MM to 19.05MM) below the deck. With the unit sitting on a flat level surface, the wheel position can be adjusted up or down as needed from 3/4" to 1-3/4" (19.05MM to 44.45MM) below the blade surface. Move the wheels up or down, in 1/2" (12.70MM) increments, using the different axle mount holes in the wheel mount bracket. Fig. 3-10

When adjusting the rear anti-scalp wheels, the wheel should be in the same axle mount hole as the front anti-scalp wheels.



# MAINTENANCE & ADJUSTMENTS

## Safe Servicing Practices

This product is capable of amputating hands and feet and throwing objects. Always follow all safety instructions to avoid serious injury or death.

## Service

- ▲ Unless specifically required, **DO NOT** have engine running when servicing or making adjustments to tractor. Park the machine on level ground. Place steering control levers in the park brake position, disengage deck clutch, lower deck, remove ignition switch key and disconnect negative battery cable before doing any maintenance. Wait for all movement to stop before adjusting, cleaning or repairing. Repairs or maintenance requiring engine power should be performed by trained maintenance personnel only. To prevent carbon monoxide poisoning, be sure proper ventilation is available when engine must be operated in an enclosed area. Read and observe safety warnings in front of manual.
- ▲ Before working on or under the deck, make certain engine cannot be accidentally started. Shut engine off and remove ignition switch key for maximum safety. Repairs or maintenance requiring engine power should be performed by trained maintenance personnel only.
- ▲ Except when changing or checking belt, **always** keep belt covers on mower deck for safety as well as cleanliness.
- ▲ Use a stick or similar instrument to clean under the mower making sure that no part of the body, especially arms and hands are under mower.
- ▲ Keep your machine clean and remove any deposits of trash and clippings, which can cause engine fires and hydraulic overheating as well as excessive belt wear. Clean up oil or fuel spillage. Allow machine to cool before storing.
- ▲ **Clean flammable material from machine. Prevent fires by keeping engine compartment, top of deck, battery, exhaust area, fuel line, fuel tank and operator's station clean of accumulated trash, grass clippings, and other debris. Always clean up spilled fuel and oil.**
- ▲ Always wear adequate eye protection when servicing the hydraulic system and battery, or when grinding mower blades and removing accumulated debris.
- ▲ Use extra caution when handling gasoline and other fuels. They are flammable and vapors are explosive.
- ▲ Never attempt to start engine when there is a strong odor of gasoline fumes present. Locate and correct cause.
- ▲ Never remove the fuel cap or refuel tractor while engine is running; never refuel near an open flame or near devices which can create a spark. Refuel outdoors. Never refuel or drain the fuel from the machine indoors.
- ▲ Never run the engine in an enclosed area unless exhaust is vented to the outside. Exhaust gases contain carbon monoxide which is odorless and deadly poison.
- ▲ Never attempt to make any adjustments or repairs to the tractor drive system, mower deck or any attachment while the tractor engine is running or deck clutch is engaged. Repairs or maintenance requiring engine power should be performed by trained maintenance personnel only.
- ▲ Never work under the machine or attachment unless it is safely supported with jack stands. Make certain machine is secure when it is raised and placed on the jack stands. The jack stands should not allow the machine to move when the engine is running and the drive wheels are rotating. **Use only certified jack stands.** Use only appropriate jack stands, with a minimum weight rating of 2000 pounds to block the unit up. Use in pairs only. Follow the instructions supplied with the vehicle stands.
- ▲ Do not touch hot parts of machine.
- ▲ Keep nuts and bolts tight, especially the blade attachment bolts. Keep equipment in good working condition.
- ▲ Never tamper with safety devices. Check their proper operation regularly.
- ▲ Stop the engine before removing the grass catcher or unclogging the

discharge chute. Never clear the discharge chute with the engine running. Turn off the engine and be sure the blades have stopped before cleaning. Use a stick to clear a plugged discharge area.

### Never use your hand!

- ▲ Grass collection system components are subject to wear, damage and deterioration, which could expose moving parts or allow objects to be thrown. Frequently check components and replace with manufacturer's recommended parts, when necessary.
- ▲ Exercise caution when working under the deck as the mower blades are extremely sharp. Wrap the blade(s) or wear gloves and use extra caution when servicing them.
- ▲ Use only genuine Hustler replacement parts to ensure that original standards are maintained

## Introduction

Regular maintenance is the best prevention for costly downtime or expensive, premature repair. The following pages contain suggested maintenance information and schedules which the operator should follow on a routine basis. The following pages contain suggested maintenance information and schedules which the operator should follow on a routine basis. For more detailed information order the correct parts manual for your unit. Refer to the Product Literature section of this manual.

Remain alert for unusual noises, they could be signaling a problem. Visually inspect the machine for any abnormal wear or damage. A good time to detect potential problems is while performing scheduled maintenance service. Correcting the problem as quickly as possible is the best insurance.

Clear away heavy build-up of grease, oil and dirt, especially in the engine and under the seat platform areas; minute dust particle are abrasive to close-tolerance engine and hydraulic assemblies.

**Daily inspect** mower for grass clippings and wire and string tangles. The underside of the mower deck will collect a build-up of grass clippings and dirt, especially when grass is wet or has high moisture content. This build-up will harden, restricting blade and air movement and will probably show a poorer quality of cutting. Therefore it should be removed routinely.

To do this it will be necessary to raise and block the deck, using jack stands or blocks, in the full up position and scrape the build-up from underneath.

Some repairs require the assistance of a trained service mechanic and should not be attempted by unskilled personnel. Consult your Hustler service center when assistance is needed.

## Torque values



**WARNING:** Particular attention must be given to tightening the drive wheel lug nuts and blade spindle bolts. Failure to correctly torque these items may result in the loss of a wheel or blade, which can cause serious damage or personal injury.

Torque values are given below:

	Ft-lbs.	Nm
Wheel (lug) nuts . . . . .	.65-75	.88.14-101.7
Blade spindle bolt top . . . . .	.118	.160.01
Blade spindle bolt bottom . . . . .	.118	.160.01

**Lug nuts only** - It is recommended that these be checked after the first 2 hours of operation, initially, every 50 hours and following removal for repair or replacement.

For all other torques refer to the various tractor parts manuals for standard torque chart. See page 21 for ordering information.

For engine torque values, see engine owner's manual.

## Tires

It is important for level mowing that the tires have the same amount of air pressure. The recommended pressure are:

Drive wheels.....	8-12 psi (55-83 KPa)
Gauge wheels .....	8-12 psi (55-83 KPa)

**Solid fill tires are not recommended** for Hustler turf equipment. On any machine, with solid filled tires, the warranty claim will be denied.

## Lubrication

Use SAE multi-purpose grease.

## Electrical system

The electrical system is a 12-volt, negative ground. Recommended battery size is a garden tractor BCI group U1R with 225 or better cranking AMP rating. A maintenance-free battery is recommended. Otherwise, follow battery manufacturer's maintenance, safety, storing and charging specifications.



**WARNING:** Battery posts, terminals, and related accessories contain lead and lead compounds, chemicals known to the State of California to cause cancer and reproductive harm. Wash hands after handling.



**WARNING:** Charge batteries in an open well ventilated area, away from sparks and flames. Unplug charger before connecting or disconnecting from battery. Wear protective clothing and use insulated tools.



**WARNING:** Avoid skin and clothing contact with battery acid.

Always wear eye protection when checking the battery, acid can cause serious injury to skin and eyes. If contact occurs, flush area with clean water and call physician immediately. Acid will also damage clothing.

Do not drink the battery electrolyte.

Do not allow open flame near the battery when charging.

Hydrogen gas forms inside the battery. This gas is both toxic and flammable and may cause an explosion if exposed to flame. Always remove the negative ground first and replace it last.

Do not overfill battery.

Electrolyte may overflow and damage paint, wiring or structure. When cleaning the battery, use soap and water. Be careful not to get soap and water into the battery. Clean the battery terminals with a solution of four parts water and one part baking soda when they become corroded.



**WARNING:** Shorts caused by battery terminals or metal tools touching metal tractor components can cause sparks. Sparks can cause a battery gas explosion which will result in personal injury.

Prevent the battery terminals from touching any metal tractor parts when removing or installing the battery.

Do not allow metal tools to short between the battery terminals and metal tractor parts.



**WARNING:** Incorrect battery cable routing could cause damage to the tractor and battery cables. This can cause sparks which can cause a battery gas explosion which will result in personal injury.

Always **disconnect** the negative (black) battery cable(s) before disconnecting the positive (red) cable(s).

Always **connect** the positive (red) battery cable(s) before disconnecting the negative (black) cable(s).

## Hydraulic system

These units are equipped with two Hydro-Gear ZT 2800 transaxles. Fig. 4-1

**IMPORTANT:** Never use hydraulic or automatic transmission fluid in this system; use only motor oil as specified. Remember, dirt is the primary enemy of any hydraulic system.

The hydraulic expansion tank is located in front of the engine and under the operator's platform. Fig. 4-2

Check oil level in hydraulic system after every 50 hours of operation or weekly, whichever occurs first. Check more often if system appears to be leaking or otherwise malfunctioning.



Figure 4-1



Figure 4-2

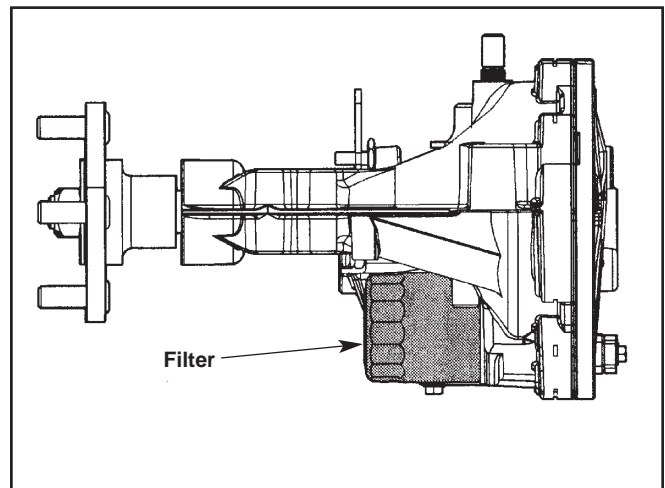

Figure 4-3

Fluid level should be at the "Full Cold" line on the expansion tank. Use only SAE 20W50 SL/SM service motor oil.

Initial system oil and filter change must be after the first 75 hours of use or 1 year whichever comes first. Thereafter, replace filter and oil in each transaxle every 2 years or 200 hours, whichever comes first. **NOTE:** The filter guard must be removed to access filter.

Each transaxle's filter is located per Fig. 4-3. A standard oil filter wrench is used to change filter, threads are right handed. Use a **Hustler**

approved filter element only.

**IMPORTANT:** Purging procedure must be followed after changing the oil and filter. Refer to Parts Manual (Hustler P/N 107652 or 108737) for more detailed oil changing and purging information.



**WARNING:** When washing the mower, direct the spray away (especially if using a power washer) from the Hydro-Gear ZT 2800 transaxle's seals to prevent water intrusion and to ensure component performance.

## Fuel system



**DANGER:** Observe usual fuel handling precautions: Do not smoke while refueling. Extinguish all cigarettes, cigars, pipes and other sources of ignition.

Do not remove fuel cap or fill tank with engine running or while engine is hot. Clean up any gasoline spills.

Allow engine to cool before storing machine inside a building.

Keep fuel away from open flame or spark and store machine away from open flame or spark or pilot light such as on a water heater or appliances.

Use extreme care when handling gasoline and other fuels. They are extremely flammable and vapors are explosive. A fire or explosion from gasoline can burn you and others and can damage property.

Never refuel or drain the fuel from the machine indoors.

Never attempt to start engine when there is a strong odor of gasoline fumes present. Locate and correct cause.

Store gasoline in an approved container and keep it out of the reach of children. Never buy more than a 30 day supply of gasoline.

Always place gasoline containers on the ground away from your vehicle before filling.

Do not fill gasoline containers inside a vehicle or on a truck or trailer bed with interior carpets or plastic truck bed liners. Always place gasoline containers on the ground away from your vehicle before filling.

When practical, remove gas-powered equipment from the truck or trailer and refuel the equipment with its wheels on the ground. If this is not possible, then refuel such equipment on the truck or trailer using a portable container and not a gasoline dispenser nozzle. If a gasoline dispenser nozzle must be used, keep the nozzle in contact with the rim of the fuel tank or container opening at all times until fueling is complete. Do not use a nozzle lock-open device.

Read and observe safety precautions elsewhere in this manual.



**WARNING:** Gasoline is harmful or fatal if swallowed.

Long-term exposure to vapors can cause serious injury and illness.

Avoid prolonged breathing of vapors.

Keep face away from nozzle and gas tank or fuel container opening.

Keep gas away from eyes and skin.

If fuel is spilled on clothing, change clothing immediately.

The fuel tanks are located in the tractor's fenders.

Use regular unleaded gasoline with an octane rating of 87 or higher.

**IMPORTANT:** Never use methanol, gasoline containing methanol, or gasohol containing more than 10% ethanol because the fuel system could be damaged. Do not mix oil with gasoline.

A **fuel shut-off valve** is located on each tractor. The location and operation of the fuel valve will vary depending upon the unit. Close the fuel valve to prevent fuel flow to the engine. The valve's two other positions will allow fuel to be drawn from either one or the other fuel tank. 4-4

**IMPORTANT:** Do not overfill the fuel tanks. The fuel tanks should be filled no higher than 2" (5.08 cm) below the tank's fill neck.

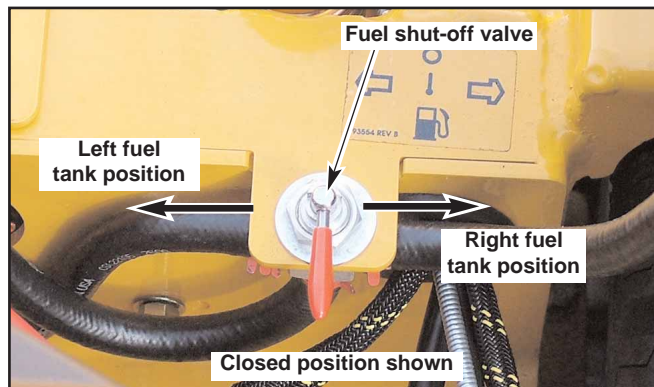

Figure 4-4

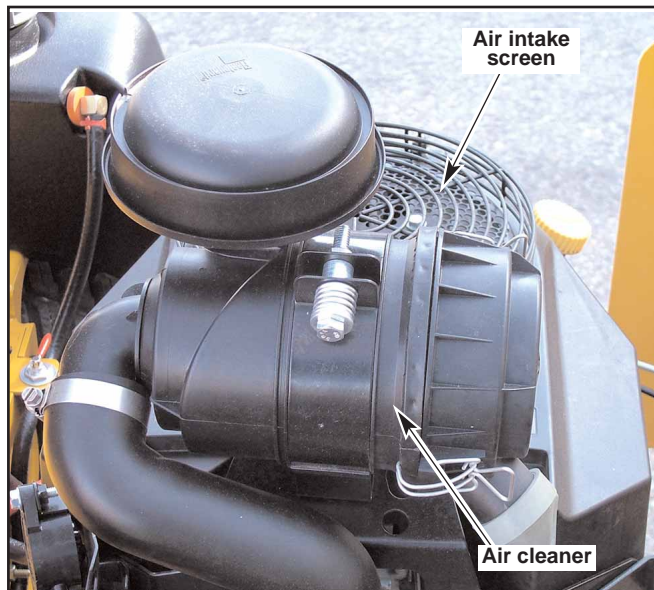

Figure 4-5

## Engine oil and filter

Check engine oil daily and after every 4 hours of operation. Tractor must be setting level when checking oil. Refer to engine manual and maintenance schedule for oil recommendation and capacities.

Change the engine oil and filter after the first 5 hours of operation, per the engine manufacturer's recommendations after that. If tractor is being operated in extremely dirty conditions, then it is recommended oil be changed more frequently.

## Engine air filter

Perform engine air filter maintenance per the Service Interval chart shown elsewhere in this manual.

A specially designed dry filter is standard equipment on these tractors and supplies clean combustion air to the engine. Fig. 4-5

## Recommended service procedure

1. Release clamps and remove element. Clean the canister with a damp cloth.
2. Before installing a new element, inspect it by placing a bright light inside and rotate the element slowly, looking for any holes or tears in the paper. Also check gaskets for cuts or tears. Do not attempt to use a damaged element which will allow abrasive particles to enter the engine.
3. Reinstall the dust cup. Make sure it seals all the way around the air cleaner body, then tighten the clamps.
4. Check all fittings and clamps periodically for tightness and inspect hoses for holes or cracks.
5. Periodically check the intake hose for signs of ingested dust. Locate and repair the source of ingested dirt.
6. Never operate a machine without an air filter installed.

## Overservicing

Overservicing occurs when an air filter element is removed for cleaning or replacement before it is necessary. Each time the filter is removed a small amount of dirt and dust could fall in the intake system. This accumulated dirt can cause a dusted engine. It only takes a few grams of ingested dirt over the normal service life of an engine to cause a dusted engine.

**Do not clean element, replace with a new element only.** Cleaning used air filter elements, through improper cleaning procedures, can get dust on the inside of the filter causing dirt ingestion and engine failure.

It is important to note that whenever an air filter element is cleaned by **any method**, the person or company performing the cleaning assumes responsibility for the integrity of the filter from then on. **The warranty for air filters expires upon cleaning or servicing in any manner because the condition of the filter after servicing is completely out of their control. Therefore, on a dust ingested engine failure, there will be no warranty consideration if the air filter element has been cleaned or serviced in any manner.**

A partially dirty air filter element works better than a new element. Therefore, a dirty filter element is not bad for the engine unless it is excessively restricting the air flow and engine performance is affected. The reason is simple. The media in the filter must be porous to allow air to pass through it. When dirty air passes through the filter, the dirt plugs some of the holes in the media and actually acts as part of the filter media. When the next round of dirt enters, the first dirt helps filter out even smaller particles making the filter more efficient at stopping dirt from entering the engine. This is referred to as barrier filtration.

Of course, at some point the filter media becomes too clogged to allow air to pass.

The mowing conditions will determine the frequency of air filter element changing.

## General engine maintenance

Detailed instructions and recommendations for break-in and regular maintenance are specified in the Engine Owner's manual. Please refer to this manual for engine servicing, lubricating oil levels with quality and viscosity recommendations, bolt torques, etc. The engine warranty is backed by the manufacturer. Special attention should be paid to applicable data which will not be duplicated here.

## Belts

Inspect belts frequently for wear and serviceability. Replace a belt that shows signs of severe cuts, tears, separation, weather checking and cracking, or burns caused by slipping. Slight raveling of belt covering does not indicate failure, trim ravelings with a sharp knife.



**WARNING:** If the pump belt fails, loss of control will occur especially when operating on a slope. **If you lose steering control while operating the machine, place the steering control levers in the park brake position immediately. Inspect the machine and involve your Hustler dealer to resolve the problem before continuing to operate.**

Inspect the belt pulley grooves and flanges for wear. A new belt, or one in good condition, should never run against the bottom of the groove. Replace the pulley when this is the case, otherwise belt will lose power and slip excessively.

Never pry a belt to get it on a pulley as this will cut or damage the fibers of the belt covering.

Keep oil and grease away from belts, and never use belt dressings. Any of these will destroy the belt composition in a very short time.

## Mower blade maintenance

Check the mower blades daily, they are the key to power efficiency and well groomed turf. Keep them sharp, a dull blade will tear rather than cut the grass, leaving a brown ragged top on the grass within a few hours. A dull blade also requires more power from the engine.

Replace any blade which is bent, cracked or broken.

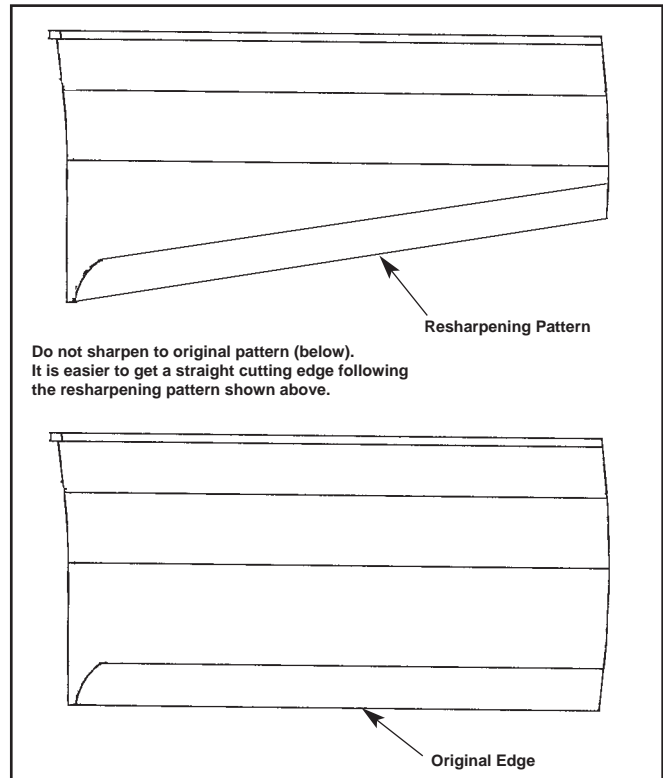

Figure 4-6

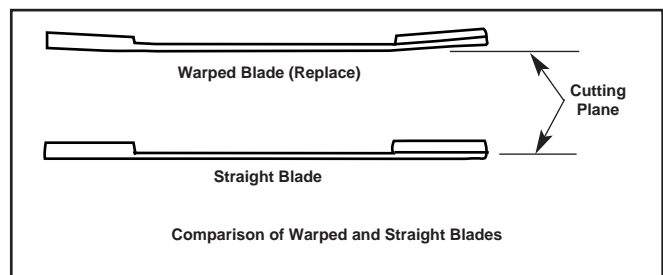

Figure 4-7

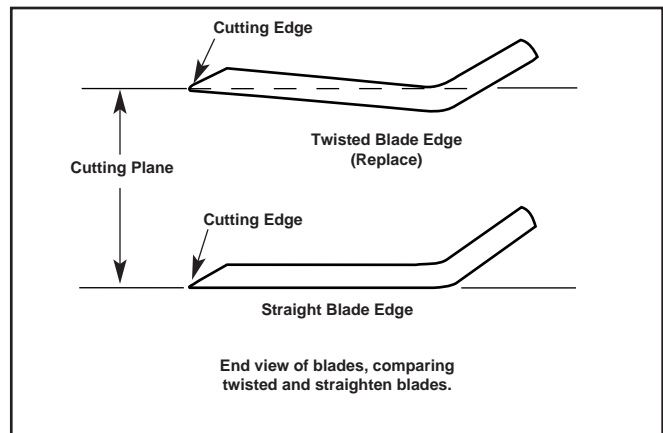

Figure 4-8



**WARNING:** Never attempt to straighten a bent blade by heating, or weld a cracked or broken blade as the blade may break and cause serious injury. Replace worn or damaged blades.



**DANGER:** Never work with blades while engine is running or deck clutch switch is engaged (on). Always place deck clutch switch in the **disengaged** position, place control levers in the park brake position and turn engine off and disconnect

negative battery cable. Block up mower when you **must** work under it. Wear gloves when handling blades. **Always check for blade damage** if mower strikes rock, branch or other foreign object during mowing!



**WARNING:** Always wear adequate eye protection when grinding mower blades.

Always place deck clutch switch in the **disengaged position**, place control levers in the park brake position and turn engine off and disconnect negative battery cable. Block up mower when you **must** work under it. Wear gloves when handling blades. **Always check for blade damage** if mower strikes rock, branch or other foreign object during mowing!

### Mower blade removal

Use a 15/16" wrench to remove the 5/8" cap screw holding the blade to the spindle shaft from underneath. **NOTE:** A blade holding tool (part number 381442) is available from Hustler Turf Equipment. It is designed to prevent the blades from rotating when they are being removed or installed on the spindle. Contact your Hustler dealer for more information.

Sharpen the blades on a grinder following pattern as shown (Fig. 4-6). Touch-up sharpening can be done with a file.

Check the blades for balance following grinding. A commercial balancing tool is available through most hardware supply stores, or balancing can be done by placing the blade on an inverted line punch or 5/8" bolt. Blade should not lean or tilt. Spin the blade slowly, blade should not wobble. If blade is out of balance, true it up before reinstalling.

Lay the blade on a flat surface and check for distortion (Fig. 4-7 and 4-8). Replace any distorted blade.

Do not re-use spindle bolts which have stripped, worn or undercut threads. Torque bolts on spindles to 118 foot-pounds (160.01Nm) when reinstalling blades.

**IMPORTANT:** The blade sail (curved part) must be pointing upward toward the inside of the deck to ensure proper cutting.



**WARNING:** When mounting blades, rotate them after installation to ensure blade tips do not touch each other or sides of the mower.



**WARNING:** Failure to correctly torque the bolt may result in the loss of the blade which can cause serious injury.



**WARNING:** Mower blades are sharp and can cut. Wrap the blade(s) or wear gloves and use extra caution when servicing them.

### Seat adjustment

The seat can be adjusted forward and rearward by removing the locknut that locks the seat platform in place and pivoting the seat platform up and forward. Then loosen the four cap screws on the underneath side of the operator's platform. Position the seat where you have the best control of the machine and are the most comfortable and then tighten the cap screws. Fig. 4-9

### Control lever adjustment

The steering control levers can be adjusted for operator comfort. By loosening the cap screws that attaches the upper control lever to the lower lever (Fig. 4-10), the upper control lever can be pivoted to fit the operator's personal preference.

The steering control levers can also be adjusted up and down. Remove the cap screws and slide the upper control lever up or down and align the holes in it with the holes in lower lever. Re-install the cap screws and tighten.

The steering control levers should be adjusted so that they align with each other when in the neutral position.

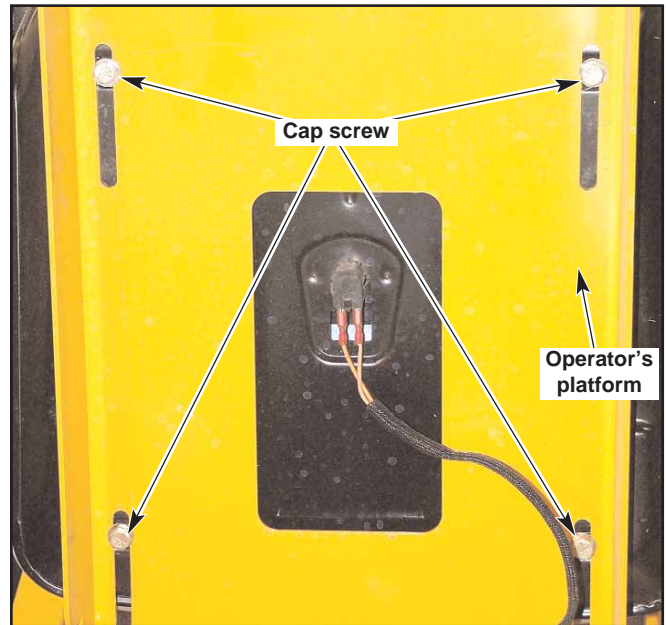

Figure 4-9

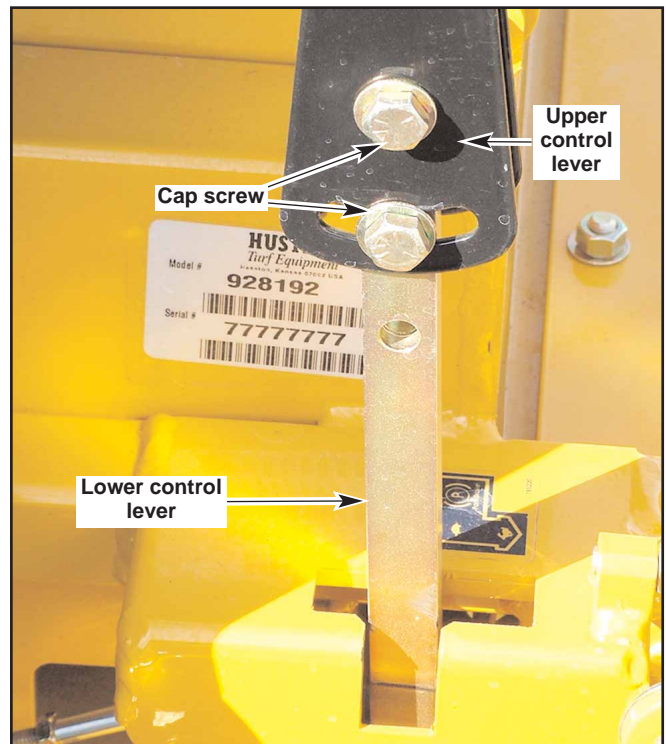

Figure 4-10



## Hustler Mini Z 36/42 & FasTrak Super Duty 36/42 Maintenance Schedule

Refer to Fig. 4-11

SERVICE AT INTERVALS INDICATED	WEEKLY OR 50 HOURS	MONTHLY OR 100 HOURS	ANNUALLY OR 500 HOURS
Verify safety start interlock system	Daily		
Visually inspect unit for loose hardware and/or damaged parts	Daily		
Visually inspect tires	Daily		
Check oil level, engine (1)	Daily or every 4 hrs.		
Clean air intake screen (4)	Daily or every 4 hrs.		
Check fuel level	Daily		
Blades - sharpen & securely fastened	Daily		
Discharge chute - securely in place & in lowest position	Daily		
Clean engine and transaxle compartment	Daily		
Replace air cleaner paper element (5)	As needed		
Change transaxle oil & filter	Every 200 hours or 2 years		
Grease deck height pivots	x		
Grease gauge wheel bearings	x		
Change engine oil & filter (1) (3)	x		
Clean cylinder and head fins (a)	x		
Check battery connections	x		
Check tire pressure with a gauge	x		
Check hydraulic oil level	x		
Clean engine exterior (a)	x		
Clean and regap spark plugs (a)		x	
Check pump and deck belt tension & condition (5)		x	
Check fuel and hydraulic lines (6)		x	
Check fuel valve and grommet (6)		x	
Tighten lug nuts on wheels (2)		x	
Change fuel filter			x
Change hydraulic filter and oil (3)			x
Replace spark plugs			x

### NOTES:

1. Initial oil change is after 5 hours of operation. Thereafter, change oil after every 40 hours operation. Change more often under dusty or dirty conditions and during hot weather periods.
2. Torque initially and after first 2 hours of operation.
3. Change engine oil filter per the engine manufacturer's recommendations. Refer to Engine Owner's Manual for recommendations and other maintenance items.
4. Service more often under dusty or dirty conditions. Use caution when servicing to prevent dust contamination in the engine. **Do not** clean filter element. Replace with a new one.
5. **Pump drive belt only - Inspect every 100 hours** and replace if worn or cracking is noticed. Otherwise, **replace every 400 hours or 2 years** whichever comes first.
6. Check fuel line hoses, fuel valve and grommets for any cracks or leaks
7. Initial system oil and filter change must be after the first 75 hours of use or 1 year whichever comes first. Thereafter, replace filter and oil in each transaxle every 2 years or 200 hours, whichever comes first.

### REFERENCES:

**a** — Refer to Engine Owner's Manual

**NOTE:** After completing maintenance cycle (500 hours), repeat cycle.

**Hustler Mini Z 36/42 & FasTrak Super Duty 36/42  
Maintenance Locator Chart**

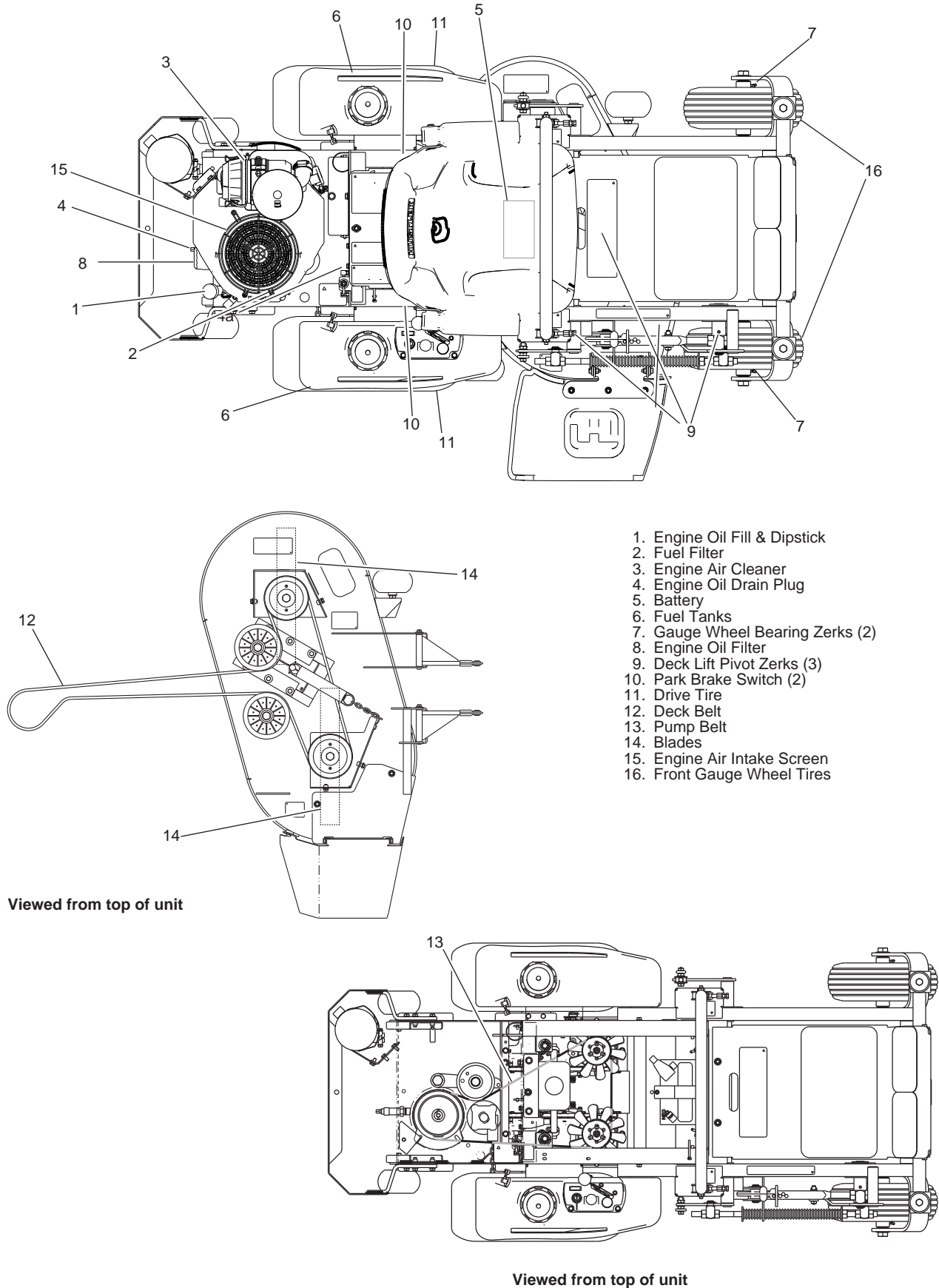

Figure 4-11



# Hustler Mini Z 36/42 & FasTrak Super Duty 36/42

## TROUBLESHOOTING

The majority of operating problems that occur with a system can be traced to improper adjustments or delayed service. A consistently applied preventative maintenance program, as outlined in the maintenance section of this manual, will prevent many problems. The following chart is designed to help you locate a problem by suggesting probable causes and the recommended solutions.

SYMPTOMS	PROBABLE CAUSES	SUGGESTED REMEDIES
<b>Starting motor does not crank</b>	Control handles not in park brake position or switch not adjusted	Place control handles in park brake position or re-adjust switch
	Deck clutch switch engaged	Disengage clutch switch
	Weak or dead battery	Recharge or replace
	Electrical connections are corroded or loose	Check the electrical connections
	20 amp fuse is blown	Replace the 20 amp fuse
	For additional causes	See engine manual
<b>The engine will not start, starts hard, or fails to keep running</b>	No fuel or line plugged	Fill tank or replace line
	Fuel valve is turned off	Open the fuel valve
	There is incorrect fuel in the fuel system	Drain the tank and replace the fuel with the proper type
	There is dirt in the fuel filter	Replace the fuel filter
	Dirt, water, or stale fuel in the fuel system	Contact your Hustler Dealer
	The choke is not on	Move the choke lever to On
	Numerous	See engine manual
<b>Engine: Runs with continuous misfiring or engine runs unevenly or erratically</b>	Numerous	See engine manual
<b>Loss of power or system will not operate in either direction</b>	Restrictions in air cleaner	Service air cleaner
	Poor compression	See your dealer
	Steering linkage needs adjustment	Adjust linkage
	Tow valve open	Close the tow valve
	The traction drive belt is worn, loose or broken	Install a new traction drive belt
	The traction drive belt is off the pulley	Install the traction drive belt and check for a reason
	For additional causes	See engine manual
<b>Overheating</b>	Air intake screen or cleaning fins clogged	Clean screen and fin
	For additional causes	See engine manual
<b>Low engine oil pressure</b>	Low oil level	Add oil
	Oil diluted or too light	Change oil and check for source of contamination
<b>High oil consumption</b>	Numerous	See your dealer
<b>Tractor jerky when starting or operates in one direction only</b>	Steering control linkage needs adjustment	Adjust linkage
	ZT 2800 component faulty	See your dealer
<b>Tractor creeps when steering control levers are in neutral</b>	Steering linkage needs adjustment	Adjust linkage
<b>Tractor circles or veers in one direction</b>	Steering linkage needs adjustment	Adjust linkage
	ZT2800 transaxle faulty	See your dealer
	Tires improperly inflated	Adjust tire pressure to 8 - 10 psi

SYMPTOMS	PROBABLE CAUSES	SUGGESTED REMEDIES
<b>There is abnormal vibration</b>	The engine mounting bolts are loose	Tighten the engine mounting bolts
	The engine pulley, idler pulley or blade pulley is loose	Tighten the appropriate pulley
	The engine pulley is damaged	Contact your Hustler Dealer
	The cutting blade(s) is/are bent or unbalanced	Install new cutting blade(s)
	A blade mounting bolt is loose	Tighten the blade mounting bolt
	Spindle bearing is worn or loose	Replace or tighten spindle bearing
	A blade spindle is bent	Contact your Hustler Dealer
<b>Uneven cutting height</b>	The blade(s) are not sharp	Sharpen the blades
	A cutting blade(s) is/are bent	Install new cutting blade(s)
	The deck is not level	Level the deck per the Deck leveling & height adjusting section of this manual
	An anti-scalp wheel is not set correctly	Adjust the height of the anti-scalp wheel
	The underside of the deck is dirty	Clean the underside of the deck
	Tire pressure is incorrect	Adjust the tire pressure to 8 - 10 psi
<b>Blades do not rotate</b>	A blade spindle is bent	Contact your Hustler Dealer
	The deck drive belt is worn, loose or broken	Install a new deck drive belt
	The deck drive belt is off the pulley	Install the deck drive belt and check for a reason
<b>Blades do not rotate</b>	Electric clutch is not engaging	Check and/or replace 10 amp fuse. Contact your Hustler dealer



# STORAGE

When storing the unit at the the end of the mowing season, the following steps should be taken to ensure readiness for the next mowing season.

1. Remove all grass, dirt, and trash from tractor and mower. Clean tractor and mower and touch up all scrapes with Hustler spray paint. **IMPORTANT:** Wash the machine with a mild detergent and water. Do not pressure wash the machine. Avoid excessive use of water, especially near the control panel, engine and the transaxle units.
2. Install new air filter per Engine Owner's Manual.
3. Check thoroughly for any worn or damaged parts that need replacing and order them from your dealer.
4. Thoroughly lubricate machine, according to lubrication instructions.
5. Check hydraulic oil level. Add oil if necessary. Change oil and filter if not done in last 200 hours.
6. Block tractor up so weight is off tires. **NOTE:** Do not deflate tires.
7. Remove the battery from machine
  - A. Clean battery
  - B. Check the electrolyte level
  - C. Charge the battery, if necessary
  - D. Store battery in a cool, dry place (do not expose to freezing temperatures)
  - E. Always keep the battery fully charged. (Especially important to prevent battery damage when the temperature is below 32°F.)
8. Perform separate engine preparation as listed below.
9. Store tractor in a clean, dry place.

## Preparation of engine for storage

When engine is to be unused for long periods, proceed as follows:

1. Run engine for a minimum of 15 minutes.
2. Drain oil from crankcase while engine is still warm.
3. Refill with fresh oil of proper viscosity.

4. Drain fuel tank and run the engine until it stops from lack of fuel. Gasoline evaporates if left in carburetor for long periods, forming gum and varnish deposits in carburetor. These deposits will cause engine flooding and loss of power.
5. Remove and replace fuel filter per maintenance schedule.
6. Remove spark plugs and pour a tablespoon of engine oil into each spark plug hole. Install plugs, but do not reconnect plug leads.
7. Crank engine with starter at least a dozen revolutions to distribute oil over cylinder walls and valve mechanism.
8. Clean exterior surface of engine. Spread a light film of oil over any exposed metal surfaces of engine that are subject to corrosion.
9. Clean dirt and chaff from cylinders and fins, blower housing and muffler.
10. Check oil filler cap and fuel tank cap to make certain they are securely in place.
11. Refer to engine manual for more information.

## New season preparation

Before starting the tractor following post season storage, the following servicing is required:

1. Clean tractor, removing trash and dirt accumulation.
2. Check engine oil level.
3. Fill fuel tank with fresh gasoline. Run machine at half speed for 5 minutes, checking operation of steering control lever. Stop engine and check for oil leaks, loose fittings and so forth.
4. Tighten any bolts that have loosened and make sure all hair pins, cotter pins and clevis pins are in place.
5. Install all safety shields and review safety precautions listed in this manual.
6. Check and inflate tires to 8-10 psi.
7. Refer to engine manual for more information.

# PRODUCT LITERATURE

This section contains sources of additional literature concerning your tractor. Literature should be ordered from your Hustler dealer or direct from indicated source.

## Parts Manuals

If you would like to order a Parts Manual for a particular tractor, the Hustler part number for that manual is listed in the following chart. Please contact your Hustler dealer to order the manual.

Model	Model Number	Parts Manual P/N	List Price
Hustler Mini Z 36/42	928192, 928200 (with serial number prior to 07020000)	107652	\$22.50
Hustler Mini Z 36/42	928192, 928200 (beginning with serial number 07020000 and later)	108737	\$22.50
FasTrak Super Duty 36/42	928192, 928200	108737	\$22.50



# INDEX

	<b>PAGE</b>		<b>PAGE</b>
Anti-scalp wheels .....	17	Model and serial number.....	1
Belts .....	22	Moving tractor with stalled engine .....	14
Control lever adjustment .....	23	Mower blade maintenance .....	22
Control panel .....	13	Mower blade removal .....	23
Controls .....	13	Mower deck operation.....	17
Deck cutting height adjustment.....	17	Operating suggestions .....	15
Driving the tractor .....	15	Parts and service.....	1
Electrical system .....	20	Product literature.....	29
Engine air filter .....	21	Safe operating practices .....	11
Engine oil and filter.....	21	Safe servicing practices.....	19
Engine starting .....	14	Safety and instruction decals.....	8
Hustler Mini Z 36/42 & FasTrak Super Duty 36/42 Troubleshooting.....	27	Safety precautions .....	7
Hustler Mini Z 36/42 & FasTrak Super Duty 36/42 Maintenance Locator Chart .....	25	Safety start interlock system .....	13
Hustler Mini Z 36/42 & FasTrak Super Duty 36/42 Maintenance Schedule .....	24	Seat adjustment .....	23
Fuel system .....	21	Slope guide.....	9
General engine maintenance .....	22	Stopping the engine.....	14
Hydraulic system.....	20	Storage.....	29
Lubrication .....	20	Tires.....	19
Maintenance & adjustment introduction.....	19	To the new owner.....	1
		Torque values .....	19
		Using this manual.....	1
		Warranty registration .....	1





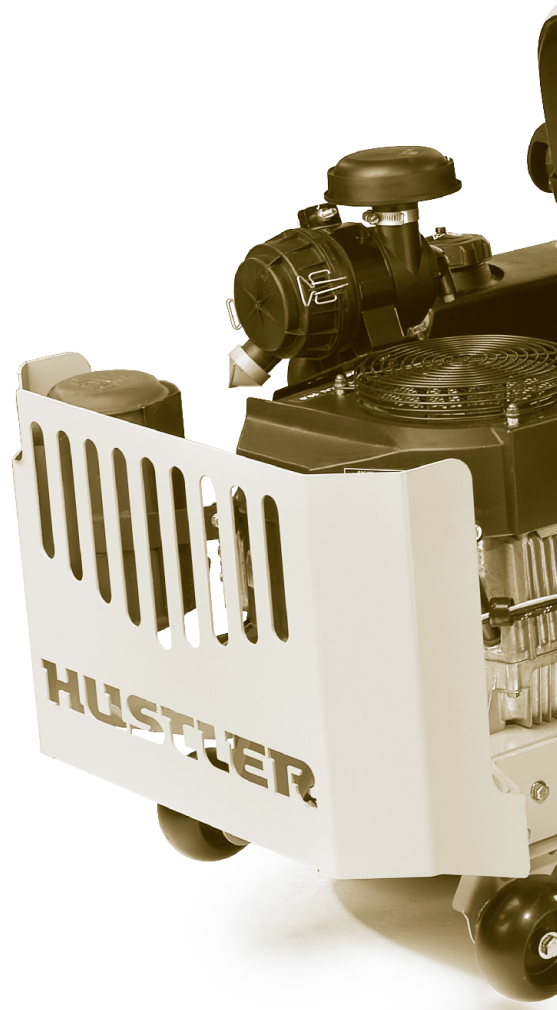

**HUSTLER**

**Hustler Turf Equipment**

PO Box 7000

Hesston, Kansas 67062

620-327-4911 • [hustlerturf.com](http://hustlerturf.com)

PN 107708