

Welcome to Huawei

HUAWEI U8350
User Guide

Contents

1 Reading Before Proceeding.....	1
1.1 Personal Information and Data Security	1
1.2 Safety Precautions.....	2
1.3 Legal Notice.....	3
2 Getting to Know Your Mobile Phone	6
2.1 Mobile Phone View	6
2.2 Installing Your Mobile Phone	8
2.3 Power On or Off Your Mobile Phone	10
2.4 Using the Touchscreen.....	11
2.5 Locking and Unlocking the Screen	12
2.6 Home Screen.....	13
2.7 Using a microSD Card	16
3 Calling.....	17
3.1 Making a Call	17
3.2 Answering or Rejecting a Call.....	18
3.3 Other Operations During a Call	19
3.4 Using Call log.....	20
3.5 Using Airplane Mode	20
4 Contacts	20
4.1 Opening the Contacts Application	21
4.2 Importing Contacts from a SIM Card	21
4.3 Adding a Contact	21
4.4 Searching for a Contact.....	22
4.5 Editing a Contact	22
4.6 Communicating with Your Contacts.....	22
4.7 Deleting a Contact	23
4.8 Managing Groups	23
4.9 Joining and Separating Contacts.....	24

4.10 Staying close to your friends.....	25
5 Using the Keypad	25
5.1 Choosing an Input Method.....	25
5.2 Using the Phone Keypad	25
5.3 Customizing Keyboard Settings.....	26
6 Messaging	27
6.1 SMS and MMS.....	27
6.2 Email.....	28
7 Getting Connected.....	31
7.1 GPRS/3G.....	31
7.2 Wi-Fi	31
7.3 Sharing Your Phone's Data Connection	32
7.4 Browser.....	33
7.5 Bluetooth.....	35
8 Entertainment.....	36
8.1 Taking Photos and Recording Videos	36
8.2 Using the Gallery	38
8.3 Enjoying Music.....	39
8.4 Listening to FM Radio.....	40
9 Google Services.....	41
9.1 Creating a Google Account.....	41
9.2 Using Gmail	42
9.3 Using Talk.....	43
9.4 Using Maps.....	45
9.5 Using YouTube	46
9.6 Using Market.....	46
10 Synchronizing Information	48
10.1 Managing Your Accounts.....	48

10.2 Customizing Your Account Synchronization	49
11 Using Other Applications.....	50
11.1 Using the Calendar	50
11.2 Using the Clock.....	52
11.3 Using the Calculator	53
11.4 Using the Notepad	53
12 Managing Your Mobile Phone	53
12.1 Setting the Date and Time	53
12.2 Setting the Display.....	54
12.3 Setting Ringers	55
12.4 Setting Phone Services	56
12.5 Setting Text-to-Speech	56
12.6 Protecting Your Mobile Phone	57
12.7 Managing Applications.....	58
12.8 Resetting Your Mobile Phone	58
13 Appendix	59
13.1 FAQ	59
13.2 Warnings and Precautions.....	60

1 Reading Before Proceeding

1.1 Personal Information and Data Security

The use of some functions or third-party applications on your device could result in your personal information and data being lost or becoming accessible to others. Several measures are recommended to help you protect personal and confidential information.

- Place your device in a safe area to prevent it from unauthorized use.
- Set your device screen to lock and create a password or unlock pattern to open it.
- Periodically back up personal information kept on your SIM/UIM card, memory card, or stored in your device memory. If you change to a different device, be sure to move or delete any personal information on your old device.
- If you are worried about viruses when you receive messages or emails from a stranger, you can delete them without opening them.
- If you use your device to browse the Internet, avoid websites that might pose a security risk to avoid theft of your personal information.
- If you use services such as Wi-Fi tether or Bluetooth, set passwords for these services to prevent unauthorized access. When these services are not in use, turn them off.
- Install or upgrade device security software and regularly scan for viruses.
- Be sure to obtain third-party applications from a legitimate source. Downloaded third-party applications should be scanned for viruses.
- Install security software or patches released by Huawei or third-party application providers.
- Some applications require and transmit location information. As a result, a third-party may be able to share your location information.
- Your device may provide detection and diagnostic information to third-party application providers. Third party vendors use this information to improve their products and services.

- If you have concerns about the security of your personal information and data, please contact mobile@huawei.com.

1.2 Safety Precautions

Please read the safety precautions carefully to ensure the correct use of your mobile phone.



Do not crash, throw, or puncture your mobile phone. Avoid the falling, squeezing, and bending of your mobile phone.



Do not use your mobile phone in a moist environment, such as the bathroom. Prevent your mobile phone from being soaked or washed in liquid.



Do not switch on your mobile phone when it is prohibited to use phones or when the phone may cause interference or danger.



Do not use your mobile phone while driving.



Follow any rules or regulations in hospitals and health care facilities. Switch off your mobile phone near medical apparatus.



Switch off your mobile phone in aircraft. The phone may cause interference to control equipment of the aircraft.



Switch off your mobile phone near high-precision electronic devices. The phone may affect the performance of these devices.



Do not attempt to disassemble your mobile phone or its accessories. Only qualified personnel are allowed to service or repair the phone.



Do not place your mobile phone or its accessories in containers with a strong electromagnetic field.



Do not place magnetic storage media near your mobile phone. Radiation from the phone may erase the information stored on them.



Do not put your mobile phone in a high-temperature place or use it in a place with flammable gas such as a gas station.



Keep your mobile phone and its accessories away from children. Do not allow children to use your mobile phone without guidance.



Use only approved batteries and chargers to avoid the risk of explosions.



Observe any laws or regulations on the use of wireless devices. Respect others' privacy and legal rights when using your wireless device.



Strictly follow the relevant instructions of this manual while using the USB cable. Otherwise your mobile phone or PC may be damaged.

1.3 Legal Notice

Copyright © Huawei Technologies Co., Ltd. 2011. All rights reserved.

No part of this document may be reproduced or transmitted in any form or by any means without prior written consent of Huawei Technologies Co., Ltd.

The product described in this manual may include copyrighted software of Huawei Technologies Co., Ltd. and possible licensors. Customers shall not in any manner reproduce, distribute, modify, decompile, disassemble, decrypt, extract, reverse engineer, lease, assign, or sublicense the said software, unless such restrictions are prohibited by applicable laws or such actions are approved by respective copyright holders.

Trademarks and Permissions

 ,  , and **HUAWEI** are trademarks or registered trademarks of Huawei Technologies Co., Ltd.

Android is a trademark of Google Inc.

Other trademarks, product, service and company names mentioned are the property of their respective owners.

Notice

Some features of the product and its accessories described herein rely on the software installed, capacities and settings of local network, and therefore may not be activated or may be limited by local network operators or network service providers. Thus the descriptions herein may not match exactly the product or its accessories you purchase.

Huawei Technologies Co., Ltd. reserves the right to change or modify any information or specifications contained in this manual without prior notice and without any liability.

Third-Party Software Statement

Huawei Technologies Co., Ltd. does not own the intellectual property of the third-party software and applications that are delivered with this product. Therefore, Huawei Technologies Co., Ltd. will not provide any warranty of any kind for these third-party software and applications. Neither will Huawei Technologies Co., Ltd. provide support to customers who use these third-party software and applications, nor be responsible or liable for the functions of these third-party software and applications.

Third-party software and applications services may be interrupted or terminated at any time. Huawei Technologies Co., Ltd. does not guarantee that any content or service would be maintained for any period during its availability. Third-party service providers provide content and services through network or transmission tools outside of the control of Huawei Technologies Co., Ltd. To the greatest extent permitted by applicable law, it is explicitly stated that Huawei Technologies Co., Ltd. shall not compensate or be liable for services provided by third-party service providers, or the interruption or termination of third-party contents or services.

Huawei Technologies Co., Ltd. shall not be responsible for the legality, quality, or any other aspects of any software installed on this product, or for any uploaded or downloaded third-party works, such as texts, images, videos, or software. Customers shall bear the risk for any and all effects, including incompatibility between the software and this product, which result from installing software or uploading or downloading the third-party works.

This product uses the open-sourced Android™ platform. Huawei Technologies Co., Ltd. has made necessary changes to the platform. Therefore, this product may not support all the functions that are supported by the standard Android platform or may be incompatible with third-party software. Huawei Technologies Co., Ltd. shall not be liable for any of such situation.

DISCLAIMER OF WARRANTIES

THE CONTENTS OF THIS MANUAL ARE PROVIDED “AS IS”. EXCEPT AS REQUIRED BY APPLICABLE LAWS, NO WARRANTIES OF ANY KIND, EITHER EXPRESS OR IMPLIED, INCLUDING BUT NOT LIMITED TO, THE IMPLIED WARRANTIES OF MERCHANTABILITY AND FITNESS FOR A PARTICULAR PURPOSE, ARE MADE IN RELATION TO THE ACCURACY, RELIABILITY OR CONTENTS OF THIS MANUAL.

LIMITATIONS OF LIABILITY

TO THE MAXIMUM EXTENT PERMITTED BY APPLICABLE LAW, IN NO EVENT SHALL HUAWEI TECHNOLOGIES CO., LTD. BE LIABLE FOR ANY SPECIAL, INCIDENTAL, INDIRECT, OR CONSEQUENTIAL DAMAGES, OR LOST PROFITS, BUSINESS, REVENUE, DATA, GOODWILL OR ANTICIPATED SAVINGS.

THE MAXIMUM LIABILITY (THIS LIMITATION SHALL NOT APPLY TO LIABILITY FOR PERSONAL INJURY TO THE EXTENT APPLICABLE LAW PROHIBITS SUCH A LIMITATION) OF HUAWEI TECHNOLOGIES CO., LTD. ARISING FROM THE USE OF THE PRODUCT DESCRIBED IN THIS DOCUMENT SHALL BE LIMITED TO THE AMOUNT PAID BY CUSTOMERS FOR THE PURCHASE OF THIS PRODUCT.

Import and Export Regulations

Customers shall comply with all applicable export or import laws and regulations and be responsible to obtain all necessary governmental permits and licenses in order to export, re-export or import the product mentioned in this manual including the software and technical data therein.







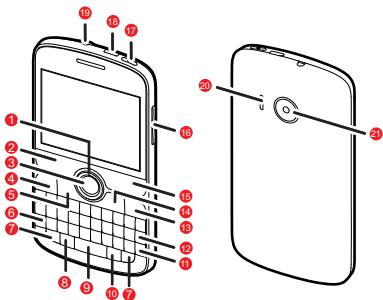

2 Getting to Know Your Mobile Phone









2.1 Mobile Phone View

2.1.1 Phone at a Glance

ⓘ All the pictures in this guide are for your reference only. The actual appearance and display features depend on the mobile phone you purchase.





1	 Navigation key	2	 Send key
3	 OK	4	 Home key
5	 Menu key	6	 Alt key
7	 Cap key	8	 Smiley key

9	 Space key	10	 Symbol key
11	 Enter key	12	 Delete key
13	 Search key	14	 Back key
15	 End key	16	Volume keys
17	 Power key	18	Charge/Data port
19	Headset jack	20	Speaker
21	Camera		

2.1.2 Key Functions at Your Fingertips

- Press to power on your mobile phone.
-  • Press and hold to open the **Phone options** menu.
- Press to lock the screen when your mobile phone is active.

-  • Touch to return to the previous screen.
- Touch to exit any application you are running.

-  Touch to open the menu on an active screen.

-  • Touch to return to the Home screen.
- Touch and hold to show the most recently used applications.

-  Touch to open Google search for searching your mobile phone and the web.

-  • Press to make or answer a call.
- Press to go to the **Call log** screen.

-  • Press to hang up a call.
- Press to return to the Home screen.



Press to navigate selectable items on the screen.



Press to select a highlighted item.

2.2 Installing Your Mobile Phone

2.2.1 Installing the SIM Card

There are two steps to install the SIM card:



1. Remove the battery cover.
2. Insert the SIM card.

2.2.2 Installing the Battery

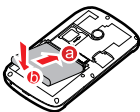

1. Angle the edge labeled **a** (with the contacts) into the bottom end of the battery slot.
2. Push down the edge labelled **b** until the battery clicks firmly into place.

2.2.3 Charging the Battery

Before charging the battery, ensure that it has been properly inserted into your phone.

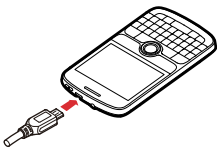

1. Connect the USB cable that came with your mobile phone to the charger.
2. Connect the USB cable to your mobile phone. Then, plug in the connector of the charger to an electrical outlet. The phone begins charging.

If your mobile phone is charged when it is powered on, the battery icon on the Notification bar shows the charging status. When the battery icon changes to , it indicates that your mobile phone is fully charged.

2.2.4 Important Information About the Battery

- If the battery has not been used for a long period of time, you may not be able to power on your mobile phone immediately after you begin charging the battery. Allow the battery to charge for a few minutes with the phone powered off before attempting to power on the phone.
- The battery will not hold a charge for the way it did when it was new. When the battery life becomes noticeably shorter than usual after being charged properly, replace the battery with a new one of the same type.
- Using data services increases demand on the battery and will reduce the length of time it can hold a charge.
- The time required to charge the battery depends on the ambient temperature and the age of the battery.
- When the battery is low on power, the phone plays an alert and displays a prompt. When battery power is almost exhausted, your phone will power off automatically.

2.2.5 Battery Saving Tips

The longevity of battery power depends on the network that you connect to, and how you use your mobile phone.

Try the following to conserve battery power:

- When you do not need 3G services, set your phone to connect to a 2G network.

- When your mobile phone is not in use, switch off the screen.
- Reset the time it takes for your screen light to switch off when you leave your phone idle.
- Lower the screen brightness.
- Use the AC adapter to plug your phone into an external power source whenever possible.
- Turn Bluetooth off when you are not using it. Only make your phone visible to other Bluetooth devices when you need to establish a Bluetooth connection.
- Switch off Wi-Fi when you are not using it.
- Turn off your phone connection to GPS satellites when you are not using it.
- Lower the volume.
- Close power-draining programs, when you do not need them.
- Turn off the data service.

2.3 Power On or Off Your Mobile Phone

2.3.1 Powering On Your Mobile Phone

Press  . The first time you power on your phone, you will be asked to sign in to your account and set up your mobile phone.

 If personal identification number (PIN) protection is enabled on your mobile phone, you must enter your PIN before using the mobile phone.

2.3.2 Setting Up Your Mobile Phone

The first time you power on your mobile phone, the phone displays a setup wizard to help you set up the phone.

The setup wizard helps you:

- Learn about your mobile phone
- Create or sign into your account
- Make some initial decisions about how you want to use your mobile phone

2.3.3 Restarting Your Mobile Phone

1. Press and hold  to open the **Phone options** menu.
2. Touch **Restart**.
3. Touch **OK**.

2.3.4 Turning On Fast Boot

1. Touch  > **Settings** > **Applications**.
2. Select the **Fast boot** check box.

 Do not turn on **Fast boot** while in the aircraft.

2.3.5 Powering Off Your Mobile Phone

1. Press and hold  to open the **Phone options** menu.
2. Touch **Power off**.

 If fast boot is enabled, the phone will go to hibernation-like state. If fast boot is disabled, touch **OK** to shut down the phone completely.

2.4 Using the Touchscreen

2.4.1 Touchscreen Actions

- **Touch:** Use the touch of your finger to select an item, confirm a selection, or start an application.
- **Touch and hold:** Touch an item with your finger and continue to press down until your mobile phone responds. For example, to open the options menu for the active screen, touch the screen and hold down until the menu appears.
- **Flick:** Move your finger either vertically or horizontally across the screen.
- **Drag:** Touch and hold the desired item with your finger. To move an item, drag the item to any part of the screen. You can drag an icon to move or delete it.

2.4.2 Rotating Your Mobile Phone Screen

The orientation of most screens will rotate with the phone as you turn it from upright to the left side and back again.

2.5 Locking and Unlocking the Screen

2.5.1 Locking the Screen

- When your phone is on, press  to lock the screen. When the screen is locked, you can still receive messages and calls.
- If your phone is idle for a while, the screen will lock automatically.

2.5.2 Unlocking the Screen

1. Press  to wake up the screen.
2. Drag the lock icon from left to right to unlock the screen.

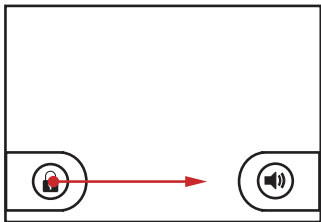

-  If you have set up a screen unlock pattern, you will be prompted to draw the pattern on the screen to unlock it.

2.6 Home Screen

Notifications bar:

Displays the reminders and status icons of your phone.

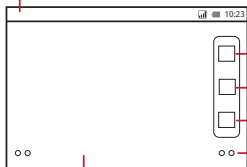

Shortcuts

Screen switching dots:

Indicate the number of the screens on the left or right. Touch the left or right dots to switch between the screen.

Display area:

Shows the operation and display areas of your phone.

2.6.1 Notification and Status Icons



Call in progress



Call in progress using a Bluetooth device



Call forwarding on



Call on hold



Missed call



Connected to a PC



GPS connected



Music playing



New voicemail



New message



GPRS connected



GPRS in use



EDGE connected



EDGE in use



Data service enabled



Data service disabled

2.6.2 Notifications Panel

Your mobile phone will notify you when you receive a new message or there is an upcoming event. The notifications panel also informs you of alarms and settings, for example, you will be notified when **Call forwarding** is activated. Open the notifications panel to see your network operator or to view a message, reminder, or event notification.

Opening the Notifications Panel

1. When a new notification icon appears on the notification bar, flick down to open the notifications panel.
2. On the panel, you can:
 - Touch a notification to open the related application.
 - Touch **Clear** to clear all notifications.

Closing the Notification Panel

Touch and hold the bottom of the panel. Then flick up to close it.

2.6.3 Viewing Other Parts of the Home Screen



Flick your finger left or right across the Home screen.

2.6.4 Customizing the Home Screen

Adding a New Screen Item

1. Touch and hold a blank area on the Home screen until the **Add to Home screen** menu is displayed.
2. Select an item to add it to the Home screen.

Moving a Screen Item

1. Touch and hold an item on the Home screen until the item expands in size and the mobile phone vibrates.
2. Without lifting your finger, drag the item to the desired position on the screen, and then release it.

Removing a Screen Item

1. Touch and hold an item on the Home screen until the item expands and the mobile phone vibrates.
2. Without lifting your finger, drag the item to the trash can. When the item and the trash can turn red, the item is ready to be removed.
3. Release the item to remove it from the Home screen.

2.6.5 Changing the Wallpaper

1. On the Home screen, press  > **Wallpaper**.
2. Touch the following menu items to select a picture and set it as the wallpaper:
 - **Live wallpapers**
 - **Pictures**
 - **Wallpapers**

2.7 Using a microSD Card

2.7.1 Installing the microSD Card (Optional)

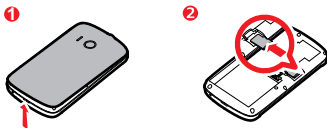

1. Remove the battery cover.
2. Insert the microSD card into the card slot as shown in the diagram.

2.7.2 Using the microSD Card as USB Mass Storage

To transfer all your favorite music and pictures from your PC to your mobile phone's microSD card, set the microSD card as USB mass storage.

1. Connect your mobile phone to your PC with the USB cable. Your PC will detect the microSD card as a removable disk.
2. Open the notification bar, and then touch **USB connected**.
3. Touch **Turn on USB storage** in the dialog box that opens to confirm that you want to transfer files.

You can now transfer files from your PC to your mobile phone's microSD card.

- (?) When your microSD card acts as USB mass storage, your mobile phone will not use this memory space. Your PC will tell you how to safely disconnect the USB mass storage device (your mobile phone) when you have finished transferring files.

2.7.3 Removing the microSD Card

1. Touch **⋮** > **Settings**.
2. Scroll down the screen, and then touch **SD card & phone storage** > **Unmount SD card**.
3. Carefully remove the microSD card.

3 Calling

To make a phone call, you can dial a number or touch a number from your contact list, on a Web page, or in a document. When you are on a call, you can answer other incoming calls or send them to your voicemail box. You can also set up conference calls with several participants.

3.1 Making a Call

To make a call, you can use the **Dialer** application, or select a number from **Contacts** or **Call log**.

When you are on a call, you can press  to use other functions. To return to the calling screen, flick the notification bar down and touch **Current call**.

 Do not block the microphone at the bottom of your phone if you want your voice heard.

3.1.1 Making a Call with the Dialer Application

1. Touch  > **Dialer** to display the dialer.

If you are already working with **Contacts** or **Call log**, touch the **Dialer** tab.

2. Touch the appropriate numeric keys to enter the phone number.

 Your mobile phone supports the SmartDial function, that is, when you touch numbers on the dialer, the phone automatically searches among your contacts and lists the matching results based on the accuracy. If no contact is matched with your entered information, the phone will not display any result.

3. Touch  to initiate the call.

3.1.2 Making a Call from Contacts

1. Touch  > **Contacts** to display the contact list.

If you are already working with **Dialer** or **Call log**, touch the **Contacts** tab.

2. In the list, touch the contact you want to call.

3. Touch  to dial the phone number.

3.1.3 Making a Call from Call log

1. If you are already working with **Contacts** or **Dialer**, touch the **Call log** tab.
2. Touch  to the right of the log entry to dial.

 If you touch and hold a log entry, the options menu will open.

3.2 Answering or Rejecting a Call

3.2.1 Answering an Incoming Call

When you receive a phone call, the incoming call screen opens with the caller's name and number that you have entered in **Contacts**.

Drag the  to the right to answer the call.

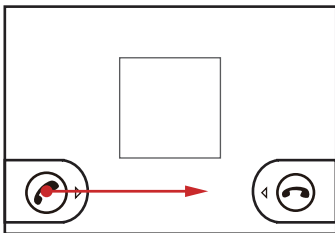

3.2.2 Ending a Call

During a call, press  or touch  > **End call** to hang up.

3.2.3 Rejecting an Incoming Call



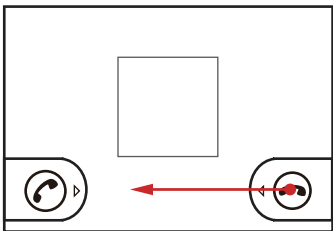

Drag the  to the left to reject the call.



3.3 Other Operations During a Call

3.3.1 Making a Conference Call

If you receive a new call while you are already on a call, you can connect the second call to the call you are on. This feature is known as conference calling. You can also set up a conference call with multiple callers.

- ❗ Contact your network operator to learn if conference calls are supported and, if yes, how many can participate.
- 1. To initiate a conference call, dial the number of the first participant. After you have connected to the first participant, keep the connection open, touch  > **Add call**.
- 2. Enter the phone number of the next person you want to join the conversation and touch , or select someone from your **Call log** or **Contacts**. The first participant is automatically placed on hold while you do this.
- 3. Once you have connected to the second person, touch  > **Merge calls** to begin the conference call.
- 4. To end the conference call and disconnect everyone, press  or touch  > **End call**.

3.3.2 Switching Between Calls

If you receive a new call while you are already on a call, you can switch between the two calls.

1. While you are on the first call and the second call comes in, answer the incoming call, and then touch  > **Swap calls**.
2. The current call is placed on hold and you are connected to the first call.

3.4 Using Call log

The **Call log** contains a list of calls that you have dialed, received, or missed. You can use the call log to reference a recently called number quickly or add an incoming number to your contact list.

3.4.1 Adding an entry to Contacts

1. If you are already working with **Phone** or **Contacts**, touch the **Call log** tab.
2. Touch and hold the entry you want to add.
3. Touch **Add to contacts** in the options menu.
4. Touch **Create new contact** or scroll through the contact list and touch an existing contact name.

3.5 Using Airplane Mode

Some locations may require you to turn off your phone's wireless connections. Rather than powering off your phone, you can place it in **Airplane mode**.

1. Press and hold .
2. Touch **Airplane mode** in the options menu.

4 Contacts

The **Contacts** application enables you to save and manage information such as phone numbers and addresses of your contacts. After you save contact information on your mobile phone, you have easy access to the people with whom you want to communicate.

4.1 Opening the Contacts Application

If you have a new mobile phone and have not yet added any contacts, **Contacts** displays a message with hints on how to start adding contacts to your mobile phone.

Touch  > **Contacts** to open the **Contacts** application.

All of your contacts are displayed alphabetically in a list that you can scroll through.

4.2 Importing Contacts from a SIM Card

1. In the contact list, press  > **Manage contacts**.
2. Touch **Copy from SIM card**.
3. Wait for the SIM card contents to be loaded. Select the contacts you want to import or touch **Select all** to select all contacts.
4. Touch **Copy**.
5. If you have more than one account on your phone, touch the account into which you want to import the contacts.

4.3 Adding a Contact

1. In the contact list, touch  > **Create contact**.
2. If you have more than one account with contacts, touch the account to which you want to add the contact.
3. Enter the contact's name, and then add detailed information such as phone number or address.
4. When you are finished, touch **Done** to save the contact information.

4.3.1 Adding a Contact to Your Favorites

- Touch and hold the contact you want to add to **Favorites**. Then touch **Add to Favorites**.
- Touch a contact, and then touch the star to the right of the contact's name. The star turns gold.

4.4 Searching for a Contact

1. In the contact list, touch  > **Search**.
2. Enter the name of the contact you wish to search for. As you type, contacts with matching names appear below the search box.

4.5 Editing a Contact

You can make changes to the information you have stored for a contact at any time.

1. In the contacts list, touch and hold the contact whose details you want to edit, and then touch **Edit contact** in the options menu.
2. Touch the category of contact information you wish to change: name, phone number, email address, or any other information you recorded earlier.
3. Make the desired changes to the contact information, and then touch **Done**. To cancel all of your changes, touch **Cancel**.

4.6 Communicating with Your Contacts

From the **Contacts** or **Favorites** tab, you can quickly call or send a text (SMS) or multimedia message (MMS) to a contact's default phone number. You can also open details to view a list of all the ways you can communicate with that contact. This section describes how to communicate with a contact when you view your contacts list.

4.6.1 Connecting Through Quick Contact for Android

1. Touch the contact's picture or picture frame (if you have not assigned a picture to the contact) to open Quick Contact for Android.
 2. Touch the icon for the way you want to communicate with the contact.
-  The icons available depend on the information you have entered for the contact, the applications on your phone, and the accounts you have.

4.6.2 Communicating with a Contact

1. In the contacts list, touch the contact that you want to communicate with.

2. On the contact's details screen, touch the icon at the right of the number to call or send messages.



4.7 Deleting a Contact

1. In the contacts list, touch and hold the contact that you want to delete, and then touch **Delete contact** in the options menu.
2. Touch **OK** to confirm that you want to delete the contact.

 Select a contact, and then press  to delete the contact.

4.8 Managing Groups

4.8.1 Creating a Group

1. Press , and then touch the **Groups** tab.
2. In the groups list, press  > **Create group**.
3. Enter the name and picture you want to store for the group, and then give the group a ringtone.
4. press  > **Add Members** to add members to the group.
5. Select the contacts to be added to the group, and then touch **OK**.
6. When you are finished, touch **Done** to save the group information.

 You can add contacts in phone memory rather than in SIM/UIM card to a group.

4.8.2 Editing a Group

You can always make changes to the information you have stored for a group.

1. In the groups list, touch and hold the group whose details you want to edit, and then touch **Edit group** in the options menu.
2. Make the desired changes to the group information, and then touch **Done**. To cancel all changes you made to the group information, touch **Cancel**.

4.8.3 Adding a Contact to Your Groups

To add a contact to your groups, you can do any of the following:

- Touch and hold the contact you want to add to **Groups**. Then touch **Add to groups**.
- When editing a group, press , and then touch **Add Members** to select the contacts you want to add to group.

4.9 Joining and Separating Contacts

When you add an account or add contacts in other ways, such as by exchanging emails, you may have duplications in your Contacts. To avoid duplication, you can join two contacts together to form a single contact.

4.9.1 Joining Contacts

 Make sure you have added an account and have duplicate contacts in Contacts.

1. Touch  > **Contacts**.
2. Touch a duplicated contact.
3. Touch **Joined Contacts** > **Add contact**.
4. Select the contact to be joined to combine two duplicate contacts.

Two contacts will be joined together and displayed as one contact. Touch the contact to view the joined information. If you touch the contact, and then touch **Joined Contacts**, you can see that the contact is joined together by two contacts.

4.9.2 Separating Contacts

If contact information from different sources was joined together with error, you can separate the contacts.

1. Touch  > **Contacts**.
2. Touch a contact to be separated.
3. Touch **Joined Contacts**.
4. Select a contact, and then it is separated.

The contact is then separated into two contacts and displayed as two contacts in **Contacts**.

4.10 Staying close to your friends

Touch  > **Streams**, you can stay close to your friends through social networks.

 The first time you do this, you will be asked to sign in to your account.

5 Using the Keypad

5.1 Choosing an Input Method

1. Touch and hold the space where you enter your text until the **Edit text** menu is displayed.
2. Touch **Input method**.
3. Select the input method.

The keyboard panel will be displayed automatically.

5.2 Using the Phone Keypad

 The following operations are applicable only to the **Huawei IME** input method.





Cursor:





To enter an upper character of one key, press  first and then the desired key.



Cursor:





To enter only upper characters, press  twice before typing. Press  again to switch back to lower-case letters.





Cursor:  To enter one upper-case letter, press  first and then a key.

Cursor:  To enter only upper-case letters, press  twice before typing. Press  again to input lower-case letters.



To switch input language, press  + . The selected language will be displayed on the notifications bar.



- Press  to input a smiley face.
 - Press and hold  to display all expressions.
-



- Press  to display all symbols.
 - Press and hold  to mute the phone.
-

5.3 Customizing Keyboard Settings

1. Touch  > **Settings** > **Language & keyboard**.
2. Select an input method to customize the keyboard settings.

6 Messaging

The Messaging application allows you to exchange text messages (SMS) and multimedia messages (MMS) with anyone using an SMS-or-MMS-capable phone. With the **Email** application you can read and send emails.

6.1 SMS and MMS

6.1.1 Opening Messaging

Touch  > **Messaging**.

6.1.2 Creating and Sending a Text Message

1. Touch  > **Messaging** > **New message**.

2. Enter a phone number in the **To** field.

As you enter the phone number, matching contacts appear. You can touch a suggested recipient or continue entering the phone number.

3. Touch the composition text box to start entering your message.

4. Once you are done, touch **Send**.

The sent and replied messages will display in the same window. As you view and send additional messages, a message thread is created.



6.1.3 Creating and Sending a Multimedia Message

You can use multimedia messages to make everyday communications very special. You can record a message and send it as an audio file, sing 'Happy Birthday' and send it to friend, or send a slideshow of photographs of a special event. The possibilities are endless.

1. Touch  > **Messaging** > **New message**.

2. Enter a phone number in the **To** field.

3. Touch the composition text box to start entering your message.

 If you want to enter a smiley face, press , and then touch **Insert smiley**.

4. Press  to display the options panel.

- Touch **Add subject** to add the message subject. Your mobile phone is now in multimedia message mode.
- Touch **Attach** to add a picture, music, or video file.

5. When the message is ready to be sent, touch **Send**.

Adding a Slideshow

If you want to attach more than one file to your message, use the Slideshow option.

1. On the message editing screen, touch  to display the options panel.
2. Touch **Attach > Slideshow**, and then select a slide to start editing it.
3. Touch  and touch **More > Add slide** to add more slides.
4. Touch **Done** to finish composing your message and return to the multimedia message screen.
5. To alter your multimedia message, touch **Edit** on the multimedia message screen. When the message is ready to be sent, touch **Send**.

6.1.4 Opening and Viewing a Multimedia Message

1. In the message list, touch the message thread you wish to view.
2. Touch the multimedia message to view the message.

6.1.5 Replying to a Message

1. In the message list, touch a text or multimedia message thread to open it.
2. Touch the text box to compose your message, and then touch **Send**.

6.1.6 Customizing the Message Settings

In the message list, touch , and then touch **Settings** to customize the message settings.

6.2 Email

Your mobile phone also puts email at your fingertips. With your phone's **Email** application, you can use your email account with Yahoo!, AOL, or other popular email services on your phone.

6.2.1 Adding an Email Account

When using the **Email** application for the first time, you must configure an email account. The Email setup wizard helps you set up your account. A number of popular email systems are supported. You can work with the same email service that you use on your PC or you can select another email service.

1. Touch  > **Email**.
2. To customize your email settings, answer the onscreen prompts, and then touch **Next**. Or touch **Manual setup** if you want to set the mail server yourself.



 If you choose to set up your account manually, you will need the correct parameters for the account. Contact your email service provider for this information.

3. Enter the account name and the name you want other people to see when they receive an email from you.

4. Touch **Done**.

After the initial setup, your **Email** opens to the screen you were viewing the last time the application was opened. If, however, the **Email** application has not been used for a period of time, it displays the contents of your Inbox or the accounts screen (if you have more than one account).

Adding Other Email Accounts

1. After creating your initial email account, touch  on the **Inbox** screen, and then touch **Accounts** to access the accounts screen.
2. Touch  on the accounts screen, and then touch **Add account** to create another email account.

 When adding an additional email account, you have the option to use the new account to send all outgoing messages.

6.2.2 Viewing an Email Message

1. On the accounts screen, touch the email account you want to use.
2. Access a folder, and then touch the message that you want to view.

6.2.3 Creating and Sending an Email Message

1. On the accounts screen, touch the email account you want to use.
2. On the **Inbox** screen, touch , and then touch **Compose** in the options panel.
3. In the **To** field, enter the name or the email address.
4. Enter the subject of your message and compose the message.

To send an attachment with the message, touch , and then touch **Add attachment**.

5. When you are finished, touch **Send**.

If you are not ready to send the message, touch **Save as draft** or touch  to save the message as a draft.

6.2.4 Replying to an Email Message

1. On the accounts screen, touch the email account you want to use.
2. Touch the email message you want to reply to.
3. Touch **Reply** or **Reply all** to reply to the email message.

6.2.5 Deleting an Email Account

1. On the accounts screen, touch and hold the email account you want to delete.
2. Touch **Remove account**.
3. Touch **OK**.

6.2.6 Changing Email Account Settings

You can change a number of settings for an account, including how often you check for emails, how you are notified of a new mail, and details about the servers the account uses to send and receive mails.

-  Your account's incoming and outgoing settings depend on the kind of email service you are using. You can enter the necessary details manually, although you may need to contact your email service provider to obtain the correct information for the account.

1. Touch  > **Email**.
2. On the accounts screen, touch and hold the email account you want to change.

3. Touch **Account settings**.
4. Change **General settings**, **Notification settings**, or **Server settings**.

7 Getting Connected

7.1 GPRS/3G

Your mobile phone will be automatically configured to use your wireless service provider's GPRS/3G/EDGE service (if available) when you turn on the phone for the first time. Note that the SIM card must be inserted.

7.1.1 Checking the Network Connection

1. Touch  > **Settings**.
2. Touch **Wireless & networks** > **Mobile networks**.
3. Touch **Network operators** or **Access Point Names** to check the network connection.

 Your mobile phone will automatically read the access point of the SIM card. For this reason, do not change the parameters of the access point; otherwise, you might not be able to access network sources.

7.1.2 Turning on the Data Service

1. Touch  > **Settings**.
2. Touch **Wireless & networks** > **Mobile networks**.
3. Select the **Data enabled** check box to turn on the data connection.

 If you do not need a wireless network, you can uncheck the **Data enabled** check box to save data traffic costs.

7.2 Wi-Fi

Wi-Fi gives you wireless access to broadband Internet access. To use Wi-Fi on your mobile phone, you need to have an access to wireless access points (hotspots). Obstacles that block the Wi-Fi signal will reduce its strength.

7.2.1 Turning On Wi-Fi

1. Touch  > **Settings**.
2. Touch **Wireless & networks**, and then select the **Wi-Fi** check box to turn on Wi-Fi.

7.2.2 Connecting to a Wireless Network

1. After turning on Wi-Fi, touch  > **Settings**.
2. Touch **Wireless & networks** > **Wi-Fi settings**. You will see a list of detected Wi-Fi networks in the **Wi-Fi networks** section.
3. Touch a Wi-Fi network to connect to it.
 - If you select an open network, you will be automatically connected to the network.
 - If you select a network that is secured with Wired Equivalent Privacy (WEP) and connect to it for the first time, enter the password, and then touch **Connect**. If you connect to a secured wireless network that you have already used, you will not be prompted to enter the password again unless you reset your mobile phone to its default settings.

 On the **Wi-Fi settings** screen, touch **Add Wi-Fi network** to add a new Wi-Fi network.

7.3 Sharing Your Phone's Data Connection

You can share your mobile phone's data connection with a single computer via a USB cable: USB tethering. You can share your mobile phone's data connection with devices at the same time, by turning your phone into a portable Wi-Fi hotspot.

7.3.1 Sharing Your Phone's Data Connection via USB

To use USB tethering in different operating systems, you may need to prepare your computer to establish a network connection via USB.

 You can not share your mobile phone's data connection and SD card via USB at the same time.

1. Touch  > **Settings**.

2. Touch **Wireless & networks** > **Tethering & portable hotspot**.
3. Select the **USB tethering** check box to share your data connection.

7.3.2 Sharing Your Phone's Data Connection as a Portable Wi-Fi Hotspot

1. Touch  > **Settings**.
2. Touch **Wireless & networks** > **Tethering & portable hotspot**.
3. Select the **Portable Wi-Fi hotspot** check box to share your data connection.

 When **Portable Wi-Fi hotspot** is selected, you can touch **Portable Wi-Fi hotspot settings** to change its network name or secure it.

7.4 Browser

Your mobile phone comes with a browser. You can use **Browser** to access and browse the Internet.

7.4.1 Opening the Browser

Touch  > **Browser** to open the home page.

 When the known or open Wi-Fi networks and the mobile networks are present at the same time, your phone will preferably select a Wi-Fi network for internet access.

Open the browser options menu and perform one of the following operations, touch



- **New window:** Touch to open a new window.
- **Bookmarks:** Touch to display bookmarks.
- **Windows:** Touch to go to the web preview screen. You can switch to another web page or open a new web page on this screen.
- **Refresh:** Touch to refresh the current page.
- **Forward:** Touch to browse the next web page.
- **More:** Touch to open other menus and perform operations such as searching, selecting text, downloading, or setting options.

7.4.2 Opening a Web Page

1. In a browser window, touch the URL field at the top of the screen.
2. Use the keyboard to enter the web page address. You can touch  to enter the web page address by voice.
3. As you enter the address, matching web page addresses will appear on the screen. If you see the address you want, touch it and go directly to that web page or complete entering the address of the web page you want.

7.4.3 Setting a Home Page

1. In a browser window, touch .
2. Touch **More > Settings > Set home page**.
3. Enter the address of the desired home page, and then touch **OK**.

7.4.4 Managing Bookmarks

You can store as many bookmarks as you want on your mobile phone.

Adding a Bookmark

1. In a browser screen, go to the web page you want to save as a bookmark.
2. Touch , and then touch **Bookmarks > Add**. The add bookmark screen opens.
3. Edit the bookmark name as needed and then touch **OK**.

Opening a Bookmark

1. In a browser window, touch , and then touch **Bookmarks**.
On the **Bookmarks** screen, touch the **History** tab to view the pages you have visited. Or touch the **Most visited** tab to view the pages you have visited most frequently.
2. Touch the bookmark of the website you want to open.

7.4.5 Customizing the Browser Settings

Customize the browser to suit your browsing style. Use **Browser** to set page content, privacy, and security preferences. In the browser screen, touch , and then touch **More > Settings**.

7.5 Bluetooth

Your mobile phone has Bluetooth, which allows you to create a wireless connection with other Bluetooth devices so you can share files with your friends, talk hands-free with a Bluetooth headset.

If you are using Bluetooth, remember to stay within 10 meters (33 feet) of other Bluetooth devices. Be aware that obstacles like walls or other electronic equipment may interfere with your Bluetooth connection.

7.5.1 Turning On Bluetooth

1. Touch  > **Settings**.
2. Touch **Wireless & networks**, and then select the **Bluetooth** check box to turn on Bluetooth. When Bluetooth is turned on, the Bluetooth icon appears in the notification bar.
3. Touch **Bluetooth settings**, and then select the **Discoverable** to make your mobile phone visible to other Bluetooth devices.

7.5.2 Pairing and Connecting a Bluetooth Device

Your mobile Bluetooth lets you do the following:

- Hands Free Profile (HFP): allows you to use a hands-free Bluetooth device.
- Headset Profile (HSP): allows you to use a mono Bluetooth headset.
- Object Push Profile (OPP): allows you to transfer files through Bluetooth.
- Advanced Audio Distribution Profile (A2DP): allows you to use a stereo Bluetooth headset.
- AV Remote Control Profile (AVRCP): allows you to control what plays through the Bluetooth headset remotely.

Before you use Bluetooth, you need to pair your mobile phone with another Bluetooth device as follows:

1. Ensure that the Bluetooth function on your mobile phone is enabled.
2. Touch  > **Settings** > **Wireless & networks** > **Bluetooth settings**. Your mobile phone will then scan for Bluetooth devices in range.
3. Touch the device you want to pair with your mobile phone.
4. Enter the pairing password to complete the connection if necessary.

7.5.3 Sending Files via Bluetooth

With Bluetooth, you can share pictures, videos, or music files with your family and friends. To send files via Bluetooth, do as follows:

1. Touch and hold the file to be sent. The active options menu is displayed.
2. Touch **Share**, and then touch **Bluetooth** to select a paired device.

7.5.4 Disconnecting or Unpairing a Bluetooth Device

1. Touch  > **Settings** > **Wireless & networks** > **Bluetooth settings**.
2. Navigate to the **Bluetooth devices** section, and then touch and hold the connected device.

You can also just touch a connected device to disconnect it.

3. Touch **Unpair** to disconnect the device.



8 Entertainment

In addition to being a communication device and personal assistant, your mobile phone also provides you with a multitude of entertainment possibilities. You can take photos, create videos and audio clips, and download and listen to music.

8.1 Taking Photos and Recording Videos

The camera is a combination of camera and camcorder that you can use to shoot and share pictures and videos.

8.1.1 Opening Your Camera

- Touch  > **Camera** to open the camera. The camera opens in landscape mode, ready to take a picture or record a video.
- Press  to close the camera.

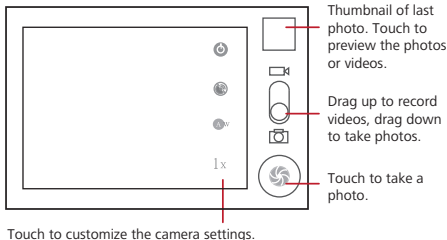

Capture Screen



Touch to customize the camera settings.

On the capture screen, press  to show the capture panel.

8.1.2 Taking a Photo



1. Open your camera and switch to the camera mode.
2. If necessary, change the camera settings. The preview changes as you change the settings.
3. Compose your photo within the photo capture screen.
4. Touch and hold . When the frame turns green, the image is in focus.
5. Release  to take your photo.

The photo you just took is displayed for a moment. You can take another photo or preview your photos.

8.1.3 Viewing Your Photos

1. After taking a photo, a thumbnail of the photo you have just taken is shown in the upper right corner of the capture screen. Touch the thumbnail to view it.
2. Touch the onscreen button to do any of the following:
 - Touch **Share** to send the photo in a message or post it online.
 - Touch **Delete** to delete the photo.
 - Touch **Set as** to set a picture as contact icon or wallpaper.

8.1.4 Recording a Video

1. Open the camera, and then switch to camcorder mode.
2. If necessary, change the camcorder settings.
3. Frame the scene which you want to start your video.
4. Touch  to start recording a video.
5. Touch  to stop recording.

8.1.5 Viewing Your Videos

After recording a video, a thumbnail of the video you have just recorded is shown in the upper right corner of the Capture screen. Touch the thumbnail to view it. On the video playing screen, touch the controls to skip forward or back or to play or pause the video.

8.2 Using the Gallery

Your **Gallery** application can automatically search for pictures and videos on your microSD card. Use **Gallery** to sort photos and videos into folders, view and edit pictures, watch videos, and set a picture as wallpaper or as a photo for a contact.

8.2.1 Opening the Gallery

Touch  > **Gallery** to open the viewer.

The **Gallery** application categorizes your pictures and videos by storage location and stores these files in folders. Touch a folder to view the pictures or videos inside.

Touch  to display the gallery panel. On the panel, you can do the following:

- Touch **Capture picture** to open the camera and switch to the picture capture mode.
- Touch **Capture video** to open the camera and switch to the video capture mode.
- Touch **Settings** to go to the gallery settings screen. There, you can set the size of a picture, arrange pictures, play a slideshow, and specify whether to prompt for confirmation when you delete a picture.

8.2.2 Viewing a Picture

1. In the **Gallery**, touch the folder that contains the pictures you want to view.

2. Touch the picture to view it in full-screen mode.
3. Touch the screen. Then the zoom panel appears. You can zoom in or zoom out on the picture.

 The picture viewer supports the automatic rotation function. When you rotate your mobile phone, the picture adjusts itself to the rotation.

8.2.3 Rotating a Picture

1. When viewing a picture, touch  to display the operations panel.
2. Touch **Rotate**.
3. Select either **Rotate left** or **Rotate right**. The picture is saved with the new orientation.

8.2.4 Cropping a Picture

1. When viewing a picture, touch  to display the more operations panel, and then touch **Crop**.
2. Use the cropping tool to select the portion of the picture to crop.
 - Drag from the inside of the cropping tool to move it.
 - Drag an edge of the cropping tool to resize the image.
 - Drag a corner of the cropping tool to resize the image without changing the length to width ratio.
3. Touch **Save** to save the cropped picture. Touch **Discard** to discard the changes.

8.3 Enjoying Music

8.3.1 Copying Music to the microSD Card

1. Connect the phone to your computer with a USB cable and mount the microSD card.
2. On the PC, navigate to the USB drive and open it.
3. Create a folder in the root directory of the microSD card (for example, **Music**).
4. Copy the music from your computer to the folder you have created.
5. After copying music, unmount or eject the drive as required by your PC's operating system to safely remove the mobile phone.

6. Disconnect the mobile phone from the PC.



8.3.2 Opening the Media Library

Touch  > **Music** to display the media library.

The **Music** application organizes your music files by storage location. It contains five tabs: **Artists**, **Albums**, **Songs**, **Playlists** and **Now playing**.

8.3.3 Playing Music

1. Touch a category on the music library screen.
2. Touch the song you want to play.

 When you are listening to music, press , to use another application. Your music continues to play. To return to the music controls, open the notification panel and then touch the song.

8.3.4 Adding Music to a Playlist

1. Touch a category on the music library screen.
2. In the list that appears, select the song you want to add to the playlist.
3. Touch and hold the song, and then touch **Add to playlist** in the options menu.
 - Touch **Current playlist** to add the song to an existing playlist.
 - Touch **New** to create a playlist and add the song to it.

8.3.5 Playing a Playlist

1. Touch the **Playlists** tab on the music library screen.
2. Touch and hold the playlist you want to play.
3. Touch **Play** to play the playlist.

8.4 Listening to FM Radio



FM Radio lets you listen to FM radio stations on your mobile phone. Since FM Radio uses the provided wired stereo headset as the antenna, connect the headset first to the audio jack of your phone before you open the application.

8.4.1 Opening the FM Radio

1. Touch  > **FM Radio** to open the application.
2. The first time you open FM Radio, touch **Auto tuning**, which automatically scans for available FM channels, saves them as presets, and plays the first FM channel found.

8.4.2 Tuning the FM Radio

Open the **FM Radio** application, and then touch  to do the following:

- Touch **Inching tuning**, then touch  or  to fine tune the frequency at -0.05 MHz or +0.05 MHz intervals. Touch **OK** when you are satisfied. After tuning, touch , and then touch **Save channel**.
- Touch **Auto tuning** to scan automatically for available FM channels.

9 Google Services

 Availability of Google applications, services, and features may vary according to your country or carrier. Please follow the local laws and regulations to use them.

When you turn on your mobile phone for the first time, touch a Google services such as **Talk**, **Gmail**, or **Market**, and you will be prompted to sign in to your Google account.

 Ensure that your mobile phone has an active data connection (3G/GPRS) before you sign in to your Google account.

If you already have a Google account, touch **Sign in** and enter your username and password.

9.1 Creating a Google Account

If you do not have a Google account, you can create one:

1. After reading the setup information, touch **Next**.
2. Touch **Create**.
3. Enter a first name, last name, and user name for your Google account, and then touch **Next**. The mobile phone will connect to the Google server to check whether

the username is available. If the username you entered is already in use, you will be prompted to choose another one or select one from a list.

4. Enter and confirm your Google account password.
5. Select a security question from the drop down menu, and then enter the answer.
6. Touch **Create**.
7. When the **Google Terms of Service** screen appears, touch **I agree, Next**.
8. Enter the characters that appear on the screen, and then touch **Next**.

 To use another Google account, go to the **Accounts & sync settings** screen, and touch **Add account** to select which type of accounts you want to add.

9.2 Using Gmail

Gmail is Google's web-based email service. When you first set up your phone, you may have configured it to use an existing **Gmail** account or create a new account. The first time you open the **Gmail** application on your phone, your **Inbox** will contain the messages from your **Gmail** account on the web.

9.2.1 Opening Gmail

Touch  > **Gmail**. The **Inbox** mail list appears. Any emails you decide to keep on your mobile phone will go to your **Inbox** folder.

9.2.2 Switching Between Accounts

1. In the mail list, touch , and then touch **Accounts**.
2. Touch the account that contains the email you want to read.

9.2.3 Creating and Sending an Email

1. In the mail list, touch , and then touch **Compose**.
2. Enter the message recipient's email address in the **To** field. If you are sending the email to several recipients, separate the email addresses with commas. You can add as many message recipients as you want.

If you want to send a copy (Cc) or a blind copy (Bcc) of the email to other recipients, touch , and then touch **Add Cc/Bcc**.

3. Enter the email subject and write your message.

If you want to add a picture attachment, touch , and then touch **Attach** to select the picture you want to attach.

4. After composing your email, touch **Send**.

9.2.4 Replying To or Forwarding an Email

1. In the mail list, touch the email that you want to reply to or forward.

2. Touch , and then touch **Reply**, **Reply all**, or **Forward**.

3. Do one of the following:

- If you selected **Reply** or **Reply all**, enter your message.
- If you selected **Forward**, specify the message recipients and add any additional text you want to include with the forwarded message.

4. Touch **Send**.

9.2.5 Searching for an Email

1. In the mail list, touch , and then touch **Search**.

2. Enter the search keywords in the box, and then touch .

9.2.6 Customizing Your Gmail Settings

In the mail list, touch , and then touch **More > Settings** to customizing your **Gmail**.

9.3 Using Talk

Talk is Google's instant messaging service. You can use it to communicate in real time with other people using **Talk** on a phone or on the web.

9.3.1 Opening Talk

Touch  > **Talk** to open the application.

 Your **Talk** account is based on the Google account you set up with your mobile phone.

9.3.2 Adding a Friend

1. In the friends list, touch  , and then touch **Add friend**.
2. Enter the **Talk** instant messaging ID or Google email address of the friend you want to add.
3. Touch **Send invitation**.

9.3.3 Accepting an Invitation

1. If you have invited anyone to chat or if someone else has invited you to chat, this information will appear in the friends list.
2. Touch a pending invitation, and then touch **Accept**.

9.3.4 Starting a Chat

1. In the friends list, touch a friend's name in the friends list.
2. Use the onscreen keyboard to enter text and chat with your friend.
3. After entering your message, touch **Send**.

9.3.5 Setting Notifications for New Instant Messages

Whenever you receive an instant message, your mobile phone can play a sound, vibrate, or display an icon. To set up one of these handy notifications, start in the friends list, and then touch  . Then touch **Settings**. Now choose from one of the following:

IM notifications	Select the check box to receive a notification on the notification bar when you receive an instant message.
Select ringtone	Touch to choose the ringtone used for a new instant message. You will hear a short sample of the ringtone when you select it. To turn the ringtone off, select Silent .
Vibrate	Select the check box to make your mobile phone vibrate when you receive a new instant message.

9.3.6 Signing Out of Talk

In the friends list screen, touch  , and then touch **Sign out** to quit **Talk**.

9.4 Using Maps

Maps lets you find your current location, view real-time traffic conditions (depending on availability in your locale), and get detailed directions to various destinations on a satellite, traffic, or other kind of map.

9.4.1 Enabling Location Source

Before you open **Maps** to find your location or search for places of interest, you must enable "location source".

1. Touch  > **Settings**.
2. Touch **Location & security**.
3. In the **My Location** section, select the **Use wireless networks** check box, **Use GPS satellites** check box, or both.

9.4.2 Opening Maps

Touch  > **Maps** to open the application.

9.4.3 Searching for Places of Interest

1. On the map, touch  , and then touch **Search**.
2. Enter the place you want to search for in the search box, and then touch the Search icon.
3. Your search results will then be displayed. Touch a place you are interested in and the application will show where it is on the map.

9.4.4 Getting Directions

1. While viewing a map, touch  , and then touch **Directions**.
2. Enter the starting point in the first text box, and then enter your destination in the second text box.
3. Touch the icon for car, public transit, or walking directions.

4. Touch **Go**. Your directions will appear in a list.
5. Touch a direction item on the list to show it on the map.
6. When you finish viewing or following the directions, touch  and touch **More > Clear Map** to reset the map.

9.5 Using YouTube

YouTube is Google's free online video streaming service for viewing, searching for, and uploading videos.

9.5.1 Opening YouTube

Touch  > **YouTube**. You will then see the YouTube screen. The videos will be grouped into categories, such as **Most viewed**, **Most discussed**, **Top rated**, and more.

9.5.2 Searching for a Video

1. On the **YouTube** screen, touch , and then touch **Search**.
2. Enter a search keyword, and then touch the Search icon.
3. You will see a number of search results displayed below the notification bar. Scroll through the results and touch a video to watch it.

9.5.3 Sharing a Video

1. On the **YouTube** screen, do one of the following:
 - While viewing a list of videos, touch and hold a video entry, and then touch **Share** on the options menu.
 - While watching a video, touch , and then touch **Share**.
2. Compose a message if you like, address the email, and send it.

9.6 Using Market

Android Market provides direct access to applications and games which you can download and install on your phone.

9.6.1 Opening Market

1. Touch  > **Market**.
2. When you open **Market** for the first time, the **Android Market Terms of Service** window will appear. Touch **Accept** to continue.

9.6.2 Searching for Applications

There are a few different ways to find applications on the **Market** home screen, including:

- Featured applications.
- List of games.
- Search function.
- Your downloads.

9.6.3 Installing an Application

 If you want to install a non-Market application, touch  > **Settings** > **Applications**, and then select the **Unknown sources** check box to allow installation of the non-Market application.

1. In the **Market**, touch **Apps**.
2. Touch a category, and then touch the item you want to download.
3. On the item details screen, read more about the application, including its cost, overall rating, and user comments. If you scroll down to the **Developer Info** section, you can see other applications from the same developer, link to the developer's website, or send the developer an email.
4. To install the item, touch **FREE** > **OK** (if the item is free) or **Buy**, whichever is displayed.
5. To check the progress of a download, open the notification panel. Most applications are installed within seconds. To stop an item from downloading, touch **Cancel**.
6. After the application has been downloaded and installed on your mobile phone, the content download icon appears in the notification bar.

9.6.4 Uninstalling an Application

1. On the **Market** screen, touch **My apps**.

2. Touch the application you want to uninstall, and then touch **Uninstall**.
3. When prompted, touch **OK** to remove the application from your mobile phone.
4. Choose the reason for removing the application, and then touch **OK**.

10 Synchronizing Information

Some applications on your mobile phone give you access to the same personal information that you can add, view, and edit on your computer. If you add, change, or delete your information in any of these applications on the web, the updated information also appears on your mobile phone.

This is made possible through over-the-air data synchronization. The process occurs in the background and does not interfere with use of your mobile phone. When your phone is synchronizing, a data synchronization icon will be shown in the notification bar.

10.1 Managing Your Accounts

You can synchronize contacts, email, and other information on your mobile phone with multiple Google accounts or other kinds of accounts, depending on the applications installed on your mobile phone.

For example, you can start by adding your personal Google account, so your personal email, contacts, and calendar are always available. You could then add a work account, so your work-related emails and work contacts are handy. If you like, you may add multiple Google accounts or other accounts.

10.1.1 Adding an Account

When you add an account, **Contacts** compares contacts from the newly synchronized account with contacts from your existing mobile phone accounts and attempts to merge duplicates into a single entry in **Contacts**. While it is presented as a single contact entry, the contact data itself is not merged.

1. Touch  > **Settings** > **Accounts & sync**. The screen displays your current synchronization settings and a list of your current accounts.

 In some cases, you may need to obtain account details from an IT support. For example, you may need to know the account's domain or server address.

2. Touch **Add account**.
3. Touch the kind of account to add.
4. Follow the onscreen steps to enter the required and optional information about the account. Most accounts require a username and password, but the details depend on the kind of account and the configuration of the service to which you are connecting.
5. Configure the account. Depending on the kind of account, you may be asked to configure what kind of data you want to sync to the mobile phone, to name the account, and for other details. When you are finished, the account is added to the list in the **Accounts & sync** screen.

10.1.2 Removing an Account

You can remove an account, deleting it and all information associated with it from your mobile phone, including email, contacts, settings, and so on. You cannot, however, remove some accounts, such as the first account you signed into on the mobile phone. If you attempt to remove certain accounts, all personal information associated with it will be deleted.

ⓘ You can only remove a **Gmail** account by resetting the phone to factory defaults.

1. On the **Accounts & sync** screen, touch the account to delete.
2. Touch **Sign Out**.
3. Confirm that you want to remove the account.

10.2 Customizing Your Account Synchronization

You can configure background data use and synchronization options for all the applications on your phone. You can also configure what kind of data you synchronize for each account.

For some accounts, synchronizing is two-directional; changes that you make to the information on your mobile phone are made to the copy of that information on the web. Some accounts support only one-way synchronize; the information on your mobile phone is read-only.

10.2.1 Configuring General Sync Settings

On the **Accounts & sync** screen, do the following:

- Select or clear the **Background data** check box to control whether applications and services can transmit data when you are not working with them directly (that is, when they are running in the background).

If you clear this option, **Gmail** stops receiving new mail, **Calendar** stops synchronizing events, and so on, until you touch the **Refresh** menu item or send an email.

- Select or clear the **Auto-sync** check box to control whether changes you make to information on the phone or on the web are automatically synchronized with each other.

For example, when this option is selected, changes that you make in **Contacts** on the phone are automatically made in Google Contacts on the web.

10.2.2 Changing an Account's Synchronization Settings

1. On the **Accounts & sync** screen, touch the account whose synchronization settings you want to change. The data and synchronization screen opens, displaying a list of the kinds of information the account can synchronize.
2. Selected items are configured to synchronize to your mobile phone.
3. Select or clear the check box of information you want to synchronize to the mobile phone.

11 Using Other Applications

11.1 Using the Calendar

Use **Calendar** to create and manage events, meetings, and appointments. Depending on your synchronization settings, the calendar on your phone can be synchronized with the internet-based calendar you use.

11.1.1 Opening the Calendar

Touch  > **Calendar** to open the application.

 To access Google calendar, touch , and then touch **More > Calendars**.

11.1.2 Creating an Event

1. On any calendar view, touch . Then touch **New event** to open the **Event details** screen.
2. Enter the event name.
 - If there is a time frame for the event, touch **From** and **To** to set the beginning and end times of the event.
 - If the event is a special occasion such as a birthday or a day-long activity, set the date for **From** and **To**, and then select the **All day** check box.
3. Enter the location of the event and a description.
4. If you have more than one calendar, select the calendar where you want to save the event.
5. Set the time of your event reminder in **Reminders**, and then specify in **Repetition** whether the event recurs and, if it does, how frequently.
6. Touch **Done**.

 To quickly create an event in the **Day**, **Week**, or **Month** view, touch and hold an empty time slot, and then touch **New event**. A new event details screen will appear with the selected time slot and date in the **From** and **To** fields.

11.1.3 Setting an Event Reminder

1. On any calendar view, touch an event to view its details or an event summary.
2. Touch the **Add reminder** button to add a reminder. Or touch the reminder's "-" button to delete an existing reminder.
3. Touch the reminder time, and then touch the length of time before the event when you want to be reminded. When the time comes, you will receive a notification about the event.

11.1.4 Customizing the Calendar Settings

On any calendar view, touch . Then touch **More > Settings**.

- **Hide declined events:** Select to hide events for which you have declined invitations.

- **Set alerts & notifications:** Touch to set event reminders to alert you, send you a notification, or to turn off event notifications on your mobile phone.
- **Select ringtone:** Touch to select the ringtone to sound when you receive an event reminder.
- **Vibrate:** Select to vibrate the mobile phone when you receive an event notification.
- **Default reminder time:** Touch to select the default time before an event for event reminders to occur.

11.2 Using the Clock

In addition to displaying the date and time, the **Clock** application displays information about the weather and your phone. You can also use **Clock** to turn your mobile phone into an alarm clock.

11.2.1 Opening the Clock

Touch  > **Clock** to open the application.

Clock opens with the date and time displayed on your Home screen wallpaper, along with your local weather and other useful information.

11.2.2 Opening the Alarms

On the **Clock** screen, touch  to open the **Alarms**.

Adding an Alarm

1. On the alarm list screen, touch **Add alarm**.
2. Set the alarm, and then touch **Done**.

Setting an Alarm

1. On the alarm list screen, touch one of the alarms on the screen.
2. Touch **Time** to set the time of the alarm.
3. Touch **Repeat** to set the days when you want the alarm to sound.
4. Touch **Ringtone** to select a ringtone for the alarm.
5. Select the **Vibrate** check box to have the phone vibrate, in addition to playing the ringtone.
6. Touch **Label** to enter a name for the alarm.

7. Touch **Done**.

Customizing Alarm Settings

On the alarm list screen, touch , and then touch **Settings**.

11.3 Using the Calculator

Use the calculator to solve simple arithmetic problems or use its advanced operators to solve more complex equations.

11.3.1 Opening the Calculator



Touch  > **Calculator** to open the application.

11.3.2 Switching to the Advanced panel

On the **Calculator** screen, flick the screen to the right or left to switch between **Advanced panel** and **Basic panel**.

11.4 Using the Notepad

Notepad features a simple text processor and lists all notes in a linear structure. You can add, edit, and delete notes.

1. Touch  > **Notepad** to open the application.
2. Touch , and then touch **Add note** to create a note.
3. Touch  to save the note.

12 Managing Your Mobile Phone

To configure your mobile phone, touch  > **Settings**.

12.1 Setting the Date and Time

By default, your mobile phone automatically uses the date, time zone, and time provided by the network.

❗ When your mobile phone is using date and time settings provided automatically by the network, you cannot manually set the date, time, and time zone.

1. On the **Settings** screen, touch **Date & time**.
2. Clear the **Automatic** check box.
3. Touch **Set date**. On the set date screen, touch **+** or **-** to adjust the date, month, and year, and then touch **Set** when the configuration is complete.
4. Touch **Select time zone**, and then select the desired time zone from the list. Scroll the list to view more time zones.
5. Touch **Set time**. On the set time screen, touch **+** or **-** to adjust the hour and minute. Touch **Set** when the configuration is complete.
6. Select or clear the **Use 24-hour format** check box to switch between 24-hour format and 12-hour format.
7. Touch **Select date format** to select how you want the date to display on your mobile phone.

12.2 Setting the Display

12.2.1 Adjusting the Screen Brightness

1. On the **Settings** screen, touch **Display > Brightness**.
2. Drag the slider left to make the screen darker, or right to make it brighter.
3. Touch **OK** to save the adjustment.

12.2.2 Adjusting the Time Before the Screen Turns Off

If your mobile phone is idle for several minutes, it will turn off the screen to save battery power. To set a longer or shorter idle time, do the following:

1. On the **Settings** screen, touch **Display > Screen timeout**.
2. Select the duration you want the screen to be illuminated.

12.3 Setting Ringers

12.3.1 Turning On Silent Mode

1. On the **Settings** screen, touch **Sound**.
2. Select the **Silent mode** check box to silence all sounds except alarms, and music and video media sound.

12.3.2 Adjusting the Volume

You can adjust the volume from the Home screen or any application screen (except during a call or when playing music or videos). Press the Volume keys to adjust volume to the level you desire.



You can also adjust the volume from the settings screen.

1. On the **Settings** screen, touch **Sound > Volume**.
2. Drag the slider left to make the volume lower, or right to make it higher.
3. Touch **OK** to save the adjustment.

12.3.3 Changing the Phone Ringtone

1. On the **Settings** screen, touch **Sound > Phone ringtone**.
2. Touch the ringtone you want to use, and then touch **OK**. The ringtone plays when selected.

12.3.4 Changing the Message Ringtone

1. On the Home screen, touch  > **Messaging**.
2. In the message list, press  > **Settings > Select ringtone**.
3. Touch the ringtone you want to use, and then touch **OK**. The ringtone plays when selected.

12.4 Setting Phone Services

12.4.1 Customizing Call Settings

Your mobile phone service provider offers different services such as call forwarding, call waiting, fixed dialing numbers, and voicemail. You can customize many of these services if they are part of your calling plan.

On the **Settings** screen, touch **Call settings** to customize your call functions.

12.4.2 Turning on Data Roaming

1. On the **Settings** screen, touch **Wireless & networks > Mobile networks**.
2. Select the **Data roaming** check box.

ⓘ Accessing data services while roaming may incur additional charges. Ask your wireless service provider about data roaming fees.

12.4.3 Switching off the Data Service

1. On the **Settings** screen, touch **Wireless & networks > Mobile networks**.
2. Clear the **Data enabled** check box.

12.5 Setting Text-to-Speech

Use the Text-to-Speech settings to configure the Android text-to-speech synthesizer, for applications that can take advantage of this feature.

12.5.1 Installing Voice Data

1. On the **Settings** screen, touch **Voice input & output > Text-to-speech settings > Install voice data**.
2. If your mobile phone does not have speech synthesizer data installed, connect to Android Market and let it guide you through the process of downloading and installing the data.
3. Follow the instructions to install the voice data.

12.5.2 Adjusting the Speech Rate

1. On the **Settings** screen, touch **Voice input & output > Text-to-speech settings > Speech rate**.
2. Select a speed at which the text is to be spoken.

12.6 Protecting Your Mobile Phone

12.6.1 Turning on Your SIM Card PIN

1. On the **Settings** screen, touch **Location & security > Set up SIM card lock**.
2. Select the **Lock SIM card** check box.
3. Use the keyboard to enter the SIM card PIN, and then touch **OK**.
4. To change the SIM card PIN at any time, touch **Change SIM PIN**.

 You can dial emergency numbers any time from your mobile phone.

12.6.2 Protecting Your Mobile Phone with a Screen Lock

To keep your data more secure, lock the screen and/or require a screen unlock pattern every time your mobile phone is turned on or wakes up from sleep mode.

1. On the **Settings** screen, touch **Location & security > Set up screen lock > Pattern**.
2. Flicking your finger vertically, horizontally or diagonally, connect at least four dots in any order you choose. Lift your finger from the screen when you are finished.

You must flick your finger on the screen to create the pattern, not simply touch individual dots.

3. Your mobile phone will record the pattern. Touch **Continue**.
 4. When prompted, draw the screen unlock pattern again, and then touch **Confirm**.
- To change your unlock screen pattern, touch **Location & security > Change screen lock**.

12.7 Managing Applications

12.7.1 Viewing an Installed Application

1. On the **Settings** screen, touch **Applications > Manage applications**.
2. In the applications list, do any of the following:
 - Touch , and then touch **Sort by size**. Then touch an application to view its details.
 - Touch an application directly to view its details.

12.7.2 Uninstalling an Application

1. On the **Settings** screen, touch **Applications > Manage applications**.
2. Touch an application, and then touch **Uninstall**.

12.7.3 Ways to Free Up Your Mobile Phone Memory

- Move files and email attachments to the microSD card.
- In **Browser**, clear all temporary Internet files and Browser history information.
- Uninstall any downloaded programs that you no longer use.
- Reset your mobile phone.

12.8 Resetting Your Mobile Phone

12.8.1 Backing Up My Data

You can use your Google account to back up your mobile phone's settings to Google servers. If you replace your mobile phone, the settings you have backed up will be transferred to the new mobile phone the first time you sign in to your Google account.

1. On the **Settings** screen, touch **Privacy**.
2. Select the **Back up my data** check box.

12.8.2 Restoring Factory Data

If you reset your phone to the settings that were configured at the factory, all of your personal data stored on the phone, including information about your Google Account,

any other accounts, your system and application settings, and any applications you have downloaded will be erased. Resetting the phone does not erase any system software updates you have downloaded or any files on your microSD card, such as music clips or photos.

1. On the **Settings** screen, touch **Privacy > Factory data reset**.
2. When prompted, touch **Reset phone**, and then touch **Erase everything**. The mobile phone resets the settings to the original factory settings, and then restarts.

13 Appendix

13.1 FAQ

How do I set a song as phone ringtone?

In the media library, touch and hold the song to be set as ringtone, and then touch **Use as phone ringtone**.

How do I prevent automatic switching of orientation when rotating phone?

Touch  > **Settings > Display > Auto-rotate screen** to disable the function.

How do I set the unlock pattern?

Touch  > **Settings > Location & security > Set up screen lock > Pattern**.

How can I change the input method?

Touch and hold the area where you write text and then select the input method you prefer.

How do I stop the song playing in the background?

Touch the notification bar, flick downwards to open the notifications panel, and then touch the music playing notification to go to the music playing screen.

How do I return to the calling screen?

While on a call, if you're on another screen, you can touch the notification bar, and drag downwards to open the notifications panel. Then touch the current call notification to return to the calling screen.

How do I create an application shortcut on the Home screen?

Touch and hold an application icon on the main menu screen until the Home screen is displayed. Then drag the icon where you want it to go and release your finger.

13.2 Warnings and Precautions

This section contains important information pertaining to the operating instructions of your device. It also contains information about how to use the device safely. Read this information carefully before using your device.

Electronic Device

Power off your device if using the device is prohibited. Do not use the device when using the device causes danger or interference with electronic devices.

Medical Device

- Follow rules and regulations set forth by hospitals and health care facilities. Do not use your device when using the device is prohibited.
- Pacemaker manufacturers recommend that a minimum distance of 15 cm be maintained between a device and a pacemaker to prevent potential interference with the pacemaker. If you are using a pacemaker, use the device on the opposite side of the pacemaker and do not carry the device in your front pocket.

Potentially Explosive Atmosphere

Power off your device in any area with a potentially explosive atmosphere, and comply with all signs and instructions. Areas that may have potentially explosive atmospheres include the areas where you would normally be advised to turn off your vehicle engine. Triggering of sparks in such areas could cause an explosion or a fire, resulting in bodily injuries or even deaths. Do not power on your device at refueling points such as service stations. Comply with restrictions on the use of radio equipment in fuel depots, storage, and distribution areas, and chemical plants. In addition, adhere to restrictions in areas where blasting operations are in progress. Before using the device, watch out for areas that have potentially explosive atmospheres that are often, but not always, clearly marked. Such locations include areas below the deck on boats, chemical transfer or storage facilities, and areas where the air contains chemicals or particles such as grain, dust, or metal powders. Ask the manufacturers of vehicles using liquefied petroleum gas (such as propane or butane) whether this device can be safely used in their vicinity.

Traffic Security

Observe local laws and regulations while using the device. In addition, if using the device while driving a vehicle, comply with the following guidelines:

- Concentrate on driving. Your first responsibility is to drive safely.
- Do not talk on the device while driving. Use hands-free accessories.
- When you have to make or answer a call, park the vehicle at the road side before using your device.
- RF signals may affect electronic systems of motor vehicles. For more information, consult the vehicle manufacturer.
- In a motor vehicle, do not place the device over the air bag or in the air bag deployment area. Otherwise, the device may hurt you owing to the strong force when the air bag inflates.
- Do not use your device while flying in an aircraft. Power off your device before boarding an aircraft. Using wireless devices in an aircraft may cause danger to the operation of the aircraft and disrupt the wireless telephone network. It may also be considered illegal.

Operating Environment

- Do not use or charge the device in dusty, damp, and dirty places or places with magnetic fields. Otherwise, it may result in a malfunction of the circuit.
- The device complies with the RF specifications when the device is used near your ear or at a distance of 1.5 cm from your body. Ensure that the device accessories such as a device case and a device holster are not composed of metal components. Keep your device 1.5 cm away from your body to meet the requirement earlier mentioned.
- On a stormy day with thunder, do not use your device when it is being charged, to prevent any danger caused by lightning.
- When you are on a call, do not touch the antenna. Touching the antenna affects the call quality and results in increase in power consumption. As a result, the talk time and the standby time are reduced.
- While using the device, observe the local laws and regulations, and respect others' privacy and legal rights.

- Keep the ambient temperature between -10°C and 45°C while the device is being charged. Keep the ambient temperature between -10°C to 55°C for using the device powered by a battery.

Prevention of Hearing Damage

Using a headset at high volume can damage your hearing. To reduce the risk of damage to hearing, lower the headset volume to a safe and comfortable level.

Safety of Children

Comply with all precautions with regard to children's safety. Letting the child play with your device or its accessories, which may include parts that can be detached from the device, may be dangerous, as it may present a choking hazard. Ensure that small children are kept away from the device and accessories.

Accessories

Choose only batteries, chargers, and accessories approved for use with this model by the device manufacturer. The use of any other type of battery, charger, or accessory may invalidate any warranty for the device, may be in violation of local rules or laws, and may be dangerous. Please contact your dealer for information about the availability of approved batteries, chargers, and accessories in your area.

Battery and Charger

- Unplug the charger from the electrical plug and the device when not in use.
- The battery can be charged and discharged hundreds of times before it eventually wears out. When the standby time and the talk time are shorter than the normal time, replace the battery.
- Use the AC power supply defined in the specifications of the charger. An improper power voltage may cause a fire or a malfunction of the charger.
- Do not connect two poles of the battery with conductors, such as metal materials, keys, or jewelries. Otherwise, the battery may be short-circuited and may cause injuries and burns on your body.
- If battery electrolyte leaks out, ensure that the electrolyte does not touch your skin and eyes. When the electrolyte touches your skin or splashes into your eyes, wash your eyes with clean water immediately and consult a doctor.
- If there is a case of battery deformation, color change, or abnormal heating while you charge or store the battery, remove the battery immediately and stop using it. Otherwise, it may lead to battery leakage, overheating, explosion, or fire.

- If the power cable is damaged (for example, the cord is exposed or broken), or the plug loosens, stop using the cable at once. Otherwise, it may lead to an electric shock, a short circuit of the charger, or a fire.
- Do not dispose of batteries in fire as they may explode. Batteries may also explode if damaged.
- Do not modify or remanufacture, attempt to insert foreign objects into the battery, immerse or expose to water or other liquids, expose to fire, explosion or other hazard.
- Avoid dropping the device or battery. If the device or battery is dropped, especially on a hard surface, and the user suspects damage, take it to a qualified service center for inspection.
- Improper battery use may result in a fire, explosion or other hazard.
- Promptly dispose of used batteries in accordance with local regulations.
- The device should only be connected to products that bear the USB-IF logo or have completed the USB-IF compliance program.

Cleaning and Maintenance

- The device, battery, and charger are not water-resistant. Keep them dry. Protect the device, battery, and charger from water or vapor. Do not touch the device or the charger with a wet hand. Otherwise, it may lead to a short circuit, a malfunction of the device, and an electric shock to the user.
- Do not place your device, battery, and charger in places where they can get damaged because of collision. Otherwise, it may lead to battery leakage, device malfunction, overheating, fire, or explosion.
- Do not place magnetic storage media such as magnetic cards and floppy disks near the device. Radiation from the device may erase the information stored on them.
- Do not leave your device, battery, and charger in a place with an extreme high or low temperature. Otherwise, they may not function properly and may lead to a fire or an explosion. When the temperature is lower than 0°C, performance of the battery is affected.
- Do not place sharp metal objects such as pins near the earpiece. The earpiece may attract these objects and hurt you when you are using the device.

- Before you clean or maintain the device, power off the device and disconnect it from the charger.
- Do not use any chemical detergent, powder, or other chemical agents (such as alcohol and benzene) to clean the device and the charger. Otherwise, parts of the device may be damaged or a fire can be caused. You can clean the device and the charger with a piece of damp and soft antistatic cloth.
- Do not dismantle the device or accessories. Otherwise, the warranty on the device and accessories is invalid and the manufacturer is not liable to pay for the damage.
- If the device screen is broken by colliding with hard objects, do not touch or try to remove the broken part. In this case, stop using the device immediately, and then contact an authorized service center in time.

Emergency Call

You can use your device for emergency calls in the service area. The connection, however, cannot be guaranteed in all conditions. You should not rely solely on the device for essential communications.

Certification Information (SAR)

This device meets guidelines for exposure to radio waves.

Your device is a low-power radio transmitter and receiver. As recommended by international guidelines, the device is designed not to exceed the limits for exposure to radio waves. These guidelines were developed by the independent scientific organization International Commission on Non-Ionizing Radiation Protection (ICNIRP) and include safety measures designed to ensure safety for all users, regardless of age and health.

The Specific Absorption Rate (SAR) is the unit of measurement for the amount of radio frequency energy absorbed by the body when using a device. The SAR value is determined at the highest certified power level in laboratory conditions, but the actual SAR level of the device when being operated can be well below the value. This is because the device is designed to use the minimum power required to reach the network.

The SAR limit also adopted by Europe is 2.0 W/kg averaged over 10 grams of tissue. The highest SAR value for this device type when tested at the ear is 0.576 W/kg, and when properly worn on the body is 0.746 W/kg.

Disposal and Recycling Information



This symbol on the device (and any included batteries) indicates that they should not be disposed of as normal household garbage. Do not dispose of your device or batteries as unsorted municipal waste. The device (and any batteries) should be handed over to a certified collection point for recycling or proper disposal at the end of their life.

For more detailed information about the recycling of the device or batteries, contact your local city office, the household waste disposal service, or the retail store where you purchased this device.

The disposal of this device is subject to the Waste from Electrical and Electronic Equipment (WEEE) directive of the European Union. The reason for separating WEEE and batteries from other waste is to minimize the potential environmental impacts on human health of any hazardous substances that may be present.

Reduction of Hazardous Substances

This device is compliant with the EU Registration, Evaluation, Authorisation and Restriction of Chemicals (REACH) Regulation (Regulation No 1907/2006/EC of the European Parliament and of the Council) and the EU Restriction of Hazardous Substances (RoHS) Directive (Directive 2002/95/EC of the European Parliament and of the Council). For more information about the REACH compliance of the device, visit the Web site www.huaweidevice.com/certification. You are recommended to visit the Web site regularly for up-to-date information.

EU Regulatory Conformance

Hereby, Huawei Technologies Co., Ltd. declares that this device is in compliance with the essential requirements and other relevant provisions of Directive 1999/5/EC. For the declaration of conformity, visit the Web site www.huaweidevice.com/certification.

CE 0197 !

ⓘ Observe the national local regulations in the location where the device is to be used. This device may be restricted for use in some or all member states of the European Union (EU).

ⓘ This device may be operated in all member states of the EU.

France: Outdoor use limited to 10 mW e.i.r.p. within the band 2454-2483.5 MHz.

Italy: For private use, a general authorisation is required if WAS/RLAN's are used outside own premises. For public use, a general authorisation is required.

Luxembourg: General authorisation required for network and service supply.

Norway: This subsection does not apply for the geographical area within a radius of 20 km from the centre of Ny-Ålesund.

Industry Canada Compliance

This device complies with Industry Canada. This device with the Class B limits for radio noise emissions as set out in the interference causing standard entitled "Digital Apparatus" (ICES-003) of Industry Canada. Cet appareil numérique de la classe B est conforme à la norme NMB-003 du Canada.

In the United States and Canada,. The standard incorporates a substantial margin of safety to give additional protection for the public and to account for any variations in measurements.

This device complies with Industry Canada licence-exempt RSS standard(s).

Operation is subject to the following two conditions: (1) this device may not cause interference, and (2) this device must accept any interference, including interference that may cause undesired operation of the device.

Le présent appareil est conforme aux CNR d'Industrie Canada applicables aux appareils radio exempts de licence. L'exploitation est autorisée aux deux conditions suivantes : (1) l'appareil ne doit pas produire de brouillage, et (2) l'utilisateur de l'appareil doit accepter tout brouillage radioélectrique subi, même si le brouillage est susceptible d'en compromettre le fonctionnement.

THIS DOCUMENT IS FOR INFORMATION PURPOSE ONLY, AND DOES NOT
CONSTITUTE ANY KIND OF WARRANTIES.

All the pictures in this guide are for your reference only. The actual
appearance and display features depend on the mobile phone you purchase.

V100R001_01