



**NXL HVAC & COMPACT
USER'S MANUAL**

AT LEAST THE 11 FOLLOWING STEPS OF THE *START-UP QUICK GUIDE* MUST BE PERFORMED DURING THE INSTALLATION AND COMMISSIONING.

IF ANY PROBLEMS OCCUR, PLEASE CONTACT YOUR LOCAL DISTRIBUTOR.

Start-up Quick Guide

1. Check that the delivery corresponds to your order, see Chapter 3.
2. Before taking any commissioning actions read carefully the safety instructions in Chapter 1.
3. Before the mechanical installation, check the minimum clearances around the unit and check the ambient conditions in Chapter 5.
4. Check the size of the motor cable, mains cable, mains fuses and check the cable connections, read Chapter 6.
5. Follow the installation instructions, see Chapter 5.
6. Control cable sizes and the grounding system are explained in Chapter 6.1.1.
7. Instructions on using the keypad are given in Chapter 7.
8. All parameters have factory default values. In order to ensure proper operation, check the rating plate data for the values below and the corresponding parameters of parameter group P2.1. See Chapter 8.3.3. In all cases Honeywell NXL start up wizard is recommended to ensure easy commissioning.

- nominal speed of the motor, par 2.1.7 (2.1.8 in NXL Compact)
- nominal current of the motor, par. 2.1.6 (2.1.9 in NXL Compact)

The following motor parameters need adjusting only if the motor voltage is different from 400 V or the equipment is installed to a electrical network which does not have the frequency of 50 Hz (e.g. North America 60 Hz).

- nominal voltage of the motor, par. 2.1.11 (2.1.6 in NXL Compact)
- nominal frequency of the motor, par. 2.1.12 (2.1.7 in NXL Compact)

All parameters are explained in the Application Manuals.

9. Follow the commissioning instructions, see Chapter 8.
10. The Honeywell NXL Frequency Converter is now ready for use.
11. In the end of this manual, you will find a quick help with the default I/O, control panel menus, monitoring values, fault codes and basic parameters

Honeywell is not responsible for the use of the frequency converters against the instructions.

CONTENTS

NXL HVAC & COMPACT USER'S MANUAL

INDEX

1	SAFETY
2	EU DIRECTIVE
3	RECEIPT OF DELIVERY
4	TECHNICAL DATA
5	INSTALLATION
6	CABLING AND CONNECTIONS
7	CONTROL KEYPAD
8	COMMISSIONING
9	FAULT TRACING
10	DESCRIPTION OF BOARD NXLOPTAA
11	DESCRIPTION OF BOARD NXLOPTAI
12	NXL HVAC BASIC SPEED CONTROL

OTHER NXL MANUALS:

NXL HVAC APPLICATION MANUAL

Programming Manual for NXL HVAC drives

MULTICONTROL APPLICATION MANUAL

Programming Manual for standard NXL and NXL Compact.

ABOUT THE NXL HVAC & COMPACT USER'S MANUAL AND NXL APPLICATION MANUALS

Congratulations for choosing the Smooth Control provided by NXL frequency converters!

The User's Manual will provide you with the necessary information about the installation, commissioning and operation of NXL Frequency Converter. We recommend that you carefully study these instructions before powering up the frequency converter for the first time.

In the NXL HVAC Application Manual and the Multi-Control Application Manual you will find information about the application used in Honeywell NXL drives.

NXL HVAC & COMPACT User's Manual



Index

Date: 28.10.2008



1.	SAFETY	7
1.1	Warnings	7
1.2	Safety instructions.....	7
1.3	Earthing and earth fault protection	8
1.4	Running the motor	8
2.	EU DIRECTIVE	9
2.1	CE marking	9
2.2	EMC directive	9
2.2.1	General	9
2.2.2	Technical criteria	9
2.2.3	NXL frequency converter EMC classification	9
2.2.4	Honeywell EMC classes and market requirements.....	10
2.2.5	Manufacturer's declaration of conformity	10
3.	RECEIPT OF DELIVERY	13
3.1	Type designation code NXL Compact.....	13
3.2	Type designation code NXL HVAC	14
3.3	Storage	14
3.4	Maintenance	14
3.5	Warranty	15
4.	TECHNICAL DATA	16
4.1	Introduction	16
4.2	Power ratings.....	18
4.2.1	NXL Compact – Mains voltage 208 – 240 V & 380 – 500 V	18
4.2.1	NXL HVAC – Mains voltage 380 – 500 V	19
4.3	Technical data	20
5.	INSTALLATION	22
5.1	Mounting.....	22
5.1.1	NXL Compact (MF2 and MF3).....	22
5.1.2	NXL HVAC (MF4 – MF6).....	25
5.2	Cooling	26
5.3	Changing EMC protection class from H/C to T in NXL HVAC	27
6.	CABLING AND CONNECTIONS	28
6.1	Power connections.....	28
6.1.1	Cabling.....	29
6.1.1.1	Cable and fuse sizes	30
6.1.2	Mounting of cable accessories	31
6.1.3	Installation instructions	33
6.1.3.1	Stripping lengths of motor and mains cables	34
6.1.3.2	Installation of cables to NXL	35
6.1.4	Cable installation and the UL standards	42
6.1.5	Cable and motor insulation checks.....	42
6.2	Control unit	43
6.2.1	NXL Compact (MF2 – MF3)	43
6.2.2	NXL HVAC (MF4 – MF6).....	43
6.2.2.1	Allowed option boards in NXL HVAC:.....	43
6.2.3	Control connections.....	44
6.2.4	Control I/O.....	45

6.2.5	Control terminal signals.....	46
6.2.5.1	Jumper selections on NXL basic board.....	47
6.2.6	Motor thermistor (PTC) connection.....	50
7.	CONTROL KEYPAD.....	51
7.1	Indications on the Keypad display.....	51
7.1.1	Drive status indications.....	51
7.1.2	Control place indications.....	52
7.1.3	Numeric indications.....	52
7.2	Keypad push-buttons.....	53
7.2.1	Button descriptions.....	53
7.3	Start-up wizard.....	54
7.4	Navigation on the control keypad.....	55
7.4.1	Monitoring menu (M1).....	58
7.4.2	Parameter menu (P2).....	60
7.4.3	Keypad control menu (K3).....	62
7.4.3.1	Selection of control place.....	62
7.4.3.2	Keypad reference.....	63
7.4.3.3	Keypad direction.....	63
7.4.3.4	Stop button activation.....	63
7.4.4	Active faults menu (F4).....	64
7.4.4.1	Fault types.....	64
7.4.5	Fault codes.....	65
7.4.6	Fault history menu (H5).....	67
7.4.7	System menu (S6).....	68
7.4.7.1	Copy parameters.....	70
7.4.7.2	Security.....	70
7.4.7.3	Keypad settings.....	71
7.4.7.4	Hardware settings.....	72
7.4.7.5	System information.....	73
7.4.7.6	AI mode.....	76
7.4.8	Modbus interface.....	77
7.4.8.1	Modbus RTU protocol.....	77
7.4.8.2	Termination Resistor.....	78
7.4.8.3	Modbus address area.....	78
7.4.8.4	Modbus process data.....	78
7.4.8.5	Fieldbus parameters.....	80
7.4.9	Expander board menu (E7).....	81
7.5	Further keypad functions.....	81
8.	COMMISSIONING.....	82
8.1	Safety.....	82
8.2	Commissioning of the frequency converter.....	82
8.3	Basic parameters.....	85
8.3.1	Monitoring values (Control keypad: menu M1).....	85
8.3.2	HVAC parameters in NXL HVAC (Control keypad: Menu P2 → B2.1).....	86
8.3.3	Basic parameters (Control keypad: Menu P2 → B2.1 / B2.1.15).....	87
9.	FAULT TRACING.....	88
10.	DESCRIPTION OF EXPANDER BOARD NXLOPTAA.....	92
11.	DESCRIPTION OF EXPANDER BOARD NXLOPTAI.....	93
12.	NXL HVAC Basic Speed Control – Quick SETUP.....	95

1. SAFETY

 **ONLY A COMPETENT ELECTRICIAN MAY CARRY OUT THE ELECTRICAL INSTALLATION** 

1.1 Warnings

 WARNING  HOT SURFACE	1	The components of the power unit of the frequency converter are live when NXL is connected to mains potential. Coming into contact with this voltage is extremely dangerous and may cause death or severe injury. The control unit is isolated from the mains potential.
	2	The motor terminals U, V, W (T1, T2, T3) and the DC-link/brake resistor terminals -/+ (in NXL ≥1.1 kW) are live when NXL is connected to mains, even if the motor is not running.
	3	The control I/O-terminals are isolated from the mains potential. However, the relay outputs and other I/O-terminals may have a dangerous control voltage present even when NXL is disconnected from mains.
	4	The frequency converter has a large capacitive leakage current.
	5	If the frequency converter is used as a part of a machine, the machine manufacturer is responsible for providing the machine with a main switch (EN 60204-1).
	6	Only spare parts delivered by Honeywell can be used.
	7	The heat sink of types MF2 and MF3 may be hot when the frequency converter is in use. Coming into contact with the heat sink may cause burns.

1.2 Safety instructions

	1	The Honeywell NXL frequency converter is meant for fixed installations only.
	2	Do not perform any measurements when the frequency converter is connected to the mains.
	3	After disconnecting the frequency converter from the mains, wait until the fan stops and the indicators on the display go out. Wait 5 more minutes before doing any work on NXL connections.
	4	Do not perform any voltage withstand tests on any part of NXL. There is a certain procedure according to which the tests shall be performed. Ignoring this procedure may result in damaged product.
	5	Prior to measurements on the motor or the motor cable, disconnect the motor cable from the frequency converter.
	6	Do not touch the IC-circuits on the circuit boards. Static voltage discharge may damage the components.

1.3 Earthing and earth fault protection

The Honeywell NXL frequency converter must always be earthed with an earthing conductor connected to the earthing terminal 

The earth fault protection inside the frequency converter protects only the converter itself against earth faults in the motor or the motor cable.

Due to the high capacitive currents present in the frequency converter, fault current protective switches may not function properly. If fault current protective switches are used they must be tested with the drive with earth fault currents that are possible to arise in fault situations.

1.4 Running the motor

Warning symbols

For your own safety, please pay special attention to the instructions marked with the following symbols:



= **Dangerous voltage**



WARNING

= **General warning**



HOT SURFACE

= **Hot surface – Risk of burn**

MOTOR RUN CHECK LIST

 WARNING	1	Before starting the motor, check that the motor is mounted properly and ensure that the machine connected to the motor allows the motor to be started.
	2	Set the maximum motor speed (frequency) according to the motor and the machine connected to it.
	3	Before reversing the motor shaft rotation direction make sure that this can be done safely.
	4	Make sure that no power correction capacitors are connected to the motor cable.
	5	Make sure that the motor terminals are not connected to mains potential.

2. EU DIRECTIVE

2.1 CE marking

The CE marking on the product guarantees the free movement of the product within the EEA (European Economic Area). It also guarantees that the product meets the various requirements placed upon it (such as the EMC Directive and possibly other directives according to the so-called new procedure).

NXL frequency converters carry the CE label as a proof of compliance with the Low Voltage Directive (LVD) and the Electro Magnetic Compatibility (EMC). The company SGS FIMKO has acted as the Competent Body.

2.2 EMC directive

2.2.1 General

The EMC Directive provides that the electrical apparatus must not excessively disturb the environment they are used in, and, on the other hand, it shall have an adequate level of immunity toward other disturbances from the same environment.

The compliance of NXL frequency converters with the EMC directive is verified with Technical Construction Files (TCF) checked and approved by SGS FIMKO, which is a Competent Body.

2.2.2 Technical criteria

EMC compliance is a major consideration for NXL drives from the outset of the design. NXL frequency converters are marketed throughout the world, a fact which makes the EMC requirements of customers different. All NXL frequency converters are designed to fulfil even the strictest immunity requirements.

2.2.3 NXL frequency converter EMC classification

NXL frequency converters are divided into two classes according to the level of electromagnetic disturbances emitted. Later in this manual the division is made according to the mechanical sizes (MF2, MF3, etc.). The technical data of the different sizes can be found in Chapter 0.

Class C (NXL HVAC IP54):

NXL HVAC drives with IP54 enclosure are delivered as class C products with an integrated RFI filter. NXL HVAC drives IP54 selection **fulfil the requirements of the product standard EN 61800-3 (2004) category C1 (EN 55011 class B)**.

The emission levels correspond to the requirements of EN 61000-6-3.

Class N (NXL Compact):

No EMC emission protection. **NXL Compact** drives (frames MF2 and MF3) are delivered from the factory without an integrated RFI filter as class N products. External RFI filters for these products for **class H** are available.

Class H (NXL HVAC IP21):

NXL HVAC drives with IP21 enclosure are delivered as class H products with an integrated RFI filter. NXL HVAC drives IP21 selection **fulfil the requirements of the product standard EN 61800-3 (2004) category C2 (EN 55011 class A)**.

The emission levels correspond to the requirements of EN 61000-6-4.

Class T:

The T-class converters have a small earth current and can be used with IT supplies only. If they are used with other supplies no EMC requirements are complied with.

All NX frequency converters fulfil all EMC immunity requirements (standards EN 61000-6-1, 61000-6-2 and EN 61800-3).

2.2.4 Honeywell EMC classes and market requirements

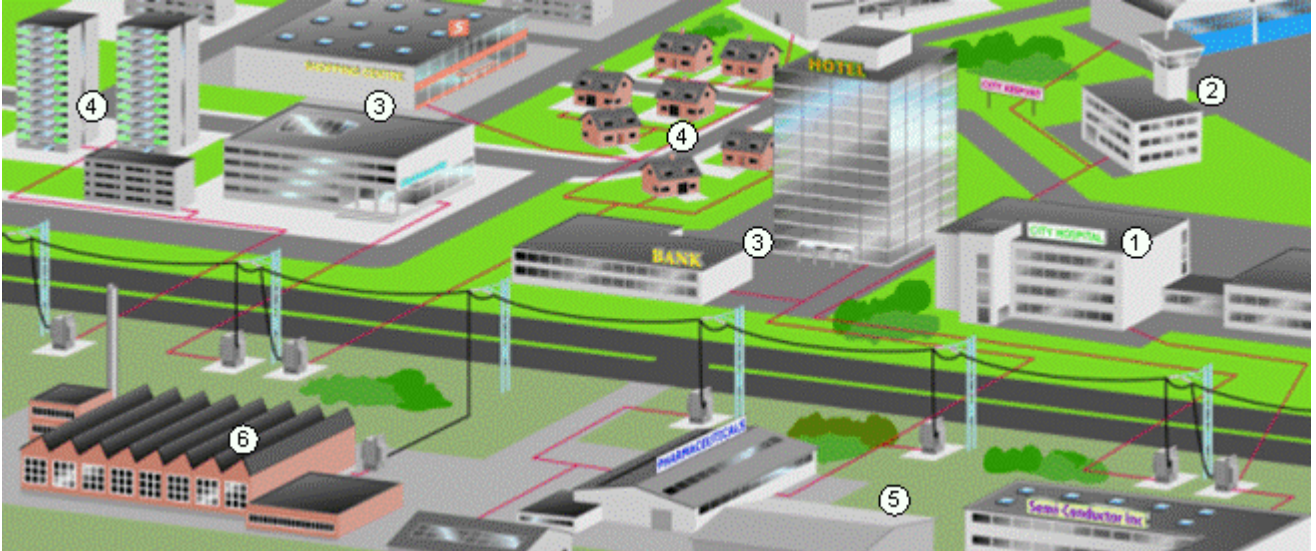

NX EMC levels	Hospital	Airport	Residential Area	Commercial	Light Industry Area	Heavy Industry
C	O	O				
H	R	R	R	R	O	O
L					R	R
T						R (IT Network)

O = Optional, R= Required

2.2.5 Manufacturer's declaration of conformity

The following page presents the photocopy of the Manufacturer's Declaration of Conformity assuring the compliance of frequency converters with the EMC-directives.

EU DECLARATION OF CONFORMITY

We

Manufacturer's name: Vacon Oyj
Manufacturer's address: P.O.Box 25
Runsorintie 7
FIN-65381 Vaasa
Finland

hereby declare that the product

Product name: NXL Frequency Converter
Model designation: NXL 0001 V3 5...to 0061 V3 5...
NXL 0002 V3 2...to 0006 V3 2...

has been designed and manufactured in accordance with the following standards:

Safety: EN 50178 (1997), EN 60204-1 (1996)
EN 60950 (3rd edition 2000, as relevant)

EMC: EN 61800-3 (1996)+A11(2000), EN 61000-6-2
(2001), EN 61000-6-4 (2001)

and conforms to the relevant safety provisions of the Low Voltage Directive (73/23/EEC) as amended by the Directive (93/68/EEC) and EMC Directive 89/336/EEC as amended by 92/31/EEC.

It is ensured through internal measures and quality control that the product conforms at all times to the requirements of the current Directive and the relevant standards.

In Vaasa, 6th of September, 2002

Vesa Laisi
President

The year the CE marking was affixed: 2002

EU DECLARATION OF CONFORMITY

We

Manufacturer's name: Vacon Oyj
Manufacturer's address: P.O.Box 25
Runsorintie 7
FIN-65381 Vaasa
Finland

hereby declare that the product

Product name: NXL HVAC DRIVE
Model designation: HVAC03C... to HVAC61C...

has been designed and manufactured in accordance with the following standards:

Safety: EN 50178 (1997), EN 60204-1 (1996)
EN 60950 (3rd edition 2000, as relevant)

EMC: EN 61800-3 (1996)+A11(2000), EN 61000-6-2
(2001), EN 61000-6-4 (2001)

and conforms to the relevant safety provisions of the Low Voltage Directive (73/23/EEC) as amended by the Directive (93/68/EEC) and EMC Directive 89/336/EEC as amended by 92/31/EEC.

It is ensured through internal measures and quality control that the product conforms at all times to the requirements of the current Directive and the relevant standards.

In Vaasa, 10th of May, 2006



Vesa Laisi
President

The year the CE marking was affixed: 2002

3. RECEIPT OF DELIVERY

NXL frequency converters have undergone scrupulous tests and quality checks at the factory before they are delivered to the customer. However, after unpacking the product, check that no signs of transport damages are to be found on the product and that the delivery is complete (compare the type designation of the product to the code below).

Should the drive have been damaged during the shipping, please contact primarily the cargo insurance company or the carrier.

If the delivery does not correspond to your order, contact the supplier immediately.

3.1 Type designation code NXL Compact

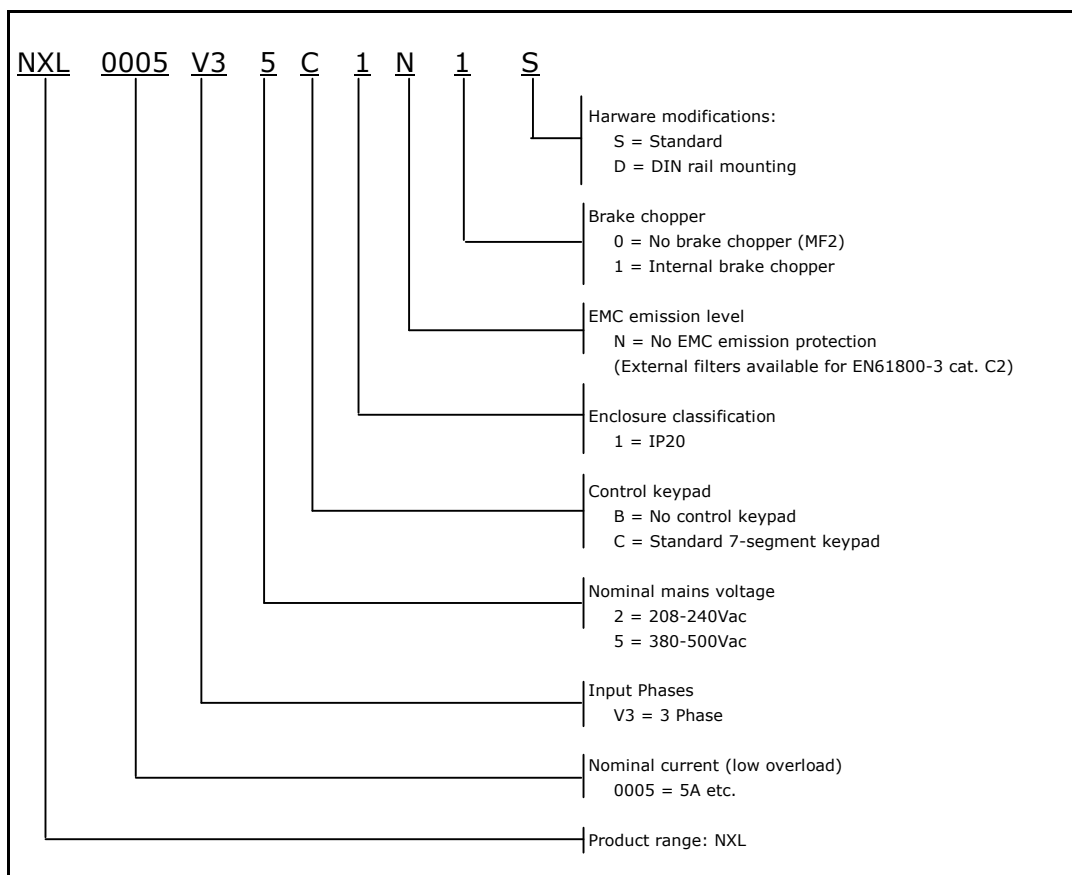

Figure 3-1. NXL Compact type designation code for sizes MF2 and MF3

3.2 Type designation code NXL HVAC

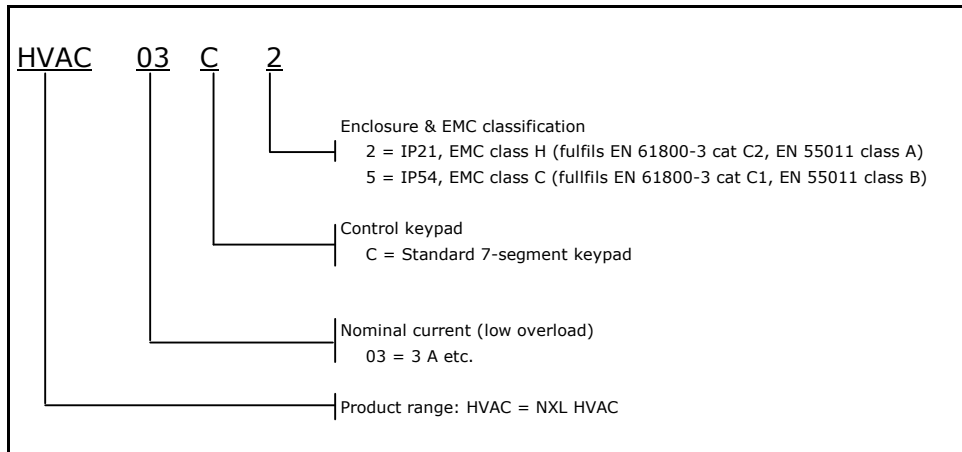

Figure 3-2. NXL HVAC type designation code for (sizes MF4 - MF6).

3.3 Storage

If the frequency converter is to be kept in store before use make sure that the ambient conditions are acceptable:

Storing temperature	-40...+70°C
Relative humidity	<95%, no condensation

3.4 Maintenance

In normal conditions, NXL frequency converters are maintenance-free. However, we recommend to clean the heatsink (using e.g. a small brush) whenever necessary.

Most NXL drives are equipped with a cooling fan, which can easily be changed if necessary.

3.5 Warranty

Only manufacturing defects are covered by the warranty. The manufacturer assumes no responsibility for damages caused during or resulting from transport, receipt of the delivery, installation, commissioning or use.

The manufacturer shall in no event and under no circumstances be held responsible for damages and failures resulting from misuse, wrong installation, unacceptable ambient temperature, dust, corrosive substances or operation outside the rated specifications. Neither can the manufacturer be held responsible for consequential damages.

Honeywell's time of warranty is 30 months from the delivery or 24 months from the commissioning whichever expires first.

The local distributor may grant a warranty time different from the above. This warranty time shall be specified in the distributor's sales and warranty terms. Honeywell assumes no responsibility for any other warranties than that granted by Honeywell itself.

In all matters concerning the warranty, please contact first your distributor.

4. TECHNICAL DATA

4.1 Introduction

Honeywell NXL is a compact frequency converter with the output ranging from 250 W to 30 kW.

The Motor and Application Control Block is based on microprocessor software. The microprocessor controls the motor basing on the information it receives through measurements, parameter settings, control I/O and control keypad. The IGBT Inverter Bridge produces a symmetrical, 3-phase PWM-modulated AC-voltage to the motor.

The control keypad constitutes a link between the user and the frequency converter. The control keypad is used for parameter setting, reading status data and giving control commands. Instead of the control keypad, also a PC can be used to control the frequency converter if connected through a cable and a serial interface adapter (optional equipment).

You can have your Honeywell NXL drive equipped with control I/O boards NXLOPTAA, NXLOPTAI, NXOPTB_ or NXOPTC_. Honeywell NXL HVAC series already includes I/O board NXLOPTAI as standard.

All other sizes but MF2 have an internal brake chopper. For closer information, contact Honeywell (see back cover). The input EMC filters are available as options externally for MF2 and MF3. In other sizes the filters are internal and included as standard.

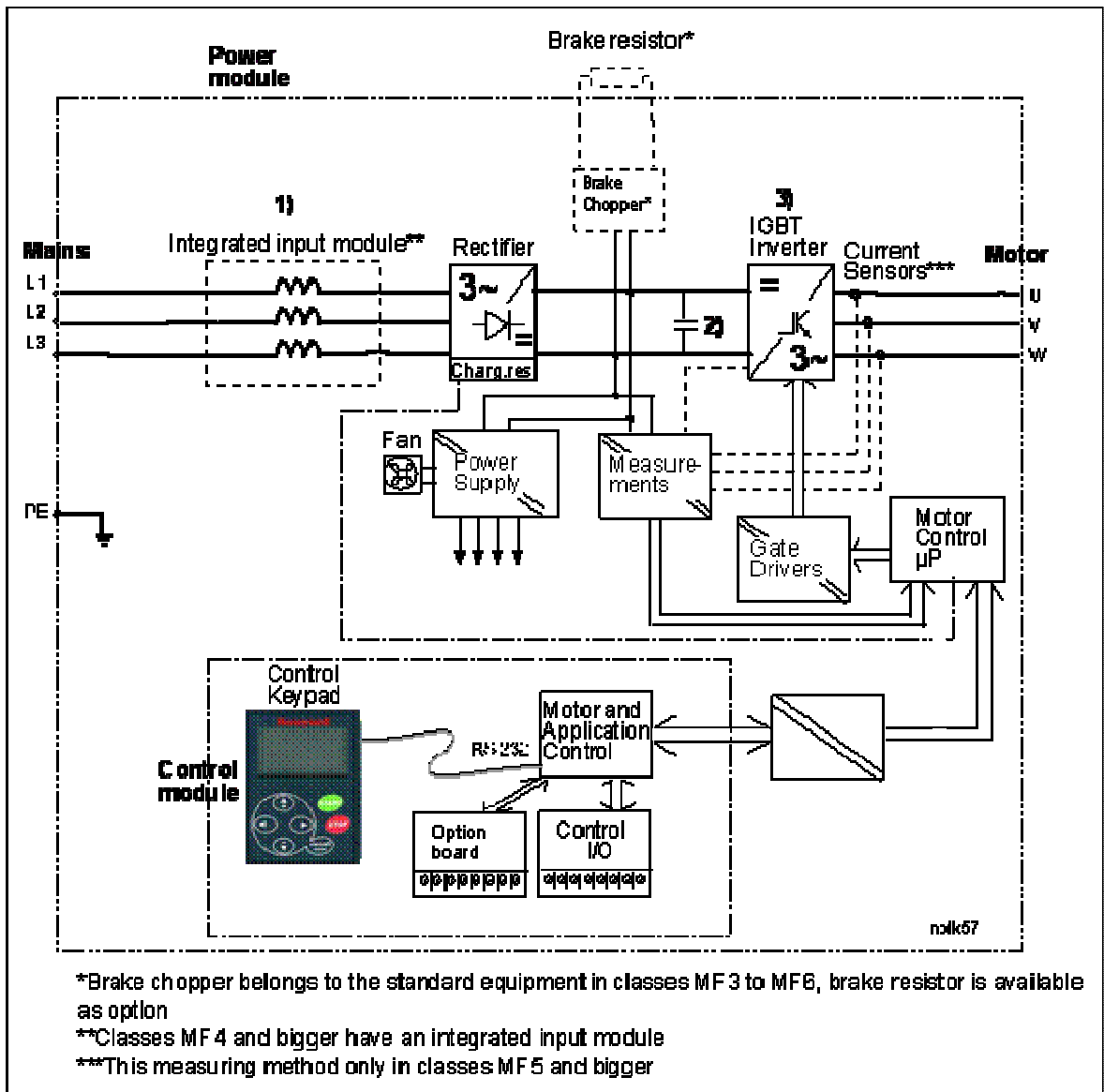

Figure 4-1. NXL block diagram

4.2 Power ratings

4.2.1 NXL Compact – Mains voltage 208 – 240 V & 380 – 500 V

Mains voltage 208-240 V, 50/60 Hz, 1~/3~ Series NXL Compact											
Frequency converter type		Loadability				Motor shaft power		Nominal input current 1~/3~	Mechanical size Enclosure and protection class	Dimensions WxHxD	Weight (kg)
		Low		High		Low	High				
		Rated continuous current I _L (A)	10% overload current (A)	Rated continuous current I _H (A)	50% overload current (A)	40°C P(kW)	50°C P(kW)				
EMC-level N	NXL 0002 2	2,4	2,6	1,7	2,6	0,37	0,25	4,8/--	MF2/IP20	60x130x150	1,0
	NXL 0003 2	3,7	4,1	2,8	4,2	0,75	0,55	7,4/5,6	MF3/IP20	84x184x172	1,9
	NXL 0004 2	4,8	5,3	3,7	5,6	1,1	0,75	9,6/7,2	MF3/IP20	84x184x172	1,9
	NXL 0006 2	6,6	7,3	4,8	7,2	1,5	1,1	13,2/9,9	MF3/IP20	84x220x172	2,0

Table 4-1. Power ratings and dimensions of NXL, supply voltage 208-240V.

NOTE! NXL 0002 2 is suitable for single phase supply only

Mains voltage 380-500 V, 50/60 Hz, 3~ Series NXL Compact													
Frequency converter type		Loadability				Motor shaft power				Nominal input current	Mechanical size Enclosure and protection class	Dimensions WxHxD	Weight (kg)
		Low		High		400V supply		500V supply					
		Rated continuous current I _L (A)	10% overload current (A)	Rated continuous current I _H (A)	50% overload current (A)	10% overload 40°C P(kW)	50% overload 50°C P(kW)	10% overload 40°C P(kW)	50% overload 50°C P(kW)				
EMC-level N	NXL 0001 5	1,9	2,1	1,3	2	0,55	0,37	0,75	0,55	2,9	MF2/IP20	60x130x150	1,0
	NXL 0002 5	2,4	2,6	1,9	2,9	0,75	0,55	1,1	0,75	3,6	MF2/IP20	60x130x150	1,0
	NXL 0003 5	3,3	3,6	2,4	3,6	1,1	0,75	1,5	1,1	5,0	MF3/IP20	84x220x172	2,0
	NXL 0004 5	4,3	4,7	3,3	5	1,5	1,1	2,2	1,5	6,5	MF3/IP20	84x220x172	2,0
	NXL 0005 5	5,4	5,9	4,3	6,5	2,2	1,5	3	2,2	8,1	MF3/IP20	84x220x172	2,0

Table 4-2. Power ratings and dimensions of NXL, supply voltage 380-500V.

4.2.1 NXL HVAC – Mains voltage 380 – 500 V

Mains voltage 380-500 V, 50/60 Hz, 3~ Series NXL HVAC												
Frequency converter type	Loadability				Motor shaft power				Mechanical size Enclosure and protection class	Dimensions WxHxD	Weight (kg)	
	Low		High		400V supply		500V supply					
	Rated continuous current I _L (A)	10% over-load current (A)	Rated continuous current I _H (A)	50% over-load current (A)	10% over-load 45°C P(kW)	50% over-load 50°C P(kW)	10% over-load 45°C P(kW)	50% over-load 50°C P(kW)				
EMC-level H	HVAC03C2	3,3	3,6	2,2	3,3	1,1	0,75	1,5	1,1	MF4/IP21	128x292x190	5
	HVAC04C2	4,3	4,7	3,3	5,0	1,5	1,1	2,2	1,5	MF4/IP21	128x292x190	5
	HVAC05C2	5,6	5,9	4,3	6,5	2,2	1,5	3	2,2	MF4/IP21	128x292x190	5
	HVAC07C2	7,6	8,4	5,6	8,4	3	2,2	4	3	MF4/IP21	128x292x190	5
	HVAC09C2	9	9,9	7,6	11,4	4	3	5,5	4	MF4/IP21	128x292x190	5
	HVAC12C2	12	13,2	9	13,5	5,5	4	7,5	5,5	MF4/IP21	128x292x190	5
	HVAC16C2	16	17,6	12	18	7,5	5,5	11	7,5	MF5/IP21	144x391x214	8,1
	HVAC23C2	23	25,3	16	24	11	7,5	15	11	MF5/IP21	144x391x214	8,1
	HVAC31C2	31	34	23	35	15	11	18,5	15	MF5/IP21	144x391x214	8,1
	HVAC38C2	38	42	31	47	18,5	15	22	18,5	MF6/IP21	195x519x237	18,5
	HVAC46C2	46	51	38	57	22	18,5	30	22	MF6/IP21	195x519x237	18,5
HVAC61C2	61	67	46	69	30	22	37	30	MF6/IP21	195x519x237	18,5	

EMC-level C	HVAC03C5	3,3	3,6	2,2	3,3	1,1	0,75	1,5	1,1	MF4/IP54	128x292x190	5
	HVAC04C5	4,3	4,7	3,3	5,0	1,5	1,1	2,2	1,5	MF4/IP54	128x292x190	5
	HVAC05C5	5,6	5,9	4,3	6,5	2,2	1,5	3	2,2	MF4/IP54	128x292x190	5
	HVAC07C5	7,6	8,4	5,6	8,4	3	2,2	4	3	MF4/IP54	128x292x190	5
	HVAC09C5	9	9,9	7,6	11,4	4	3	5,5	4	MF4/IP54	128x292x190	5
	HVAC12C5	12	13,2	9	13,5	5,5	4	7,5	5,5	MF4/IP54	128x292x190	5
	HVAC16C5	16	17,6	12	18	7,5	5,5	11	7,5	MF5/IP54	144x391x214	8,1
	HVAC23C5	23	25,3	16	24	11	7,5	15	11	MF5/IP54	144x391x214	8,1
	HVAC31C5	31	34	23	35	15	11	18,5	15	MF5/IP54	144x391x214	8,1
	HVAC38C5	38	42	31	47	18,5	15	22	18,5	MF6/IP54	195x519x237	18,5
	HVAC46C5	46	51	38	57	22	18,5	30	22	MF6/IP54	195x519x237	18,5
HVAC61C5	61	67	46	69	30	22	37	30	MF6/IP54	195x519x237	18,5	

Table 4-3. Power ratings and dimensions of NXL HVAC, supply voltage 380 – 500V.

4.3 Technical data

Mains connection	Input voltage U_{in}	380 - 500V, -15%...+10% 3~ 208...240V, -15%...+10% 3~ 208...240V, -15%...+10% 1~
	Input frequency	45...66 Hz
	Connection to mains	Once per minute or less (normal case)
Motor connection	Output voltage	0— U_{in}
	Continuous output current	I_L : Ambient peak temperature max. +45°C (with 24h average ambient +40°C),* overload 1.1 x I_L (1min/10min) I_H : Ambient temperature max. +50°C, overload 1.5 x I_H (1min/10min)
	Starting torque	150% (Low overload); 200% (High overload)
	Starting current	2 x I_H 2 seconds every 20 seconds, if output frequency <30Hz and temperature of heatsink <+60°C
	Output frequency	0...320 Hz
	Frequency resolution	0,01 Hz
	Control characteristics	Control method
Switching frequency (See parameter 2.6.8)		1...16 kHz; Factory default 6 kHz
<u>Frequency reference</u>		
Analogue input		Resolution 0.1% (10bit), accuracy ±1%
Keypad reference		Resolution 0.01 Hz
Field weakening point		30...320 Hz
Acceleration time		0.1...3000 sec
Deceleration time		0.1...3000 sec
Braking torque		DC-brake: 30%*TN (without brake option)
Ambient conditions		Ambient operating temperature
	Storage temperature	-40°C...+70°C
	Relative humidity	0...95% RH, non-condensing, non-corrosive, no dripping water
	Air quality: - chemical vapours - mechanical particles	IEC 721-3-3, unit in operation, class 3C2 IEC 721-3-3, unit in operation, class 3S2
	Altitude	100% load capacity (no derating) up to 1000m 1-% derating for each 100m above 1000m; max. 3000m
	Vibration: EN50178/EN60068-2-6	5...150 Hz Displacement amplitude 1(peak) mm at 5...15.8 Hz Max acceleration amplitude 1 G at 15.8...150 Hz
	Shock EN50178, IEC 68-2-27	UPS Drop Test (for applicable UPS weights) Storage and shipping: max 15 G, 11 ms (in package)
	Enclosure class	IP20; MF2 and MF3. IP21/IP54; MF4 – MF6

Technical data (continues on next page)

* In NXL Compact the maximum ambient operation temperature is +40°C. (+45°C only applies to NXL HVAC)

EMC	Immunity	Complies with EN50082-1, -2, EN61800-3
	Emissions	<u>MF2-MF3</u> : EMC level N; With an external RFI filter (option) attached EMC-level H (see Ch. 6.1.2.2) <u>MF4-MF6</u> : IP21 : EMC-level H: EN 61800-3 (2004) Cat C2, EN 55011 Class A IP54 : EMC level C: EN 61800-3 (2004) Cat C1, EN 55011 Class B
Safety		EN50178, EN60204-1, CE, UL, cUL, FI, GOST R, IEC 61800-5 (see unit nameplate for more detailed approvals)
Control connections	Analogue input voltage	0...+10V, $R_i = 200k\Omega$, Resolution 10 bit, accuracy $\pm 1\%$
	Analogue input current	0(4)...20 mA, $R_i = 250\Omega$ differential
	Digital inputs	3 positive logic; 18...24VDC NXL Compact 6 positive logic; 18...24VDC NXL HVAC
	Auxiliary voltage	+24V, $\pm 15\%$, max. 100mA
	Output reference voltage	+10V, +3%, max. load 10mA
	Analogue output	0(4)...20mA; R_L max. 500 Ω ; resolution 16 bit; accuracy $\pm 1\%$
	Relay outputs	1 programmable change over relay output NXL Compact 2 programmable change over relay output NXL HVAC Switching capacity: 24VDC/8A, 250VAC/8A, 125VDC/0.4A
	Motor thermistor Input *)	$R_{trip} = 4.7 k\Omega$ (PTC) NXL HVAC
Protections	Overvoltage protection	NXL_2 : 437VDC; NXL_5 : 911VDC
	Undervoltage protection	NXL_2 : 183VDC; NXL_5 : 333VDC
	Earth-fault protection	In case of earth fault in motor or motor cable, only the frequency converter is protected
	Unit overtemperature protection	Yes
	Motor overload protection	Yes
	Motor stall protection	Yes
	Motor underload protection	Yes
	Short-circuit protection of +24V and +10V reference voltages	Yes
	Overcurrent protection	Trip limit $4,0 \cdot I_H$ instantaneously

Table 4- 4. Technical data

5. INSTALLATION

5.1 Mounting

5.1.1 NXL Compact (MF2 and MF3)

There are two possible positions in the wall mounting for the frames MF2 and MF3 (see Figure 5-1)

The NXL type MF2 is mounted with two screws using the **middle** holes of the mounting plates. If an RFI filter is used, the upper mounting plate shall be attached with **two** screws (see Figure 5-2). MF3 and bigger types are always mounted with **four** screws.

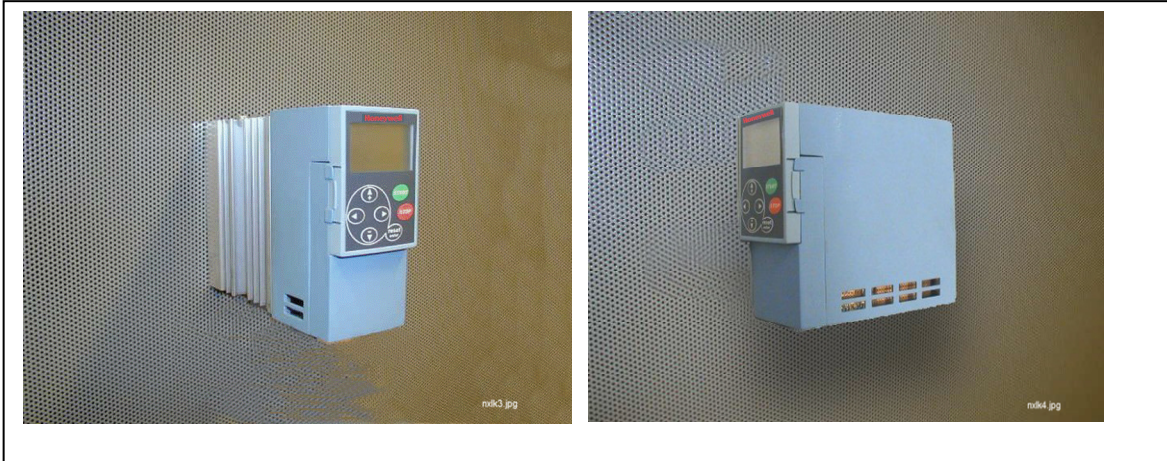

Figure 5-1. The two possible mounting positions of NXL (MF2 and MF3)

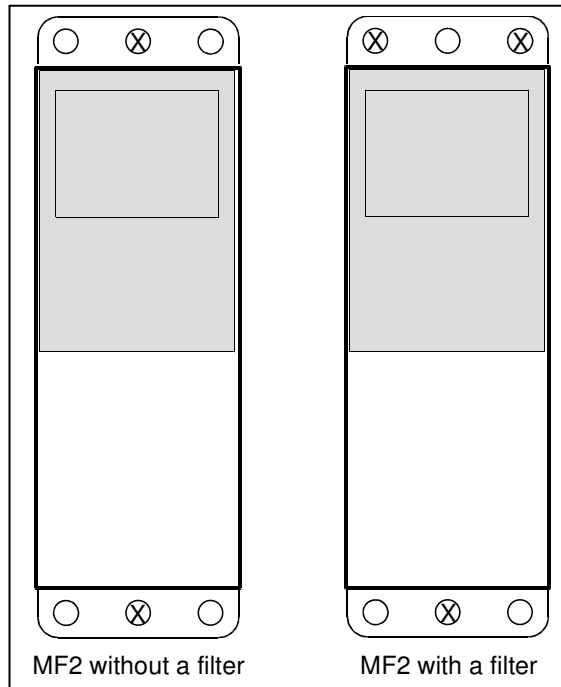

Figure 5-2. Mounting of NXL, MF2

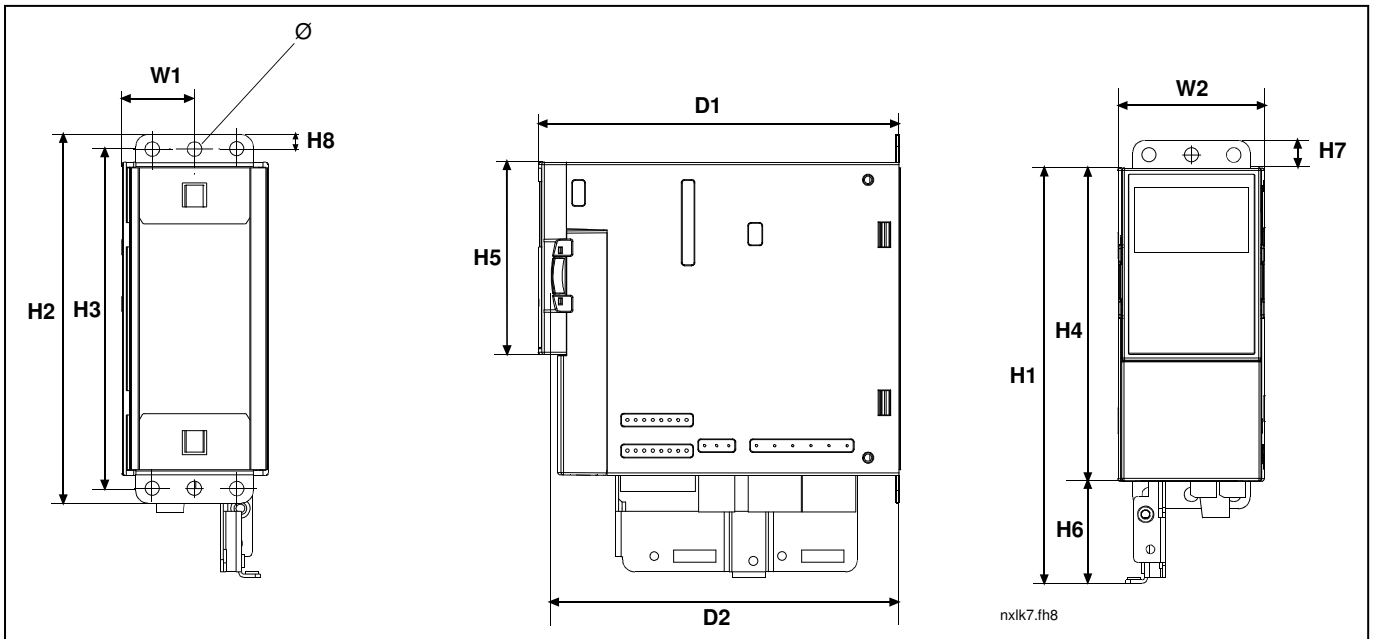

Figure 5-3. NXL Compact dimensions, MF2

Type	Dimensions (mm)												
	W1	W2	H1	H2	H3	H4	H5	H6	H7	H8	D1	D2	\varnothing
MF2	30	60	172	152	140	130	80	42	11	6	150	144	6

Table 5-1. Dimensions of NXL, MF2

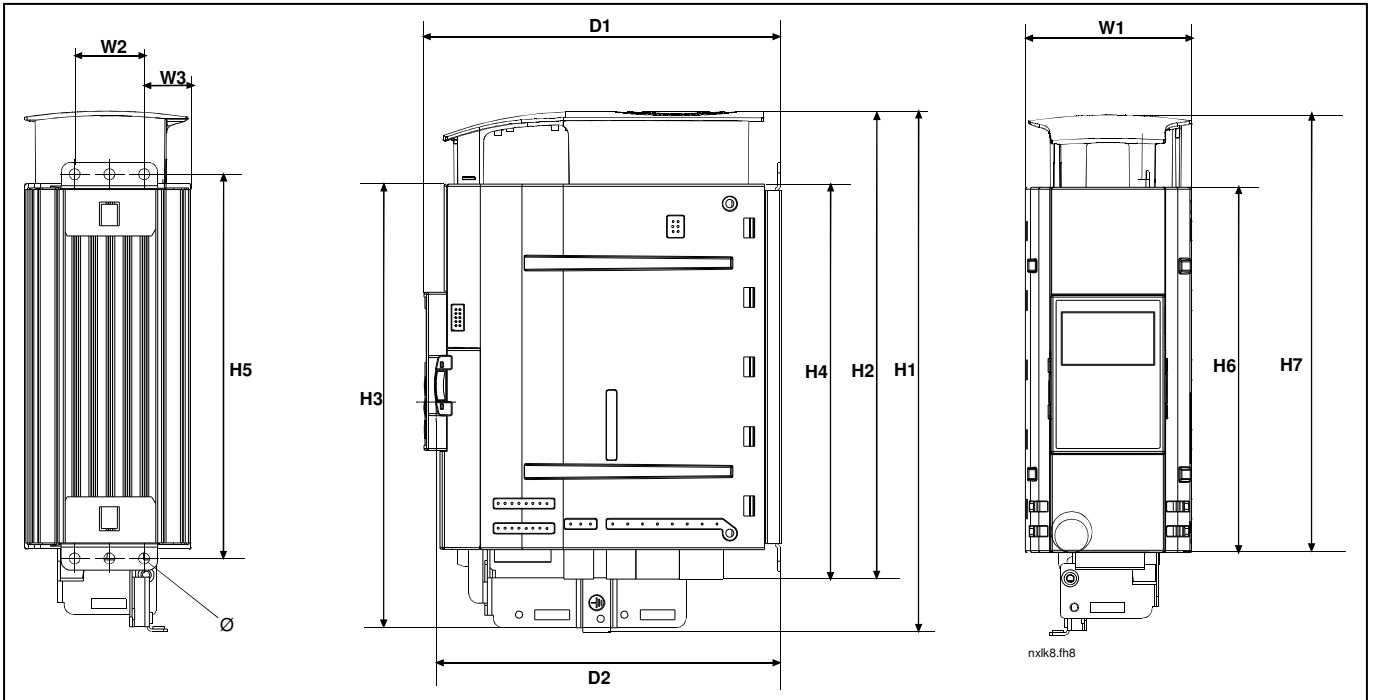

Figure 5-4. NXL Compact dimensions, MF3

Type	Dimensions (mm)												
	W1	W2	W3	H1	H2	H3	H4	H5	H6	H7	D1	D2	Ø
MF3	84	35	23	262	235	223	199	193	184	220	172	166	6

Table 5-2. Dimensions of NXL, MF3

5.1.2 NXL HVAC (MF4 – MF6)

The frequency converter shall be fixed with four screws (or bolts, depending on the unit size). Enough space shall be reserved around the frequency converter in order to ensure a sufficient cooling, see Table 5-4 and Figure 5-6.

Also see to that the mounting plane is relatively even.

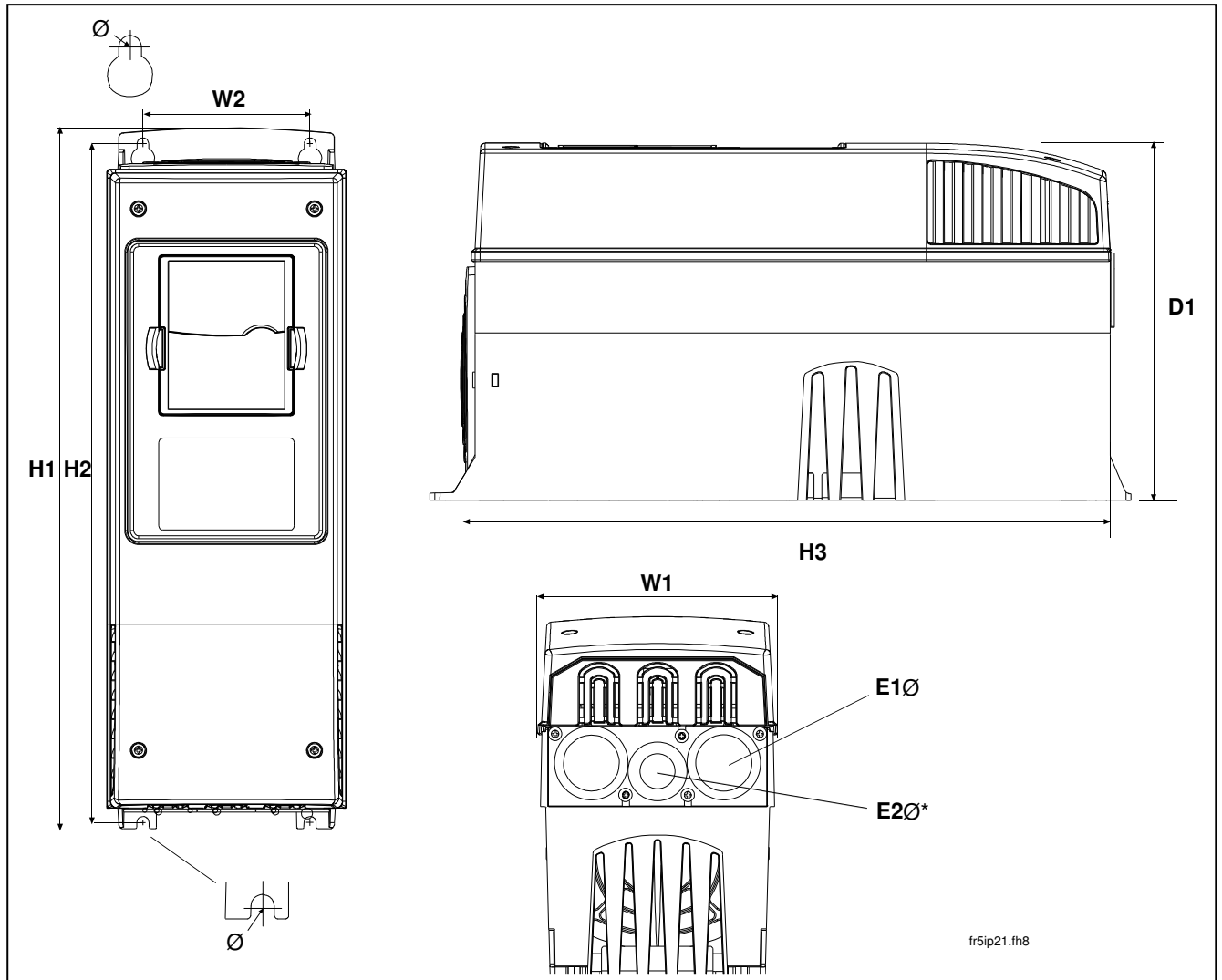

Figure 5-5. NXL HVAC dimensions

Type	Dimensions									
	W1	W2	H1	H2	H3	D1	Ø	E1Ø	E2Ø*	
MF4 (HVAC03-12)	128	100	327	313	292	190	7	3 x 28,3		
MF5 (HVAC16-31)	144	100	419	406	391	214	7	2 x 37	1 x 28,3	
MF6 (HVAC38-61)	195	148	558	541	519	237	9	3 x 37		

Table 5-3. Dimensions of NXL HVAC, MF4—MF6

* = MF5 only

5.2 Cooling

Forced air flow cooling is used for NXL HVAC and NXL Compact size MF3.

Enough free space shall be left above and below the frequency converter to ensure sufficient air circulation and cooling. You will find the required dimensions for free space in the table below.

Type	Dimensions [mm]			
	A	B	C	D
NXL 0002-0006 2	10	10	100	50
NXL 0001-0005 5	10	10	100	50
HVAC 03-12	20	20	100	50
HVAC 16-31	20	20	120	60
HVAC 38-61	30	20	160	80

Table 5-4. Mounting space dimensions

- A** = clearance around the freq. converter (see also **B**)
- B** = distance from one frequency converter to another or distance to cabinet wall
- C** = free space above the frequency converter
- D** = free space underneath the frequency converter

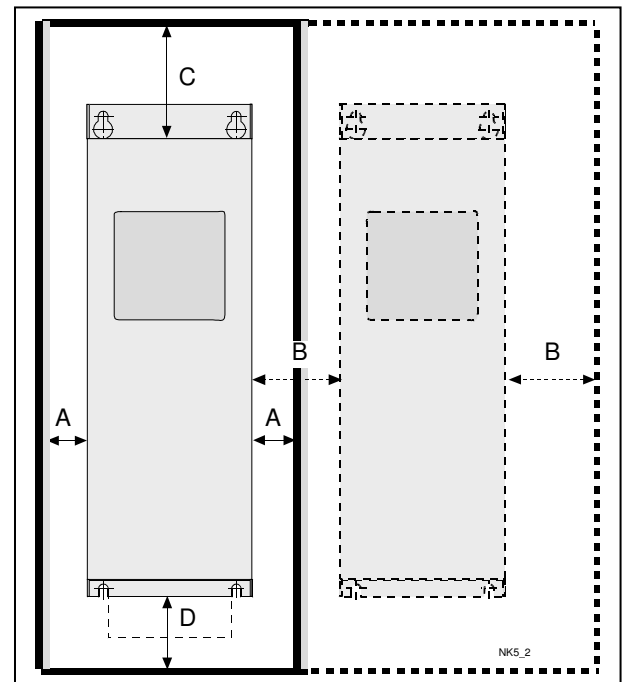

Figure 5-6. Installation space

Type	Cooling air required [m ³ /h]
HVAC 03—12	70
HVAC 16—31	190
HVAC 38—61	425

Table 5-5. Required cooling air

5.3 Changing EMC protection class from H/C to T in NXL HVAC

The EMC protection class of NXL HVAC frequency converter types can be changed from **class H/C** to **class T** with a simple procedure presented in the figures below.

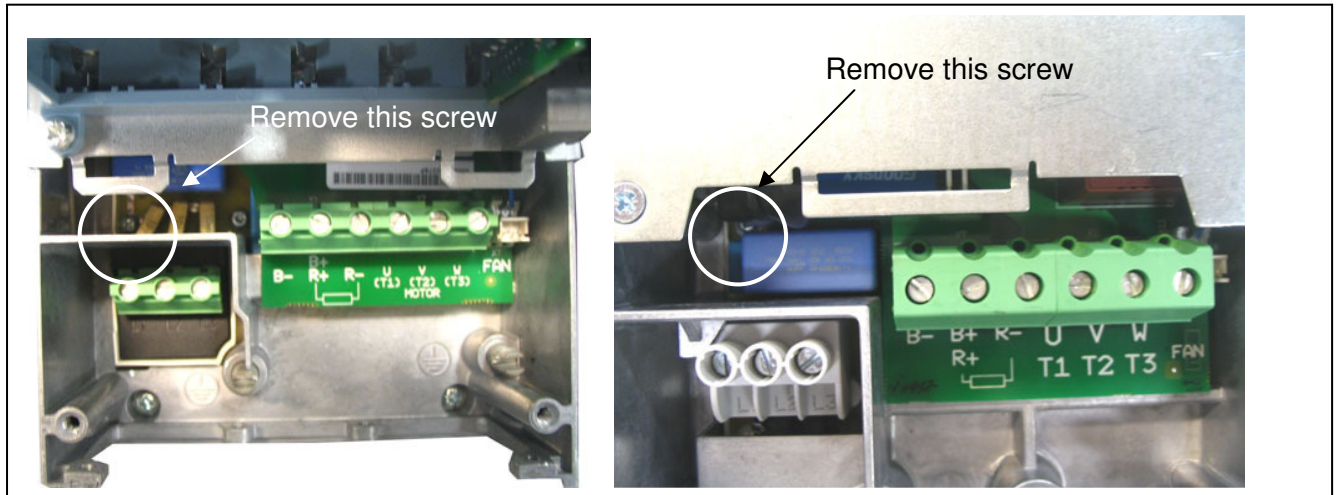

Figure 5-7. Changing of EMC protection class, MF4 (left) and MF5 (right)

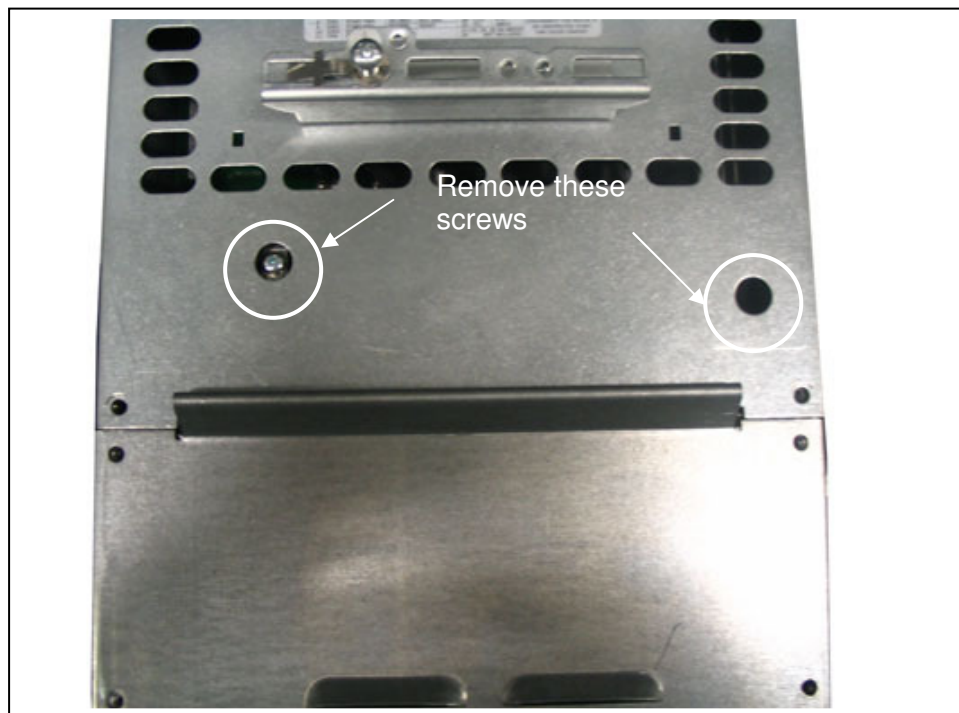

Figure 5-8. Changing of EMC protection class, MF6

Note! Do not attempt to change the EMC-level back to class H or C. Even if the procedure above is reversed, the frequency converter will no longer fulfil the EMC requirements of class H or C!

6. CABLING AND CONNECTIONS

6.1 Power connections

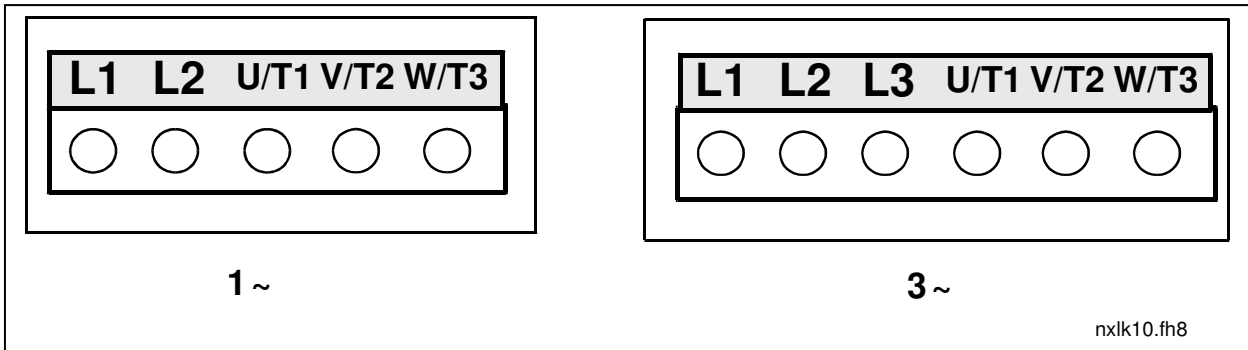

Figure 6-1. Power connections, MF2

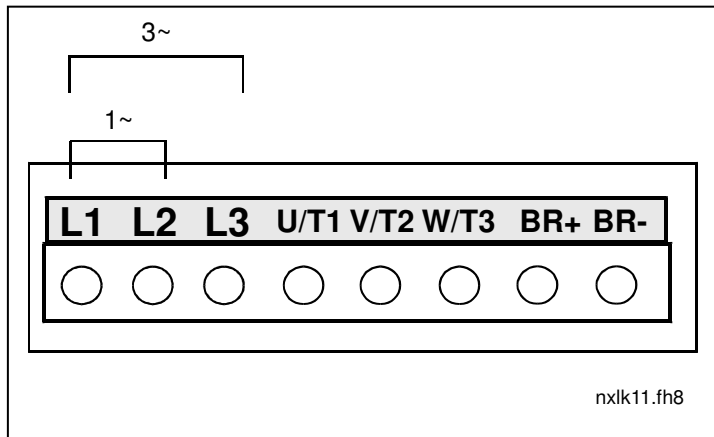

Figure 6-2. Power connections, NXL Compact MF3 (1~/3~)

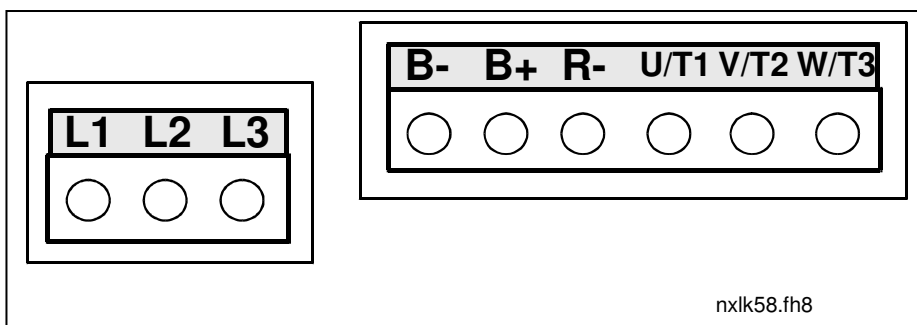

Figure 6-3. Power connections, NXL HVAC (MF4-MF6)

6.1.1 Cabling

Use cables with heat resistance of at least +70°C. The cables and the fuses must be dimensioned according to the tables below. Installation of cables according to UL regulations is presented in Chapter 6.1.4.

The fuses function also as cable overload protection.

These instructions apply only to cases with one motor and one cable connection from the frequency converter to the motor. In any other case, ask the factory for more information.

	1 st environment (restricted distribution)	2 nd environment		
Cable type	Level H/C	Level L	Level T	Level N
Mains cable	1	1	1	1
Motor cable	3*	2	1	1
Control cable	4	4	4	4

Table 6-1. Cable types required to meet standards.

Level C = EN 61800-3 (2004), category C1
EN 61000-6-3

Level H = EN 61800-3 (2004), category C2
EN 61000-6-4

Level L = EN61800-3 (2004), 2nd environment (industrial)

Level T: See page 9.

Level N: See page 9.

- 1 = Power cable intended for fixed installation and the specific mains voltage. Shielded cable not required. (NKCABLES/MCMK or similar recommended)
- 2 = Power cable equipped with concentric protection wire and intended for the specific mains voltage. (NKCABLES /MCMK or similar recommended).
- 3 = Power cable equipped with compact low-impedance shield and intended for the specific mains voltage. (NKCABLES /MCCMK, SAB/ÖZCUY-J or similar recommended).
*360° earthing of both motor and FC connection required to meet the standard
- 4 = Screened cable equipped with compact low-impedance shield (NKCABLES /jamak, SAB/ÖZCuY-O or similar).

In NXL HVAC (MF4 – MF6): A cable entry flange should be used when installing the motor cable at both ends in order to reach the EMC levels.

Note: The EMC requirements are fulfilled at factory defaults of switching frequencies (all frames).

6.1.1.1 Cable and fuse sizes

Frame	Type	I _L [A]	Fuse [A]	Mains cable Cu [mm ²]	Terminal cable size (min/max)			
					Main terminal [mm ²]	Earth terminal [mm ²]	Control terminal [mm ²]	Relay terminal [mm ²]
MF2	NXL0002	2	10	2*1.5+1.5	0.5—2.5	0.5—2.5	0.5—1.5	0.5—2.5
MF3	NXL0003—0006	3-6	16	2*2.5+2.5	0.5—2.5	0.5—2.5	0.5—1.5	0.5—2.5

Table 6-2. Cable and fuse sizes for NXL Compact, 208 - 240V

Frame	Type	I _L [A]	Fuse [A]	Mains cable Cu [mm ²]	Terminal cable size (min/max)			
					Main terminal [mm ²]	Earth terminal [mm ²]	Control terminal [mm ²]	Relay terminal [mm ²]
MF2	NXL0001—0002	1-2	10	3*1.5+1.5	0.5—2.5	0.5—2.5	0.5—1.5	0.5—2.5
MF3	NXL0003—0005	1-5	10	3*1.5+1.5	0.5—2.5	0.5—2.5	0.5—1.5	0.5—2.5
MF4	HVAC03—09	7—9	10	3*1.5+1.5	1—4	1—2.5	0.5—1.5	0.5—2.5
MF4	HVAC12	12	16	3*2.5+2.5	1—4	1—2.5	0.5—1.5	0.5—2.5
MF5	HVAC16	16	20	3*4+4	1—10	1—10	0.5—1.5	0.5—2.5
MF5	HVAC23	22	25	3*6+6	1—10	1—10	0.5—1.5	0.5—2.5
MF5	HVAC31	31	35	3*10+10	1—10	1—10	0.5—1.5	0.5—2.5
MF6	HVAC38—45	38- 45	50	3*10+10	2.5—50 Cu 6—50 Al	6—35	0.5—1.5	0.5—2.5
MF6	HVAC61	61	63	3*16+16	2.5—50 Cu 6—50 Al	6—35	0.5—1.5	0.5—2.5

Table 6-3. Cable and fuse sizes for NXL, 380 – 500V

Note! This cable recommendation is based on standard **EN 60204-1** and **PVC isolated** cable where there is either one cable on a shelf in temperature of + 40°C or four cables on a shelf in temperature of + 30°C.

6.1.2 Mounting of cable accessories

Enclosed to your NXL frequency converter you have received a plastic bag containing components that are needed for the installation of the mains and motor cables in the frequency converter.

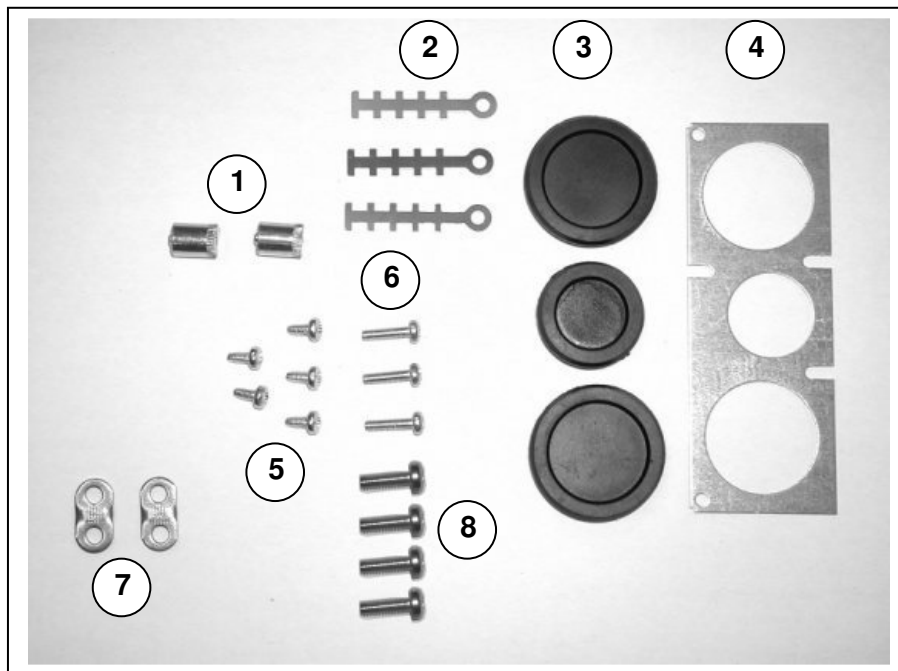

Figure 6-4. Cable accessories

Components:

- | | |
|---|--|
| 1 | Grounding terminals (MF4, MF5) (2) |
| 2 | Cable clamps (3) |
| 3 | Rubber grommets (sizes vary from class to class) (3) |
| 4 | Cable entry gland (1) |
| 5 | Screws, M4x10 (5) |
| 6 | Screws, M4x16 (3) |
| 7 | Grounding cable clamps (MF6) (2) |
| 8 | Grounding screws M5x16 (MF6) (4) |

NOTE: The cable accessories installation kit for frequency converters of protection class **IP54** includes all components except **4** and **5**.

Mounting procedure

1. Make sure that the plastic bag you have received contains all necessary components.
2. Open the cover of the frequency converter (**Figure 1**).
3. Remove the cable cover. Observe the places for
 - a) the grounding terminals (MF4/MF5) (**Figure 2**).
 - b) the grounding cable clamps (MF6) (**Figure 3**).
4. Re-install the cable cover. Mount the cable clamps with the three M4x16 screws as shown in **Figure 4**. Note that the location of the grounding bar in FR6/MF6 is different from what is shown in the picture.

5. Place the rubber grommets in the openings as shown in **Figure 5**.
6. Fix the cable entry gland to the frame of the frequency converter with the five M4x10 screws (**Figure 6**). Close the cover of the frequency converter.

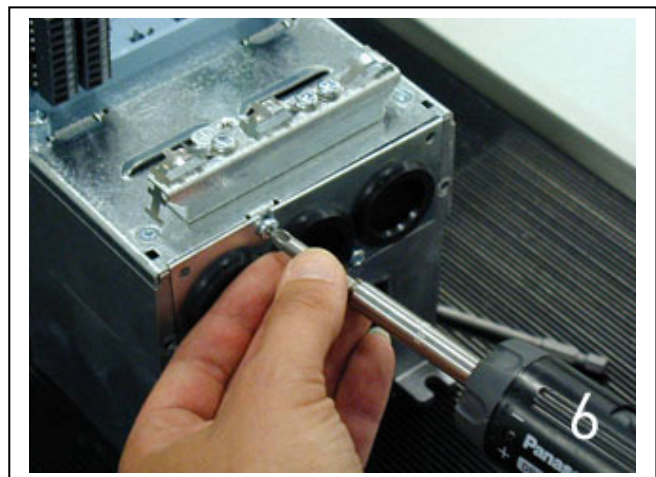
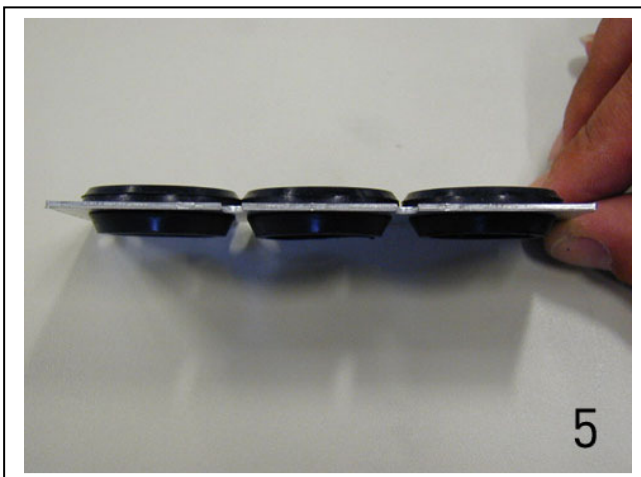
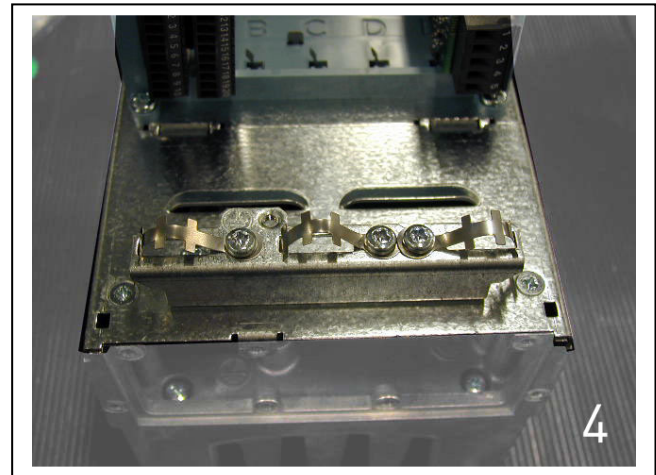
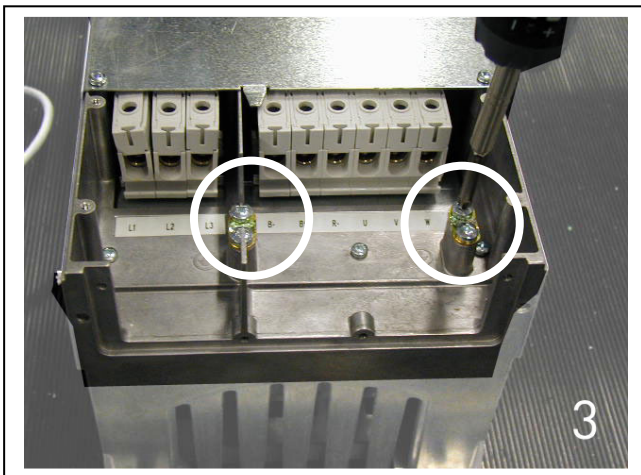
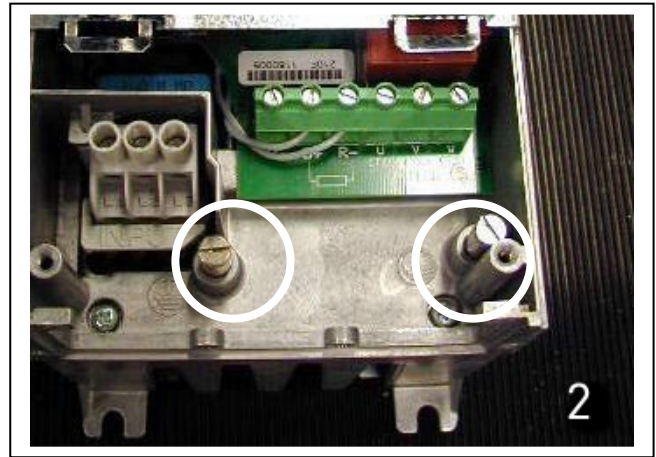
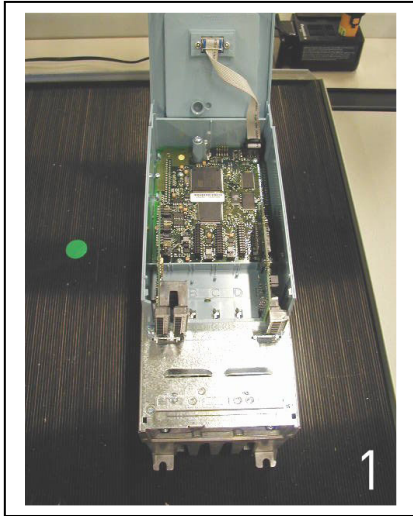

6.1.3 Installation instructions

1	Before starting the installation, check that none of the components of the frequency converter is live.						
2	The NXL frequency converter types MF2 and MF3 shall be installed inside switchgear, separate cubicle or electrical room because of the protection class IP20 and the fact that the cable terminals are not protected.						
3	<p>Place the motor cables sufficiently far from other cables:</p> <ul style="list-style-type: none"> ▪ Avoid placing the motor cables in long parallel lines with other cables ▪ If the motor cables run in parallel with other cables, note the minimum distances between the motor cables and other cables given in table below. ▪ The given distances also apply between the motor cables and signal cables of other systems. ▪ The maximum length of the motor cables is 30 m (MF2-MF3), 50 m (MF4) and 300 m (MF5 – MF6). ▪ The motor cables should cross other cables at an angle of 90 degrees. <table border="1" style="margin-left: auto; margin-right: auto;"> <thead> <tr> <th style="text-align: center;">Distance between cables [m]</th> <th style="text-align: center;">Shielded cable [m]</th> </tr> </thead> <tbody> <tr> <td style="text-align: center;">0.3</td> <td style="text-align: center;">≤20</td> </tr> <tr> <td style="text-align: center;">1.0</td> <td style="text-align: center;">≤50</td> </tr> </tbody> </table>	Distance between cables [m]	Shielded cable [m]	0.3	≤20	1.0	≤50
Distance between cables [m]	Shielded cable [m]						
0.3	≤20						
1.0	≤50						
4	If cable insulation checks are needed, see Chapter 6.1.5.						
5	<p>Connect the cables:</p> <ul style="list-style-type: none"> ▪ Strip the motor and mains cables as advised in Table 6-4 and Figure 6-5. ▪ Connect the mains, motor and control cables into their respective terminals (see e.g.). ▪ For Information on cable installation according to UL regulations see Chapter 6.1.4. ▪ Make sure that the control cable wires do not come in contact with the electronic components of the unit. ▪ If an external brake resistor (option) is used, connect its cable to the appropriate terminal. ▪ Check the connection of the earth cable to the motor and the frequency converter terminals marked with . ▪ Connect the separate shield of the motor cable to the earth plate of the frequency converter, motor and the supply centre. ▪ Ensure that the control cables or the cables of the unit are not trapped between the frame and the protection plate. 						

6.1.3.1 *Stripping lengths of motor and mains cables*

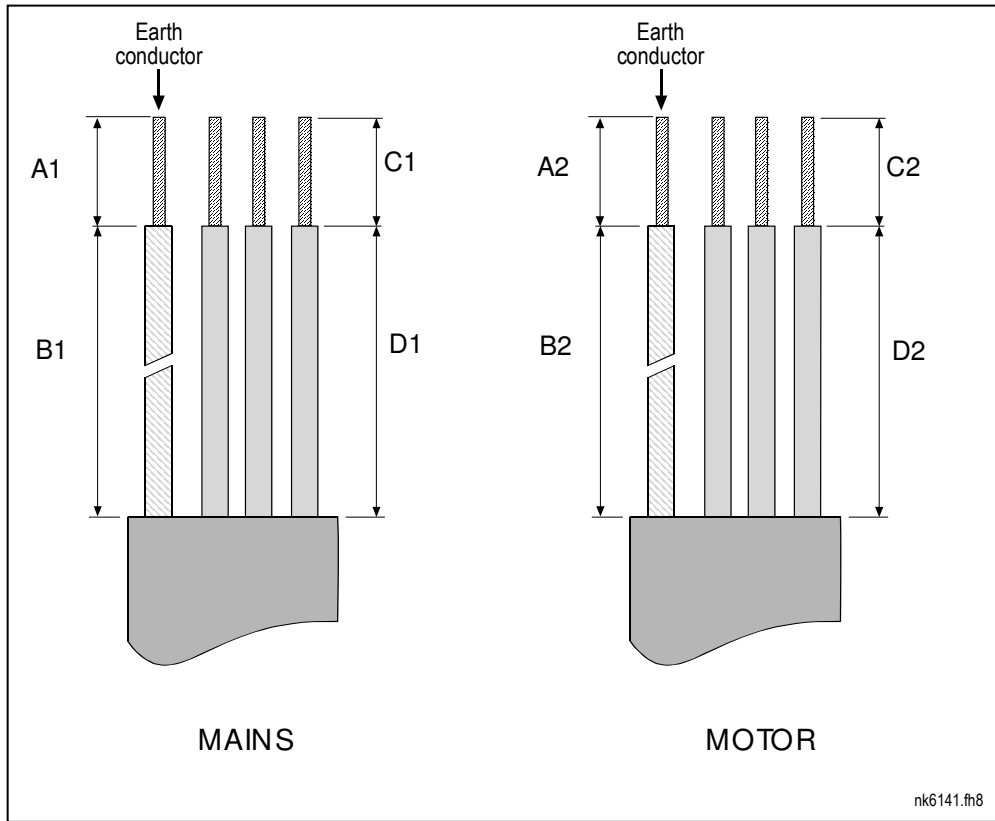

Figure 6-5. Stripping of cables

Frame	A1	B1	C1	D1	A2	B2	C2	D2
MF2	7	35	7	20	7	50	7	35
MF3	7	40	7	30	7	60	7	40
MF4	15	35	10	20	7	50	7	35
MF5	20	40	10	30	20	60	10	40
MF6	20	90	15	60	20	90	15	60

Table 6-4. Cables stripping lengths [mm]

6.1.3.2 Installation of cables to NXL

Note: In case you want to connect an external brake resistor (MF3 and bigger sizes), see separate Brake Resistor Manual.



Figure 6-6. NXL Compact, MF2

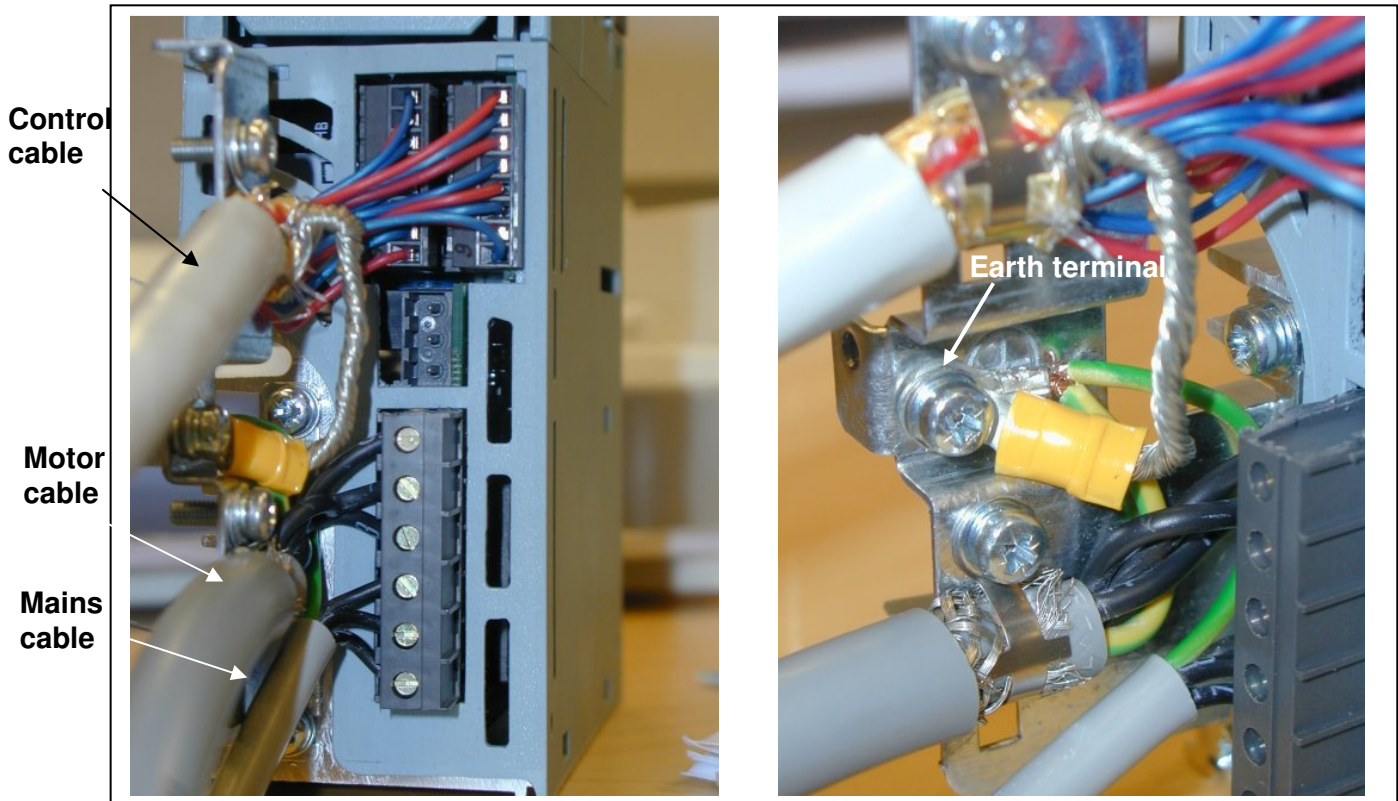

Figure 6-7. Cable installation in NXL Compact, MF2 (500V, 3-phase)



Figure 6-8. NXL Compact, MF3

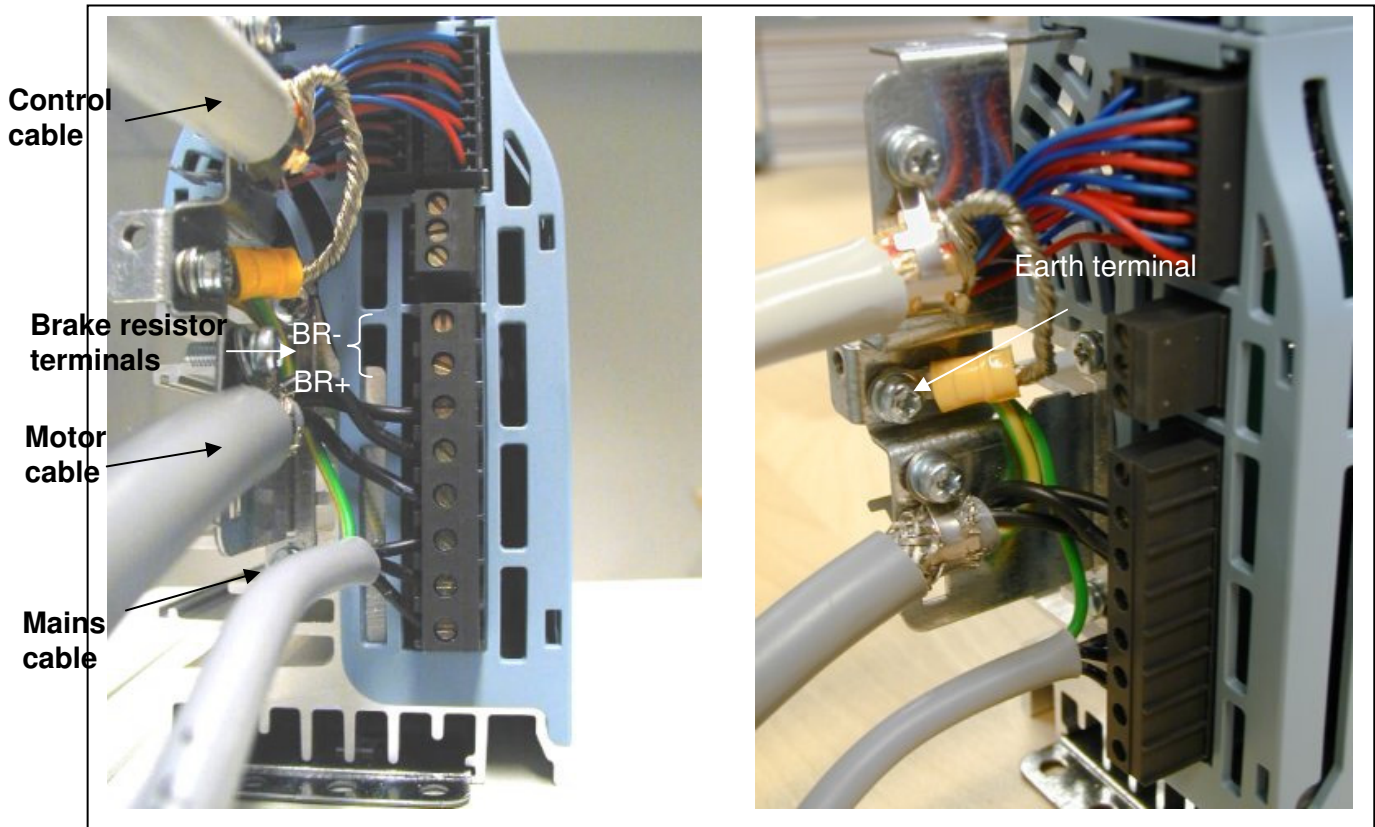

Figure 6-9. Cable installation in NXL Compact, MF3

NOTE! NXL Compact (MF2-3): It is advisable to connect the cables to the terminals and earthing plate first and then attach the terminals and earthing plate to the unit.

Installation of an external RFI filter to NXL Compact (MF2-3)

The EMC protection class of NXL Compact frequency converters MF2 and MF3 can be changed from **N** to **H** with an optional external RFI filter. Install the power cables in terminals L1, L2 and L3 and the grounding cable in terminal PE of the filter. See the figures below. See also mounting instructions of MF2 in Figure 5-2.



Figure 6-10. MF2 with the RFI-filter

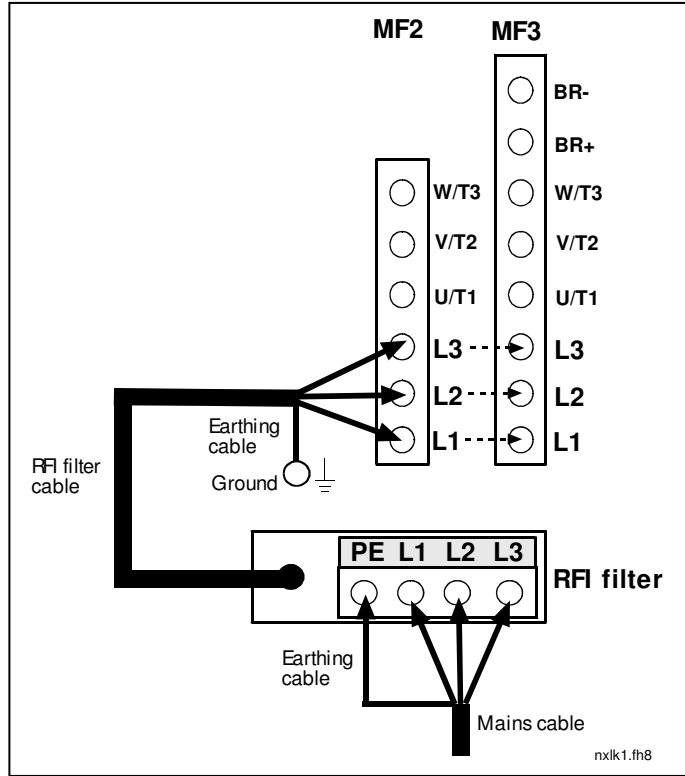

Figure 6-11. RFI installation for MF2 and MF3, 380...500V, 3 phase supply. Filter type NXLRFIV35

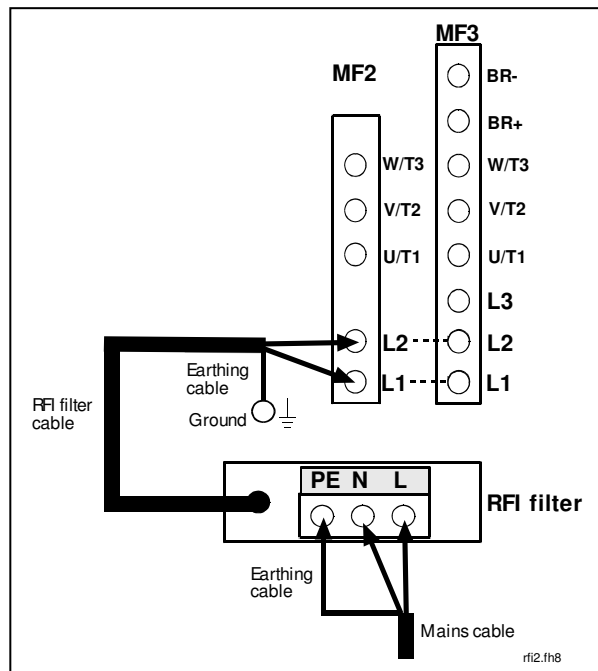

Figure 6-12. RFI cable installation for MF2 and MF3, 208...240V, 1 phase supply. Filter type NXLRFIV12

RFI Filter type	Input voltage	Dimensions WxHxD (mm)
NXLRFIV35	380-500V 3~	60x252x35
NXLRFIV12	208-240V 1~	60x252x35

Table 6-5. RFI filter types and their dimensions



Figure 6-13. NXL HVAC (03-12), MF4

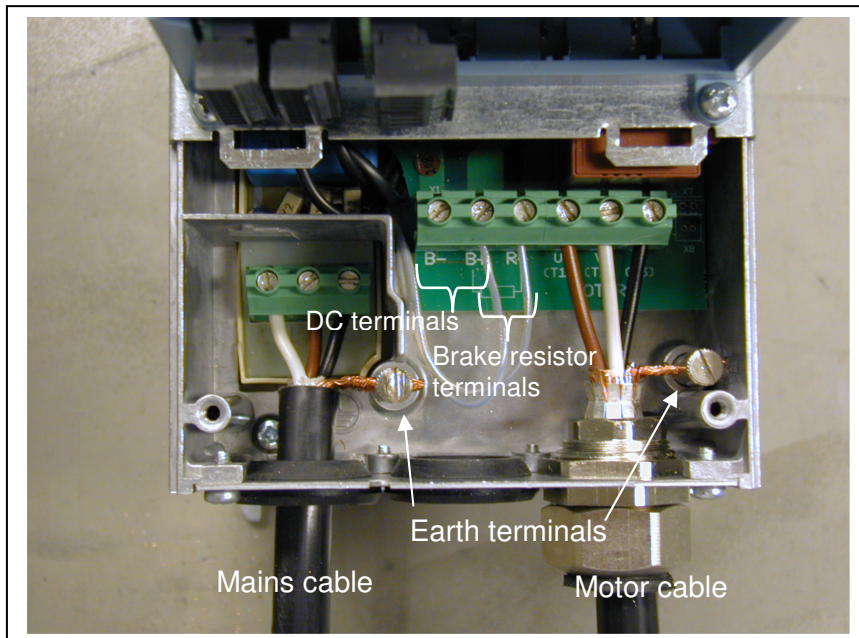

Figure 6-14. Cable installation in NXL HVAC (03-12), MF4



Figure 6-15. NXL HVAC (16-31), MF5

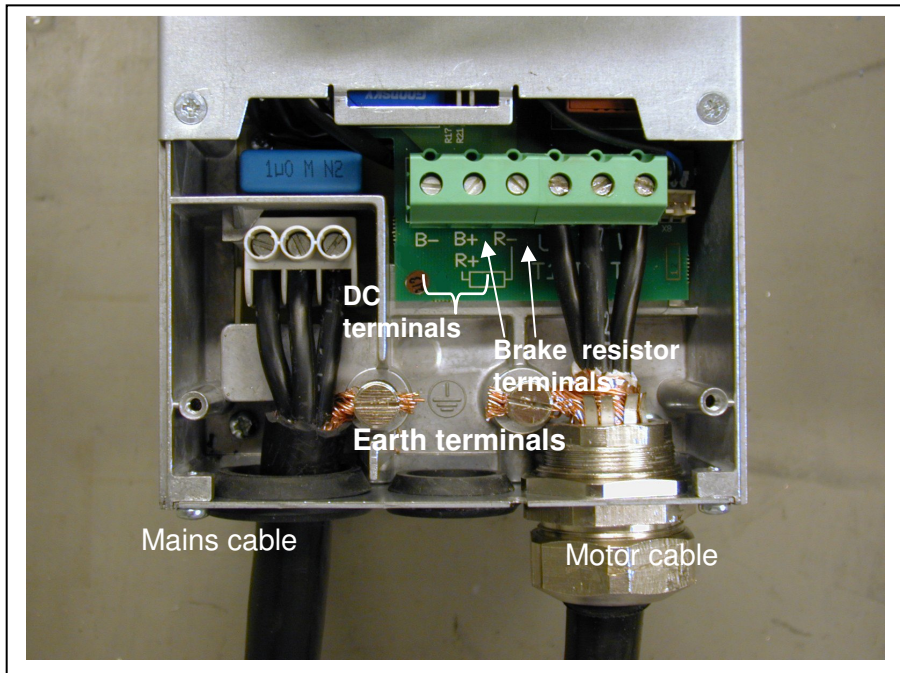

Figure 6-16. Cable installation in NXL HVAC (16-31), MF5

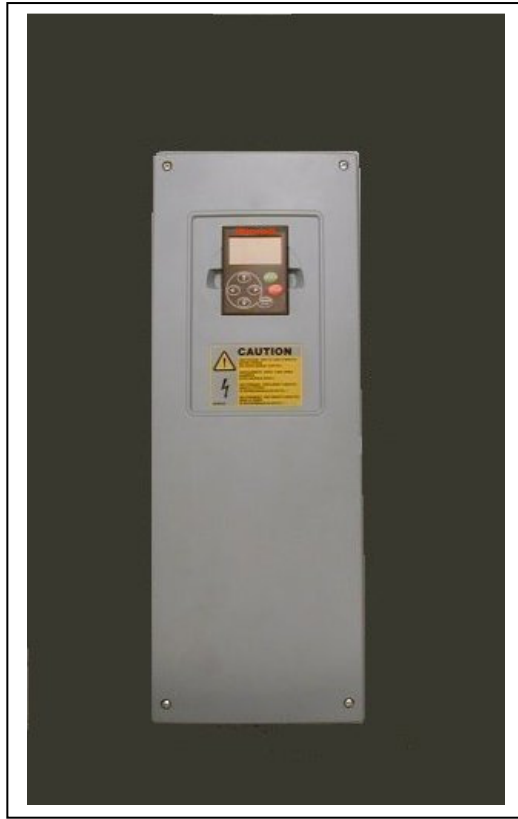

Figure 6-17. NXL HVAC (38-61), MF6

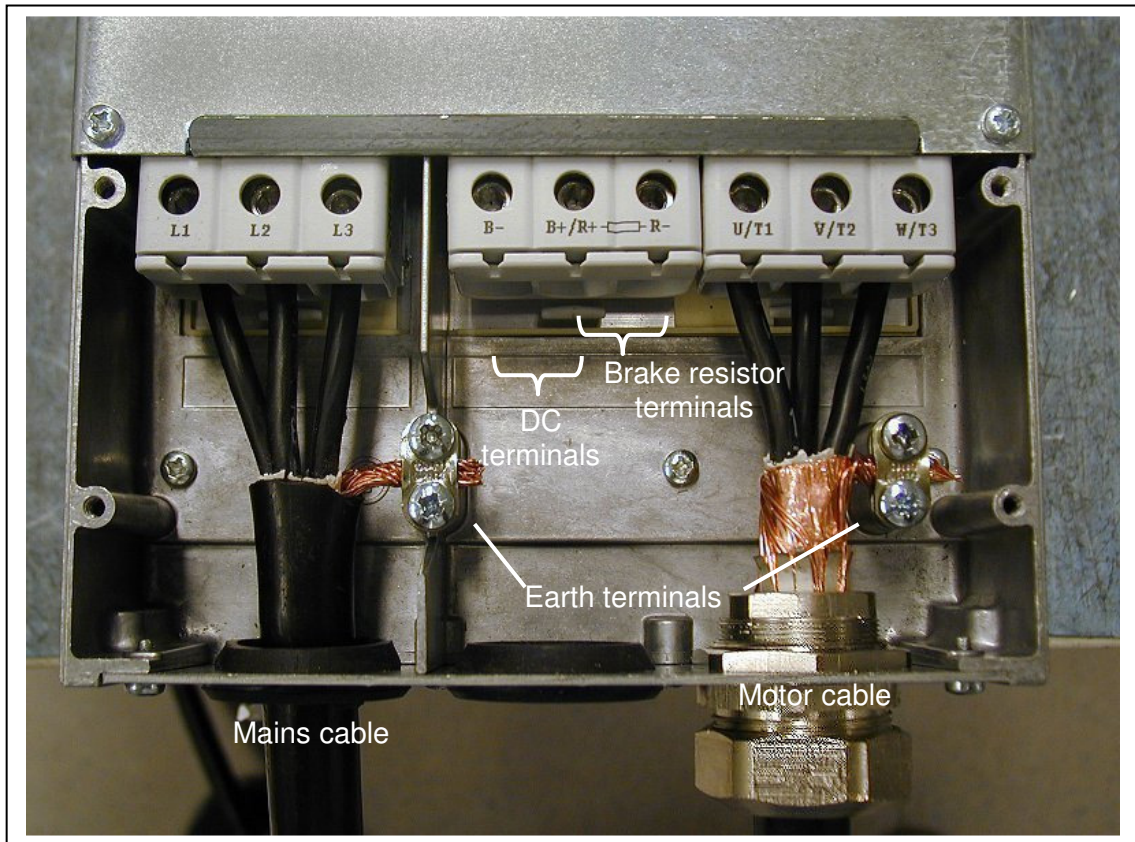

Figure 6-18. Cable installation in NXL HVAC (38-61), MF6

6.1.4 Cable installation and the UL standards

To meet the UL (Underwriters Laboratories) regulations, a UL-approved copper cable with a minimum heat-resistance of +60/75°C must be used.

The tightening torques of the terminals are given in Table 6-6.

Frame	Tightening torque [Nm]	Tightening torque in-lbs.
MF2	0.5—0.6	4—5
MF3	0.5—0.6	4—5
MF4	0.5—0.6	4—5
MF5	1.2—1.5	10—13
MF6	4	35

Table 6-6. Tightening torques of terminals

6.1.5 Cable and motor insulation checks

1. Motor cable insulation checks

Disconnect the motor cable from terminals U, V and W of the frequency converter and from the motor. Measure the insulation resistance of the motor cable between each phase conductor as well as between each phase conductor and the protective ground conductor.

The insulation resistance must be $>1\text{M}\Omega$.

2. Mains cable insulation checks

Disconnect the mains cable from terminals L1, L2 and L3 of the frequency converter and from the mains. Measure the insulation resistance of the mains cable between each phase conductor as well as between each phase conductor and the protective ground conductor.

The insulation resistance must be $>1\text{M}\Omega$.

3. Motor insulation checks

Disconnect the motor cable from the motor and open the bridging connections in the motor connection box. Measure the insulation resistance of each motor winding. The measurement voltage must equal at least the motor nominal voltage but not exceed 1000 V. The insulation resistance must be $>1\text{M}\Omega$.

6.2 Control unit

6.2.1 NXL Compact (MF2 – MF3)

The control unit of the NXL frequency converter is integrated with the power unit and consists roughly of the control board and **one optional board**, which can be connected to the *slot connector* of the control board.

6.2.2 NXL HVAC (MF4 – MF6)

In NXL HVAC frames **MF4-MF6** there are two option board connectors SLOT D and SLOT E (see Figure 6-19).

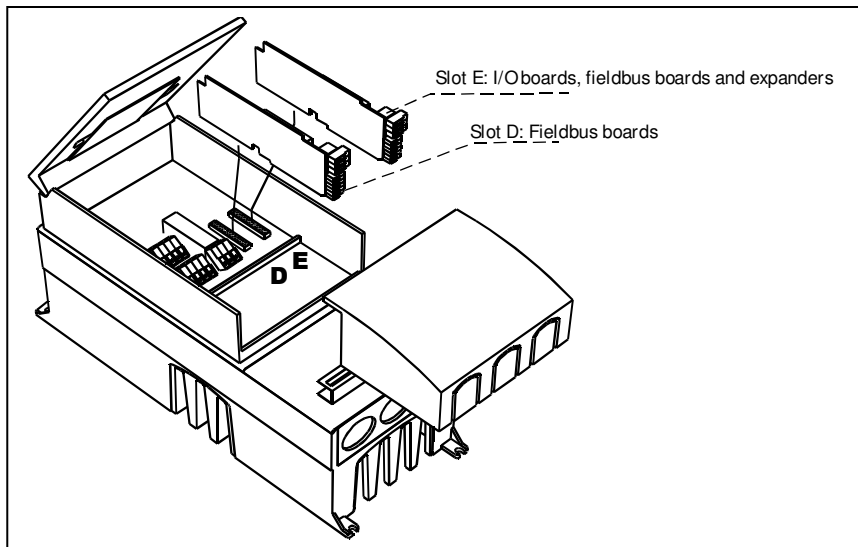

Figure 6-19. Option board slots D and E in frames MF4 – MF6

6.2.2.1 Allowed option boards in NXL HVAC:

See below for the allowed option boards in the two slots on NXL HVAC frequency converters:

SLOT D	C2	C3	C4	C6	C7	C8	C1	CJ							
SLOT E	AA	AI	B1	B2	B4	B5	B9	C2	C3	C4	C6	C7	C8	C1	CJ

In **NXL HVAC** series the option board **NXLOPTAI** is included in all deliveries as standard. The free slot D is meant for additional fieldbus boards.

When two option boards are used, the one in **slot E** has to be **NXLOPTAI** or **NXLOPTAA**. It is not allowed to use two NXOPTB_ or NXOPTC_ boards. Also combinations of NXOPTB_ and NXOPTC_ –boards are prohibited.

See descriptions for NXLOPTAA and NXLOPTAI option boards in chapters 10 and 11.

6.2.3 Control connections

The basic control connections are shown below.

The signal descriptions of the HVAC and Multicontrol Applications are presented in Chapter 6.2.4 and in Chapter 2 of the HVAC and Multicontrol Application Manuals.

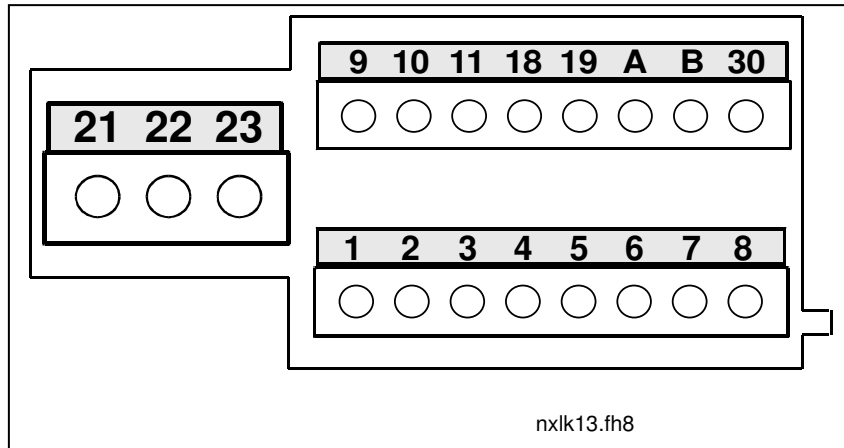

Figure 6-20. Control connections NXL Compact, MF2 – MF3

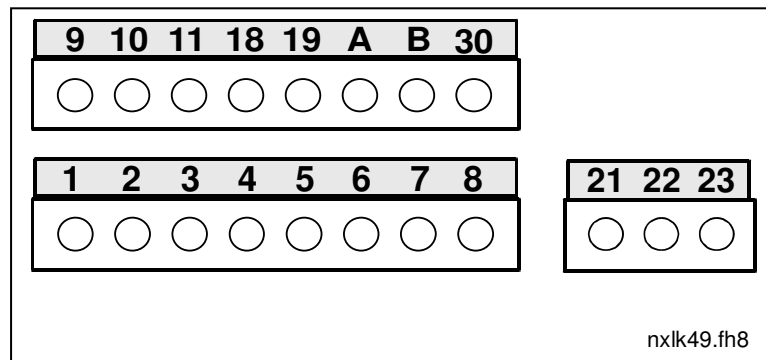
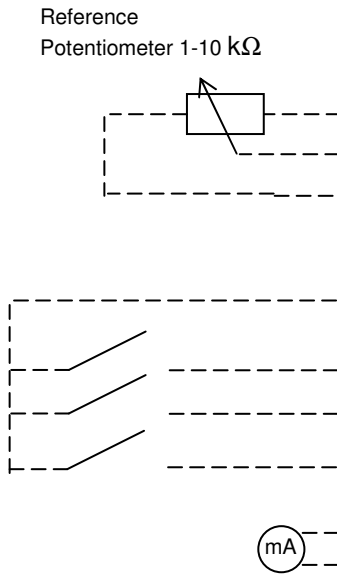

Figure 6-21. Control connections NXL HVAC, MF4 – MF6

6.2.4 Control I/O



Terminal	Signal	Description
1	+10V _{ref}	Reference output Voltage for potentiometer, etc.
2	AI1+	Analogue input, voltage range 0—10V DC. Voltage input frequency reference
3	AI1-	I/O Ground Ground for reference and controls
4	AI2+	Analogue input, current range 0—20mA Current input frequency reference
5	AI2- /GND	
6	+24V	Control voltage output Voltage for switches, etc. max 0.1 A
7	GND	I/O ground Ground for reference and controls
8	DIN1	Start forward (programmable) Contact closed = start forward
9	DIN2	Start reverse (programmable) Contact closed = start reverse
10	DIN3	Preset speed selection 1 (programmable) Contact closed = Preset speed 1
11	GND	I/O ground Ground for reference and controls
18	AO1+	Output frequency Analogue output Programmable Range 0—20 mA/R _L , max. 500Ω
19	AO1-	
A	RS 485	Serial bus Differential receiver/transmitter
B	RS 485	Serial bus Differential receiver/transmitter
30	+24V	24V aux. input voltage Control power supply backup
21	RO1	Relay output 1 FAULT Programmable
22	RO1	
23	RO1	

Table 6-7. Default I/O configuration.

Terminal	Signal	Description
12	+24V	+24 V DC Control voltage output; voltage for switches etc.
13	GND	I/O ground Ground for reference and controls
14	Exp DIN1	Preset speed selection 2 (programmable) Contact closed = Preset speed 2
15	Exp DIN2	Fault Reset (programmable) Contact closed = Fault reset
16	Exp DIN3	Disable PID (PID control selection) (Programmable) Contact closed = Disable PID
25	Exp RO1	Expander Relay output 1 (NO) RUN Programmable
26	Exp RO1	
28	TI+	Motor Thermistor input Active = Fault, stop according to defined method
29	TI-	

Table 6-8. Additional inputs in **NXL HVAC** (available as option for **NXL Compact**)

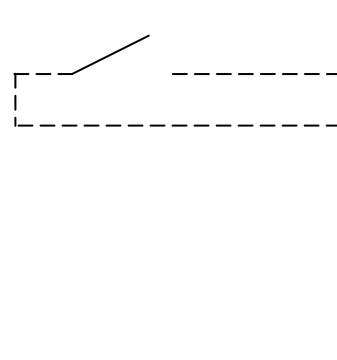

Terminal	Signal	Description
1	+10V _{ref}	Reference output Voltage for potentiometer, etc.
2	AI1+ or DIN 4	Analogue input, voltage range 0—10V DC Voltage/current input frequency reference (MF2-3) Voltage/current input frequency reference (MF4-MF6) Can be programmed as DIN4
3	AI1-	I/O Ground Ground for reference and controls
4	AI2+	Analogue input, voltage range 0—10V DC or current range 0—20mA Voltage or current input frequency reference
5	AI2- /GND	
6	+ 24 V	Control voltage output
7	GND	I/O ground Ground for reference and controls

Table 6-9. AI1 configuration, when programmed as DIN4

6.2.5 Control terminal signals

Terminal	Signal	Technical information
1	+10 Vref	Reference voltage Maximum current 10 mA
2	AI1+	Analogue input, voltage (MF4 and bigger: voltage or current)
3	AI1-	Analogue input common
4	AI2+	Analogue input, voltage or current
5	AI2-	Analogue input common
6	24 Vout	24V auxiliary output voltage
7	GND	I/O ground
8	DIN1	Digital input 1
9	DIN2	Digital input 2
10	DIN3	Digital input 3
11	GND	I/O ground
18	AO1+	Analogue signal (+output)
19	AO1-/GND	Analogue output common
A	RS 485	Serial bus
B	RS 485	Serial bus
30	+24V	24V auxiliary input voltage

21	RO1/1	 Relay output 1
22	RO1/2	
23	RO1/3	
		Switching capacity: 24VDC/8A 250VAC/8A 125VDC/0,4A Relay output terminals are galvanically isolated from the I/O ground

Table 6-9. Control I/O terminal signals

NOTE! **NXL HVAC** additional inputs terminal signals defined in **section 11 NXLOPTAI**

6.2.5.1 *Jumper selections on NXL basic board*

The user is able to customise the functions of the frequency converter to better suit his needs by selecting certain positions for the jumpers on the NXL board. The positions of the jumpers determine the signal type of analogue input (terminal #2) and whether the termination resistor RS485 is used or not.

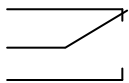
The following figures present the jumper selections of NXL frequency converters:

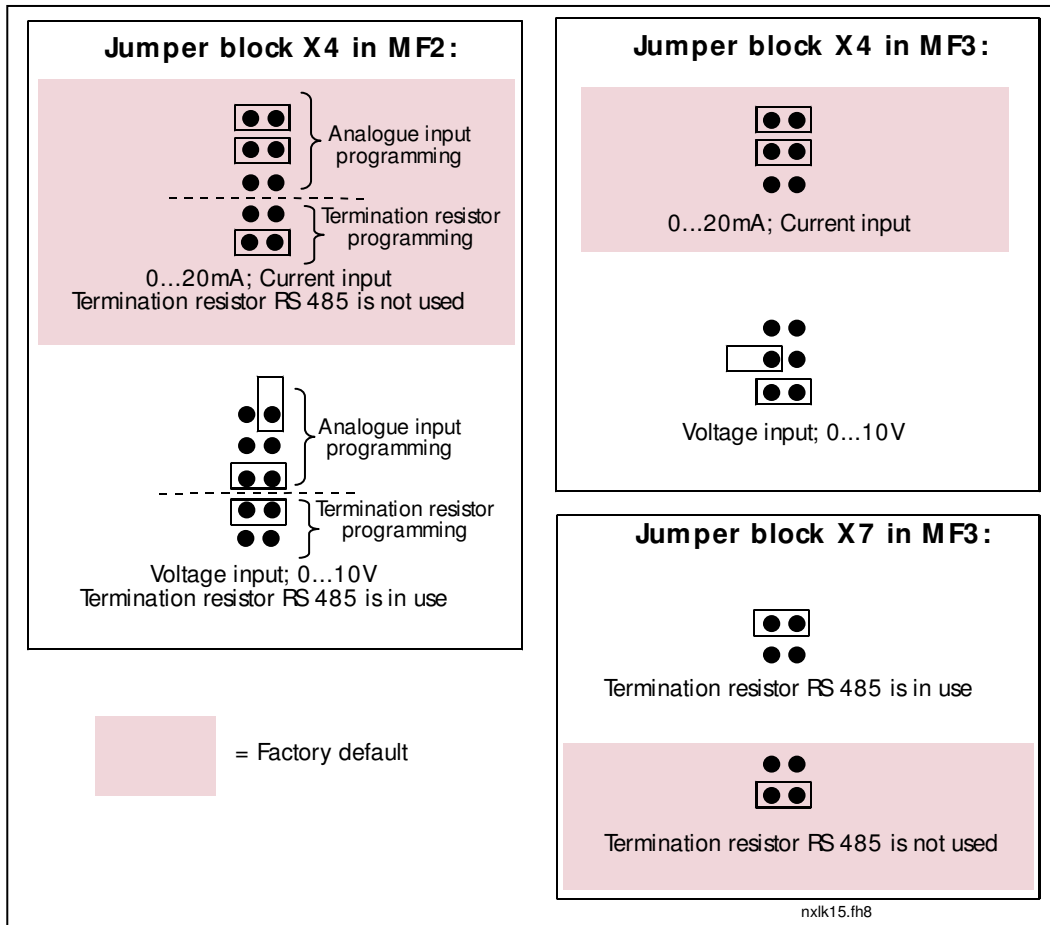

Figure 6-22. Jumper selection for NXL, MF2 and MF3

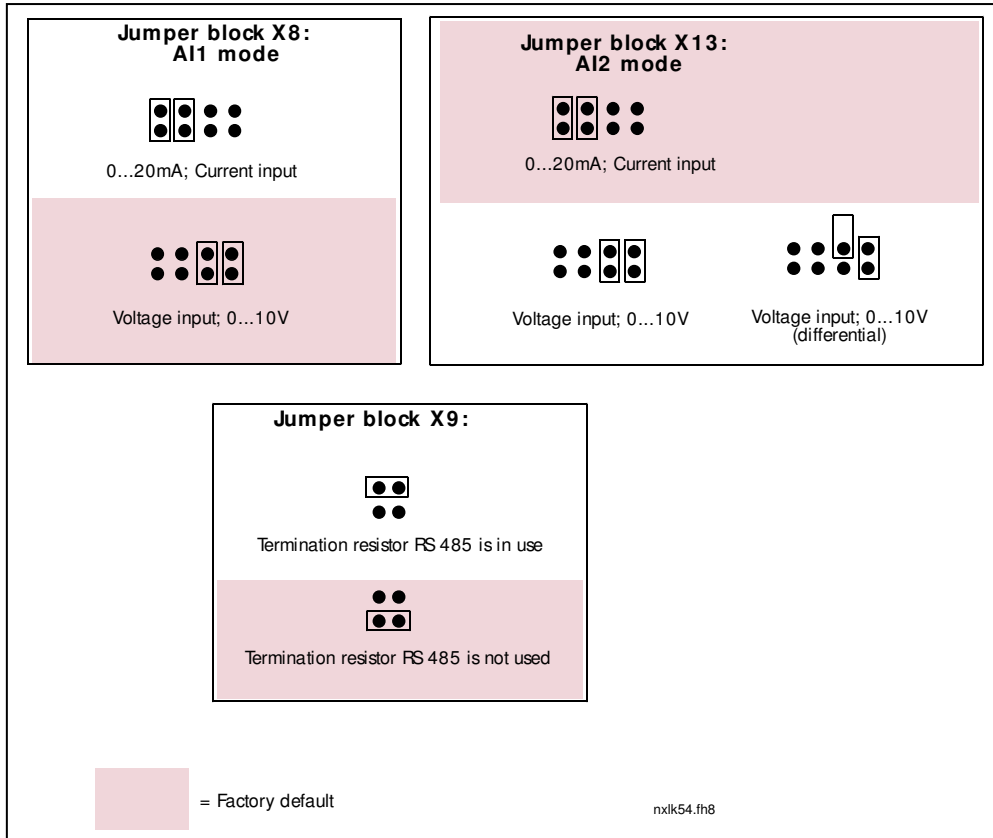



Figure 6-23. Jumper selection for NXL HVAC, MF4 – MF6

 WARNING	<p>Check the correct positions of the jumpers. Running the motor with signal settings different from the jumper positions will not harm the frequency converter but may damage the motor.</p>
 NOTE	<p>If you change the AI signal content also remember to change the corresponding parameters (S6.9.1, 6.9.2) in System Menu.</p>

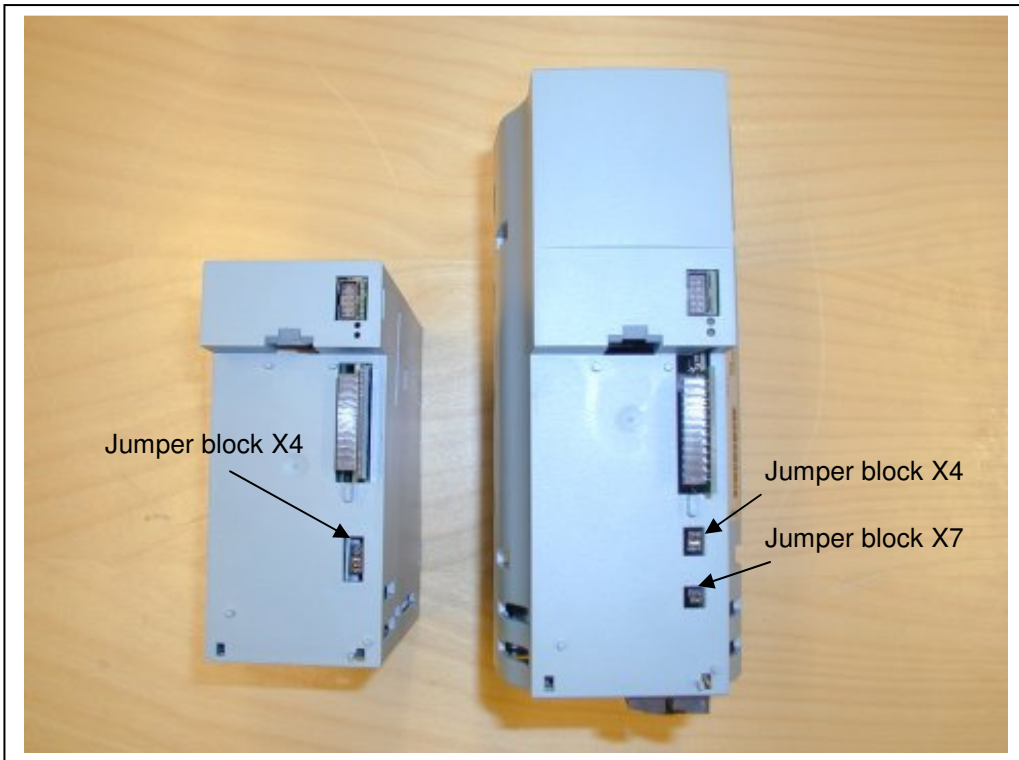

Figure 6-24. The location of jumper blocks in MF2 (left) and MF3 (right)

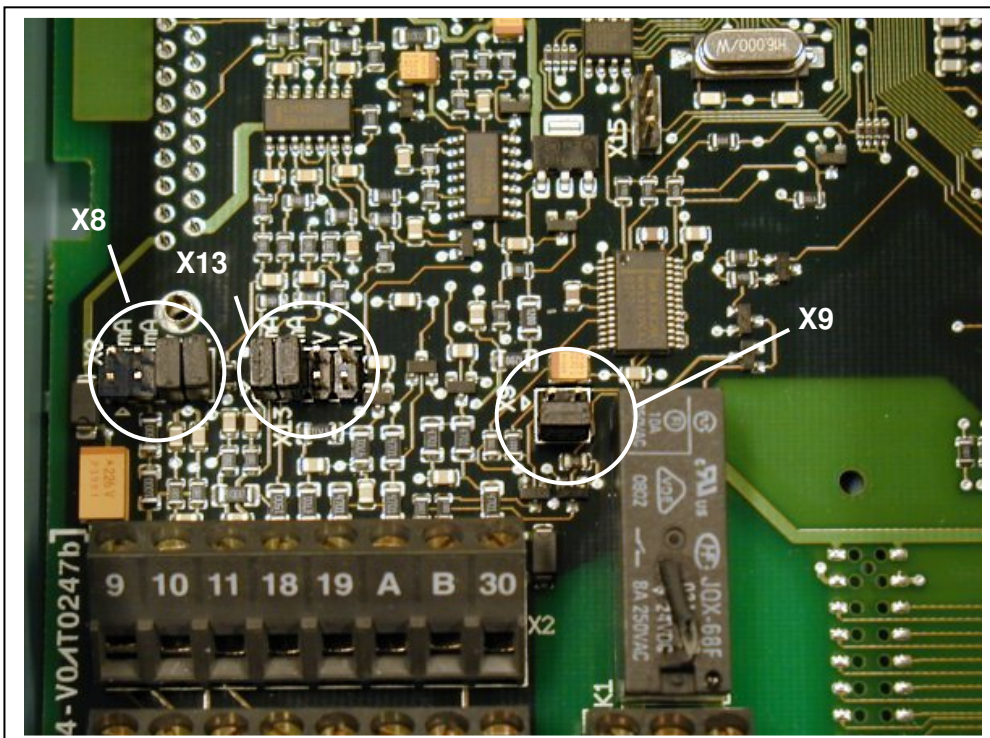

Figure 6-25. The location of jumper blocks in the control board of NXL HVAC

6.2.6 Motor thermistor (PTC) connection

There are three possibilities to connect a PTC resistor to NXL:

1. With optional board NXLOPTAI. (Recommended method. Board included in NXL HVAC as standard)

NXL equipped with NXLOPTAI fulfils IEC 664 if the motor thermistor is insulated (= effective double insulation).

2. With optional board NXOPTB2.

NXL equipped with NXOPTB2 fulfils IEC 664 if the motor thermistor is insulated (= effective double insulation).

3. With the digital input (DIN3) of NXL.

The DIN3 is galvanically connected to other I/O's of NXL.

This is why reinforced or double insulation of the thermistor (IEC 664) is absolutely required outside the frequency converter (in the motor or between the motor and the frequency converter).

Figure 6-26. Motor thermistor (PTC) connection

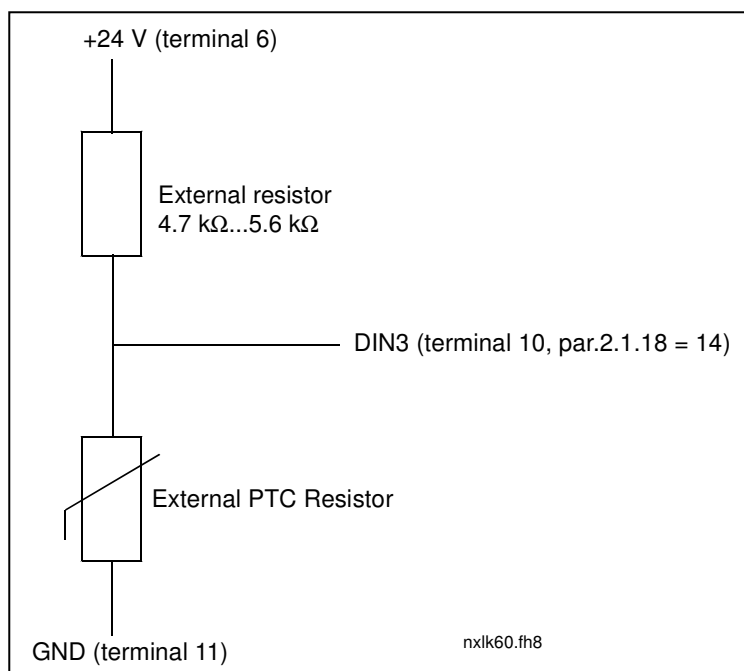



Note! The NXL trips when PTC impedance exceeds 4,7 kΩ



It is strongly recommended to use NXLOPTAI or NXOPTB2 board for motor thermistor connection.

If the motor thermistor is connected to DIN3, the instructions above **must be** followed; otherwise a serious safety hazard may result from the connection.

7. CONTROL KEYPAD

The control keypad is the link between the NXL frequency converter and the user. The NXL control keypad features a seven-segment display with seven indicators for the Run status (RUN, , , READY, STOP, ALARM, FAULT) and three indicators for the control place (I/O term, Keypad, Bus/Comm).

The control information, i.e. the number of menu, the displayed value and the numeric information are presented with numeric symbols.

The frequency converter is operable through the seven push-buttons of the control keypad. Furthermore, the keypad serves the purposes of parameter setting and value monitoring.

The keypad is detachable and isolated from the input line potential.

7.1 Indications on the Keypad display

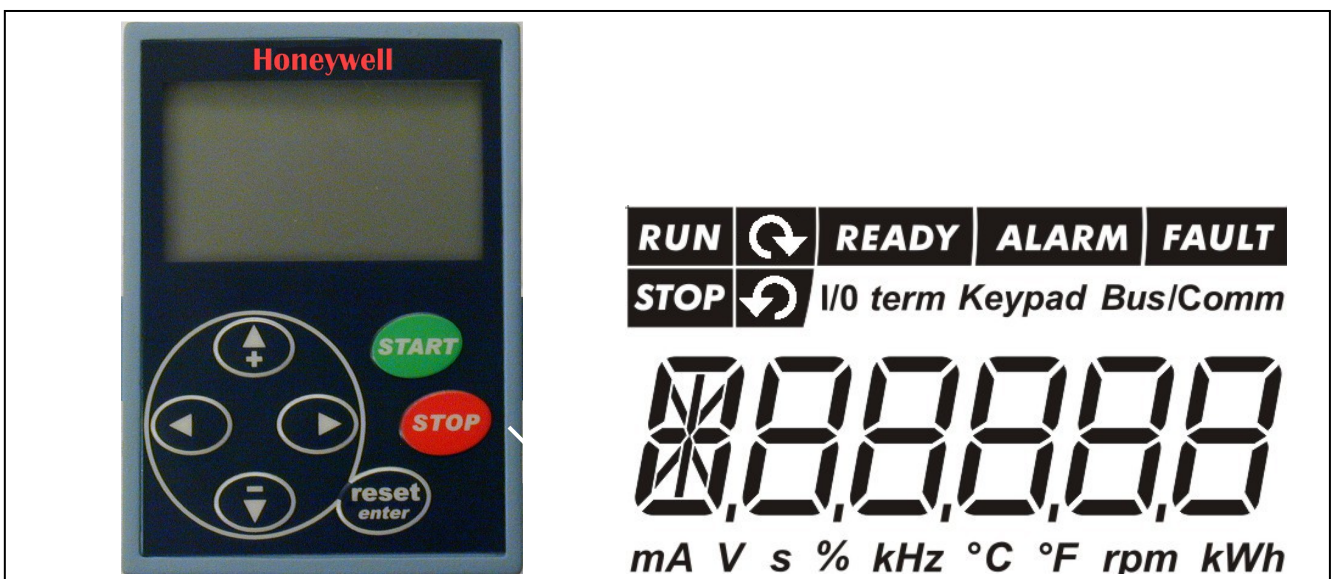



Figure 7-1. NXL control keypad and drive status indications

7.1.1 Drive status indications

The drive status indications tell the user what the status of the motor and the drive is.

- 1 RUN = Motor is running; Blinks when the stop command has been given but the frequency is still ramping down.
- 2   = Indicate the direction of motor rotation.
- 3 STOP = Indicates that the drive is not running.
- 4 READY = Lights when AC power is on. In case of a fault, the symbol will not light up.
- 5 ALARM = Indicates that the drive is running outside a certain limit and a warning is given.
- 6 FAULT = Indicates that unsafe operating conditions were encountered due to which the drive was stopped.

7.1.2 Control place indications

The symbols *I/O term*, *Keypad* and *Bus/Comm* (see chapter 7.4.3.1) indicate the choice of control place made in the Keypad control menu (see chapter 7.4.3).

- a ***I/O term*** = I/O terminals are the selected control place; i.e. START/STOP commands or reference values are given through the I/O terminals.
- b ***Keypad*** = Control keypad is the selected control place; i.e. the motor can be started or stopped and its reference values altered from the keypad.
- c ***Bus/Comm*** = The frequency converter is controlled through a fieldbus.

7.1.3 Numeric indications

The numeric indications provide the user with information on his present location in the keypad menu structure as well as with information related to the operation of the drive.

7.2 Keypad push-buttons

The NXL seven-segment control keypad features 7 push-buttons that are used for the control of the frequency converter (and motor) and parameter setting.

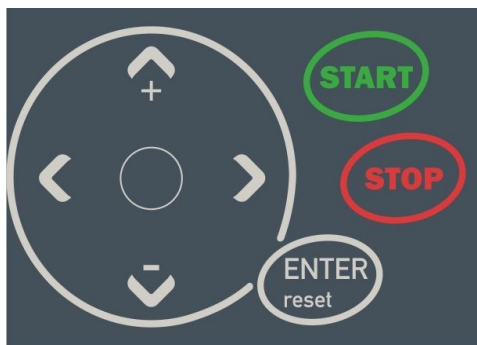







Figure 7-2. Keypad push-buttons

7.2.1 Button descriptions

-  = There are two operations integrated in this button. The button operates mainly as reset button except in the parameter edit mode. The button operation is shortly described below.
- ENTER** = The Enter button serves for:
 - 1) confirmation of selections
 - 2) fault history reset (2...3 seconds)
- reset** = This button is used to reset active faults.
Note! The motor may start immediately after resetting the faults.
-  = Browser button up
 Browse the main menu and the pages of different submenus.
 Edit values.
-  = Browser button down
 Browse the main menu and the pages of different submenus.
 Edit values.
-  = Menu button left
 Move backward in menu.
 Move cursor left (in parameter edit mode).
 Exit edit mode.
 Hold down for 5 seconds for quick change of control place;
manual (keypad) ↔ remote (fielbuds or I/O).
-  = Menu button right
 Move forward in menu.
 Move cursor right (in parameter edit mode).
 Enter edit mode.



= Start button.
Pressing this button starts the motor if the keypad is the active control place. See Chapter 7.4.3.1.



= Stop button.
Pressing this button stops the motor (unless disabled by parameter P3.4).
Stop button serves also for activating the Start-up Wizard (see below)

7.3 Start-up wizard

NXL has a built-in start-up wizard, which speeds up the programming of the drive. The wizard helps you choose between four different operating modes, Standard, Fan, Pump and High Performance. Each mode has automatic parameter settings optimised for the mode in question. The programming wizard is started by pressing the *Stop button* for 5 seconds, when the drive is in stop mode. See the figure below for the procedure:

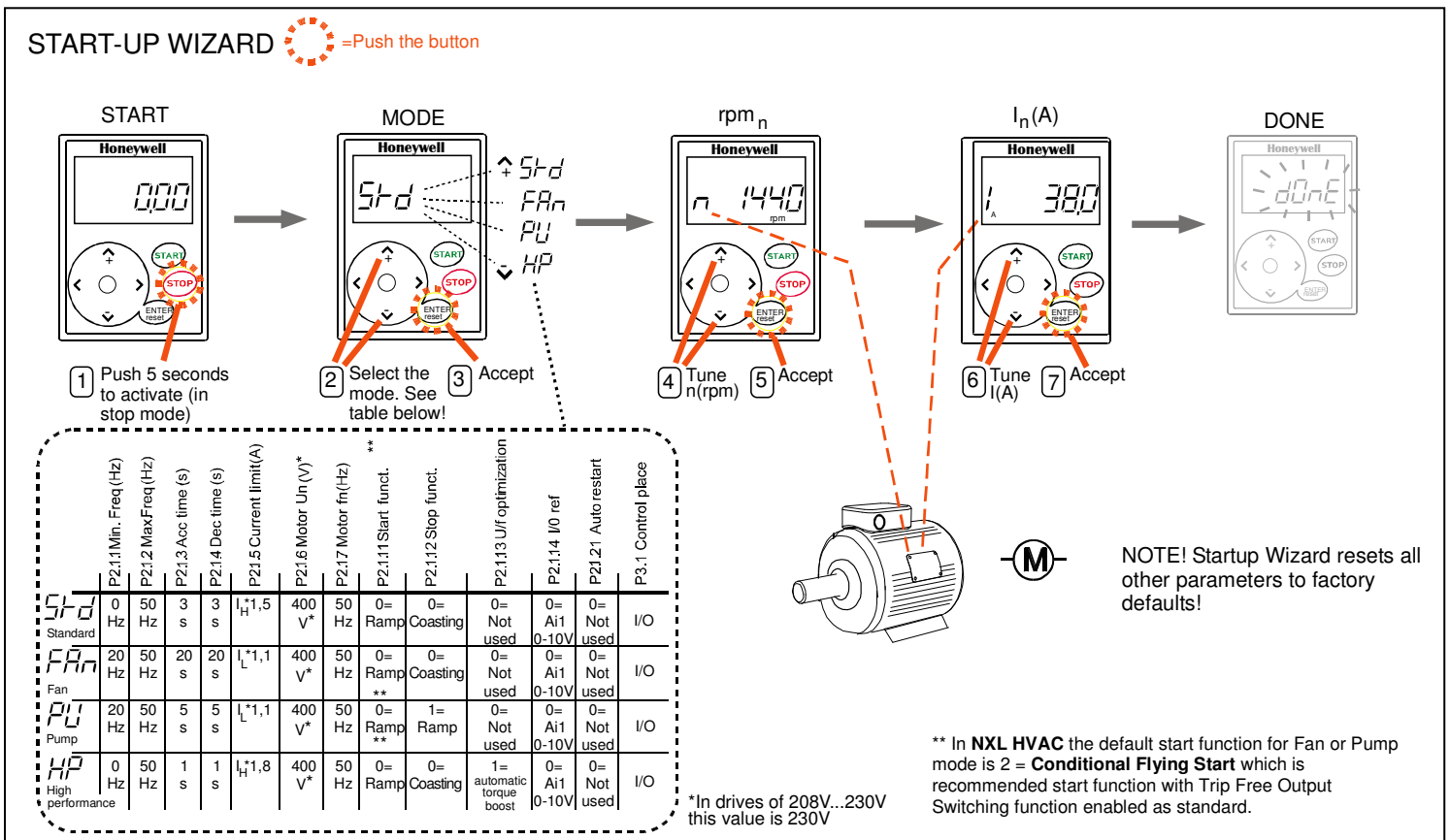
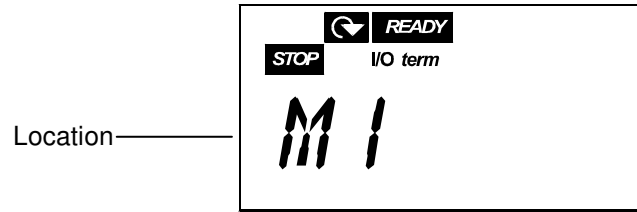

Figure 7-3. NXL Start-up wizard

Note! See the Application manuals for detailed parameter descriptions.

7.4 Navigation on the control keypad

The data on the control keypad are arranged in menus and submenus. The menus are used for example for the display and editing of measurement and control signals, parameter settings (chapter 7.4.2), reference values (Chapter 7.4.3) and fault displays (chapter 7.4.4).



The first menu level consists of menus M1 to E7 and is called the *Main menu*. The user can navigate in the main menu using the *Browser buttons* up and down. The desired submenu can be entered from the main menu using the *Menu buttons*. When there still are pages to enter under the currently displayed menu or page, the last digit of the figure on the display is blinking and by pressing the *Menu button right*, you can reach the next menu level.

The control keypad navigation chart is shown on page 46. Please note that the menu **M1** is located in the lower left corner. From there you will be able to navigate your way up to the desired menu using the menu and browser buttons.

More detailed descriptions of the menus you will find later in this Chapter.

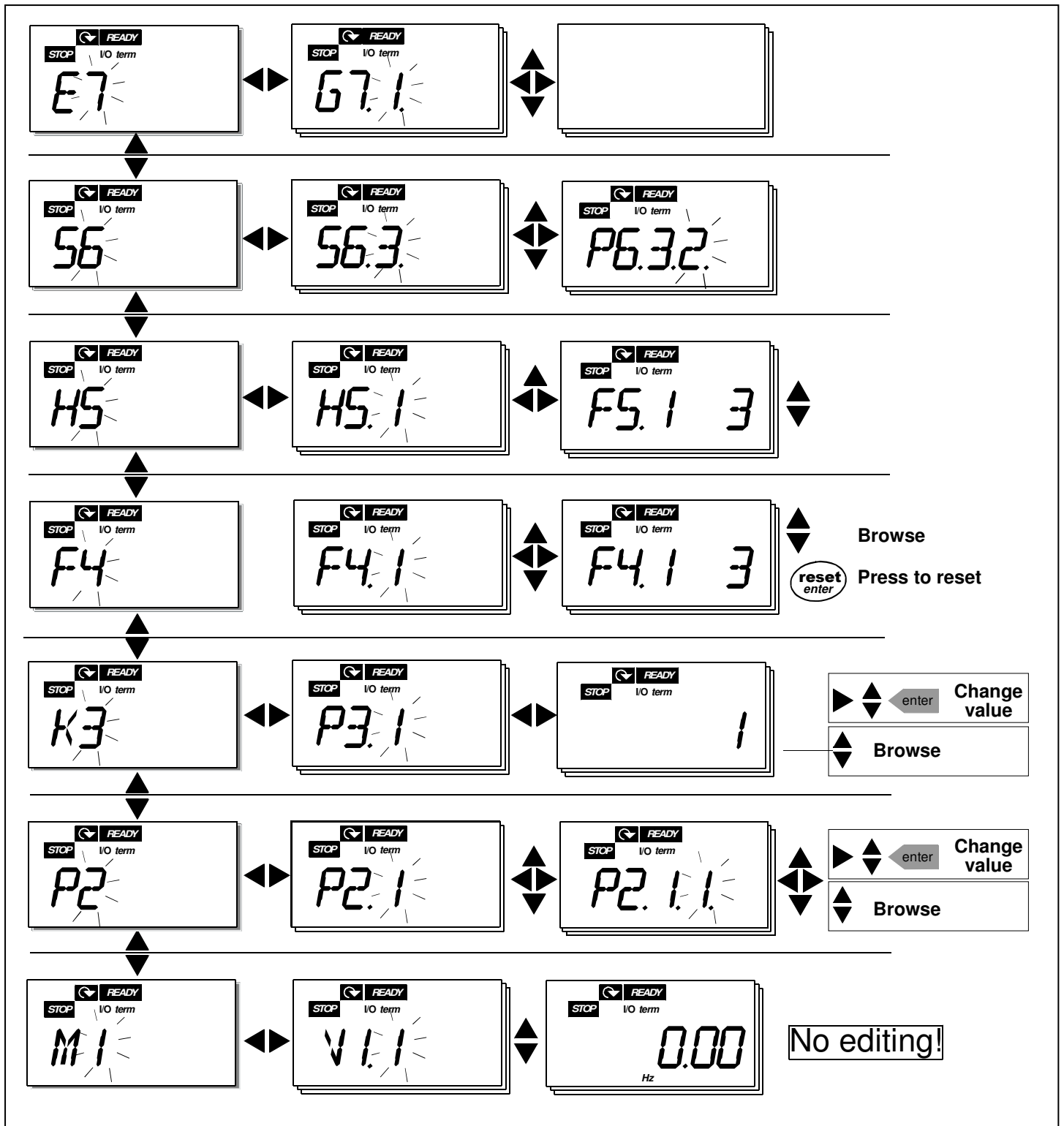

Figure 7-4. Keypad navigation chart

Menu functions

Code	Menu	Min	Max	Selections
M1	Monitoring menu	V1.1	V1.24	See chapter 7.4.1 for the monitoring values
P2	Parameter menu	P2.1	P2.10	NXL HVAC P2.1 = HVAC parameters P2.1.15 = Basic parameters NXL Compact P2.1 = Basic parameters
				P2.2 = Input signals P2.3 = Output signals P2.4 = Drive control P2.5 = Prohibit frequencies P2.6 = Motor control P2.7 = Protections P2.8 = Autorestart P2.9 = PID control P2.10 = Pump and fan control See the application manuals for detailed parameter lists
K3	Keypad control menu	P3.1	P3.6	P3.1 = Selection of control place R3.2 = Keypad reference P3.3 = Keypad direction P3.4 = Stop button activation P3.5 = PID reference 1 P3.6 = PID reference 2
F4	Active faults menu			Shows the active faults and their types
H5	Fault history menu			Shows the fault history list
S6	System menu	S6.3	S6.10	S6.3 = Copy parameters S6.5 = Security S6.6 = Keypad settings S6.7 = Hardware settings S6.8 = System info S6.9 = AI mode S6.10 = Fieldbus parameters Parameters are described in chapter 7.4.7
E7	Expander board menu	E7.1	E7.2	E7.1 = Slot D E7.2 = Slot E

Table 7-1. Main menu functions

7.4.1 Monitoring menu (M1)

You can enter the Monitoring menu from the Main menu by pushing the *Menu button right* when the location indication **M1** is visible on the display. How to browse through the monitored values is presented in Figure 7-5.

The monitored signals carry the indication **V#.#** and they are listed in Table 7-2. The values are updated once every 0.3 seconds.

This menu is meant only for value checking. The values cannot be altered here. For changing values of parameters see Chapter 7.4.2.

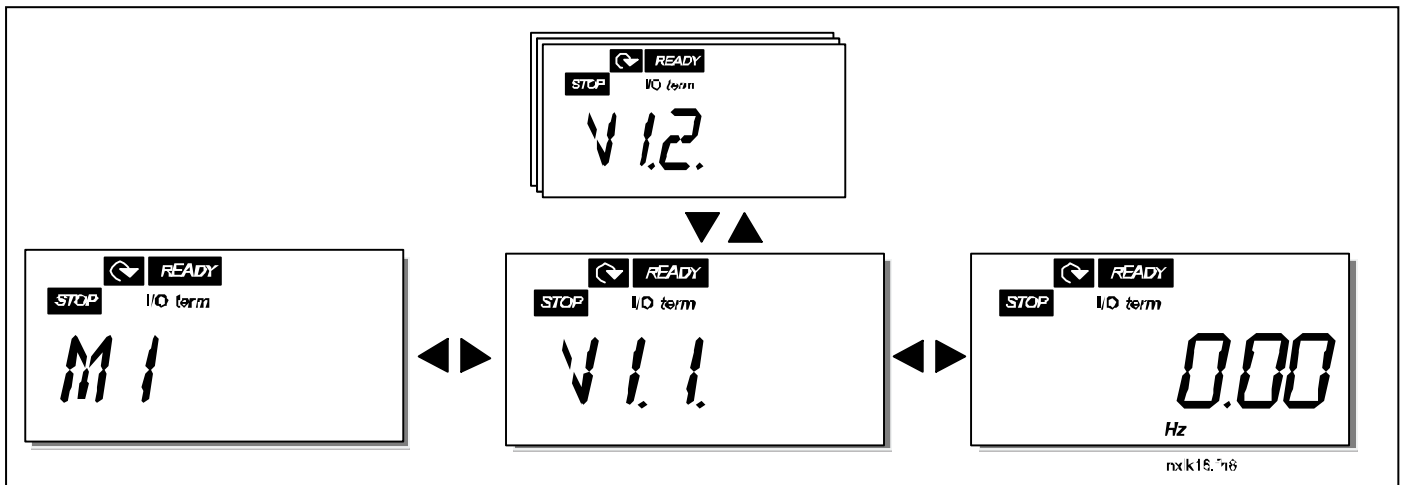

Figure 7-5. Monitoring menu

Code	Signal name	Unit	ID	Description
V1.1	Output frequency	Hz	1	Frequency to the motor
V1.2	Frequency reference	Hz	25	
V1.3	Motor speed	rpm	2	Calculated motor speed
V1.4	Motor current	A	3	Measured motor current
V1.5	Motor torque	%	4	Calculated actual torque/nominal torque of the motor
V1.6	Motor power	%	5	Calculated actual power/nominal power of the motor
V1.7	Motor voltage	V	6	Calculated motor voltage
V1.8	DC-link voltage	V	7	Measured DC-link voltage
V1.9	Unit temperature	°C	8	Heat sink temperature
V1.10	Analogue input 1		13	AI1
V1.11	Analogue input 2		14	AI2
V1.12	Analogue output current	mA	26	AO1
V1.13	Analogue output current 1, expander board	mA	31	
V1.14	Analogue output current 2, expander board	mA	32	
V1.15	DIN1, DIN2, DIN3		15	Digital input statuses
V1.16	DIE1, DIE2, DIE3		33	I/O expander board: Digital input statuses
V1.17	RO1		34	Relay output 1 status
V1.18	ROE1, ROE2, ROE3		35	I/O exp. board: Relay output statuses
V1.19	DOE 1		36	I/O exp. board: Digital output 1 status
V1.20	PID Reference	%	20	In percent of the maximum process reference
V1.21	PID Actual value	%	21	In percent of the maximum actual value
V1.22	PID Error value	%	22	In percent of the maximum error value
V1.23	PID Output	%	23	In percent of the maximum output value
V1.24	Autochange outputs 1,2,3		30	Used only in Pump and Fan Cascade control
V1.25	Mode		66	Shows the current drive configuration mode selected with start-up wizard: 0 = No mode selected (Default) 1 = Standard 2 = Fan 3 = Pump 4 = High performance

Table 7-2. Monitored signals

7.4.2 Parameter menu (P2)

Parameters are the way of conveying the commands of the user to the frequency converter. The parameter values can be edited by entering the *Parameter Menu* from the *Main Menu* when the location indication **P2** is visible on the display. The value editing procedure is presented in Figure 7-6.

Push the *Menu button right* once to move into the *Parameter Group Menu (G#)*. Locate the parameter group desired by using the *Browser buttons* and push the *Menu button right* again to enter the group and its parameters. Use again the *Browser buttons* to find the parameter (*P#*) you want to edit. Pushing the *Menu button right* takes you to the edit mode. As a sign of this, the parameter value starts to blink. You can now change the value in two different manners:

- 1 Just set the new desired value with the *Browser buttons* and confirm the change with the *Enter button*. Consequently, the blinking stops and the new value is visible in the value field.
- 2 Push the *Menu button right* once again. Now you will be able to edit the value digit by digit. This editing manner may come in handy, when a relatively greater or smaller value than that on the display is desired. Confirm the change with the *Enter button*.

The value will not change unless the Enter button is pushed. Pressing the *Menu button left* takes you back to the previous menu.

Several parameters are locked, i.e. not editable, when the drive is in RUN status. The frequency converter must be stopped in order to edit these parameters.

The parameters values can also be locked using the function in menu **S6** (see Chapter 7.4.7.2).

You can return to the *Main menu* anytime by pressing the *Menu button left* for 1—2 seconds.

The basic parameters are listed in Chapter 8.3. You will find the complete parameter lists and descriptions in the HVAC and Multi-Control Application manuals.

Once in the last parameter of a parameter group, you can move directly to the first parameter of that group by pushing the *Browser button up*.

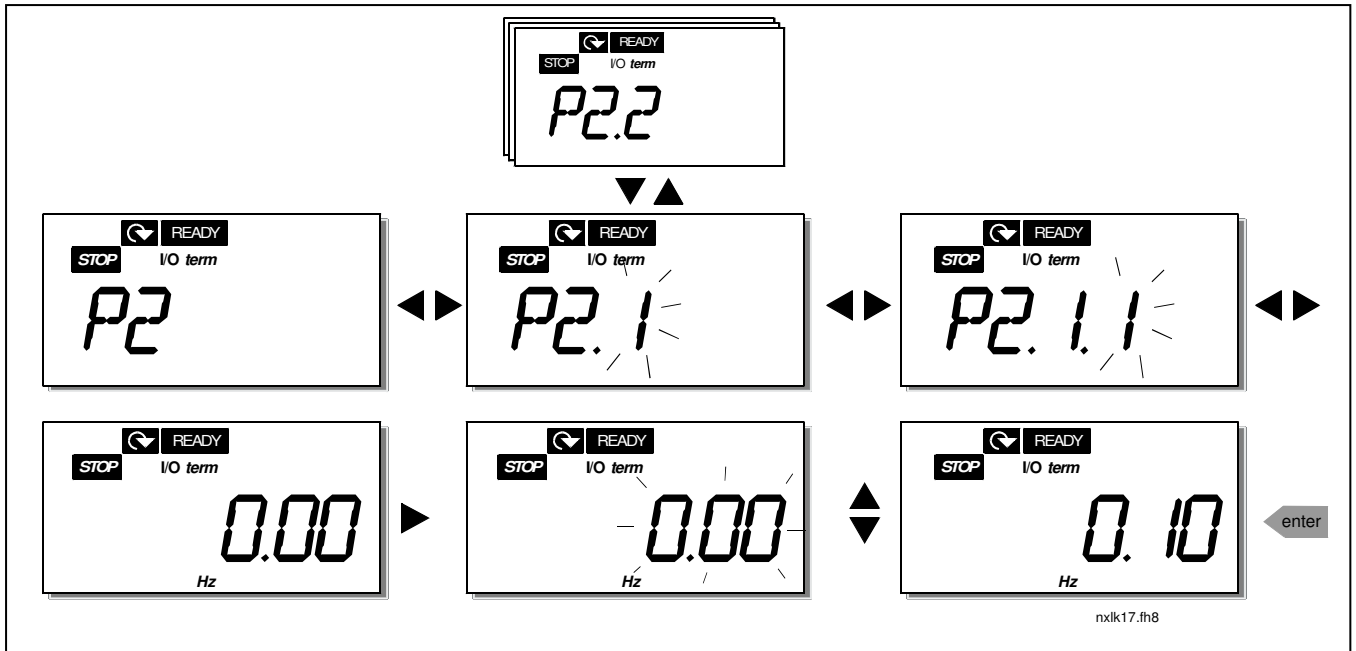

Figure 7-6. Parameter value change procedure

7.4.3 Keypad control menu (K3)

In the *Keypad Controls Menu*, you can choose the control place, edit the frequency reference and change the direction of the motor. Enter the submenu level with the *Menu button right*.

Parameters in Menu K3	Selections
P3.1 = Selection of control place	1 = I/O terminals 2 = Keypad 3 = Fieldbus
R3.2 = Keypad reference	
P3.3 = Keypad direction	0 = Forward 1 = Reverse
P3.4 = Stop button activation	0 = Limited function of Stop button 1 = Stop button always enabled
P3.5 = PID reference 1	
P3.6 = PID reference 2	

7.4.3.1 Selection of control place

There are three different places (sources) which the frequency converter can be controlled from. For each control place, a different symbol will appear on the alphanumeric display:

Control place	Symbol
I/O terminals	<i>I/O term</i>
Keypad (panel)	<i>Keypad</i>
Fieldbus	<i>Bus/Comm</i>

Change the control place by entering the edit mode with the *Menu button right*. The options can then be browsed through with the *Browser buttons*. Select the desired control place with the *Enter button*. See the diagram below. See also Chapter 7.4.3 above.

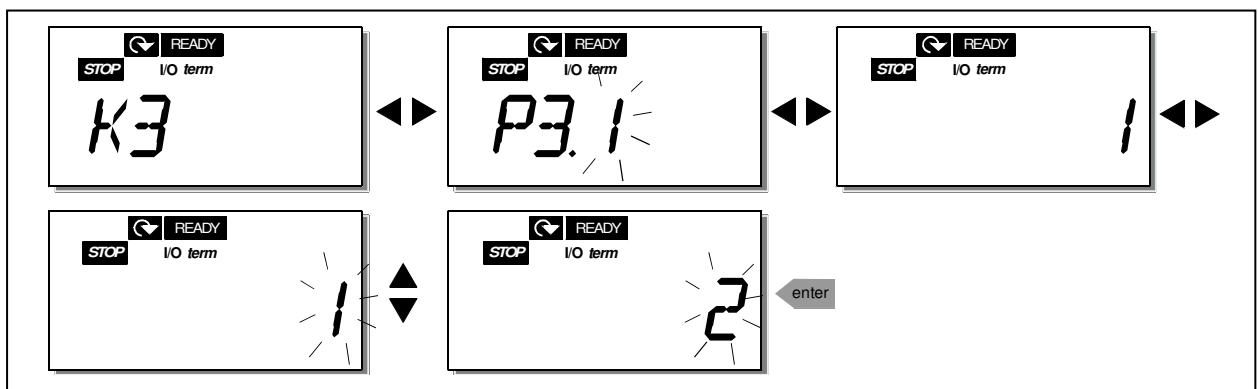

Figure 7-7. Selection of control place

7.4.3.2 Keypad reference

The keypad reference submenu (**R3.2**) displays and allows the operator to edit the frequency reference. The changes will take place immediately. **This reference value will not, however, influence the rotation speed of the motor unless the keypad has been selected as the active control place.**

NOTE: The maximum difference between the output frequency and the keypad reference is 6 Hz. The application software monitors the keypad frequency automatically.

See Figure 7-6 for how to edit the reference value (pressing the *Enter button* is not, however, necessary).

7.4.3.3 Keypad direction

The keypad direction submenu displays and allows the operator to change the rotating direction of the motor. **This setting will not, however, influence the rotation direction of the motor unless the keypad has been selected as the active control place.**

See Figure 7-7 for how to change the rotation direction.

7.4.3.4 Stop button activation

By default, pushing the STOP button will **always** stop the motor regardless of the selected control place. You can disable this function by giving parameter 3.4 the value **0**. If the value of this parameter is **0**, the STOP button will stop the motor only **when the keypad has been selected as the active control place.**

See Figure 7-7 for how to change the value of this parameter.

7.4.4 Active faults menu (F4)

The *Active faults menu* can be entered from the *Main menu* by pushing the *Menu button right* when the location indication **F4** is visible on the keypad display.

The memory of active faults can store the maximum of 5 faults in the order of appearance. The display can be cleared with the *Reset button* and the read-out will return to the same state it was before the fault trip. The fault remains active until it is cleared with the *Reset button* or with a reset signal from the I/O terminal.

Note! Remove external Start signal before resetting the fault to prevent unintentional restart of the drive.

Normal state,
no faults:

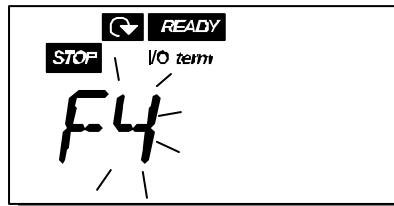

7.4.4.1 Fault types

In the NXL frequency converter, there are two different types of faults. These types differ from each other on the basis of the subsequent behaviour of the drive. See Table 7-3. Fault types.

Figure 7-8. Fault display

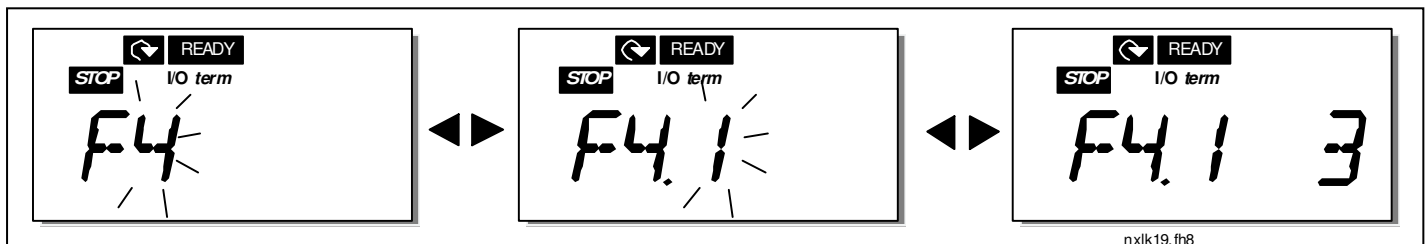

Fault type symbol	Meaning
A (Alarm)	This type of fault is a sign of an unusual operating condition. It does not cause the drive to stop, nor does it require any special actions. The 'A fault' remains in the display for about 30 seconds.
F (Fault)	A 'F fault' is a kind of fault that makes the drive stop. Actions need to be taken in order to restart the drive.

Table 7-3. Fault types

7.4.5 Fault codes

The fault codes, their causes and correcting actions are presented in the table below. The shadowed faults are A faults only. The items written in white on black background present faults for which you can program different responses in the application. See parameter group Protections.

Note! When you contact the factory or the distributor due to a fault, it is advisable to write down all fault texts and codes that appear on the keypad

Fault code	Fault	Possible cause	Correcting measures
1	Overcurrent	Frequency converter has detected too high a current ($>4 \cdot I_n$) in the motor cable: <ul style="list-style-type: none"> – sudden heavy load increase – short circuit in motor cables – unsuitable motor 	Check loading. Check motor size. Check cables.
2	Overvoltage	The DC-link voltage has exceeded the limits defined in Table 4-3. <ul style="list-style-type: none"> – too short a deceleration time – high overvoltage spikes in supply 	Make the deceleration time longer.
3	Earth fault	Current measurement has detected that the sum of motor phase current is not zero. <ul style="list-style-type: none"> – insulation failure in cables or motor 	Check motor cables and motor.
8	System fault	<ul style="list-style-type: none"> - component failure - faulty operation 	Reset the fault and restart. Should the fault re-occur, contact the distributor near to you.
9	Undervoltage	DC-link voltage is under the voltage limits defined in Table 4-3. <ul style="list-style-type: none"> – most probable cause: too low a supply voltage – frequency converter internal fault 	In case of temporary supply voltage break reset the fault and restart the frequency converter. Check the supply voltage. If it is adequate, an internal failure has occurred. Contact the distributor near to you.
11	Output phase supervision	Current measurement has detected that there is no current in one motor phase.	Check motor cable and motor.
13	Frequency converter under temperature	Heatsink temperature is under -10°C	
14	Frequency converter overtemperature	Heatsink temperature is over 90°C . Overtemperature warning is issued when the heatsink temperature exceeds 85°C .	Check the correct amount and flow of cooling air. Check the heatsink for dust. Check the ambient temperature (p2.6.8). Make sure that the switching frequency is not too high in relation to ambient temperature and motor load.
15	Motor stalled	Motor stall protection has tripped.	Check motor. Check that Pump or Fan is not jammed
16	Motor overtemperature	Motor overheating has been detected by frequency converter motor temperature model. Motor is overloaded.	Decrease the motor load. If no motor overload exists, check the temperature model parameters.

17	Motor underload/ Pump Dry detection/ Broken belt Detection	Motor underload protection has tripped.	FAN: check that Belt is not broken PUMP: check that Pump is not dry
22	EEPROM checksum fault	Parameter save fault – faulty operation – component failure	Contact the distributor near to you
24	Counter fault	Values displayed on counters are incorrect	
25	Microprocessor watchdog fault	– faulty operation – component failure	Reset the fault and restart. Should the fault re-occur, contact the distributor near to you.
29	Thermistor fault	The thermistor input of option board has detected increase of the motor temperature	Check motor cooling and loading Check thermistor connection (If thermistor input of the option board is not in use it has to be short circuited)
34	Internal bus communication	Ambient interference or defective hardware	Reset the fault and restart Should the fault re-occur, contact the distributor near to you.
35	Application fault	Selected application does not function.	Contact the distributor near to you.
39	Device removed	Option board removed. Drive removed.	Reset
40	Device unknown	Unknown option board or drive.	Contact the distributor near to you.
41	IGBT temperature	IGBT Inverter Bridge overtemperature protection has detected too high a motor current.	Check loading. Check motor size.
44	Device change	Option board changed. Option board has default settings.	Reset
45	Device added	Option board added.	Reset
50	Analogue input $I_{in} < 4\text{mA}$ (selected signal range 4 to 20 mA)	Current at the analogue input is $< 4\text{mA}$. – control cable is broken or loose – signal source has failed	Check the current loop circuitry.
51	External fault	Digital input fault. Digital input has been programmed as external fault input and this input is active.	Check the programming and the device indicated by the external fault information. Check also the cabling of this device.
52	Keypad communication fault	The connection between the control keypad and the frequency converter is broken.	Check keypad connection and possible keypad cable.

53	Fieldbus fault	The data connection between the fieldbus Master and the fieldbus board is broken	Check installation. If installation is correct contact the nearest Honeywell distributor
54	Slot fault	Defective option board or slot	Check board and slot. Contact the nearest Honeywell distributor
55	Actual value supervision	Actual value has exceeded or fallen below (depending on par. 2.7.22) the actual value supervision limit (par. 2.7.23)	

Table 7-4. Fault codes

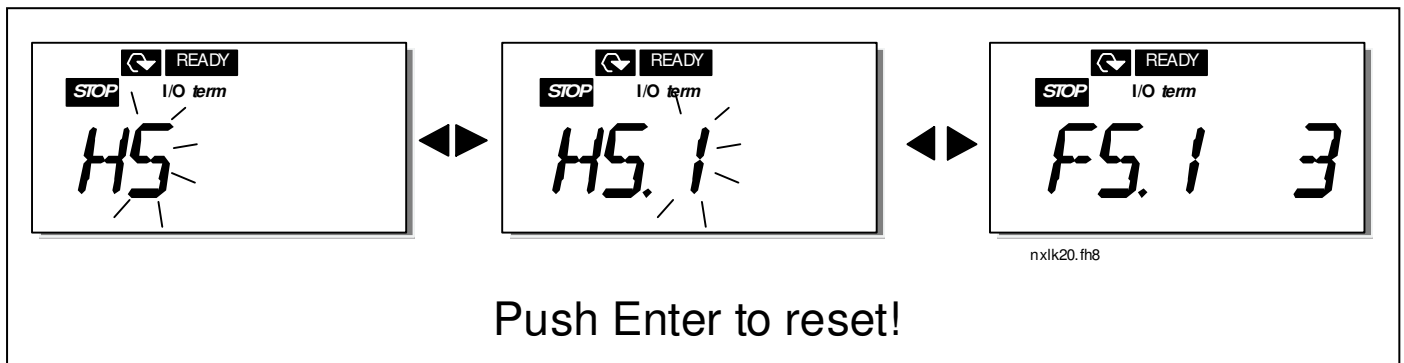

7.4.6 Fault history menu (H5)

The *Fault history menu* can be entered from the *Main menu* by pushing the *Menu button right* when the location indication **H5** is visible on the keypad display.

All faults are stored in the *Fault history menu* in which you can browse through them using the *Browser buttons*. You can return to the previous menu anytime by pushing the *Menu button left*.

The memory of the frequency converter can store a maximum of 5 faults in the order of appearance. The latest fault carries the indication H5.1, the second latest H5.2 etc. If there are 5 uncleared faults in the memory the next occurring fault will erase the oldest from the memory.

Pressing the *Enter button* for about 2 to 3 seconds resets the whole fault history.

Figure 7-9. Fault history menu

7.4.7 System menu (S6)

The *System menu* can be entered from the main menu by pushing the *Menu button right* when the location indication **S6** is visible on the display.

The controls associated with the general use of the frequency converter, such as keypad settings, customised parameter sets or information about the hardware and software are located under the *System menu*.

Below you will find a list of the functions available in the System menu.

Functions in the System menu

Code	Function	Min	Max	Unit	Default	Cust	Selections
S6.3	Copy parameters						
P6.3.1	Parameter sets						0 = Select 1 = Store set 1 2 = Load set 1 3 = Store set 2 4 = Load set 2 5 = Load factory defaults 6 = Fault 7 = Wait 8 = OK
S6.5	Security						
P6.5.2	Parameter lock	0	1		0		0 = Change Enabled 1 = Change Disabled
S6.6	Keypad settings						
P6.6.1	Default page	0			1.1		
P6.6.3	Timeout time	5	65535	s	1200		
S6.7	Hardware settings						
P6.7.2	Fan control	0			0		0 = Continuous 1 = Temperature (only sizes MF4 and bigger)
P6.7.3	HMI acknowledg. timeout	200	5000	ms	200		
P6.7.4	HMI number of retries	1	10		5		
S6.8	System info						
S6.8.1	Counters menu						
C6.8.1.1	MWh counter			KWh			
C6.8.1.2	Operating days counter			hh:mm:ss			
C6.8.1.3	Operating hours counter			hh:mm:ss			
S6.8.2	Trip counters						
T6.8.2.1	MWh trip counter			kWh			
P6.8.2.2	Clear MWh trip counter						0 = No action 1 = Clear MWh trip counter
T6.8.2.3	Operating days trip counter						

T6.8.2.4	Operating hours trip counter			hh:mm:ss			
P6.8.2.5	Clear operating time counter						0 = No action 1 = Clear T6.8.2.3, T6.8.2.4
S6.8.3	Software info						
I6.8.3.1	Software package						Scroll information with menu button right
I6.8.3.2	System SW version						
I6.8.3.3	Firmware interface						
I6.8.3.4	System load			%			
S6.8.4	Application info						
S6.8.4.1	Application						
A6.8.4.1.1	Application id						
A6.8.4.1.2	Application version						
A6.8.4.1.3	Firmware interface						
S6.8.5	Hardware info						
I6.8.5.2	Unit voltage			V			
I6.8.5.3	Brake chopper						0=Not present, 1=Present
S6.8.6	Options						
S6.8.6.1	Slot E OPT-						Note! the submenus are not showing if no option board is installed
I6.8.6.1.1	Slot E Status	1	5				1=Connection lost 2=Initializing 3=Run 5=Fault
I6.8.6.1.2	Slot E Program version						
S6.8.6.2	Slot D OPT-						Note! the submenus are not showing if no option board is installed
I6.8.6.2.1	Slot D Status	1	5				1=Connection lost 2=Initializing 3=Run 5=Fault
I6.8.6.2.2	Slot D Program version						
S6.9	AI mode						
P6.9.1	AIA1 mode	0	1		0		0=Voltage input 1=Current input (Types MF4 – MF6)
P6.9.2	AIA2 mode	0	1		1		0=Voltage input 1=Current input
S6.10	Fieldbus parameters						
I6.10.1	Communication status						
P6.10.2	Fieldbus protocol	1	1		1		0=Not used 1=Modbus protocol
P6.10.3	Slave address	1	255		1		Addresses 1 – 255
P6.10.4	Baud rate	0	8		5		0=300 baud 1=600 baud 2=1200 baud 3=2400 baud 4=4800 baud 5=9600 baud 6=19200 baud 7=38400 baud 8=57600 baud
P6.10.5	Stop bits	0	1		0		0=1 1=2
P6.10.6	Parity type	0	2		0		0=None 1=Odd 2=Even
P6.10.7	Communication timeout	0	300	s	0		0=Not used 1=1 second 2=2 seconds, etc

Table 7-5. System menu functions

7.4.7.1 Copy parameters

The Copy parameters submenu (**S6.3**) is located under the *System menu*.

The Honeywell NX frequency converter features a possibility for the user to store and load two customised parameter sets (all parameters included in the application, not the system menu parameters) and to load back the factory default parameter values.

Parameter sets (S6.3.1)

On *Parameter sets* page (**S6.3.1**), push the *Menu button right* to enter the *Edit menu*. You can store or load two customised parameter sets or load back the factory defaults. Confirm with the *Enter button*. Wait, until **8 (=OK)** appears on the display.

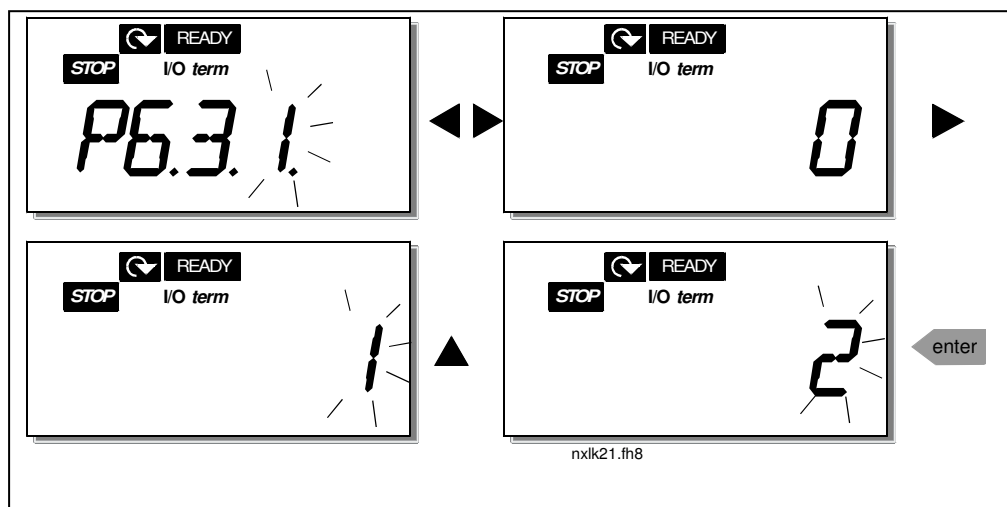

Figure 7-10. Storing and loading of parameter sets

7.4.7.2 Security

The Security submenu (**S6.5**) under the system menu has a function that allows the user to prohibit changes to the parameters.

Parameter lock (P6.5.2)

If the parameter lock is activated the parameter values cannot be edited.

NOTE: This function does not prevent unauthorised editing of parameter values.

Enter the edit mode by pushing the *Menu button right*. Use the *Browser buttons* to change the parameter lock status (**0** = changes enabled, **1** = changes disabled). Accept the change with the *Enter button* or return to the previous level with the *Menu button left*.

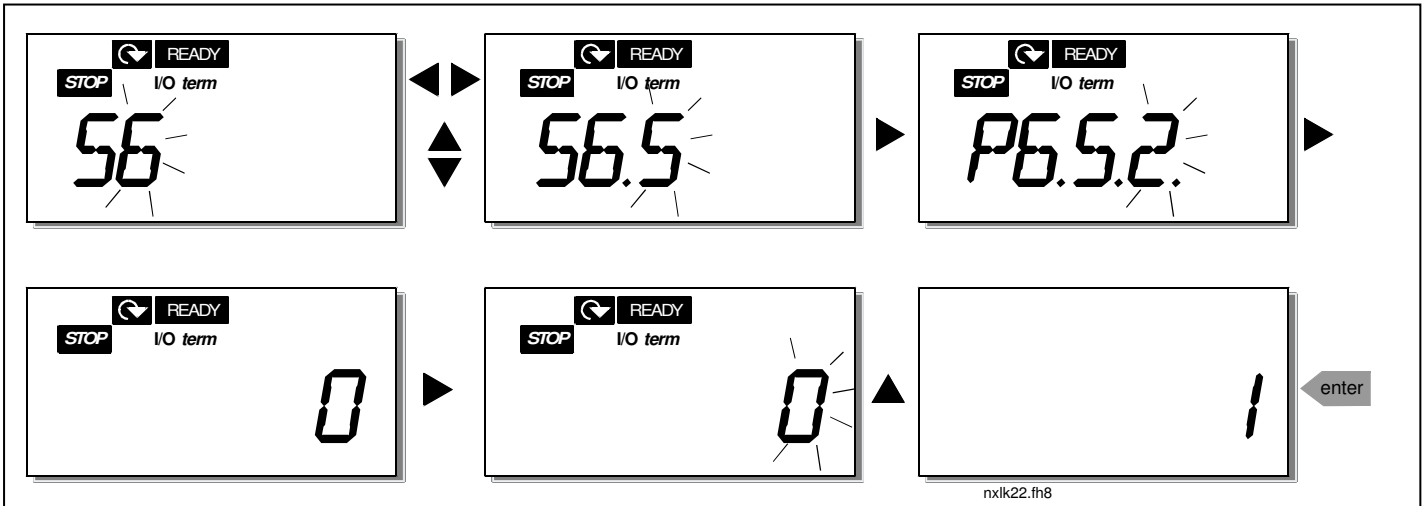

Figure 7-11. Parameter locking

7.4.7.3 Keypad settings

In the submenu **S6.6** under the *System menu* you can further customise your frequency converter operator interface.

Locate the Keypad settings submenu (**S6.6**). Under the submenu, there are two pages (**P#**) associated with the keypad operation, *Default page (P6.6.1)* and *Timeout time (P6.6.3)*

Default page (P6.6.1)

Here you can set the location (page) to which the display automatically moves as the *Timeout time* (see below) has expired or as the power is switched on to the keypad.

Press the *Menu button right* once to enter the edit mode. Pressing the *Menu button right* once again makes you able to edit the number of the submenu/page digit by digit. Confirm the new default page value with the *Enter button*. You can return to the previous step anytime by pushing the *Menu button left*.

Note! If you set a page that does not exist in the menu, the display will automatically move to the last available page in the menu.

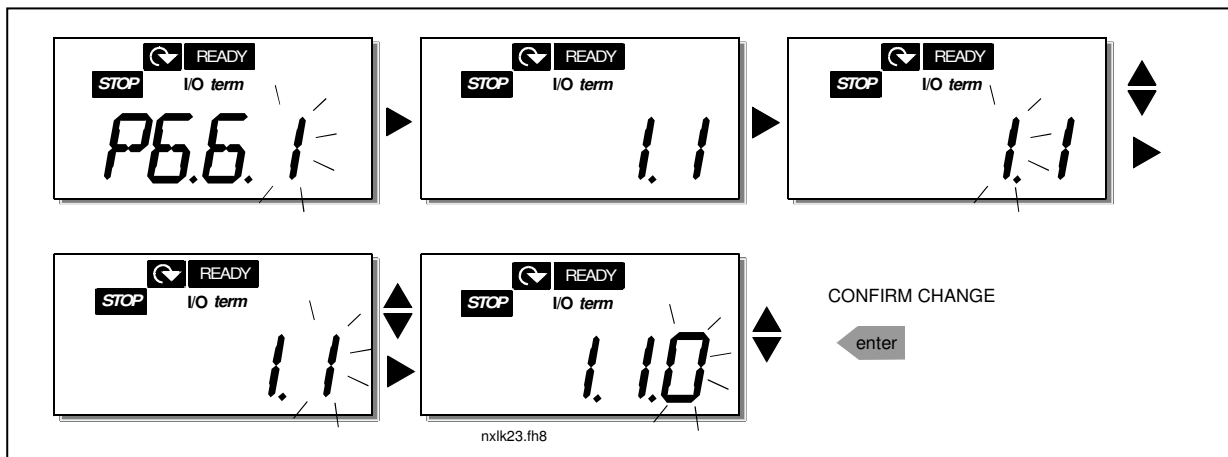

Figure 7-12. Default page function

Timeout time (P6.6.3)

The Timeout time setting defines the time, after which the keypad display returns to the Default Page (P6.6.1), see above.

Move to the Edit menu by pressing the *Menu button right*. Set the timeout time you want and confirm the change with the *Enter button*. You can return to the previous step anytime by pushing the *Menu button left*.

NOTE: This function cannot be disabled.

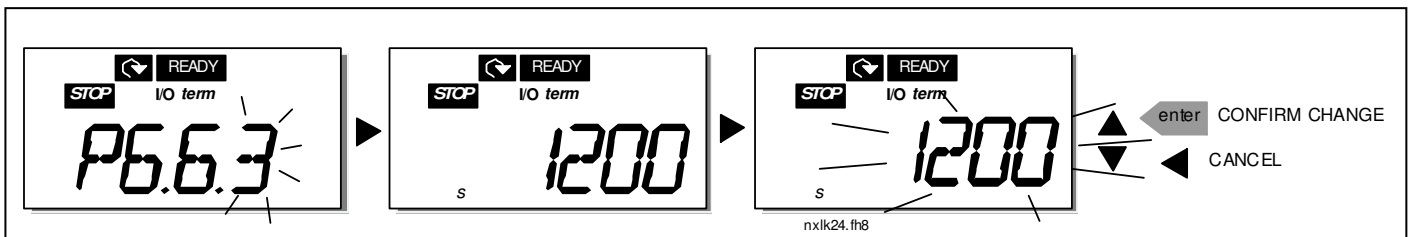

Figure 7-13. Timeout time setting

7.4.7.4 Hardware settings

In the Hardware settings submenu (**S6.7**) you can further customise the settings of the frequency converter with three parameters: **Fan control**, **HMI acknowledgement timeout** and **HMI retry**.

Fan control (P6.7.2)

Note! Only the higher power modules of MF3 have been equipped with a cooling fan, in lower power modules of MF3 the cooling fan is available as optional equipment.

If the cooling fan has been installed in MF3 it runs continuously, when the power is switched on.

NXL HVAC:

This function allows you to control the frequency converter's cooling fan. You can set the fan to run continuously when the power is switched on or depending on the temperature of the unit. If the latter function has been selected the fan is switched on automatically when the heat sink temperature reaches 60°C. The fan receives a stop command when the heat sink temperature falls to 55°C. However the fan runs for about a minute after receiving the stop command, as well as after changing the value from **0** (*Continuous*) to **1** (*Temperature*).

Enter the edit mode by pushing the *Menu button right*. The present mode shown starts to blink. Use the *Browser buttons* to change the fan mode. Accept the change with the *Enter button* or return to the previous level with the *Menu button left*.

HMI acknowledge timeout (P6.7.3)

This function allows the user to change the timeout of the HMI acknowledgement time.

Note! If the frequency converter has been connected to the PC with a **normal cable**, the default values of parameters 6.7.3 and 6.7.4 (200 and 5) **must not be changed**.

If the frequency converter has been connected to the PC via a modem and there is delay in transferring messages, the value of par. 6.7.3 must be set according to the delay as follows:

Example:

- Transfer delay between the frequency converter and the PC = 600 ms
- The value of par. 6.7.3 is set to 1200 ms (2 x 600, sending delay + receiving delay)
- The corresponding setting shall be entered in the [Misc]-part of the file NCDrive.ini:
Retries = 5
AckTimeOut = 1200
TimeOut = 6000

It must also be considered that intervals that are shorter than the AckTimeOut-time cannot be used in NC-Drive monitoring.

Enter the edit mode by pushing the *Menu button right*. Use the *Browser buttons* to change the acknowledgement time. Accept the change with the *Enter button* or return to the previous level with the *Menu button left*. See Figure 7-14 for how to change the HMI acknowledgement timeout.

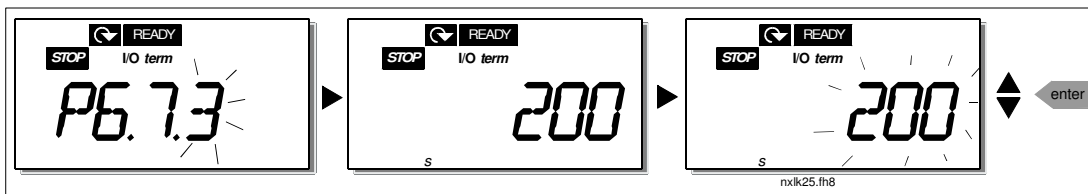

Figure 7-14. HMI acknowledge timeout

Number of retries to receive HMI acknowledgement (P6.7.4)

With this parameter you can set the number of times the drive will try receive acknowledgement if this does not succeed within the acknowledgement time (P6.7.3)

Enter the edit mode by pushing the *Menu button right*. The present value shown starts to blink. Use the *Browser buttons* to change the amount of retries. Accept the change with the *Enter button* or return to the previous level with the *Menu button left*.

7.4.7.5 System information

In the submenu **S6.8** under the *System menu* you can find frequency converter-related hardware and software information as well as operation-related information.

Enter the *Info menu* by pressing the *Menu button right*. Now you can browse through the information pages with the *Browser buttons*.

Counters submenu (S6.8.1)

In the *Counters submenu (S6.8.1)* you can find information related to the frequency converter operation times, i.e. the total numbers of MWh, operation days and operation hours passed so far. Unlike the counters in the trip counters menu, these counters cannot be reset.

Note! The operation time counter (days and hours) runs always, when the power is on.

Page	Counter
C6.8.1.1	MWh counter
C6.8.1.2	Operation day counter
C6.8.1.3	Operation hour counter

Table 7-6. Counter pages

Trip counters submenu (S6.8.2)

Trip counters (menu S6.8.2) are counters the values of which can be reset i.e. restored to zero. You have the following resettable counters at your disposal:

Page	Counter
T6.8.2.1	MWh counter
P6.8.2.2	Clear MWh counter
T6.8.2.3	Operation day counter
T6.8.2.4	Operation hour counter
P6.8.2.5	Clear operation time counter

Table 7-7. Trip counter pages

Note! The trip counters run only when the motor is running.

Example: When you want to reset the operation counters, you should do the following:

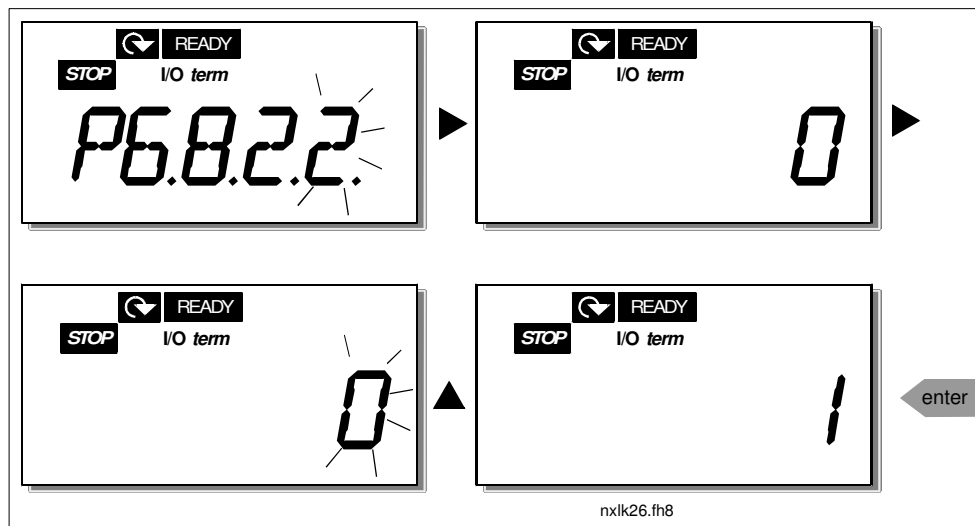

Figure 7-15. MWh counter reset

Software info submenu (S6.8.3)

The following information can be found under the Software info submenu (S6.8.3):

Page	Content
I6.8.3.1	Software package
I6.8.3.2	System software version
I6.8.3.3	Firmware interface
I6.8.3.4	System load

Table 7-8. Software information pages

Application information submenu (S6.8.4)

You can find the following information from the Application info submenu (S6.8.4)

Page	Content
A6.8.4.1	Application
D6.8.4.1.1	Application id
D6.8.4.1.2	Version
D6.8.4.1.3	Firmware interface

Table 7-9. Application information pages

Hardware information submenu (S6.8.5)

You can find the following information from the Hardware info submenu (S6.8.5)

Page	Content
I6.8.5.2	Unit voltage
I6.8.5.3	Brake chopper

Table 7-10. Hardware information pages

Connected options submenu (S6.8.6)

The Connected options submenu (S6.8.6) shows the following information on the option board connected to the frequency converter:

Page	Content
S6.8.6.1	Slot E Option board
I6.8.6.1.1	Slot E Option board status
I6.8.6.1.2	Slot E Program version
S6.8.6.2	Slot D Option board
I6.8.6.2.1	Slot D Option board status
I6.8.6.2.2	Slot D Program version

Table 7-11. Connected options submenu

In this submenu you find information about the option board connected to the control board (see chapter 6.2)

You can check the status of the slot by entering the board submenu with the *Menu button right* and using the *Browser buttons*. Push the *Menu button right* again to display the status of the board. The selections are shown in Table 7-5. The keypad will also display the program version of the respective board when you push either one of the *Browser buttons*.

For more information on the expander board-related parameters, see Chapter 7.4.9.

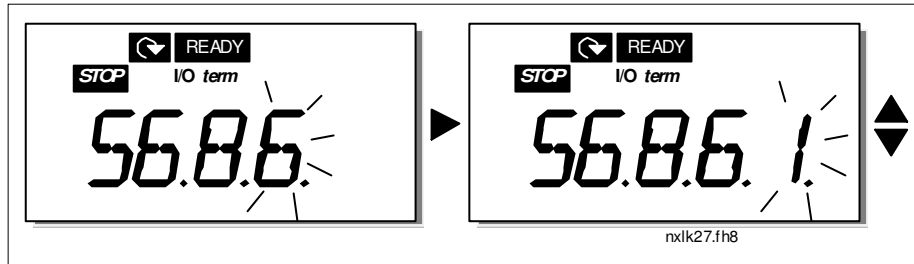

Figure 7-16. Expander board information menu

7.4.7.6 AI mode

The parameters P6.9.1 and P6.9.2 select the analogue input mode. **P6.9.1** appears only in classes **MF4 – MF6**

- 0 = voltage input (par. 6.9.1 default)
- 1 = current input (par. 6.9.2 default)

Note! Make sure that the jumper selections correspond to the selections of this parameter. See Figure 6-23.

7.4.8 Modbus interface

NXL has a built-in Modbus RTU bus interface. The signal level of the interface is in accordance with the RS-485 standard.

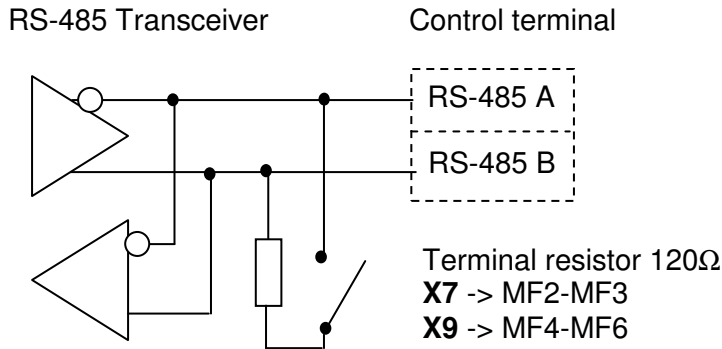

Protocol: Modbus RTU
 Baud rates: 300, 600, 1200, 2400, 4800,
 9600, 19200, 38700, 57600 (bit/s)
 Signal level: RS-485 (TIA/EIA-485-A)
 Input impedance: 2 kΩ

7.4.8.1 Modbus RTU protocol

Modbus RTU protocol is a simple but effective fieldbus protocol. Modbus network has a bus topology, where every device has an individual address. With the help of the individual bus addresses the commands are directed to the single devices within the network. Modbus supports also broadcast -type messages, which are received by every device of the bus. Broadcast messages are sent to the address '0' which is reserved for these messages.

The protocol includes CRC error detection and parity check for preventing the handling of messages containing errors. In Modbus the data is transferred in hex mode asynchronously and a break of approximately 3.5 characters is used as an end character. The length of the break depends on the used baud rate.

Function code	Function name	Address	Broadcast messages
03	Read Holding Register	All ID numbers	No
04	Read Input Register	All ID numbers	No
06	Preset Single Register	All ID numbers	Yes
16	Preset Multiple Register	All ID numbers	Yes

Table 7-12. Modbus commands supported by NXL

7.4.8.2 Termination Resistor

The RS-485 bus is terminated with 120 Ω termination resistors in both ends. NXL has a built-in termination resistor which is switched off as a default. See the jumper selections in chapter 6.2.5.1

7.4.8.3 Modbus address area

The Modbus bus of NXL uses the ID numbers of the application as addresses. The ID numbers can be found in the parameter tables of the Application manual.

When several parameters/monitoring values are read at a time they must be consecutive. 11 addresses can be read and the addresses can be parameters or monitoring values.

7.4.8.4 Modbus process data

Process data is an address area for fieldbus control. Fieldbus control is active when the value of parameter 3.1 (Control place) is **2** (=fieldbus). The contents of the process data has been determined in the application. The following tables present the process data contents in the Multi-Control Application.

Output Process data

Addr.	Modbus register	Name	Scale	Type
2101	32101, 42101	FB Status Word	-	Binary coded
2102	32102, 42102	FB General Status Word	-	Binary coded
2103	32103, 42103	FB Actual Speed	0,01	%
2104	32104, 42104	Motor speed	0,01	+/- Hz
2105	32105, 42105	Motor speed	1	+/- Rpm
2106	32106, 42106	Motor current	0,1	A
2107	32107, 42107	Motor Torque	0,1	+/- % (of nominal)
2108	32108, 42108	Motor Power	0,1	+/- % (of nominal)
2109	32109, 42109	Motor Voltage	0,1	V
2110	32110, 42110	DC Voltage	1	V
2111	32111, 42111	Active Fault	-	Fault code

Input Process data

Addr.	Modbus register	Name	Scale	Type
2001	32001, 42001	FB Control Word	-	Binary coded
2002	32002, 42002	FB General Control Word	-	Binary coded
2003	32003, 42003	FB Speed Reference	0,01	%
2004	32004, 42004	PID Control Reference	0,01	%
2005	32005, 42005	PID Actual Value	0,01	%
2006	32006, 42006	-	-	-
2007	32007, 42007	-	-	-
2008	32008, 42008	-	-	-
2009	32009, 42009	-	-	-
2010	32010, 42010	-	-	-
2011	32011, 42011	-	-	-

Status Word

15	14	13	12	11	10	9	8	7	6	5	4	3	2	1	0
-	-	-	-	-	-	-	-	F	Z	AREF	W	FLT	DIR	RUN	RDY

Information about the status of the device and messages is indicated in the *Status word*. The *Status word* is composed of 16 bits the meanings of which are described in the table below:

Actual speed

15	14	13	12	11	10	9	8	7	6	5	4	3	2	1	0
MSB															LSB

This is actual speed of the frequency converter. The scaling is $-10000...10000$. In the application, the value is scaled in percentage of the frequency area between set minimum and maximum frequency.

Control word

15	14	13	12	11	10	9	8	7	6	5	4	3	2	1	0
-	-	-	-	-	-	-	-	-	-	-	-	-	RST	DIR	RUN

In Honeywell applications, the three first bits of the control word are used to control the frequency converter. However, you can customise the content of the control word for your own applications because the control word is sent to the frequency converter as such.

Speed reference

15	14	13	12	11	10	9	8	7	6	5	4	3	2	1	0
MSB															LSB

This is the Reference 1 to the frequency converter. Used normally as Speed reference. The allowed scaling is $-10000...10000$. In the application, the value is scaled in percentage of the frequency area between the set minimum and maximum frequencies.

Bit definitions

Bit	Description	
	<i>Value = 0</i>	<i>Value = 1</i>
RUN	Stop	Run
DIR	Clockwise	Counter clockwise
RST	Rising edge of this bit will reset active fault	
RDY	Drive not ready	Drive ready
FLT	No fault	Fault active
W	No warning	Warning active
AREF	Ramping	Speed reference reached
Z	-	Drive is running at zero speed
F	-	Flux Ready

7.4.8.5 Fieldbus parameters

RS-485 communication status (I6.10.1)

With this function you can check the status of the RS 485 bus. If the bus is not in use, this value is **0**.

xx.yyy

xx = 0 – 64 (Number of messages containing errors)

yyy = 0 – 999 (Number of messages received correctly)

Fieldbus protocol (P6.10.2)

With this function you can select the fieldbus communications protocol.

0 = Not used

1 = Modbus protocol

Slave address (P6.10.3)

Set here the slave address for the Modbus protocol. You can set any address between 1 and 255.

Baud rate (P6.10.4)

Selects the baud rate used with the Modbus communication.

0 = 300 baud

1 = 600 baud

2 = 1200 baud

3 = 2400 baud

4 = 4800 baud

5 = 9600 baud

6 = 19200 baud

7 = 38400 baud

8 = 57600 baud

Stop bits (P6.10.5)

Set the number of stop bits used in Modbus communication

0 = 1 stop bit

1 = 2 stop bits

Parity type (P6.10.6)

Here you can select the type of parity checking used with the Modbus communication.

0 = None

1 = Odd

2 = Even

Communication time-out (P6.10.7)

If communication between two messages is broken for a longer time than that defined by this parameter, a communication error is initiated. If the value of this parameter is **0**, the function is not used.

0 = Not used

1 = 1 second

2 = 2 seconds, etc

7.4.9 Expander board menu (E7)

The *Expander board menu* makes it possible for the user 1) to see which expander board is connected to the control board and 2) to reach and edit the parameters associated with the expander board.

Enter the following menu level (**E#**) with the *Menu button right*. You can view and edit the parameter values in the same way as described in chapter 7.4.2.



7.5 Further keypad functions

The Honeywell NXL control keypad embodies additional application-related functions. See NXL Application Manuals for more information.

8. COMMISSIONING

8.1 Safety

Before commissioning, note the following directions and warnings:

  WARNING  HOT SURFACE	1	Internal components and circuit boards of the frequency converter (except for the galvanically isolated I/O terminals) are live when NXL is connected to mains potential. Coming into contact with this voltage is extremely dangerous and may cause death or severe injury.
	2	The motor terminals U, V, W and the DC-link/brake resistor terminals –/+ are live when NXL is connected to mains, even if the motor is not running.
	3	The control I/O-terminals are isolated from the mains potential. However, the relay outputs and other I/O-terminals may have a dangerous control voltage present even when NXL is disconnected from mains.
	4	Do not make any connections with the frequency converter connected to the mains.
	5	After having disconnected the frequency converter from the mains, wait until the fan stops and the indicators on the keypad go out (if no keypad is attached see the indicator through the keypad base). Wait 5 more minutes before doing any work on NXL connections. Do not even open the cover before this time has expired.
	6	Before connecting the frequency converter to mains make sure that the NXL front cover is closed.
	7	The heat sink of types MF2 and MF3 may be hot when the frequency converter is in use. Coming into contact with the heat sink may cause burns.

8.2 Commissioning of the frequency converter

- 1 Read carefully the safety instructions in Chapter 6 and above and follow them.
- 2 After the installation, make sure that:
 - both the frequency converter and the motor are grounded.
 - the mains and motor cables comply with the requirements given in Chapter 6.1.1.
 - the control cables are located as far as possible from the power cables (see Chapter 6.1.3, step 3); the shields of the shielded cables are connected to protective earth (⊥). The wires may not touch the electrical components of the frequency converter.
 - **For option boards only:** make sure that the common ends of digital input groups are connected to +24V or ground of the I/O terminal or the external supply.
- 3 Check the quality and quantity of cooling air (Chapter 5.2).
- 4 Check the inside of the frequency converter for condensation.
- 5 Check that all Start/Stop switches connected to the I/O terminals are in **Stop**-position.
- 6 Connect the frequency converter to mains.
- 7 Set the parameters of group 1 according to the requirements of your application. At least the following parameters should be set:
 - motor nominal voltage
 - motor nominal frequency

- motor nominal speed
- motor nominal current

You will find the values needed for the parameters on the motor rating plate.

NOTE! You can also run the Start-up Wizard. See Chapter 7.3 or NXL HVAC quick guide for more information.





8 Perform run test **without motor**

Perform either Test A or Test B:

A Controls from the I/O terminals:

- a) Turn the Start/Stop switch to ON position.
- b) Change the frequency reference (potentiometer)
- c) Check in the Monitoring menu (M1) that the value of Output frequency changes according to the change of frequency reference.
- d) Turn the Start/Stop switch to OFF position.

B Control from the control keypad:

- a) Change the control from the I/O terminals to the keypad as advised in Chapter 7.4.3.1.
- b) Push the Start button on the keypad  .
- c) Move over to the Keypad Control Menu (K3) and Keypad Reference submenu (Chapter 7.4.3) and change the frequency reference using the Browser buttons
 -
+  .
- d) Check in the Monitoring menu (M1) that the value of Output frequency changes according to the change of frequency reference.
- e) Push the Stop button on the keypad  .

- 9** Run the start-up tests without the motor being connected to the process, if possible. If this is not possible, secure the safety of each test prior to running it. Inform your co-workers of the tests.
- a) *Switch off the supply voltage and wait up until the drive has stopped **as advised at Chapter 8.1, step 5.***
 - b) *Connect the motor cable to the motor and to the motor cable terminals of the frequency converter.*
 - c) *See to that all Start/Stop switches are in Stop positions.*
 - d) *Switch the mains ON*
 - e) *Repeat test **8A** or **8B.***
- 10** Connect the motor to the process (if the start-up test was run without the motor being connected)
- a) *Before running the tests, make sure that this can be done safely.*
 - b) *Inform your co-workers of the tests.*
 - c) *Repeat test **8A** or **8B.***

8.3 Basic parameters

On the next pages you will find the list of parameters that are essential for the commissioning of the frequency converter. You will find more details of these and other special parameters in the HVAC and in the Multi-Control Application manuals.

Column explanations:

Code	= Location indication on the keypad; Shows the operator the present param. number
Parameter	= Name of parameter
Min	= Minimum value of parameter
Max	= Maximum value of parameter
Unit	= Unit of parameter value; Given if available
Default	= Value preset by factory
Cust	= Customer's own setting
ID	= ID number of the parameter (used with PC tools)
	= On the parameter code: parameter value can only be changed after the FC has been stopped.

8.3.1 Monitoring values (Control keypad: menu M1)

The monitoring values are the actual values of parameters and signals as well as statuses and measurements. Monitoring values cannot be edited. See Chapter 7.4.1 for more information.

Code	Parameter	Unit	ID	Description
V1.1	Output frequency	Hz	1	Frequency to the motor
V1.2	Frequency reference	Hz	25	
V1.3	Motor speed	rpm	2	Calculated motor speed
V1.4	Motor current	A	3	Measured motor current
V1.5	Motor torque	%	4	Calculated actual torque/nominal torque of the unit
V1.6	Motor power	%	5	Calculated actual power/nominal power of the unit
V1.7	Motor voltage	V	6	Calculated motor voltage
V1.8	DC-link voltage	V	7	Measured DC-link voltage
V1.9	Unit temperature	°C	8	Heat sink temperature
V1.10	Analogue input 1	V	13	AI1
V1.11	Analogue input 2		14	AI2
V1.12	Analogue output current		26	AO1
V1.13	Analogue output current 1, expander board	mA	31	
V1.14	Analogue output current 2, expander board	mA	32	
V1.15	DIN1, DIN2, DIN3		15	Digital input statuses
V1.16	DIE1, DIE2, DIE3		33	I/O expander board: Digital input statuses
V1.17	RO1		34	Relay output 1 status
V1.18	ROE1, ROE2, ROE3		35	I/O exp. board: Relay output statuses
V1.19	DOE 1		36	I/O exp. board: Digital output 1 status
V1.20	PID Reference	%	20	In percent of the maximum frequency
V1.21	PID Actual value	%	21	In percent of the maximum actual value
V1.22	PID Error value	%	22	In percent of the maximum error value
V1.23	PID Output	%	23	In percent of the maximum output value
V1.24	Autochange outputs 1, 2, 3		30	Used only in pump and fan control
V1.25	Mode		66	Shows the current operating mode selected with the Start-up Wizard: 1=Standard, 2= Fan, 3= Pump, 4= High Performance

Table 8-1. Monitoring values

8.3.2 HVAC parameters in NXL HVAC (Control keypad: Menu P2 → B2.1)

Code	Parameter	Min	Max	Unit	Default**	Cust	ID	Note
P2.1.1	Min frequency	0,00	Par. 2.1.2	Hz	0,00		101	
P2.1.2	Max frequency	Par. 2.1.1	320,00	Hz	50,00		102	NOTE: If f_{max} > than the motor synchronous speed, check suitability for motor and drive system
P2.1.3	Acceleration time 1	0,1	3000,0	s	1,0		103	
P2.1.4	Deceleration time 1	0,1	3000,0	s	1,0		104	
P2.1.5	Current limit	$0,1 \times I_L$	$1,5 \times I_L$	A	I_L		107	NOTE: Formulas apply approximately for frequency converters up to MF3. For greater sizes, consult the factory.
P2.1.6	Nominal current of the motor	$0,3 \times I_L$	$1,5 \times I_L$	A	I_L		113	Check the rating plate of the motor
P2.1.7	Nominal speed of the motor	300	20000	rpm	1440		112	The default applies for a 4-pole motor and a nominal size frequency converter.
P2.1.8	Start function	0	1		0		505	0 =Ramp 1 =Flying start 2 =Conditional Flying start*
P2.1.9	Stop function	0	1		0		506	0 =Coasting 1 =Ramp
P2.1.10	Automatic restart	0	1		0		731	0 =Not used 1 =Used (3 x automatic Restart)
P2.1.11	Nominal voltage of the motor	380	500	V	400V		110	
P2.1.12	Nominal frequency of the motor	30,00	320,00	Hz	50,00		111	Check the rating plate of the motor
P2.1.13	Preset speed 1	0,00	Par. 2.1.2	Hz	10,00		105	
P2.1.14	Parameter conceal	0	1		1		115	0 =All parameters and menus visible 1 =HVAC group P2.1 and menus M1 – H5 visible

Table 8-2. HVAC parameters P2.1 in NXL HVAC

* Start mode where Trip Free Output Switching is enabled, recommended to be used with all pump and fan applications.

** Default values if Start-up wizard has not been used. Look Figure 7-3 on page 54 or **NXL HVAC Quick Guide** to see the values with different modes in wizard.

NOTE! Deactivating Parameter conceal P.2.1.14 gets all parameters into use in NXL HVAC drive

8.3.3 Basic parameters (Control keypad: Menu P2 → B2.1 / B2.1.15)

In NXL HVAC the full NXL basic group can be found under the subgroup 2.1.15.

Code		Parameter	Min	Max	Unit	Default**	ID	Note
NXL Compact	NXL HVAC							
P2.1.1	P2.1.15.1	Min frequency	0,00	Par. 2.1.2	Hz	0,00	101	
P2.1.2	P2.1.15.2	Max frequency	Par. 2.1.1	320,00	Hz	50,00	102	NOTE: If f_{max} > than the motor synchronous speed, check suitability for motor and drive system
P2.1.3	P2.1.15.3	Acceleration time 1	0,1	3000,0	s	1,0	103	
P2.1.4	P2.1.15.4	Deceleration time 1	0,1	3000,0	s	1,0	104	
P2.1.5	P2.1.15.5	Current limit	$0,1 \times I_L$	$1,5 \times I_L$	A	I_L	107	NOTE: Formulas apply approximately for frequency converters up to MF3. For greater sizes, consult the factory.
P2.1.6	P2.1.15.6	Nominal voltage of the motor	180	690	V	NXL2:230V NXL5:400V	110	
P2.1.7	P2.1.15.7	Nominal frequency of the motor	30,00	320,00	Hz	50,00	111	Check the rating plate of the motor
P2.1.8	P2.1.15.8	Nominal speed of the motor	300	20 000	rpm	1440	112	The default applies for a 4-pole motor and a nominal size frequency converter.
P2.1.9	P2.1.15.9	Nominal current of the motor	$0,3 \times I_L$	$1,5 \times I_L$	A	I_L	113	Check the rating plate of the motor
P2.1.10	P2.1.15.10	Motor $\cos\phi$	0,30	1,00		0,85	120	Check the rating plate of the motor
P2.1.11	P2.1.15.11	Start function	0	1		0	505	0=Ramp 1=Flying start 2=Conditional Flying start*
P2.1.12	P2.1.15.12	Stop function	0	1		0	506	0=Coasting 1=Ramp
P2.1.13	P2.1.15.13	U/f optimisation	0	1		0	109	0=Not used 1=Automatic torque boost
P2.1.14	P2.1.15.14	I/O reference	0	5		0	117	0=AI1 1=AI2 2=Keypad reference 3=Fieldbus reference (FBSpeedReference) 4=Motor potentiometer 5=AI1/AI2 selection
P2.1.15	P2.1.15.15	AI2 signal range	1	4		2	390	Not used if AI2 Custom min > 0% or AI2 custom max. < 100% 1=0mA – 20mA 2=4mA – 20mA 3=0V – 10V 4=2V – 10V

P2.1.16	P2.1.15.16	Analogue output function	0	12		1	307	<ul style="list-style-type: none"> 0=Not used 1=Output freq. (0—f_{max}) 2=Freq. reference (0—f_{max}) 3=Motor speed (0—Motor nominal speed) 4=Output current (0—I_{nMotor}) 5=Motor torque (0—T_{nMotor}) 6=Motor power (0—P_{nMotor}) 7=Motor voltage (0—U_{nMotor}) 8=DC-link volt (0—1000V) 9=PI controller ref. value 10=PI contr. act. value 1 11=PI contr. error value 12=PI controller output
P2.1.17	P2.1.15.17	DIN2 function	0	10		1	319	<ul style="list-style-type: none"> 0=Not used 1=Start Reverse 2=Reverse 3=Stop pulse 4=External fault, cc 5=External fault, oc 6=Run enable 7=Preset speed 2 8= Motor pot. UP (cc) 9= Disable PID (Direct freq. reference) 10=Interlock 1
P2.1.18	P2.1.15.18	DIN3 function	0	17		6	301	<ul style="list-style-type: none"> 0=Not used 1=Reverse 2=External fault, cc 3=External fault, oc 4=Fault reset 5=Run enable 6=Preset speed 1 7=Preset speed 2 8=DC-braking command 9=Motor pot. UP (cc) 10=Motor pot. DOWN (cc) 11=Disable PID (PID control selection) 12=PID Keypad ref. 2 selection 13=Interlock 2 14=Thermistor input (See Chapter 6.2.4) 15=Force CP to I/O 16=Force CP to Fieldbus 17=AI1/AI2 selection
P2.1.19	P2.1.15.19	Preset speed 1	0,00	Par. 2.1.2	Hz	10,00	105	
P2.1.20	P2.1.15.20	Preset speed 2	0,00	Par. 2.1.2	Hz	50,00	106	
P2.1.21	P2.1.15.21	Automatic restart	0	1		0	731	<ul style="list-style-type: none"> 0=Not used 1=Used
P2.1.22		Parameter conceal	0	1		0	115	<ul style="list-style-type: none"> 0=All parameters and menus visible 1=Only group P2.1 and menus M1 – H5 visible

Table 8-3. Basic parameters P2.1

* Start mode where Trip Free Output Switching is enabled, recommended to be used with all pump and fan applications.

** Default values if Start-up wizard has not been used. Look Figure 7-3 on page 54 or **NXL HVAC Quick Guide** to see the values with different modes in wizard.

9. FAULT TRACING

When a fault is detected by the frequency converter control electronics, the drive is stopped and the symbol **F** together with the ordinal number of the fault and the fault code appear on the display. The

fault can be reset with the *Reset button* on the control keypad or via the I/O terminal. The faults are stored in the Fault history menu (H5) which can be browsed. The different fault codes you will find in the table below.

The fault codes, their causes and correcting actions are presented in the table below. The shadowed faults are A faults only. The items written in white on black background present faults for which you can program different responses in the application. See parameter group Protections.

Fault code	Fault	Possible cause	Correcting measures
1	Overcurrent	Frequency converter has detected too high a current ($>4 \cdot I_n$) in the motor cable: <ul style="list-style-type: none"> – sudden heavy load increase – short circuit in motor cables – unsuitable motor 	Check loading. Check motor size. Check cables.
2	Overvoltage	The DC-link voltage has exceeded the limits defined in. <ul style="list-style-type: none"> – too short a deceleration time – high overvoltage spikes in utility 	Make the deceleration time longer.
3	Earth fault	Current measurement has detected that the sum of motor phase current is not zero. <ul style="list-style-type: none"> – insulation failure in cables or motor 	Check motor cables and motor.
8	System fault	<ul style="list-style-type: none"> - component failure - faulty operation 	Reset the fault and restart. Should the fault re-occur, contact the distributor near to you.
9	Undervoltage	DC-link voltage is under the voltage limits defined in. <ul style="list-style-type: none"> – most probable cause: too low a supply voltage – frequency converter internal fault 	In case of temporary supply voltage break reset the fault and restart the frequency converter. Check the supply voltage. If it is adequate, an internal failure has occurred. Contact the distributor near to you.
11	Output phase supervision	Current measurement has detected that there is no current in one motor phase.	Check motor cable and motor.
13	Frequency converter under temperature	Heatsink temperature is under -10°C	
14	Frequency converter overtemperature	Heatsink temperature is over 90°C . Overtemperature warning is issued when the heatsink temperature exceeds 85°C .	Check the correct amount and flow of cooling air. Check the heatsink for dust. Check the ambient temperature. Make sure that the switching frequency is not too high in relation to ambient temperature and motor load.
15	Motor stalled	Motor stall protection has tripped.	Check motor. Check that Pump or Fan is not blocked.
16	Motor overtemperature	Motor overheating has been detected by frequency converter motor temperature model. Motor is overloaded.	Decrease the motor load. If no motor overload exists, check the temperature model parameters.

17	Motor underload/ Pump Dry detection/ Broken belt Detection	Motor underload protection has tripped.	FAN: check that Belt is not broken PUMP: check that Pump is not dry
22	EEPROM checksum fault	Parameter save fault – faulty operation – component failure	Contact the distributor near to you
24	Counter fault	Values displayed on counters are incorrect	
25	Microprocessor watchdog fault	– faulty operation – component failure	Reset the fault and restart. Should the fault re-occur, contact the distributor near to you.
29	Thermistor fault	The thermistor input of option board has detected increase of the motor temperature	Check motor cooling and loading Check thermistor connection (If thermistor input of the option board is not in use it has to be short circuited)
34	Internal bus communication	Ambient interference or defective hardware	Should the fault re-occur, contact the distributor near to you.
35	Application fault	Selected application does not function.	Contact the distributor near to you.
39	Device removed	Option board removed. Drive removed.	Reset
40	Device unknown	Unknown option board or drive.	Contact the distributor near to you.
41	IGBT temperature	IGBT Inverter Bridge overtemperature protection has detected too high a motor current.	Check loading. Check motor size.
44	Device change	Option board changed. Option board has default settings.	Reset
45	Device added	Option board added.	Reset
50	Analogue input $I_{in} < 4\text{mA}$ (selected signal range 4 to 20 mA)	Current at the analogue input is $< 4\text{mA}$. – control cable is broken or loose – signal source has failed	Check the current loop circuitry.
51	External fault	Digital input fault. Digital input has been programmed as external fault input and this input is active.	Check the programming and the device indicated by the external fault information. Check also the cabling of this device.
52	Keypad communication fault	The connection between the control keypad and the frequency converter is broken.	Check keypad connection and possible keypad cable.

53	Fieldbus fault	The data connection between the fieldbus Master and the fieldbus board is broken	Check installation. If installation is correct contact the nearest Honeywell distributor.
54	Slot fault	Defective option board or slot	Check board and slot. Contact the nearest Honeywell distributor.
55	Actual value supervision	Actual value has exceeded or fallen below (depending on par. 2.7.22) the actual value supervision limit (par. 2.7.23)	

Table 9-1. Fault codes

10. DESCRIPTION OF EXPANDER BOARD NXLOPTAA

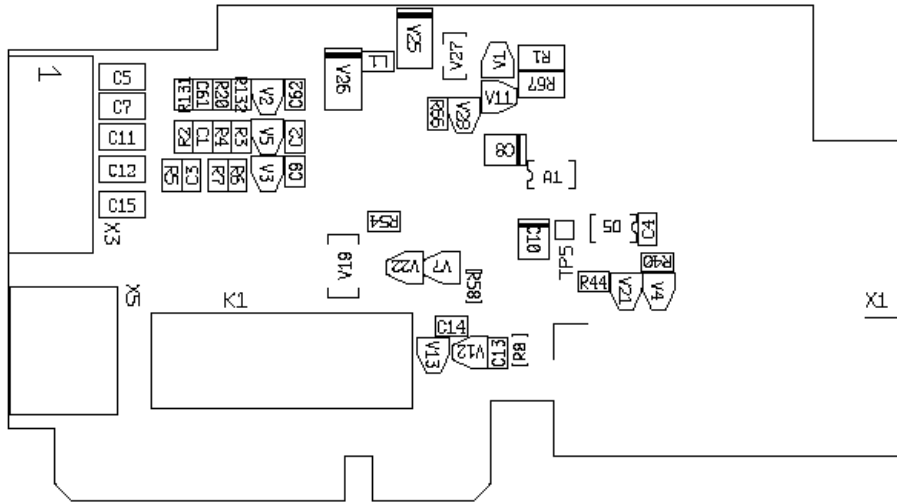

Description: I/O expander board with one relay output, one open collector output and three digital inputs.

- Allowed slots: **Honeywell NXL** board slot E
- Type ID: 16705
- Terminals: Two terminal blocks; Screw terminals (M2.6 and M3); No coding
- Jumpers: None
- Board parameters: None

I/O terminals on NXLOPTAA

Terminal	Parameter setting	Description	
X3			
1	+24V	Control voltage output; voltage for switches etc, max. 150 mA	
2	GND	Ground for controls, e.g. for +24 V and DO	
3	DIN1	DIGIN:x.1	Digital input 1
4	DIN2	DIGIN:x.2	Digital input 2
5	DIN3	DIGIN:x.3	Digital input 3
6	DO1	DIOUT:x.1	Open collector output, 50mA/48V
X5			
24	RO1/NC	DIOUT:x.2	Relay output 1 (NO) Switching capacity: 24VDC/8A 250VAC/8A 125VDC/0,4A
25	RO1/C		
26	RO1/NO		

Table 10-1. I/O terminals of board NXLOPTAA

Note! The +24 V control voltage terminal can also be used to power the control module (but not the power module).

11. DESCRIPTION OF EXPANDER BOARD NXLOPTAI

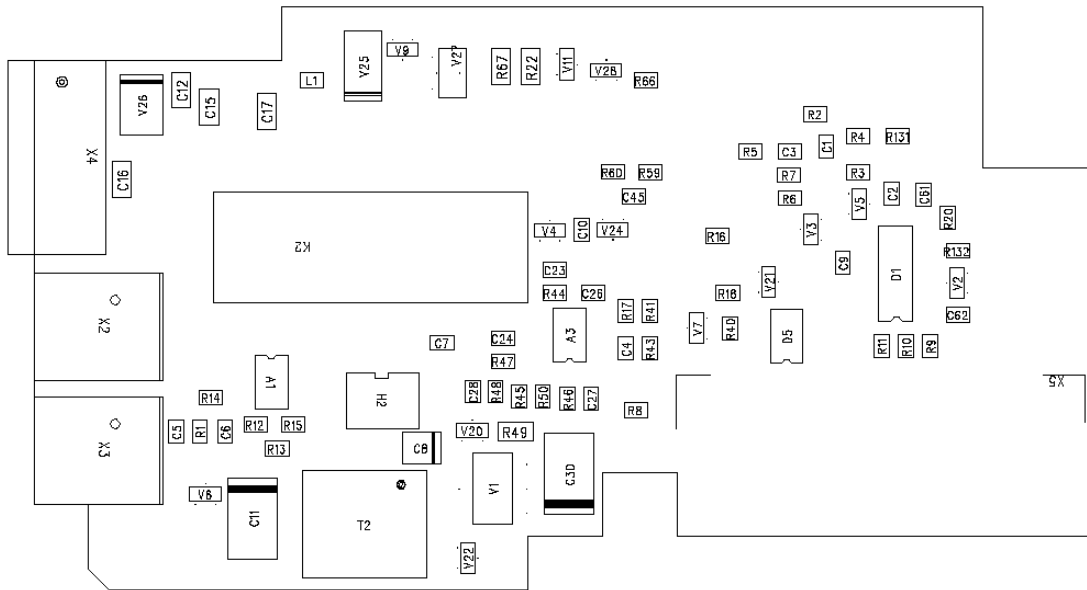

Description: I/O expander board with one relay output (NO), three digital inputs and one thermistor input for Honeywell NXL frequency converters

Allowed slots: **Honeywell NXL** board slot E (standard board in NXL HVAC)

Type ID: 16713

Terminals: Three terminal blocks; Screw terminals; No coding

Jumpers: None

Board parameters: None

Terminal		Parameter setting	Description
X4			
12	+24V		Control voltage output; voltage for switches etc, max. 150 mA
13	GND		Ground for controls, e.g. for +24 V and DO
14	DIN1	DIGIN:B.1	Digital input 1
15	DIN2	DIGIN:B.2	Digital input 2
16	DIN3	DIGIN:B.3	Digital input 3
X2			
25	RO1/ Common	DigOUT:B.1 	Relay output 1 (NO) Switching capacity: 24VDC/8A 250VAC/8A 125VDC/0,4A
26	RO1/ Normal Open		
X3			
28	TI+	DIGIN:B.4	Thermistor input; Rtrip = 4.7 kΩ (PTC), galvanically isolated
29	TI-		

Table 11-1. I/O terminals of board NXLOPTAI

Note! The +24 V control voltage terminal can also be used to power the control module (but not the power module).

12. NXL HVAC BASIC SPEED CONTROL – QUICK SETUP

This chapter provides basic setup instructions for the user of NXL HVAC inverters, when using Basic Speed Control in HVAC applications.

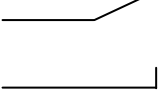
What you need to know

Motor nameplate data

- Nominal current
- Nominal speed

Speed signal specification

- Signal type (V, mA)
- Range (0-10, 2-10, 0-20, 4-20)

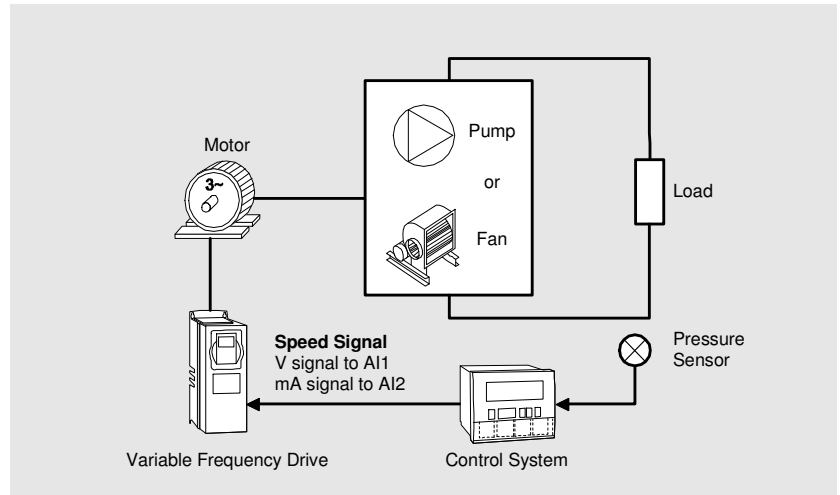

Setup

1 Run the Start-up Wizard

Note: Running the Start Up Wizard resets all parameters to their default values.

- Hold STOP button down for 5 seconds
- Select application type FAN or PUMP and confirm with ENTER
- Select motor nominal speed and confirm with ENTER
- Select motor nominal current and confirm with ENTER
- For speed signal 0 – 10 V use AI1 (Analogue Input 1)
- All settings **DONE**

2 Control Signal Settings for Speed Signals other than 0 – 10 V

- For other selections full parameter view is needed:

P2.1.14	Parameter Conceal	Set to 0 (not in use)
---------	-------------------	-----------------------
- For speed signal 2 – 10 V use Analogue Input 1

P2.2.6	AI1 Signal Range	Set to 4 (2 – 10 V)
--------	------------------	---------------------
- For speed signal 4 – 20 mA use Analogue Input 2

P2.1.15.14	I/O Reference	Set to 1 (AI2)
------------	---------------	----------------
- For speed signal 0 – 20 mA use Analogue Input 2

P2.1.15.14	I/O Reference	Set to 1 (AI2)
P2.2.12	AI2 Signal Range	Set to 1 (0 – 20 mA)

Manual Test

1 Hold LEFT down for 3-5 seconds

Control Place automatically switches to Keypad

2 Use normal keypad buttons for speed control

- UP and DOWN to adjust the speed
- START and STOP for control

3 Hold LEFT down for 3 seconds to return to remote control (I/O or Fieldbus)

Find out more

For more information on
Honeywell's frequency
converters and other Honeywell
products, visit us online at
<http://ecc.emea.honeywell.com>

Automation and Control Solutions
Honeywell GmbH
Böblinger Str. 17
71101 Schönaich, Germany
Telephone (49) 7031 637 01
Telefax (49) 7073 637 493
www.ecc.emea.honeywell.com

EN1B-0388GE51 R1107
November 2007
© 2007 Honeywell International Inc.

Honeywell