



OM-928

198 842J

2007-01

**Processes**



Air Plasma Cutting  
and Gouging

**Description**



Air Plasma Cutter

# AirForce 250A<sup>TM</sup> And ICE-12C Torch

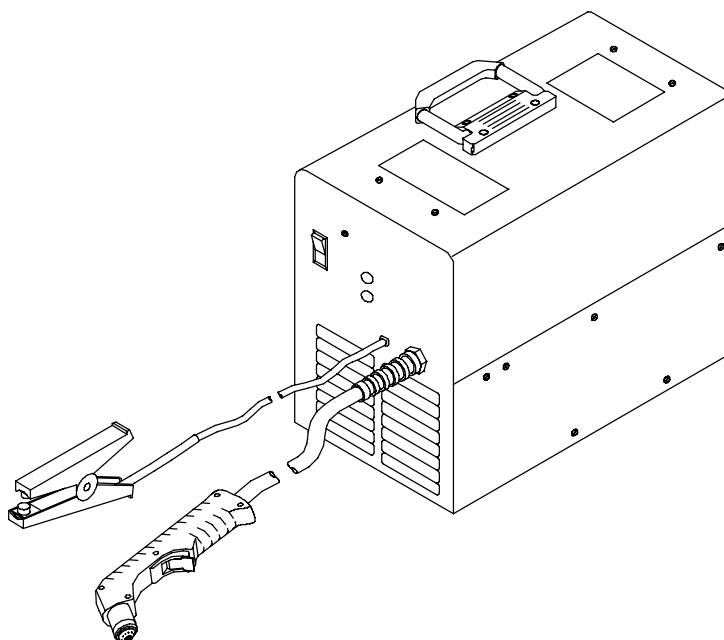

[www.HobartWelders.com](http://www.HobartWelders.com)



**OWNER'S MANUAL**

# From Hobart to You

---

*Thank you and congratulations* on choosing Hobart. Now you can get the job done and get it done right. We know you don't have time to do it any other way.

This Owner's Manual is designed to help you get the most out of your Hobart products. Please take time to read the Safety precautions. They will help you protect yourself against potential hazards on the worksite.



Hobart is registered to the ISO 9001:2000 Quality System Standard.

We've made installation and operation quick and easy. With Hobart you can count on years of reliable service with proper maintenance. And if for some reason the unit needs repair, there's a Troubleshooting section that will help you figure out what the problem is. The parts list will then help you to decide the exact part you may need to fix the problem. Warranty and service information for your particular model are also provided.

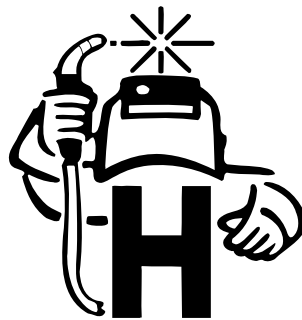

Hobart Welders manufactures a full line of welders and welding related equipment. For information on other quality Hobart products, contact your local Hobart distributor to receive the latest full line catalog or individual specification sheets. **To locate your nearest distributor or service agency call 1-877-Hobart1 or visit our website at [www.HobartWelders.com](http://www.HobartWelders.com).**

For Technical Help call 1-800-332-3281.

## 5/3/1 WARRANTY

Working as hard as you do – every power source from Hobart is backed by the best warranty in the business.

**Protect Your Investment!**



**Register your product at:**  
**[HobartWelders.com](http://HobartWelders.com)**

# TABLE OF CONTENTS

<b>SECTION 1 – SAFETY PRECAUTIONS - READ BEFORE USING</b> .....	<b>1</b>
1-1. Symbol Usage .....	1
1-2. Plasma Arc Cutting Hazards .....	1
1-3. Additional Symbols For Installation, Operation, And Maintenance .....	3
1-4. California Proposition 65 Warnings .....	3
1-5. Principal Safety Standards .....	4
1-6. EMF Information .....	4
<b>SECTION 2 – CONSIGNES DE SÉCURITÉ – LIRE AVANT UTILISATION</b> .....	<b>5</b>
2-1. Signification des symboles .....	5
2-2. Dangers liés au coupage à l'arc au plasma .....	5
2-3. Dangers supplémentaires en relation avec l'installation, le fonctionnement et la maintenance .....	7
2-4. Principales normes de sécurité .....	8
2-5. Information sur les champs électromagnétiques .....	8
<b>SECTION 3 – DEFINITIONS</b> .....	<b>9</b>
3-1. Symbols And Definitions For Nameplate And Serial Number/Rating Label .....	9
<b>SECTION 4 – INSTALLATION</b> .....	<b>10</b>
4-1. Specifications For Power Source .....	10
4-2. Specifications For Torch .....	10
4-3. Duty Cycle And Overheating .....	10
4-4. Torch Dimensions And Weight .....	11
4-5. Selecting A Location .....	11
4-6. Connecting Work Clamp .....	12
4-7. Connecting Input Power .....	12
<b>SECTION 5 – OPERATION</b> .....	<b>13</b>
5-1. Controls .....	13
5-2. Trigger Safety Lock .....	13
5-3. Sequence Of Operation .....	14
<b>SECTION 6 – MAINTENANCE &amp; TROUBLESHOOTING</b> .....	<b>15</b>
6-1. Routine Maintenance .....	15
6-2. Trouble Light And Checking Shield Cup Shutdown System .....	16
6-3. Torch And Work Cable Connections .....	17
6-4. Checking/Replacing Retaining Cup, Tip, And Electrode .....	18
6-5. Troubleshooting Power Source .....	19
6-6. Troubleshooting Torch .....	20
<b>SECTION 7 – ELECTRICAL DIAGRAM</b> .....	<b>21</b>
<b>SECTION 8 – PARTS LIST</b> .....	<b>22</b>
<b>OPTIONS AND ACCESSORIES</b>	
<b>WARRANTY</b>	



# SECTION 1 – SAFETY PRECAUTIONS - READ BEFORE USING

pom\_nd\_5/04

## 1-1. Symbol Usage



Means Warning! Watch Out! There are possible hazards with this procedure! The possible hazards are shown in the adjoining symbols.

▲ Marks a special safety message.

☞ Means "Note"; not safety related.



This group of symbols means Warning! Watch Out! possible ELECTRIC SHOCK, MOVING PARTS, and HOT PARTS hazards. Consult symbols and related instructions below for necessary actions to avoid the hazards.

## 1-2. Plasma Arc Cutting Hazards

▲ The symbols shown below are used throughout this manual to call attention to and identify possible hazards. When you see the symbol, watch out, and follow the related instructions to avoid the hazard. The safety information given below is only a summary of the more complete safety information found in the Safety Standards listed in Section 1-5. Read and follow all Safety Standards.

▲ Only qualified persons should install, operate, maintain, and repair this unit.

▲ During operation, keep everybody, especially children, away.

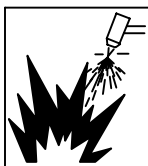

### CUTTING can cause fire or explosion.

Hot metal and sparks blow out from the cutting arc. The flying sparks and hot metal, hot workpiece, and hot equipment can cause fires and burns. Check and be sure the area is safe before doing any cutting.

- Protect yourself and others from flying sparks and hot metal.
- Do not cut where flying sparks can strike flammable material.
- Remove all flammables within 35 ft (10.7 m) of the cutting arc. If this is not possible, tightly cover them with approved covers.
- Be alert that sparks and hot materials from cutting can easily go through small cracks and openings to adjacent areas.
- Watch for fire, and keep a fire extinguisher nearby.
- Be aware that cutting on a ceiling, floor, bulkhead, or partition can cause fire on the hidden side.
- Do not cut on closed containers such as tanks or drums.
- Connect work cable to the work as close to the cutting area as practical to prevent cutting current from traveling long, possibly unknown paths and causing electric shock and fire hazards.
- Never cut containers with potentially flammable materials inside – they must be emptied and properly cleaned first.
- Do not cut in atmospheres containing explosive dust or vapors.
- Do not cut pressurized cylinders, pipes, or vessels.
- Do not cut containers that have held combustibles.
- Wear oil-free protective garments such as leather gloves, heavy shirt, cuffless trousers, high shoes, and a cap.
- Do not locate unit on or over combustible surfaces.
- Remove any combustibles, such as a butane lighter or matches, from your person before doing any cutting.



### ELECTRIC SHOCK can kill.

Touching live electrical parts can cause fatal shocks or severe burns. The torch and work circuit are electrically live whenever the output is on. The input power circuit and machine internal circuits are also live when power is on. Plasma arc cutting requires

higher voltages than welding to start and maintain the arc (200 to 400 volts dc are common), but also uses torches designed with safety interlock systems which turn off the machine when the shield cup is loosened or if tip touches electrode inside the nozzle. Incorrectly installed or improperly grounded equipment is a hazard.



### ELECTRIC SHOCK can kill.

**SIGNIFICANT DC VOLTAGE exists on internal parts of inverter power sources AFTER the removal of input power.**

- Turn Off unit, disconnect input power, check voltage on input capacitors, and be sure it is near zero (0) volts before touching any parts. Check capacitors according to instructions in Maintenance Section of Owner's Manual or Technical Manual before touching any parts.

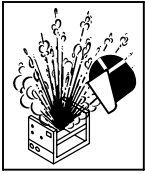

### EXPLODING PARTS can injure.

- On inverter power sources, failed parts can explode or cause other parts to explode when power is applied. Always wear a face shield and long sleeves when servicing inverters.

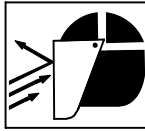

### FLYING SPARKS can cause injury.

Sparks and hot metal blow out from the cutting arc. Chipping and grinding cause flying metal.

- Wear approved face shield or safety goggles with side shields.
- Wear proper body protection to protect skin.
- Wear flame-resistant ear plugs or ear muffs to prevent sparks from entering ears.

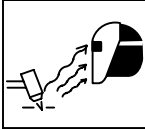

### ARC RAYS can burn eyes and skin.

Arc rays from the cutting process produce intense visible and invisible (ultraviolet and infrared) rays that can burn eyes and skin.

- Wear face protection (helmet or shield) with correct shade of filter to protect your face and eyes when cutting or watching. ANSI Z49.1 (see Safety Standards) suggests a No. 9 shade (with No. 8 as minimum) for all cutting currents less than 300 amperes. Z49.1 adds that lighter filter shades may be used when the arc is hidden by the workpiece. As this is normally the case with low current cutting, the shades suggested in Table 1 are provided for the operator's convenience.
- Wear approved safety glasses with side shields under your helmet or shield.
- Use protective screens or barriers to protect others from flash and glare; warn others not to watch the arc.
- Wear protective clothing made from durable, flame-resistant material (leather and wool) and foot protection.

**Table 1. Eye Protection For Plasma Arc Cutting**

Current Level In Amperes	Minimum Shade Number	
Below 20		#4
20 – 40		#5
40 – 60		#6
60 – 80		#8

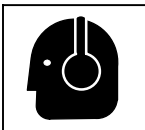

### NOISE can damage hearing.

Prolonged noise from some cutting applications can damage hearing if levels exceed limits specified by OSHA (see Safety Standards).

- Use approved ear plugs or ear muffs if noise level is high.
- Warn others nearby about noise hazard.



### FUMES AND GASES can be hazardous.

Cutting produces fumes and gases. Breathing these fumes and gases can be hazardous to your health.

- Keep your head out of the fumes. Do not breathe the fumes.

- If inside, ventilate the area and/or use exhaust at the arc to remove cutting fumes and gases.
- If ventilation is poor, use an approved air-supplied respirator.
- Read the Material Safety Data Sheets (MSDSs) and the manufacturer's instruction for metals to be cut, coatings, and cleaners.
- Work in a confined space only if it is well ventilated, or while wearing an air-supplied respirator. Fumes from cutting and oxygen depletion can alter air quality causing injury or death. Be sure the breathing air is safe.
- Do not cut in locations near degreasing, cleaning, or spraying operations. The heat and rays of the arc can react with vapors to form highly toxic and irritating gases.
- Do not cut on coated metals, such as galvanized, lead, or cadmium plated steel, unless the coating is removed from the cutting area, the area is well ventilated, and if necessary, while wearing an air-supplied respirator. The coatings and any metals containing these elements can give off toxic fumes when cut.
- Do not cut containers with toxic or reactive materials inside or containers that have held toxic or reactive materials – they must be emptied and properly cleaned first.

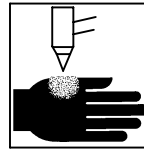

### PLASMA ARC can cause injury.

The heat from the plasma arc can cause serious burns. The force of the arc adds greatly to the burn hazard. The intensely hot and powerful arc can quickly cut through gloves and tissue.

- Keep away from the torch tip.
- Do not grip material near the cutting path.
- The pilot arc can cause burns – keep away from torch tip when trigger is pressed.
- Wear proper flame-retardant clothing covering all exposed body areas.
- Point torch away from your body and toward work when pressing the torch trigger – pilot arc comes on immediately.
- Turn off power source and disconnect input power before disassembling torch or changing torch parts.
- Use only torch(es) specified in the Owner's Manual.

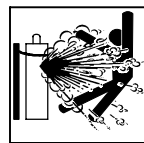

### CYLINDERS can explode if damaged.

Gas cylinders contain gas under high pressure. If damaged, a cylinder can explode. Since gas cylinders are normally part of metalworking processes, be sure to treat them carefully.

- Protect compressed gas cylinders from excessive heat, mechanical shocks, slag, open flame, sparks, and arcs.
- Install and secure cylinders in an upright position by chaining them to a stationary support or equipment cylinder rack to prevent falling or tipping.
- Keep cylinders away from any cutting or other electrical circuits.
- Never allow electrical contact between a plasma arc torch and a cylinder.
- Never cut on a pressurized cylinder – explosion will result.
- Use only correct gas cylinders, regulators, hoses, and fittings designed for the specific application; maintain them and associated parts in good condition.
- Turn face away from valve outlet when opening cylinder valve.
- Keep protective cap in place over valve except when cylinder is in use or connected for use.
- Read and follow instructions on compressed gas cylinders, associated equipment, and CGA publication P-1 listed in Safety Standards.

## 1-3. Additional Symbols For Installation, Operation, And Maintenance



### HOT PARTS can cause severe burns.

- Do not touch hot parts bare handed.
- Allow cooling period before working on torch.



### MOVING PARTS can cause injury.

- Keep away from moving parts such as fans.
- Keep all doors, panels, covers, and guards closed and securely in place.

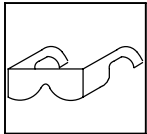

### FLYING METAL can injure eyes.

- Wear safety glasses with side shields or face shield.

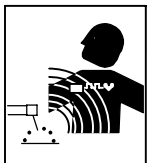

### MAGNETIC FIELDS can affect pacemakers.

- Pacemaker wearers keep away.
- Wearers should consult their doctor before going near plasma arc cutting operations.

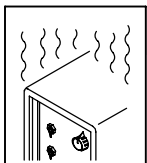

### OVERUSE can cause OVERHEATING.

- Allow cooling period; follow rated duty cycle.
- Reduce amperage (thickness) or reduce duty cycle before starting to cut again.



### EXPLODING HYDROGEN hazard.

- When cutting aluminum underwater or with the water touching the underside of the aluminum, free hydrogen gas may collect under the work-piece.

- See your cutting engineer and water table instructions for help.

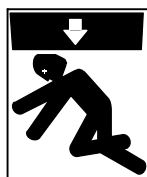

### FALLING UNIT can cause injury.

- Use lifting eye to lift unit only, NOT running gear, gas cylinders, or any other accessories.
- Use equipment of adequate capacity to lift unit.

- If using lift forks to move unit, be sure forks are long enough to extend beyond opposite side of unit.

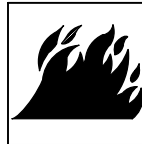

### FIRE OR EXPLOSION hazard.

- Do not locate unit on, over, or near combustible surfaces.
- Do not install unit near flammables.
- Do not overload building wiring – be sure power supply system is properly sized, rated, and protected to handle this unit.

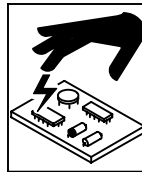

### STATIC (ESD) can damage PC boards.

- Put on grounded wrist strap BEFORE handling boards or parts.
- Use proper static-proof bags and boxes to store, move, or ship PC boards.

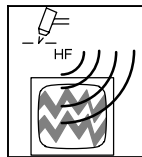

### H.F. RADIATION can cause interference.

- High frequency (H.F.) can interfere with radio navigation, safety services, computers, and communications equipment.
- Have only qualified persons familiar with electronic equipment perform this installation.
- The user is responsible for having a qualified electrician promptly correct any interference problem resulting from the installation.
- If notified by the FCC about interference, stop using the equipment at once.
- Have the installation regularly checked and maintained.
- Keep high-frequency source doors and panels tightly shut, keep spark gaps at correct setting, and use grounding and shielding to minimize the possibility of interference.

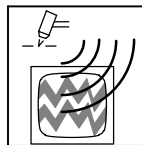

### ARC CUTTING can cause interference.

- Electromagnetic energy can interfere with sensitive electronic equipment such as computers and computer-driven equipment such as robots.
- To reduce possible interference, keep cables as short as possible, close together, and down low, such as on the floor.
- Locate cutting operation 100 meters from any sensitive electronic equipment.
- Be sure this cutting power source is installed and grounded according to this manual.
- If interference still occurs, the user must take extra measures such as moving the machine, using shielded cables, using line filters, or shielding the work area.

## 1-4. California Proposition 65 Warnings

- ▲ **Welding or cutting equipment produces fumes or gases which contain chemicals known to the State of California to cause birth defects and, in some cases, cancer. (California Health & Safety Code Section 25249.5 et seq.)**
- ▲ **Battery posts, terminals and related accessories contain lead and lead compounds, chemicals known to the State of California to cause cancer and birth defects or other reproductive harm. Wash hands after handling.**

### For Gasoline Engines:

- ▲ **Engine exhaust contains chemicals known to the State of California to cause cancer, birth defects, or other reproductive harm.**

### For Diesel Engines:

- ▲ **Diesel engine exhaust and some of its constituents are known to the State of California to cause cancer, birth defects, and other reproductive harm.**

## 1-5. Principal Safety Standards

*Safety in Welding and Cutting*, ANSI Standard Z49.1, from American Welding Society, 550 N.W. LeJeune Rd, Miami FL 33126

*Safety and Health Standards*, OSHA 29 CFR 1910, from Superintendent of Documents, U.S. Government Printing Office, Washington, D.C. 20402.

*Recommended Practices for Plasma Arc Cutting*, American Welding Society Standard AWS C5.2, from American Welding Society, 550 N.W. LeJeune Rd, Miami, FL 33126

*Recommended Safe Practices for the Preparation for Welding and Cutting of Containers That Have Held Hazardous Substances*, American Welding Society Standard AWS F4.1, from American Welding Society, 550 N.W. LeJeune Rd, Miami, FL 33126

*National Electrical Code*, NFPA Standard 70, from National Fire Protection Association, Batterymarch Park, Quincy, MA 02269.

*Safe Handling of Compressed Gases in Cylinders*, CGA Pamphlet P-1, from Compressed Gas Association, 1235 Jefferson Davis Highway, Suite 501, Arlington, VA 22202.

*Code for Safety in Welding and Cutting*, CSA Standard W117.2, from Canadian Standards Association, Standards Sales, 178 Rexdale Boulevard, Rexdale, Ontario, Canada M9W 1R3.

*Safe Practices For Occupation And Educational Eye And Face Protection*, ANSI Standard Z87.1, from American National Standards Institute, 1430 Broadway, New York, NY 10018.

*Cutting And Welding Processes*, NFPA Standard 51B, from National Fire Protection Association, Batterymarch Park, Quincy, MA 02269.

## 1-6. EMF Information

Considerations About Welding Or Cutting And The Effects Of Low Frequency Electric And Magnetic Fields

Welding or cutting current, as it flows through the welding or cutting cables, will cause electromagnetic fields. There has been and still is some concern about such fields. However, after examining more than 500 studies spanning 17 years of research, a special blue ribbon committee of the National Research Council concluded that: "The body of evidence, in the committee's judgment, has not demonstrated that exposure to power-frequency electric and magnetic fields is a human-health hazard." However, studies are still going forth and evidence continues to be examined. Until the final conclusions of the research are reached, you may wish to minimize your exposure to electromagnetic fields when welding or cutting.

To reduce magnetic fields in the workplace, use the following procedures:

1. Keep cables close together by twisting or taping them.
2. Arrange cables to one side and away from the operator.
3. Do not coil or drape cables around your body.
4. Keep cutting power source and cables as far away from operator as practical.
5. Connect work clamp to workpiece as close to the cut as possible.

### **About Pacemakers:**

Pacemaker wearers consult your doctor first. If cleared by your doctor, then following the above procedures is recommended.



# SECTION 2 – CONSIGNES DE SÉCURITÉ – LIRE AVANT UTILISATION

pom\_fr 5/04

## 2-1. Signification des symboles



Signifie Mise en garde ! Soyez vigilant ! Cette procédure présente des risques de danger ! Ceux-ci sont identifiés par des symboles adjacents aux directives.

▲ **Identifie un message de sécurité particulier.**

☞ Signifie *NOTA* ; n'est pas relatif à la sécurité.



Ce groupe de symboles signifie Mise en garde ! Soyez vigilant ! Il y a des risques de danger reliés aux CHOCS ÉLECTRIQUES, aux PIÈCES EN MOUVEMENT et aux PIÈCES CHAUDES. Reportez-vous aux symboles et aux directives ci-dessous afin de connaître les mesures à prendre pour éviter tout danger.

## 2-2. Dangers liés au coupage à l'arc au plasma

▲ Les symboles présentés ci-après sont utilisés tout au long du présent manuel pour attirer votre attention et identifier les risques de danger. Lorsque vous voyez un symbole, soyez vigilant et suivez les directives mentionnées afin d'éviter tout danger. Les consignes de sécurité présentées ci-après ne font que résumer l'information contenue dans les normes de sécurité énumérées à la section 2-4. Veuillez lire et respecter toutes ces normes de sécurité.

▲ L'installation, l'utilisation, l'entretien et les réparations ne doivent être confiés qu'à des personnes qualifiées.

▲ Au cours de l'utilisation, tenir toute personne à l'écart et plus particulièrement les enfants.

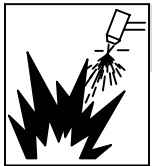

**LE COUPAGE présente un risque de feu ou d'explosion.**

Des particules de métal chaud et des étincelles peuvent jaillir de la pièce au moment du coupage. Les étincelles et le métal chaud, la pièce à couper chauffée et l'équipement chaud peuvent causer un feu ou des brûlures. Avant de commencer à travailler, assurez-vous que l'endroit est sécuritaire.

- Protégez-vous, ainsi que toute autre personne travaillant sur les lieux, contre les étincelles et le métal chaud.
- Ne coupez pas dans un endroit où des étincelles pourraient atteindre des matières inflammables.
- Déplacez toute matière inflammable se trouvant à l'intérieur d'un périmètre de 10,7 m (35 pi) de la pièce à couper. Si cela est impossible, vous devez les couvrir avec des housses approuvées et bien ajustées.
- Assurez-vous qu'aucune étincelle ni particule de métal ne peut se glisser dans de petites fissures ou tomber dans d'autres pièces.
- Afin d'éliminer tout risque de feu, soyez vigilant et gardez toujours un extincteur à la portée de la main.
- Si vous coupez sur un plafond, un plancher ou une cloison, soyez conscient que cela peut entraîner un feu de l'autre côté.
- Ne coupez pas sur un contenant fermé tel qu'un réservoir ou un bidon.
- Fixez le câble de masse sur la pièce à couper, le plus près possible de la zone à couper afin de prévenir que le courant de coupage ne prenne une trajectoire inconnue ou longue et ne cause ainsi une décharge électrique ou un feu.
- Ne coupez jamais des contenants qui peuvent contenir des matières inflammables. Vous devez en premier lieu les vider et les nettoyer convenablement.
- Ne coupez pas dans un endroit où l'atmosphère risque de contenir de la poussière ou des vapeurs explosives.
- Ne coupez pas de bouteilles, de tuyaux ou de contenants pressurisés.
- Ne coupez pas de contenants qui ont déjà reçu des combustibles.
- Portez des vêtements de protection exempts d'huile tels que des gants en cuir, une veste résistante, des pantalons sans revers, des bottes et un casque.
- Ne placez pas le poste sur une surface combustible ou au-dessus de celle-ci.
- Avant le coupage, retirez tout combustible de vos poches, par exemple un briquet au butane ou des allumettes.



**UNE DÉCHARGE ÉLECTRIQUE peut entraîner la mort.**

Le fait de toucher à une pièce électrique sous tension peut donner une décharge fatale ou entraîner des brûlures graves. Le chalumeau et le circuit de masse sont automatiquement actifs lorsque le poste est sous tension. L'alimentation d'entrée et les circuits internes de l'appareil le sont également. Le coupage au plasma d'arc exige des tensions plus élevées que le soudage pour amorcer et maintenir l'arc (souvent de 200 à 400 V CC), c'est pourquoi on fait appel à des chalumeaux conçus avec un système de verrouillage sécuritaire qui met l'appareil hors tension lorsque la capsule anti-feu est desserrée ou si le tube touche l'électrode à l'intérieur de la buse. Un poste incorrectement installé ou inadéquatement mis à la terre constitue un danger.

- Ne touchez pas aux pièces électriques sous tension.
- Portez des gants isolants et des vêtements de protection secs et sans trous.
- Isolez-vous de la pièce à couper et du sol en utilisant des housses ou des tapis assez grands afin d'éviter tout contact physique avec la pièce à couper ou le sol.
- Ne touchez pas aux pièces du chalumeau si vous êtes en contact avec la pièce à couper ou le sol.
- Mettez l'appareil hors tension avant d'effectuer la vérification, le nettoyage ou le changement d'une pièce du chalumeau.
- Coupez l'alimentation d'entrée avant d'installer l'appareil ou d'effectuer l'entretien. Verrouillez ou étiquetez la sortie d'alimentation selon la norme OSHA 29 CFR 1910.147 (reportez-vous aux Principales normes de sécurité).
- Installez le poste correctement et mettez-le à la terre convenablement selon les consignes du manuel de l'opérateur et les normes nationales, provinciales et locales.
- Assurez-vous que le fil de terre du cordon d'alimentation est correctement relié à la borne de terre dans la boîte de coupure ou que la fiche du cordon est branchée à une prise correctement mise à la terre – vous devez toujours vérifier la mise à la terre.
- Avant d'effectuer les connexions d'alimentation, vous devez relier le bon fil de terre.
- Vérifiez fréquemment le cordon d'alimentation afin de vous assurer qu'il n'est pas altéré ou à nu, remplacez-le immédiatement s'il l'est. Un fil à nu peut entraîner la mort.
- L'équipement doit être hors tension lorsqu'il n'est pas utilisé.
- Vérifiez et remplacez les cosses du câble du chalumeau si elles sont usées ou altérées.
- Le câble du chalumeau ne doit pas s'enrouler autour de votre corps.
- Si les normes le stipulent, la pièce à couper doit être mise à la terre.
- Utilisez uniquement de l'équipement en bonne condition. Réparez ou remplacez immédiatement toute pièce altérée.
- Portez un harnais de sécurité si vous devez travailler au-dessus du sol.
- Assurez-vous que tous les panneaux et couvercles sont correctement en place.
- N'essayez pas d'aller à l'encontre des systèmes de verrouillage de sécurité ou de les contourner.
- Utilisez uniquement le ou les chalumeaux recommandés dans le manuel de l'opérateur.
- N'approchez pas le tube du chalumeau et l'arc pilote lorsque la gâchette est enfoncée.
- Le câble de masse doit être pincé correctement sur la pièce à couper, métal contre métal (et non de telle sorte qu'il puisse se détacher), ou sur la table de travail le plus près possible de la ligne de coupage.

- Isoler la pince de masse quand pas mis à la pièce pour éviter le contact avec tout objet métallique.

## Il y a DU COURANT CONTINU IMPORTANT dans les convertisseurs après la suppression de l'alimentation électrique.

- Arrêter les convertisseurs, débrancher le courant électrique, et décharger les condensateurs d'alimentation selon les instructions indiquées dans la partie entretien avant de toucher les pièces.



### DÉCHARGES ÉLECTRIQUES potentiellement mortelles.

#### Les pièces internes des sources d'alimentation de l'inverseur ont DES CHARGES C.C. SIGNIFICATIVES même APRÈS coupure du courant d'alimentation.

- Mettre l'unité hors tension, mesurer la tension des condensateurs d'entrée et s'assurer qu'elle est pratiquement nulle avant de toucher à l'une quelconque des pièces. Mesurer cette tension conformément aux directives énoncées à la section Entretien du manuel de l'utilisateur ou du manuel technique avant de toucher à l'une quelconque des pièces.

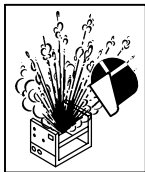

### Risque de blessure en cas D'EXPLOSION DES PIÈCES.

- Mise sous tension, toute pièce défectueuse des sources d'alimentation de l'inverseur peut exploser ou faire exploser d'autres pièces. Pour entretenir les inverseurs, toujours porter un masque protecteur et un vêtement à manches longues.

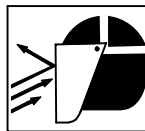

### LES ÉTINCELLES VOLANTES risquent de provoquer des blessures.

Le coupage plasma produit des étincelles et projections de métal à très haute température. Lorsque la pièce refroidit, du laitier peut se former.

- Portez une visière ou des lunettes de sécurité avec des écrans latéraux approuvés.
- Portez des vêtements de protection adéquats afin de protéger votre peau.
- Ayez recours à des protège-tympons ou à un serre-tête ignifuges afin d'éviter que les étincelles n'entrent dans vos oreilles.

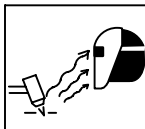

### LES RAYONS D'ARC peuvent entraîner des brûlures aux yeux et à la peau.

Les rayons d'arc provenant du procédé de coupage produisent des rayons visibles et invisibles intenses (ultraviolets et infrarouges) qui peuvent entraîner des brûlures aux yeux et à la peau.

- Lorsque vous coupez ou regardez quelqu'un couper, portez un masque ou un écran facial avec le filtre approprié. La norme ANSI Z49.1 (reportez-vous aux Principales normes de sécurité) suggère d'utiliser un filtre de teinte n° 9 (n° 8 étant le minimum) pour tout travail de coupage faisant appel à un courant de moins de 300 A. On mentionne également dans la norme Z49.1 qu'un filtre plus faible peut être utilisé lorsque l'arc est caché par la pièce à couper. Comme cela est habituellement le cas pour les travaux de coupage à faible courant, les teintes énumérées au tableau 1 sont fournies à titre d'information pour l'opérateur.
- Porter des lunettes de sécurité à coques latérales sous votre casque ou écran facial.
- Ayez recours à des écrans protecteurs ou à des rideaux pour protéger les autres contre les rayonnements et les éblouissements; prévenez toute personne sur les lieux de ne pas regarder l'arc.
- Portez des vêtements confectionnés avec des matières résistantes et ignifuges (cuir et laine) et des bottes de protection.

Tableau 1. Protection des yeux pour le coupage au plasma d'arc

Intensité de courant en ampères	Filtre de teinte (minimum)	
Moins de 20		no. 4
20 - 40		no. 5
40 - 60		no. 6
60 - 80		no. 8

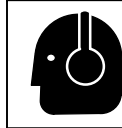

### LE BRUIT peut endommager l'ouïe.

Certaines applications de coupage produisent un bruit constant, ce qui peut endommager l'ouïe si le niveau sonore dépasse les limites permises par l'OSHA (reportez-vous aux Principales normes de sécurité).

- Utilisez des protège-tympons ou un serre-tête antibruit si le niveau sonore est élevé.
- Prévenez toute personne sur les lieux du danger relié au bruit.



### LES FUMÉES ET LES GAZ peuvent être dangereux.

Le coupage produit des vapeurs et des gaz. Respirer ces vapeurs et ces gaz peut être dangereux pour la santé.

- Ne mettez pas votre tête au-dessus des vapeurs. Ne respirez pas ces vapeurs.
- Si vous êtes à l'intérieur au moment du coupage, ventilez la pièce ou ayez recours à une ventilation aspirante installée près de l'arc pour évacuer les vapeurs et les gaz.
- Si la ventilation est médiocre, utilisez un respirateur anti-vapeurs approuvé.
- Veuillez lire le Material Safety Data Sheets (MSDS) et les instructions du fabricant pour obtenir plus de renseignements sur les métaux à couper, les enrobages et les nettoyants.
- Travaillez dans un espace restreint uniquement s'il est bien ventilé ou si vous portez un respirateur anti-vapeurs. Les vapeurs causées par le coupage et l'épuisement de l'oxygène peuvent altérer la qualité de l'air et entraîner des blessures ou la mort. Assurez-vous que l'air ambiant est sain pour la santé.
- Ne coupez pas dans un endroit près d'opérations de décapage, de nettoyage ou de vaporisation. La chaleur et les rayons d'arc peuvent réagir avec les vapeurs et former des gaz hautement toxiques et irritants.
- Ne coupez pas des métaux enrobés tels que des métaux galvanisés, contenant du plomb ou de l'acier plaqué au cadmium, à moins que l'enrobage ne soit ôté de la surface du métal à couper, que l'endroit où vous travaillez ne soit bien ventilé, ou, si nécessaire, que vous ne portiez un respirateur anti-vapeurs. Les enrobages ou tous métaux qui contiennent ces éléments peuvent créer des vapeurs toxiques s'ils sont coupés.
- Ne coupez pas de contenants qui renferment ou ont renfermés des matières toxiques ou réactives – vous devez en premier lieu les vider et les nettoyer convenablement.

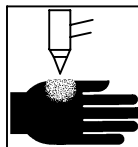

### LE PLASMA D'ARC peut entraîner des blessures.

La chaleur dégagée par le plasma d'arc peut entraîner de sérieuses brûlures. La force de l'arc est un facteur qui s'ajoute au danger de brûlures. La chaleur intense et la puissance de l'arc peuvent rapidement passer au travers de gants et de tissus.

- N'approchez pas le tube du chalumeau.
- Ne saisissez pas la pièce à couper près de la ligne de coupage.
- L'arc pilote peut causer des brûlures – n'approchez pas le tube du chalumeau lorsque vous avez appuyé sur le gâchette.
- Portez des vêtements de protection adéquats qui recouvrent tout votre corps.
- Ne pointez pas le chalumeau en direction de votre corps ni de la pièce à couper lorsque vous appuyez sur la gâchette – l'arc pilote s'allume automatiquement.
- Mettez l'alimentation hors tension et débranchez le cordon d'alimentation avant de démonter le chalumeau ou de changer une pièce du chalumeau.
- Utilisez uniquement le ou les chalumeaux recommandés dans le manuel de l'opérateur.

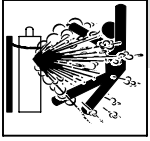

### LES BOUTEILLES peuvent exploser si elles sont endommagées.

Les bouteilles de gaz contiennent du gaz sous haute pression. Si une bouteille est endommagée, elle peut exploser. Puisque les bouteilles de gaz sont habituellement partie d'un processus de travail des métaux, assurez-vous de les manipuler correctement.

- Protégez les bouteilles de gaz comprimé contre la chaleur excessive, les chocs mécaniques, le laitier, la flamme, les étincelles et l'arc.
- Installez et attachez les bouteilles dans la position verticale à l'aide d'une chaîne, sur un support stationnaire ou un châssis porte-bouteille afin de prévenir qu'elles ne tombent ou ne basculent.
- Les bouteilles ne doivent pas être près de la zone de coupage ni de tout autre circuit électrique.

## 2-3. Dangers supplémentaires en relation avec l'installation, le fonctionnement et la maintenance



### DES PIÈCES CHAUDES peuvent provoquer des brûlures graves.

- Ne pas toucher des parties chaudes à mains nues.
- Laisser refroidir avant d'intervenir sur la torche.



### DES ORGANES MOBILES peuvent provoquer des blessures.

- S'abstenir de toucher des organes mobiles tels que des ventilateurs.
- Maintenir fermés et verrouillés les portes, panneaux, recouvrements et dispositifs de protection.

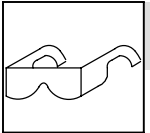

### DES PARTICULES VOLANTES peuvent blesser les yeux.

- Porter des lunettes de sécurité avec protections latérales ou frontales.

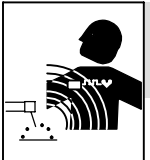

### LES CHAMPS MAGNÉTIQUES peuvent affecter les stimulateurs cardiaques.

- Porteurs de stimulateur cardiaque, restez à distance.
- Les porteurs sont priés de consulter leur médecin avant d'approcher les opérations de coupage plasma.

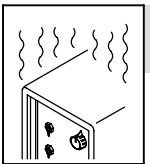

### L'EMPLOI EXCESSIF peut SURCHAUFFER L'ÉQUIPEMENT.

- Prévoir une période de refroidissement; respecter le cycle opératoire nominal.
- Réduire l'ampérage (épaisseur) avant de continuer à couper ou réduire le facteur de marche.



### Danger D'EXPLOSION D'HYDROGÈNE.

- Lors du coupage d'aluminium partiellement ou totalement immergé dans l'eau, de l'hydrogène libre peut s'accumuler sous la pièce.
- Consultez votre ingénieur de coupage et les instructions de la table de coupage.



### LA CHUTE DE L'APPAREIL peut blesser.

- Utiliser l'anneau de levage uniquement pour soulever l'appareil, NON PAS les chariot, les bouteilles de gaz ou tout autre accessoire.
- Utiliser un engin d'une capacité appropriée pour soulever l'appareil.
- En utilisant des fourches de levage pour déplacer l'unité, s'assurer que les fourches sont suffisamment longues pour dépasser du côté opposé de l'appareil.

- Un contact électrique ne doit jamais se produire entre un chalumeau de plasma d'arc et une bouteille.
- Ne coupez jamais sur une bouteille pressurisée – une explosion en résulterait.
- Utilisez uniquement des bouteilles de gaz, des détendeurs, des boyaux et des raccords conçus pour l'application déterminée. Gardez-les, ainsi que toute autre pièce associée, en bonne condition.
- Détournez votre visage du détendeur-régulateur lorsque vous ouvrez la soupape de la bouteille.
- Le couvercle du détendeur doit toujours être en place, sauf lorsque vous utilisez la bouteille ou qu'elle est reliée pour usage ultérieur.
- Lisez et suivez les instructions sur les bouteilles de gaz comprimé, l'équipement connexe et le dépliant P-1 de la CGA mentionné dans les Principales normes de sécurité.



### Risque D'INCENDIE OU D'EXPLOSION.

- Ne pas placer l'appareil sur, au-dessus ou à proximité de surfaces inflammables.
- Ne pas installer l'appareil à proximité de produits inflammables.
- Ne pas surcharger l'installation électrique – s'assurer que l'alimentation est correctement dimensionnée et protégée avant de mettre l'appareil en service.

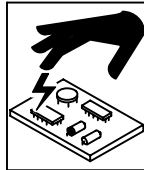

### LES CHARGES ÉLECTROSTATIQUES peuvent endommager les circuits imprimés.

- Établir la connexion avec la barrette de terre avant de manipuler des cartes ou des pièces.
- Utiliser des pochettes et des boîtes antistatiques pour stocker, déplacer ou expédier des cartes PC.

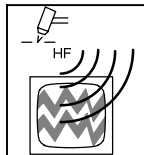

### LE RAYONNEMENT HAUTE FRÉQUENCE (H.F.) risque de provoquer des interférences.

- Le Rayonnement haute fréquence (H.F.) peut provoquer des interférences avec les équipements de radio-navigation et de communication, les services de sécurité et les ordinateurs.
- Demander seulement à des personnes qualifiées familiarisées avec des équipements électroniques de faire fonctionner l'installation.
- L'utilisateur est tenu de faire corriger rapidement par un électricien qualifié les interférences résultant de l'installation.
- Si le FCC signale des interférences, arrêter immédiatement l'appareil.
- Effectuer régulièrement le contrôle et l'entretien de l'installation.
- Maintenir soigneusement fermés les portes et les panneaux des sources de haute fréquence, maintenir les éclateurs à une distance correcte et utiliser une terre et un blindage pour réduire les interférences éventuelles.

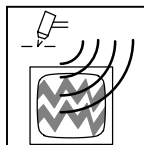

### LE COUPAGE À L'ARC peut causer des interférences.

- L'énergie électromagnétique peut gêner le fonctionnement d'appareils électroniques comme des ordinateurs et des robots.
- Pour réduire la possibilité d'interférence, maintenir les câbles aussi courts que possible, les grouper, et les poser aussi bas que possible (ex. par terre).
- Veiller à couper à une distance de 100 mètres de tout équipement électronique sensible.
- S'assurer que la source de coupage est correctement branchée et mise à la terre.
- Si l'interférence persiste, l'utilisateur doit prendre des mesures supplémentaires comme écarter la machine, utiliser des câbles blindés de des filtres, ou boucler la zone de travail.

## 2-4. Principales normes de sécurité

*Safety in Welding and Cutting*, norme ANSI Z49.1, de l'American Welding Society, 550 N.W. Lejeune Rd, Miami FL 33126

*Safety and Health Standards*, OSHA 29 CFR 1910, du Superintendent of Documents, U.S. Government Printing Office, Washington, D.C. 20402.

*Recommended Safe Practice for the Preparation for Welding and Cutting of Containers That Have Held Hazardous Substances*, norme AWS F4.1, de l'American Welding Society, 550 N.W. Lejeune Rd, Miami FL 33126

*National Electrical Code*, NFPA Standard 70, de la National Fire Protection Association, Batterymarch Park, Quincy, MA 02269.

*Safe Handling of Compressed Gases in Cylinders*, CGA Pamphlet P-1, de la Compressed Gas Association, 1235 Jefferson Davis Highway, Suite 501, Arlington, VA 22202.

*Règles de sécurité en soudage, coupage et procédés connexes*, norme CSA W117.2, de l'Association canadienne de normalisation, vente de normes, 178 Rexdale Boulevard, Rexdale (Ontario) Canada M9W 1R3.

*Safe Practices For Occupation And Educational Eye And Face Protection*, norme ANSI Z87.1, de l'American National Standards Institute, 1430 Broadway, New York, NY 10018.

*Cutting and Welding Processes*, norme NFPA 51B, de la National Fire Protection Association, Batterymarch Park, Quincy, MA 02269.

## 2-5. Information sur les champs électromagnétiques

Données sur le soudage électrique et sur les effets, pour l'organisme, des champs magnétiques basse fréquence

Le courant de soudage ou de coupage passant dans les câbles de puissance crée des champs électromagnétiques. Il y a eu et il y a encore un certain souci à propos de tels champs. Cependant, après avoir examiné plus de 500 études qui ont été faites pendant une période de recherche de 17 ans, un comité spécial ruban bleu du National Research Council a conclu: "L'accumulation de preuves, suivant le jugement du comité, n'a pas démontré que l'exposition aux champs magnétiques et champs électriques à haute fréquence représente un risque à la santé humaine". Toutefois, des études sont toujours en cours et les preuves continuent à être examinées. En attendant que les conclusions finales de la recherche soient établies, il vous serait souhaitable de réduire votre exposition aux champs électromagnétiques pendant le soudage ou le coupage.

Afin de réduire les champs électromagnétiques dans l'environnement de travail, respecter les consignes suivantes :

















- 1 Garder les câbles ensemble en les torsadant ou en les attachant avec du ruban adhésif.
- 2 Mettre tous les câbles du côté opposé de l'opérateur.
- 3 Ne pas courber pas et ne pas entourer pas les câbles autour de vous.
- 4 Garder le poste de soudage et les câbles le plus loin possible de vous.
- 5 Relier la pince de masse le plus près possible de la zone de soudure.

### Consignes relatives aux stimulateurs cardiaques :

Les consignes mentionnées précédemment font partie de celles destinées aux personnes ayant recours à un stimulateur cardiaque. Veuillez consulter votre médecin pour obtenir plus de détails.

# SECTION 3 – DEFINITIONS

## 3-1. Symbols And Definitions For Nameplate And Serial Number/Rating Label

<b>A</b>	Amperes		Plasma Arc Cutting (PAC)		Adjust Air/Gas Pressure		Low Air Pressure Light
<b>V</b>	Volts		Increase		No - Do Not Do This		Temperature
	Protective Earth (Ground)		Single Phase		Constant Current		Voltage Input
<b>I</b>	On		Off	<b>%</b>	Percent		Direct Current
<b>U<sub>0</sub></b>	Rated No Load Voltage (Average)	<b>U<sub>1</sub></b>	Primary Voltage	<b>U<sub>2</sub></b>	Conventional Load Voltage		Line Connection
<b>I<sub>1max</sub></b>	Rated Maximum Supply Current	<b>I<sub>2</sub></b>	Rated Welding Current	<b>X</b>	Duty Cycle		Single Phase Static Frequency Transformer-Rectifier-Converter
<b>IP</b>	Degree Of Protection		Loose Shield Cup		Input	<b>Hz</b>	Hertz
<b>I<sub>1eff</sub></b>	Maximum Effective Supply Current	<b>pf</b>	power factor		Suitable for Some Hazardous Locations	<b>S<sub>1</sub></b>	Power Rating, Product Of Voltage And Current (KVA)

# SECTION 4 – INSTALLATION

## 4-1. Specifications For Power Source



Primary Volts	Primary Amperes	Primary Service (Recommended)	Secondary Volts (DC)	Secondary Amperes	KW	KVA	Rated Cutting Capacity	Power Factor	Max** OCV (DC)
120	20.32 (0.25*)	20A	110	12	2.01	2.44	0.25 in (6.4 mm) At 6 IPM (2.5 mm/s)	0.82	353

\*While idling  
\*\*10% High line condition

## 4-2. Specifications For Torch

Air-cooled torch for plasma arc cutting (PAC)
35% duty cycle
Gas flow/pressure: 1 SCFM (28.3 L/min) at 50 PSI (345 kPa)
Safety interlock devices shut down power source
Safety trigger guard
Cutting capacity: see Section 4-1

## 4-3. Duty Cycle And Overheating

Duty Cycle is percentage of 10 minutes that unit can cut at rated load without overheating.

If unit overheats, thermostat(s) opens, output stops, Temperature trouble light goes On, and cooling fan runs. Wait fifteen minutes for unit to cool or temperature light to go off. Reduce amperage or duty cycle before cutting or gouging.

**▲ Exceeding duty cycle can damage unit and void warranty.**

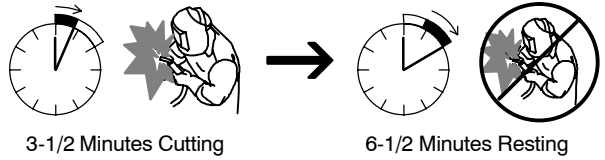

3-1/2 Minutes Cutting      6-1/2 Minutes Resting

---

**Overheating**

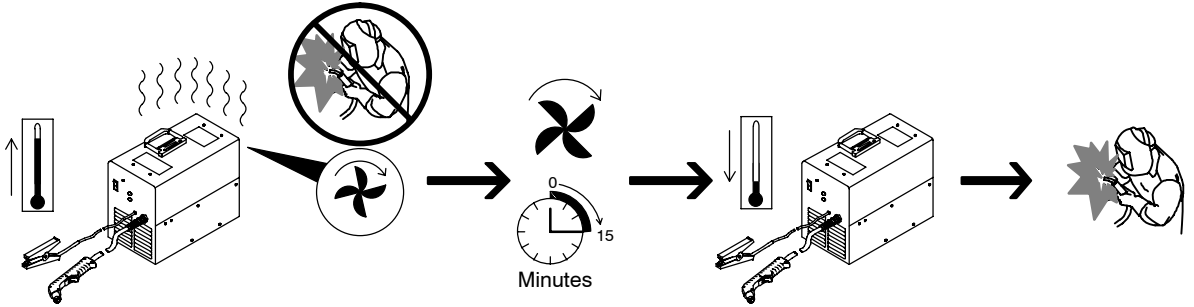

Minutes

duty1 4/95 – 802 588-A

## 4-4. Torch Dimensions And Weight

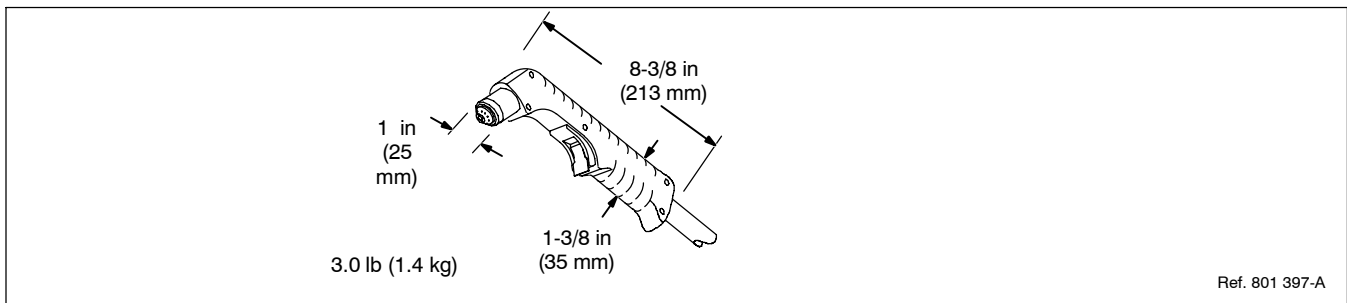

## 4-5. Selecting A Location

**Dimensions And Weight**  
42 lb (19.1 kg)

Dimensions of the unit:

- Top width: 6-3/4 in (171 mm)
- Height: 17 in (432 mm)
- Depth: 18 in (457 mm)

---

**Movement**

1 Lifting Handle  
Use handle to lift unit.

2 Hand Cart  
Use cart or similar device to move unit.

3 120 VAC Receptacle  
Locate unit near correct input power supply.

**▲ Special installation may be required where gasoline or volatile liquids are present – see NEC Article 511 or CEC Section 20.**

---

**Location And Airflow**

☞ Serial Number/Rating Label located on rear panel of plasma cutter; use label to determine input power for unit.

10 in (254 mm) [Airflow direction]

10 in (254 mm) [Airflow direction]

3 [Power Receptacle]

loc\_2 3/96 - Ref. 802 588-A / 802 589-A

## 4-6. Connecting Work Clamp

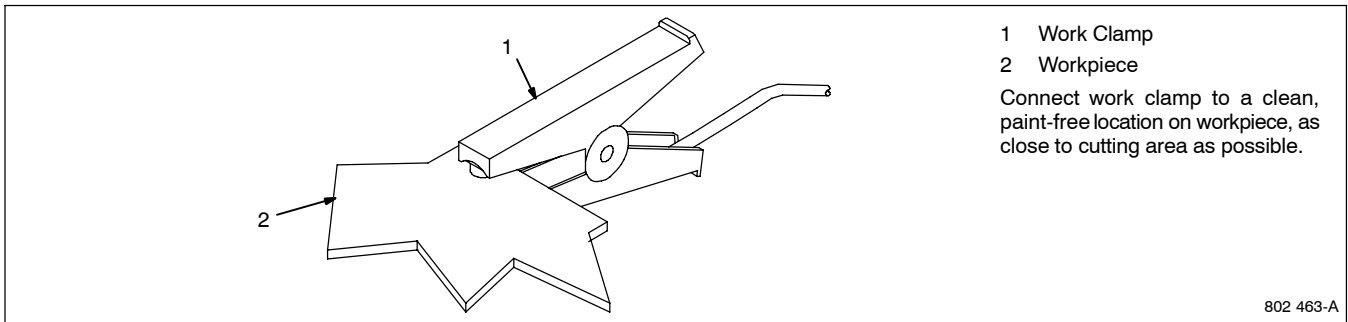

## 4-7. Connecting Input Power

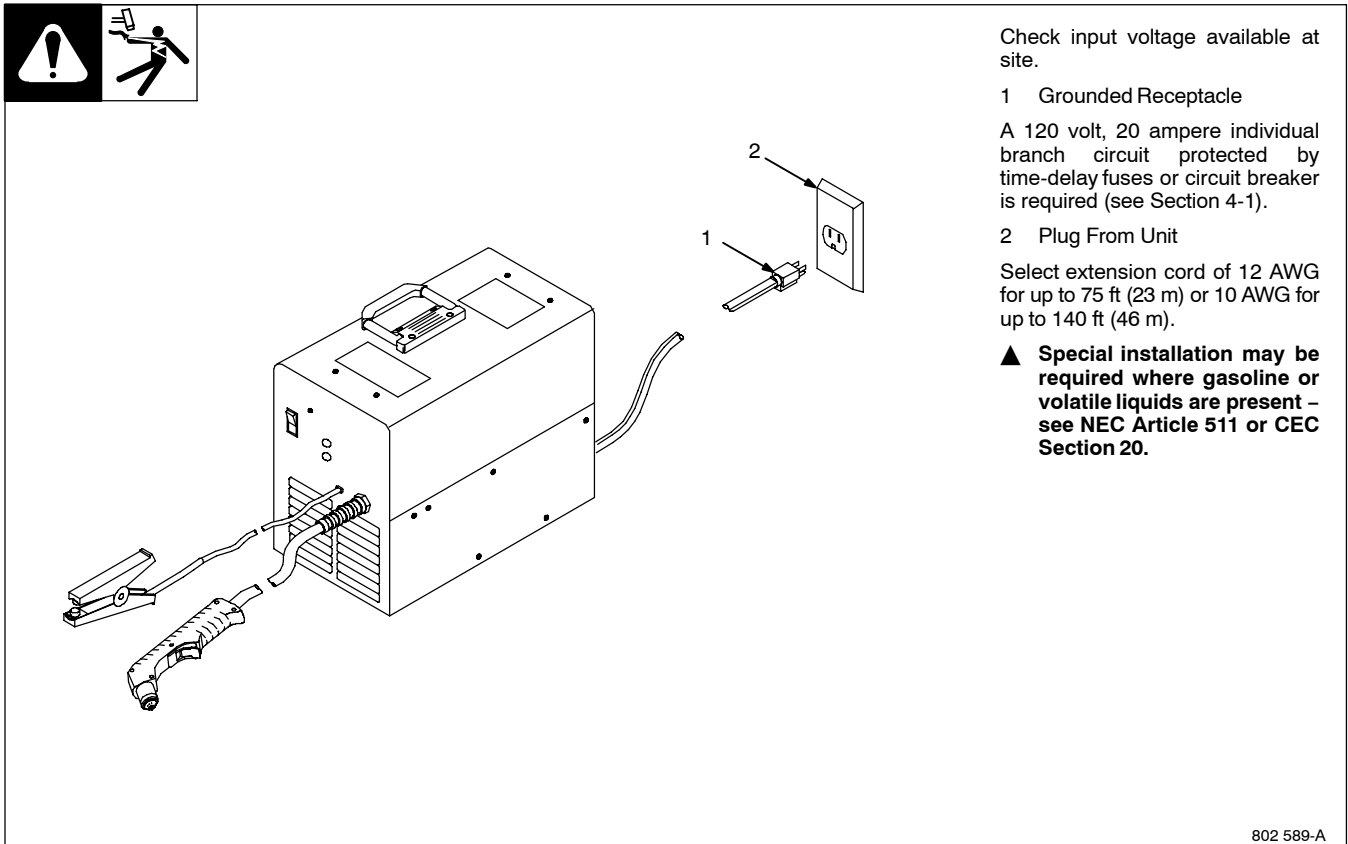



# SECTION 5 – OPERATION

## 5-1. Controls

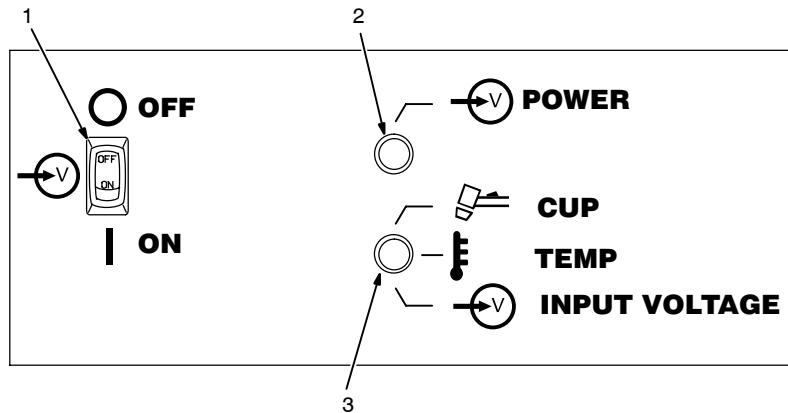

196 630

1 Power Switch

2 Power Light

Use light to tell if unit is energized and ready to operate. Light goes off if input power is not within specified range (see trouble light information).

3 Trouble Light

Trouble light comes on for the following conditions:

a If cup is removed from torch (unit power must be turned off and back on again)

b If unit overheats

c If input power is not within specification (93 to 137 vac). If input power is outside of specified range, cycle power by placing the power switch in the off position and back on again. Check input power if problem continues.

Cutting Speed vs. Material Thickness

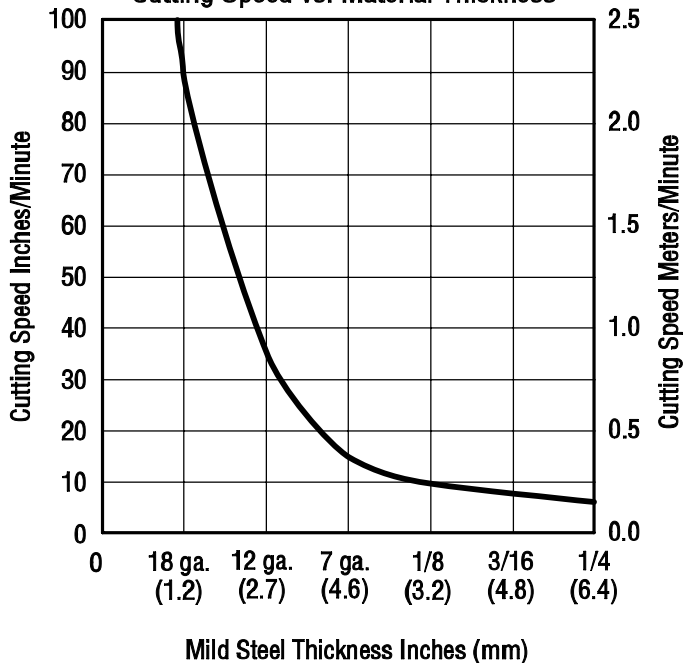

## 5-2. Trigger Safety Lock

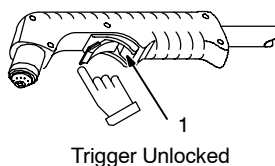
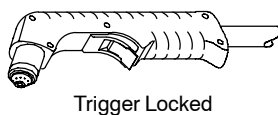

801 545-A

## 5-3. Sequence Of Operation



### EXAMPLE Of Cutting Operation

☞ *Moisture from the compressor will form in the air line and at the torch. It will be normal to sometimes see moisture come out the end of the torch.*

⚠ **The pilot arc starts immediately when trigger is pressed.**

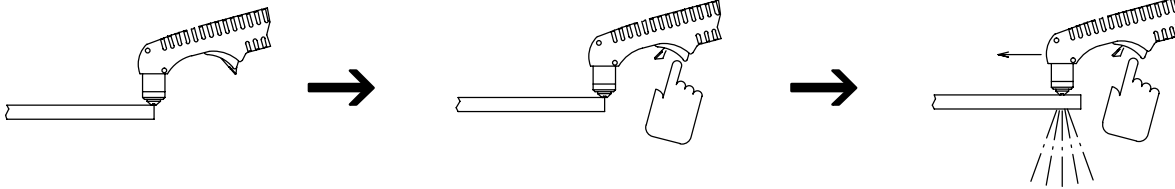

For shielded cutting, place drag shield on edge of metal. For non-shielded cutting, use 1/8 in (3.2 mm) standoff distance (dragging tip will reduce tip life).

Raise trigger lock and press trigger. Pilot arc starts.

After cutting arc starts, slowly start moving torch across metal.

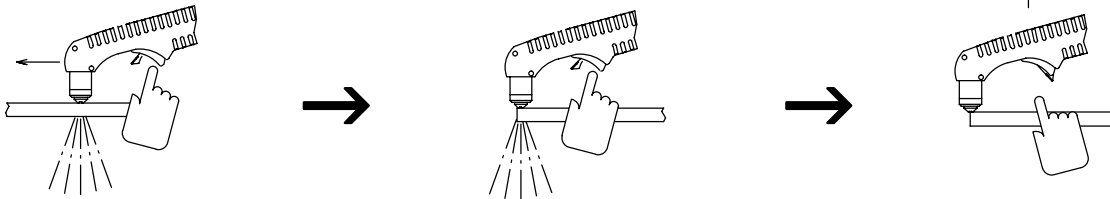

Adjust torch speed so sparks go thru metal and out bottom of cut.

Pause briefly at end of cut before releasing trigger.

Postflow continues for approx. 12 seconds after releasing trigger; cutting arc can be instantly restarted during postflow by raising trigger lock and pressing trigger.

As a convenience, the torch can be set up with two cutting combinations, either drag or non-shielded cutting. The torch comes standard with drag cutting.

☞ *Maximum performance on thicker materials can be obtained by using non-shielded cutting with a 1/16 - 1/8 in (1.6 - 3.2 mm) standoff.*

### Drag Cutting

Use retaining cup (197 567) and drag shield (196 929) to obtain a 1/16 in (1.6 mm) standoff automatically. This combination is designed to allow dragging the torch directly on the workpiece. Use shields for ease of use when cutting with a template, or when drag cutting is preferred.

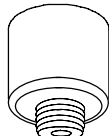

197 567



196 929

### Non-Shielded Cutting

Use retaining cup (196 928) and hold a 1/16-1/8 in (1.6-3.2 mm) standoff between the workpiece and cutting tip. Use non-shielded when visually following a line.

☞ *This combination can be used for drag cutting but does not provide optimum cutting performance on thicker material.*

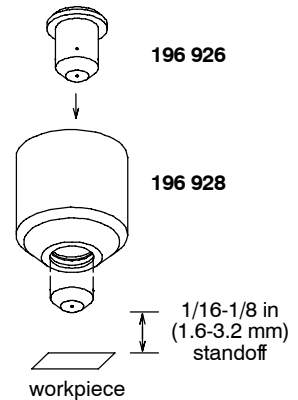

196 926

196 928









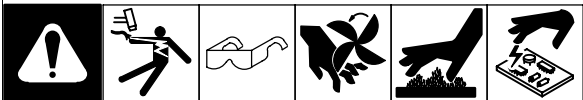
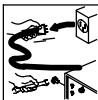

workpiece

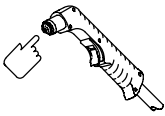
1/16-1/8 in  
(1.6-3.2 mm)  
standoff

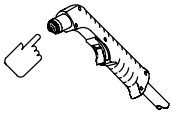
801 400-A

# SECTION 6 – MAINTENANCE & TROUBLESHOOTING

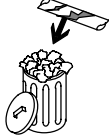
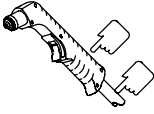
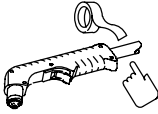
## 6-1. Routine Maintenance

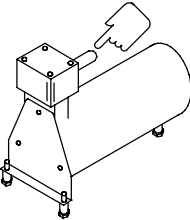
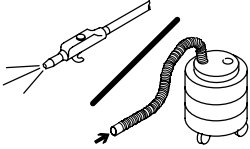
		 <b>▲ Disconnect power before maintaining.</b>		 <i>Maintain more often during severe conditions.</i>
 <b>Each Use</b>				
		Check Torch Tip, Electrode, And Shield Cup		
 <b>Every Week</b>				
		Check Shield Cup Shutdown System		
 <b>3 Months</b>				
				Replace Damaged Or Unreadable Labels
	Replace Cracked Parts			
		Torch Body, Cable		
		Tape Torn Outer Covering		
 <b>6 Months</b>				
	Check Compressor Filter – Clean With A Damp Cloth Or Replace If Necessary (Compressor Model Only)			
		Blow Out Or Vacuum Inside		

## 6-2. Trouble Light And Checking Shield Cup Shutdown System

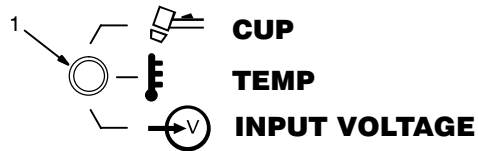
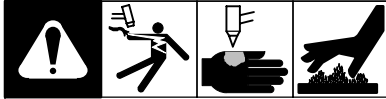

### Checking Torch Shield Cup Shutdown System

 Power source Power switch must be reset whenever cup shutdown system is activated. **Always turn Off power source when changing or checking consumables.**

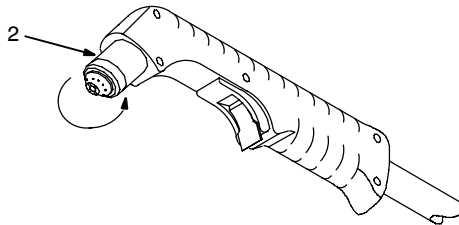

If certain problems occur, the trouble light comes on, and output stops.

#### 1 Trouble Light

- a Lights if shield cup is loose.

Turn power Off, and check shield cup connection (see Item 2 below). Power must be reset whenever the cup shutdown is activated.

Check shield cup shutdown system once a week.

- b Lights if power source overheats (see Sections 4-3 and 4-5).

- c Lights if input power is not within specification (93 to 137 vac). Power must be reset whenever the input voltage shutdown is activated.

#### 2 Torch Shield Cup

Turn Power On and loosen shield cup. If shutdown system works properly, trouble light comes on. If not, turn power Off and check for loose shield cup. Check consumables (see Sections 6-4 and Parts List).

If system works properly, retighten cup and reset power.

## 6-3. Torch And Work Cable Connections

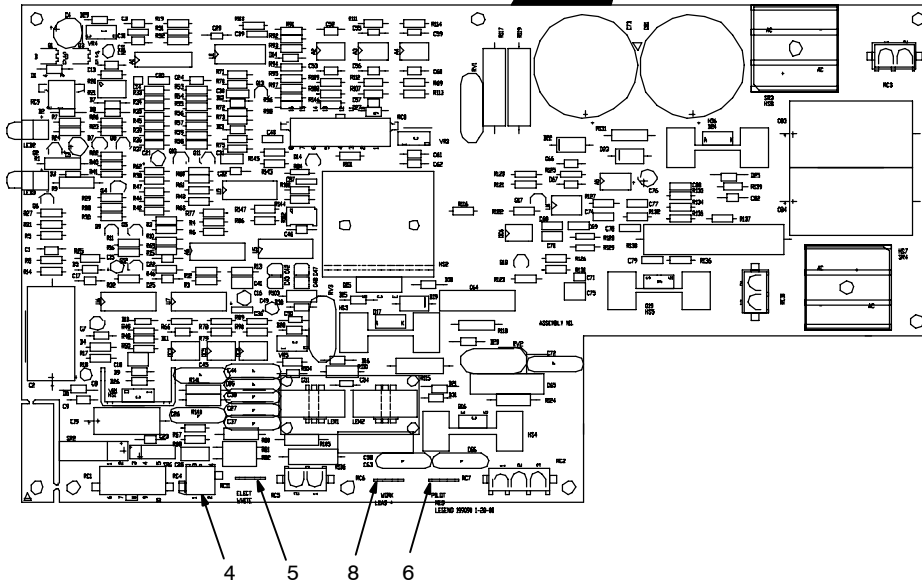
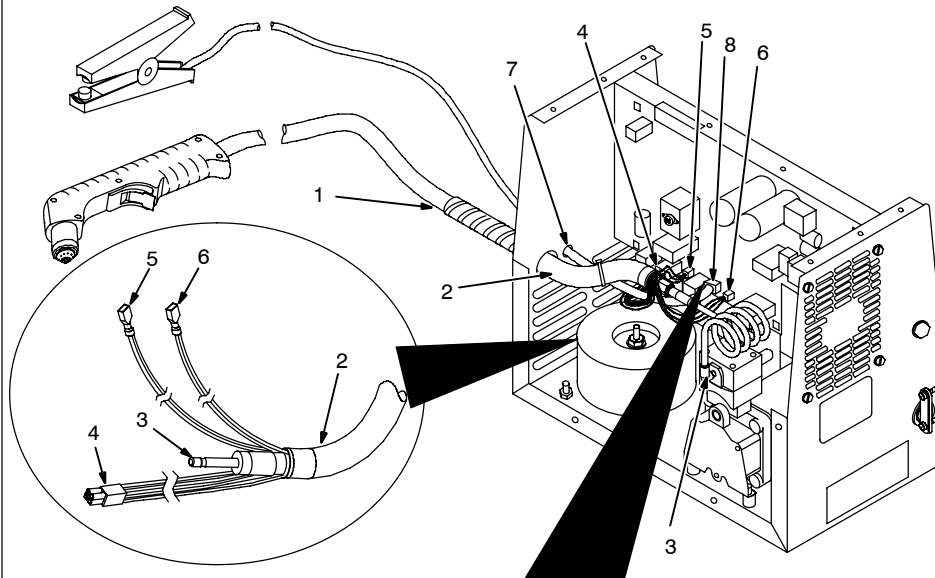

If torch or work cable needs to be removed or replaced, proceed as follows:

Turn power Off, and disconnect input power plug from receptacle. Remove wrapper from unit.

### Torch Connections

Remove existing torch cable from unit.

- 1 Strain Relief
- 2 Torch Cable

Insert cable through strain relief. Slide strain relief nut onto torch cable, but do not tighten.

- 3 Air Line Connector

Install air line connector onto compressor fitting.

- 4 Plug PLG4/Receptacle RC4

Connect PLG4 to receptacle RC4 on circuit board PC1.

- 5 Female And Male Friction Terminal RC11/ELECT WHITE

Connect female friction terminal on end of white leads to RC11/ELECT WHITE.

- 6 Female And Male Friction Terminal RC7/PILOT RED

Connect female friction terminal on end red leads to RC7/PILOT RED.

Tighten strain relief nut.

Tighten strain relief around cable.

### Work Cable Connections

Remove existing work cable from unit.

- 7 Strain Relief

*Be sure to allow some work cable slack inside the unit.*

Insert work clamp lead through strain relief, and install strain relief into front panel.

- 8 Work Lead Male Friction Terminal

Connect work clamp lead to male friction terminal labeled WORK LEAD on circuit board PC1. Route lead along torch lead bundle.

#### Tools Needed:

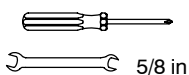

## 6-4. Checking/Replacing Retaining Cup, Tip, And Electrode



**⚠** Overtightening will strip threads. Do not overtighten retaining cup during assembly. Do not cross-thread parts causing stripping. Use care during torch assembly and parts replacement.

**⚠** Inspect shield cup, tip, and electrode for wear before cutting or whenever cutting speed has been significantly reduced. Do not operate torch without a tip or electrode in place. Be sure to use genuine replacement parts.

A good practice is to replace both the tip and electrode at the same time.

**⚠** Turn Off power source before checking torch parts.

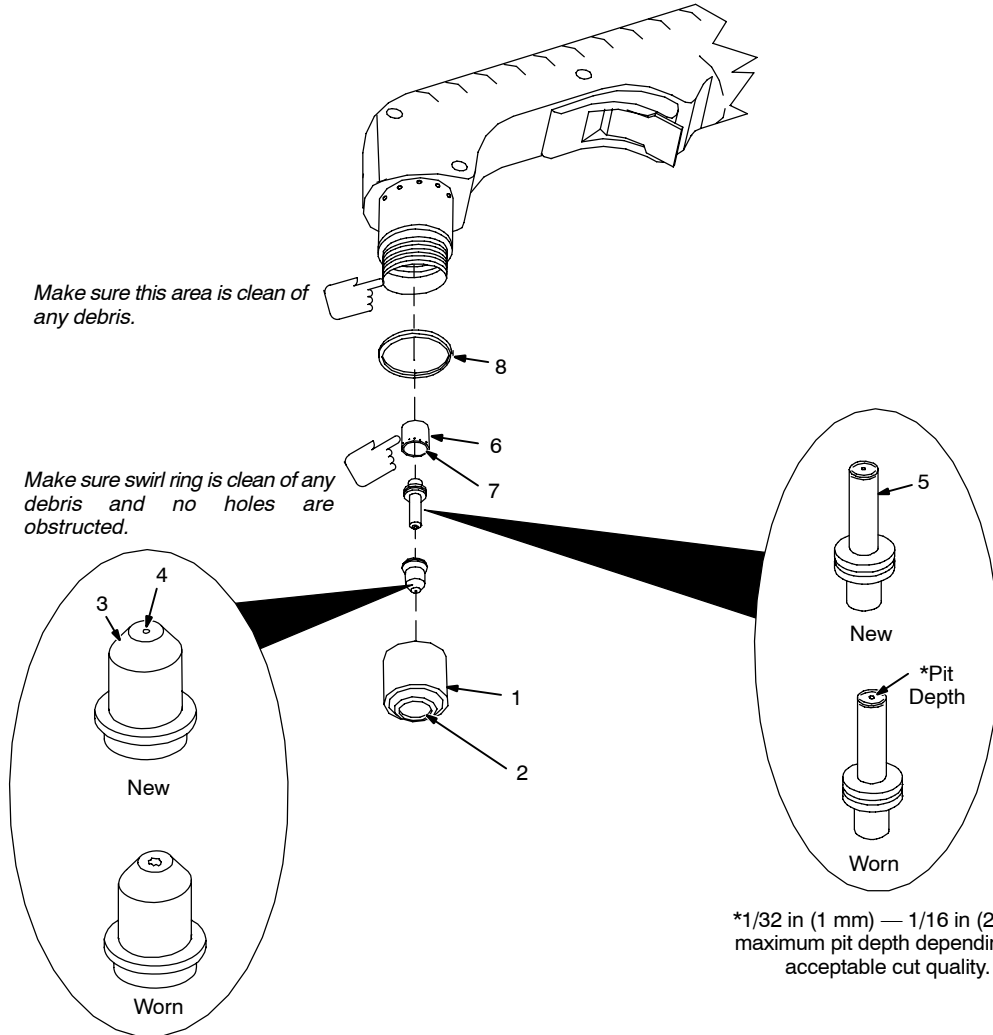

802 465

Turn Off power source.

1 Shield Cup

2 O-Ring

Remove shield cup. Check cup for cracks, and replace if necessary.

Check O-ring for cracks or worn spots, replace shield cup if necessary.

3 Tip

4 Opening

Remove tip. Check tip, and replace if opening is deformed or 50% oversize. If inside of tip is not clean and bright, clean with steel wool. Be sure to remove any pieces of steel wool afterwards.

5 Electrode

Check electrode. If center has a pit more than a 1/16 in (2 mm) deep, remove and replace electrode.

6 Swirl Ring

7 O-Ring

Remove swirl ring. Check ring, and replace if side holes are plugged.

Check O-ring for cracks or worn spots, replace swirl ring if necessary.

8 O-Ring

Check O-ring for cracks or worn spots, and replace if necessary.

Carefully reassemble parts in reverse order.

## 6-5. Troubleshooting Power Source

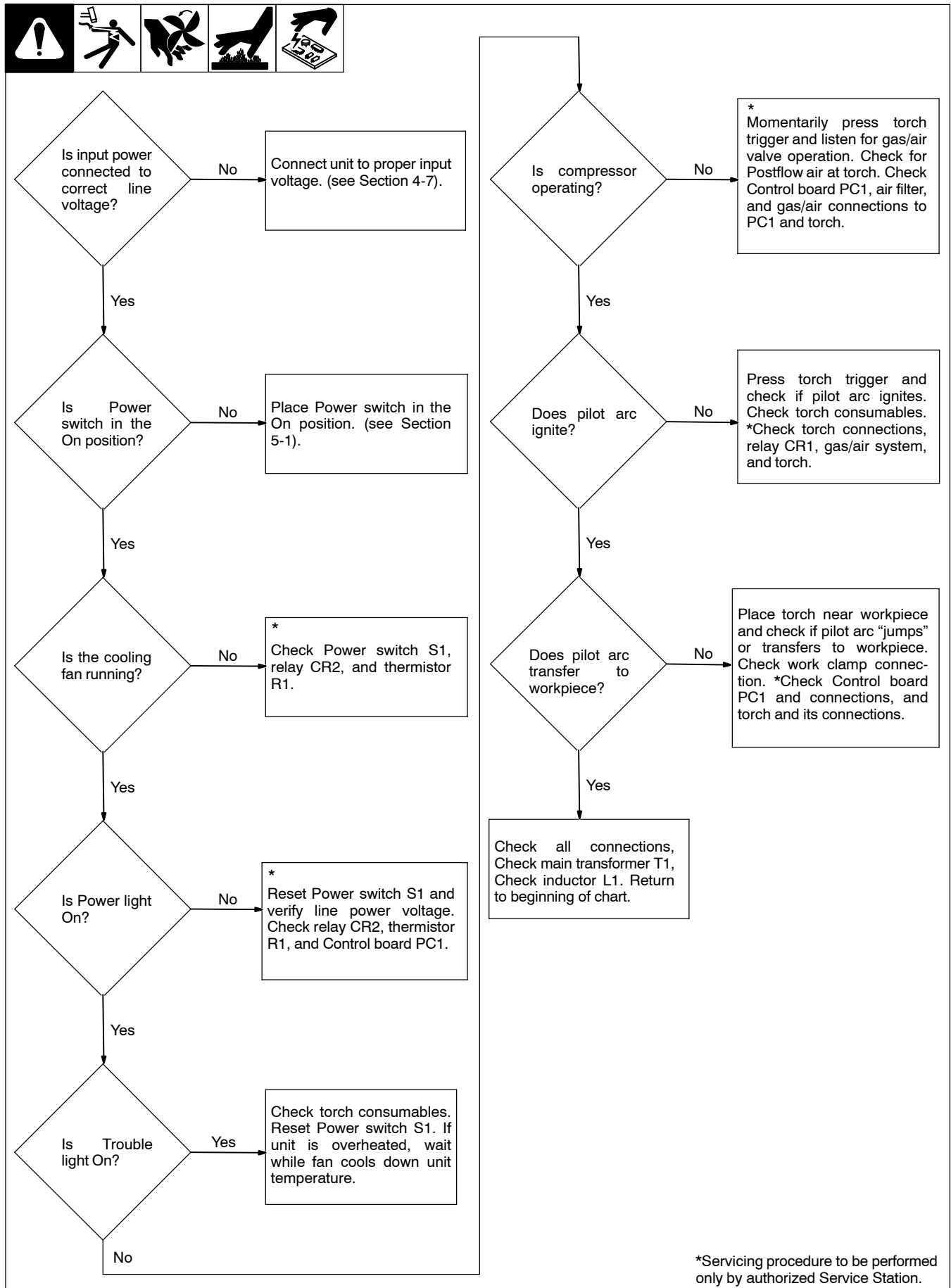

## 6-6. Troubleshooting Torch

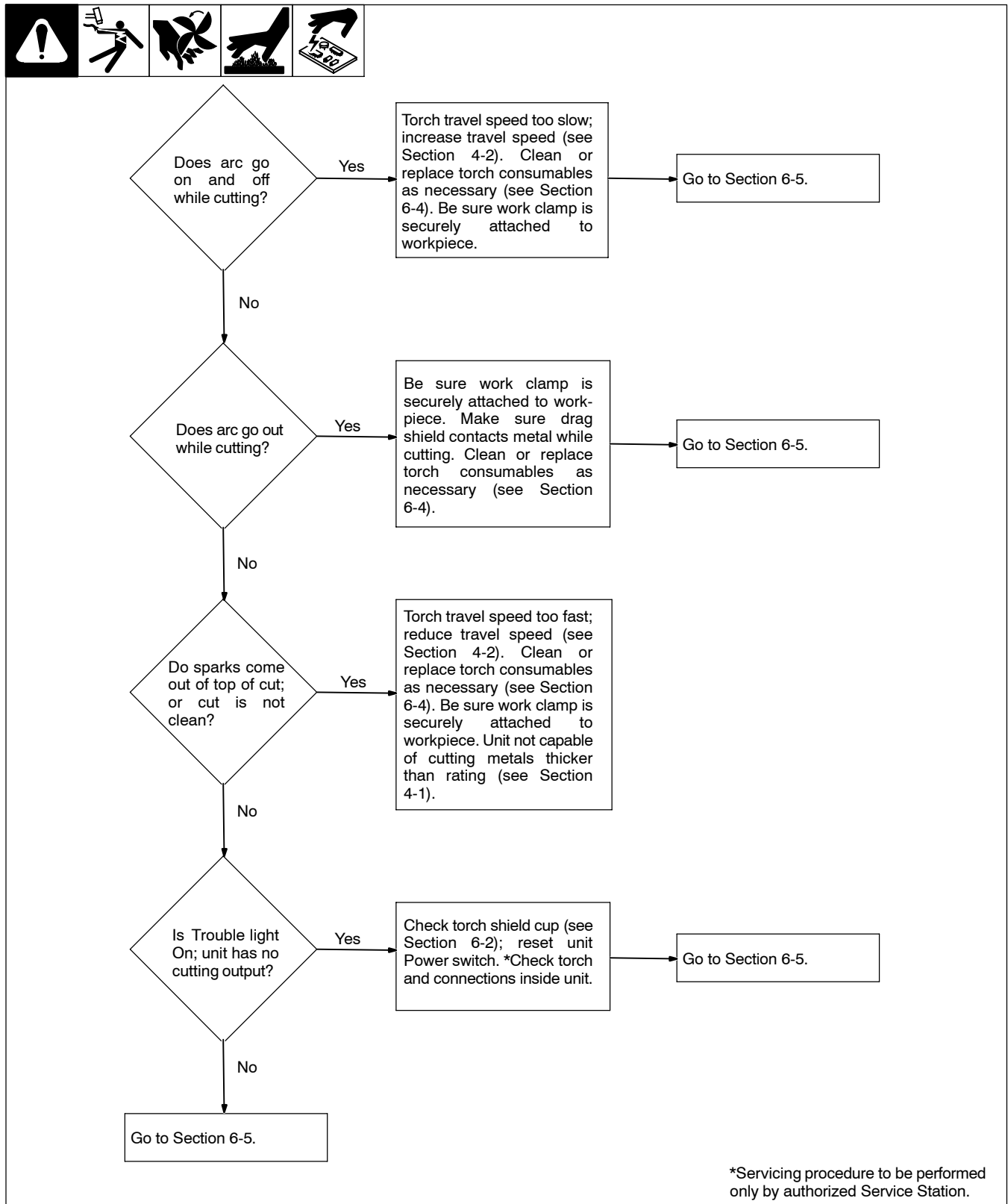



# SECTION 7 - ELECTRICAL DIAGRAM

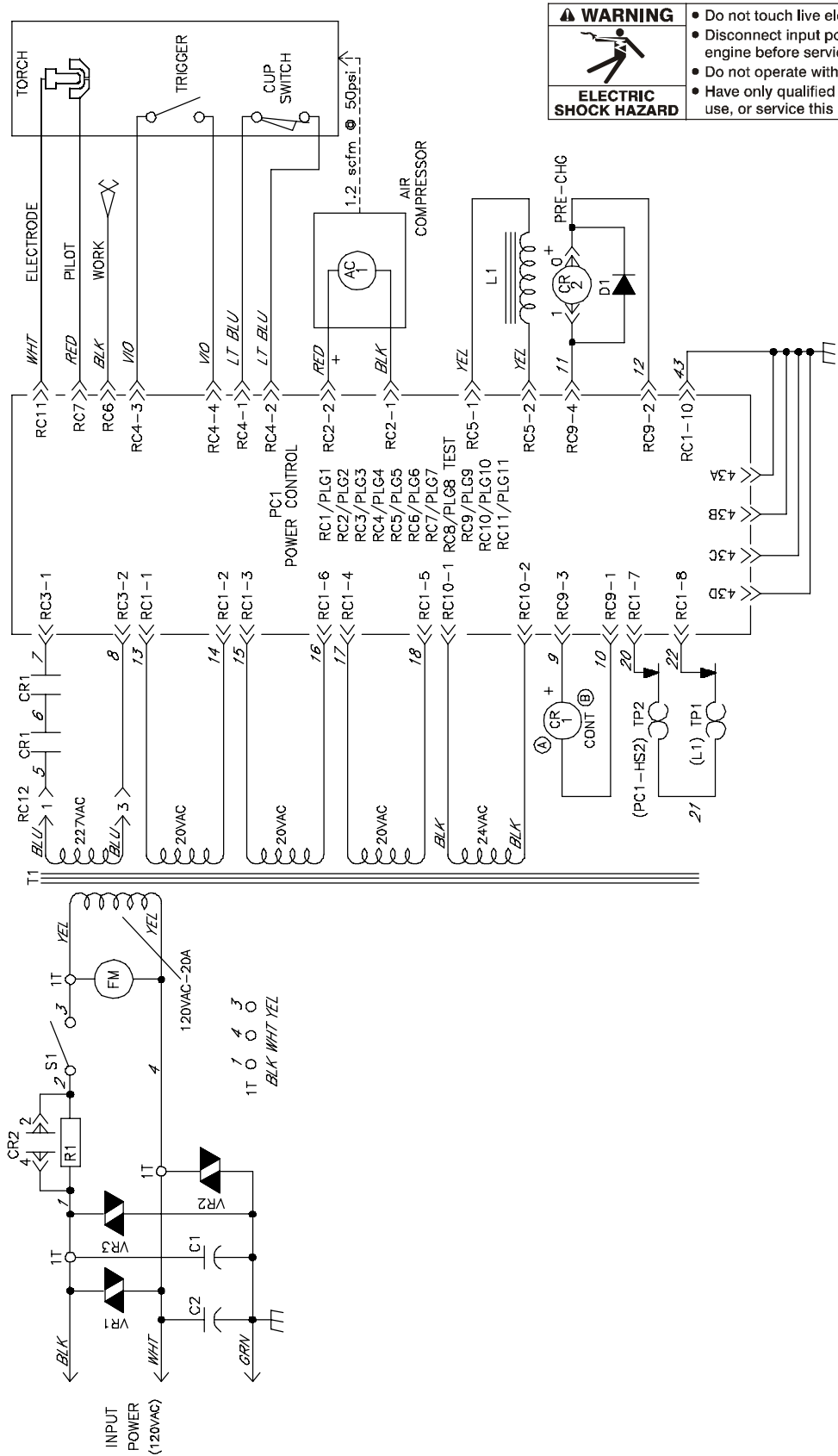

**⚠ WARNING**

**ELECTRIC SHOCK HAZARD**

- Do not touch live electrical parts.
- Disconnect input power or stop engine before servicing.
- Do not operate with covers removed.
- Have only qualified persons install, use, or service this unit.

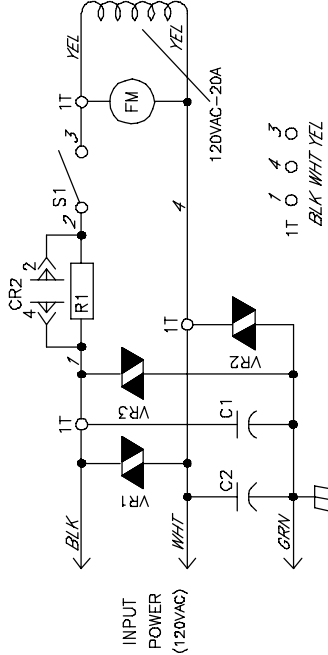

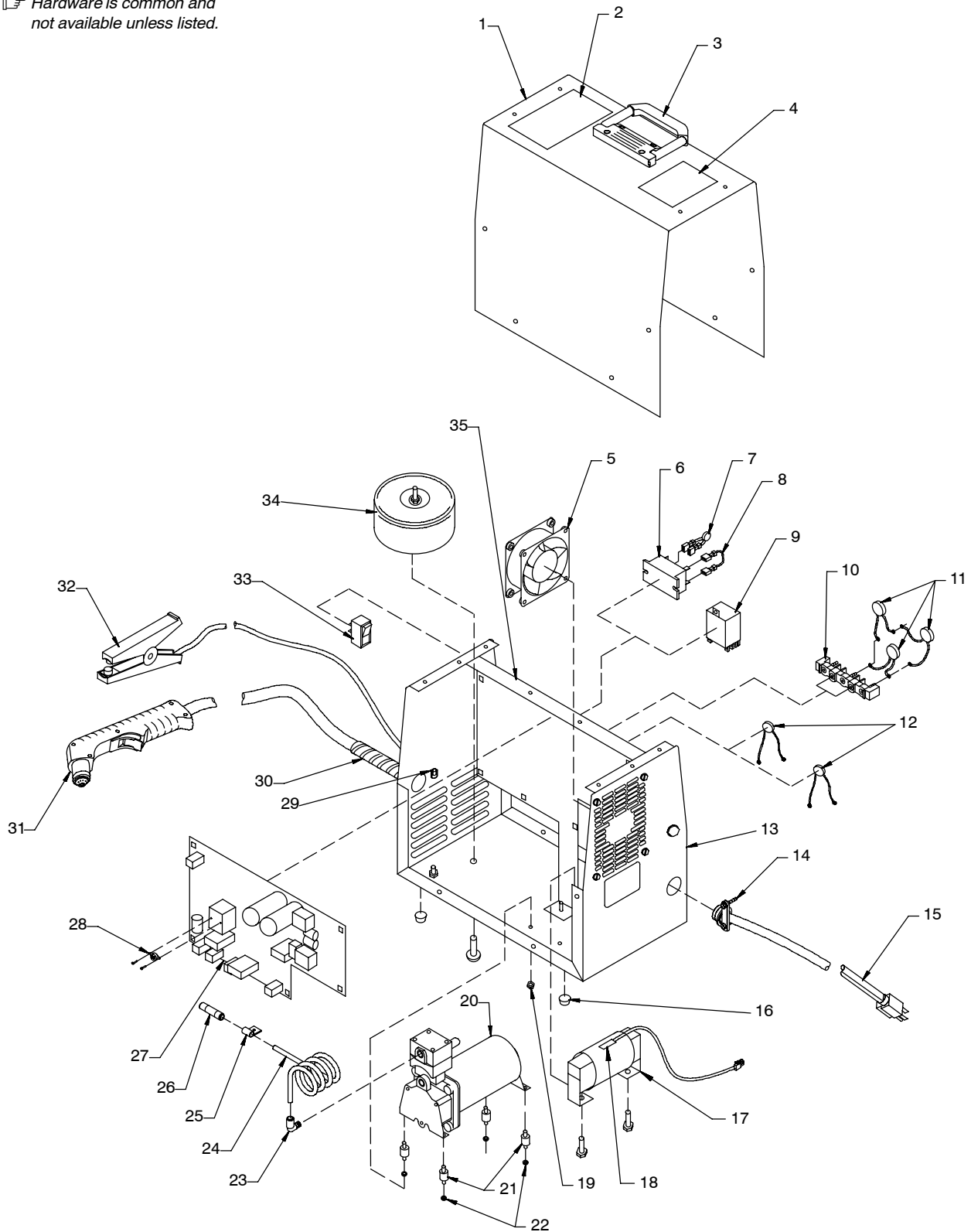

Figure 7-1. Circuit Diagram

# SECTION 8 – PARTS LIST

 Hardware is common and not available unless listed.



Ref. 802 591-F

Figure 8-1. Main Assembly

Item No.	Dia. Mkgs.	Part No.	Description	Quantity
----------	------------	----------	-------------	----------

**Figure 8-1. Main Assembly**

.....		212 524 ..	COVER ASSY (including) .....	1
1		+195 621 .....	WRAPPER .....	1
2		197 336 .....	LABEL, consumables ICE-12C .....	1
3		208 015 .....	HANDLE, rubberized carrying .....	1
4		196 851 .....	LABEL, warning precautionary plasma cutting .....	1
.....		184 791 .....	LABEL, HOBART .....	2
5	FM	195 610 .....	FAN .....	1
6	CR2	149 823 .....	RELAY .....	1
7	R1	182 486 .....	THERMISTOR .....	1
8		200 000 .....	DIODE ASSY .....	1
9	CR1	106 462 .....	RELAY .....	1
10	1T	202 056 .....	BLOCK, term 60A 3 pole .....	1
11	VR1,2,3	201 959 .....	VARISTOR, 430V 75 joule .....	3
12	C1,C2	197 739 .....	CAPACITOR, cer disc .....	2
13		230 563 .....	CASE SECTION, base/front/rear .....	1
14		115 104 .....	STRAIN RELIEF .....	1
15		194 480 .....	CABLE, power 10ft 16ga 3c .....	1
16		019 663 .....	FOOT, rubber .....	4
17	L1	196 364 .....	INDUCTOR .....	1
18	TP1	020 520 .....	THERMOSTAT .....	1
19		156 734 .....	NUT, 010-32 .31 hex .13H stl pld .....	8
20	AC1	207 999 .....	COMPRESSOR .....	1
.....		197 251 .....	FILTER, compressor .....	1
21		197 255 .....	RUBBER MOUNT .....	4
22		602 205 .....	WASHER, tooth .195 ID x .381 OD x .025T stl pld .....	4
23		216 277 .....	FTG, brs elbow qdisc 1/8 NPT X .250 TBG .....	1
24		216 276 .....	TUBING, copper coil heat exchanger .....	1
25		216 296 .....	CLAMP, cable 1/4 ID stl galv .....	1
26		216 280 .....	FTG, brs straight qdisc 1/4 OD X 1/4 OD tubing .....	1
27	PC1	214 585 .....	CIRCUIT CARD .....	1
28	TP2	197 892 .....	THERMOSTAT .....	1
29		138 044 .....	BUSHING, strain relief .....	1
30		121 276 .....	STRAIN RELIEF .....	1
31		195 172 .....	TORCH, ICE-12C .....	1
32		199 022 .....	CABLE, work 15ft 12ga w/clamp & term .....	1
.....		203 988 .....	CLAMP, work 150A .....	1
.....		199 995 .....	CONTACT TIP, work clamp .....	2
33	S1	111 997 .....	SWITCH, rocker SPST 10A 250VAC .....	1
34	T1	194 475 .....	TRANSFORMER, toroid main .....	1
35		211 007 .....	BAFFLE, center .....	1
.....		205 859 .....	NAMEPLATE .....	1

+When ordering a component originally displaying a precautionary label, the label should also be ordered.

**To maintain the factory original performance of your equipment, use only Manufacturer's Suggested Replacement Parts. Model and serial number required when ordering parts from your local distributor.**

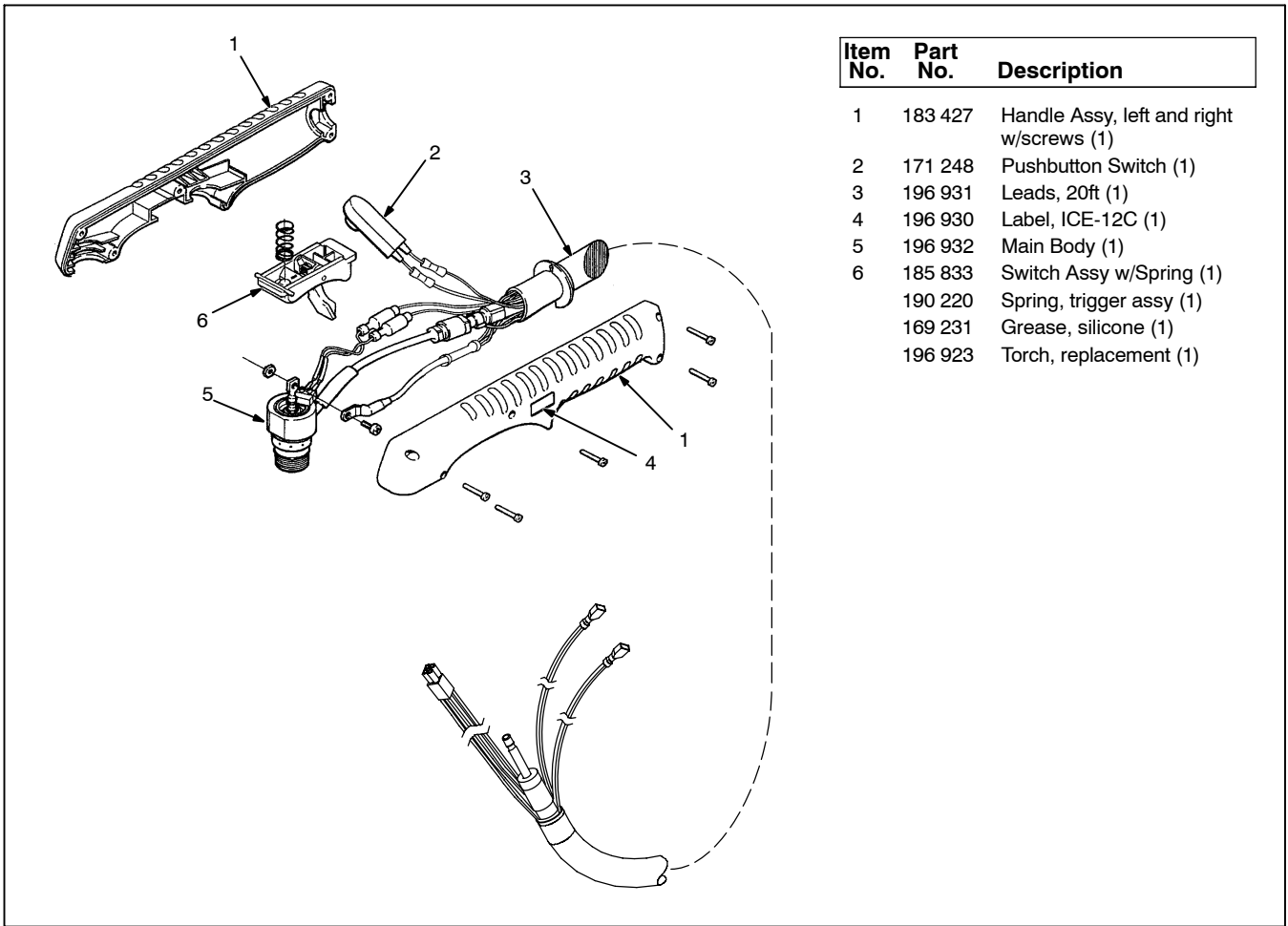

Figure 8-2. Torch, ICE-12C

and CE markings only apply when the torch is used with shielded parts: retaining cup (197 567) and drag shield (196 929).

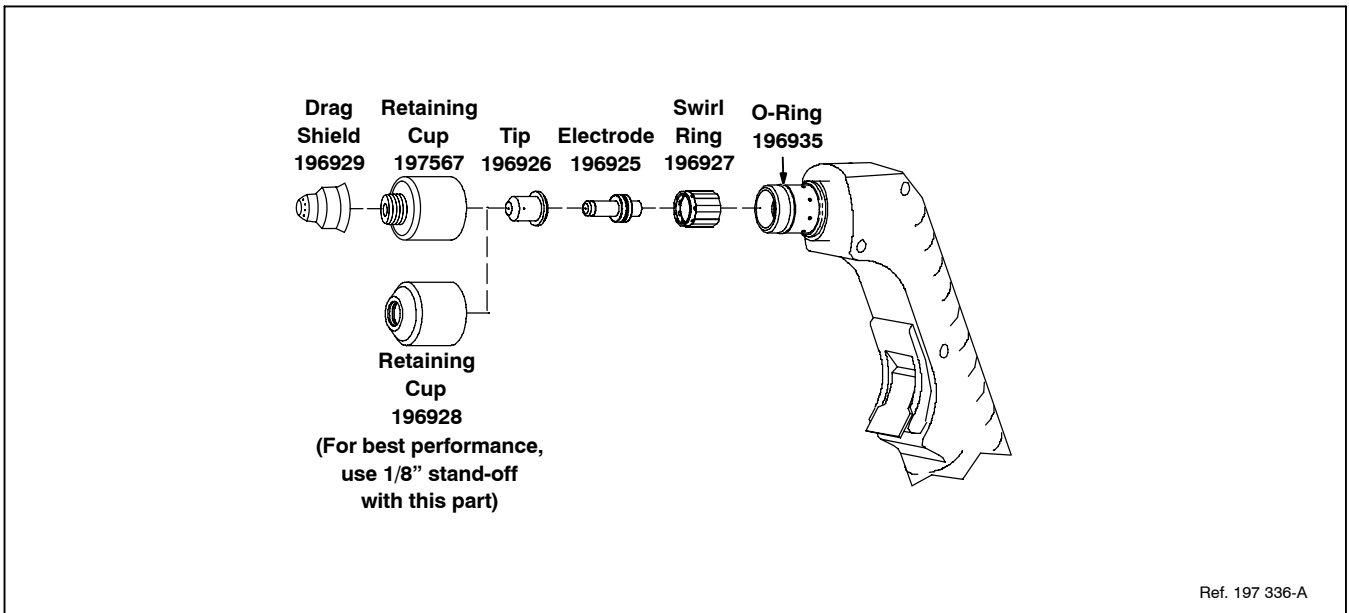

Figure 8-3. Consumable Parts For ICE-12C

To maintain the factory original performance of your equipment, use only Manufacturer's Suggested Replacement Parts. Model and serial number required when ordering parts from your local distributor.





# HOBART 5/3/1 WARRANTY

Effective January 1, 2006

## Warranty Questions?

Call  
1-800-332-3281  
7 AM – 6 PM EST

## Service

You always get the fast, reliable response you need. Most replacement parts can be in your hands in 24 hours.

## Support

Need fast answers to the tough welding questions? Contact your distributor or call 1-800-332-3281. The expertise of the distributor and Hobart is there to help you, every step of the way.

## Assistance

Visit the Hobart website:  
[www.HobartWelders.com](http://www.HobartWelders.com)

5/3/1 WARRANTY applies to all Hobart welding equipment, plasma cutters and spot welders with a serial number preface LG or newer.

This limited warranty supersedes all previous Hobart warranties and is exclusive with no other guarantees or warranties expressed or implied.

Hobart products are serviced by Hobart or Miller Authorized Service Agencies.

LIMITED WARRANTY – Subject to the terms and conditions below, Hobart/Miller Electric Mfg. Co., Appleton, Wisconsin, warrants to its original retail purchaser that new Hobart equipment sold after the effective date of this limited warranty is free of defects in material and workmanship at the time it is shipped by Hobart. THIS WARRANTY IS EXPRESSLY IN LIEU OF ALL OTHER WARRANTIES, EXPRESS OR IMPLIED, INCLUDING THE WARRANTIES OF MERCHANTABILITY AND FITNESS.

Within the warranty periods listed below, Hobart/Miller will repair or replace any warranted parts or components that fail due to such defects in material or workmanship. Hobart/Miller must be notified in writing within thirty (30) days of such defect or failure, at which time Hobart/Miller will provide instructions on the warranty claim procedures to be followed.

Hobart/Miller shall honor warranty claims on warranted equipment listed below in the event of such a failure within the warranty time periods. All warranty time periods start on the date that the equipment was delivered to the original retail purchaser, or one year after the equipment is sent to a North American distributor or eighteen months after the equipment is sent to an International distributor.

1. 5 Years — Parts and Labor
  - \* Original Main Power Rectifiers
  - \* Transformers
  - \* Stabilizers
  - \* Reactors
2. 3 Years — Parts and Labor
  - \* Drive Systems
  - \* PC Boards
  - \* Rotors, Stators and Brushes
  - \* Idle Module
  - \* Solenoid Valves
  - \* Switches and Controls
  - \* Spot Welder Transformer
3. 1 Year — Parts and Labor Unless Specified (90 days for industrial use)
  - \* Motor-Driven Guns
  - \* MIG Guns/TIG Torches
  - \* Relays
  - \* Contactors
  - \* Regulators
  - \* Water Coolant Systems
  - \* Flowgauge and Flowmeter Regulators (No Labor)
  - \* HF Units
  - \* Running Gear/Trailers
  - \* Plasma Cutting Torches
  - \* Remote Controls
  - \* Replacement Parts (No labor) – 90 days
  - \* Accessories
  - \* Field Options  
(NOTE: Field options are covered for the remaining warranty period of the product they are installed in, or for a minimum of one year — whichever is greater.)
4. Engines, batteries and tires are warranted separately by the manufacturer.

Hobart's 5/3/1 Limited Warranty shall not apply to:

1. **Consumable components such as contact tips, cutting nozzles, slip rings, drive rolls, gas diffusers, plasma torch tips and electrodes, weld cables, and tongs and tips, or parts that fail due to normal wear.** (Exception: brushes, slip rings, and relays are covered on Hobart Engine-Driven models.)
2. Items furnished by Hobart/Miller, but manufactured by others, such as engines or trade accessories. These items are covered by the manufacturer's warranty, if any.
3. Equipment that has been modified by any party other than Hobart/Miller, or equipment that has been improperly installed, improperly operated or misused based upon industry standards, or equipment which has not had reasonable and necessary maintenance, or equipment which has been used for operation outside of the specifications for the equipment.

HOBART PRODUCTS ARE INTENDED FOR PURCHASE AND USE BY COMMERCIAL/INDUSTRIAL USERS AND PERSONS TRAINED AND EXPERIENCED IN THE USE AND MAINTENANCE OF WELDING EQUIPMENT.

In the event of a warranty claim covered by this warranty, the exclusive remedies shall be, at Hobart's/Miller's option: (1) repair; or (2) replacement; or, where authorized in writing by Hobart/Miller in appropriate cases, (3) the reasonable cost of repair or replacement at an authorized Hobart/Miller service station; or (4) payment of or credit for the purchase price (less reasonable depreciation based upon actual use) upon return of the goods at customer's risk and expense. Hobart's/Miller's option of repair or replacement will be F.O.B., Factory at Appleton, Wisconsin, or F.O.B. at a Hobart/Miller authorized service facility as determined by Hobart/Miller. Therefore no compensation or reimbursement for transportation costs of any kind will be allowed.

TO THE EXTENT PERMITTED BY LAW, THE REMEDIES PROVIDED HEREIN ARE THE SOLE AND EXCLUSIVE REMEDIES. IN NO EVENT SHALL HOBART/MILLER BE LIABLE FOR DIRECT, INDIRECT, SPECIAL, INCIDENTAL OR CONSEQUENTIAL DAMAGES (INCLUDING LOSS OF PROFIT), WHETHER BASED ON CONTRACT, TORT OR ANY OTHER LEGAL THEORY.

ANY EXPRESS WARRANTY NOT PROVIDED HEREIN AND ANY IMPLIED WARRANTY, GUARANTY OR REPRESENTATION AS TO PERFORMANCE, AND ANY REMEDY FOR BREACH OF CONTRACT TORT OR ANY OTHER LEGAL THEORY WHICH, BUT FOR THIS PROVISION, MIGHT ARISE BY IMPLICATION, OPERATION OF LAW, CUSTOM OF TRADE OR COURSE OF DEALING, INCLUDING ANY IMPLIED WARRANTY OF MERCHANTABILITY OR FITNESS FOR PARTICULAR PURPOSE, WITH RESPECT TO ANY AND ALL EQUIPMENT FURNISHED BY HOBART/MILLER IS EXCLUDED AND DISCLAIMED BY Hobart/Miller.

Some states in the U.S.A. do not allow limitations of how long an implied warranty lasts, or the exclusion of incidental, indirect, special or consequential damages, so the above limitation or exclusion may not apply to you. This warranty provides specific legal rights, and other rights may be available, but may vary from state to state.

In Canada, legislation in some provinces provides for certain additional warranties or remedies other than as stated herein, and to the extent that they may not be waived, the limitations and exclusions set out above may not apply. This Limited Warranty provides specific legal rights, and other rights may be available, but may vary from province to province.





# Owner's Record

Please complete and retain with your personal records.

Model Name

Serial/Style Number

Purchase Date

(Date which equipment was delivered to original customer.)

Distributor

Address

City

State

Zip



# Resources Available

Always provide Model Name and Serial/Style Number.

## To locate a Distributor, retail or service location:

Call 1-877-Hobart1 or visit our website at [www.HobartWelders.com](http://www.HobartWelders.com)

## For technical assistance:

Call 1-800-332-3281

## Contact your Distributor for:

Welding Supplies and Consumables

Options and Accessories

Personal Safety Equipment

Service and Repair

Replacement Parts

Training (Schools, Videos, Books)

Technical Manuals (Servicing Information and Parts)

Circuit Diagrams

Welding Process Handbooks

## Contact the Delivering Carrier to:

File a claim for loss or damage during shipment.

For assistance in filing or settling claims, contact your distributor and/or equipment manufacturer's Transportation Department.

## Protect Your Investment!



Register your product at:  
[HobartWelders.com](http://HobartWelders.com)

## Hobart Welding Products

An Illinois Tool Works Company  
600 West Main Street  
Troy, OH 45373 USA

### For Technical Assistance:

Call 1-800-332-3281

For Literature Or Nearest Dealer:  
Call 1-877-Hobart1