

HITACHI

Model
Modèle
Modelo

CG 18DSDL

Cordless Grass Trimmer
Coupe bordure sans fil
Cortaseto a batería



Please contact HITACHI KOKI U.S.A. LTD.
at 1-800-59-TOOLS (toll free), or HITACHI
AUTHORIZED POWER TOOL SERVICE
CENTER regarding COLLECTION.



Pour le RAMASSAGE, contacter HITACHI
KOKI U.S.A. LTD. au 1-800-59-TOOLS (appel
gratuit), ou UN SERVICE APRES-VENTE
D'OUTILS ÉLECTRIQUE AGRÉÉ PAR
HITACHI.



Con respecto a la RECOLECCIÓN de
baterías, póngase en contacto con HITACHI
KOKI U.S.A. LTD. número 1-800-59-TOOLS
(llamada gratis), o con HITACHI AUTHORIZED
POWER TOOL SERVICE CENTER.

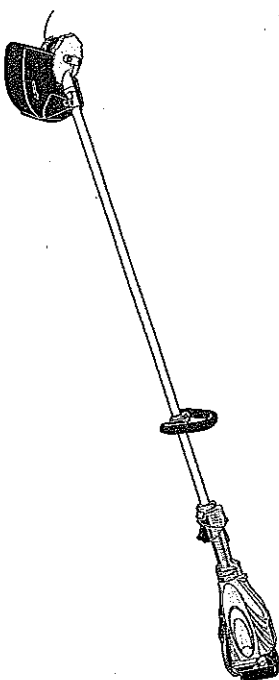

SAFETY INSTRUCTIONS AND INSTRUCTION MANUAL

⚠ WARNING

IMPROPER OR UNSAFE use of this gardening appliance can result in death or serious bodily injury!

This manual contains important information about product safety. Please read and understand this manual BEFORE operating the gardening appliance. Please keep this manual available for other users and owners before they use the gardening appliance. This manual should be stored in safe place.

INSTRUCTIONS DE SECURITE ET MODE D'EMPLOI

⚠ AVERTISSEMENT

Une utilisation **INCORRECTE OU DANGEREUSE** de cet appareil de jardinage peut entraîner la mort ou de sérieuses blessures corporelles !

Ce mode d'emploi contient d'importantes informations à propos de la sécurité de ce produit. Prière de lire et de comprendre ce mode d'emploi AVANT d'utiliser l'appareil de jardinage. Gardez ce mode d'emploi à la disposition des autres utilisateurs et propriétaires avant qu'ils utilisent l'appareil de jardinage. Ce mode d'emploi doit être conservé dans un endroit sûr.

INSTRUCCIONES DE SEGURIDAD Y MANUAL DE INSTRUCCIONES

⚠ ADVERTENCIA

!La utilización **INAPROPIADA O PELIGROSA** de esta herramienta para jardín puede resultar en lesiones de gravedad o la muerte!

Este manual contiene información importante sobre la seguridad del producto. Lea y comprenda este manual ANTES de utilizar la herramienta para jardín. Guarde este manual para que puedan leerlo otras personas antes de utilizar la herramienta para jardín. Este manual debe ser guardado en un lugar seguro.

Issued by

Hitachi Koki Co., Ltd.

Shinagawa Intercity Tower A, 15-1, Konan 2-chome,

Minato-ku, Tokyo 108-6020, Japan

Distributed by

Hitachi Koki U.S.A., Ltd.

3950 Steve Reynolds Blvd.

Norcross, GA 30093

Hitachi Koki Canada Co.

450 Export Blvd. Unit B,

Mississauga ON L5T 2A4

110

Code No. C99197161 G

Printed in China

Hitachi Koki

CONTENTS

English	Page	English	Page
IMPORTANT SAFETY INSTRUCTIONS	3	ASSEMBLY AND OPERATION	13
MEANINGS OF SIGNAL WORDS	3	APPLICATIONS	13
SAFETY	3	REMOVAL AND INSTALLATION METHOD OF BATTERY ..	13
GENERAL GARDENING APPLIANCE SAFETY		CHANGING METHOD	13
WARNINGS	3	ABOUT POWER LAMP	13
SPECIFIC SAFETY RULES AND SYMBOLS	3	ABOUT REMAINING BATTERY INDICATOR	15
PRECAUTIONS FOR CORDLESS GRASS TRIMMER ..	5	PRIOR TO OPERATION	15
IMPORTANT SAFETY INSTRUCTIONS FOR		NYLON HEAD	16
BATTERY CHARGER	6	OPERATION	19
BATTERY SAFETY INSTRUCTIONS		OPERATIONAL CAUTIONS	20
FOR USE OF THE BATTERY AND		MAINTENANCE AND INSPECTION	21
BATTERY CHARGER	7	ACCESSORIES	23
CAUTION ON LITHIUM-ION BATTERY	8	STANDARD ACCESSORIES	23
FUNCTIONAL DESCRIPTION	9	OPTIONAL ACCESSORIES	23
NAME OF PARTS	11	TROUBLESHOOTING	24
SPECIFICATIONS	12	PARTS LIST	76

TABLE DES MATIERES

Français	Page	Français	Page
CONSIGNES DE SÉCURITÉ IMPORTANTES	26	ASSEMBLAGE ET FONCTIONNEMENT	37
SIGNIFICATION DES MOTS D'AVERTISSEMENT	26	UTILISATIONS	37
SÉCURITÉ	26	MÉTHODE DE RETRAIT ET D'INSTALLATION	
AVERTISSEMENTS DE SÉCURITÉ GÉNÉRAUX		DE LA BATTERIE	37
CONCERNANT LES APPAREILS DE JARDINAGE ..	26	MÉTHODE DE RECHARGE	37
RÈGLES DE SÉCURITÉ SPÉCIFIQUES ET SYMBOLES ..	28	À PROPOS DU TÉMOIN D'ALIMENTATION	39
PRÉCAUTIONS RELATIVES À LA DÉBOUSSAILLEUSE ..	29	RESIDUELLE DE LA BATTERIE	39
CONSIGNES DE SÉCURITÉ IMPORTANTES POUR LE		AVANT D'UTILISER L'APPAREIL DE JARDINAGE	40
CHARGEUR DE BATTERIE	31	TÊTE DE FIL DE NYLON	41
CONSIGNES DE SÉCURITÉ IMPORTANTES		UTILISATION	43
POUR L'UTILISATION DE LA BATTERIE ET		PRÉCAUTIONS D'UTILISATION	44
DU CHARGEUR DE BATTERIE	32	ENTRETIEN ET INSPECTION	46
PRÉCAUTIONS RELATIVES À LA BATTERIE AU		ACCESOIRES	48
LITHIUM ION	33	ACCESOIRES STANDARD	48
DESCRIPTION FONCTIONNELLE	35	ACCESOIRES EN OPTION	48
NOM DES PARTES	35	DÉPANNAGE	49
SPECIFICATIONS	36	LISTE DES PIÈCES	76

ÍNDICE

Español	Página	Español	Página
INSTRUCCIONES IMPORTANTES SOBRE SEGURIDAD ..	51	MONTAJE Y OPERACIÓN	62
SIGNIFICADO DE LAS PALABRAS DE SEÑALIZACIÓN ..	51	APLICACIONES	62
SEGURIDAD	51	MÉTODO DE EXTRACCIÓN E INSTALACIÓN	
ADVERTENCIAS DE SEGURIDAD GENERAL DE LA		DE LA BATERIA	62
HERRAMIENTA PARA JARDIN	51	MÉTODO DE CARGA	62
NORMAS Y SÍMBOLOS ESPECÍFICOS DE SEGURIDAD ..	53	AGENCIA DE LA LÁMPARA INDICADORA DE	
PRECAUCIONES DE LA SEGADORA DE CÉSPED		FUNCIONAMIENTO	64
AUTOALIMENTADA	54	AGENCIA DEL INDICADOR DE BATERIA RESTANTE ..	64
INSTRUCCIONES IMPORTANTES DE SEGURIDAD		ANTES DE LA OPERACIÓN	65
PARA EL CARGADOR DE BATERÍAS	56	CABEZAL DE NYLON	66
INSTRUCCIONES IMPORTANTES DE SEGURIDAD PARA		OPERACIÓN	68
LA BATERÍA Y EL CARGADOR DE BATERÍAS	57	PRECAUCIONES DE OPERACIÓN	69
ADVERTENCIA DE LA BATERÍA DE LITIO	58	MAINTENIMIENTO E INSPECCIÓN	71
DESCRIPCIÓN FUNCIONAL	60	ACCESORIOS	73
NOMENCLATURA	60	ACCESORIOS ESTÁNDAR	73
ESPECIFICACIONES	61	ACCESORIOS OPCIONALES	73
		SOLUCIÓN DE PROBLEMAS	74
		LISTA DE PIEZAS	76

IMPORTANT SAFETY INSTRUCTIONS

Read and understand all of the safety precautions, warnings and operating instructions in the Instruction Manual before operating or maintaining this gardening appliance.

Most accidents that result from gardening appliance operation and maintenance are caused by the failure to observe basic safety rules or precautions. An accident can often be avoided by recognizing a potentially hazardous situation before it occurs, and by observing appropriate safety procedures.

Basic safety precautions are outlined in the "SAFETY" section of this Instruction Manual and in the sections which contain the operation and maintenance instructions.

Hazards that must be avoided to prevent bodily injury or machine damage are identified by WARNINGS on the gardening appliance and in this Instruction Manual.

NEVER use this gardening appliance in a manner that has not been specifically recommended by HITACHI.

MEANINGS OF SIGNAL WORDS

WARNING indicates a potentially hazardous situations which, if ignored, could result in death or serious injury.

CAUTION indicates a potentially hazardous situations which, if not avoided, may result in minor or moderate injury, or may cause machine damage.

NOTE emphasizes essential information.

SAFETY

GENERAL GARDENING APPLIANCE SAFETY WARNINGS

▲ WARNING:

When using electric gardening appliances, basic safety precautions should always be followed to reduce the risk of fire, electric shock, and personal injury, including the following:

Read all safety warnings and all instructions.

Failure to follow the warnings and instructions may result in electric shock, fire and/or serious injury.

Save all warnings and instructions for future reference.

The term "gardening appliance" in the warnings refers to your mains-operated (corded) gardening appliance or battery-operated (cordless) gardening appliance.

- 1) Work area safety
 - a) Keep work area clean and well lit. Cluttered or dark areas invite accidents.
 - b) Do not operate gardening appliances in explosive atmospheres, such as in the presence of flammable liquids, gases or dust. Gardening appliances create sparks which may ignite the dust or fumes.
 - c) Keep children and bystanders away while operating a gardening appliance. Distractions can cause you to lose control.
 - d) Electrical safety
 - a) Gardening appliance plugs must match the outlet.
 - b) Never modify the plug in any way. Do not use any adapter plugs with earthed (grounded) gardening appliances. Unmodified plugs and matching outlets will reduce risk of electric shock.
 - c) Avoid body contact with earthed or grounded surfaces such as pipes, radiators, ranges and refrigerators. There is an increased risk of electric shock if your body is earthed or grounded.
 - d) Do not expose gardening appliances to rain or wet conditions. Water entering a gardening appliance will increase the risk of electric shock.
 - e) Do not abuse the cord. Never use the cord for carrying, pulling or unplugging the gardening appliance. Keep cord away from heat, oil, sharp edges or moving parts. Damaged or entangled cords increase the risk of electric shock.
 - f) When operating a gardening appliance outdoors, use an extension cord suitable for outdoor use. Use of a cord suitable for outdoor use reduces the risk of electric shock.
- 2) Electrical safety
 - a) Gardening appliance plugs must match the outlet.
 - b) Never modify the plug in any way. Do not use any adapter plugs with earthed (grounded) gardening appliances. Unmodified plugs and matching outlets will reduce risk of electric shock.
 - c) Avoid body contact with earthed or grounded surfaces such as pipes, radiators, ranges and refrigerators. There is an increased risk of electric shock if your body is earthed or grounded.
 - d) Do not expose gardening appliances to rain or wet conditions. Water entering a gardening appliance will increase the risk of electric shock.
 - e) Do not abuse the cord. Never use the cord for carrying, pulling or unplugging the gardening appliance. Keep cord away from heat, oil, sharp edges or moving parts. Damaged or entangled cords increase the risk of electric shock.
 - f) When operating a gardening appliance outdoors, use an extension cord suitable for outdoor use. Use of a cord suitable for outdoor use reduces the risk of electric shock.

- f) If operating a gardening appliance in a damp location is unavoidable, use a residual current device (RCD) protected supply. Use of an RCD reduces the risk of electric shock.
- 3) Personal safety
- a) Stay alert, watch what you are doing and use common sense when operating a gardening appliance.
- Do not use a gardening appliance while you are tired or under the influence of drugs, alcohol or medication.
- A moment of inattention while operating gardening appliances may result in serious personal injury.
- b) Use personal protective equipment. Always wear eye protection.
- Protective equipment such as dust mask, non-skid safety shoes, hard hat, or hearing protection used for appropriate conditions will reduce personal injuries.
- c) Prevent unintentional starting. Ensure the switch is in the off-position before connecting to power source and/or battery pack, plugging up or carrying the gardening appliance.
- Carrying gardening appliances with your finger on the switch or energising gardening appliances that have the switch on invites accidents.
- d) Remove any adjusting key or wrench before turning the gardening appliance on.
- A wrench or a key, left attached to a rotating part of the gardening appliance may result in personal injury.
- e) Do not overreach. Keep proper footing and balance at all times.
- This enables better control of the gardening appliance in unexpected situations.
- f) Dress properly. Do not wear loose clothing or jewellery. Keep your hair, clothing and gloves away from moving parts.
- Loose clothes, jewellery or long hair can be caught in moving parts.
- g) If devices are provided for the connection of dust extraction and collection facilities, ensure these are connected and properly used.
- Use of dust collection can reduce dust-related hazards.
- 4) Gardening appliance use and care
- a) Do not force the gardening appliance. Use the correct gardening appliance for your application.
- The correct gardening appliance will do the job better and safer at the rate for which it was designed.
- b) Do not use the gardening appliance if the switch does not turn it on and off.
- Any gardening appliance that cannot be controlled with the switch is dangerous and must be repaired.
- 4
- c) Disconnect the plug from the power source and/or the battery pack from the gardening appliance before making any adjustments, changing accessories, or storing gardening appliances.
- Such preventive safety measures reduce the risk of starting the gardening appliance accidentally.
- d) Store idle gardening appliances out of the reach of children and do not allow persons unfamiliar with the gardening appliance or these instructions to operate the gardening appliance.
- Gardening appliances are dangerous in the hands of untrained users.
- e) Maintain gardening appliances. Check for misalignment or binding of moving parts, breakage of parts and any other condition that may affect the gardening appliance's operation.
- If damaged, have the gardening appliance repaired before use.
- Many accidents are caused by poorly maintained gardening appliances.
- f) Keep cutting tools sharp and clean.
- Properly maintained cutting tools with sharp cutting edges are less likely to bind and are easier to control.
- g) Use the gardening appliance, accessories and tool bits etc. in accordance with these instructions, taking into account the working conditions and the work to be performed.
- Use of the gardening appliance for operations different from those intended could result in a hazardous situation.
- 5) Battery gardening appliance use and care
- a) Recharge only with the charger specified by the manufacturer.
- A charger that is suitable for one type of battery pack may create a risk of fire when used with another battery pack.
- b) Use gardening appliances only with specifically designated battery packs.
- Use of any other battery packs may create a risk of injury and fire.
- c) When battery packs are not in use, keep it away from other metal objects like paper clips, coins, keys, nails, screws, or other small metal objects, that can make a connection from one terminal to another.
- Shorting the battery terminals together may cause burns or a fire.
- d) Under abusive conditions, liquid may be ejected from the battery; avoid contact. If contact accidentally occurs, flush with water. If liquid contacts eyes, additionally seek medical help.
- Liquid ejected from the battery may cause irritation or burns.

- 6) Service
- a) Have your gardening appliance serviced by a qualified repair person using only identical replacement parts.
- This will ensure that the safety of the gardening appliance is maintained.

WARNING:

Some dust created by power sanding, sawing, grinding, drilling, and other construction activities contains chemicals known (to the State of California) to cause cancer, birth defects or other reproductive harm. Some examples of these chemicals are:

- Lead from lead-based paints,
- Crystalline silica from bricks and cement and other masonry products, and
- Arsenic and chromium from chemically-treated lumber.

Your risk from these exposures varies, depending on how often you do this type of work. To reduce your exposure to these chemicals: work in a well ventilated area, and work with approved safety equipment, such as those dust masks that are specially designed to filter out microscopic particles.

SPECIFIC SAFETY RULES AND SYMBOLS

- Hold gardening appliances by insulated gripping surfaces when performing an operation where the cutting tool may contact hidden wiring or its own cord.
- Contact with a "live" wire will make exposed metal parts of the gardening appliance "live" and shock the operator.
- ALWAYS** wear ear protectors when using the gardening appliance for extended periods.
- Prolonged exposure to high intensity noise can cause hearing loss.
- NEVER** place hands or other body parts near the moving parts during operation. Hold the grass trimmer by its handle only.
- Because the cordless grass trimmer operates by battery power, be aware of the fact that it can begin to operate at any time.
- When working at elevated locations, clear the area of all other people and be aware of conditions below you.
- NEVER** touch moving parts.
- NEVER** place your hands, fingers or other body parts near the gardening appliance's moving parts.
- NEVER** operate without all guards in place.
- NEVER** operate this gardening appliance without all guards or safety features in place and in proper working order. If maintenance or servicing requires the removal of a guard or safety feature, be sure to replace the guard or safety feature before resuming operation of the gardening appliance.
- Use right gardening appliance.
- Don't force small gardening appliance or attachment to do the job of a heavy-duty gardening appliance.
- Don't use gardening appliance for purpose not intended — for example — don't use circular saw for cutting tree limbs or logs.
- NEVER** use a gardening appliance for applications other than those specified.
- NEVER** use a gardening appliance for applications other than those specified in the Instruction Manual.
- Handle gardening appliance correctly.
- Operate the gardening appliance according to the instructions provided herein. Do not drop or throw the gardening appliance. **NEVER** allow the gardening appliance to be operated by children, individuals unfamiliar with its operation or unauthorized personnel.
- Keep all screws, bolts and covers tightly in place. Keep all screws, bolts, and plates tightly mounted. Check their condition periodically.
- Do not use gardening appliances if the plastic housing or handle is cracked.
- Cracks in the gardening appliance's housing or handle can lead to electric shock. Such gardening appliances should not be used until repaired.
- Accessories must be securely mounted to the gardening appliance.
- Prevent potential injuries to yourself or others. Cutting implements and accessories which have been mounted to the gardening appliance should be secure and tight.
- NEVER** use a gardening appliance which is defective or operating abnormally.
- If the gardening appliance appears to be operating unusually, making strange noises, or otherwise appears defective, stop using it immediately and arrange for repairs by a Hitachi authorized service center.
- Carefully handle gardening appliances.
- Should a gardening appliance be dropped or struck against hard materials inadvertently, it may be deformed, cracked, or damaged.
- Do not wipe plastic parts with solvent.
- Solvents such as gasoline, thinner, benzene, carbon tetrachloride and alcohol may damage and crack plastic parts. Do not wipe them with such solvents.
- Wipe plastic parts with a soft cloth lightly dampened with soapy water and dry thoroughly.
- ALWAYS** wear eye protection that meets the requirement of the latest revision of ANSI Standard Z87.1.



- 18. This product contains a strong permanent magnet in the motor. Observe the following precautions regarding adhering of chips to the gardening appliance and the effect of the permanent magnet on electronic devices.

CAUTION:

- ① Do not place the gardening appliance on a workbench or work area where metal chips are present. The chips may adhere to the gardening appliance, resulting in injury or malfunction, if chips have adhered to the gardening appliance, do not touch it. Remove the chips with a brush.
- ② Failure to do so may result in injury.
- ③ If you use a pacemaker or other electronic medical device, do not operate or approach the gardening appliance.

- ④ Operation of the electronic device may be affected. Do not use the gardening appliance in the vicinity of precision devices such as cell phones, magnetic cards or electronic memory media. Doing so may lead to misoperation, malfunction or loss of data.

- 19. Definitions for symbols used on this gardening appliance
 V volts
 ~ direct current
 No no load speed
 —/min revolutions or reciprocation per minute

PRECAUTIONS FOR CORDLESS GRASS TRIMMER

- 1. **WARNING:** Avoid Dangerous Environment – Don't use appliances in damp or wet locations.
- 2. **Don't Use in Rain.**
- 3. **Keep Children Away** – All visitors should be kept at a distance from work area.
- 4. **Dress Properly** – Do not wear loose clothing or jewelry. They can be caught in moving parts. Use of rubber gloves and substantial footwear is recommended when working outdoors. Wear protective hair covering to contain long hair.
- 5. **Use Safety Glasses** – Always use face or dust-mask if operation is dusty.
- 6. **Use Right Appliance** – Do not use appliance for any job except that for which it is intended.
- 7. **Avoid Unintentional Starting** – Don't carry plugged-in appliance with finger on switch. Be sure switch is off when plugging in.
- 8. **Don't Force Appliance** – It will do the job better and with less likelihood of a risk of injury at the rate for which it was designed.

- 9. **Don't Overreach** – Keep proper footing and balance at all times.
- 10. **Stay Alert** – Watch what you are doing. Use common sense. Do not operate appliance when you are tired.
- 11. **Store Idle Appliances Indoors** – When not in use, appliances should be stored indoors in dry, and high or locked-up place – out of reach of children.
- 12. **Maintain Appliance With Care** – Keep cutting edge sharp and clean for best performance and to reduce the risk of injury. Follow instructions for lubricating and changing accessories. Inspect appliance cord periodically, and if damaged, have it repaired by an authorized service facility. Inspect extension cords periodically and replace if damaged. Keep handles dry, clean, and free from oil and grease.

- 13. **Cheek Damaged Parts** – Before further use of the appliance, a guard or other part that is damaged should be carefully checked to determine that it will operate properly and perform its intended function. Check for alignment of moving parts, binding of moving parts, breakage of parts, mounting, and any other condition that may affect its operation. A guard or other part that is damaged should be properly repaired or replaced by an authorized service center unless indicated elsewhere in this manual.
- 14. **Do not charge appliance in rain, or in wet locations.**
- 15. **Do not use battery-operated appliance in rain.**
- 16. **Remove or disconnect battery before servicing, cleaning or removing material from the gardening appliance.**

- 17. **Use only the following type and size battery(ies):**BSL1830
- 18. **Do not dispose of the battery(ies) in a fire.** The cell may explode. Check with local codes for possible special disposal instructions.
- 19. **Do not open or mutilate the battery(ies).** Released electrolyte is corrosive and may cause damage to the eyes or skin. It may be toxic if swallowed.
- 20. **Exercise care in handling batteries in order not to short the battery with conducting materials such as rings, bracelets, and keys.** The battery or conductor may overheat and cause burns.
- 21. **Exercise patience in all work with the gardening appliance. And dress properly to keep warm.**
- 22. **Plan all work ahead to prevent accidents.**
- 23. **Do not operate the gardening appliance at night or under bad weather conditions when visibility is poor. And do not operate the gardening appliance when it is raining or right after it has been raining.** Working on slippery ground could lead to an accident if you lose your balance.

- 24. **Inspect the nylon head before starting work.** Do not use the gardening appliance if the nylon head is cracked, scarred or bent. Make sure the nylon head is properly attached. A nylon head that falls apart, or comes loose during operation could cause an accident.
- 25. **Be sure to attach the cover before starting work.** Operating the gardening appliance without this parts could lead to injury.
- 26. **Be sure to attach the loop handle before starting work. Make sure it is not loose but properly attached before starting work. Hold the loop handle firmly during work and do not swing the gardening appliance around, but use the correct posture and maintain your balance.** Losing your balance during work could lead to an injury.

- 27. **Take care when starting the motor.** Place the gardening appliance on level ground. Do operate the gardening appliance within 50ft. (15 m) of people or animals. Make sure that the nylon head does not come into contact with the ground or trees and plants. A careless start could lead to injury.
- 28. **Do not secure the lock lever.** Accidentally pulling back the lever could lead to unexpected injury.
- 29. **Before leaving the gardening appliance, press the power button to turn it off.**
- 30. **Operate the gardening appliance with care near electric cables, gas pipes and similar installations. Look out for and remove empty cans, wire, stones or other obstacles before starting work. And do not work near tree roots or rocks.** Working in such areas could damage the nylon head or lead to injury.
- 31. **Never touch the nylon head during operation.** Also make sure it does not come into contact with your hair, clothes, etc.
- 32. **In the following situations, turn off the motor and check that the nylon head has stopped rotating.** To move to another work area.
- 33. **To remove rubbish or grass that has become stuck in the gardening appliance.** To remove from the work area obstacles or the rubbish, grass and chips generated by trimming. To lay down the gardening appliance. Doing this with the nylon head still rotating could lead to unexpected accidents.
- 34. **Do not use the gardening appliance within 50ft. (15 m) of another person.** When you work with someone else, maintain a distance of more than 50ft. (15 m). Flying chips could lead to unexpected accidents. When working on unstable surfaces like slopes, make sure that your co-worker is not exposed to any hazards. Use whistles or other means for calling the attention of your co-workers.

- 35. **When grass and other objects become entangled in the nylon head, turn off the motor and make sure the nylon head has stopped rotating before removing them.** Removing objects from the nylon head when it is still rotating will lead to injury. Continuing operation when foreign matter is stuck in the nylon head may lead to damage. If the gardening appliance is operating poorly and produces strange noise or vibrations, turn off the motor immediately and ask your dealer to have it inspected and repaired. Continued use under these conditions could lead to injury or gardening appliance damage. If you drop or bump the gardening appliance, inspect it carefully to check there is no damage, cracks or deformation.

- 37. **Using a gardening appliance that is damaged, cracked or deformed could result in injury.** Secure the gardening appliance during vehicle transport to ensure that it lies still. Failure to heed this warning may result in an accident.

- 38. **CAUTION**
 1. **Do not turn on the nylon head for cutting objects other than grass.** Do not operate the gardening appliance in water puddles and make sure that soil does not come into contact with the nylon head.
- 2. **The gardening appliance contains precision parts and should not be dropped, exposed to strong impact or water.** The gardening appliance could be damaged or malfunction.
- 3. **When the gardening appliance is to be stored after use or be transported, remove the nylon head. Do not expose the gardening appliance to insecticide and other chemicals.** Such chemicals could cause cracking and other damage.
- 4. **Replace warning labels with new labels when they become difficult to recognize or illegible and when they start to peel.** Ask your dealer to provide the warning labels. Do not touch the motor immediately after use since it may be very hot.

IMPORTANT SAFETY INSTRUCTIONS FOR BATTERY CHARGER

- 1. **WARNING:** Death or serious bodily injury could result from improper or unsafe use of battery chargers. To avoid these risks, follow these basic safety instructions:

READ ALL INSTRUCTIONS

1. This manual contains important safety and operating instructions for battery charger Model UC18YGSL.
2. Before using battery charger, read all instructions and cautionary markings on (1) battery charger, (2) battery, and (3) product using battery.
3. To reduce risk of injury, charge HITACHI rechargeable battery type: for UC18YGSL---BSL1830. Other type of batteries may burst causing personal injury and damage.
4. Do not expose battery charger to rain or snow.
5. Use of an attachment not recommended or sold by the battery charger manufacturer may result in a risk of fire, electric shock, or injury to persons.

Table 1
RECOMMENDED MINIMUM AWG SIZE FOR
EXTENSION CORDS FOR BATTERY CHARGERS

AC Input Rating Amperes*	but less than	Length of Cord, Feet (Meter)	100 (30)	150 (45)
Equal to or greater than	than	25 (7.5)	50 (15)	100 (30)
0	2	18	18	16
2	3	18	18	16
3	4	18	18	16
			16	14

* If the input rating of a battery charger is given in watts rather than in amperes, the corresponding ampere rating is to be determined by dividing the wattage rating by the voltage rating—for example:
 $\frac{1,250 \text{ watts}}{125 \text{ volts}} = 10 \text{ amperes}$

9. Do not operate battery charger with damaged cord or plug—replace them immediately.
10. Do not operate battery charger if it has received a sharp blow, been dropped, or otherwise damaged in any way; take it to a qualified serviceman.
11. Do not disassemble battery charger; take it to a qualified serviceman when service or repair is required. Incorrect reassembly may result in a risk of electric shock or fire.
12. To reduce risk of electric shock, unplug charger from receptacle before attempting any maintenance or cleaning. Removing the battery will not reduce this risk.

6. To reduce risk of damage to electric plug and cord, pull by plug when disconnecting battery charger.
7. Make sure cord is located so that it will not be stepped on, tripped over, or otherwise subjected to damage or stress.
8. An extension cord should not be used unless absolutely necessary. Use of improper extension cord could result in a risk of fire and electric shock. If extension cord must be used make sure:
 - a. That blades of extension cord are the same number, size, and shape as those of plug on battery charger;
 - b. That extension cord is properly wired and in good electrical condition; and
 - c. That wire size is large enough for AC ampere rating of battery charger as specified in Table 1.

IMPORTANT SAFETY INSTRUCTIONS FOR USE OF THE BATTERY AND BATTERY CHARGER

You must charge the battery before you can use the gardening appliance. Before using the model UC18YGSL battery charger, be sure to read all instructions and cautionary statements on it, the battery and in this manual.

REMEMBER: USE ONLY HITACHI BATTERY TYPES: FOR UC18YGSL---BSL1830. OTHER TYPES OF BATTERIES MAY BURST AND CAUSE INJURY!

Follow these instructions to avoid the risk of injury:

- ⚠ **WARNING:**
Improper use of the battery or battery charger can lead to serious injury. To avoid these injuries:
1. NEVER disassemble the battery.
 2. NEVER incinerate the battery, even if it is damaged or is completely worn out. The battery can explode in a fire.
 3. NEVER short-circuit the battery.

4. NEVER insert any objects into the battery charger's air vents. Electric shock or damage to the battery charger may result.
5. NEVER charge outdoors. Keep the battery away from direct sunlight and use only where there is low humidity and good ventilation.
6. NEVER charge when the temperature is below 32°F (0°C) or above 104°F (40°C).
7. NEVER connect two battery chargers together.
8. NEVER insert foreign objects into the hole for the battery or the battery charger.
9. NEVER use a booster transformer when charging.
10. NEVER use an engine generator or DC power to charge.
11. NEVER store the battery or battery charger in places where the temperature may reach or exceed 104°F (40°C).
12. ALWAYS operate charger on standard household electrical power (120 volts). Using the charger on any other voltage may overheat and damage the charger.
13. ALWAYS wait at least 15 minutes between charges to avoid overheating the charger.
14. ALWAYS disconnect the power cord from its receptacle when the charger is not in use.

CAUTION ON LITHIUM-ION BATTERY

To extend the lifetime, the lithium-ion battery equips with the protection function to stop the output.

In the cases of 1 to 3 described below, when using this product, even if you are pulling the switch, the motor may stop. This is not the trouble but the result of protection function.

1. When the battery power remaining runs out, the motor stops.
2. In such case, charge it up immediately. If the gardening appliance is overloaded, the motor may stop. In this case, release the switch of gardening appliance and eliminate causes of overloading. After that, you can use it again.
3. If the battery is overheated under overload work, the battery power may stop. In this case, stop using the battery and let the battery cool. After that, you can use it again. Furthermore, please heed the following warning and caution.

- ⚠ **WARNING**
In order to prevent any battery leakage, heat generation, smoke emission, explosion and ignition beforehand, please be sure to heed the following precautions.
1. Make sure that swarf and dust do not collect on the battery.
 2. During work make sure that swarf and dust do not fall on the battery.
 3. Make sure that any swarf and dust falling on the gardening appliance during work do not collect on the battery.

1. Do not store an unused battery in a location exposed to swarf and dust.
2. Before storing a battery, remove any swarf and dust that may adhere to it and do not store it together with metal parts (screws, nails, etc.).
3. Do not pierce battery with a sharp object such as a nail, strike with a hammer, step on, throw or subject the battery to severe physical shock.
4. Do not use an apparently damaged or deformed battery.
5. Do not use the battery in reverse polarity.
6. Do not connect directly to an electrical outlets or car cigarette lighter sockets.
7. Do not use the battery for a purpose other than those specified.
8. If the battery charging fails to complete even when a specified recharging time has elapsed, immediately stop further recharging.
9. Do not put or subject the battery to high temperatures or high pressure such as into a microwave oven, dryer, or high pressure container. Keep away from fire immediately when leakage or foul odor are detected.
10. Do not use in a location where strong static electricity generates.
11. If there is battery leakage, foul odor, heat generated, discolored or deformed, or in any way appears abnormal during use, recharging or storage, immediately remove it from the equipment or battery charger, and stop use.

CAUTION

If liquid leaking from the battery gets into your eyes, do not rub your eyes and wash them well with fresh clean water such as tap water and contact a doctor immediately.

If left untreated, the liquid may cause eye-problems.

If liquid leaks onto your skin or clothes, wash well with clean water such as tap water immediately. There is a possibility that this can cause skin irritation.

If you find rust, foul odor, overheating, discolor, deformation, and/or other irregularities when using the battery for the first time, do not use and return it to your supplier or vendor.

- ⚠ **WARNING:**
If an electrically conductive foreign object enters the terminals of the lithium ion battery, a short-circuit may occur resulting in the risk of fire. Please observe the following matters when storing the battery.
1. Do not place electrically conductive cuttings, nails, steel wire, copper wire or other wire in the storage case.
 2. Install the battery in the gardening appliance until the ventilation holes shown in Fig. 1 are concealed to prevent short-circuits.

**SAVE THESE INSTRUCTIONS
AND
MAKETHEM AVAILABLE TO OTHER USERS
AND
OWNERS OF THIS GARDENING APPLIANCE!**

FUNCTIONAL DESCRIPTION

NOTE:
The information contained in this Instruction Manual is designed to assist you in the safe operation and maintenance of the gardening appliance.
NEVER operate, or attempt any maintenance on the gardening appliance unless you have first read and understood all safety instructions contained in this manual.
Some illustrations in this Instruction Manual may show details or attachments that differ from those on your own gardening appliance.

NAME OF PARTS

1. Cordless grass trimmer

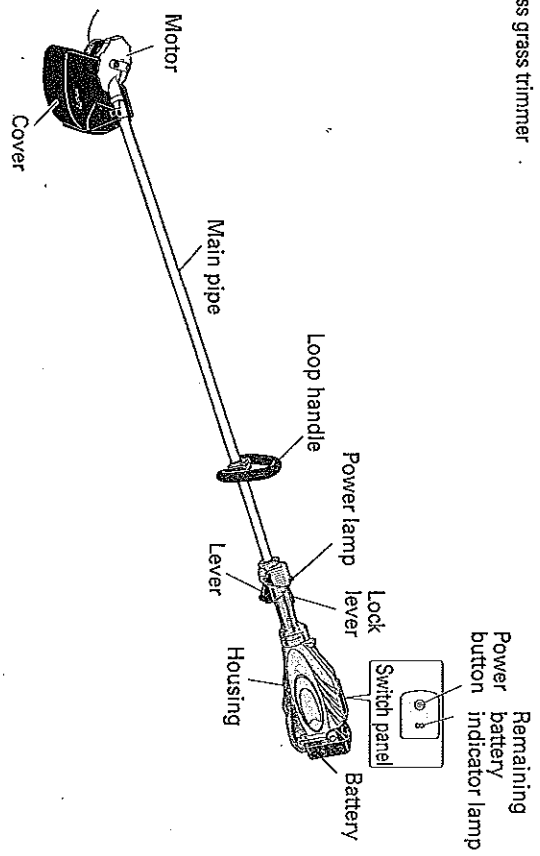

○ Battery (BSL1830)

2. Battery Charger (UC18YGSL)

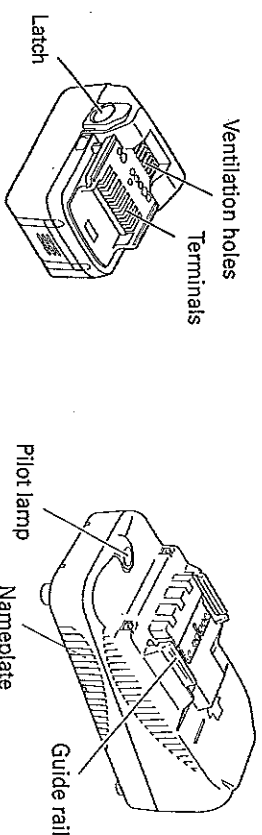

Fig. 1

Fig. 2

SPECIFICATIONS

1. Cordless Grass Trimmer

Model	CG18DSDL	
Pole type	Straight type	
Cutting capacity diameter	12" (310 mm)	
Rotation direction	Counterclockwise as seen from above	
No-load speed	5,000/min	
Motor	Disc Motor	
Operating time on one charge *1 (When supplied rechargeable battery is fully charged)	18 - 22 min *2	
Handle type	Loop handle	
Total length x total width x full height	65-3/4" x 12-19/32" x 9-27/32" (1,670 mm x 320 mm x 250 mm) (with type BSL1830 inserted)	
Battery	Model	BSL1830
	Type	Li-ion battery
Weight (with nylon head, type BSL1830 battery and cover)	Voltage	DC 18 V
		9.5 lbs. (4.3 kg)

*1 The data in the above table is provided only as an example. Since type of grass, ambient temperature, rechargeable battery characteristics, work methods, etc. can vary widely the above should only be used as a rough guideline.

*2 Conditions: Outer diameter of nylon head 12" (310 mm), switch set to full speed. (switch left ON all the time)

2. Battery Charger

Model	UC18YGSL
Input power source	Single phase: AC 120 V 60 Hz
Charging time (At a temperature of 68°F (20°C))	Approx. 90 min BSL1830
Charging voltage	DC 14.4 - 18 V
Charging current	DC 2.0 A
Weight	0.9 lbs. (0.4 kg)

ASSEMBLY AND OPERATION**APPLICATIONS**

Trimming, scaling and mowing of weed.

REMOVAL AND INSTALLATION METHOD OF BATTERY

1. Battery removal
Hold the housing tightly and push the battery latch to remove the battery. (See Fig. 3).

CAUTION
Never short-circuit the battery.

2. Battery installation
Insert the battery while observing its polarities (see Fig. 3).

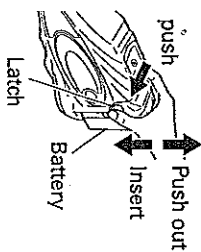

Fig. 3

CHARGING METHOD**NOTE:**

Before plugging into the receptacle, make sure the following points.

- The power source voltage is stated on the nameplate.
- The cord is not damaged.

WARNING:

Do not charge at voltage higher than indicated on the nameplate.
If charged at voltage higher than indicated on the nameplate, the charger will burn out.

ASSEMBLY AND OPERATION

1. Insert the plug of battery charger into the receptacle.
When the plug of battery charger has been inserted into the receptacle, pilot lamp will blink in red. (At 1-second intervals)



WARNING:
Do not use the electrical cord if damaged. Have it repaired immediately.

2. Insert the battery to the battery charger.
Insert the battery into the battery charger as shown in Fig. 4. Make sure it contacts the bottom of the battery charger.

BSL1830

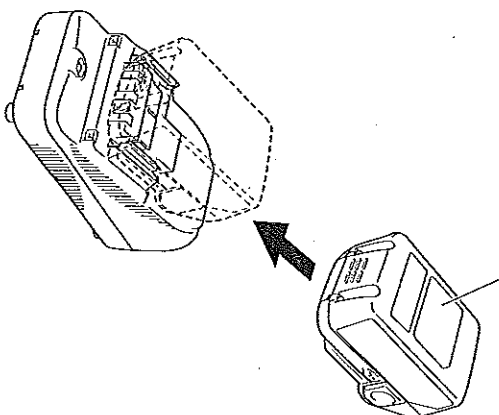

Fig. 4

- 3. Charging
 - When the battery is inserted into the battery charger, charging will commence and the pilot lamp will light in red. (See Table 2)

NOTE:
If the pilot lamp does not light or blink in red, pull out the plug from the receptacle and check if the battery is properly mounted.

- When the battery is fully charged, the pilot lamp will blink in red slowly. (At 1-second intervals) (See Table 2)

Table 2

Pilot lamp (red)	Indications of the pilot lamp		Battery overheated. Unable to charge. (Charging will commence when battery cools)
	Before charging	While charging	
Charging complete	Blinks for 0.5 seconds. (off for 0.5 seconds)	Blinks for 0.5 seconds. (off for 0.5 seconds)	Battery malfunction in the battery or the charger
Overheat standby	Blinks for 1 second. (off for 0.5 seconds)	Does not light	
Charging impossible	Flickers for 0.1 seconds. (off for 0.1 seconds)	Does not light	

- Regarding the temperature of the rechargeable battery.
 - △ The temperatures for rechargeable batteries are as shown in the Table 3, and batteries that have become hot should be cooled for a while before being recharged.

Table 3 Recharging ranges of batteries

Rechargeable batteries	Temperatures at which the battery can be recharged
BSL1830	32°F - 122°F (0°C - 50°C)

- Regarding recharging time
 - △ Table 4 shows the recharging time required according to the type of battery.

Table 4 Recharging time (approx. min.) at 20°C

Battery Voltage (V)	Battery capacity (Ah)	
	Li-ion BATTERY	
18V	BSL1830	90 min.

NOTE:
The recharging time may vary according to the ambient temperature.

- 4. Disconnect battery charger from the receptacle.
 - △ **CAUTION**
Do not pull the plug out of the receptacle by pulling on the cord.
Make sure to grasp the plug when removing from receptacle to avoid damaging cord.
- 5. Hold the charger firmly and pull out the battery. Supporting the battery charger with hand, pull out the battery from the battery charger.

NOTE:
After operation, pull out batteries from the charger first, and then keep the batteries properly.
Regarding electric discharge in case of new batteries, etc.

As the internal chemical substance of new batteries and batteries that have not been used for an extended period is not activated, the electric discharge might be low when using them the first and second time. This is a temporary phenomenon, and normal time required for recharging will be restored by recharging the batteries 2 - 3 times.

How to make the batteries perform longer.

- Recharge the batteries before they become completely exhausted.
- When you feel that the power of the gardening appliance becomes weaker, stop using the gardening appliance and recharge its battery. If you continue to use the gardening appliance and exhaust the electric current, the battery may be damaged and its life will become shorter.
- Avoid recharging at high temperatures.
- A rechargeable battery will be hot immediately after use. If such a battery is recharged immediately after use, its internal chemical substance will deteriorate, and the battery life will be shortened. Leave the battery and recharge it after it has cooled for a while.

CAUTION
When the battery charger has been continuously used, the battery charger will be heated, thus constituting the cause of the failures. Once the charging has been completed, give 15 minutes rest until the next charging.

- If the battery is charged while it is heated because it has been left for a long time in a location subject to direct sunlight or because the battery has just been used, the pilot lamp of the charger lights for 1 second, does not light for 0.5 seconds (off for 0.5 seconds).
- The battery will not be recharged. In such a case, let the battery cool before charging.
- When the pilot lamp flickers (at 0.2-second intervals), check for and take out any foreign objects in the charger's battery connector. If there are no foreign objects, it is probable that the battery or charger is malfunctioning. Take it to your authorized Service Center.

- NOTE:**
- Charging times may be longer depending on the surrounding temperature and battery conditions.
 - Charge time lamp indications are only a guide, and may vary depending on the surrounding temperature and battery conditions.
 - Remove the battery from the charger when not in use.

ABOUT POWER LAMP

The power lamp indicates various statuses for the gardening appliance. (Fig. 5)
Table 5 shows the various statuses indicated by the power lamp.

Table 5

State of lamp	Status of Gardening appliance
Off	Power OFF
Red	Power ON
Blinking red	The over-heat protection circuit of the gardening appliance is operating.
Quickly blinking red	The lever is being pressed while the overheat protection circuit of the gardening appliance is operating. The gardening appliance is operating abnormally.

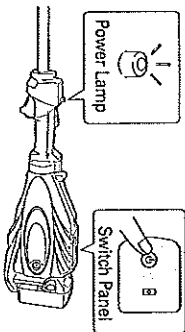

Fig. 5

ABOUT REMAINING BATTERY INDICATOR

The remaining battery lamp blinks when the remaining battery power is low. (Fig. 6)
Please charge the gardening appliance as soon as possible.
The table 6 shows the state of remaining battery indicator lamp and the battery remaining power.

Table 6

State of lamp	Battery Remaining Power
	The battery remaining power is enough.
	The battery remaining power is nearly empty. Re-charge the battery as soon as possible.

As the remaining battery indicator shows somewhat differently depending on ambient temperature and battery characteristics, read it as a reference.

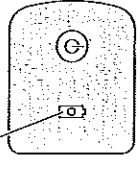

Fig. 6

NOTE:
Do not give a strong shock to the switch panel or break it; it may lead to a trouble.

PRIOR TO OPERATION

CAUTION:

Pull out battery before doing any assembly.

1. Installing the loop handle (Fig. 7)
- (1) Remove the finger-tight M6 x 43 bolts (2 pcs.).
- (2) Install the loop handle on the main pipe so that it leans against the housing.
- (3) Place the handle fixture at the lower end of the main pipe and secure it firmly using M6 x 43 bolts (2 pcs.) and M6 nuts (2 pcs.).

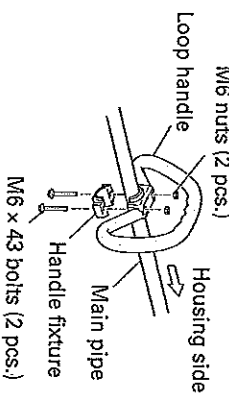

Fig. 7

NOTE:
Secure the loop handle in a location that provides a good grip.

CAUTION:

Install the loop handle properly and securely as instructed in the handling instructions. If not attached properly or securely, it may come off and cause injury.

2. Installing cover (Fig. 8, 9)

WARNING:

Be sure to install the cover in its designated location. Failure to heed this warning may result in injury from flying stones.

NOTE:

Use the supplied Allen wrench 4mm for installation.

- (1) Use the supplied D5 tapping screw to install the knife in the cover. (Fig. 8)

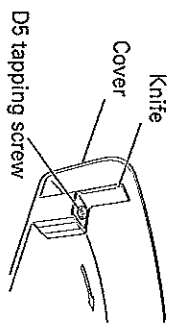

Fig. 8

- (2) Align the two holes in the cover bracket and the cover and insert two M6 x 25 hex. socket button bolts passed through a M6 spring washer respectively. (The cover bracket is installed in the motor case.)
- (3) Place the cover holder on the underside of the cover and use the supplied Allen wrench 4 mm to alternately tighten the two M6 x 25 hex. socket button bolts until they are properly tightened.

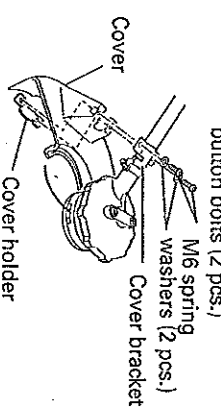

Fig. 9

CAUTION:

Take care to avoid cutting yourself on the knife inside the cover. Install the cover and knife properly and securely as instructed in the handling instructions. If not attached properly or securely, they may come off and cause injury.

NYLON HEAD

Installation of semi-auto nylon head

1. Function
Automatically feeds more nylon cutting line when it is tapped.

Specifications

Code No.	Type of attaching screw	Direction of rotation	Size of attaching screw
334127	Female screw	Counterclockwise	M10x P1.25-LH

Applicable nylon cord
Cord diameter: Fig. 10
Length: 6.56 ft. (2 m)
Cross-section shape of line: Oval

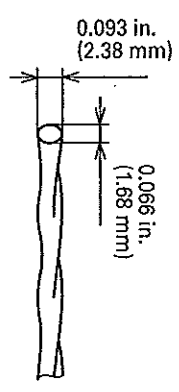

Fig. 10

CAUTION:

The case must be securely attached to the cover. Check the cover, case and other components for cracks or other damage. Check the case and button for wear. If the wear limit mark on the case is no longer visible or there is a hole in the bottom of the button, change the new parts immediately. (Fig. 11) The nylon head must be securely mounted to the threaded fastener of the motor case. For outstanding performance and reliability, always use Hitachi nylon cutting line. Never use metal wire rope and the like that could become a dangerous projectile.

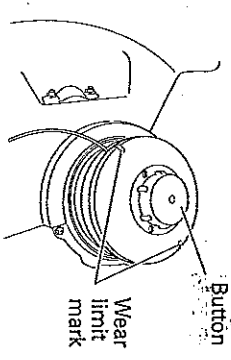

Fig. 11

- If the nylon head does not feed cutting line properly, check that the nylon line and all components are properly installed. Contact your Hitachi dealer if you need assistance.

2. Installation (Fig. 12, 13)
- (1) Insert the flange ass'y into the motor case. At this time, the wing of the flange ass'y should face the motor case side. Next, align the holes of the flange ass'y and the motor case, insert the Allen wrench 4 mm, and then turn to tighten the flange ass'y.
- (2) Screw the nylon head directly to the threaded fastener of the motor case.

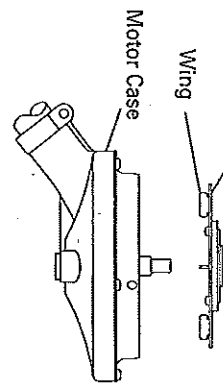

Fig. 12

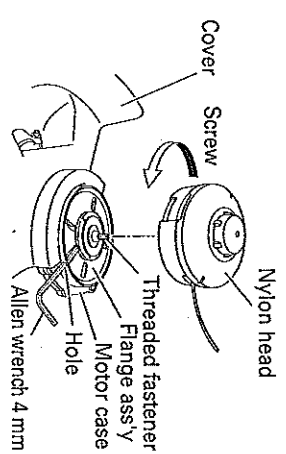

Fig. 13

CAUTION:

Install the nylon head properly and securely as instructed in the handling instructions. If not attached properly or securely, it may come off and cause injury.

- The mounting nut of nylon head is left-hand-threaded. Turn clockwise to loosen/counterclockwise to tighten.

3. Adjustment of line length

- (1) Rotate and tap the nylon head on the ground. Nylon line is drawn out abt. 1-3/16" (30 mm) by one tapping. (Fig. 14)

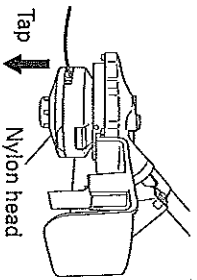

Fig. 14

Also, you can extend nylon line with hands. This time the motor must be completely stopped.

Confirm the line extends in 1-3/16" (30 mm) increments by "tapping" and "releasing" the bottom button while pulling the line ends of the nylon head. (Fig. 15)

Appropriate length of nylon line

The appropriate length of the line when the gardening appliance is in use is 3-17/32" - 4-5/16" (90 - 110 mm). Extend the line to the appropriate length.

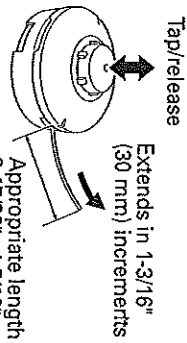

Fig. 15

4. Nylon line replacement
 - (1) Prepare 6.56 ft. (2 m) of genuine nylon line in Fig. 10. (Code No.334128)
If the cross section is circular, 0.055 in. (ø1.4 mm) of line can be used.
 - (2) Press the opposing tabs, and then remove the cover from the case. (Fig. 16)

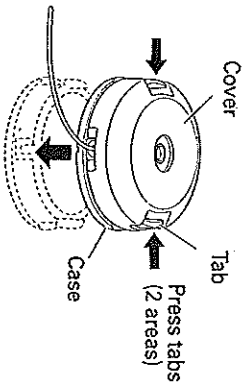

Fig. 16

- (3) Remove the reel from the case. (Fig. 17)
If there is nylon line remaining, hook the line in the grooves, and then remove the reel.

- (4) If the nylon line does not extend when there is enough nylon line remaining, or when replacing the nylon line (Code No. 334128), wind the nylon line using the following procedure.

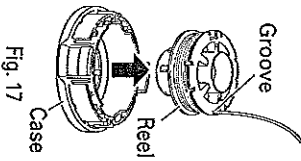

Fig. 17

- (4) Hook the nylon line in the grooves of the reel as shown in Fig. 18 and 19, and then wind the line in the direction of the arrow so that the nylon line does not cross.

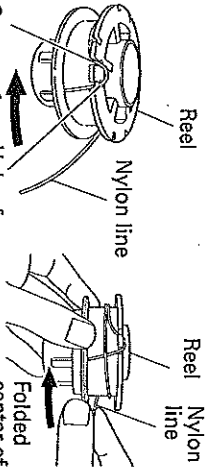

Fig. 18

Fig. 19

- (5) Leave about 3-15/16" - 5-15/16" (100 mm - 150 mm) nylon cord unwound, hook and secure the line in the stopper. (Fig. 20)

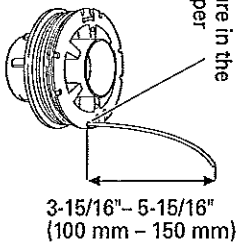

Fig. 20

NOTE:
Do not cross the nylon line when securing the line in the stopper. (Fig. 21)

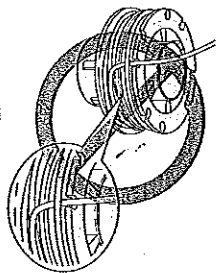

Fig. 21

- (6) Align the position of the stopper and eyelet line guide, and then insert the button through the case. Release the line from the stopper while holding the reel lightly, and then string the line through the eyelet line guide. (Fig. 22)

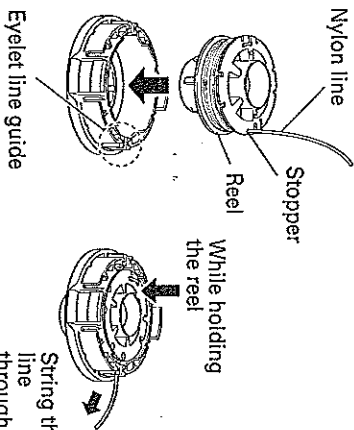
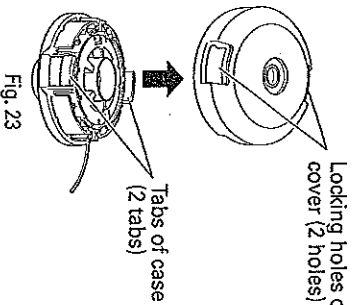

Fig. 22

- (7) Press and snap the tabs of the case in the locking holes of the cover. (Fig. 23)

WARNING:

Check to make sure the tabs are firmly snapped into the locking holes. Operating the gardening appliance while the parts are not firmly snapped together may result in accidents or injury from flying part.



- (8) Pull the line taut so there is no slack, and then cut the line to an extended length of 3-17/32" - 4-5/16" (90 mm - 110 mm) with scissors. (Fig. 24)

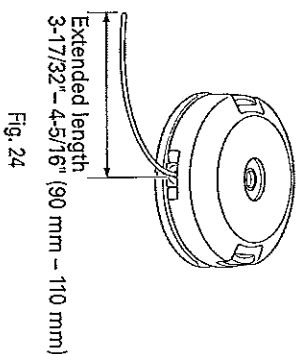

OPERATION

Trimming grass

WARNING:

- Do not operate the gardening appliance at night or under bad weather conditions when visibility is poor.
- Do not operate the gardening appliance when it is raining or right after it has been raining.
- Wear proper footwear to prevent slipping that could cause you to lose your balance and fall.
- Do not use the gardening appliance on steep slopes.
- When trimming grass on slopes that are not so steep, trim by moving towards the ridge.
- Place the right hand on the handle and the left hand on the loop handle and hold it firmly.
- Take care not to move the nylon head too close to your feet.
- Do not raise the nylon head above your knee during cutting.
- Do not use the gardening appliance where the nylon head may come into contact with stones, tree and other obstacles.
- Do not use the gardening appliance within 50ft. (15 m) of another person. When you work with someone else, maintain a distance of more than 50ft. (15 m).
- Insert the battery while observing its polarities.
- Turn on the gardening appliance. (Fig. 25)
- Press the power button on the housing, the power goes on and the power lamp on the handle lights red.
- Pressing the power button a second time turns the power off and the red lamp on the handle goes off.

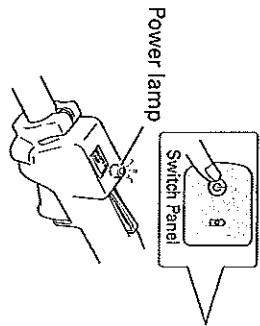

Fig. 25

[Auto power off]

When the power is turned on but the lever is not used for one minute, the gardening appliance is automatically turned off. To turn the gardening appliance on again, press the power button a second time.

- ▲ **WARNING:**
Never leave the gardening appliance with the power on. This could result in an accident.

- 3. Trimming grass
Grip the handle from above, press the lock lever and pull the lever to start nylon head rotation. (Fig. 26)

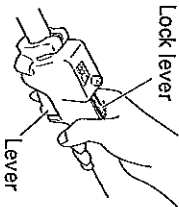

Fig. 26

- Release the lever when you finish trimming and stop the motor.
- Place your thumb on the loop handle and grip the handle with your other fingers. (Fig. 27)

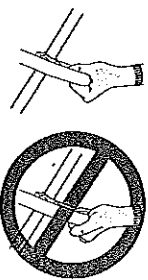

Fig. 27

- Take a posture that makes it easy to move.

- **[Grass trimming techniques]**
Do not swing the pipe, but use the hips to move the nylon head horizontally from right to left in an arc while going forward and use the left side of the nylon head for cutting grass. (Fig. 28)

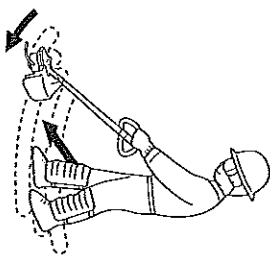

Fig. 28

OPERATIONAL CAUTIONS

Continuous work

This gardening appliance comes with an over-heat protection circuit that protects the electronic parts that control the rechargeable battery. In continuous trimming work, gardening appliance temperature will rise and eventually trigger the over-heat protection circuit, which will shut down the gardening appliance.

If this happens, let the gardening appliance cool for a length of time. When the temperature drops, it will again become possible to use the gardening appliance. When the rechargeable battery has to be exchanged during continuous operation, let the gardening appliance rest for about 15 minutes.

Overload Protection

This gardening appliance comes with an overload protection circuit to protect the electronic parts controlling the gardening appliance. In continuous overload during trimming work (locking the nylon head, etc.), the overload protection circuit shuts down the motor. If this happens, turn OFF the power, and then resolve the problem causing the overload.

The power lamp blinks if the lever is pressed after the motor has stopped (see page 15, "ABOUT POWER LAMP"). The power automatically turns OFF if the power lamp blinks longer than 5 seconds. If this happens, resolve the problem causing the overload, and then switch the power button ON to resume using the gardening appliance.

MAINTENANCE AND INSPECTION

- ▲ **CAUTION**
Pull out battery before doing any inspection or maintenance.

- 1. Checking the condition of the nylon head
The nylon head should be checked regularly. If worn or broken nylon head can slip or decrease the efficiency of the motor and burn it out. Replace worn nylon head with new ones.

▲ **CAUTION**

If you use a nylon head of which point is worn or broken, it will be dangerous. So replace it with a new one.

- 2. Check the Screws
Loose screws are dangerous. Regularly inspect them and make sure they are tight.

▲ **CAUTION**

Using this gardening appliance with loosened screws is extremely dangerous.

- 3. Inspecting the carbon brushes (Fig. 29)
The motor employs carbon brushes which are consumable parts. Since and excessively worn carbon brush can result in motor trouble, replace the carbon brush with new ones when it becomes worn to or near the "wear limit". In addition, always keep carbon brushes clean and ensure that they slide freely within the brush holders.

NOTE:

When replacing the carbon brush with a new one, be sure to use the Hitachi Carbon Brush Code No. 999015.

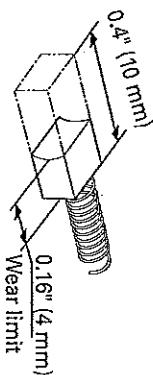

Fig. 29

- 4. Replacing carbon brushes
Take out the carbon brush by first removing the brush cap and then hooking the protrusion of the carbon brush with a flat head screw driver, etc., as shown in Fig. 30 and Fig. 31.

When installing the carbon brush, choose the direction so that the nail of the carbon brush (See Fig. 32) agrees with the contact portion of brush tube. Then push it in with a finger as illustrated in Fig. 32. Lastly, install the brush cap.

▲ **CAUTION**

Be absolutely sure to insert the nail of the carbon brush into the contact portion of brush tube. (You can insert whichever one of the two nails provided.)

Caution must be exercised since any error in this operation can result in the deformed nail of the carbon brush and may cause motor trouble at an early stage.

Brush cap (2 pcs.)

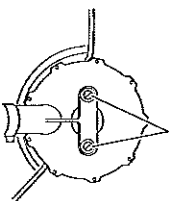

Fig. 30

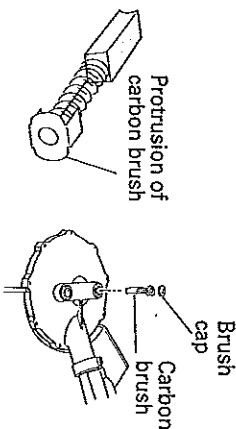

Fig. 31

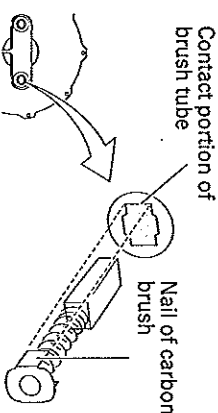

Fig. 32

5. Check for Dust
Dust may be removed with a soft cloth or a cloth dampened with soapy water.
Do not use bleach, chlorine, gasoline or thinner, for they may damage the plastics.
6. Disposal of the exhausted battery

WARNING:
Do not dispose of the exhausted battery. The battery must explode if it is incinerated. The product that you have purchased contains a rechargeable battery. The battery is recyclable. At the end of its useful life, under various state and local laws, it may be illegal to dispose of this battery into the municipal waste stream. Check with your local solid waste officials for details in your area for recycling options or proper disposal.

7. Storage
Storing in a place below 104°F (40°C) and out of the reach of children.

NOTE:

Make sure that the battery is fully charged when stored for a long period (3 months or more). The battery with smaller capacity may not be able to be charged when used, if stored for a long period.

8. Service and repairs
All quality gardening appliances will eventually require servicing or replacement of parts because of wear from normal use. To assure that only authorized replacement parts will be used, all service and repairs must be performed by a HITACHI AUTHORIZED SERVICE CENTER, ONLY.
9. Service parts list

CAUTION

Repair, modification and inspection of Hitachi Gardening Appliances must be carried out by a Hitachi Authorized Service Center.
This Parts List will be helpful if presented with the gardening appliance to the Hitachi Authorized Service Center when requesting repair or other maintenance. In the operation and maintenance of gardening appliances, the safety regulations and standards prescribed in each country must be observed.

MODIFICATIONS:
Hitachi Gardening Appliances are constantly being improved and modified to incorporate the latest technological advancements.
Accordingly, some parts may be changed without prior notice.

ACCESSORIES

WARNING:
ALWAYS use Only authorized HITACHI replacement parts and accessories. NEVER use replacement parts or accessories which are not intended for use with this gardening appliance. Contact HITACHI if you are not sure whether it is safe to use a particular replacement part or accessory with your gardening appliance.
The use of any other attachment or accessory can be dangerous and could cause injury or mechanical damage.

NOTE:

Accessories are subject to change without any obligation on the part of the HITACHI.

STANDARD ACCESSORIES

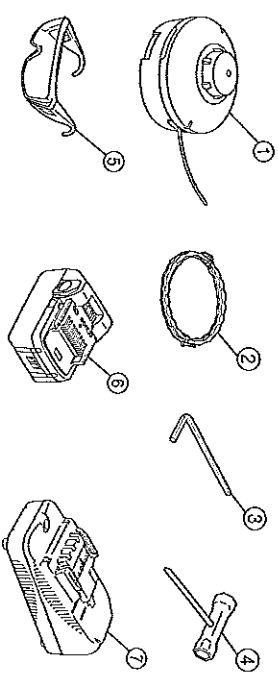
<p>CG18BSDL (LSC)</p> 	<ol style="list-style-type: none"> ① Nylon head (Code No. 334127) 1 ② Nylon line (Code No. 334128) 1 ③ Allen wrench 4 mm (Code No. 6684813) 1 ④ Box wrench (Hex. socket 17/19) (Code No. 6684764) 1 ⑤ Protective glasses (Code No. 875769) 1 ⑥ Battery (BSL1830) 1 ⑦ Battery Charger (UC18YGSL) 1
--	--

Included items
The following items are supplied with the product (used for assembly of each part).

<ol style="list-style-type: none"> ① Cover 1 ② Cover holder 1 ③ M6 x 25 hex. socket button bolt 2 ④ M6 spring washer 2 ⑤ Knife 1 ⑥ D5 tapping screw 1 	<ol style="list-style-type: none"> ⑦ Loop handle 1 ⑧ Handle fixture 1 ⑨ M6 x 43 bolt 2 ⑩ M6 nut 2 ⑪ Flange ass'y 1
---	---

OPTIONAL ACCESSORIES.....sold separately

1. Battery

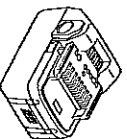

BSL1830 (Code No. 3300671)

TROUBLESHOOTING

Use the inspections in the table below if the gardening appliance does not operate normally. If this does not remedy the problem, consult your dealer or the Hitachi Authorized Service Center.

	Symptom	Possible cause	Remedy
Charger	The Charge lamp does not go on.	The power plug is not connected to an AC outlet.	Connect the power plug to an AC outlet.
		The battery is not properly connected to the charger. The battery or charger electrodes are soiled. The battery is extremely hot.	Insert the battery so that it is properly seated in the charger. Use a cotton swab or other tool to clean the electrodes. Allow the battery to properly cool before charging.
Gardening appliance	The Charge lamp does not go off after 4 hours of charging.	The battery or charger is faulty.	Disconnect the power plug and consult your dealer or the Hitachi Authorized Service Center.
		The rechargeable battery is depleted. The rechargeable battery has not been properly installed. The power has not been turned on.	Charge the rechargeable battery. Remove the rechargeable battery from the battery compartment in the gardening appliance and check for and remove any foreign matter. Also check the battery electrodes for soiling, water or other foreign matter. Use a cotton swab for cleaning. Make sure that the rechargeable battery is pressed in until it clicks into place. Press the power button on the housing to start the gardening appliance. This gardening appliance comes with an auto power off function. The power is automatically turned off if nobody pulls the lever during a one minute period after power on. To turn the gardening appliance on again, press the power button a second time. Pressing the power button a second time turns the power off.
	The lock lever was not pressed when the lever was pulled back		To prevent accidents from incorrect operation, the lock lever must be pressed while the lever is pulled back to start the motor. Hold the handle from above and press the lock lever while pulling the handle.

	Symptom	Possible cause	Remedy
Gardening appliance	Does not operate.	The gardening appliance pulls in large volumes of grass that are caught between the cover and the nylon head, the gardening appliance is overloaded.	This is the effect of a function that protects the rechargeable battery by turning off the motor when the gardening appliance is exposed to an excessive load. Turn off the gardening appliance and remove the cause of the overload. Press the power button once again to continue operation.
		Goes on, but soon stops.	The rechargeable battery power is low. The rechargeable battery is overheated.
	Strong vibrations	The loop handle is not properly attached to the main pipe. The cover is not being properly attached to the main pipe.	Secure properly. Secure properly.