

CHICAGO

Electric[®] Power Tools

ELECTRIC CHAINSAW SHARPENER

Model 93213
ASSEMBLY and OPERATING
INSTRUCTIONS



NOTE: Actual product design may differ slightly from that shown in this manual.



3491 Mission Oaks Blvd., Camarillo, CA 93011
Visit our Web site at <http://www.harborfreight.com>

Copyright© 2005 by Harbor Freight Tools®. All rights reserved. No portion of this manual or any artwork contained herein may be reproduced in any shape or form without the express written consent of Harbor Freight Tools.

For technical questions and replacement parts, please call 1-800-444-3353

Specifications

Motor	115 V, .75A (Load), Direct Drive
RPM	4200
Vise Capacity	0.80" to 0.50"
Table / Vise Angles	35 Degrees Right to Left
Arbor Diameter	7/8"
Wheel Dimensions	4-1/4" Dia. x 1/8" Thick
Overall Dimensions	9" W x 10" L x 12-1/8" H
Weight	4.85 Lbs.

Save This Manual

You will need the manual for the safety warnings and precautions, assembly instructions, operating and maintenance procedures, parts list and diagram. Keep your invoice with this manual. Write the invoice number on the inside of the front cover. Keep the manual and invoice in a safe and dry place for future reference.

Safety Warnings and Precautions

WARNING: When using tool, basic safety precautions should always be followed to reduce the risk of personal injury and damage to equipment.

Read all instructions before using this tool!

1. **Keep work area clean.** Cluttered areas invite injuries.
2. **Observe work area conditions.** Do not use machines or power tools in damp or wet locations. Don't expose to rain. Keep work area well lighted. Do not use electrically powered tools in the presence of flammable gases or liquids.
3. **Keep children away.** Children must never be allowed in the work area. Do not let them handle machines, tools, or extension cords.
4. **Store idle equipment.** When not in use, tools must be stored in a dry location to inhibit rust. Always lock up tools and keep out of reach of children.
5. **Use the right tool for the job.** Do not attempt to force a small tool or attachment to do the work of a larger industrial tool. There are certain applications for which this tool was designed. It will do the job better and more safely at the rate for which it was intended. Do not modify this tool and do not use this tool for a purpose for which it was not intended.
6. **Dress properly.** Do not wear loose clothing or jewelry as they can be caught in moving parts. Protective, electrically nonconductive clothes and nonskid footwear are recommended when working. Wear restrictive hair covering to contain long hair.
7. **Use eye and ear protection.** Always wear ANSI approved impact safety goggles. Wear a full face shield if you are producing metal filings or wood chips.
8. **Do not overreach.** Keep proper footing and balance at all times. Do not reach over or across running machines.

9. **Maintain tools with care.** Keep tools sharp and clean for better and safer performance. Follow instructions for lubricating and changing accessories. Inspect tool cords periodically and, if damaged, have them repaired by an authorized technician. The handles must be kept clean, dry, and free from oil and grease at all times.
10. **Avoid unintentional starting.** Be sure the switch is in the Off position when not in use and before plugging in.
11. **Stay alert.** Watch what you are doing, use common sense. Do not operate any tool when you are tired.
12. **Check for damaged parts.** Before using any tool, any part that appears damaged should be carefully checked to determine that it will operate properly and perform its intended function. Check for alignment and binding of moving parts; any broken parts or mounting fixtures; and any other condition that may affect proper operation. Any part that is damaged should be properly repaired or replaced by a qualified technician. Do not use the tool if any switch does not turn On and Off properly.
13. **Guard against electric shock.** Prevent body contact with grounded surfaces such as pipes, radiators, ranges, and refrigerator enclosures.
14. **Replacement parts and accessories.** When servicing, use only identical replacement parts. Use of any other parts will void the warranty. Only use accessories intended for use with this tool. Approved accessories are available from Harbor Freight Tools.
15. **Do not operate tool if under the influence of alcohol or drugs.** Read warning labels on prescriptions to determine if your judgment or reflexes are impaired while taking drugs. If there is any doubt, do not operate the tool.
16. **Use proper size and type extension cord.** If an extension cord is required, it must be of the proper size and type to supply the correct current to the tool without heating up. Otherwise, the extension cord could melt and catch fire, or cause electrical damage to the tool. This tool requires use of an extension cord of **0 to 10 amps** capability (up to 50 feet), with wire size rated at **18 AWG**. Longer extension cords require larger size wire. If you are using the tool outdoors, use an extension cord rated for outdoor use (signified by "WA" on the jacket).
17. **Maintenance.** For your safety, maintenance should be performed regularly by a qualified technician.
18. Never use the Electric Chainsaw Sharpener around flammable materials.
19. This product contains lead, which is a chemical known to the State of California to cause cancer and birth defects or other reproductive harm. (California Health & Safety Code § 25249.5, *et seq.*)

Note: Performance of this tool (if powered by line voltage) may vary depending on variations in local line voltage. Extension cord usage may also affect tool performance.

Warning: The warnings, cautions, and instructions discussed in this instruction manual cannot cover all possible conditions and situations that may occur. It must be understood by the operator that common sense and caution are factors which cannot be built into this product, but must be supplied by the operator.

Additional Safety Warnings

Grinding Wheel Warnings.

1. Do not use a grinding wheel if it is chipped, cracked, or worn. You can check if the wheel has cracks not visible to the human eye by hanging it up by the central hole and tapping it with a nonmetallic object (ie: screwdriver handle). If it is in good condition it will produce a metallic sound. A dull sound indicates a crack or break.
2. Only use grinding wheels that fit the Arbor (7/8"). Do not try to change or modify the mounting hole on a grinding wheel to make it fit. Grinding wheel replacements are available at Harbor Freight Tools.
3. Do not overtighten the **Grinder Lock Cap (9)**. Hand tighten it only. Overtightening may cause the wheel to break or disintegrate.
4. Never use the Chainsaw Sharpener without the **Grinding Wheel Cover (11B)** in place.
5. Always test the **Grinding Wheel (8)** by running it for a minute prior to contact with a chain.
6. Keep away from the wheel when it is turning, and make sure no one is standing close, in the line of the wheel rotation trajectory.
7. If the grinding wheel vibrates, turn off the machine immediately and check that it is mounted securely, and that is not damaged.
8. Never try to stop the grinding wheel with your hands, even if you are wearing safety gloves. The wheel will cut through gloves and your hand, causing serious injury.
9. Never operate tool without the Grinding Wheel Cover in place.
10. Replacement grinding wheel listed speed must meet or exceed RPM rating of the tool.

Warning!! This machine is designed to sharpen chainsaw chains. Do not attempt to sharpen any other tools, and do not attempt to grind any other objects.

Unpacking

When unpacking, check to make sure the parts listed on page 9 are included. If any parts are missing or broken, please call Harbor Freight Tools at the number on the cover of this manual as soon as possible.

Assembly

1. When installing the sharpener on a workbench, make sure that the **Lock Wheel (18)** is accessible, as shown in the mounting picture in **FIGURE 1**.
2. Bolt (bolts not included) the unit directly to the workbench through the two 1/4" holes on the **Base (17)**. The workbench must have a solid surface capable of supporting the weight of this product, the workpiece and assorted tools. See **FIGURE 2**.

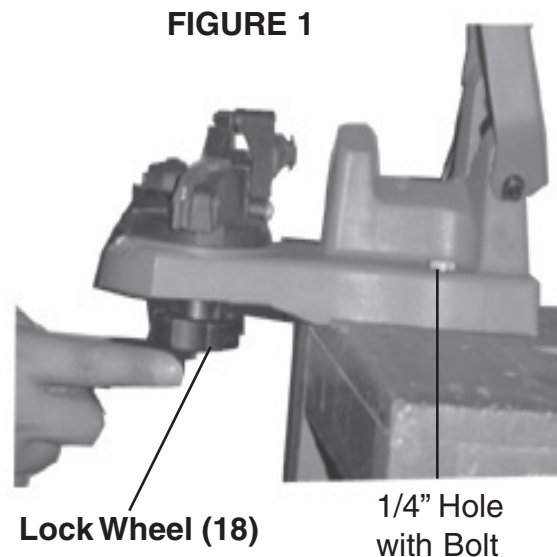
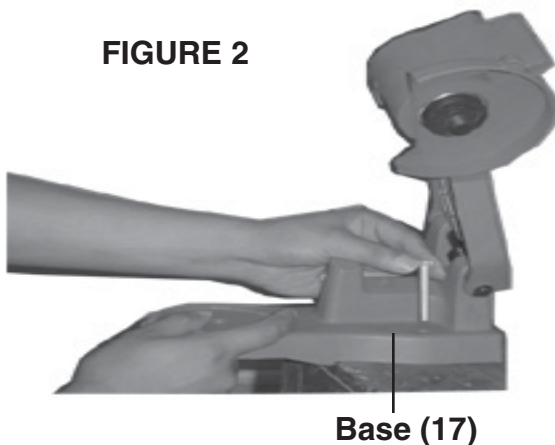

Warning! Always unplug the unit before changing grinding wheels, or when making any adjustments to the Sharpener.

Mounting a Grinding Wheel.

Refer to the Assembly Drawing on page 10 and **FIGURE 3** and **FIGURE 4** below.

1. Raise the **Top Housing (4B)** and lock it in the up position by tightening the **Lock Stop (6)**.
2. Remove the two screws holding the **Grinding Wheel Cover (11B)**. Set the cover aside.
3. Unscrew the **Grinder Lock Cap (9)** that holds the **Grinding Wheel (8)** in place.
4. Install the new wheel on the **Grinding Wheel Base (7)**, making sure it fits properly.

Note: Do not use a grinding wheel if it is chipped, cracked, or worn. You can check if the wheel has cracks not visible to the human eye by hanging it up by the central hole and tapping it with a non metal object (ie: screwdriver handle). If it is in good condition it will produce a metallic sound. A dull sound indicates a crack or break.

5. Replace the **Grinder Lock Cap (9)**.
6. Replace the **Grinding Wheel Cover (11B)**.
7. Release the **Lock Stop (6)** and lower the **Top Housing (4B)**.
8. Never operate tool without the Grinding Wheel Cover in place.

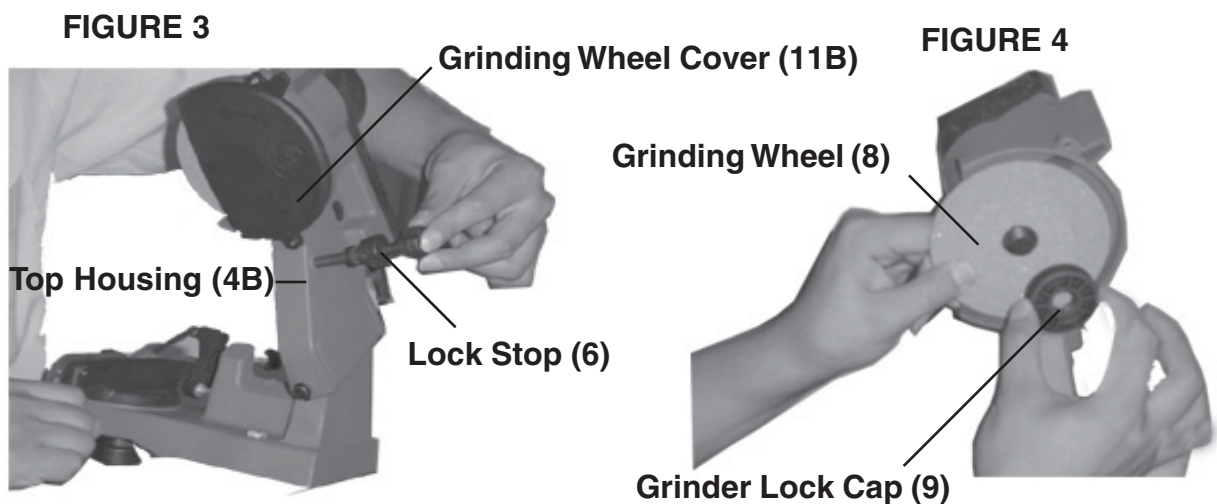

Operation

Warning! Always unplug the unit while adjusting chain to be sharpened.

Refer to the Assembly Drawing on page 10 and the various photographs.

Note: Raise the **Top Housing (4B)** while adjusting the chain.

1. Clean the chain before sharpening. Wash it with a nonflammable solvent. Do not use gasoline. Dry the chain.
2. Lift up the **Chain Stop (23)** and secure the chain in the **Sliding Guides (31)**. See **FIGURE 6**.
3. Lower the **Chain Stop (23)** so that it is positioned on the tooth (cutter) you want to start with. See **FIGURE 5**.

FIGURE 5

Tip of Chain Stop positioned against tooth.

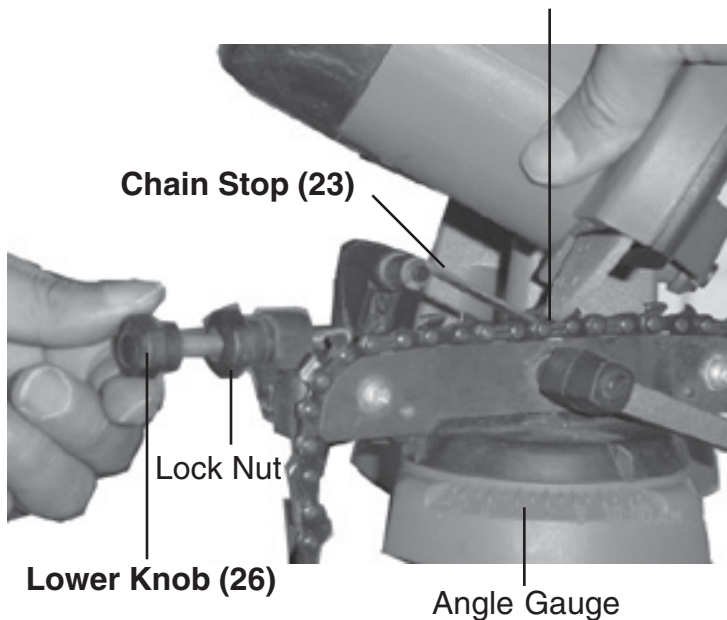
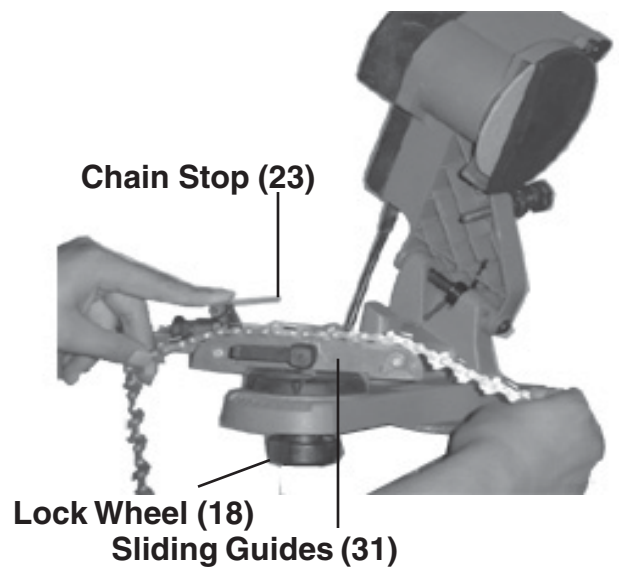

FIGURE 6



4. See **FIGURES 5 & 6**. Loosen the **Lock Wheel (18)** to allow entire housing to turn. Rotate the housing to match the degree of angle you need on the Angle Gauge. Chains come in various sizes with varying degrees of sharpening angles. Check with your chain manufacturer's manual to determine what degree you need to sharpen at. Once the degree is set, tighten the **Lock Wheel (18)**.
5. Lower the **Top Housing (4B)** so that the **Grinding Wheel (8)** skims the chain tooth.
6. Hold it at that position while you tighten the **Lock Stop (6)** so that the wheel will only go down to that point. See **FIGURE 7**.
7. Depending on the amount of material you wish to remove, tighten or loosen the **Lower Knob (26)** and set the Lock Nut. See **FIGURE 5**. The **Lower Knob (26)** has a Lock Nut which will determine how much material is removed. Once you set the Lock Nut, fully tighten the **Lower Knob (26)**.

FIGURE 7



Operation (continued)

8. Lock the chain in the **Sliding Guides (31)** by turning the **Handle (34)**. See **FIGURE 8**. The **Handle (34)** should be situated so that you can easily release and tighten it. You will need to release it each time you move to the next link, and tighten it to sharpen each link.

FIGURE 8

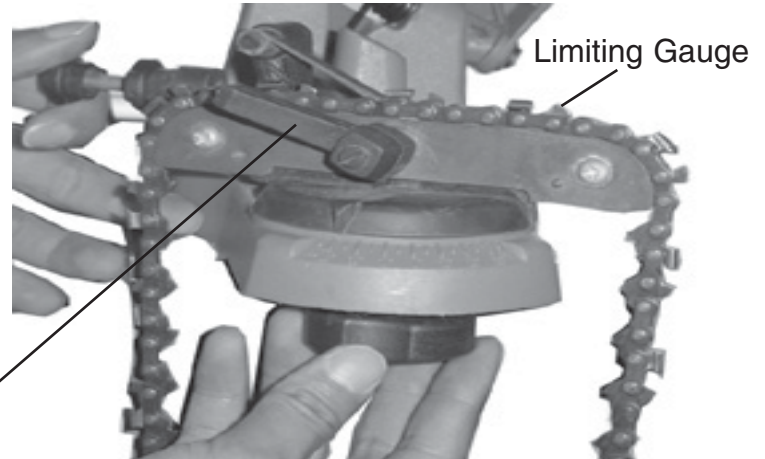

9. If the chain has been repeatedly sharpened, the chain depth limiting gauges may need to be taken down with a flat file (not included). See **FIGURES 8 & 9**. File down each gauge so that they are at a lower level than the cutting teeth.

FIGURE 9



Sharpening

1. Put on your protective gear and make sure the immediate area is clear of bystanders.
2. Plug in the **Power Cord (3)** and push the **Switch (5B)** to turn on the machine.
3. Slowly lower the grinding wheel as shown in **FIGURE 10**. If you notice slight errors in your settings, turn off the unit and unplug it before you make your adjustments.

Note: A good grind occurs when the contact between the wheel and the teeth are gradual and smooth. Do not stop too long on any tooth.

4. After sharpening one tooth, turn off the machine. Lift the **Top Housing (4B)**, release the **Handle (34)**, and move the chain so that the next link is positioned in the **Chain Stop (23)**. Tighten the **Handle (34)**. Turn the machine back on and continue sharpening the next tooth. Repeat this process until you have sharpened all of the links set up for this angle.

FIGURE 10

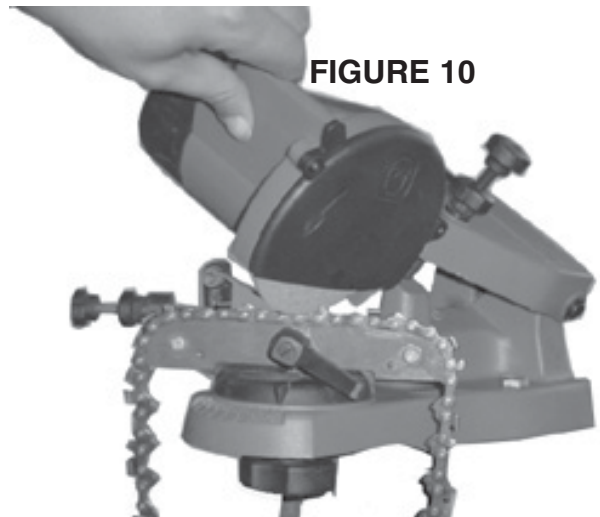

Operation (continued)

5. After you finished sharpening all of the teeth set for your current angle, turn off the machine by pushing the **Switch (5B)** and unplugging the unit. **See FIGURE 11**
6. Loosen the **Lock Wheel (18)** and reset the angle so that the first tooth that hasn't been sharpened is positioned against the **Chain Stop (23)** and locked in, as explained on page 6.
7. As you did with the first half of the chain, be sure to lower the **Top Housing (4B)** so that the **Grinding Wheel (8)** skims the chain tooth, and lock it in place. See page 6. Follow all of the steps on page 6 double checking everything before you plug in the machine and turn it on again.

FIGURE 11

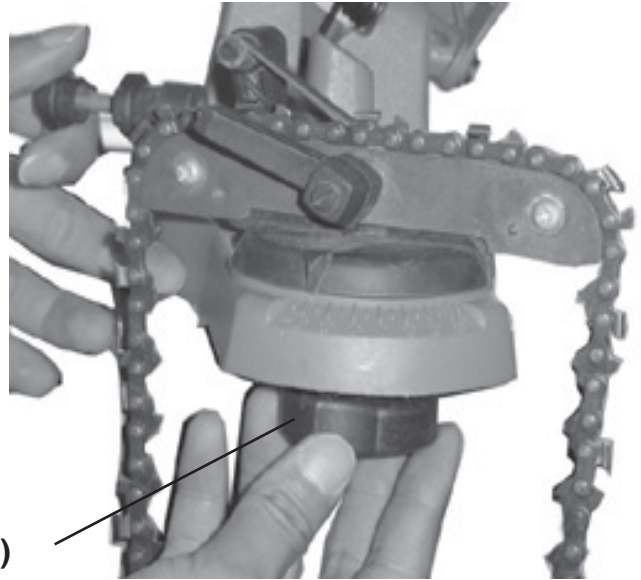

Lock Wheel (18)

Remember to turn off the machine and unplug it if you need to make any adjustments.

8. After you repeat all of the steps under Sharpening on page 7, your chain is ready to be mounted on your saw.

Maintenance

1. Keep the Sharpener clean and free of dust, metal debris and dirt.
2. Check the Grinding Wheel before each use to make sure it isn't damaged. Do not use a grinding wheel if it is chipped, cracked, or worn. You can check if the wheel has cracks not visible to the human eye by hanging it up by the central hole and tapping it with a non metal object (ie: screwdriver handle). If it is in good condition it will produce a metallic sound. A dull sound indicates a crack or break.
3. Replace the Grinding Wheel when it grinds down to a diameter of 3 inches.

Parts List

Part	Description	Qty.	Part	Description	Qty.
1	Screw	3	20*	Washer	1
2	Motor Cover	1	21*	Bearing	1
3	Power Cord	1	22*	Swing Arm	1
4B	Top Housing	1	23*	Chain Stop	1
5B	Rocker Switch	1	24*	Tension Spring	1
6	Lock Stop	1	25*	Retaining Ring (5)	1
7	Grinding Wheel Base	1	26*	Lower Knob	1
8	Grinding Wheel	1	27*	Screw	1
9	Grinder Lock Cap	1	28*	Bolt	1
10	Screw	2	29*	Chain Saw Frame	1
11B	Grinding Wheel Cover	1	30*	Square Neck Screw	1
12	O-ring	2	31*	Sliding Guide	2
13	Punching Axis	1	32*	Pad	2
14	Torsion Spring	1	33*	Screw	2
15B	Switch Circuit Board	1	34*	Handle	1
16	Nut	1	35*	Spring	1
17	Base	1	36*	Lock Screw	1
18	Lock Wheel	1	37	Retaining Ring (10)	2
19*	Screw	1	38	Motor	1

The **Chain Mounting Assembly (39)** is only available as a set. It includes all part numbers with asterisks (*). Part numbers with asterisks (19 through 36) are not available individually.

PLEASE READ THE FOLLOWING CAREFULLY

THE MANUFACTURER AND/OR DISTRIBUTOR HAS PROVIDED THE PARTS DIAGRAM IN THIS MANUAL AS A REFERENCE TOOL ONLY. NEITHER THE MANUFACTURER NOR DISTRIBUTOR MAKES ANY REPRESENTATION OR WARRANTY OF ANY KIND TO THE BUYER THAT HE OR SHE IS QUALIFIED TO MAKE ANY REPAIRS TO THE PRODUCT OR THAT HE OR SHE IS QUALIFIED TO REPLACE ANY PARTS OF THE PRODUCT. IN FACT, THE MANUFACTURER AND/OR DISTRIBUTOR EXPRESSLY STATES THAT ALL REPAIRS AND PARTS REPLACEMENTS SHOULD BE UNDERTAKEN BY CERTIFIED AND LICENSED TECHNICIANS AND NOT BY THE BUYER. THE BUYER ASSUMES ALL RISK AND LIABILITY ARISING OUT OF HIS OR HER REPAIRS TO THE ORIGINAL PRODUCT OR REPLACEMENT PARTS THERETO, OR ARISING OUT OF HIS OR HER INSTALLATION OF REPLACEMENT PARTS THERETO.

NOTE: Some parts are listed and shown for illustration purposes only and are not available individually as replacement parts.

Assembly Drawing

