

HANNSPREE

1506-060B000



28"

Liquid Crystal Display Television

Téléviseur à Écran à Cristaux Liquides

TV de Pantalla de Cristal Líquido

User's Manual

HANNSPREE, INC.
www.hannspree.com

Table of Contents

Regulatory Information	3
Description of Warning Symbols	4
Safety Notices	5
Important Safety Instructions	6
Preface	9
Warranty and Service	9
1. Getting Started	11
1.1 Package Contents	11
1.2 Introducing the TV	12
1.2.1 Features	12
1.3 Control Panel	13
1.4 Input and Output Jacks	14
1.5 Remote Control	15
1.6 Inserting the Remote Control Batteries	18
2. Setting up your TV	19
2.1 Basic Connections	19
2.1.1 Power Connection	19
2.1.2 Connecting an Antenna or Cable TV	19
2.2 Connecting External Devices	20
2.2.1 Connecting External Earphones	20
2.2.2 Connecting to AV Devices	21
2.2.3 Connecting a VCR/ STB/ DVD Player Using Component Video	22
2.2.4 Connecting a VCR/ STB/ DVD Player Using Composite Video	22
2.2.5 Connecting a PC using VGA	23
2.2.6 Connecting a PC using DVI	23
2.2.7 Connecting HDMI	24
2.3 Using the TV	25
2.3.1 Turning the TV On and Off	25
2.3.2 Switching Source Signals	25
2.3.3 Performing an Automatic Channel Search	25
2.3.4 Selecting Channels	25
2.3.5 Adjusting the Volume	25
2.3.6 Editing Channel Table or Favorite Channel	26

Table of Contents

3. Adjusting On-Screen Display (OSD) Settings	27
3.1 OSD Setting Menus	28
3.2 Adjusting Picture Settings	28
3.3 Adjusting Audio Settings	29
3.4 Adjusting Channel Settings	30
3.5 Adjusting V-CHIP Settings	31
3.6 Adjusting Setup Settings	32
4. Troubleshooting	33
5. Specifications	34
6. Appendix: Remote Control Guide	36
6.1 Introduction	36
6.1.2 Setting Program Codes	36
6.1.3 Searching Codes	37
6.1.4 Setting Volume Lock	37
6.1.5 Setting Channel Lock	38
6.1.6 Factory Setting Mode	39
6.1.7 Description	41
6.2 Other Descriptions	41
6.2.1 Double Clicking	41
6.2.2 Buttons Information	41
6.2.3 Power-out Protection Capability	41
6.3 Component Program Codes	42
7. Setting the TV on the Wall	49
8. Using the Cable Organizer	50



Regulatory Information

FCC Compliance Statement¹

This device complies with part 15 of the FCC Rules. Operation is subject to the following two conditions: (1) This device may not cause harmful interference, and (2) this device must accept any interference received, including interference that may cause undesired operation.

Additional Information

This equipment has been tested and found to comply with the limits for a Class B digital device, pursuant to part 15 of the FCC Rules. These limits are designed to provide reasonable protection against harmful interference in a residential installation. This equipment generates, uses and can radiate radio frequency energy and, if not installed and used in accordance with the instructions, may cause harmful interference to radio communications. However, there is no guarantee that interference will not occur in a particular installation. If this equipment does cause harmful interference to radio or television reception, which can be determined by turning the equipment off and on, the user is encouraged to try to correct the interference by one or more of the following measures:

- Reorient or relocate the receiving antenna
- Increase the separation between the equipment and receiver
- Connect the equipment into an outlet on a circuit different from that to which the receiver is connected
- Consult the dealer or an experienced technician for help

Warning: The Federal Communications Commission warns that changes or modifications of the equipment not expressly approved by the party responsible for compliance could void your authority to operate the equipment.

DOC Compliance Notice²

This digital apparatus does not exceed the Class B limits for radio noise emissions from digital apparatus as set out in the Radio Interference Regulations of the Canadian Department of Communications. This device complies with Canada ICES-003 Class B.

-
1. applies only to products purchased in the United States of America
 2. applies only to products purchased in Canada

Description of Warning Symbols

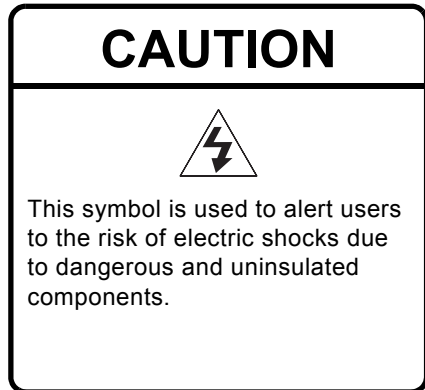
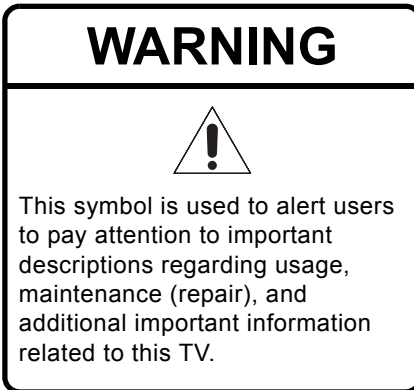
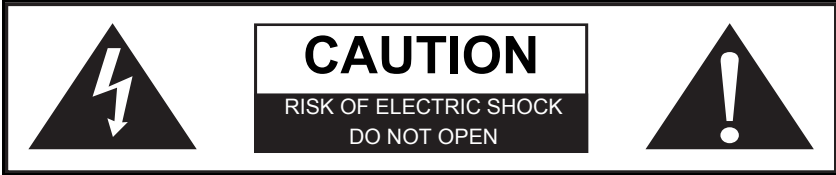

Safety Notices



Installation Safety Notes

Location

Avoid allowing the TV to get prolonged exposure to sunlight or other strong sources of heat. Leave sufficient distance between the TV and the wall to provide enough space for the emission of heat.



WARNING

To reduce the risk of fire or electric shock, do not expose this apparatus to rain or moisture.

Apparatus shall not be exposed to dripping or splashing and no objects filled with liquids, such as vases, shall be placed on the apparatus.



CAUTION

These servicing instructions are for use by qualified service personnel only. To reduce the risk of electric shock, do not perform any servicing other than that contained in the operating instructions unless you are qualified to do so.

Notes:

- **The LCD TV is for entertainment use only and visual display tasks are excluded.**
- **This device uses a VGA connector to connect to a PC. To reduce the influence of main frequency on the source signal, use a VGA monitor cable with ferrite shield.**

Important Safety Instructions

	<ol style="list-style-type: none"> 1. Read these instructions. 2. Keep these instructions. 3. Heed all warnings. 4. Follow all instructions.
	5. Do not use this apparatus near water.
	6. Clean only with dry cloth.
	7. Do not block any ventilation openings. Install in accordance with manufacturer's instructions.
	8. Do not install near any heat sources such as radiators, heat registers, stoves, or other apparatus (including amplifiers) that produce heat.
	<p>9. Do not defeat the safety purpose of the polarized or grounding-type plug. A polarized plug has two blades with one wider than the other. A grounding-type plug has two blades and a third grounding prong. The wide blade or the third prong are provided for your safety. If the provided plug does not fit into your outlet, consult an electrician for replacement of the obsolete outlet.</p> <p>NOTE: Applies to US only.</p>
	10. Protect the power cord from being walked on or pinched, particularly at plugs, convenience receptacles, and the point where they exit from the apparatus.
	11. Only use attachments/accessories specified by the manufacturer.
	12. Use only with the cart, stand, tripod, bracket, or table specified by the manufacturer, or sold with the apparatus. When a cart is used, use caution when moving the cart/apparatus combination to avoid injury from tip-over.

13.	Unplug this apparatus during lightning storms or when unused for long periods of time.
14.	Refer all servicing to qualified service personnel. Servicing is required when the apparatus has been damaged in any way, such as power-supply cord or plug is damaged, liquid has been spilled or objects have fallen into the apparatus, the apparatus has been exposed to rain or moisture, does not operate normally, or has been dropped.
15.	WARNING: To reduce the risk of fire or electric shock, do not expose this apparatus to rain or moisture.
16.	The apparatus shall be connected to a MAINS socket outlet with a protective earthing connection.
17.	Where the MAINS plug or an appliance coupler is used as the disconnect device, the disconnect device shall remain readily operable.
18.	The apparatus should be used in moderate climate.
19.	The apparatus shall not be exposed to dripping or splashing and that no objects filled with liquids, such as vases, shall be placed on the apparatus.

Personal safety

1. To avoid overloading the power supply, never plug too many electrical devices into an outlet, power strip, or extension cable.
 2. Dangerous high-voltage electric power components are located inside the TV. To avoid electric shock, do not disassemble the casing.
 3. Do not place or drop metals, small objects, or flammable materials into the vent of the TV.
 4. If the TV is dropped, falls down, or is otherwise damaged, unplug the power cord immediately and contact an authorized service technician.
 5. If any fluid is sprayed or dropped into the TV, contact an authorized service technician.
 6. The screen of the TV is made of glass. Avoid hitting or scraping it. If the screen is broken, do not touch the broken glass.
 7. Do not allow children to use the TV unattended.
 8. Be careful when disconnecting the power plug. Hold the plug. Do not attempt to disconnect the plug by pulling on the power cord.
-

Installation

1. Do not place the TV in locations where there is excessive steam or dust.
 2. Avoid blocking the TV's vents, do not place the TV on a bed, sofa, carpet, or in a sealed cabinet.
 3. Install the outdoor antenna away from power transmission lines to avoid possible danger.
-



Preface

Thank you for purchasing a Hannspree Liquid Crystal Display Television (LCD TV). Your new TV will allow you to enjoy superior audio and video while enriching your lifestyle with advanced technology.

Please carefully read this manual in its entirety before setting up, using or operating your TV. To ensure the safe and correct installation and operations of the TV, it is important that the safety and operation instructions in this manual are followed.

This instruction manual is designed to assist you in setting up and using the TV. The information in this manual has been carefully checked for accuracy; however, no guarantee is given to the correctness of the contents. The information in this manual is subject to change without notice.

To the extent allowed by applicable law, Hannspree, Inc. (“Hannspree”) shall not be liable for direct, indirect, special, exemplary, incidental or consequential damages arising from any defect or omission in this manual, even if advised of the possibility of such damages in advance.



Warranty and Service

For complete warranty service information, please refer to the “Warranty card” enclosed with your TV.

As an ENERGY STAR[®] Partner, Hannspree has determined that this product meets the ENERGY STAR[®] guidelines for energy efficiency.

Copyright

© Copyright 2009 Hannspree, Inc.

All rights reserved. This manual is protected by copyright and distributed under licenses restricting its use, copying and distribution. No part of this manual may be reproduced in any form by any means without the prior written authorization of Hannspree. The TV described in this manual may include copyrighted software of Hannspree (or other third parties). Hannspree (or other third parties) preserves the exclusive rights for copyrighted software, such as the right to distribute or reproduce the copyrighted software. Accordingly, and to the extent allowed by applicable law, any copyrighted software contained in the product described herein shall not be distributed, modified, reverse engineered, or reproduced in any manner without the prior written authorization of Hannspree (or of other third parties).

The Hannspree logos presented herein are trademarks of Hannspree. All other product names, trademarks or logos mentioned herein are used for identification purpose only, and may be the trademarks or registered trademarks of their respective owners.

The purchase of the product described herein shall not be deemed to grant, either directly or by implication, estoppel or otherwise, any license under the copyrights, patents, patent applications or trademarks of Hannspree, except for the normal, non-exclusive use that arises by operation of law in the sale of a product.

Trademark Notice



Hannspree products incorporate High-Definition Multimedia Interface (HDMI™) technology.

HDMI, the HDMI logo and High-Definition Multimedia Interface are trademarks or registered trademarks of HDMI Licensing LLC.

License Notice and Trademark Acknowledgment



Manufactured under license from Dolby Laboratories. "Dolby" and the double-D symbol are trademarks of Dolby Laboratories.



1.1 Package Contents

Make sure the following components are included in the box. Please contact Hannspree Customer Service immediately if anything is missing or damaged.

- TV
- Power cord
- Remote control and batteries
- User's manual
- Quick start guide
- Warranty card
- Product registration card
- Attention notice card
- Cleaning cloth

1.2 Introducing the TV

You can watch NTSC/ATSC broadcast, cable, or digital television channels, and easily connect a VCR, STB or DVD player to the standard CVBS, S-Video, component, and HDMI input ports (location of these ports depends on model). You can also use the TV as a monitor for your PC by connecting it through the VGA port.

Convenient control buttons located on the TV and a handy remote control let you change channels, adjust the volume, and change display settings through an easy-to-use on-screen display menu system. The built-in stereo speakers provide full rich sound and a convenient audio output port lets you connect to an external audio system or earphones.

1.2.1 Features

- Built-in TV tuner
- Audio/ Video support:
 - PC audio input
 - YPbPr input
 - CVBS input
 - S-Video input
 - 3.5 mm stereo earphone output
 - VGA input
 - HDMI input
 - One set for R/L audio inputs for CVBS/S-Video and the other one for YPbPr.
- On-Screen Display (OSD) menu system
- Built-in stereo speakers
- Digital Noise reduction
- 3D comb filter
- De-interlace Image
- DTV/ Scalar solution
- 3:2/ 2:2 Pull down













Note:

The supporting devices mentioned in this manual may vary on different models.





1.3 Control Panel





Description	Button	Function
Power		Power button. Press to turn the TV on or off.
Input source	INPUT	Press to open the input source list or mark an item on the OSD menu.
Menu	MENU	Press to open the OSD menu.
Channel select	CH ▲	Press to increase the channel number or move upward to the previous item on the OSD menu.
Channel select	CH ▼	Press to decrease the channel number or move downward to the next item on the OSD menu.
Volume adjust	VOL+	Press to increase the volume or move to the right on the OSD menu.
Volume adjust	VOL-	Press to decrease the volume or move to the left on the OSD menu.
Remote IR sensor		Receive incoming remote control commands.
Power/ Standby indicator		Indicate power or standby status.
Speakers		Deliver high-quality sounds.

1.4 Input and Output Jacks

Description	Connector	Function
Power connector	 AC IN	Connect to the included power cord.
HDMI 1 input	 HDMI 1	Connect to an external device, such as a DVD player, set-top box, or a PC's DVI/ HDMI port.
HDMI 2 input	 HDMI 2	Connect to an external device, such as a DVD player, a Set-Top-Box, or a PC's DVI/ HDMI port.
VGA (PC) input	 VGA	Connect to a PC's VGA port.
Audio input (PC)	 PC LINE IN	Connect to a PC's audio port.
Component inputs (audio)		Connect to an external device, such as a VCR, Set-Top-Box, or a DVD player.
Component inputs (video)		Connect to an external device, such as a VCR, Set-Top-Box, or a DVD player.
Earphone output	 EAR PHONE	Connect to earphones or external speakers with built-in amplifiers.
Cable/ Antenna	 VHF / UHF CABLE / ANTENNA	Connect to an antenna or cable TV.
S-Video input	 S-Video	Connect to an external device, such as a VCR, Set-Top-Box, or a DVD player.
Composite inputs		Connect to an external device, such as a VCR, Set-Top-Box, or a DVD player.
SERVICE	 SERVICE	For service only.

1.5 Remote Control

Description	Icon	Function												
Power		Press to turn the TV on or off.												
Input source	INPUT	Press to open the input source list.												
Keypad	<table border="0"> <tr><td>1</td><td>2</td><td>3</td></tr> <tr><td>4</td><td>5</td><td>6</td></tr> <tr><td>7</td><td>8</td><td>9</td></tr> <tr><td>0</td><td></td><td></td></tr> </table>	1	2	3	4	5	6	7	8	9	0			Use to select a channel directly. Press 0-9 to enter the program numbers (press 1 and 0 for channel 10).
1	2	3												
4	5	6												
7	8	9												
0														
Program entry	—	Press this button for entering DTV minor channel.												
Last	LAST 	Press to return to the last channel selected.												
Information	INFO	Press to display program information.												
Menu	MENU	Press to turn the on-screen display (OSD) menu on/ off; confirm the setting.												
Arrows		Press up, down, left or right to scroll through the on-screen display menus.												
Select	OK	Press to confirm your selection.												
Guide channel list	GUIDE	Press to view the Electronic-Programming-Guide screen.												
Return	RETURN	Press to return to the previous menu.												
Select channel	CH ▲ / CH ▼	Press  _{CH} to increase the channel number. Press  _{CH} to decrease the channel number.												
Volume adjust	VOL+ / VOL-	Press VOL + to increase audio volume. Press VOL - to decrease audio volume.												

Description	Icon	Function
Sleep timer	SLEEP 	Press repeatedly to set the sleep time (Sleep off, 15, 30, 45, 60, 90, or 120 minutes). A Sleep Info appears on the middle of the screen to show the remaining time. Cancel the timer by pressing the button to sleep off mode.
Mute	MUTE 	Press to eliminate audio. Press it again or press the volume adjust buttons to restore sound.
Multichannel television sound	MTS 	Press to toggle the audio mode (Mono/ Stereo/ SAP) in ATV or the audio services in DTV.
DVD	DVD	Press to select a programmed DVD player.
AUDIO	AUDIO	Press to select a programmed Audio Receiver/ Amp/ Home Theatre System.
CABLE	CABLE	Press to select a programmed Cable TV set-top box or a satellite TV set-top box.
TV	TV	Press to enter TV mode.
Favorite channels	FAV.	Press to switch to favorite channels. (if no favorite channel was set, "Not Available!" will display on the screen)
Aspect ratio	ASPECT 	Press to adjust the width-to-height ratio of the image with aspect ratio Auto, Full, Normal, Zoom, Zoom-1 and Subtitle.
Close caption	C.C.	Press to open or close the close caption.



CAUTION

- If the remote control is not used for a long period, remove the batteries and store them properly.
- Handle damaged or leaking batteries carefully, and wash hands with soap if they come in contact with leaked chemical fluids.
- If your remote control has two batteries, do not mix new and old batteries, or the life of the new batteries will be shortened. Chemical fluids may leak from the old batteries.
- Danger of explosion if battery is incorrectly replaced. Replace only with the same or equivalent type recommended by the equipment manufacturer. Discard used batteries according to manufacturer's instructions.
- Refer to your local recycling or waste disposal rules and contact a local waste disposal vendor to dispose of used batteries.
- The remote control cover may have a magnet in it, so do not place magnetic sensitive items such as watches, credit cards, or flash media close to the cover.
- Do not use force when pulling the remote control cover open; you may damage the hinge.

Note:

- For best results, use the remote control within a proper distance from the front of the TV. Do not exceed an angle of 30 degrees when pointing at TV.
- The operational distance may be shortened when the signal sensor is directly exposed to strong light.
- Aim the transmitter on the remote control at the signal sensor and ensure that there are no obstacles between them.

1.6 Inserting the Remote Control Batteries

- 1 Open the battery compartment cover at the back of the remote control (A).

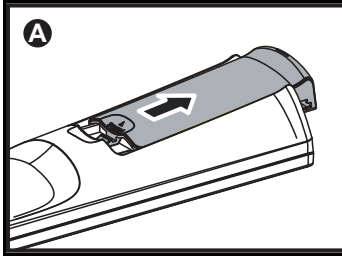

- 2 Insert the batteries paying attention to the polarity markings inside the battery compartment (B).

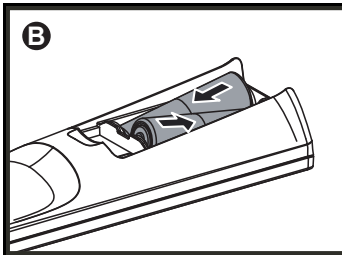

- 3 Close the battery compartment cover (C).

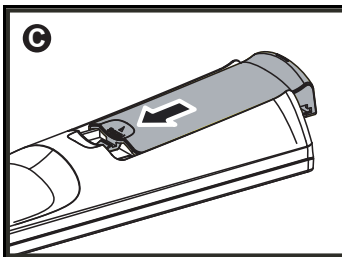

2.1 Basic Connections

2.1.1 Power Connection

- 1 Connect the power cord to the AC IN input jack on the rear of the TV.
- 2 Insert the plug at the other end of the power cord into a power outlet.

2.1.2 Connecting an Antenna or Cable TV

Connect one end of the VHF/UHF (Antenna) or CATV cable to VHF/UHF jack on the rear of the TV.

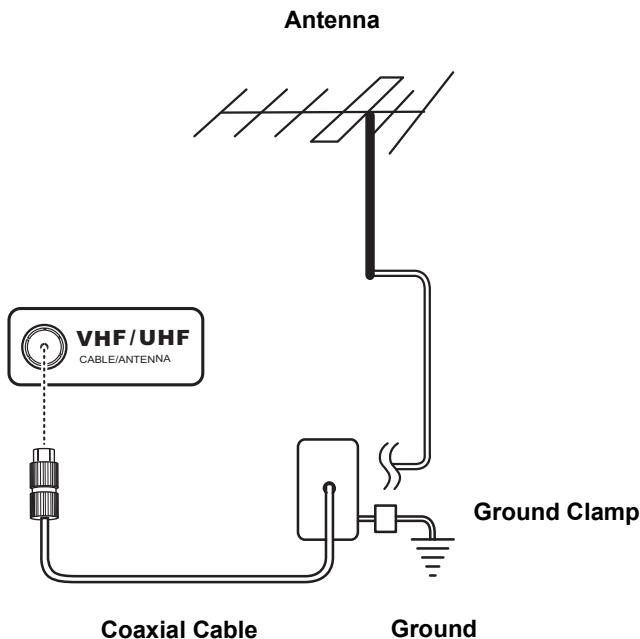
**Note:**

If you cannot receive channels after connecting to an antenna or cable TV line, try scanning for channels.

2.2 Connecting External Devices

Connect external devices such as VCRs, Set-Top-Box, DVD players, video game consoles, earphones, or a PC to the TV using the appropriate ports on the rear of the TV.

2.2.1 Connecting External Earphones

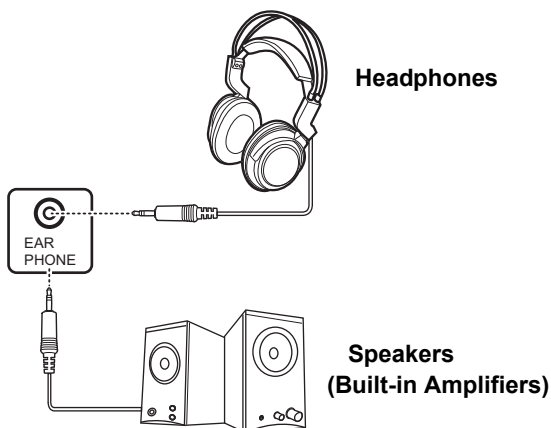

Note:

- External speakers or headphones are not included with the TV.
- The internal TV speakers will not output sound when headphones are plugged in.
- Use external speakers with built-in amplifiers only.
- Only one external device for sound can be connected at a time.

2.2.2 Connecting to AV Devices

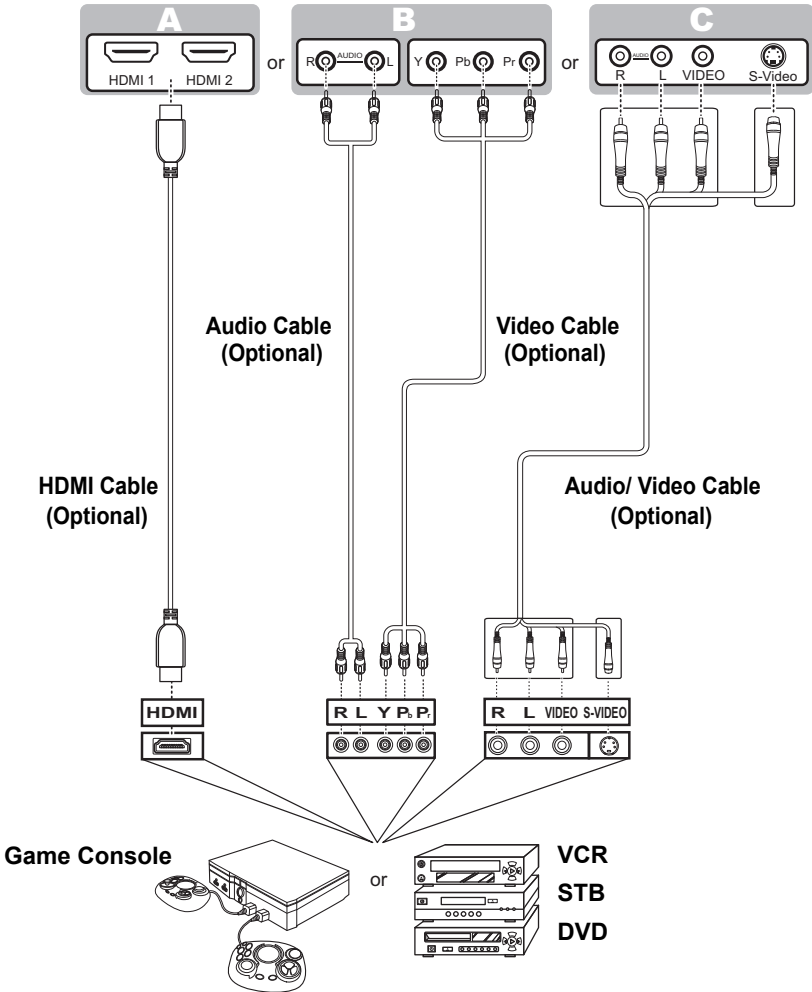

2.2.3 Connecting a VCR/ STB/ DVD Player Using Component Video

Connect the TV to a VCR/ STB/ DVD player using the component video inputs.

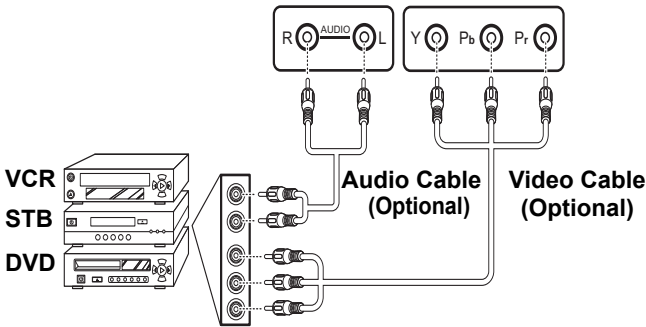

2.2.4 Connecting a VCR/ STB/ DVD Player Using Composite Video

Connect the TV to a VCR/ STB/ DVD player using the composite video input.

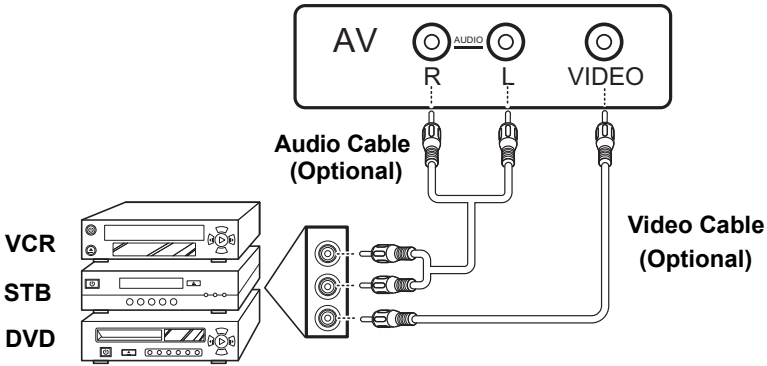

2.2.5 Connecting a PC using VGA

Connect the TV to your PC to use it as the monitor using the VGA port as shown.

- 1 Connect the VGA port of the TV to the VGA output of the PC.
- 2 Connect the PC LINE IN port of your TV to the line out port of the PC to listen to audio from the PC.

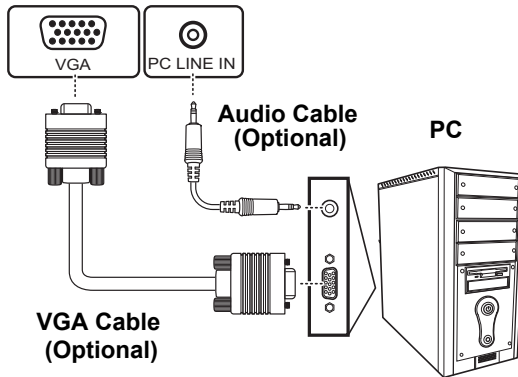

2.2.6 Connecting a PC using DVI

Connect the TV to your PC to use it as the monitor using the DVI port as shown.

- 1 Connect the HDMI 1 or HDMI 2 port of the TV to the DVI output of the PC.
- 2 Connect the PC LINE IN port of your TV to the line out port of the PC of your TV to listen to audio from the PC.

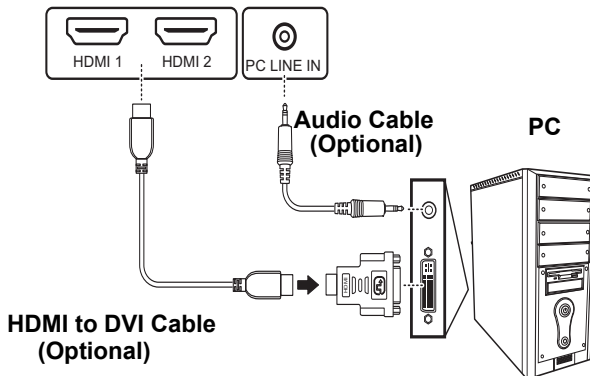

2.2.7 Connecting HDMI

HDMI (High Definition Multimedia Interface) assures that the best video signal is always sent from source to the TV.

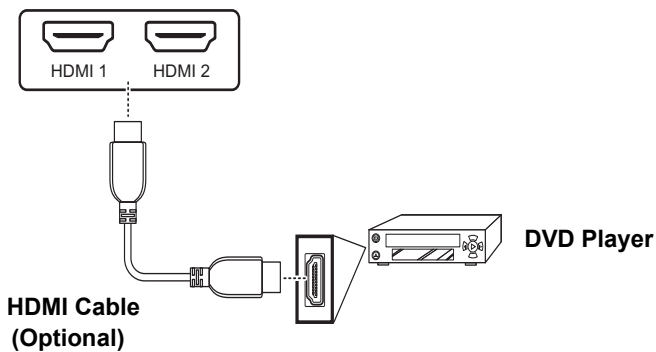

Refer to the following illustration to connect an HDMI device to the TV.

**Note:**

When the HDMI cable is connected, connecting the audio cable is not necessary. However, it is necessary to do so if a HDMI to DVI cable is connected.

2.3 Using the TV

2.3.1 Turning the TV On and Off

- 1 Press  on the control panel or remote control. The power LED indicator on the TV changes from red to green, indicating that the TV is on.
- 2 Press  again. The power LED changes from green to red, indicating that the TV is off.

2.3.2 Switching Source Signals



Press **INPUT** on the control panel or remote control to select the incoming source signal to set TV source for channel search. Press **OK** to confirm.

2.3.3 Performing an Automatic Channel Search



Before using the TV to view programs, you need to activate the channel search first.



- 1 Press **MENU** on the control panel or remote control, then select to enter the Channel menu.
- 2 Select Antenna to set the signal source. (Air or Cable, default is Air)
- 3 Select Auto scan, then Start option.
- 4 Press **OK** on the remote control to run the channel search.

2.3.4 Selecting Channels

- Press **CH▲** on the control panel or  **CH** on the remote control to increase the channel number.
- Press **CH▼** on the control panel or  **CH** on the remote control to decrease the channel number.
- Enter the specific channel number by pressing the number buttons on the remote control.

2.3.5 Adjusting the Volume

- 1 Press **VOL+** on the control panel or  **VOL** on the remote control to increase the volume.
- 2 Press **VOL-** on the control panel or  **VOL** on the remote control to decrease the volume.

-
- 3 Press **MUTE**  to eliminate sounds, and press **MUTE**  again or press the volume buttons to restore the original volume.

2.3.6 Editing Channel Table or Favorite Channel

- 1 Press **MENU** on the control panel or remote control, then select to enter the Channel menu.
- 2 Select Channel List.
- 3 If you want to add or remove channel from channel table, please select the channel and press **OK** to mark "S" column. If you want to add or remove favorite channel, please select the channel and press **OK** to mark "F" column.

3

Adjusting On-Screen Display (OSD) Settings

The On-Screen Display (OSD) menu system provides a quick and simple method to adjust the TV settings. The OSD menu can be accessed through the buttons either on the control panel or the remote control.

Before going to details of each OSD item, you may get acquainted with the placement of the OSD system:

CURRENT MENU:

Displays the title of the currently chosen menu.

ADJUSTABLE ITEMS:

Displays the settings/ values of the adjustable items.

MAIN MENU:

Displays a list of menu items. The chosen item is marked by a different color than other menu items.

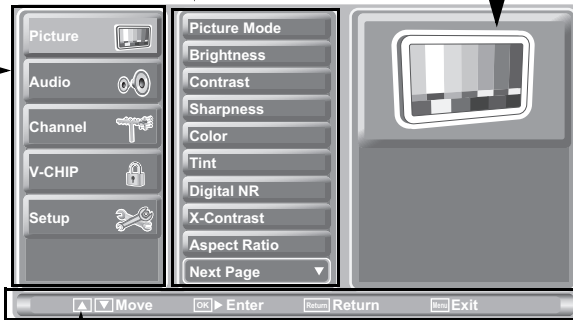

INSTRUCTIONS:

Quick instructions for adjusting the settings.

Function	TV Control Panel	Remote Control
OSD Menu	MENU	MENU
Up	CH ▲	Arrow ^
Down	CH ▼	Arrow v
Increase	VOL +	Arrow >
Decrease	VOL -	Arrow <
Select	INPUT/ VOL+	OK/ Arrow >
Return	MENU/ VOL-	RETURN/ Arrow <

3.1 OSD Setting Menus

Follow the instructions indicated on the bottom of the OSD Function Menu. Press **CH ▲ / CH ▼** on the control panel or **▲ / ▼** arrow keys on the remote control to scroll through the menus. Press **INPUT/ VOL+** on the control panel or **OK** key on the remote control to select an item and then press **MENU/ VOL-** key to exit the OSD menu. The following menus can be set by different adjustment methods.

3.2 Adjusting Picture Settings

- 1 Press **MENU** to enter the OSD Main Menu screen.
- 2 Press **▲ / ▼** on the remote control or **CH▲ / CH▼** on the control panel to select Picture menu.
- 3 Press **> / OK** on the remote control or **INPUT/ VOL+** on the control panel to enter the Picture menu.

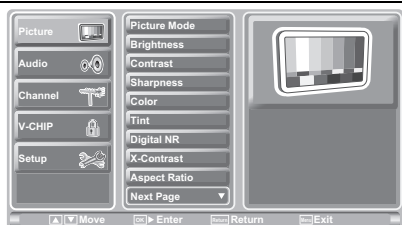

- 4 Press **▲ / ▼** on the remote control or **CH▲ / CH▼** on the control panel to select an item.
- 5 Press **> / OK** on the remote control or **INPUT/ VOL+** on the control panel to enter the item.
- 6 Press **< / >** on the remote control or **VOL+ / VOL-** on the control panel, to change the scales or press **OK** on the remote control or **INPUT/ VOL+** on the control panel to mark an item.
- 7 Press **RETURN** to return to the Picture menu.
- 8 Press **MENU/ VOL-** to exit the Picture menu.
- 9 The Picture menu can be used to adjust the **Picture mode, Brightness, Contrast, Sharpness, Color, Tint, Digital NR, X-Contrast, Aspect Ratio, Color Temp** and **Recall** settings. **Brightness, Contrast, Sharpness, Color, and Tint** are only available for adjustments if you select **User** in Picture Mode. Press **< / >** on the remote control or **VOL+ / VOL-** on the control panel to adjust these settings.
 - The Picture Mode can be set to **Vivid, Standard, Movie, or User**.
 - The Digital NR can be set to **Off, Weak, Medium, or Strong**.
 - The X-Contrast can be set to **Off** or **On**.
 - The Aspect Ratio can be set to **Full, Normal, Zoom, Subtitle, Auto, Zoom-1, Wide**.
 - The Color Temp can be set to **Warm, Standard, or Cool**.
 - The Recall can be used to reset the original factory settings.

Note:

The items available on the OSD may vary depending on the input signal source.

3.3 Adjusting Audio Settings

- 1 Press **MENU** to enter the OSD Main Menu screen.
- 2 Press **▲ / ▼** on the remote control or **CH▲ / CH▼** on the control panel to select Audio menu.
- 3 Press **➤ / OK** on the remote control or **INPUT/ VOL+** on the control panel to enter the Audio menu.



- 4 Press **▲ / ▼** on the remote control or **CH▲ / CH▼** on the control panel to select an item.
- 5 Press **➤ / OK** on the remote control or **INPUT/ VOL+** on the control panel to enter the item.
- 6 Press **◀ / ▶** on the remote control or **VOL+ / VOL-** on the control panel to change the scales or press **OK** on the remote control or **INPUT/ VOL+** on the control panel to mark an item.
- 7 Press **RETURN** to return to the Audio menu.
- 8 Press **MENU/ VOL-** to exit the Audio menu.
- 9 The Audio menu can be used to adjust the **Audio Mode**, **Equalizer**, **Balance**, **MTS (ATV only)**, **Auto Volume (ATV only)**, and **Recall** settings. **Equalizer** is available for adjustment only if you select **User** in Audio Mode.
 - The Audio Mode can be set to **Dynamic**, **Standard**, **Soft**, or **User**.
 - Press **◀ / ▶** on the remote control or **VOL+ / VOL-** on the control panel to adjust the scales in Equalizer and Balance.
 - The MTS can be set to **Stereo**, **Mono**, or **SAP**.
 - The Auto Volume can be set to **Off** or **On**.
 - The Recall can be used to reset the original factory settings.

Note:

The items available on the OSD may vary depending on the input signal source.

3.4 Adjusting Channel Settings

- 1 Press **MENU** to enter the OSD Main Menu screen.
- 2 Press **▲ / ▼** on the remote control or **CH▲ / CH▼** on the control panel to select Channel menu.
- 3 Press **➤ / OK** on the remote control or **INPUT/ VOL+** on the control panel to enter the Channel menu.
- 4 Press **▲ / ▼** on the remote control or **CH▲ / CH▼** on the control panel to select an item.
- 5 Press **➤ / OK** on the remote control or **INPUT/ VOL+** on the control panel to enter the item.
- 6 Press **◀ / ▶** on the remote control or **VOL+ / VOL-** on the control panel to change the scales or press **OK** on the remote control or **INPUT/ VOL+** on the control panel to mark an item.
- 7 Press **RETURN** to return to the Channel menu.
- 8 Press **MENU/ VOL-** to exit the Channel menu.
- 9 The Channel menu can be used to perform a channel search and edit channel list (see "Performing an Automatic Channel Search" on page 25 and "Editing Channel Table or Favorite Channel" on page 26).
 - The Antenna can be set to **Air** or **Cable**.
 - The Scan Mode can be set to **Auto**, **Analog**, or **Digital**.
 - The Auto Scan can be set to **Auto**, **Standard**, **HRC**, or **IRC**.



Note:

The Channel settings are available when the signal is set to TV source.

3.5 Adjusting V-CHIP Settings

- 1 Press **MENU** to enter the OSD Main Menu screen.
- 2 Press **▲ / ▼** on the remote control or **CH▲ / CH▼** on the control panel to select V-CHIP menu.
- 3 Press **➤ / OK** on the remote control or **INPUT/ VOL+** on the control panel to enter the V-CHIP menu.
- 4 Enter the password to activate the menu of V-CHIP.
- 5 Press **▲ / ▼** on the remote control or **CH▲ / CH▼** on the control panel to select an item.
- 6 Press **➤ / OK** on the remote control or **INPUT/ VOL+** on the control panel to enter the item.
- 7 Press **OK** on the remote control or **INPUT/ VOL+** on the control panel to mark an item.
- 8 Press **RETURN** to return to the V-CHIP menu.
- 9 Press **MENU/ VOL-** to exit the V-CHIP menu.
- 10 The V-CHIP menu can set **Change Password**, **Lock**, **Unrated Block**, **MPAA** , **TV Rating**, **Can. English**, and **Can. French** settings.

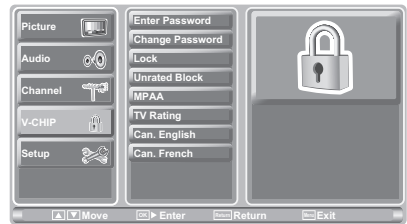

Note:

Super Password

Step 1: Input password "7071" (But OSD will display "Error !".)

Step 2: Input password "8512". Then OSD will display "Correct !" and V-CHIP is unlocked.

3.6 Adjusting Setup Settings

- 1 Press **MENU** to enter the OSD Main Menu screen.
- 2 Press **▲ / ▼** on the remote control or **CH▲ / CH▼** on the control panel to select Setup menu.
- 3 Press **➤ / OK** on the remote control or **INPUT/ VOL+** on the control panel to enter the Setup menu.
- 4 Press **▲ / ▼** on the remote control or **CH▲ / CH▼** on the control panel to select an item.
- 5 Press **➤ / OK** on the remote control or **INPUT/ VOL+** on the control panel to enter the item.
- 6 Press **◀ / ▶** on the remote control or **VOL+ / VOL-** on the control panel to change the scales or press **OK** on the remote control or **INPUT/ VOL+** on the control panel to mark an item.
- 7 Press **RETURN** to return to the Setup menu.
- 8 Press **MENU/ VOL-** to exit the Setup menu.
- 9 The Setup menu can be used to adjust the **Setup Wizard, OSD Language, OSD Time, Clock Mode, Clock Set, Time Zone, Sleep Time, Back Light, CC Mode, Analog CC,** and **CC Style** settings. Clock Set is only available for adjustments when Clock Mode is set to **Manual**; Clock Mode can be set to **Auto** or **Manual**.
 - Setup Wizard can be used to set up OSD Language, Clock Mode, Time Zone, TV RF Source, and channel scan.
 - The five available OSD languages are: **English, Spanish, French, Traditional Chinese,** and **Simplified Chinese**.
 - OSD Time can be set to **10 secs, 20 secs, 30 secs,** and **60 secs**.
 - The Time Zone can be set to **Eastern, Central, Mountain, Pacific, Alaska,** and **Hawaii**.
 - The Sleep Time can be set to **Sleep Off, 15 mins, 30 mins, 45 mins, 60 mins, 90 mins,** and **120 mins**.
 - Press **◀ / ▶** on the remote control to move the scale in the Back Light settings.
 - To change settings in CC Mode, Analog CC, Digital CC, and CC Style, press **▲ / ▼** on the remote control to select the items and press **➤ / OK** to activate the item.



Note:

The items available on the OSD may vary depending on the input signal source.

Situation	Solution
No picture and sound.	<ul style="list-style-type: none"> • Connect the power cord properly. • Check if the power LED is on or not. • Press  on the control panel or remote control. • press INPUT to cycle through connected video sources. • Press channel up or channel down to switch to other TV channels. • Make sure all cables are connected properly.
No picture, or poor picture, sound is OK.	<ul style="list-style-type: none"> • Check the antenna and cable connections. • Adjust the brightness in the OSD menus.
Picture is not in color.	<ul style="list-style-type: none"> • Adjust the saturation in the OSD menus.
Picture is OK, no sound.	<ul style="list-style-type: none"> • Make sure the source device is functioning properly. • Make sure the audio cable is connected securely. • Turn the mute off. • Press volume up on the control panel or remote control.
One of the speakers has no sound.	<ul style="list-style-type: none"> • Adjust the balance in the OSD Audio menu.
Cannot receive some TV channels using cable TV.	<ul style="list-style-type: none"> • Try the Auto Scan function in the OSD Channel menu.
Want to reset TV settings.	<ul style="list-style-type: none"> • Use the Setup Wizard function in the OSD Setup menu.
Cannot operate menus.	<ul style="list-style-type: none"> • If OSD items are colored in gray, the system is in a state such that those settings are not available.
Screen image turns over.	<ul style="list-style-type: none"> • Make sure the video signal cable is connected properly.
Snow appears on the screen.	<ul style="list-style-type: none"> • Adjust the location of the antenna, placing it far from roads or sources of interference. • Check the antenna and the video signal line connections.
Blurred or overlapped images.	<ul style="list-style-type: none"> • Adjust the sharpness setting. • Choose programs with high quality signals. • Adjust the direction of the antenna or change the video signal cable.
Remote control doesn't work.	<ul style="list-style-type: none"> • Make sure the battery is inserted correctly. • Replace the battery with a new one. • Make sure the TV power cord is plugged in securely. • Make sure the path between the remote control and the sensor is clear. • Try operating the remote control at a closer distance to the TV.

LCD Panel Size	28 inch TFT	
Screen Format	16:10	
Panel Resolution	1920 (H) x 1200 (V)	
TV System	ATV: NTSC	DTV: ATSC
Video System	HDMI Input x 2	
	YPbPr Input x 1	
	S-Video Input x1	
	Composite Input x 1	
	VGA (PC) Input x 1	
	Tuner Input x 1	
Audio System	AV/S-Video: (RCA x 1) R/L in	
	HDTV: (RCAx1) R/L in	
	HDMI: HDMI1/HDMI2	
	PC Audio in: Phone jack (Green)	
	Audio out: Earphone jack (Pink)	
	Analog: MTS	Digital: AC3
	EQ	
Built-in Stereo Amplifier Output	10W+10W	
ACInput	100V~240V / 50Hz~60Hz	
Power Consumption	70W (Typical)	
Standby Power Consumption (W)	< 1 (W)	
AC Power Supply (Vac)	100~240	
Dimension W x H x D	672.2mm x 516.5mm x 190mm	
Weight	G.W. 10.85 Kg	

PC Mode Support Timing

Mode	Resolution (active dot)	Horizontal Frequency (KHz)	Vertical Frequency (Hz)	Nominal Pixel Clock (MHz)	VGA	DVI to HDMI
VGA	640x480@60Hz	31.469	59.941	25.175	V	V
SVGA	800x600@60Hz	37.879	60.317	40.000	V	V
XGA	1024x768@60Hz	48.363	60.004	65.000	V	V
SXGA	1280x1024@60Hz	63.981	60.020	108.000	V	V
WXGA+	1440x900@60Hz	55.935	59.887	106.500	V	V
WSXGA+	1680x1050@60Hz	65.290	59.954	146.250	V	V
WUXGA	1920x1200@60Hz	74.083	60.000	154.000	V	V

Video Mode Support Timing

Resolution (active dot)	HDMI	YPbPr
640x480p@60Hz	V	
720x480i@60Hz		V
720x480p@60Hz	V	V
1280x720p@60Hz	V	V
1920x1080i@60Hz	V	V
1920x1080p@60Hz	V	V

6.1 Introduction

The electronic equipment type switch buttons are used for switching the current electronic equipment type on the remote control.

The remote control includes 4 electronic equipment types: DVD, AUDIO, CABLE and TV.

The remote control keypad matrix includes 4 electronic equipment type switch buttons (DVD, AUDIO, CABLE and TV). If switching the current electronic equipment is desired, just press the button of the electronic equipment type you wish to switch to, e.g., press the TV button for TV; the corresponding indicator light will come on for 2 seconds then it goes off, and now the current electronic equipment mode has been switched to TV.

6.1.2 Setting Program Codes

Electronic equipment code setting mode is used for setting electronic equipment codes for various types of electronic equipment. Electronic equipment codes are 4 digits. Electronic equipment codes can be looked up in the electronic equipment code list of the appendix.

Electronic equipment code setting mode has the following operating procedures:

1. Select a 4-digit code from the list (start from the first code if more than one).
2. Select the desired corresponding mode of electronic equipment type; for example, DVD players.
3. Press DVD button. The indicator light will come on for 2 seconds then it goes off; after 3 seconds, the indicator light will come on again, showing that the setting mode has been entered.
4. Hold the electronic equipment button, while pressing digit keys corresponding to the electronic equipment code in sequence. The indicator light will flash once each time when a digit was inputted, and if the indicator light does not come on again after going off, the input code is valid; if the indicator light comes on again after going off for 2 seconds, the code setting is failed, and users will be prompted to input other electronic equipment codes.
5. During the setting process, releasing the electronic equipment button exits the setting mode immediately without changing the status prior to setting.

6. During the setting process, only digit keys '0' through '9' are valid inputs, while other buttons are deemed invalid and do not affect the code setting. For example, inputting "02" then pressing RETURN does affect the "02" already input.

6.1.3 Searching Codes

If the desired electronic equipment code for setting can not be found on the list in the appendix, try to use the code-searching function with operating procedures as follows:

1. Press the corresponding electronic equipment button. The indicator light will come on for 2 seconds then it goes off; after 3 seconds, the indicator light will come on again, showing that the setting mode has been entered.
2. Hold the electronic equipment button while pressing POWER, then input mode codes 9-9-9 in sequence. If the indicator light does not come on again after going off, the code setting is valid; otherwise the indicator light comes on again after going off for 2 seconds, prompting user to re-enter mode codes.
3. If setting is successful, the electronic equipment code-searching state is entered upon releasing the electronic equipment button. The POWER signal of all manufacturers' codes under the current electronic equipment mode is then transmitted automatically every 5 seconds.
4. During search, the indicator light will flash when the POWER signal of each electronic equipment is transmitted. When one cycle of code-searching is complete, the indicator light will come on for 2 seconds before going off, exiting search mode automatically.
5. Pressing CH+/CH- during search transmits the next/previous electronic equipment POWER signal without waiting for 5 seconds, and resets the timer to trigger another 5 seconds interval.
6. Pressing POWER during search exits search mode without saving the new electronic equipment code; pressing OK during search saves the most recently searched electronic equipment code and then exits search mode.
7. Buttons other than POWER, OK, and CH+/CH- are not functional during search.

6.1.4 Setting Volume Lock

Operating procedures are as follows:

1. Press the corresponding electronic equipment button. The indicator light will come on for 2 seconds then it goes off; after 3 seconds, the indicator light will come on again, showing that the setting mode has been entered.
2. While holding the electronic equipment button, press VOL+ twice consecutively to assign volume lock to that electronic equipment (meaning the volume buttons will only transmit code values to the assigned electronic equipment even under other electronic equipment modes). The indicator light then goes off and setting mode is exited.
3. While holding the electronic equipment button, press VOL- twice consecutively to cancel volume lock under current mode (for example, if volume lock was set under TV mode and you wish to transmit code values under current DVD mode, just perform this unlock operation, while those electronic equipment modes not operated still have volume locked up). The indicator light then goes off and setting mode is exited.
4. During the setting process, releasing the electronic equipment button exits the setting mode immediately without changing the status prior to setting.
5. Buttons other than VOL+/VOL- are not functional during search. Volume buttons include VOL+, VOL- and MUTE.

6.1.5 Setting Channel Lock

Operating procedures are as follows:

1. Press the corresponding electronic equipment button. The indicator light will come on for 2 seconds then it goes off; after 3 seconds, the indicator light will come on again, showing that the setting mode has been entered.
2. While holding the electronic equipment button, press CH+ twice consecutively to assign channel lock to that electronic equipment (meaning the channel buttons will only transmit code values to the assigned electronic equipment even under other electronic equipment modes). The indicator light then goes off and setting mode is exited.
3. While holding the electronic equipment button, press CH- twice consecutively to cancel channel lock under current mode (for example, if channel lock was set under TV mode and you wish to transmit code values under current CABLE mode, just perform this unlock operation, while those electronic equipment modes not so operated still have channel locked up). The indicator light then goes off and setting mode is exited.

4. During the setting process, releasing the electronic equipment button exits the setting mode immediately without changing the status prior to setting.
5. Buttons other than CH+/CH- are not functional during search. Channel buttons include CH+ and CH-.

6.1.6 Factory Setting Mode

Factory setting operation procedures are as follows:

1. Press the corresponding electronic equipment button. The indicator light will come on for 2 seconds then it goes off; after 3 seconds, the indicator light will come on again, showing setting mode has been entered.
2. While holding the electronic equipment button, first press < (left arrow), then press OK. The indicator then goes off and setting mode is exited, showing factory setting has been restored.
3. During the setting process, releasing the electronic equipment button exits the setting mode immediately without changing the status prior to setting.
4. Pressing any of the electronic equipment buttons to enter factory setting operation mode.
5. The default current electronic equipment is TV upon first power-on.

Electronic equipment	Code	Note
TV	1001	Provided by manufacturer
CABLE	--	Transmit TV code
AUDIO	--	Transmit TV code
DVD	--	Transmit TV code

6. Default volume lock setting:

Electronic equipment	VOL+, VOL- and Mute	Note
TV	Transmit TV code	Provided by manufacturer
CABLE	Transmit CABLE code	Unlocked
AUDIO	Transmit AUDIO code	Unlocked
DVD	Transmit DVD code	Unlocked

7. Default channel lock setting:

Electronic equipment	CH+ and CH-	Note
TV	Transmit TV code	Provided by manufacturer
CABLE	Transmit CABLE code	Unlocked
AUDIO	Transmit AUDIO code	Unlocked
DVD	Transmit DVD code	Unlocked

Note:

Each re-powering restores factory setting, and all electronic equipment modes transmit TV-mode infrared (IR) signal until being set up through code setting. For example, setting the electronic equipment code of CABLE as '0001' stops transmitting TV code, whereas AUDIO and DVD continue to transmit TV code.

6.1.7 Description

There is no multi-function code setting operation under TV mode but a fixed code for the TV manufacturer. Therefore, code setting and code-searching functions are disabled under this mode; other functions such as volume lock, channel lock and code display are operable.

6.2 Other Descriptions

6.2.1 Double Clicking

At any time, only when a single button is pressed, the corresponding code is just output. Two or more buttons simultaneously pressed do not output any code.

6.2.2 Buttons Information

Except TV equipment, all the buttons on remote controls corresponding to other electronic equipments (AUDIO, CABLE, and DVD) are not necessarily functional, but most of those remote controls only include power control, channel control, volume control, etc.

6.2.3 Power-out Protection Capability

During battery replacement, all settings are only maintained by external capacitors. Data therefore may be lost after power-out, and factory setting will be restored.

6.3 Component Program Codes

Setup Code for VCR's	
ABC	2102
Admiral	2012, 2022
Aiko	2025
Aiwa	2005, 2027
Alienware	2102
America Action	2025
American High	2004
Amoisonic	2027
Anam	2020, 2005, 2024, 2025
Anam National	2020
Asha	2024
Audiovox	2005, 2025
Beaumarck	2024
Bell & Howell	2017
Broksonic	2021, 2018, 2022, 2001, 2027
Calix	2005
Cannon	2004
Carver	2016
CCE	2015, 2025
Changhong	2012, 2016
Citizen	2005, 2025
Colt	2015

Setup Code for VCR's	
Craig	2005, 2011, 2024, 2015
Curtis Mathes	2913, 2004, 2020
Cybernex	2024
CyberPower	2102
Daewoo	2010, 2017, 2025
Dell	2102
Denon	2008
Direc TV	2059
Durabrand	2007, 2006
Electrohome	2005
Electroponic	2005
Emerex	2002
Emerson	2004, 2005, 2021, 2024, 2010, 2018, 2009, 2022, 2001, 2025, 2027
Fisher	2011, 2017
Fuji	2004, 2003
Fujitsu	2010
Gateway	2102
GE	2013, 2004, 2024
General	2010
Go Video	2026

Setup Code for VCR's	
GoldStar	2005, 2022, 2006, 2023
HaoJie	2024
Harman/ Kardon	2016, 2006
Harwood	2015
Hewlett Packard	2102
HI-Q	2011
Hitachi	2005, 2008
Howard Computers	2102
HP	2102
Hughes Network Systems	2008, 2059
iBUYPOWER	2102
JVC	2010, 2014
KEC	2005, 2025
Kenwood	2014, 2006
KLH	2015
Kodak	2004, 2005
Kolin	2009
LG	2005, 2010, 2008, 2022, 2006
Logik	2015
LXI	2005
Magnavox	2004, 2007, 2016

Setup Code for VCR's	
Magnin	2024
Marantz	2004, 2016
Marta	2005
Matsushita	2004, 2020
Media Center PC	2102
MEI	2004
Memorex	2004, 2020, 2005, 2012, 2007, 2011, 2024, 2017, 2022, 2027
MGA	2024, 2009
MGN Technology	2024
Microsoft	2102
Mind	2102
Minolta	2008
Mitsubishi	2014, 2009
Motorola	2004, 2012
MTC	2024
Multitech	2015
NEC	2004, 2005, 2012, 2017, 2014, 2006
Newave	2005
Nikko	2005
Noblex	2024
Northgate	2102

Setup Code for VCR's	
Olympus	2004
Optimus	2087, 2020, 2005, 2012, 2017, 2026
Orion	2021, 2022, 2001, 2027
Panasonic	2087, 2004, 2020, 2043, 2023
Penney	2004, 2005, 2024, 2008, 2006
Pentax	2008
Philco	2004, 2027
Philips	2004, 2016, 2059, 2044
Pilot	2005
Pioneer	2008, 2014
Polk Audio	2016
Profitronic	2024
Proscan	2013
Protec	2015
Puslar	2007
Qisheng	2013
Quasar	2004, 2020
Radix	2005
Randex	2005

Setup Code for VCR's	
RCA	2013, 2004, 2024, 2008, 2077
Realistic	2004, 2005, 2012, 2011, 2017
Replay TV	2043
Runco	2007
Sampo	2005, 2012
Samsung	2024, 2010, 2026
Sanky	2012, 2007
Sansui	2014, 2022, 2027
Sanyo	2011, 2024, 2017
Scolt	2021, 2010, 2018, 2009
Sears	2004, 2005, 2011, 2008, 2017
Sharp	2012, 2022
Shintom	2015
Shogun	2024
Singer	2015
Sonic Blue	2043
Sony	2004, 2002, 2003, 2048, 2102
STS	2008
Sylvania	2004, 2016, 2009

Setup Code for VCR's	
Tashiko	2005
Tatung	2010, 2014
Technics	2004, 2020
Teco	2004, 205, 2012, 2006
Teknika	2004, 2005
Tivo	2048, 2044, 2098, 2059
TMK	2024
Toshiba	2010, 2008, 2014, 2009, 2098, 2079, 2102
Totevision	2005, 2024
Touch	2102
Unitech	2024
Vector	2010
Vector Research	2006
Victor	2014
Video Concepts	2010
Videomagic	2005
Vidosonic	2024
Wards	2013, 2004, 2012, 2011, 2016, 2024, 2008, 2015
White Westinghouse	2022, 2015

Setup Code for VCR's	
XR-1000	2004, 2015
Yamaha	2006

Setup Code for DVD's	
Aiwa	2049
Akai	2062
Allegro	2076
Apex Digital	2053, 2058, 2067, 2086, 2066, 2084
Blaupunkt	2058
Blue Parade	2039
Broksonic	2055
Changhong	2046, 2086
CineVision	2076
Coby	2090
Curtis Mathes	2091
CyberHome	2082, 2081, 2094, 2070, 2093
Daewoo	2073, 2097, 2076
Denon	2028
DVD2000	2031
Emerson	2042, 2054
Enterprise	2042
Funai	2054
Gateway	2096, 2088
GE	2032, 2058

Setup Code for DVD's	
Go Video	2060, 2073, 2092, 2063, 2089, 2076, 2100
Greenhill	2058
Harman/Kardon	2041, 2057
Hitachi	2040, 2052
Hiteker	2053
Initial	2058
Integra	2046
JBL	2057
JVC	2038, 2045, 2075
Kenwood	2028, 2035
KLH	2085, 2080, 2095
Koss	2051
Lasonic	2068
LG	2042, 2076, 2069
Lite-ON	2096, 2085
Loewe	2030
Magnavox	2029, 2036, 2054
Marantz	2036
Memorex	2055
Microsoft	2032
Mintek	2058
Mitsubishi	2099, 2031
Nesa	2058

Setup Code for DVD's	
Norcent	2078
Onkyo	2029, 2046, 2064
Oritron	2051
Panasonic	2028, 2101
Philips	2029, 2036, 2050
Pioneer	2033, 2039
Polaroid	2090, 2086
Polk Audio	2036
Portland	2062
Proscan	2032
Qwestar	2051
RCA	2032, 2039, 2058, 2072
Rio	2076
Rotel	2045
Sampo	2061, 2056
Samsung	2028, 2040, 2089, 2071
Sansui	2055
Sanyo	2055
Sharp	2047, 2061
Sharper Image	2093
Sherwood	2062
Shinco	2058
Shinsonic	2034
Sonic Blue	2076, 2092

Setup Code for DVD's	
Sony	2034, 20864, 2083
SVA	2085
Sylvania	2054
Symphonic	2054
Teac	2058
Technics	2028
Theta Digital	2039
Toshiba	2029, 2055
V, Inc.	2019
Urban Concepts	2029
Xbox	2032
Yamaha	2028, 2036, 2037
Zenith	2029, 2042, 2076

Setup Code for Cable	
ABC	0002, 0003, 0006
Americast	0039
Bell & Howell	0006
Bell South	0039
Clearmaster	0038
ClearMax	0038
Coolmax	0038
Daeryung	0059, 0037, 0020, 0003

Setup Code for Cable	
Digi	0024
Diector	0019
Dumont	0024
Gehua	0019
General Instrument	0019, 0033, 0015, 0002, 0006
GoldStar	0010
Hamlin	0004, 0014
Hitachi	0006
Jerrold	0019, 0033, 0015, 0002, 0005, 0006
KNC	0003
LG	0010
Memorex	0001
Motorola	0019, 0033, 0015, 0046, 0050
MultiVision	0005
Pace	0059, 0012
Panasonic	0001, 0003, 0008
Panther	0024
Paragon	0001
Philips	0017, 0049
Pioneer	0059, 0037, 0010, 0022
Pulsar	0001
Quasar	0001
RadioShack	0038

Setup Code for Cable

Regal	0016, 0014
Runco	0001
Samsung	0001, 0010
Scientific Atlanta	0059, 0037, 0020, 0003
Sony	0041
Starcom	0002, 0006
Supercable	0015
Supermax	0038
Tocom	0005
Torx	0002
Toshiba	0001
Trans PX	0015
Tristar	0038
TS	0002
V2	0038
Viewmaster	0038
Vision	0038
Vortex View	0038
Zenith	0001, 0021, 0039

Setup Code for Satellite

AlphaStar	0030
Chaparral	0011
Crossdigital	0043

Setup Code for Satellite

DirecTV	0018, 0023, 0025, 0044, 0013, 0029, 0057, 0028, 0034, 0058, 0060, 0043, 0007, 0051, 0056, 0053, 0052, 0042
Dish Network System	0040, 0031, 0054
Dishpro	0040, 0031, 0054
Echostar	0040, 0031, 0054
Expressvu	0031
GE	0023
General Instrument	0036
GOL	0031
Hisense	0055
Hitachi	0034
HTS	0031
Hughes Network Systems	0044, 0029, 0057, 0053
I-Lo	0055
JVC	0031
LG	0052, 0045
Magnavox	0028, 0027
Memorex	0028
Mitsubishi	0029
Motorola	0036
Next Level	0036

Setup Code for Satellite

Panasonic	0013, 0026
Paysat	0028
Philips	0044, 0029, 0057, 0028, 0060, 0027, 0007, 0053
Proscan	0018, 0023
Proton	0055
RadioShack	0036
RCA	0018, 0023, 0035, 0009, 0051
Samsung	0047, 0043, 0042
Sony	0025, 0056
Star Choice	0036
Tivo	0044, 0053
Toshiba	0029, 0057, 0032, 0048
Ultimate TV	0056, 0051
Uniden	0028, 0027
US Digital	0055
USDTV	0055
Voom	0036
Zenith	0058

Setup Code for CD

Aiwa	3019
Burmester	3027
California Audio Labs	3004

Setup Code for CD	
Carver	3019, 3022
Dkk	3001
DMX Electronics	3019
Dynamic Bass	3022
Fisher	3022
Garrard	3027
Genexxa	3005
Harman/Kardon	3019, 3020
Hitachi	3005
Integra	3013
JVC	3009
Kenwood	3030, 3003, 3007, 3006, 3023
Krell	3019
Linn	3019
Magnavox	3019
Marantz	3030, 3004, 3019
MCS	3004
Miro	3001
Mission	3019
MTC	3027
NSM	3019
Onkyo	3013
Optimus	3001, 3005, 3007, 3027, 3022

Setup Code for CD	
Panasonic	3004
Parasound	3027
Philips	3030, 3019
Pioneer	3038, 3005
Polk Audio	3019
Proton	3019
QED	3019
Quad	3004
RCA	3038, 3005, 3027, 3022, 3008
Realistic	3027, 3022
Rotel	3019, 3027
SAE	3019
Sansui	3019
Sanyo	3022
SAST	3049
Sharp	3007
Silsonic	3006
Sonic Frontiers	3019
Sony	3028, 3001, 3012
TAG McLaren	3019
Tascam	3027
Teac	3027
Technics	3004
Victor	3009
Wards	3019, 3008

Setup Code for CD	
Yamaha	3006
Zonda	3019

Setup Code for Audio Amp's	
Bose	3033
GE	3011
JVC	3059
NEC	3024
Optimus	3026
Realistic	3026
Shure	3024
Sony	3034
Soundesign	3011
Victor	3059
Wards	3011
Yamaha	3025, 3016

Setup Code for Audio Amp / Tuner's	
ADC	3029
Aiwa	3052, 3015
Anam	3057, 3039
Audiotronic	3042
Bose	3043
Capetronic	3027

Setup Code for Audio Amp / Tuner's	
Carver	3042
Denon	3051, 3040
Fonmix	3051
Harman/ Kardon	3014
Hitachi	3047
Integra	3017
JBL	3014
JVC	3010
Kenwood	3050, 3056
KLH	3053
Magnavox	3042, 3046, 3029
Marantz	3042, 3046
Onkyo	3035, 3017
Optimus	3036, 3018, 3002, 3031, 3029
Proscan	3044
Qisheng	3057
RCA	3036, 3057, 3044, 3029, 3039
Silsonic	3021
Sony	3037, 3054, 3045, 3058
Soundesign	3032
Stereophonics	2025
Sunfire	3050

Setup Code for Audio Amp / Tuner's	
Teac	3049
Technics	3043, 3055
Thorens	3042
Victor	3010
Wards	3002
Yamaha	3021, 3048, 3041

Setting the TV on the Wall

Disassembling the stand base:

- 1 Disconnect all the cables and cords from the TV to prevent breakage.
- 2 Carefully place the TV face down on a soft and flat surface (blanket, foam, cloth, etc) to prevent any damage to the TV.
- 3 Squeeze the sides to release the retaining plastic tabs and pull the stand cover off.
- 4 Remove the six (6) screws so that the stand base can be removed.
- 5 Gently remove the stand base.

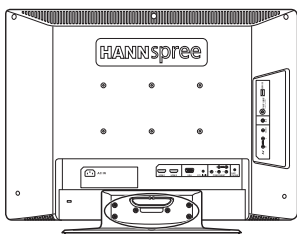

(For reference only)

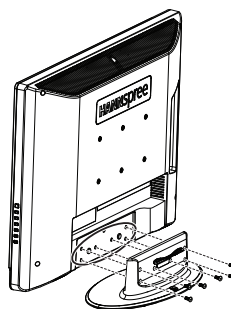

Wall mounting the TV:

- 1 Purchase a VESA compatible wall bracket: VESA 100 X 200, 6 holes, M4, 8mm, 20 kg.
- 2 Locate your ideal TV position on the wall.
- 3 Fix the wall bracket firmly on the wall.
- 4 Secure the TV to the bracket using the 6 mount holes on the back and center of the TV.

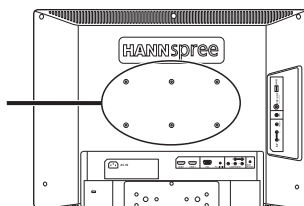

Note:

- Please read the instructions of your specific wall bracket to properly wall mount the TV.
- The pitch of the mounting holes is 100mm horizontally and 100mm vertically.
- The screws type required is metric: M4, 8 mm length.
- The 28" TV stand base can be screwed on a table or a hard surface using the hole on the back of the stand base.

**Installing the LCD TV requires special skill that should only be performed by qualified service personnel. Customers should not attempt to do the work themselves. Hannspree bears no responsibility for improper mounting or mounting that results in accident or injury. You can ask a qualified service personnel about using an optional bracket to mount the TV to the wall.*

Using the Cable Organizer

Organize your cables by routing the cables through the cable clamp.

