

Genie®



Operator's Manual

with Maintenance Information

Second Edition
Fourth Printing
Part No. 48643

IWP™ Super Series™

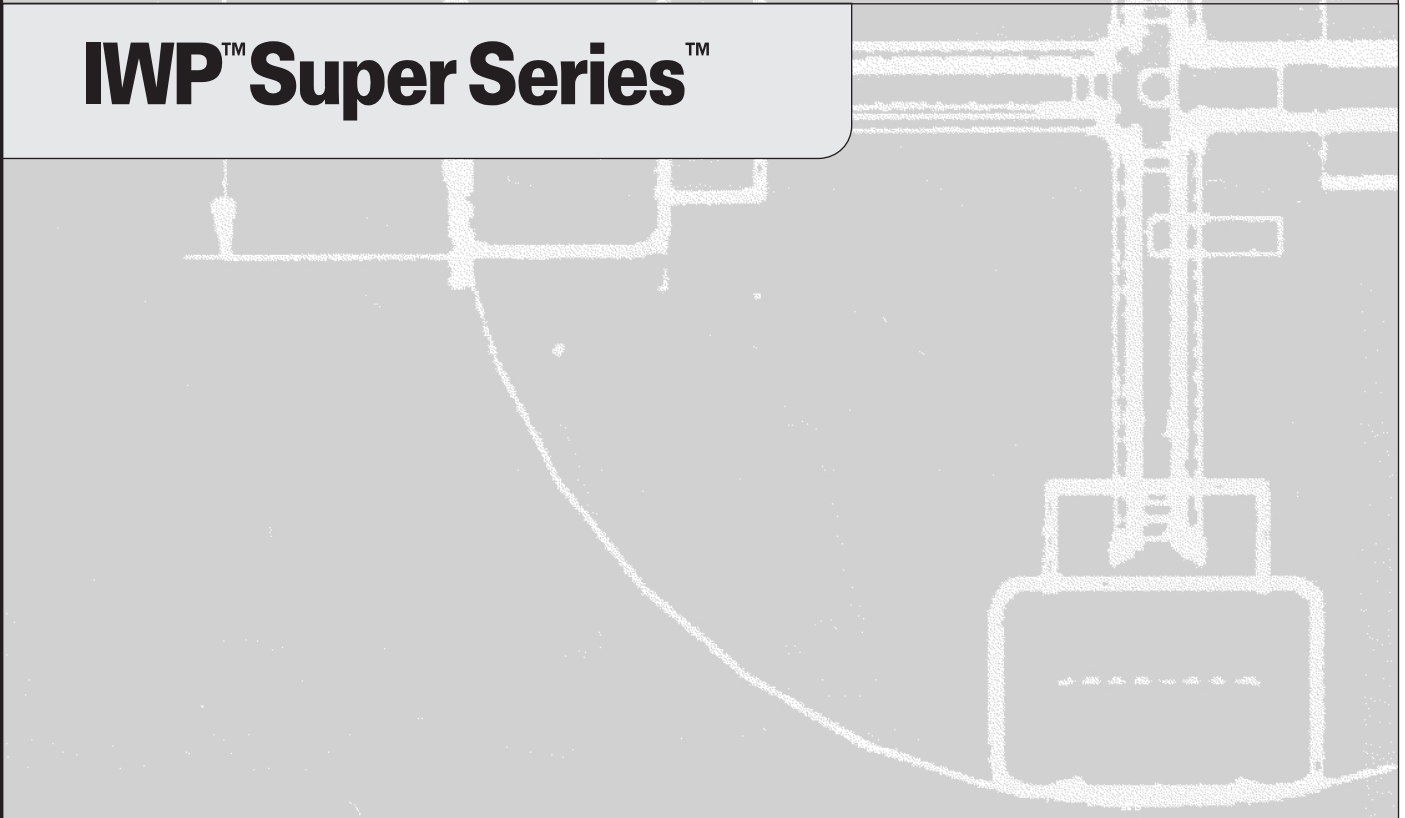

Important

Read, understand and obey these safety rules and operating instructions before operating this machine. Only trained and authorized personnel shall be permitted to operate this machine. This manual is considered a permanent part of your machine and should remain with the machine at all times. If you have any questions, call Genie Industries.

Contents

	Page
Safety Rules	1
Controls	7
Legend	8
Pre-operation Inspection	9
Maintenance	11
Function Tests	13
Workplace Inspection	16
Operating Instructions	17
Battery and Charger Instructions	20
Transport Instructions	21
Decals	22
Specifications	24

Contact us:

Internet: <http://www.genielift.com>
 e-mail: techpub@genieind.com

Copyright © 1996 by Genie Industries.

First Edition: Fifth Printing, November 1997

Second Edition: Fourth Printing, January 2002

"Genie" and "IWP" are registered trademarks of Genie Industries in the U.S.A. and many other countries. "Super Series" is a trademark of Genie Industries.

This machine complies with
 ANSI/SIAA92.3-1990.

 Printed on recycled paper.

Printed in U.S.A.

Safety Rules



Danger

Failure to obey the instructions and safety rules in this manual will result in death or serious injury.

Do Not Operate Unless:

- You** learn and practice the principles of safe machine operation contained in this operator's manual.

1 Avoid hazardous situations.

Know and understand the safety rules before going on to the next section.

- 2 Always perform a pre-operation inspection.
- 3 Always perform the function tests prior to use.
- 4 Inspect the workplace.
- 5 Only use the machine as it was intended.

- You** read, understand and obey:
 - manufacturer's instructions and safety rules—operator's manual and machine decals
 - employer's safety rules and worksite regulations
 - applicable governmental regulations

SAFETY RULES

Tip-over Hazards

Do not raise the platform unless the machine is on a firm, level surface.

Do not move the machine while the platform is raised.

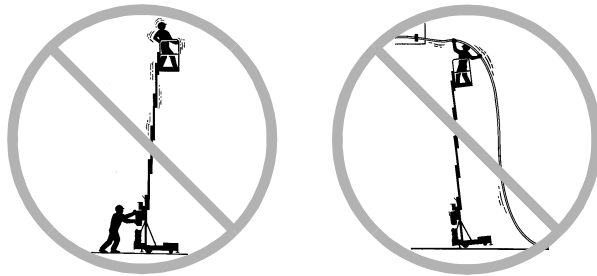

Do not cause a horizontal force or side load to the machine by raising or lowering a fixed or overhanging load.

Do not place or attach overhanging loads to any part of this machine.

Do not place ladders or scaffolds in the platform or against any part of this machine.

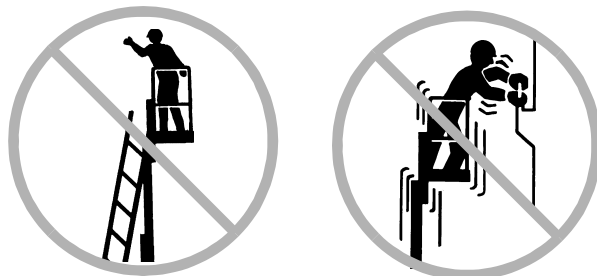

Do not push off or pull toward any object outside the platform.

Maximum allowable manual force	45 lbs 200 N
---------------------------------------	-----------------

Do not use the machine to lift material or equipment. The machine is intended to lift personnel and tools to an aerial work site.

Do not operate the machine near drop-offs, holes, bumps, debris, unstable or slippery surfaces or other possible hazardous conditions.

Do not use the machine on a moving or mobile surface or vehicle.

Do not alter or disable machine components that in any way affect safety and stability.

Do not operate the machine in strong or gusty winds. Do not increase the surface area of the platform or the load. Increasing the area exposed to the wind will decrease machine stability.



Do not exceed the rated platform load capacity.

Maximum capacity - ANSI & CE	350 lbs	159 kg
Maximum capacity - CSA	300 lbs	136 kg
Maximum capacity IWP-20S with outreach option	300 lbs	136 kg
Maximum occupancy	1 person	

SAFETY RULES

Do not replace items critical to stability with items of different weight or specification.

When moving the machine with a forklift or other transport vehicle, the platform should be fully lowered, the machine should be turned off and no personnel shall remain in the platform.

Do not install the outreach option on an IWP-25S or an IWP-30S. The outreach option is for the IWP-20S with the proper counterweight configuration.

Fall Hazards

Do not sit, stand or climb on the platform guard rails. Maintain a firm footing on the platform floor at all times.

Do not exit the platform while raised. If a power failure occurs, have ground personnel activate the manual lowering valve.

Keep the platform floor clear of debris.

Lower the platform entry mid-rail before operating.



Electrocution Hazards

This machine, even with an optional fiberglass platform, is not electrically insulated and will not provide protection from contact with or proximity to electrical current.



Keep away from the machine if it contacts energized power lines or becomes electrically charged. Personnel on the ground or in the platform must not touch or operate the machine until energized power lines are shut off.

Maintain safe distances from electrical power lines and apparatus in accordance with applicable governmental regulations and the following chart.

Voltage	Minimum Safe Approach Distance	
	Feet	Meters
Phase to Phase		
0 to 300V	Avoid Contact	
300V to 50KV	10	3.05
50KV to 200KV	15	4.60
200KV to 350KV	20	6.10
350KV to 500KV	25	7.62
500KV to 750KV	35	10.67
750KV to 1000KV	45	13.72

SAFETY RULES

Allow for platform movement, electrical line sway or sag and movement due to strong or gusty winds.

Do not use the machine as a ground for welding.

Do not operate an AC powered machine or a DC battery charger unless using a 3-wire grounded extension cord connected to a grounded AC circuit. Do not alter or disable 3-wire grounded plugs.

Collision Hazards

Check the work area for overhead obstructions or other possible hazards.



Be aware of crushing hazard when grasping the platform guard rail.

Do not lower the platform unless the area below is clear of personnel and obstructions.

Use common sense and planning to control the movement of the machine on or near inclines.



Stay clear of descending platform.

Damaged Machine Hazards

Do not use a damaged or malfunctioning machine.

Be sure all maintenance has been performed as specified in this manual and the Genie IWP Super Series service manual.

Be sure all decals are in place and legible.

Be sure the operator's, safety and responsibilities manuals are complete, legible and in the storage container located on the mast.

Conduct a thorough pre-operation inspection of the machine and test all functions before each work shift.

Do not use the machine as a ground for welding.

Improper Use Hazard

Do not leave the machine unattended unless the key is removed to secure from unauthorized use.

Bodily Injury Hazard

Do not operate the machine with a hydraulic oil or air leak. An air leak or hydraulic leak can penetrate and/or burn skin.

SAFETY RULES

Outreach Option Safety

Bodily Injury Hazard

Keep hands and feet away from moving parts: mounting plate, locking bracket and extension arms.

Power Wheel Assist Option Safety

Collision Hazards

Limit travel speed according to the condition of the ground surface, congestion, slope, location of personnel and any other factors which may cause collision.

Be aware of limited sight distance when moving the machine.

Do not move the machine with the platform raised.

When moving the machine on an incline, operate from the uphill side of the machine.

Do not rely on the brake to hold the machine on an incline.

Decal Legend

Genie product decals use symbols, color coding and signal words to identify the following:



Safety alert symbol—used to alert personnel to potential personal injury hazards. Obey all safety messages that follow this symbol to avoid possible injury or death.



Red—used to indicate the presence of an imminently hazardous situation which, if not avoided, will result in death or serious injury.



Orange—used to indicate the presence of a potentially hazardous situation which, if not avoided, could result in death or serious injury.



Yellow with safety alert symbol—used to indicate the presence of a potentially hazardous situation which, if not avoided, may cause minor or moderate injury.



Yellow without safety alert symbol—used to indicate the presence of a potentially hazardous situation which, if not avoided, may result in property damage.



Green—used to indicate operation or maintenance information.

SAFETY RULES

Battery and Charger Safety - DC Models

Burn Hazards

Batteries contain acid. Always wear protective clothing and eyewear when working with batteries.



Avoid spilling or contacting battery acid. Neutralize battery acid spills with baking soda and water.

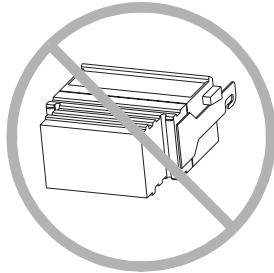

The battery pack must remain in an upright position.

Explosion Hazards



Batteries emit explosive gas. Keep sparks, flames and lighted tobacco away from batteries.

Charge the battery in a well-ventilated area.

Do not disconnect charger DC output wires from the battery when the charger is on.

Electrocution Hazards

Connect the charger to a grounded AC circuit only.



Do not expose the battery or charger to water and/or rain.

Before each use, inspect for damage. Replace damaged components before operating.

Lifting Hazard

The battery pack weighs 90 lbs / 40.8 kg. Use the appropriate number of people and proper lifting techniques.

Controls

Ground Controls

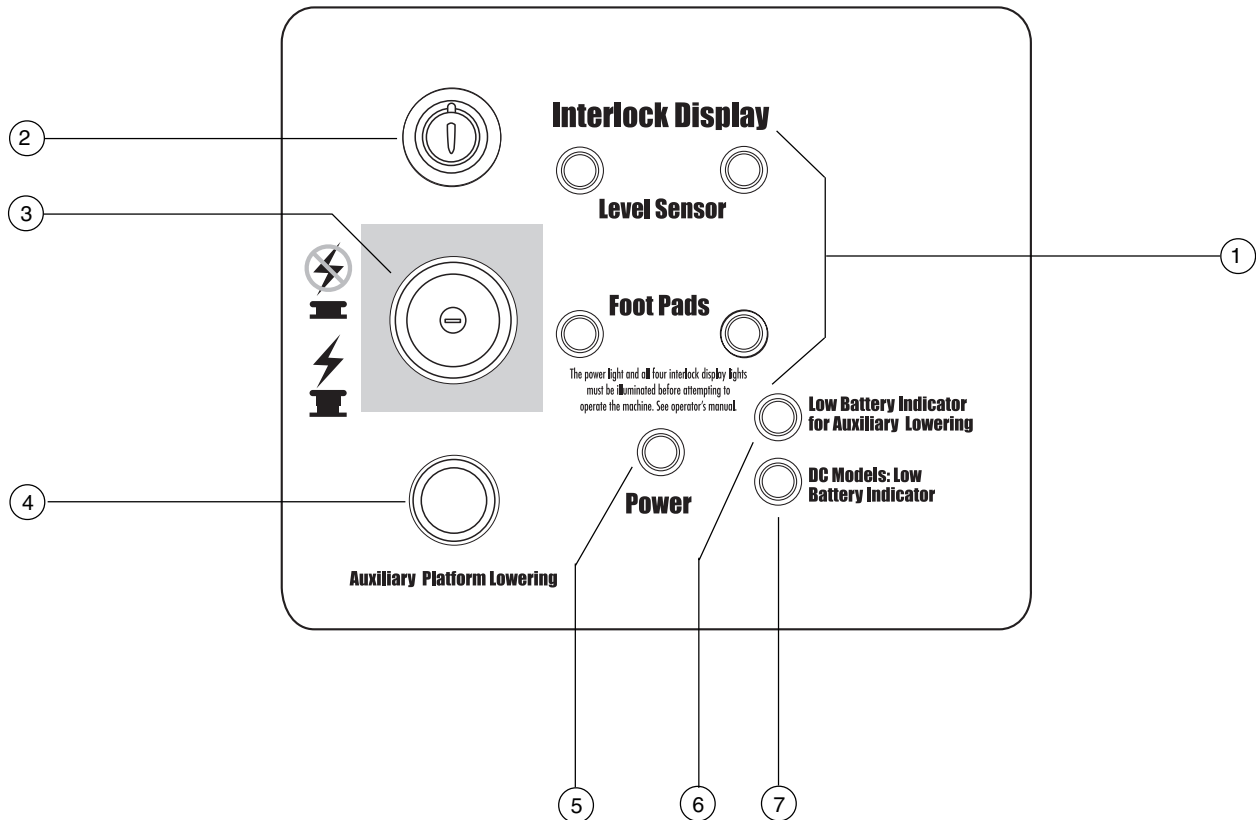

Platform Controls - ANSI & CSA

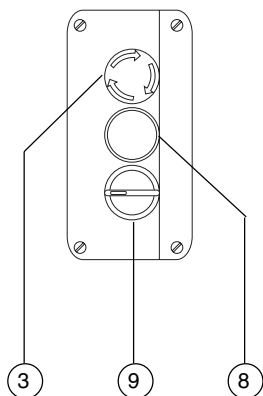

Platform Controls - CE

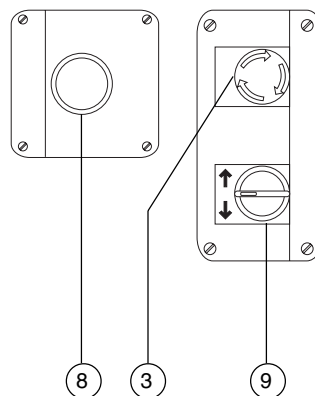

- 1 Interlock display lights (four)
- 2 Key switch
- 3 Red Emergency Stop button
- 4 Auxiliary platform lowering button
- 5 Power light
- 6 Low battery indicator light for auxiliary lowering
- 7 DC models: Low battery indicator light
- 8 Control activate button
- 9 Up/Down switch

Legend

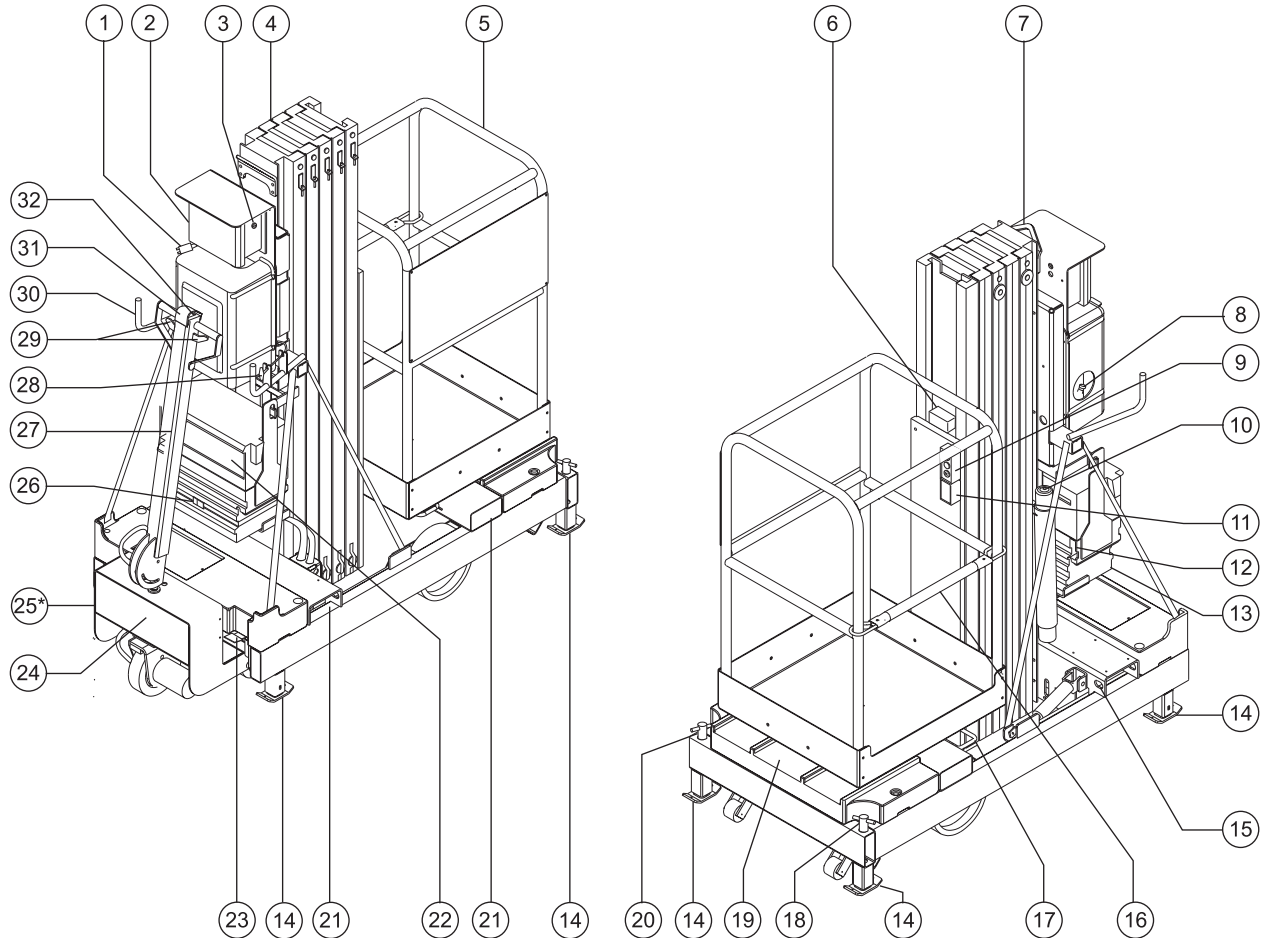

- | | | |
|---|--|---|
| 1 AC models: AC power supply line for machine
DC models: power to platform | 11 AC outlet | 24 Power wheel assist option |
| 2 Ground controls (interlock display) | 12 DC models: Battery quick disconnect | 25 Manual lowering valve (*located at the bottom of the hydraulic cylinder) |
| 3 Circuit breaker | 13 DC models: Battery pack | 26 Battery strap |
| 4 Mast | 14 Footpad | 27 Steer handle - power wheel assist option |
| 5 Platform | 15 Transport tie down | 28 Base lowering handle |
| 6 Operator's manual storage container | 16 Platform entry mid-rail or gate | 29 Function enable lever - power wheel assist option |
| 7 Lifting eye | 17 Forklift ring | 30 Steering handle |
| 8 Breather cap | 18 Left side leveling jack | 31 Direction-reversing safety switch - power wheel assist option |
| 9 Platform controls | 19 Counterweight | 32 Thumb rocker switch - power wheel assist option |
| 10 Bubble level/level sensor | 20 Right side leveling jack | |
| | 21 Forklift pocket | |
| | 22 DC models: Battery charger | |
| | 23 Foot pedal | |

Pre-operation Inspection



Do Not Operate Unless:

You learn and practice the principles of safe machine operation contained in this operator's manual.

- 1 Avoid hazardous situations.
- 2 Always perform a pre-operation inspection.**

Know and understand the pre-operation inspection before going on to the next section.

- 3 Always perform function tests prior to use.
- 4 Inspect the workplace.
- 5 Only use the machine as it was intended.

Fundamentals

It is the responsibility of the operator to perform a Pre-operation Inspection and routine maintenance.

The Pre-operation Inspection is a visual inspection performed by the operator prior to each work shift. The inspection is designed to discover if anything is apparently wrong with a machine before the operator performs the function tests.

The Pre-operation inspection also serves to determine if routine maintenance procedures are required. Only routine maintenance items specified in this manual may be performed by the operator.

Refer to the list on the next page and check each of the items and locations for modifications, damage or loose or missing parts.

A damaged or modified machine must never be used. If damage or any variation from factory delivered condition is discovered, the machine must be tagged and removed from service.

Repairs to the machine may only be made by a qualified service technician, according to the manufacturer's specifications. After repairs are completed, the operator must perform a pre-operation inspection again before going on to the function tests.

Scheduled maintenance inspections shall be performed by qualified service technicians, according to the manufacturer's specifications and the requirements listed in the responsibilities manual.

PRE-OPERATION INSPECTION

Pre-operation Inspection

- Be sure that the operator's, safety and responsibilities manuals are complete, legible and in the storage container located on the mast.
- Be sure that all decals are legible and in place. See Decals section.
- AC & DC models: Check for hydraulic oil leaks and proper oil level. Add oil if needed. See Maintenance section.
- DC models: Check for battery fluid leaks and proper fluid level. Add distilled water if needed. See Maintenance section.

Check the following components or areas for damage, modifications and improperly installed or missing parts:

- Electrical components, wiring and electrical cables
- Hydraulic power unit, hoses, fittings and cylinders
- Hydraulic manifolds and foot pump
- Platform entry mid-rail or gate
- Sequencing cables and pulleys
- Lifting chains and idler wheels
- Mast columns and counterweight
- Nuts, bolts and other fasteners
- Breather cap
- Foot pads
- Adjustable glide pads

If equipped: Power wheel assist option

- Steer handle
- Hydraulic motor and hoses

If equipped: IWP-20S with Outreach option

- Locking bracket
- Handle and handle lock
- Extension arms
- Confirm proper counterweight configuration (part number is stamped on top of counterweight)

ANSI & CE Indoor	Front P/N	Rear P/N
IWP-20S Standard Base	37354	37355
IWP-20S Wide Base	40990	40991
CSA	Front P/N	Rear P/N
IWP-20S Wide Base	40988	40989

Check entire machine for:

- Dents or damage
- Corrosion or oxidation
- Cracks in welds or structural components
- Inspect and clean battery terminals and all battery cable connections
- Be sure that all structural and other critical components are present and all associated fasteners and pins are in place and properly tightened.

Maintenance



Observe and Obey:

- ☑ Only routine maintenance items specified in this manual shall be performed by the operator.
- ☑ Scheduled maintenance inspections shall be completed by qualified service technicians, according to the manufacturer's specifications and the requirements specified in the responsibilities manual.

Maintenance Symbols Legend

NOTICE The following symbols have been used in this manual to help communicate the intent of the instructions. When one or more of the symbols appear at the beginning of a maintenance procedure, it conveys the meaning below.



Indicates that tools will be required to perform this procedure.



Indicates that new parts will be required to perform this procedure.

Check the Battery - DC Models



Proper battery condition is essential to good machine performance and operational safety. Improper fluid levels or damaged cables and connections can result in engine component damage and hazardous conditions.

WARNING Electrocution hazard. Contact with hot or live circuits could result in death or serious injury. Remove all rings, watches and other jewelry.

WARNING Bodily injury hazard. Batteries contain acid. Avoid spilling or contacting battery acid. Neutralize battery acid spills with baking soda and water.

NOTICE Perform this test after fully charging the batteries.

- 1 Put on protective clothing and eye wear.
- 2 Remove the battery vent caps.
- 3 Check the battery acid level. If needed, replenish with distilled water to the bottom of the battery fill tube. Do not overfill.
- 4 Install the vent caps.

MAINTENANCE

Check the Hydraulic Oil Level



Maintaining the hydraulic oil at the proper level is essential to machine operation. Improper hydraulic oil levels can damage hydraulic components. Daily checks allow the inspector to identify changes in oil level that might indicate the presence of hydraulic system problems.

- 1 Be sure the platform is fully lowered.
 - 2 Check the sight gauge on the side of the hydraulic tank.
- ⦿ **Result:** The hydraulic oil level should be visible in the middle of the sight gauge. Do not overfill.

Hydraulic oil specifications

Hydraulic oil type	Dexron equivalent
--------------------	-------------------

Scheduled Maintenance

Maintenance performed quarterly, annually and every two years must be completed by a person trained and qualified to perform maintenance on this machine according to the procedures found in the service manual for this machine.

Machines that have been out of service for more than three months must receive the quarterly inspection before they are put back into service.

Function Tests



Do Not Operate Unless:

- You learn and practice the principles of safe machine operation contained in this operator's manual.
- 1 Avoid hazardous situations.
- 2 Always perform a pre-operation inspection.
- 3 Always perform function tests prior to use.**

Know and understand the function tests before going on to the next section.

- 4 Inspect the workplace.
- 5 Only use the machine as it was intended.

Fundamentals

The Function Tests are designed to discover any malfunctions before the machine is put into service. The operator must follow the step-by-step instructions to test all machine functions.

A malfunctioning machine must never be used. If malfunctions are discovered, the machine must be tagged and removed from service. Repairs to the machine may only be made by a qualified service technician, according to the manufacturer's specifications.

After repairs are completed, the operator must perform a pre-operation inspection and function tests again before putting the machine into service.

FUNCTION TESTS

Function Tests

1 Select a level test area free of obstructions.

2 Pump the foot pedal to raise the base.

☉ Result: The wheels should contact the ground.

3 Pull the base lowering handle to fully lower the base.

☉ Result: All four foot pads should come in firm contact with the ground.

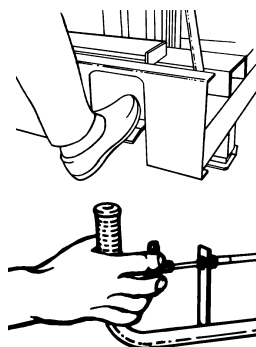

4 Connect the appropriate power source.

5 Use the bubble level and adjust the leveling jacks until the machine is level and all four foot pads are in firm contact with the ground.

6 Insert the key and turn to the ON position OR turn to platform controls.

7 Pull out the red Emergency Stop button at the ground controls to the ON position.

8 Twist to release the red Emergency Stop button at the platform controls.

☉ Result: The power light should come on. Within 1 to 4 seconds, all four display lights should turn on and remain on.

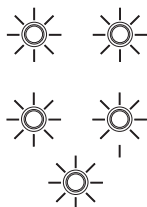

Test Interlock System

9 Pump the foot pedal to raise the base.

☉ Result: The two foot pad display lights should be off.

10 Pull the base lowering handle to lower the base.

☉ Result: The two foot pad display lights should be on.

11 Pump the foot pedal to raise the base.

12 Turn both the leveling jacks clockwise to the full down position.

13 Pull the base lowering handle to lower the base.

☉ Result: The base will lower and the two level sensor display lights should be off and remain off because the base is not level.

14 At the platform controls, push in the control activate button and rotate the up/down switch to the UP position, then the DOWN position.

☉ Result: The platform up/down function should not operate.

Test Emergency Stop

15 Use the bubble level and adjust the leveling jacks until the machine base is level. Be sure all four display lights are on.

16 Push in the red Emergency Stop button at the ground controls.

17 At the platform controls, push in the control activate button and rotate the up/down switch in each direction.

☉ Result: The platform up/down function should not operate.

18 Push in the red Emergency Stop button at the platform controls and pull out the red Emergency Stop button at the ground controls.

19 At the platform controls, push in the control activate button and rotate the up/down switch in each direction.

☉ Result: The platform up/down function should not operate.

FUNCTION TESTS

Test Auxiliary Platform Lowering

- 20 Raise the platform slightly.
- ☉ Result: The inner frame wheels should lift off the ground.
- 21 Disconnect the power source from the machine.
- 22 Turn the key switch to ground control (if equipped).
- 23 Push in the auxiliary platform lowering button at the ground controls.
- ☉ Result: The platform should lower.
- 24 Connect the power source to the machine.
- 25 Turn the key switch to platform control (if equipped).
- 26 Raise the platform slightly.
- 27 Disconnect the power source from the machine.
- 28 At the platform controls, push in the control activate button and rotate the up/down switch in the down direction.
- ☉ Result: The platform should lower.
- 29 Connect the power source to the machine.

Test Manual Lowering

- 30 Twist to release the red Emergency Stop button at the platform controls. Confirm that the interlock display lights and the power light are on.
- 31 Push in the control activate button and rotate the up/down switch to the UP position to raise the platform approximately 6 inches / 15 cm.
- 32 Activate the manual lowering valve located at the bottom of the hydraulic cylinder.
- ☉ Result: The platform should lower.

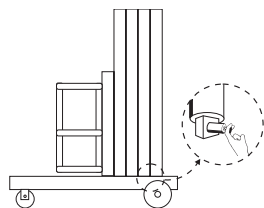

Test Platform Raise and Lower

- 33 Push in the control activate button and rotate the up/down switch to the UP position.

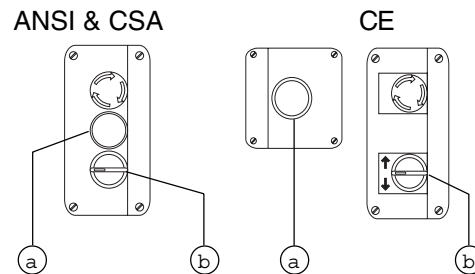

a control activate button
b up/down switch

- ☉ Result: The platform should raise smoothly, free of hesitation.
- 34 Push in the control activate button and rotate the up/down switch to the DOWN position.

- ☉ Result: The platform should lower.

Test the Direction-reversing Safety Switch (models with Power Wheel Assist Option only)

- 35 Pull and hold the function enable lever on either side.
- 36 Press the thumb rocker switch and drive the machine in the reverse direction.
- 37 Press the direction-reversing safety switch on the end of the steer handle.
- ☉ Result: The machine should travel in the forward direction.

Workplace Inspection



Do Not Operate Unless:

- You learn and practice the principles of safe machine operation contained in this operator's manual.
- 1 Avoid hazardous situations.
- 2 Always perform a pre-operation inspection.
- 3 Always perform function tests prior to use.
- 4 Inspect the workplace.**
Know and understand the workplace inspection before going on to the next section.
- 5 Only use the machine as it was intended.

Be aware of and avoid the following hazardous situations:

- Drop-offs or holes
- Bumps and floor obstructions
- Debris
- Overhead obstructions and high voltage conductors
- Hazardous locations
- Inadequate surface support to withstand all load forces imposed by the machine
- Wind and weather conditions
- All other possible unsafe conditions

Fundamentals

The Workplace Inspection helps the operator determine if the workplace is suitable for safe machine operation. It should be performed by the operator prior to moving the machine to the workplace.

It is the operator's responsibility to read and remember the workplace hazards, then watch for and avoid them while moving, setting up and operating the machine.

Operating Instructions



Do Not Operate Unless:

- You learn and practice the principles of safe machine operation contained in this operator's manual.
- 1 Avoid hazardous situations.
- 2 Always perform a pre-operation inspection.
- 3 Always perform function tests prior to use.
- 4 Inspect the work place.
- 5 **Only use the machine as it was intended.**

Fundamentals

Using the machine for anything other than lifting personnel and tools to an aerial work site is unsafe.

If more than one operator is expected to use a machine at different times in the same work shift, each operator is expected to follow all safety rules and instructions in the operator's manual. That means every new operator should perform a pre-operation inspection, function tests and a work place inspection before using the machine.

Setup

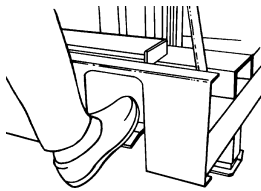
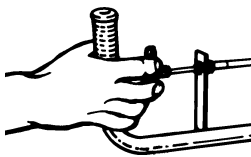
- 1 Pump the foot pedal to raise the base until the wheels contact the ground. 
- 2 Use the steering handle to push the machine.
- 3 Position the machine on a firm, level surface directly below the work area.
- 4 Pull the base lowering handle to lower the base until all four foot pads are in firm contact with the ground. 
- 5 Connect to an appropriate power source:
DC models: Connect battery pack.
AC models: Connect to a grounded 15A AC power supply. Use a 12 gauge / 3.3mm² 3-wire grounded extension cord no longer than 50 feet / 13 m.
- 6 Insert the key and turn to the ON position OR to platform control.
- 7 Pull out the red Emergency Stop button at the ground controls and be sure the power light is on.
- 8 Check the interlock display. Be sure that all four display lights are on.

OPERATING INSTRUCTIONS

Emergency Stop

- 1 Push in the red Emergency Stop button at the platform controls or at the ground controls to stop the up function.

Platform Raise & Lower

- 1 Twist to release the red Emergency Stop button at the platform controls.
- 2 Push in the control activate button and rotate the up/down switch in the desired direction of travel.

ANSI & CSA

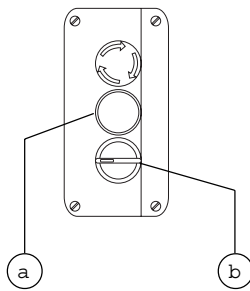

CE

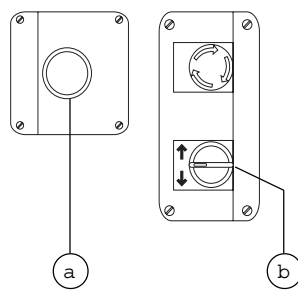

- a control activate button
b up/down switch

Auxiliary Platform Lowering

- 1 Turn the key switch to ground control (if equipped).
- 2 Activate the auxiliary platform lowering button at the ground controls.

After Each Use

- 1 Select a safe storage location—firm, level surface, weather protected, clear of obstruction and traffic.
- 2 Pull the base lowering handle to lower the base until all four foot pads are in firm contact with the ground.
- 3 Remove the key to secure from unauthorized use.
- 4 DC models: Recharge battery.

Manual Lowering

- 1 Activate the manual lowering valve located at the bottom of the hydraulic cylinder.

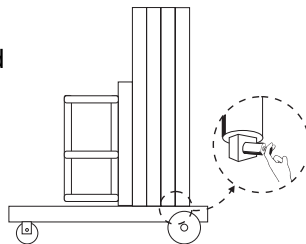

OPERATING INSTRUCTIONS

Outreach Option Operating Instructions

- 1 Lift up on the locking bracket.
- 2 Rotate the handle clockwise to extend the platform. Rotate the handle counterclockwise to retract the platform.
- 3 Be sure to lock the handle.

CE models: When the outreach is extended, the up/down function will not operate. Retract the outreach and reposition the platform.

Power Wheel Assist Option Operating Instructions

- 1 Lower the steer handle.
- 2 Pull and hold the function enable lever on either side.
- 3 Activate the thumb rocker switch in the desired direction of travel.
- 4 Release the thumb rocker switch. The machine will continue to roll when the rocker switch is released.
- 5 Release the function enable lever to stop the machine and set the brake.

Note: The brake will hold the machine on inclines of less than 3°.

To Move The Machine Without Power Wheel Assist: Pull and hold the function enable lever to release the brake.

OPERATING INSTRUCTIONS



Battery and Charger Instructions

Observe and Obey:

- Do not use an external charger or booster battery.
- Charge the battery in a well-ventilated area.
- Use proper AC input voltage for charging as indicated on the charger.
- Use only Genie authorized battery and charger.

To Charge Battery

- 1 Open the battery pack lid to access the battery.
- 2 Remove the battery vent caps and check the battery acid level. If necessary, add only enough distilled water to cover the plates. Do not overfill prior to the charge cycle.
- 3 Replace the battery vent caps.
- 4 Set the power switch to the OFF position. Be sure that the DC output cord is properly connected to the battery. Black to negative, red to positive.
- 5 Connect the battery charger to a grounded AC circuit.
- 6 If equipped: Set the AC Selector switch to the proper voltage.
- 7 Set the power switch to the AUTO position.

- 8 Monitor the ampere meter for the correct charge rate. The initial charge rate should be approximately 10A. The charge rate will decrease as the battery reaches full charge.
- 9 The charger will turn off automatically when the battery is fully charged. Set the power switch to the OFF position, then disconnect from the AC supply.
- 10 Check the battery acid level when the charge cycle is complete. Replenish with distilled water to the bottom of the fill tube. Do not overfill.

Dry Battery Filling and Charging Instructions

- 1 Remove battery vent caps and permanently remove plastic seal from battery vent openings.
- 2 Fill each cell with battery acid (electrolyte) until the level is sufficient to cover the plates.

Do not fill to maximum level until battery charge cycle is complete. Overfilling can cause the battery acid to overflow during charging. Neutralize battery acid spills with baking soda and water.

- 3 Install the battery vent caps.
- 4 Charge the battery.
- 5 Check the battery acid level when the charging cycle is complete. Replenish with distilled water to the bottom of the fill tube. Do not overfill.

Transport Instructions



Observe and Obey:

- ☑ Common sense and planning must be applied to control the movement of the machine when lifting it with a crane or forklift.
- ☑ The transport vehicle must be parked on a level surface.
- ☑ The transport vehicle must be secured to prevent rolling while the machine is being loaded.
- ☑ Vehicle capacity, loading equipment and surfaces must be capable of supporting the machine weight. See Specifications section.
- ☑ The base of the machine must remain lowered during all loading and transport procedures.
- ☑ The machine must be secured to the transport vehicle with chains or straps of ample load capacity.

Winching the Machine onto a Flatbed Truck

- 1 Lower the platform.
- 2 Push in the red Emergency Stop buttons, turn the key switch to the OFF position and remove the key.
- 3 Inspect the entire machine for loose or unsecured items.
- 4 Connect the cable to the winching point located on the front of the base.
- 5 Carefully winch the machine onto the truck.
- 6 Secure the machine base and mast to the transport vehicle. Use chains or straps of ample load capacity.

Loading the Machine With a Forklift

Use the forklift pockets located on the sides of the machine or the forklift rings located behind the counterweight under the platform.

Be sure to inspect the machine and remove any loose or unsecured items.

To use the forklift rings:

- 1 Raise the platform 3 inches / 7.5 cm.
- 2 Position the forklift rings in the up position.

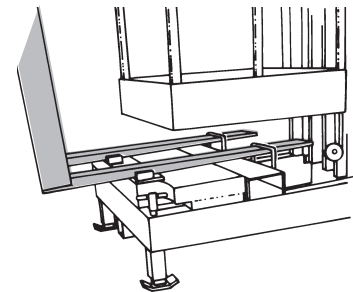

Loading the Machine With a Crane

Use the lifting eye mounted on the rear mast column.

The battery pack must be removed before lifting the machine with a crane.

Be sure to inspect the machine and remove any loose or unsecured items.

Always place the lifting hook through the lifting eye so that it points away from the machine.

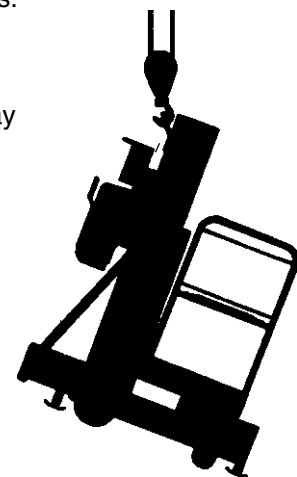

Decals

Decal Inspection

Use the pictures on the next page to verify that all decals are legible and in place. Below is a numerical list with quantities and descriptions.

Part No.	Description	Quantity
27857	Caution - Pipe Plug	1
27865	Label - Bubble Level	1
27868	Danger - Relief Valve	1
28157	Label - Dexron	1
28372	Caution - Quick Disconnect	1
31068	Danger - Battery Charger Safety	1
31070	Danger - Tip-over Hazard, Moving	1
31071	Warning - Failure to Read	1
31073	Label - Foot Pedal	1
31075	Caution - Crushing Hazard	4
31076	Caution - 8A Maximum, 115V AC	1
31077	Caution - Collision Hazard	1
31245	Warning - Collision Hazard	1
33550	Safety Tape, CE	---
37134	Label - Interlock Display	1
37141	Manual Lowering Instructions	1
37143	Notice - Max Capacity 300 lbs / 136 kg	1
37144	Notice - Max Capacity 350 lbs / 159 kg	1
37145	Label - Manual Lowering Valve	1
38116	Danger - Outreach Option Safety & Instructions	1
38117	Notice - Power Wheel Assist Option Operating Instructions	1
38119	Notice - Operating Instructions	1
38122	Label - Manual Storage Container	1

Part No.	Description	Quantity
38142	Label - Circuit Breaker (AC models)	1
38149	Label - Patents	1
43657	Danger - Tip-over Hazard, Outreach Option	1
46212	Notice - Max Side Force 45 lbs / 200 N	1
44813	Label - Interlock Display	1
44999	Label - Control Activate	1
48644	Label - Function Enable Lever	1
48645	Danger - Power Wheel Assist Option Safety	1
52996	Cosmetic - Genie Logo	2
62045	Cosmetic - IWP-25S	2
62046	Cosmetic - IWP-30S	2
62996	Cosmetic - IWP-20S	2
72844	Danger - General Safety	1

DECALS

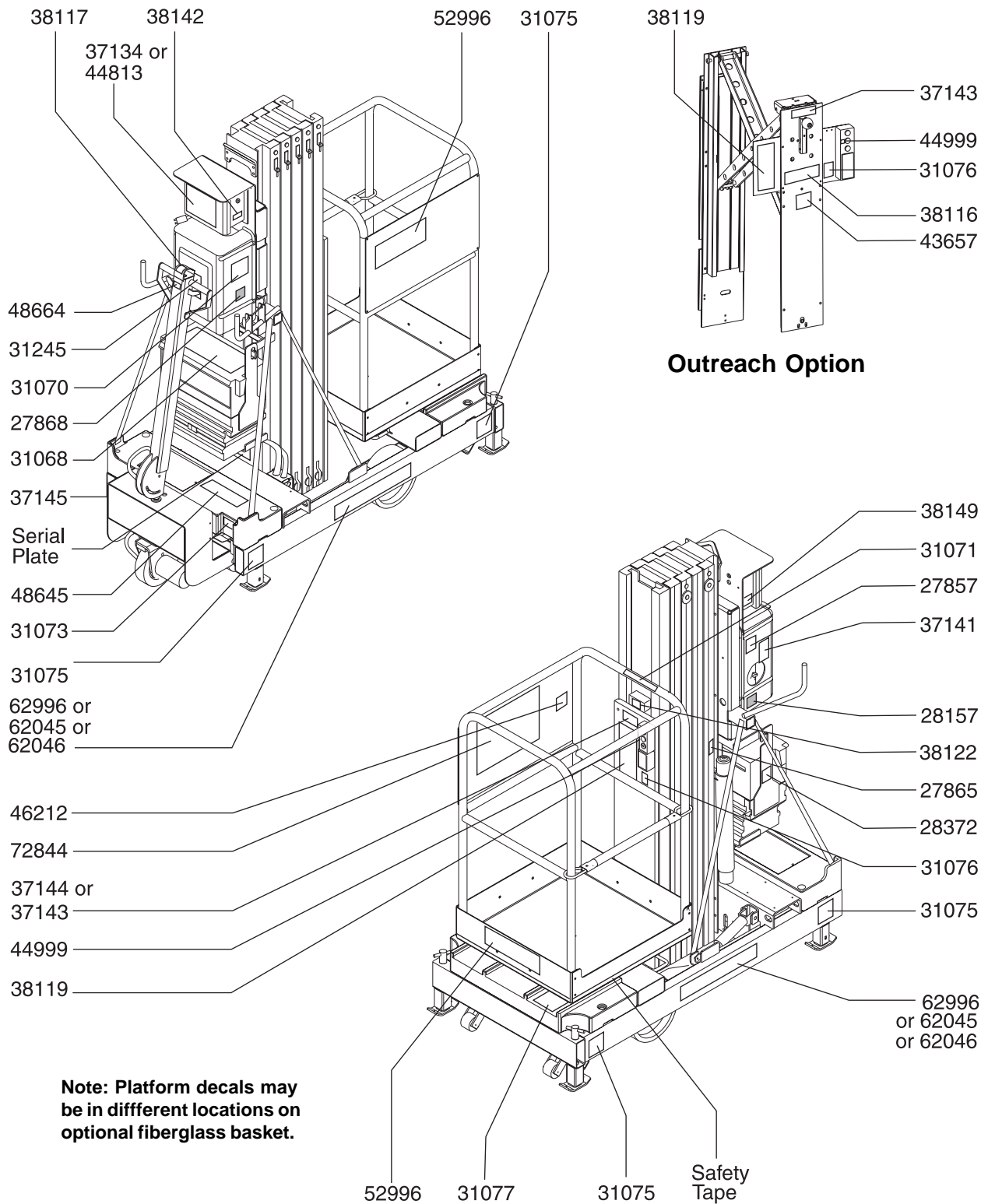

Note: Platform decals may be in different locations on optional fiberglass basket.

Specifications

Model	IWP-20S	IWP-25S	¹ IWP-30S
Height, working maximum	26 ft 5 in 8.1 m	30 ft 5 in 9.3 m	35 ft 6 in 10.8 m
Height, platform maximum	20 ft 5 in 6.2 m	24 ft 5 in 7.4 m	29 ft 6 in 9.0 m
Lift capacity - ANSI & CE	350 lbs 159 kg	350 lbs 159 kg	350 lbs 159 kg
Lift capacity - CSA	300 lbs 136 kg	300 lbs 136 kg	300 lbs 136 kg
Lift capacity with outreach option	300 lbs 136 kg	— —	— —
Power source			
DC model	12V	12V	12V
AC model	110V or 220V	110V or 220V	110V or 220V
Machine weight (Machine weights vary with option configurations)	See Serial Plate	See Serial Plate	See Serial Plate
Height, stowed base fully lowered/base raised	76 in / 78 in 1.9 m / 2.0 m	76 in / 78 in 1.9 m / 2.0 m	76 in / 78 in 1.9 m / 2.0 m
Width - Standard base	32 in 81 cm	32 in 81 cm	— —
Length - Standard base	60 in 1.5 m	60 in 1.5 m	— —
Width - Wide base	40 in 1 m	40 in 1 m	40 in 1 m
Length - Wide base	60 in 1.5 m	60 in 1.5 m	60 in 1.5 m
Optional Outreach, extended	26 in 66 cm	— —	— —
Corner access ²	6 in 15 cm	6 in 15 cm	7 in 18 cm

¹ IWP-30S is only available with a wide base.

² Corner of platform top rail to corner of wall with ability to rotate leveling jack handle.

Continuous improvement of our products is a Genie policy. Product specifications are subject to change without notice or obligation.

SPECIFICATIONS

Ambient operating temperature	-20°F to 135°F -29°C to 57°C
-------------------------------	---------------------------------

Airborne noise emissions Maximum sound level at normal operating workstations (A-weighted)	80 dB
---	-------

Platform Dimensions (length x width x height)

Standard platform gated or sliding mid-rail	27 x 26 x 44 ³ / ₄ in 69 cm x 66 cm x 1.1 m
--	--

Gated ultra-narrow platform	22 x 18 x 44 ³ / ₄ in 56 cm x 46 cm x 1.1 m
-----------------------------	--

Gated narrow platform	26 x 20 x 44 ³ / ₄ in 66 cm x 51 cm x 1.1 m
-----------------------	--

Standard fiber platform	29 x 26 ¹ / ₂ x 43 ¹ / ₂ in 74 cm x 67 cm x 1.1 m
-------------------------	--

Narrow fiber platform	26 x 22 x 43 ¹ / ₂ in 66 cm x 56 cm x 1.1 m
-----------------------	--

Front entry gated narrow platform	20 x 26 x 44 ³ / ₄ in 51cm x 66 cm x 1.1 m
-----------------------------------	---

Extra large front and side entry platform	30 x 28 x 44 ³ / ₄ in 76 cm x 71 cm x 1.1 m
---	--

Genie Holland
Phone +31 70 51 78836
Fax +31 70 51 13993

Genie Scandinavia
Phone +46 31 3409612
Fax +46 31 3409613

Genie France
Phone +33 (0)2 37 26 09 99
Fax +33 (0)2 37 26 09 98

Genie Ibérica
Phone +34 93 579 5042
Fax +34 93 579 5059

Genie Germany
Phone +49 (0)4202 88520
Fax +49 (0)4202 8852-20

Genie U.K.
Phone +44 (0)1476 584333
Fax +44 (0)1476 584334

Genie Mexico City
Phone +52 5 653 03 84
Fax +52 5 664 40 16

Genie North America
Phone 425.881.1800
Toll Free USA and Canada
800.536.1800
Fax 425.883.3475

Genie Australia Pty Ltd.
Phone +61 7 3375 1660
Fax +61 7 3375 1002

Genie China
Phone +86 21 53852570
Fax +86 21 53852569

Genie Malaysia
Phone +60 4 228 1235
Fax +60 4 226 6872

Genie Japan
Phone +81 3 3453 6082
Fax +81 3 3453 6083

Genie Korea
Phone +82 2 558 7267
Fax +82 2 558 3910

Genie Africa
Phone +27 11 455 0373
Fax +27 11 455 0355

Genie Latin America
Phone +55 11 4055 2499
Fax +55 11 4043 1661

Distributed By: