

# INSTRUCTION MANUAL

# FUSION®



**MODEL: CA-ML600**  
**AM/FM/MP3/WMA/SD/USB/iPod/iPhone RECEIVER**

0000 2445 0000  
2445 2545 A854  
0000 0072 9900  
0000 2222 1235

## MADE FOR:

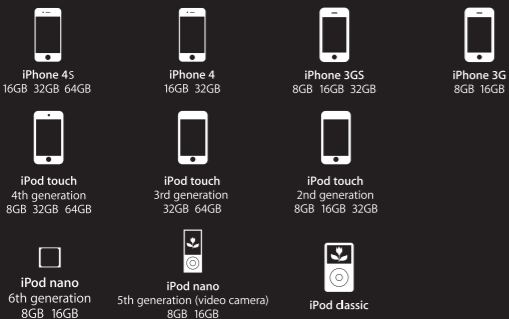

For the latest news on supported iPod models visit: [www.fusionelectronics.com](http://www.fusionelectronics.com)

## CONTENTS

Precautions & Maintenance	P3
Quick Start Guide	P3
Dashboard Installation	P4
Removal / Re-Attachment of the Face	P5
Connecting the System	P6
Basic Operations	P7
Audio Functions	P8
System Menu	P9
Radio Operation	P10
RDS Operation	P10
iPod / iPhone Operation	P11
Media Playback (USB/SD/Aux In)	P12
Additional Media Playback Options	P14
Troubleshooting	P16
How To Reset The Unit	P16
RDS Program Types & Descriptions	P17
Product Specifications	P17
Supported File Types	P18
Licensing	P18
Register Your Product	P19
Warranty	P20-27

## PRECAUTIONS & MAINTENANCE

### GENERAL

- When cleaning the vehicle, do not get water or cleaning fluids on the unit.
- Do not attempt to open the unit chassis. There are no user servicable parts or adjustments inside.
- This unit has been tested with all compatible authentic iPod/iPhone models under normal expected operating conditions, free from any pre-existing defects in either the unit or iPod/iPhone and with unmodified or "jailbroken" software.
- No Responsibility can be taken for use of the unit other than under normally expected operating conditions in conjunction with fully functional and undamaged iPod/iPhone units which have been manufactured and authorised by Apple Inc.
- Ensure that only a Apple sync iPhone/iPod cable is used for connection to this unit.

## QUICK START GUIDE

### TUNER REGION SETTING

When the unit is powered up for the first time (or the battery is disconnected or runs flat), you will need to set your tuner region.

1. When you press the power button to turn on the unit  [OCEANIA] will be displayed on the LCD screen as the default Tuner region.
2. Rotate the Encoder Volume Control to select an option: OCEANIA (Australia / New Zealand), USA, EUROPE or RUSSIA.
3. Press the Encoder Volume Control to store your selection and exit to the Tuner mode.

If you make the wrong selection, you may not be able to tune in to your desired stations. This setting can be easily changed from the SYSTEM MENU — see page 9.

### SELECTING THE MUSIC SOURCE

Press the source button  to cycle through the following sources (if available) — Radio → USB → SD → AUX

### RGB 32K+ COLOUR SELECTION

The initial colour setting for this unit is Colour Scan. To quickly enter the 32K+ RGB colour menu, press and hold the ESC/RGB button 

You can then rotate the Encoder Volume Control to select from the following pre-set display colours:

WHITE: GREEN1: GREEN2: GREEN3: AMBER: PINK1:  
PINK2: PURPLE1: PURPLE2: BLUE1: BLUE2: USER  
COLOUR: ORANGE

Press the ESC/RGB button  to confirm your selection.

See Page 10 for details on how to set the USER COLOUR

### STORE DEMO MODE

When you connect the unit for the first time and press the Mute/Power button  the unit will operate in Demo Mode. To exit Demo Mode, press the Mute/Power Button again. See Page 10 to turn Demo Mode off.

## DASHBOARD INSTALLATION

The following illustration shows a typical installation. If you have any questions or require information regarding installation kits, consult your car audio retailer.

If you are not sure how to install this unit correctly, have it installed by a qualified installer.

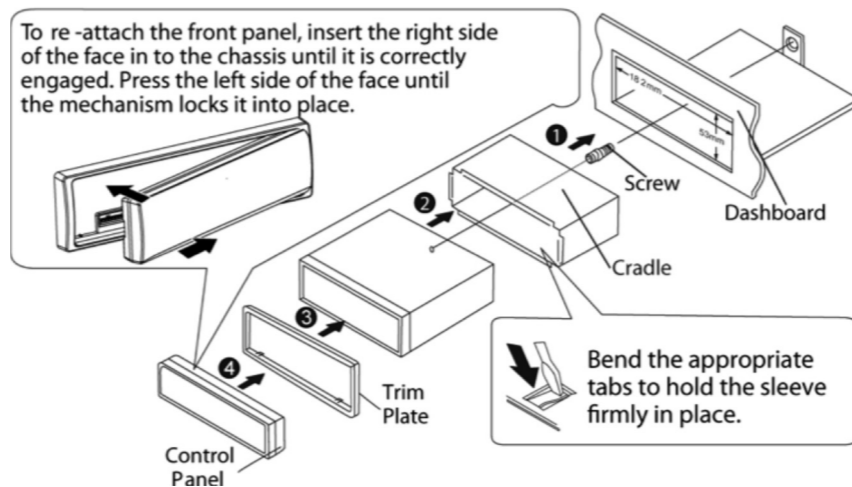

## REMOVAL/RE-ATTACHMENT OF THE FACE

1. Press the Panel OPEN button.
2. Hold the left-hand side of the Face and pull forward
3. Pull the Face towards you (1) to disengage it from the chassis (2).

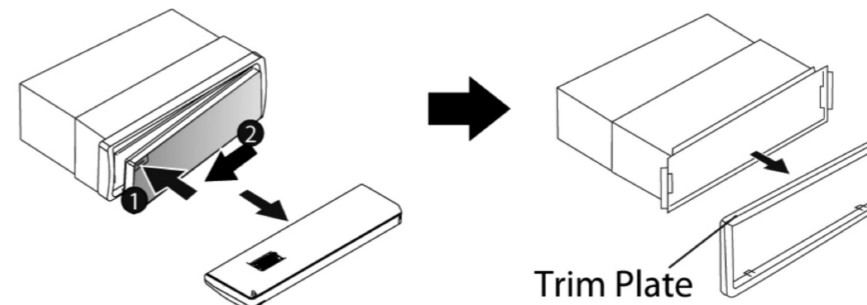

## CONNECTING THE SYSTEM

### WIRING DIAGRAM

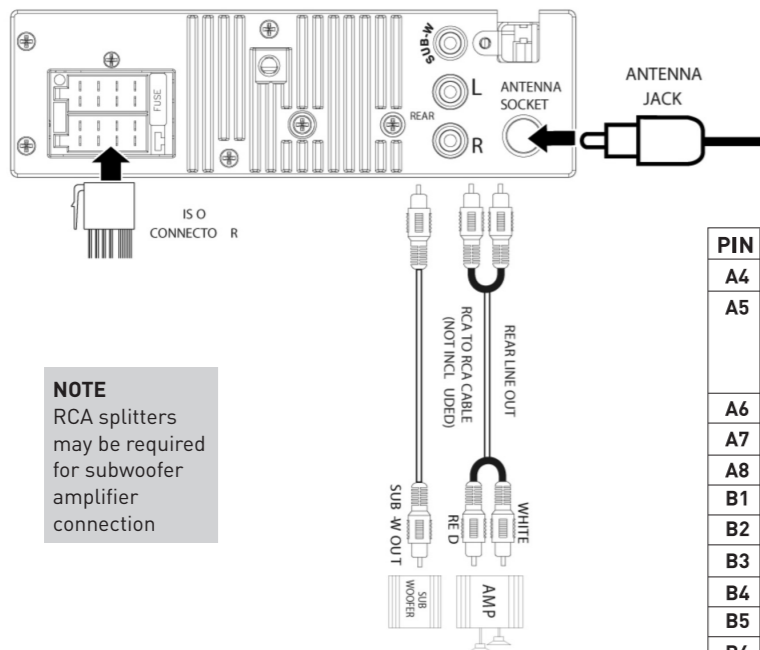

#### NOTE

RCA splitters may be required for subwoofer amplifier connection

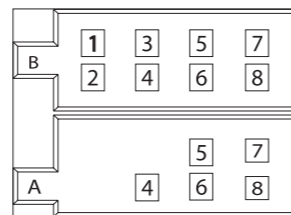
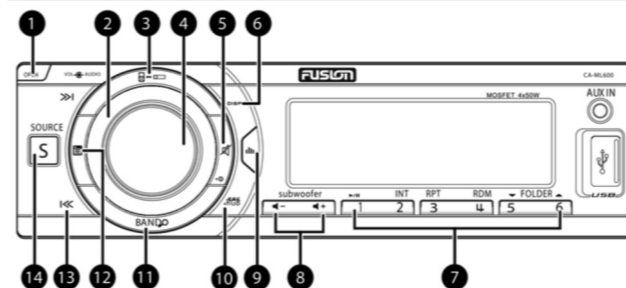

Figure 2

### ISO CONNECTOR WIRING DIAGRAM

PIN	WIRE COLOUR	FUNCTION/LABEL
A4	YELLOW	12V CONSTANT(+)
A5	BLUE	CONNECT TO SYSTEM CONTROL TERMINAL OF THE POWER AMP OR AUTO ANTENNA RELAY CONTROL TERMINAL (max 150mA 12VDC)
A6	ORANGE/WHITE	DIMMER
A7	RED	12V ACCESSORIES (+)
A8	BLACK	GROUND
B1	VIOLET	RIGHT REAR SPEAKER(+)
B2	VIOLET/BLACK	RIGHT REAR SPEAKER(-)
B3	GREY	RIGHT FRONT SPEAKER(+)
B4	GREY/BLACK	RIGHT FRONT SPEAKER(-)
B5	WHITE	LEFT FRONT SPEAKER(+)
B6	WHITE/BLACK	LEFT FRONT SPEAKER(-)
B7	GREEN	LEFT REAR SPEAKER(+)
B8	GREEN/BLACK	LEFT REAR SPEAKER(-)

## BASIC OPERATIONS



### 1. OPEN

Press this button detach the control panel.

### 2. ENCODER VOLUME CONTROL

Rotate the encoder volume to increase and decrease the volume.

### 3. iPod/iPhone INTERNAL/EXTERNAL CONTROL

Press this button to switch between iPod/iPhone control from either the unit or from the device itself.

### 4. ENCODER VOLUME CONTROL AUDIO/ENTER FUNCTIONS

- AUDIO. Press this button to enter the Audio Menu mode.
- ENTER. In Media playback mode and Menu functions, press this button to confirm a selection (ENTER).

### 5. MUTE - POWER ON/OFF

- Press this button to turn Mute ON or OFF
- Press this button to turn the unit on. Press and hold to turn the unit off.

### 6. DISP - DISPLAY

a) In MP3/WMA playback mode, press to display ID3 information: Track number and elapsed play Time -> File -> Album -> Title -> Artist.

b) In iPod/iPhone playback mode, press to display Album -> Title -> Artist

### 7. NUMERIC BUTTONS

a) In the Tuner mode, press the Numeric buttons to recall the preset stations. Press and hold these buttons for 2 seconds to store stations.

b) In Media playback mode, Press the Numeric buttons to perform the operations below:

Number	1	2	3	4	5	6
Button	Pause/Play	Intro	Repeat	Random	Folder Up	Folder Down

### 8. SUBWOOFER - DIRECT SUBWOOFER LEVEL CONTROL

When a subwoofer is connected; use the DSLC buttons to adjust the subwoofer level up or down.

### 9. EQ

Press this button to select the preset equaliser settings: FLAT->POP->USER->DANCE->ROCK->CLASSIC->JAZZ->VOCAL

### 10. ESC/RGB

a) ESC - ESCAPE. Press to quick return previous menu or mode rather than having to cycle through all of the options in the menu.

b) RGB - 32K+ RGB COLOUR. Press and hold this button to

access the 32k+ variable colour setting mode. See Page 10 for more information

### 11. BAND/SEARCH

a) In Tuner mode, press this button to cycle through Bands: FM1, FM2, FM3, AM1 (MW1) or AM2 (MW2).

b) In Media playback mode, press to access the folder / file search mode.

c) In iPod/iPhone playback mode, press this button to access the iPod/iPhone search functions.

### 12. MENU

Press to access the system menu. See Page 9 for menu options.

### 13. TUNE UP/DOWN, FILE & TRACK UP/DOWN & FAST FORWARD/BACK

a) TUNE UP/DOWN. In tuner mode, press this button to Auto Seek to the next station or press and hold this button to manually tune in to your desired station.

b) FILE & TRACK UP/DOWN. In CD or USB/SD media playback mode, press these buttons to skip a chapter, track or file.

c) FAST FORWARD/BACK. In USB/SD media playback mode, press and hold momentarily to fast forward/rewind.

### 14. SOURCE BUTTON

Press the Source Button to cycle through the following sources if available: Radio: CD: USB: SD: AUX

## AUDIO FUNCTIONS

All Audio functions are easily accessible on the CA-ML600.

**AUDIO MENU.** Press the ENCODER VOLUME CONTROL to access the Audio Menu mode. Then press **ENTER** or **TUNE UP >>>** to select the Audio Function to be adjusted, then rotate the ENCODER VOLUME CONTROL to select the desired setting. You can always return to the previous Audio Function by pressing the **TUNE DOWN <<<** button.

#### REMINDER

In the AUDIO MENU, or in any menu, you can quickly exit the menu by pressing the ESC/RGB button

**EBX ON/OFF:** Turn ON or OFF the EBX (Encounter Bass Xtender) Bass Boost.

**BAS** Adjust the Bass level between -7 to +7.

**TRE** Adjust the Treble level between -7 to +7.

**BAL (Balance)** Adjust the balance between the right and left speakers from 12R (full right) to 12L (full left).

**FAD (Fader)** Adjust the fader between the front and rear speakers from 12R (full rear) to 12L (full front).

#### (SUBWOOFER)

**SW ON/OFF** Turn On or Off the Subwoofer RCA output.

**SW LPF** Subwoofer low pass crossover: 80/120/160Hz

**SWAM ON/OFF** In AM mode, turn ON or OFF the Sub output.

#### NOTE

If the Subwoofer RCA output is set to "OFF", then the SW LPF & SWAM functions will not be displayed.



## EQUALISER OPERATION

When you activate the Equaliser, the Pre-Set Equaliser settings override your existing Bass, Midrange & Treble Settings.

Press the Equaliser button repeatedly to cycle through the following pre-sets: FLAT→POP→USER→DANCE→ROCK→CLASSIC→JAZZ→VOCAL

To return to the Bass & Treble settings that were in use before the EQ was selected, please select the USER setting.

## SYSTEM MENU

Press  (MENU) to access the System Menu and press again to select the item to be adjusted, then rotate Encoder Volume Knob to select a value / option. To exit this menu at any time, press the ESC/RGB button 

### STORE (Auto store)

While in Tuner mode, press the ENCODER VOLUME CONTROL to activate Auto Store. The six strongest stations of the selected band will be saved in the preset channels automatically

### RDS ON/OFF

While in Tuner mode, this selection turns On or Off RDS. RDS Functions are explained in more detail on Page 8. If RDS is set to OFF, then the RDS Functions indicated below with an \* will not appear in the System Menu

### PTY\* (Program Type)

Press the ENCODER VOLUME CONTROL to enter program type, then rotate the ENCODER VOLUME CONTROL to select the category.

### AF\* ON/OFF

Turn On or Off the Alternate Frequencies function.

### TA\* ON/OFF

Turn On or Off the Traffic Announcement function.

### REG\* ON/OFF

Turn On or Off the Set Region for Alternate Frequencies function

### CT\* ON/OFF

Turn On or Off the CT function.

### LOC\* ON/OFF

(Local/Distance). Use this setting to Auto Seek to strong local stations (Local) or all stations regardless of their strength (Distance).

### AREA

Select your country/region for the tuner: OCEANIA (Australia/New Zealand); USA; EUROPE; RUSSIA & press ESC/RGB  to save.

### CLK (Clock)

To set the clock, rotate the Encoder Volume Control to set the hours (Note "A" or "P" will be displayed in the top-right hand of the LCD display indicating AM or PM if the Clock is in 12H mode – see below). Press the Encoder Volume control to select "minutes" then rotate the control to set.

### CLK 12H/24H (Clock Format)

Select the time format 12H or 24H

### BEEP ON/OFF

Select On or Off to activate button confirmation beep tones.

## DEMO ON/OFF

Demo mode is activated when the unit is first connected to the vehicle, but is de-activated when the Power Button is pressed. It can, however, be activated again by pressing the Power Button. To stop this feature, set Demo Mode to off.

## COLOUR

This unit is equipped with a 32K+ RGB variable colour display. By rotating the Encoder Volume Control, you can select the system colour from the following options: COLOUR SCAN (default setting); WHITE; GREEN 1; GREEN 2; GREEN 3; AMBER; PINK 1; PINK 2; PURPLE 1; PURPLE 2; BLUE 1; BLUE 2; USER; ORANGE

## USER (USER SELECTED COLOUR):

This allows you to select your choice of display colour from over 32,000 combinations (32K+). When you select USER in the colour menu, press the Encoder Volume Control to then rotate to select the intensity or Red, Green & Blue (from between 0 and 32) to make your own custom colour.

To switch between R (Red), G (Green) and B (Blue) setting modes, push the **TUNE UP** button

Press **ESC/RGB**  button once you have completed your selection.

## RADIO OPERATION

### TUNE INTO A RADIO STATION

1. Press the **SOURCE** button  repeatedly until [RADIO] is displayed on the LCD screen.
2. Select your preferred listening Band (FM or AM) by pressing

**BAND**  . There are 3 FM Bands [FM1] [FM2] [FM3] and 2 AM Bands [AM1] [AM2]. These multiple Bands allow you to store up to 18 FM stations & 12 AM stations in memory (see below).

3. To search for a radio station, press either the **TUNE UP or DOWN**  buttons to search for the next station higher than the current station frequency or lower than the current frequency.

4. To Manually tune to a radio station, press and hold either the **TUNE UP or DOWN**  button until the tuner frequency on the LCD display starts flashing. You can then release the TUNE UP or DOWN button, and press it again repeatedly until you select your desired frequency. After 5 seconds, the display will stop flashing and the unit will be tuned in to that station.

### HOW TO STORE YOUR FAVOURITE STATIONS

1. Select you preferred Band. Generally you would use FM1 or AM1 to save you favourite stations (6 stations per band). If you need to store more stations, you can use FM2/3 or AM2 for AM stations.
2. Tune in to your preferred station as per the steps above
3. Press and hold one of the Preset Station Buttons (1-6) for 2 seconds to store the station. The preset number and [SAVED] will be displayed on the LCD screen.

### TUNE TO A SAVED or PRE-SET STATION

1. Select the relevant BAND
2. Press the Preset Station Number corresponding to your required Pre-Set station.

## RDS OPERATION

The RDS (Radio Data System) function operates only in areas with FM stations broadcasting RDS signals. If you tune to an RDS

station, an RDS icon and information about the presenter, station or program is displayed.

This unit supports the following RDS features:

### (PTY) SELECT PROGRAM TYPE

Before tuning to RDS stations, you can select program type and let the unit search only for programs of the selected category.

Press the **MENU** button to enter the System Menu, press **ENTER** again to confirm and select PTY type & search for that style station. Please see a list of PTY Types & descriptions on P14:

### (AF) SELECT ALTERNATE FREQUENCIES

If the radio signal from the current station is poor, you can turn on the AF (Alternate Frequency) function to let the unit search automatically for another station with a stronger signal but with the same program identification as the current station.

### (TA) RECEIVE TRAFFIC ANNOUNCEMENTS

If you do not want to miss a traffic announcement during music playback, you can turn on the TA (Traffic Announcement) function.

**TA ON:** When there is a traffic announcement; the unit switches to the tuner mode (regardless of the current mode) and begins to broadcast the announcement on traffic conditions. When the traffic announcement is over, the unit will return to the previous mode.

**TA OFF:** Traffic announcement does not cut in.

### (REG) REGION FOR AF TUNING

**REG ON:** Only stations in the current region will be tuned to automatically.

**REG OFF:** All stations can be tuned to automatically

### (CT) CLOCK TIME

Turn CT on to set the clock time using RDS data. Turn CT off to set the clock time manually.

## iPod/iPhone OPERATION

This unit is equipped with iPod/iPhone control which allows you to directly control and charge iPod/iPhones using the units controls – with display of iPod/iPhone track information appearing on the unit's LCD display.

Please read below for more detailed operation.

### CONNECTING AN iPod OR iPhone

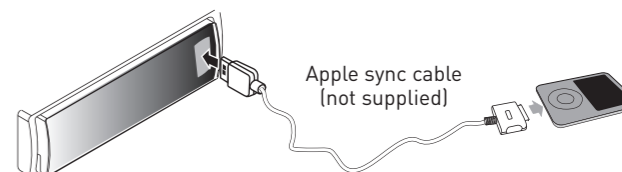

Insert the Apple Sync cable to the Front USB socket as shown and the unit will start playing the iPod/iPhone automatically

### BASIC SEARCH – PLAYLIST/ARTIST/ALBUM/SONG on iPod/iPhone

Press **BAND**  to browse the iPod/iPhone menu.

Then rotate the Encoder Volume Control clockwise to and press **ENTER** to choose one of the following selections, then follow the steps below:

**PLAYLIST** Rotate the Encoder Volume control to select your desired Playlist and press **ENTER** to start play.

**ARTIST** Rotate the Encoder Volume Control to select your

desired Artist then press ENTER. Rotate the Encoder Volume Control to then select an Album & press ENTER. Rotate the Encoder Volume Control again to select a song within the selected Album.

**ALBUM** Rotate the Encoder Volume Control to select your desired Album and press ENTER to select it. Then rotate the Encoder Volume Control to select a specific song within the selected Album.

#### SEARCH FOR FURTHER CONTENT on iPod/iPhone

In addition to the PLAYLIST/ARTIST/ALBUM search functions, there are also additional fields you can search on your iPod or iPhone – the full list of fields is as follows:

**PLAYLIST / ARTIST / ALBUM / SONG / GENRE / COMPOSER / AUDIOBOOK / PODCAST**

3. Rotate the Encoder Volume knob to select the desired search field, then press ENTER to confirm.

4. Rotate the Encoder Volume knob to select the desired selection within the field then, press ENTER to confirm.

#### NOTE

When searching for Album, Artist, Song etc, rotate the Encoder Volume Control clockwise to search from A-Z or anti-clockwise for Z-A search.

#### RANDOM PLAY

Press **RDM** to cycle between the following modes:

RDM FLD – Plays the current album randomly.

RDM ALL – Plays the whole iPod/iPhone library randomly.

RDM OFF – Turns the Random function off.

#### iPod/iPhone MASTER CONTROL MODE

Press the button  to switch between the two control options

- Unit control mode: Use the head unit controls to select Track/Artist/Album/Playlist etc. This is the Default setting.
- iPod/iPhone control mode: Use the iPod/iPhone to select the Artist/Album/Track etc.

This mode is useful if you need to sort through a large amount of Tracks/Albums etc.

#### NOTE

When using an iPhone, the LCD Screen will display [iPod] upon connection to indicate "Music" section of the iPhone is in use.



## MEDIA PLAYBACK (USB/SD/AUX IN)

### MEDIA PLAYBACK

Use the following functions during media playback:

- Press  to pause the music playback. Press this button again to resume music playback.

NOTE the volume level can be adjusted while the unit is paused

- Press the /  to skip forward to the beginning of the next or previous chapter/track.
- Press and hold  to fast forward or fast rewind through the track.

## USB OPERATION

### Insert the USB Device

1. Open the cover marked  on the front panel.

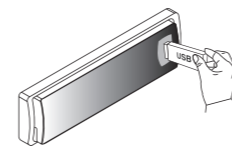

2. Insert the USB device into the USB socket. The unit will start playing from the USB device automatically.

### Removal of the USB Device

Before removing the USB device from the front panel, always remember to switch to another Source then remove the USB device.

## SD CARD OPERATION

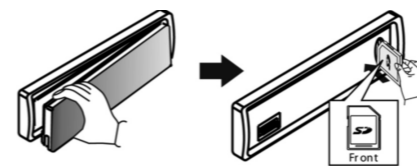

### Insert the SD Card

1. Press the OPEN button to remove the front panel.
2. Hold the left hand side of the panel & pull forward to disengage it from the chassis.

3. Insert the SD card into the slot with label facing left until a "CLICK" sound is heard.

4. Replace the front panel and the unit will start playing files from the card automatically.

### Removal of the SD Card

Detach the face and press the card until you hear a click sound. The card is now disengaged. You can then remove the card.

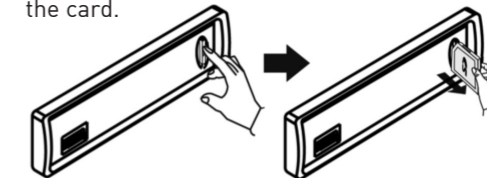

#### NOTE

Please ensure that USB devices & SD cards contain WMA or MP3 files only.

## USING AUX-IN

Connect the external device to AUX in jack using a 3.5mm stereo Aux In cable (not supplied) located on the face, then press the Source button to select AUX mode. Press the Source Button again to select other source options.

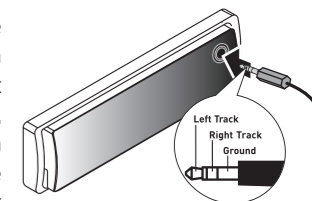

## ADDITIONAL MEDIA PLAYBACK FUNCTIONS (CD/USB/SD)

### PLAY OPTIONS

#### MP3/WMA File or Folder Search

- Press the **BAND**  button on front panel access the MP3/WMA file search mode.
- Rotate the Encoder Volume Control to search through all folders on the device then press **ENTER** to make your selection.
- Rotate the Encoder Volume control to select the desired track within the previously selected folder and press **ENTER** to start it playing

### INTRO PLAY

- During playback, press the **INT** button (Preset button 2) to start intro mode. The first 10 seconds of all tracks on the storage media will be played.
- Once you have find a track you like, press **INT** again to resume normal playback.
- To perform Intro Play on files in the current folder only, press & hold the **INT** button while in Intro Mode. [INT] will be displayed on the LCD along with the folder number. When you find your desired, press **INT** Twice to play the track normally.

### REPEAT PLAY

- During playback, press the **RPT** button (Preset button

3) to repeat all tracks on the storage media. [RPT ALL] is displayed.

- If you press **RPT** again, the current track will be repeated only [RPT TRK] will be displayed
- Pressing **RPT** again repeats all tracks in the current folder only [RPT FLD] is displayed
- Once a track is playing in repeat mode, or to check if Repeat is on, press the **RPT** button.
- To Cancel Repeat, press and hold the **RPT** button. The display will revert back to the standard track number & time elapsed display.

### RANDOM PLAY

- During playback, press the **RDM** button (Preset button 4) to display the current Random Play Mode. If Random Play is off, [RDM OFF] will be displayed.
- Press **RDM** again to select Random Play for the current folder only [RDM FLD] is displayed.
- Pressing **RDM** again selects Random Play for all tracks on the storage media [RDM ALL] is displayed.
- To cancel Random Play, press **RDM** to display the current Random Play mode, then press **RDM** again to cancel Random Play

**FOLDER SELECT** 

During music playback, use this button to jump to the previous/next folder on the storage device.

### DISPLAY FUNCTION

During playback, pressing the **DISP** button will automatically cycle through the following information on the file being played on the LCD display:

FOLDER NAME → FILE NAME → ALBUM → TITLE → ARTIST

You can also keep pressing the **DISP** button to find the particular information you are after. Once you have cycled through all of the available track information by continuing to press the **DISP** button, the display will return to the standard Track Number & Time display. If you stop at this point, the Automatic Display function is cancelled.



## TROUBLESHOOTING

Before going through the check list, please check the wiring connection diagram. If problems persist, please consult your Car Audio dealer.

### No power or no sound

- Ignition is not on. Turn the Ignition to “accessories”
- Unit is off - press the power button to activate the unit.
- Fuse is blown. Please replace the fuse.
- If the speakers are connected to the speaker outputs, check the speaker connections.
- If the speakers are connected to amplifier/s only, check that they are operating correctly.
- If the above solutions do not help, please press the RESET button.

### Noise in radio broadcasts

- Signals are too weak, turn LOC off.
- Check the antenna connection or replace the antenna if necessary.

### Preset stations lost

- Yellow power cable is not correctly wired. Ensure it is connected to Constant 12V (+).

### Display shows ERR-1

- The USB or SD device cannot be read. Confirm the device is formatted to FAT32 (Windows) file system.

### Display shows ERR-3

- USB/SD data error. Check to ensure only MP3 or WMA files are loaded on the storage devices.

### Display shows ERR-5

- Communication error. The USB/SD device could be damaged or corrupted. Please re-format (Fat32 only) or try a different device.

## HOW TO RESET THE UNIT

Using the Reset button, you can reset the unit to its default settings.

- The RESET button is located on the main unit (as shown on the diagram). Press it in with a ballpoint pen or metal object to activate it.

- The reset button can be used under the following circumstances:

1. Initial installation of the unit when all wiring is completed.
2. If the unit “freezes”.
3. To RESET the unit to the factory configuration
4. Error indication on the LCD display.

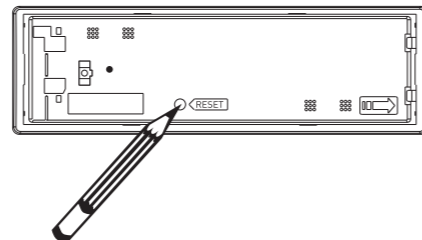

## RDS PROGRAM TYPES & DESCRIPTIONS

NEWS	News services
AFFAIRS	Politics & current affairs
INFO	Special information programs
SPORT	Sports
EDUCATE	Education and advanced training
DRAMA	Radio plays and literature
CULTURE	Culture, religion and society.
SCIENCE	Science programming
VARIED	Entertainment programs
POP M	Pop music
ROCK M	Rock Music
EASY M	Easy listening music
LIGHT M	Light classical music
CLASSICS	Classical music
OTHER M	Special music programs
WEATHER	Weather information
FINANCE	Finance programs
CHILDREN	Children's programs
SOCIAL	Social affairs
RELIGION	Religion
PHONE IN	Talkback
TRAVEL	Travel programs
LEISURE	Leisure
JAZZ M	Jazz music
COUNTRY	Country music
NATION M	National music
OLDIES M	Old time music
FOLK M	Folk music
DOCUMENT	Documentary
A-TEST	Alarm Test
ALARM	Alarm function

## PRODUCT SPECIFICATIONS

Power Supply	12V DC (11-16V), Negative Ground
Fuse	15A
Suitable Speaker	4 – 8Ω
Impedance	
Power output	MOSFET 50W MAX x 4 channels
RMS output	22W x 4 @ 10% THD
Pre-AMP output	2.0 V (USB play mode; 1KHZ, 0dB, 10 k Ω load)
Aux-In level	≥300mV
iPod/iPhone	
Charging	USB, 1A

### RADIO

-FM	
Frequency Range	87.5 – 108MHz, 50kHz Step (Oceania) 87.5 – 107.9 MHz 200kHz Step (USA) 87.5 – 108.0 MHz 50kHz Step (Europe) 87.5 – 108 MHz (FM 1/2) (Russia) + 65MHz – 74MHz (FM3) (Russia)
Usable Sensitivity	Better than 15dB at S/N 30dB
-AM(MW)	
Frequency Range	522 –1620KHz (Oceania) 530 – 1710 KHz (USA) 522 – 1620 KHz (Europe) 522 – 1620 KHz (Russia)
Usable Sensitivity	Better than 45dB

### USB DEVICES:

USB flash memory USB 1.1 & 2.0 compatible

## SUPPORTED FILE FORMATS

MPEG1/2/2.5	Layer 2/3
WMA Version	7/8/9
Sampling frequency	
MPEG1	32/44.1/48 kHz
MPEG2	16/22.05/24 kHz
MPEG2.5	8/11.025/12KHz
WMA	22/32/44/48KHz
Sampling Bit rate	
MP3/WMA	32-320Kbps & VBR
ISO9660 Level	1 / 2 & Joliet (unicode)
Max File/DIR. Count	999
Max DIR. Depth	255
Sorting Method	Tree sorting
Max File/DIR. Name	64Byte
ID3	V1.0/1.1/2.0/2.3 (Max 32 Byte)
MP3 dir shown in manual as	"Folder"
MP3 file referred to as	"Track".
Maximum length of file name	28 characters.
Maximum length of directory	16 characters.
Supports	Multi-Session recording.

NOTE: Product specifications are subject to change without prior notice.

## LICENSING



"Made for iPod and "Made for iPhone" mean that an electronics accessory has been designed to connect specifically to iPod or iPhone respectively, and has been certified by the developer to meet Apple performance standards. Apple is not responsible the operation of this device or its compliance with safety and regulatory standards. Please note that the use of this accessory with iPod or iPhone may affect wireless performance. Apple is not responsible for the operation of the device or its compliance with safety and regulatory standards.

iPod and iPhone are trademarks of Apple inc., registered in the U.S. and other countries.



Windows Media and the windows logo are trademarks, or registered trademarks of Microsoft Corporation in the United States and/or other countries.

## REGISTER YOUR PRODUCT ONLINE:

For your own peace of mind, register your product purchase online at [www.fusionelectronics.com](http://www.fusionelectronics.com)

We'll keep you up to date with any news related to your product or new accessories to help you get the most from your product.

By registering your product you can be assured that if the unexpected occurs we'll have your details and be ready to help.

## THE FUSION PROMISE OF QUALITY

### LIMITED 1 YEAR CONSUMER WARRANTY

FUSION Electronics Limited 'FUSION' warrants this FUSION Speaker, Subwoofer, Amplifier Head Unit or genuine FUSION Accessory 'product' is free from defects in material and workmanship, according to the following terms and conditions:

- The limited warranty for the FUSION product purchased extends to the first twelve (12) months beginning on the date of purchase of the product.
- The limited warranty extends only to the original consumer purchaser (consumer) of the product and is not assignable or transferable to any subsequent purchaser/end user.
- The limited warranty extends only to consumers who purchase the product in one of the countries (or areas) set forth on www.fusionelectronics.com. The limited warranty is only valid in FUSION'S intended country (or area) of sale of the product.
- During the limited warranty period, FUSION or its authorised service network will repair or replace, at FUSION or FUSION'S authorised dealer, any defective product or parts thereof with new and return the product to the consumer in working condition. No charge will be made to the consumer for either parts or labour in repairing or replacing the product. All replaced parts and cosmetic parts should be free of defects at the time of shipment and, therefore shall not be covered under these limited warranty terms.
- Repaired product will be warranted for the balance of the original warranty period or for ninety (90) days from the date of repair, whichever is longer.
- All warranty claims must be accompanied with a copy of this warranty card, and a copy of proof of purchase date.

**The consumer shall have no coverage or benefits under this limited warranty if any of the following conditions are applicable:**

- The product has been subject to: abnormal use, abnormal conditions, improper storage, exposure to excessive moisture or dampness, exposure to excessive temperature or other such environmental conditions, unauthorised modifications, unauthorised connections, unauthorised repair including but not limited to use of unauthorised spare parts in repairs, misuse, neglect, abuse, accident, alteration, improper installation, acts of God, spill of foods or liquids, maladjustment of customer controls or other acts which are beyond the reasonable control of FUSION, including deficiencies in consumable parts such as fuses, and breakage or damage to antennae unless caused directly by defects in materials or workmanship, and normal wear and tear of the product.
- FUSION was not notified by the consumer of the alleged defect or malfunction of the product during the applicable limited warranty period.
- The product serial number or the accessory date code has been removed, defaced or altered.
- The product was used with or connected to an accessory not supplied by FUSION or fit for use with FUSION product, or used in a manner other than its intended use.

**If a problem develops during the limited warranty period, the consumer should take the following step-by-step procedure:**

1. The consumer shall return the product to the place of purchase for repair or replacement processing.
2. The consumer shall also be charged for any parts or labour charges not covered by this limited warranty. The consumer shall be responsible for expenses related to reinstallation of the product.
3. If the product is returned to FUSION after the expiration of the warranty period, FUSION'S normal service policies shall apply and the consumer will be charged accordingly.

THE BENEFITS CONFERRED BY THIS LIMITED WARRANTY APPLY TO THE EXTENT THAT THEY ARE NOT SUPERCEDED BY ANY OTHER RIGHTS AND REMEDIES UNDER ANY APPLICABLE LEGISLATION THAT CANNOT BE EXCLUDED. OTHERWISE, TO THE EXTENT PERMITTED BY LAW, ANY IMPLIED WARRANTY IS EXCLUDED AND THE FOREGOING WARRANTY IS THE PURCHASER'S SOLE AND EXCLUSIVE REMEDY AND IS IN LIEU OF ALL OTHER WARRANTIES, EXPRESS OR IMPLIED. TO THE EXTENT PERMITTED BY LAW, FUSION SHALL NOT BE LIABLE FOR INCIDENTAL OR CONSEQUENTIAL DAMAGES OR A LOSS OF ANTICIPATED BENEFITS OR PROFITS, OUT OF USE OR INABILITY TO USE THE PRODUCT.

- Some states in America do not allow the exclusion or limitation of consequential damages, so the above limitation and exclusion may not apply to you. This warranty gives you specific legal rights which may vary from state to state.
- FUSION neither assumes nor authorises any authorised service centre or any person or entity to assume for it any other obligation or liability beyond that which is expressly provided for in this warranty.
- All warranty information, product features and specifications are subject to change without notice.

## AUSTRALIAN CONSUMERS

### LIMITED 1 YEAR CONSUMER WARRANTY

Fusion Electronics Pty Limited, Unit 21/130 Kingston Road, Underwood, Queensland, 4119, Australia.

EMAIL: [australia@fusionelectronics.com](mailto:australia@fusionelectronics.com) PHONE: 1300 736 012

THE FUSION PROMISE OF QUALITY LIMITED 1 YEAR CONSUMER WARRANTY

**This warrant is given in addition to other rights and remedies available to the consumer under Australian Consumer Law. In addition to the Fusion Warranty our goods come with guarantees that cannot be excluded under the Australian Consumer Law. You are entitled to a replacement or refund for a major failure and for compensation for any others reasonably foreseeable loss or damage. You are also entitled to have the goods repaired or replaced if the goods fail to be of acceptable quality and the failure does not amount to a major failure.**

FUSION Electronics Limited 'FUSION' warrants this FUSION Product including Speaker, Subwoofer, Amplifier Head Unit or genuine FUSION Accessory 'product' is free from defects in materials and workmanship, in accordance with the following terms and conditions:

- The limited warranty for the FUSION product purchased is only available for (12) months after the date of purchase.
- The limited warranty extends only to the original consumer of the product and may not be assigned or transferred to any other person or consumer without Fusion's prior written consent being provided.
- During the limited warranty period, FUSION or its authorised service network will repair or replace any defective or faulty product or parts at its own cost.
- Repaired or replaced product will be warranted for the balance of the original warranty period or for ninety (90) days after the date of repair, whichever is longer.
- All warranty claims must be notified to Fusion or its authorised Dealer in writing during the warranty period accompanied with a copy of this warranty card, proof of purchase date and the product with an intact and unaltered serial number or accessory date code.

This Warranty will not apply if:

The consumer causes the Product to be of unacceptable quality or fails to take steps to prevent the Product from becoming of unacceptable quality and/or it is damaged by abnormal use. Examples of goods becoming of unacceptable quality or of abnormal use by the consumer include:

- Storage of product under improper conditions.
- Exposure to excessive moisture or dampness.
- Exposure to excessive temperature extremes or other adverse environmental conditions.
- Unauthorised modifications of product, connections or otherwise unauthorised repairs including, but not limited, to the use of unauthorised parts in the repair of products
- Improper use of or installation of, or interference with, product adjustments or controls and or including antenna breakage or damage due to misuse
- Damage caused by consumables or by electricity supply.
- Acts of god (force majeure), exposure of product to food spills, or any other type of fluid ingress
- Using the product in a way for which was not intended to be used or connecting it to an accessory not supplied by, specified by, or authorised by Fusion
- Any other abnormal use of or conduct causing product to become of unacceptable quality

Other exclusions;

- This warranty extends to the repair or replacement of Fusion product only and the consumer is responsible for any expenses relating to the removal or installation of the product or related services including the cost of delivering the product to Fusion or its authorised dealer.
- Repair work conducted by Fusion after this warranty has expired or if this warranty for any other reason this Fusion warranty does not apply is subject to Fusion's normal service policies and Fusion charges for labour and material may apply.
- This is a manufacturers warranty provided to consumers of Fusion products. Variations to this warranty may only be made by Fusion and will be notified to the customer in writing or issued on the Fusion website. Fusion Dealers, agents and authorised dealers are not authorised to make changes or vary this Fusion warranty.
- All warranty information, product features and specifications are subject to change without notice.
- Fusion is not responsible for replacing or the cost of replacing any consumer data lost occurring either due to equipment failure, or during the repair and replacement process.

## LA PROMESSE DE QUALITE FUSION

## GARANTIE LIMITEE 1 AN

FUSION Electronics Limited, « FUSION », garantit ce haut-parleur, caisson de basses, amplificateur ou accessoire FUSION authentique contre tout défaut de matériaux et de main-d'œuvre conformément aux conditions générales énoncées ci-après :

- La garantie limitée couvrant le produit FUSION acheté est valable douze (12) mois à compter de la date d'achat dudit produit.
- Seul l'acheteur initial (client) du produit peut faire valoir la garantie limitée, qui n'est ni cessible ni transférable à un quelconque autre acheteur/utilisateur final.
- Seuls les clients achetant le produit dans l'un des pays (ou régions) listés sur [www.fusionelectronics.com](http://www.fusionelectronics.com) peuvent faire valoir la garantie limitée. La garantie limitée n'est valable que dans les pays (ou régions) de vente du produit prévus par FUSION.
- Pendant la période de garantie limitée, FUSION ou son réseau de SAV agréé répare ou remplace, à la discrétion de FUSION ou du distributeur FUSION agréé, tout produit défectueux ou pièce du produit en question par un produit ou pièce neuf et retourne le produit en état de marche au client. Aucuns frais ne sont facturés au client pour les pièces ou la main-d'œuvre en cas de réparation ni pour le remplacement du produit. Toutes les pièces remplacées et toutes les pièces d'habillement devraient être exemptes de défauts au moment de l'expédition et ne seront donc pas couvertes par la présente garantie limitée.
- Les produits réparés sont garantis pendant la durée restante de la garantie initiale ou pendant quatre-vingt-dix (90) jours à compter de la date de la réparation, si cette durée est supérieure à la durée de garantie restante.
- Toutes les réclamations au titre de la garantie doivent être envoyées avec une copie de cette carte de garantie et une copie de la preuve de la date d'achat.

La garantie limitée est annulée si :

- Le produit : a été utilisé de manière ou dans des conditions anormales, rangé de manière inappropriée, exposé à une humidité ou température excessive ou à des conditions ambiantes similaires, modifié sans autorisation, connecté de manière non autorisée, réparé de manière non autorisée y compris, sans que cela soit limitatif, en utilisant des pièces de rechange non agréées, soumis à un usage abusif, négligé, endommagé accidentellement, altéré, mal installé, endommagé dans une catastrophe naturelle, par de la nourriture ou des liquides, du fait d'un mauvais ajustement des commandes utilisateur ou par tout acte échappant à la volonté de FUSION, y compris la défaillance des consommables tels que les fusibles et la rupture ou l'endommagement des antennes, à moins que cela ne soit la conséquence directe d'un défaut de matériaux ou de main-d'œuvre, et a subi une usure normale.
- FUSION n'a pas été informée par le client du défaut ou de la défaillance présumé du produit pendant la durée de garantie limitée applicable.
- Le numéro de série du produit ou le code de date de l'accessoire a été effacé, dégradé ou altéré.
- Le produit était utilisé avec ou connecté à un accessoire non fourni par FUSION ou incompatible avec le produit FUSION, ou a été utilisé pour un usage autre que celui pour lequel il est prévu.

**En cas de problème pendant la durée de la garantie limitée, le client devra suivre la procédure suivante :**

1. Le client doit retourner le produit au lieu d'achat pour réparation ou remplacement.
2. Le client doit assumer tous les frais de pièces ou de main-d'œuvre non couverts par la garantie limitée. Le client doit assumer le coût de réinstallation du produit.
3. Si le produit est retourné à FUSION après expiration de la période de garantie, la politique de SAV habituelle de FUSION s'applique et le client sera facturé en conséquence.

LES PRESTATIONS AU TITRE DE CETTE GARANTIE LIMITEE SONT ASSUREES DANS LA MESURE OU ELLES NE SONT PAS REMPLACEES PAR UN QUELCONQUE AUTRE DROIT OU RECOURS CONFORMEMENT A TOUTE LOI APPLICABLE NE POUVANT PAS ETRE EXCLUE. DANS TOUS LES AUTRES CAS ET DANS LA MESURE PERMISE PAR LA LOI, TOUTE GARANTIE IMPLICITE EST EXCLUE ET LA GARANTIE DECRITE PRECEDEMMENT EST LE SEUL ET UNIQUE RECOURS DE L'ACHETEUR ET REMPLACE TOUTES LES AUTRES GARANTIES, QU'ELLES SOIENT EXPRESSES OU IMPLICITES. DANS LA MESURE PERMISE PAR LA LOI, FUSION NE PEUT ETRE TENU POUR RESPONSABLE DE TOUT DOMMAGE ACCESSOIRE OU INDIRECT NI DE TOUTE PERTE D'AVANTAGES OU DE PROFITS ESCOMPTES RESULTANT DE L'UTILISATION DU PRODUIT OU DE L'IMPOSSIBILITE DE L'UTILISER.

- FUSION n'autorise aucun SAV agréé, personne ou entité à assumer en son nom des obligations ou une responsabilité autres que celles expressément énoncées dans la présente garantie.
- Toutes les informations de garantie, caractéristiques et spécifications produit peuvent être modifiées sans notification préalable.

## LA PROMESA DE CALIDAD DE FUSION

## GARANTÍA LIMITADA DEL CONSUMIDOR DE 1 AÑO

FUSION Electronics Limited, "FUSION", garantiza que este altavoz, subwoofer, amplificador FUSION o "producto" accesorio auténtico de FUSION no presenta defectos materiales ni de fabricación, según lo estipulado por los siguientes términos y condiciones:

FUSION Electronics Limited, "FUSION", garantiza que este altavoz, subwoofer, amplificador FUSION o "producto" accesorio auténtico de FUSION no presenta defectos materiales ni de fabricación, según lo estipulado por los siguientes términos y condiciones:

- La garantía limitada para los productos FUSION adquiridos se extiende durante los primeros doce (12) meses a partir de la fecha de compra del producto.
- La garantía limitada se aplica solo al comprador consumidor original (consumidor) del producto y no es endosable ni transferible a ningún comprador/usuario final posterior.
- La garantía limitada se aplica únicamente a los consumidores que adquieran el producto en uno de los países (o regiones) expuestos en [www.fusionelectronics.com](http://www.fusionelectronics.com). La garantía limitada solo es válida en los países (o regiones) en los que FUSION tenga intención de vender el producto.
- Durante el periodo de garantía limitada, FUSION o su red de reparación autorizada reparará o sustituirá en FUSION o en un concesionario de FUSION autorizado todo producto defectuoso o piezas del mismo con otros nuevos y devolverá el producto al consumidor en condiciones de utilizarlo. No se le cobrarán al consumidor ninguna pieza ni mano de obra necesarios para reparar o sustituir el producto. Ninguna pieza sustituida ni pieza embellecedora debería presentar defectos en el momento de su envío y, por lo tanto, no estará cubierta en los presentes términos de garantía limitada.
- La garantía del producto reparado se extenderá durante el tiempo restante del periodo original de garantía o durante noventa (90) días a partir de la fecha de reparación, escogiéndose la opción de mayor duración.
- Todas las reclamaciones sobre la garantía han de ir acompañadas de una copia de la presente tarjeta de garantía y una copia justificante de la fecha de compra.

**El consumidor no tendrá la cobertura ni beneficios expuestos en la presente garantía limitada si se da cualquiera de las siguientes condiciones:**

- El producto ha sido objeto de: uso anormal, condiciones anormales, almacenamiento inadecuado, exposición a una humedad excesiva, exposición a una temperatura excesiva u otras condiciones ambientales similares, modificaciones no autorizadas, conexiones no autorizadas, reparaciones no autorizadas, incluyendo pero sin limitarse a, uso de piezas no autorizadas en reparaciones, uso indebido, abandono, abuso, accidente, alteración, instalación incorrecta, causa de fuerza mayor, derrame de alimentos o líquidos, ajuste incorrecto de los controles del cliente u otros actos que estén más allá del control de FUSION, incluida la falta de piezas consumibles tales como fusibles, y la rotura o daños ocasionados a las antenas, salvo que hayan sido causados directamente por materiales o fabricación defectuosos, y el desgaste natural por el uso.
- El consumidor no le notificó a FUSION el supuesto defecto o disfunción del producto durante el periodo de aplicación de la garantía limitada.
- Se ha eliminado, borrado o modificado el número de serie del producto o el código de fecha del accesorio.
- El producto se utilizó con o se conectó a un accesorio no suministrado por FUSION o no adecuado para utilizar con productos FUSION, o se utilizó de una forma diferente a su uso indicado.

**Si surge un problema durante el periodo de validez de la garantía limitada, el consumidor debe seguir paso a paso el siguiente procedimiento:**

1. El consumidor devolverá el producto al lugar de compra para proceder a su reparación o sustitución.
2. El consumidor habrá de pagar toda pieza o mano de obra que no cubra la presente garantía limitada. El consumidor será responsable de los gastos asociados a la reinstalación del producto.
3. Si se devuelve el producto a FUSION después del vencimiento del periodo de garantía, se aplicará la política normal de reparación de FUSION y se le cobrará al consumidor de acuerdo con ésta.

LOS BENEFICIOS CONFERIDOS POR LA PRESENTE GARANTÍA LIMITADA SON DE APLICACIÓN SIEMPRE Y CUANDO NO SEAN SUSTITUIDOS POR OTROS DERECHOS Y RECURSOS BAJO OTRA LEGISLACIÓN QUE NO SE PUEDA EXCLUIR. DE LO CONTRARIO, Y HASTA EL LÍMITE PERMITIDO POR LA LEY, SE EXCLUYE TODA GARANTÍA IMPLÍCITA, Y LA GARANTÍA ANTERIORMENTE EXPUESTA ES EL RECURSO ÚNICO Y EXCLUSIVO DEL COMPRADOR, Y REVOCA CUALQUIER OTRA GARANTÍA, YA SEA EXPLÍCITA O IMPLÍCITA. HASTA EL LÍMITE PERMITIDO POR LA LEY, FUSION NO SE RESPONSABILIZA DE DAÑOS INCIDENTALES NI EMERGENTES NI DE PERDIDAS DE BENEFICIOS O GANANCIAS ANTICIPADAS RESULTANTES DEL USO O DE LA INCAPACIDAD PARA UTILIZAR EL PRODUCTO.

- Algunos estados en EE.UU. no permiten la exclusión o limitación de los daños emergentes, por lo que puede que la limitación y exclusión anteriores no sea de aplicación para usted. Esta garantía le otorga derechos específicos que pueden variar de un estado a otro.
- FUSION no asume ni autoriza a ningún centro autorizado ni persona ni entidad a aceptar ninguna otra obligación o responsabilidad más allá de lo expuesto expresamente en esta garantía.
- Toda la información de garantía, características y especificaciones del producto están sujetas a cambios sin previo aviso.

**LA PROMESSA DI QUALITÀ FUSION****GARANZIA LIMITATA DI 1 ANNO PER IL CONSUMATORE**

FUSION Electronics Limited "FUSION" garantisce questo altoparlante, subwoofer, amplificatore o accessorio originale FUSION ("il prodotto") da difetti dei materiali e di fabbricazione, fatte salve le seguenti clausole:

- La garanzia limitata per il prodotto FUSION acquistato vale per i primi dodici (12) mesi dalla data di acquisto del prodotto stesso.
- La garanzia limitata vale solo per l'acquirente originale ("il consumatore") del prodotto e non può essere assegnata né trasferita a successivi acquirenti o utenti finali.
- La garanzia limitata vale solo per il consumatore che acquistò il prodotto in uno dei Paesi (o delle aree) elencati presso [www.fusionelectronics.com](http://www.fusionelectronics.com). La garanzia limitata è valida solo nel Paese (o nell'area) in cui il prodotto è stato destinato da FUSION alla vendita.
- Durante il periodo di validità della garanzia limitata, FUSION o la sua rete di assistenza autorizzata s'impegna a riparare o sostituire, presso FUSION o un suo rivenditore autorizzato, il prodotto difettoso o le parti difettose di un prodotto e di restituire il prodotto al consumatore in buono stato. Non sarà addebitato al consumatore alcun costo di parti o manodopera incorso da FUSION per la riparazione o sostituzione del prodotto. Tutte le parti funzionali e decorative che siano state sostituite s'intendono prive di difetti al momento della consegna e pertanto non sono coperte a loro volta dalle clausole della presente garanzia limitata.
- Il prodotto riparato sarà garantito per il periodo di validità restante della garanzia o per novanta (90) giorni dalla data di riparazione, qualora la garanzia originale debba scadere entro meno di novanta (90) giorni.
- Tutte le richieste d'intervento in garanzia devono essere accompagnate da una copia di questo cartoncino e della prova di acquisto completa di data.

La garanzia limitata viene a decadere in presenza di una o più delle seguenti situazioni:

- Il prodotto sia stato soggetto a uso anomalo, condizioni anomale, stoccaggio anomalo, esposizione a umidità eccessiva, esposizione a temperature o altre condizioni ambientali al di fuori dai parametri di utilizzo, modifiche non autorizzate, collegamenti non autorizzati, riparazioni non autorizzate, ivi compreso – ma senza limitazione – l'uso di parti di ricambio non autorizzate in tali riparazioni, cattivo uso, negligenza, abuso, incidenti, modifiche, installazione scorretta, eventi riconducibili a cause di forza maggiore, versamento di liquidi o cibi, cattiva regolazione dei comandi da parte del cliente o altre azioni che siano al di fuori del ragionevole controllo di FUSION, compreso il malfunzionamento di materiali di consumo quali i fusibili, e lesioni o danni alle antenne, a patto che non siano causati direttamente da difetti di materiali o di fabbricazione, come pure il normale deterioramento del prodotto.
- FUSION non sia stata informata dal consumatore del supposto difetto o malfunzionamento del prodotto entro la scadenza della garanzia limitata.
- Il numero di serie del prodotto o il codice di data di un accessorio sia stato rimosso, reso illeggibile o alterato.
- Il prodotto sia stato usato insieme a o in collegamento con un accessorio non fornito da FUSION o inadatto all'uso con il prodotto FUSION, o sia stato utilizzato per scopi diversi da quello a cui è destinato.

Qualora si presenti un problema prima della scadenza della garanzia limitata, il consumatore è tenuto a:

1. Restituire il prodotto al punto vendita perché venga riparato o se ne disponga la sostituzione.
2. Farsi carico dei costi di parti e manodopera che non siano coperti da questa garanzia limitata. Farsi carico delle spese relative alla reinstallazione del prodotto.
3. Se il prodotto viene restituito a FUSION dopo la scadenza della garanzia, FUSION farà valere le sue normali clausole di assistenza e addebiterà al consumatore le spese del caso.

LE CLAUSOLE DI QUESTA GARANZIA LIMITATA VIGONO NELLA MISURA IN CUI NON RISULTINO INCOMPATIBILI CON ALTRI DIRITTI O TUTELE PREVISTI DALLE LEGGI VIGENTI CUI QUESTA GARANZIA NON PUÒ SOSTITUIRSI. AD ESCLUSIONE DI QUANTO SUINDICATO, ED ENTRO I LIMITI CONSENTITI DALLA LEGGE, LA PRESENTE GARANZIA FA DECADERE QUALSIASI GARANZIA IMPLICITA O ESPLICITA E DIVIENE L'UNICA ED ESCLUSIVA FORMA DI TUTELA DELL'ACQUIRENTE. ENTRO I LIMITI CONSENTITI DALLA LEGGE, FUSION NEGA QUALSIASI RESPONSABILITÀ PER DANNI DIRETTI O INDIRETTI COME PURA PER LA PERDITA DI BENEFICI O PROFITTI AUSPICATI, ANCHE QUALORA TALI DANNI POSSANO ESSERE RICONDOTTI ALL'USO DEL PRODOTTO O ALL'IMPOSSIBILITÀ DI SERVIRSI DI ESSO.

- FUSION non invita né autorizza che un centro di servizio autorizzato o un qualsiasi altro individuo o entità si faccia carico di obblighi o responsabilità che vadano oltre quelli espressamente previsti dalle clausole della presente garanzia.
- Tutte le informazioni di garanzia, le caratteristiche e le specifiche di prodotto sono soggette a modifiche senza preavviso.

**DAS QUALITÄTSVERSPRECHEN VON FUSION****EINJÄHRIGE BESCHRÄNKTE GEWÄHRLEISTUNG**

FUSION Electronics Limited „FUSION“ garantiert, dass dieser Lautsprecher, Subwoofer oder Verstärker bzw. dieses Originalzubehör von FUSION frei von Material- oder Verarbeitungsfehlern ist und gibt eine Gewährleistung unter den folgenden Bedingungen:

- Die beschränkte Gewährleistung für das FUSION-Produkt beschränkt sich auf die ersten zwölf (12) Monate ab Kaufdatum des Produkts.
- Die beschränkte Gewährleistung gilt nur für den Erstkäufer (Kunde) des Produkts und ist nicht auf nachfolgende Käufer bzw. Endverbraucher übertragbar.
- Die beschränkte Gewährleistung gilt nur für Kunden, die das Produkt in einem der Länder/Gebiete gekauft haben, die unter [www.fusionelectronics.com](http://www.fusionelectronics.com) aufgelistet sind.
- Die beschränkte Gewährleistung ist nur im von FUSION vorgesehenen Verkaufsland/-gebiet gültig.
- Während der beschränkten Gewährleistungsdauer repariert FUSION oder sein autorisierter Fachhändler defekte Produkte oder deren Komponenten oder ersetzt diese durch neue Produkte oder Komponenten und gibt das Produkt funktionstüchtig an den Kunden zurück. Dem Kunden werden weder Arbeitszeit noch Ersatzteile für die Reparatur bzw. den Ersatz des Produkts in Rechnung gestellt. Alle ersetzten und kosmetische Teile sollten zum Zeitpunkt des Versands frei von Defekten sein und sind deshalb nicht durch diese beschränkte Gewährleistung abgedeckt.
- Die Gewährleistungsfrist für reparierte Produkte erstreckt sich über den verbliebenen Zeitraum der ursprünglichen Gewährleistungsfrist oder beträgt neunzig (90) Tage ab Reparaturdatum, je nach dem welcher Zeitraum länger ist.
- Für alle Gewährleistungsansprüche muss eine Kopie dieses Gewährleistungsscheins sowie ein Beleg des Kaufdatums vorgelegt werden.

Unter den folgenden Bedingungen hat diese beschränkte Gewährleistung keine Gültigkeit:

- Unsachgemäße Verwendung des Produkts, unsachgemäße Bedingungen, unsachgemäße Lagerung, übermäßige Feuchtigkeit, übermäßige Temperaturen oder andere unangemessene Umgebungsbedingungen, nicht autorisierte Modifikationen, nicht autorisierte Anschlüsse, nicht autorisierte Reparaturen, einschließlich (ohne Anspruch auf Vollständigkeit) Verwendung nicht autorisierter Ersatzteile, unsachgemäßer Gebrauch, Vernachlässigung, Missbrauch, Unfall, Abänderung, unsachgemäße Installation, höhere Gewalt, Auslaufen von Lebensmitteln oder Flüssigkeiten, unsachgemäße Einstellung der Bedienungselemente oder andere von FUSION nicht vorhersehbarer Vorfälle wie defekte Verbrauchsteile (z. B. Sicherungen) oder defekte oder beschädigte Antennen, die nicht direkt auf Material- oder Verarbeitungsfehlern zurückzuführen sind, sowie normaler Verschleiß des Produkts.
- FUSION wurde während der entsprechenden Gewährleistungsfrist nicht vom Kunden über den angeblichen Defekt bzw. die Fehlfunktion informiert.
- Die Seriennummer des Produkts oder der Zubehörcode wurde entfernt, ausgetrichen oder abgeändert.
- Das Produkt wurde mit einem Zubehörteil verwendet oder an ein Zubehörteil angeschlossen, das nicht von FUSION geliefert bzw. für die Verwendung mit dem Produkt von FUSION nicht geeignet war oder unsachgemäß verwendet wurde.

Wenn während der beschränkten Gewährleistungsfrist ein Problem auftritt, muss der Kunde die folgenden Schritte befolgen:

1. Der Kunde muss das Produkt zur Reparatur bzw. zum Umtausch zur Verkaufsstelle zurückbringen.
2. Dem Kunden werden alle Teile bzw. Arbeitskosten berechnet, die nicht von dieser beschränkten Gewährleistung abgedeckt sind. Der Kunde trägt die Kosten für den Neuaufbau des Produkts.
3. Wenn das Produkt nach Ablauf der Gewährleistungsfrist an FUSION zurückgegeben wird, gelten die normalen Reparaturbedingungen von FUSION, und der Kunde trägt die entsprechenden Kosten.

DIESE BESCHRÄNKTE GEWÄHRLEISTUNG GILT, SOWEIT ANDERE RECHTE UND RECHTSMITTEL DES ANWENDBAREN RECHTS, DIE NICHT AUSGESCHLOSSEN WERDEN KÖNNEN, AN IHRE STELLE TRETEN. SOWEIT GESETZLICH ZUGELASSEN, IST JEDE ANDERE STILLSCHWEIGENDE GEWÄHRLEISTUNG AUSGESCHLOSSEN. DIESE GEWÄHRLEISTUNG IST DAS EINZIGE RECHTSMITTEL DES KÄUFERS UND ERSETZT ALLE ANDEREN AUSDRÜCKLICHEN ODER STILLSCHWEIGENDEN GEWÄHRLEISTUNGEN. SOWEIT GESETZLICH ZUGELASSEN, HAFTET FUSION NICHT FÜR NEBEN- UND FOLGESCHÄDEN ODER DEN VERLUST VORAUSSICHTLICHER VORTEILE ODER GEWINNE INFOLGE DES GEBRAUCHS ODER AUSFALLS DES PRODUKTS.

- Weder FUSION selbst noch andere autorisierte Service-Center bzw. Personen oder juristische Personen sind befugt, andere, als die in dieser Gewährleistung ausdrücklich aufgeführten Verpflichtungen oder Haftungen zu übernehmen.
- Alle Gewährleistungsinformationen, Produktmerkmale und technischen Daten können sich ohne Vorankündigung ändern.

## ОБЕЩАНИЕ КАЧЕСТВА ОТ ФИРМЫ FUSION

## ОГРАНИЧЕННАЯ ПОТРЕБИТЕЛЬСКАЯ ГАРАНТИЯ НА 1 ГОД

Фирма FUSION Electronics Limited ('FUSION') гарантирует, что эта акустическая система, сабвуфер, усилитель или подлинные дополнительные 'приспособления' фирмы FUSION не будут иметь дефектов материала и изготовления согласно следующим условиям:

- Ограниченная гарантия на купленный продукт фирмы FUSION действует в течение первых двенадцати (12) месяцев, начиная с даты покупки продукта.
  - Ограниченная гарантия распространяется только на первичного потребителя-покупателя (покупателя) продукта и не может быть передана или уступлена никакому последующему покупателю/конечному пользователю.
  - Ограниченная гарантия распространяется на покупателей, которые купили продукт в одной из стран (или регионов), указанных на [www.fusionelectronics.com](http://www.fusionelectronics.com). Ограниченная гарантия действительна только в стране (или регионе), в которой данный продукт предназначен фирмой FUSION для продажи.
  - В течение срока ограниченной гарантии, фирма FUSION или уполномоченная ею сеть обслуживания отремонтирует или заменит новым в фирме FUSION или у уполномоченного дилера фирмы FUSION любой неисправный продукт или его детали и возвратит продукт покупателю в рабочем состоянии. С покупателя не будет взята плата ни за детали, ни за работу, ни за замену продукта. Все замененные и косметические детали должны быть без дефектов во время отправки, и поэтому на них не распространяются условия этой ограниченной гарантии.
  - Отремонтированный продукт подлежит гарантии на оставшийся срок первичной гарантии или на девяносто (90) дней с даты ремонта, в зависимости от того, что действует дольше.
  - Все гарантийные претензии должны сопровождаться копией этого гарантийного формуляра и копией подтверждением даты покупки.
- Покупатель не пользуется льготами по этой ограниченной гарантии, если могут быть применены любые из следующих условий:**
- Продукт был подвергнут: неправильному использованию, несоответствующим условиям, неправильному хранению, воздействию чрезмерной сырости или влажности, воздействию чрезмерной температуры или других условий окружающей среды, несанкционированным модификациям, неразрешенным подключениям, несанкционированному ремонту, включая, но не ограничиваясь использованием несанкционированных запасных частей при ремонте, неправильным использованием, небрежностью, злоупотреблением, аварией, переделкой, неправильной установкой, стихийными бедствиями, пролитой едой или жидкостями, неправильной регулировкой покупателем или другими действиями, которые находятся вне разумного контроля фирмы FUSION, включая дефекты используемых деталей, таких как плавкие предохранители, поломку или повреждение антенны, если только они не вызваны непосредственно дефектами материала и изготовления, и обычный износ продукта.
  - Фирма FUSION не была информирована потребителем о заявленном дефекте или неисправности продукта в течение соответствующего срока ограниченной гарантии.
  - Серийный номер или код даты приспособлений был удален, поврежден или изменен.
  - Продукт использовался или был соединен с приспособлением, не поставляемым фирмой FUSION, или не предназначенным для использования с продуктами FUSION, или использовался иным способом, чем тот, для которого он был предназначен.

**Если в период ограниченной гарантии возникла проблема, то покупатель должен последовательно выполнить следующие действия:**

1. Покупатель должен вернуть продукт в место покупки для осуществления ремонта или замены.
2. Покупатель должен оплатить любые детали или работу, на которую не распространяется эта ограниченной гарантией. Покупатель будет нести ответственность за расходы, связанные с повторной установкой продукта.
3. Если продукт был возвращен фирме FUSION после истечения гарантийного срока, для него будут применимы обычные условия обслуживания фирмы FUSION, и с покупателя будет взята соответствующая плата.

**Льготы, предоставляемые этой ограниченной гарантией, применимы в такой степени, что они не могут быть заменены какими-либо другими правами и средствами согласно любому законодательству, которые нельзя было бы исключить, другими словами, в пределах закона, исключается любая подразумеваемая гарантия, и вышеупомянутая гарантия является для покупателя единственным и исключительным средством защиты прав вместо всех других гарантий, выраженных или подразумеваемых. В рамках закона, фирма FUSION не несет ответственности за побочные или косвенные убытки или потерю ожидаемой выгоды, вследствие использования или невозможности использования продукта.**

- FUSION не берет на себя и не уполномачивает никакие центры обслуживания, лица или субъекты брать на себя от ее имени никакие другие обязательства или ответственность помимо тех, которые явно предусмотрены этой гарантией.
- Вся гарантийная информация, характеристики и спецификации продуктов могут быть изменены без предупреждения.

## DE FUSION-BELOFTE VAN KWALITEIT

## 1 JAAR BEPERKTE CONSUMENTENGARANTIE

**FUSION Electronics Limited ('FUSION') garandeert dat deze Fusion-speaker, -subwoofer, -versterker of oorspronkelijk Fusion-accessoire ('het product') vrij is van materiaal- en fabricagefouten, overeenkomstig de volgende voorwaarden en bepalingen:**

- De beperkte garantie voor het gekochte Fusion-product beperkt zich tot de eerste twaalf (12) maanden vanaf de aankoopdatum van het product.
  - De beperkte garantie geldt uitsluitend voor de originele aanschaf door de consument van het product en kan niet worden toegewezen of overgedragen aan enige daaropvolgende koper/eindgebruiker.
  - De beperkte garantie geldt uitsluitend voor consumenten die het product hebben gekocht in één van de landen (of gebieden) vermeld op [www.fusionelectronics.com](http://www.fusionelectronics.com). De beperkte garantie is uitsluitend geldig in een land (of gebied) dat door Fusion bedoeld is voor verkoop van het product.
  - Tijdens de beperkte-garantieperiode zal Fusion of haar geautoriseerde servicenetwerk elk defect product of eventuele onderdelen daarvan bij FUSION zelf of bij een door FUSION geautoriseerde dealer repareren of door nieuw vervangen en het product in werkende staat aan de consument retourneren. De consument zal niets hoeven te betalen voor de onderdelen of de arbeidskosten voor het repareren of vervangen van het product. Alle vervangen onderdelen en cosmetische onderdelen moeten op het moment van verzending vrij zijn van defecten en vallen daarom niet onder de voorwaarden van deze beperkte garantie.
  - Het gerepareerde product wordt gegarandeerd voor de resterende dagen van de originele garantieperiode of gedurende negentig (90) dagen na de datum van reparatie, wat het langste is.
  - Alle garantieclaims moeten vergezeld gaan van een kopie van dit garantiebewijs en een kopie van het bewijs van de aankoopdatum.
- De consument heeft geen dekking of voordelen krachtens deze beperkte garantie indien een van de volgende omstandigheden zich voordoet:**
- het product heeft te lijden gehad van: abnormaal gebruik, abnormale omstandigheden, verkeerde opslag, blootstelling aan overmatig vocht of te grote vochtigheid, blootstelling aan te hoge temperatuur of andere dergelijke omgevingsfactoren, niet-geautoriseerde modificatie, niet-geautoriseerde aansluitingen, niet-geautoriseerde reparatie inclusief maar niet beperkt tot gebruik van niet-geautoriseerde onderdelen bij de reparatie, verkeerd gebruik, verwaarlozing, misbruik, ongeluk, verandering, onjuiste installatie, force majeure, gemorst(e) voedsel of vloeistof, verkeerde afstelling van de bediening of andere handelingen die waar Fusion geen controle over heeft, zoals gebreken aan verbruiksonderdelen zoals zekeringen, en breuk of schade aan antennes tenzij deze rechtstreeks zijn veroorzaakt door materiaal- of fabricagefouten, en de normale slijtage van het product.
  - Fusion is niet door de consument ingelicht over het beweerde defect of beweerde slechte werking van het product tijdens de geldende beperkte-garantieperiode.
  - Het productserienummer of de datumcode op het accessoire is verwijderd, onleesbaar gemaakt of veranderd.
  - Het product is gebruikt met of aangesloten op een accessoire dat niet door Fusion is meegeleverd of niet geschikt is voor gebruik met het Fusion-product, of gebruikt op een wijze anders dan het bedoelde gebruik.

**Als er tijdens de beperkte-garantieperiode een probleem ontstaat, moet de consument de volgende stapsgewijze procedure volgen:**

1. De consument zal het product voor reparatie of vervanging naar de plaats van aankoop terugbrengen.
2. Eventuele onderdelen of arbeidskosten die niet door deze beperkte garantie worden gedekt zijn ook voor rekening van de consument. De consument is verantwoordelijk voor de kosten in verband met herinstallatie van het product.
3. Als het product na afloop van de garantieperiode aan Fusion wordt geretourneerd, zal het normale servicebeleid van Fusion gelden en worden de consument dienovereenkomstig kosten berekend.

**DE IN DEZE BEPERKTE GARANTIE BEPAALDE VOORZIENINGEN GELDEN VOOR ZOVER ZE NIET KUNNEN WORDEN VERVANGEN DOOR ENIGE ANDERE RECHTEN EN RECHTSMIDDELEN ONDER ENIGE GELDENDE WETGEVING DIE NIET KAN WORDEN UITGESLOTEN. OVERIGENS WORDT VOOR ZOVER DAT BIJ DE WET IS TOEGESTAAN, ELKE IMPLICITE GARANTIE UITGESLOTEN. DE HIERVOOR VERMELDE GARANTIE IS DE ENIGE EN EXCLUSIEVE GARANTIE VOOR DE KOPER EN VERVANGT ALLE ANDERE UITDRUKKELIJKE OF IMPLICITE GARANTIES. VOOR ZOVER BIJ DE WET TOEGESTAAN, ZAL FUSION NIET AANSPRAKELIJK ZIJN VOOR INCIDENTELE OF GEVOLGSCHADE OF EEN VERLIES VAN VERWACHTTE VOORDELLEN OF WINSTEN UIT HET GEBRUIKEN OF NIET KUNNEN GEBRUIKEN VAN HET PRODUCT.**

- Fusion aanvaardt geen enkele andere verplichting of aansprakelijkheid boven hetgeen uitdrukkelijk in deze garantie is vermeld en autoriseert geen enkel geautoriseerd reparatiecentrum of persoon of eenheid om deze voor haar te accepteren.
- Alle informatie over garantie, productfuncties en specificaties kunnen zonder kennisgeving worden gewijzigd.



**FUSION<sup>®</sup>**

**WWW.FUSIONELECTRONICS.COM**

FUSION Electronics New Zealand	09 369 2900
FUSION Electronics Australia	1300 736 012
FUSION Electronics Europe	+31 76 5723 632
FUSION Electronics USA	623 580 9000
FUSION Electronics Pacific	+64 9 369 2900