

FURUNO

OPERATOR'S MANUAL

BRIDGE ALARM SYSTEM

MODEL **BR-1000**

ECF

(Elemental Chlorine Free)

The paper used in this manual
is elemental chlorine free.

FURUNO ELECTRIC CO., LTD.

9-52 Ashihara-cho,
Nishinomiya, 662-8580, JAPAN

Telephone : +81-(0)798-65-2111

Fax : +81-(0)798-65-4200

• FURUNO Authorized Distributor/Dealer

All rights reserved. Printed in Japan

A : SEP . 2009

Pub. No. OME-44500-A

(DAMI) BR-1000



* 0 0 0 1 6 9 1 8 6 1 0 *

IMPORTANT NOTICES

General

- This manual has been authored with simplified grammar, to meet the needs of international users.
- The operator of this equipment must read and follow the descriptions in this manual. Wrong operation or maintenance can cancel the warranty or cause injury.
- Do not copy any part of this manual without written permission from FURUNO.
- If this manual is lost or worn, contact your dealer about replacement.
- The contents of this manual and equipment specifications can change without notice.
- The example screens (or illustrations) shown in this manual can be different from the screens you see on your display. The screens you see depend on your system configuration and equipment settings.
- Save this manual for future reference.
- Any modification of the equipment (including software) by persons not authorized by FURUNO will cancel the warranty.
- All brand and product names are trademarks, registered trademarks or service marks of their respective holders.

How to discard this product

Discard this product according to local regulations for the disposal of industrial waste. For disposal in the USA, see the homepage of the Electronics Industries Alliance (<http://www.eiae.org/>) for the correct method of disposal.

How to discard a used battery

Some FURUNO products have a battery(ies). To see if your product has a battery(ies), see the chapter on Maintenance. Follow the instructions below if a battery(ies) is used.

In the European Union

The crossed-out trash can symbol indicates that all types of batteries must not be discarded in standard trash, or at a trash site. Take the used batteries to a battery collection site according to your national legislation and the Batteries Directive 2006/66/EU.



In the USA

The Mobius loop symbol (three chasing arrows) indicates that Ni-Cd and lead-acid rechargeable batteries must be recycled. Take the used batteries to a battery collection site according to local laws.

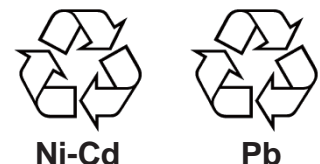



In the other countries

There are no international standards for the battery recycle symbol. The number of symbols can increase when the other countries make their own recycle symbols in the future.











SAFETY INSTRUCTIONS

Read these safety instructions before you operate the equipment.

 WARNING	Indicates a condition that can cause death or serious injury if not avoided.
 CAUTION	Indicates a condition that can cause minor or moderate injury if not avoided.

 Warning, Caution	 Prohibitive Action	 Mandatory Action
--	--	--

 WARNING	
	Do not open the equipment. This equipment uses high voltage that can cause electrical shock. Only qualified persons can work inside the equipment.
	Turn off power at switchboard if the something is dropped inside the equipment. Fire or electrical shock can result if the power remains on.
	Turn off power at switchboard if the equipment is emitting smoke or fire. Fire or electrical shock can result if the power remains on.

 CAUTION	
	Do not disassemble or modify the equipment. Fire, electrical shock or bodily injury can result.
	Do not operate the equipment with wet hands. Fire or electrical shock can result.
	Keep the equipment away from rain, water and water splash. Fire or electrical shock can result if water gets into the equipment.
	Use the correct fuse. Use of a wrong fuse can cause bodily injury or fire.

Warning Label

A warning label is attached to the equipment. Do not remove the label. If the label is missing or damaged, see your dealer about replacement.

 WARNING 
To avoid electrical shock, do not remove cover. No user-serviceable parts inside.
 警告 
感電の恐れあり。 サービスマン以外の方はカバーを開けないで下さい。内部には高電圧部分が多くあり、万一さわると危険です。

Name: Warning Label (1)
Type: 86-003-1011-3
Code No.: 100-236-233-10

TABLE OF CONTENTS

FOREWORD	v
SYSTEM CONFIGURATION	vi
1. HOW THE BRIDGE ALARM SYSTEM OPERATES	1-1
1.1 Bridge Alarm	1-1
1.2 Watch Safety Alarm.....	1-2
2. BRIDGE PANEL	2-1
2.1 Controls	2-1
2.2 How to Turn the Bridge Panel On/Off.....	2-2
2.3 How to Adjust the Brilliance.....	2-3
2.4 Standby Display.....	2-4
2.5 Alarm Sequence	2-6
2.5.1 Bridge alarm	2-6
2.5.2 Watch safety alarm.....	2-7
2.6 Help Area.....	2-9
2.6.1 System failure indications.....	2-9
2.6.2 Operational event indications	2-11
2.6.3 Operation help indications.....	2-12
3. TIMER RESET PANEL, CABIN PANEL	3-1
3.1 Timer Reset Panel.....	3-1
3.2 Cabin Panel.....	3-3
3.2.1 DUTY lamp.....	3-3
3.2.2 ALARM lamp	3-3
4. ADMINISTRATOR MENU (Initial Settings)	4-1
4.1 How to Use the Administrator Menu.....	4-1
4.2 Mode Select (Operation Mode)	4-3
4.2.1 Harbour mode	4-4
4.2.2 Bridge attended mode	4-5
4.2.3 One-man mode	4-6
4.3 Back-up Officer.....	4-7
4.4 Captain Back-up.....	4-7
4.5 Watch Time Interval.....	4-8
4.6 All Back-up Officer Call Interval.....	4-8
4.7 Use Key Beep.....	4-8
5. CALL FUNCTIONS	5-1
5.1 Back-up Officer Call.....	5-1
5.2 Navigation Officer Call.....	5-2
6. MAINTENANCE, TROUBLESHOOTING	6-1
6.1 Maintenance	6-1
6.2 Fuse Replacement	6-2
6.3 Troubleshooting.....	6-3
6.4 How to Check Connection Between Bridge Panel and Cabin Panels.....	6-4

TABLE OF CONTENTS

APPENDIX 1 MENU TREE	AP-1
SPECIFICATIONS	SP-1
INDEX.....	IN-1

FOREWORD

A Word to the Owner of the BR-1000

Congratulations on your choice of the BR-1000 Bridge Alarm System. We are confident you will see why the FURUNO name has become synonymous with quality and reliability.

For over 60 years FURUNO Electric Company has enjoyed an enviable reputation for innovative and dependable marine electronics equipment. This dedication to excellence is furthered by our extensive global network of agents and dealers.

Your equipment is designed and constructed to meet the rigorous demands of the marine environment. However, no machine can perform its intended function unless properly operated and maintained. Please carefully read and follow the operation and maintenance procedures set forth in this manual.

Thank you for considering and purchasing FURUNO.

We would appreciate feedback from you, the end-user, about whether we are achieving our purposes.

Features

The BR-1000 Bridge Alarm System collectively controls the warning notice from equipment on the bridge and monitors watch officer's presence to prevent marine accidents.

- Complies with IMO Resolution MSC.125(75) for Bridge Navigational Watch Alarm System
- Collectively manages and presents alarm information on the Bridge Panel
- Alarm information is sorted and displayed according to set priority
- Watch safety alarm watches for unattended bridge or operator disability
- Transmits alarm to backup officer if the Officer of the Watch fails to respond to active alarm or emergency call

Software history

BR-1010 Application Program	BR-1010 FPGA Program	BR-1020 Program
2450041-01.xx Initial version 06/2009	0650117-01.xx Initial version 06/2009	2450040-01.xx Initial version 06/2009

xx=minor change

SYSTEM CONFIGURATION

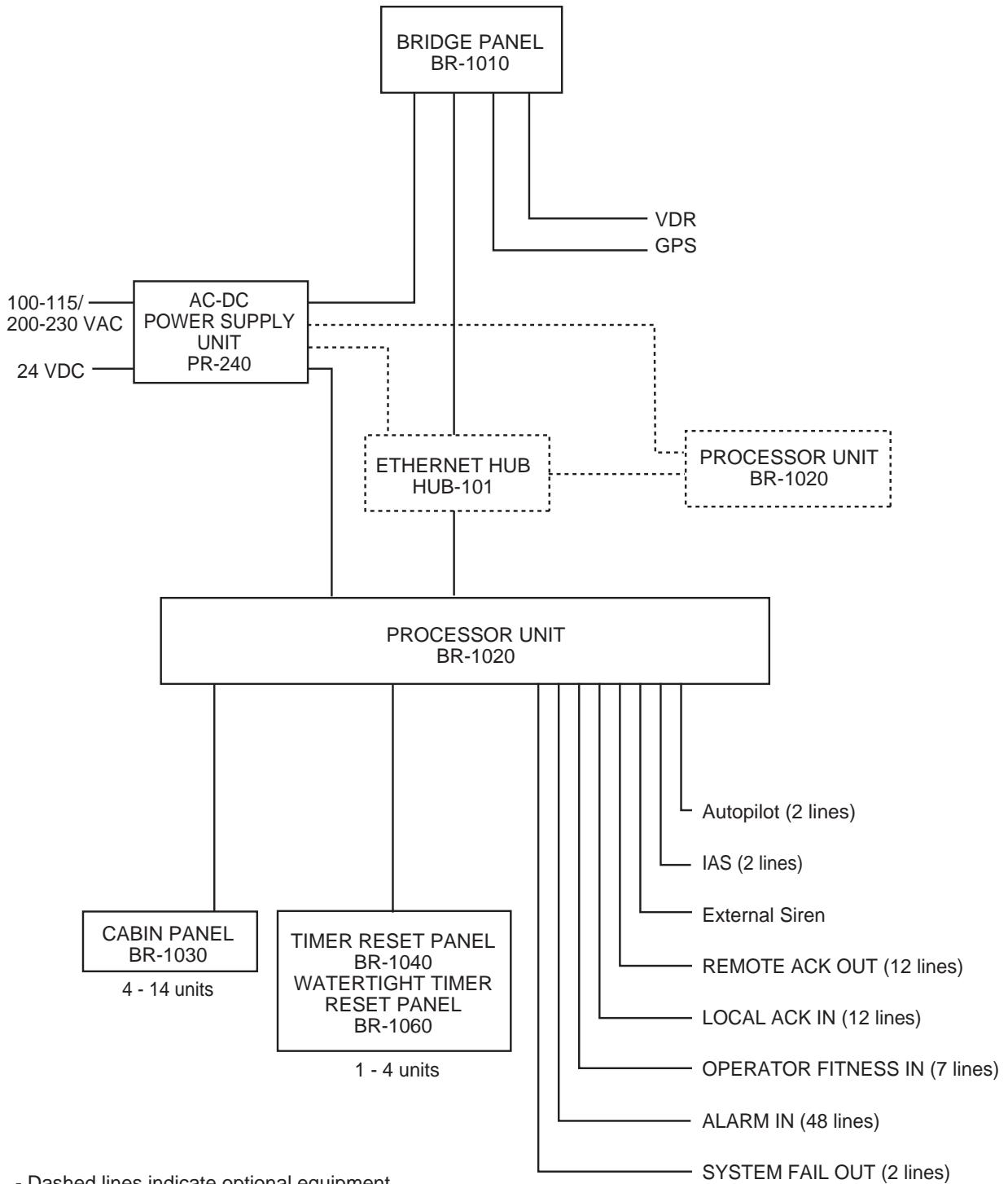

- Dashed lines indicate optional equipment.
- Environment category: All units protected from weather.

1. HOW THE BRIDGE ALARM SYSTEM OPERATES

The FURUNO BR-1000 Bridge Alarm System has the following purposes:

- **Bridge Alarm:** Control all warning notices from the navigation equipment installed on the bridge.
- **Watch Safety Alarm:** Monitor bridge activity to detect operator disability which can cause marine accidents.

1.1 Bridge Alarm

The bridge alarm controls all the warning notices from the navigation equipment installed on the bridge. When an equipment gives an alarm, the alarm is sent in three stages.

- **1st stage:** When a device connected to this system sends an alarm, the system gives 30-second long visual (flashing lamp) and audible (buzzer) alarms from the Bridge Panel and the Timer Reset Panel to tell the Officer of the Watch (hereafter called OOW) on the bridge.
- **2nd stage:** If the OOW does not acknowledge the 1st stage alarm, the Cabin Panel in the living quarters of the selected back-up officer and the Cabin Panels fitted in public areas give audible and visual alarms.
- **3rd stage:** if no one acknowledges the 2nd stage alarm within the selected time interval (90-180 s), all the Cabin Panels fitted in living quarters of all navigation officers and public areas give audible and visual alarms.

To stop the audible alarm, press the **BUZ STOP** key on the Bridge Panel. The audible alarm stops at the Bridge Panel, Timer Reset Panel and the equipment that gave the alarm.

After you stop the audible alarm, press the **ACK** key to acknowledge the alarm. The Bridge Panel displays the visual alarm "Pending" and the visual alarm at the Timer Reset Panel is stopped. The "Pending" indication remains on the Bridge Panel until the cause for the alarm is removed. Stop the audible alarm BEFORE you acknowledge the alarm. If the buzzer is not stopped first, the visual alarm is not stopped when you press the **ACK** key.

1. HOW THE BRIDGE ALARM SYSTEM OPERATES

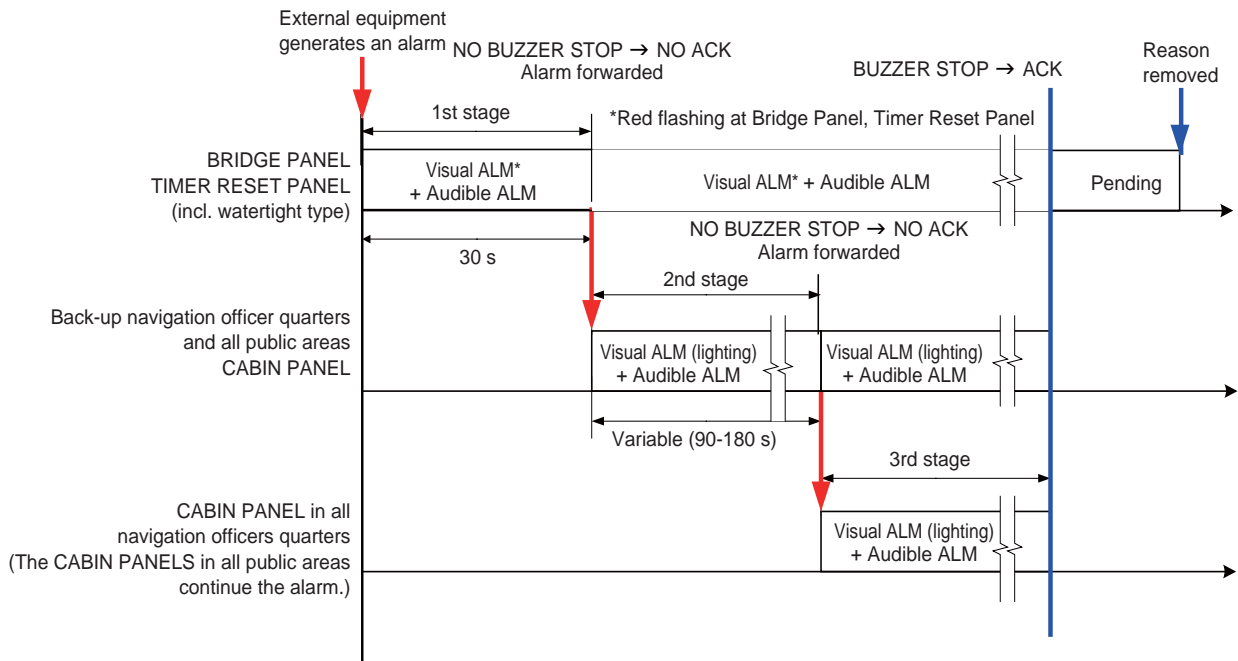

Bridge alarm sequence

1.2 Watch Safety Alarm

The main purpose of the watch safety alarm is to monitor bridge activity on the ship that uses a “one-man bridge”. The system looks for the operation of equipment within the selected time interval (3-12 minutes). The OOW validates operator fitness on the bridge with the **WATCH/RESET** button on the Timer Reset Panel or any operation on the Bridge Panel. The system also acknowledges the presence of the OOW if some equipment connected to the BR-1000 (radar, ECDIS, etc.) is operated. The watch safety alarm has four stages, one a prewarning stage.

- **Prewarning:** If the OOW does not validate operator fitness within the selected time interval, a lamp on the Bridge Panel flashes (in red) and a lamp on the Timer Reset Panel flashes (in yellow) for 15 seconds.
- **1st stage:** If the OOW does not validate operator fitness in the prewarning stage, the lamps flash an additional 15 seconds and a 15-second audible alarm sounds.
- **2nd stage:** If the OOW does not validate operator fitness at the 1st stage, the alarm is sent to the Cabin Panel in the living quarters of the selected back-up officer and all the Cabin Panels fitted in public areas. These Cabin Panels give visual (illuminated lamp) and audible (buzzer) alarms.
- **3rd stage:** If the OOW does not validate operator fitness within the selected time interval (90-180 s), the Cabin Panel in the living quarters of all navigation officers and all the Cabin Panels fitted in public areas give audible and visual alarms (illuminated lamp).

1. HOW THE BRIDGE ALARM SYSTEM OPERATES

The OOW stops the audible alarm and acknowledges the alarm. Then, audible and visual alarms at the Bridge Panel, Cabin Panels and Timer Reset Panel are removed and the watch safety timer is reset.

The interpretation of the prewarning 15-second visual alarm (flashing) and the 15-second visual (flashing) and audible (buzzer) alarms at the 1st stage depends on the mode type selected. The BR-1000 can be configured for IMO (International Maritime Organization) or DNV (Det Norske Veritas, Norwegian classification society).

IMO: Alarm given for 30 seconds AFTER selected time interval elapses.

DNV: Alarm given for 30 seconds BEFORE selected time interval elapses.

The required mode can be selected from the Service menu.

The sequence of the watch safety alarm in each mode is shown in the figures that follow.

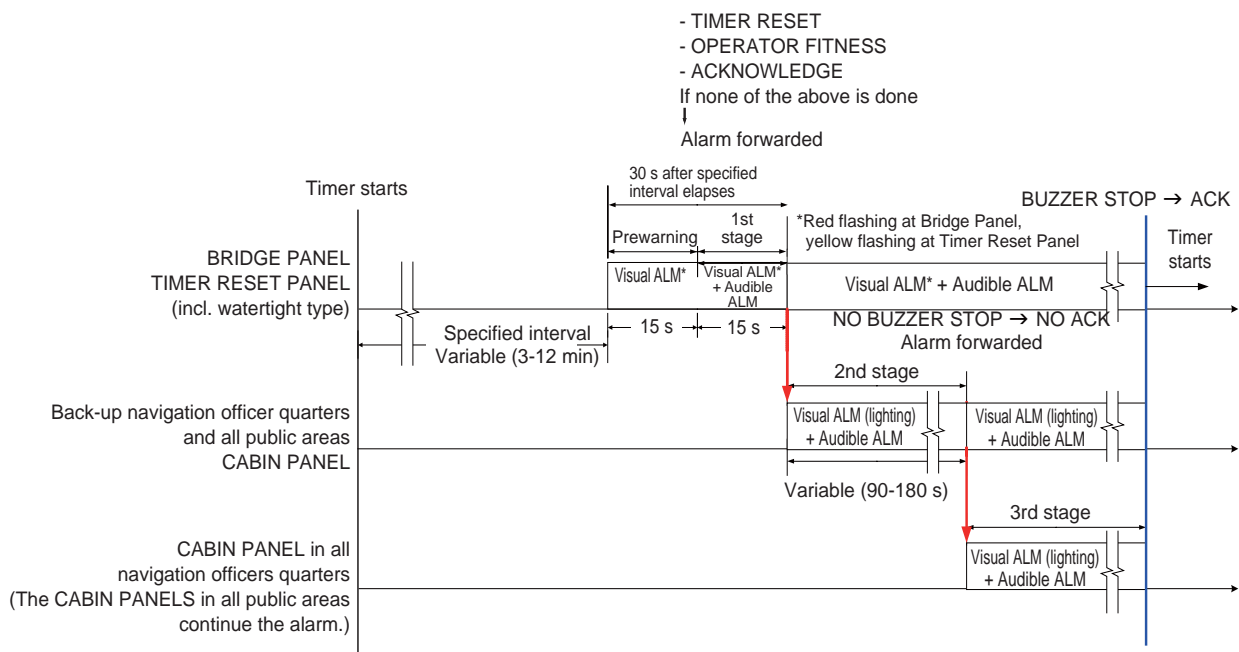

Watch safety alarm sequence (IMO)

1. HOW THE BRIDGE ALARM SYSTEM OPERATES

- TIMER RESET
 - OPERATOR FITNESS
 - ACKNOWLEDGE
- If none of the above is done
↓
Alarm forwarded

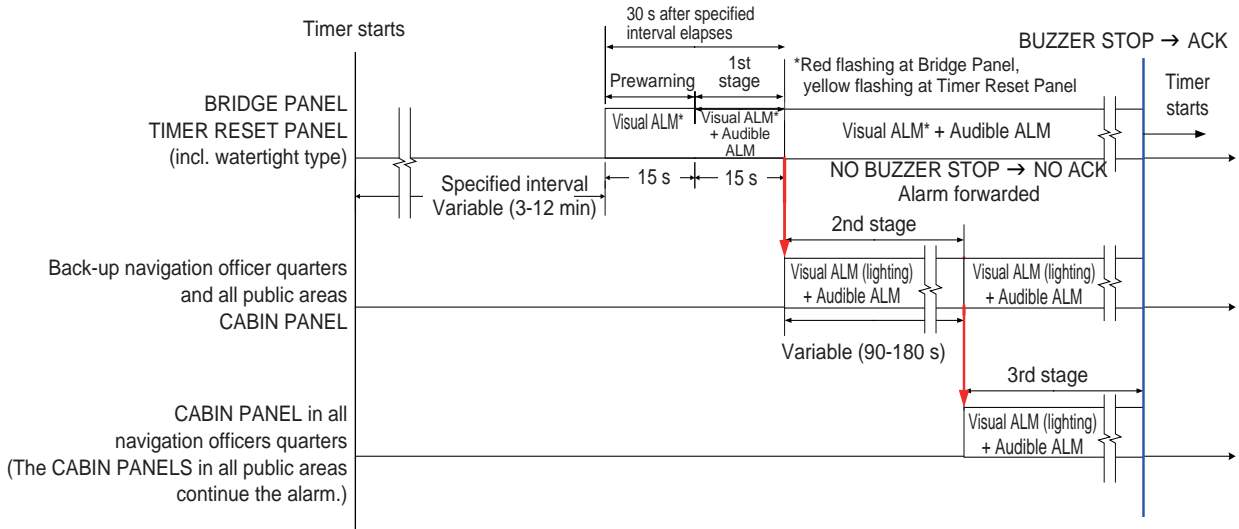

Watch safety alarm sequence (DNV)

2. BRIDGE PANEL

The Bridge Panel is the heart of the bridge alarm system. All settings are done from the Bridge Panel.

2.1 Controls



No.	Control Name	Description
1	BRILL	Turn the power ON and OFF. Adjust the brilliance.
2	Cursor pad, ENTER key	Pad: Select item from the Alarm List, menu, etc. Key: Validate a setting.
3	ESC	Return to previous setting or previous screen.
4	MENU	Open the menu.
5	EDIT	Go to the Alarm List when the bridge alarm display is shown.
6	BUZ STOP	Stop the buzzer on all units connected to this system.
7	LIST	Show the bridge alarm screen.
8	CALL BK-UP	Call the Captain or other navigation officer when there is an emergency.
9	TEST	Test the buzzer.
10	ACK	Bridge alarm: OOW acknowledges a bridge alarm (bridge alarm is then set for "Pending"). Watch safety alarm: OOW acknowledges presence on the bridge.

2.2 How to Turn the Bridge Panel On/Off

Press the **BRILL** key to turn on the Bridge Panel. The start-up screen appears.



The program number is shown and the system checks the ROM and RAM. If the ROM and RAM are normal, OK appears for their check results. If NG (NoGood) appears for any check result, reset the power to try to restore normal operation. If NG still appears, contact your dealer.

Press any key at the start-up screen to go to the standby display (see section 2.4). You can also go to the standby display if you wait 10 seconds after the completion of the start-up check.

To turn off the Bridge Panel, press the **BRILL** key until the power goes off (approx. 10 seconds).

2.3 How to Adjust the Brilliance

The system starts with the last-used brilliance setting. Adjust the brilliance as shown in the procedure below. This procedure adjusts the brilliance in the “no-alarm state”.

1. Press the **BRILL** key to show the brilliance adjustment window.

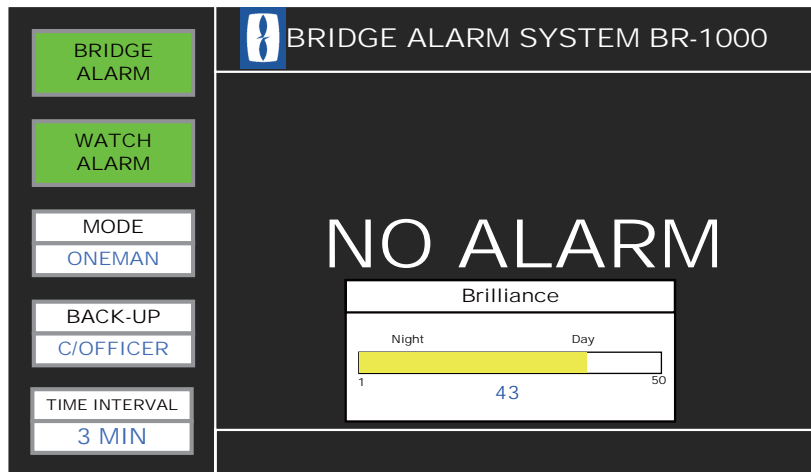

2. Press the right arrow on the Cursor pad to increase the brilliance. The maximum brilliance is “50”.
3. Press the left arrow on the Cursor pad to decrease the brilliance. The minimum brilliance is “1”.
4. Press the **ESC** key to close the window.

Alarm and brilliance level

The system increases the brilliance when the bridge alarm or watch alarm is given. For the bridge alarm, the brilliance is increased by 10, up to a maximum of 50. The brilliance is kept until the cause for the alarm is removed.

For the watch safety alarm, the brilliance is increased by 10, up to a maximum of 50. If the alarm is acknowledged at the 1st stage, the previous brilliance is restored. If an alarm is not acknowledged at the 1st stage (the alarm is then sent to the Cabin Panels), the previous brilliance is restored after the **BUZ STOP** and **ACK** keys are pressed, in that order.

2.4 Standby Display

The standby display appears after the start-up is completed. This display is divided into three areas, information area, status area, and help area.

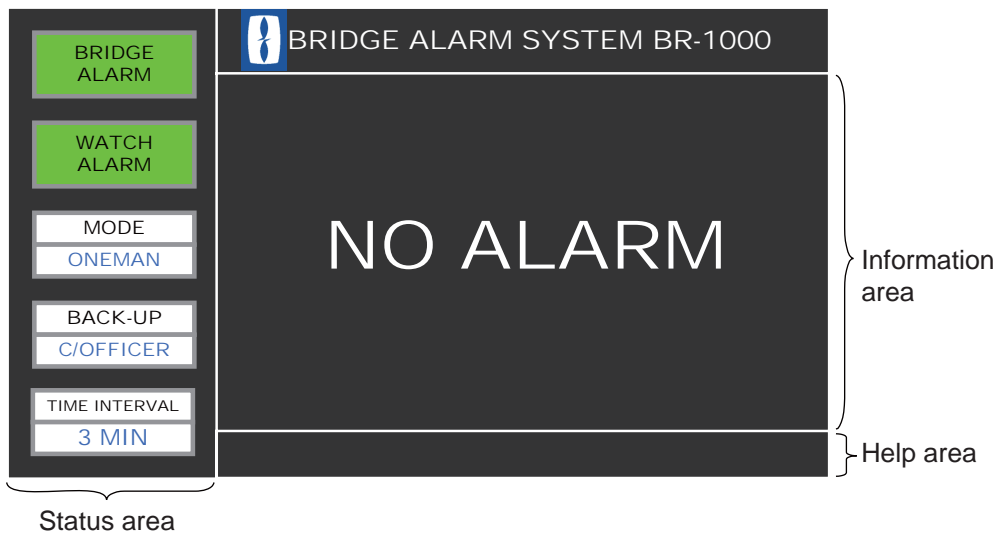

Standby display

Information area

All types of operating information appear here.

Status area

The status area has five boxes which show system status.

BRIDGE ALARM box

- Green: Standby (no bridge alarms)
- Red/Gray flashing: Bridge alarm active
- Yellow: Pending alarm is active
- Gray: Bridge alarm OFF

WATCH ALARM box

- Green: Standby condition (no watch safety alarms)
- Red/Gray flashing: Watch safety alarm active
- Gray: Watch safety alarm OFF

MODE box

- HARBOUR: Harbour mode (When this mode is selected, the buzzer sounds and MODE is colored red. MODE becomes yellow after **BUZ STOP** and **ACK** keys are operated.)
- ATTENDED: Bridge attended mode
- ONE MAN: One-man mode

BACK-UP box

The BACK-UP box shows the name of the back-up officer, for example, C-Officer.

TIME INTERVAL box

The TIME INTERVAL box shows the time interval setting for the 1st stage alarm for the watch safety alarm. The progress bar (yellow) at the bottom half of the box moves right as the end of the interval nears.

Help area

Help for controls, etc. See section 2.6.

2.5 Alarm Sequence

2.5.1 Bridge alarm

- When a device connected to the system gives an alarm, the Bridge Panel gives the audible alarm and flashes the BRIDGE ALARM box in red. The information area shows the name of the alarm.

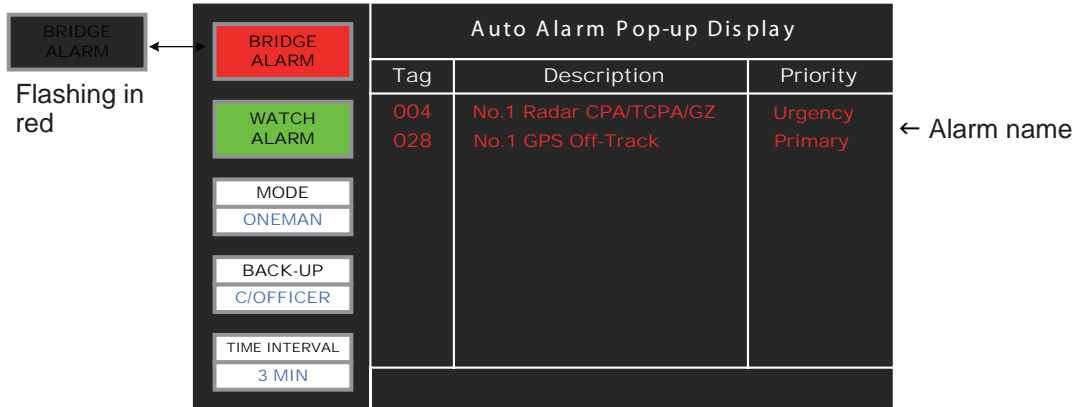

Bridge alarms given

- Press the **BUZ STOP** key on the Bridge Panel to stop the buzzer and the **ACK** key to acknowledge the alarm. Confirm the alarm also at the device that gave the alarm. The Bridge Panel shows the Alarm List, an example of which is shown below.
The buzzer stops only at the equipment which has the Remote ACK Out signal connected to this equipment.
The Alarm List shows in yellow the alarms for which their cause have not yet been removed.

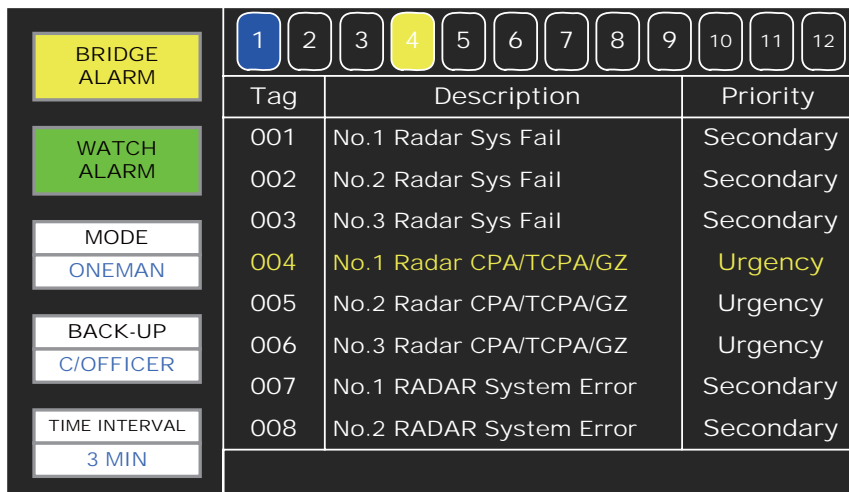

Note: In the one-man mode, if the **BUZ STOP** and **ACK** keys are not operated within 30 seconds after an alarm is given, the alarm is sent to the quarters of the back-up officer and all public areas. If the alarm is still not acknowledged within the selected time interval, the alarm is sent to the quarters of all the navigation officers.

- Press the **ESC** key, and the Bridge Panel shows PENDING ALARM. Pending alarm indicates that an alarm has been acknowledged, but the cause for the alarm has not been removed. The PENDING ALARM indication is erased after the cause for the alarm is removed.

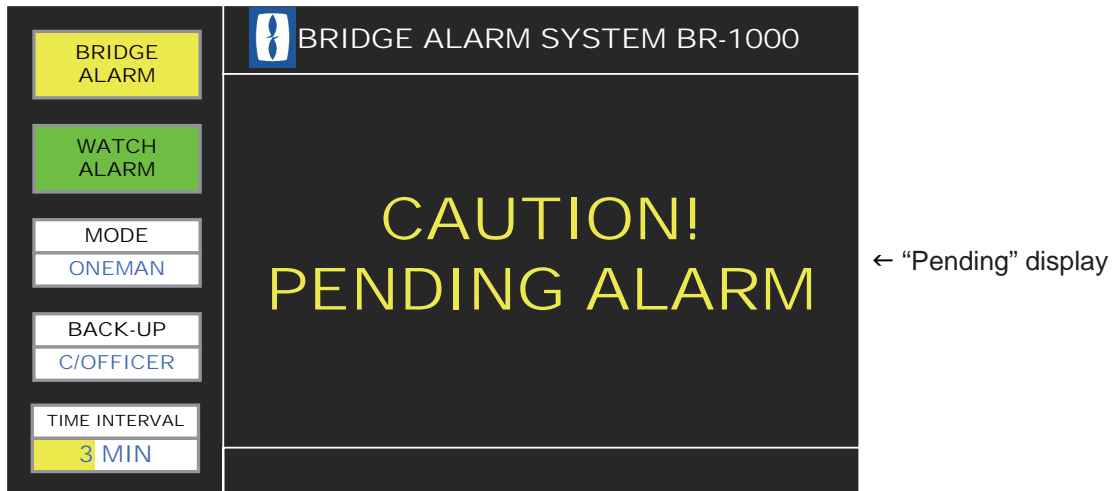

Note: If the Bridge Panel receives a buzzer stop signal from the device that gave an alarm, the buzzer at the Bridge Panel is stopped, but the BRIDGE ALARM box continues to flash (in red). Press the **ACK** key to acknowledge the alarm. If the key is not operated in the one-man mode, the alarm is sent to the Cabin Panels after the time interval has elapsed.

2.5.2 Watch safety alarm

The watch safety alarm checks for the presence of the OOW on the bridge in the one-man bridge operation. If a radar, ECDIS or Bridge Panel is operated within the selected time interval, no alarm is given. If no equipment is operated, the Bridge Panel gives an alarm to tell the OOW. If that alarm is not acknowledged at the bridge, the alarm is then sent to the Cabin Panel in the quarters of the back-up officer and all the Cabin Panels fitted in public areas. If those alarms are not acknowledged, the alarm is sent to the quarters of all navigation officers.

The watch safety alarm is given in the following conditions.

- One-man mode
The watch safety alarm activates when the track control system or heading control system goes on for the attended mode. The watch safety alarm is inoperative in the Harbour mode.
- Operator fitness signal is not input by the OOW
The operator fitness signal is input when a device on the bridge is operated. The following equipment give this signal when operated.

Radar	Operate any key or control.
ECDIS	Operate any key or control other than the trackball.
Bridge Panel	Operate any key.
Other	A device that has the operator fitness signal connected is operated.

2. BRIDGE PANEL

3) If the **RESET/WATCH** key on the Timer Reset Panel is not operated.

Note: The watch alarm timer continues to operate during an active bridge alarm.

The sequence of the watch safety alarm is as follows:

1. After turning on the Bridge Panel and the standby display appears, the timer for the watch safety alarm starts.
The yellow bar in the setting indication in the TIME INTERVAL box (lower left corner) moves right as the end of the selected time interval nears.

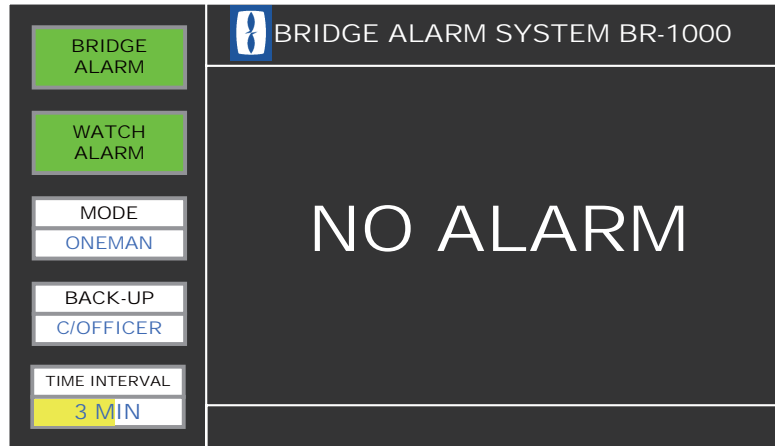

The time interval is set on the Administrator Menu. See Chapter 4.

When the end of the time interval has come, the yellow bar completely fills the bottom half of the TIME INTERVAL box. The timing for the beginning of the alarm is different between the IMO and DNV modes. The time interval indication is filled as follows:

- DNV mode: The progress bar fills the time interval indication area BEFORE the time interval has come.
 - IMO mode: The progress bar fills the time interval indication area AFTER the time interval has come.
2. When the operator fitness signal is input before the progress bar completely fills, the timer is reset and the bar is erased.
 3. The progress bar fills the interval indication and the Bridge Panel releases a 15-second visual alarm. The WATCH ALARM box flashes in red and the message PREWARNING WATCH ALARM appears in the information area.

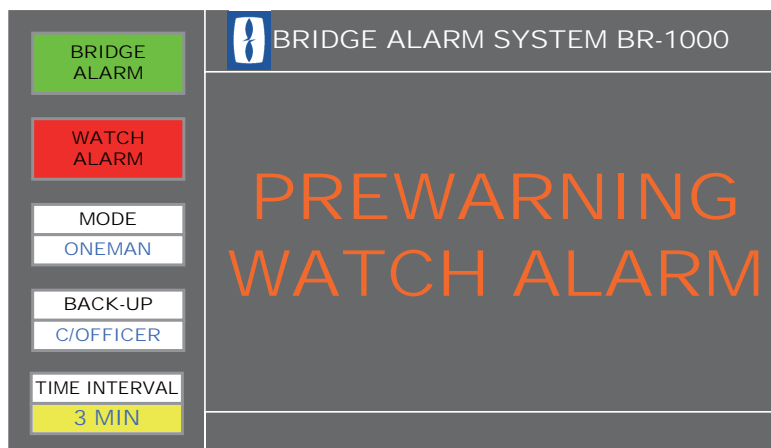

4. If there is no operator fitness signal input within the 15-second visual alarm, the Bridge Panel releases a 15-second audible alarm (buzzer). The WATCH ALARM box continues to flash in red and the message WARNING! WATCH ALARM appears in the information area.

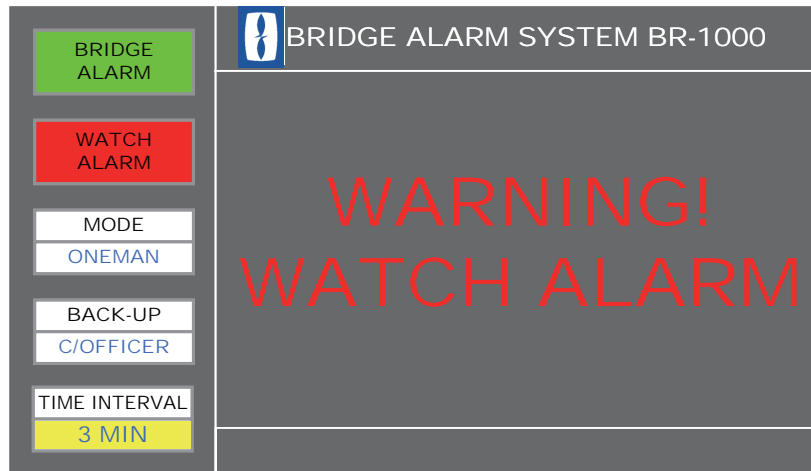

5. If there is no operator fitness signal input within 15 seconds, the Cabin Panel in the quarters of the back-up officer and all the Cabin Panels in public areas give audible and visual alarms.
Note: The alarm cannot be stopped from a Cabin Panel.
6. At the Bridge Panel, stop the buzzer with the **BUZ STOP** key and acknowledge the alarm with **ACK** key. NO ALARM appears in the information area on the Bridge Panel.
Note: Make sure to operate the **ACK** key. The audible and visual alarms are sent to the quarters of all navigation officers and all public areas if only the **BUZ STOP** key is operated.
7. If the operations at step 6 are not done within the selected time interval, the audible and visual alarms are then sent to the Cabin Panel in the quarters of all navigation officers. This interval is set on the Administrator Menu. See Chapter 4.
8. Stop the buzzer and acknowledge the alarm with the **BUZ STOP** and **ACK** keys on the Bridge Panel.

2.6 Help Area

The help area displays system failures, operational events, operation help, etc. If multiple system failures or operational events occur together, they appear in order of priority. The order from high to low is 1: System failure, 2: Operational events, 3: Operation help, 4: Pending matters. "Pending" appears for system failure and operational events, and it means that the reason for an alarm has not been removed.

2.6.1 System failure indications

This section describes how system failures are given and the accompanying operation flow.

- 1) The help area shows system failure messages in red:
[FAIL] YYY: xxxxx (YYY is failure ID, and xxxxx is the description of the system failure). If multiple system failures are found, they are displayed alternately.

2. BRIDGE PANEL

- 2) The buzzer at the Bridge Panel sounds.
There is no visual or audible alarm at the Timer Reset Panel nor is the alarm forwarded to the Cabin Panel.
- 3) Press the **BUZ STOP** key to stop the buzzer.
- 4) Press the **ACK** key to acknowledge the alarm.
- 5) The color of the message changes to yellow.
- 6) The message is erased when the reason for the alarm is removed.

The table below shows the system failure messages.

MSG ID	ID No.	Indication	Problem
FAIL	001	Bridge Panel Operating Fail	Error at Bridge Panel
FAIL	002	No.1 Processor Unit Communication Fail	No connection with No.1 Processor Unit
FAIL	003	No.2 Processor Unit Communication Fail	No connection with No.2 Processor Unit
FAIL	004	No.1 Processor Unit Operating Fail	Problem with command at the No. 1 Processor Unit.
FAIL	005	No.2 Processor Unit Operating Fail	Problem with command at the No. 2 Processor Unit.
FAIL	006	Modbus Time out	Cannot connect with Modbus.
FAIL	007	Modbus Format Error	Modbus format error: - Illegal Function - Illegal Data Address - Illegal Data Value
FAIL	008	PR-240 AC Power Fail	No AC input at PR-240. The system operates with DC power.
FAIL	009	Please check the definition File.	Error found in definition file at equipment startup. Below are the definition file errors. <ul style="list-style-type: none"> • Duplicate part found in Modbus address IO in the definition file. • An address out of address range is found during check of Modbus address setting range and IO address. • Duplicate Cabin Panel names found. • "Type" is set to "Captain" on two or more Cabin Panels.

2.6.2 Operational event indications

When an operational event occurs, the Bridge Panel shows the related message in red in the help area, in the following format:

[OPER] YYY:xxxxxx (YYY is ID No., and xxxx is the message)

Multiple events are displayed alternately.

The table below describes the operational messages.

MSG ID	ID No.	Indication	Event
OPER	001	Harbour Mode Select	Operation mode changed from Attended Mode or One-Man Mode to Harbour Mode.
OPER	002	Watch Safety System is activated	Track Control System or Heading Control System activates.
OPER	003	Press [BUZ STOP] Key to stop buzzer.	<ol style="list-style-type: none"> 1) Buzzer is sounding for bridge alarm in 1st, 2nd or 3rd stage. (Not displayed if buzzer stopped with Local ACK.) 2) Buzzer is sounding for watch safety alarm in 2nd or 3rd stage. 3) Buzzer is sounding for system failure. 4) Buzzer is sounding for operational event in 1st, 2nd or 3rd stage.
OPER	004	Press [ACK] Key	<ol style="list-style-type: none"> 1) Bridge alarm given and buzzer stopped (with BUZ STOP key) at 1st, 2nd or 3rd stage, or buzzer stopped by Local ACK but alarm not acknowledged. 2) Watch safety alarm given and buzzer stopped (with BUZ STOP key) at 2nd or 3rd stage, or buzzer stopped but alarm not acknowledged. 3) System failure given and buzzer stopped (with BUZ STOP key) but alarm not acknowledged. 4) Operational event given and buzzer stopped (with BUZ STOP key) at 1st, 2nd or 3rd stage but alarm not acknowledged.
OPER	005	Press Any Key.	<p>Watch safety alarm given and this indication appears during Prewarning 1 and Prewarning 2 (1st stage) periods. Not displayed if a bridge alarm is currently active.</p> <p>*Not displayed when 001 or 002 occur.</p>
OPER	006	Press [CALL BK-UP] key to stop alarm.	Press CALL BK-UP key to stop buzzer at all Cabin Panels.
OPER	007	The alarm was transmitted. (2nd stage)	<ol style="list-style-type: none"> 1) The Bridge Panel changed the alarm stage from 1st to 2nd. 2) The watch safety alarm stage changed from 1st to 2nd.
OPER	008	The alarm was transmitted. (3rd stage)	<ol style="list-style-type: none"> 1) The Bridge Panel changed the alarm stage from 2nd to 3rd. 2) The watch safety alarm stage changed from 2nd to 3rd.
OPER	009	Press [TEST] key to stop buzzer.	Press TEST key on Bridge Panel to stop buzzer test.

2. BRIDGE PANEL

For ID 001-003, the buzzer at the Bridge Panel sounds and the Timer Reset Panel flashes its **BRIDGE ALARM** button and sounds the buzzer. If the **BUZ STOP** and **ACK** keys are not operated within 30 seconds after an event has occurred, the alarm is then sent to the Cabin Panels.

For ID 004-008, only the lamp flashes (in red). The buzzer is not given and the alarm is not sent to the next stage.

2.6.3 Operation help indications

Operation help is shown in white characters.

[GUID] YYY: xxxxxxx (YYY is ID no., xxxxxxx is the help message)

A help message is erased after you operate the equipment according to the help. Below are the help messages.

MSG ID	ID No.	Message	Meaning
GUID	001	Press [ESC] key to exit.	Use ESC key to exit from currently displayed menu.
GUID	002	Press [LEFT]/[RIGHT] key to select page.	1) Select page when Bridge Alarm Display is shown. 2) Select page when simplified editing display is shown. 3) Select alarm settings when simplified editing display is shown.
GUID	003	Press [UP]/[DOWN] key to select an item.	Use up/down arrow on Cursor pad to select item on menu.
GUID	004	Out of range	You entered a numeric value that is out of specified input range.
GUID	005	Duplicate name exists.	You entered a name that already exists.
GUID	006	Press [ENTER] key to edit	Edit selected Cabin Panel from Cabin Panel Setting menu.
GUID	007	Press [UP]/[DOWN]/[LEFT]/[RIGHT] key	1) Operate arrow pads on Cursor pad to select a Cabin Panel from Cabin Panel Setting Menu. 2) Select a Cabin Panel to call with Nav. Off. Call function.
GUID	008	To select an item.	Continuation of GUID007
GUID	009	Press [ENTER] key to call.	Press the ENTER button to call Cabin Panel selected with Nav. Off. Cal function.

3. TIMER RESET PANEL, CABIN PANEL

3.1 Timer Reset Panel

The Timer Reset Panel is installed on the bridge, and the Watertight Timer Reset Panel is installed on the wing. A total of four can be installed.



TIMER RESET PANEL



WATERTIGHT TIMER RESET PANEL

When the bridge alarm is given

When this system receives an alarm from an external equipment, both the Bridge Panel and the Timer Reset Panel(s) give audible and visual alarms. The BRIDGE ALARM button on the Timer Reset Panel flashes (in red) and the audible alarm sounds.

The Timer Reset Panel cannot stop the buzzer or acknowledge an alarm.

When the watch safety alarm is given

If the WATCH/RESET button is pressed within the selected time interval, the watch timer is reset. If operation is not confirmed within the selected time interval, the WATCH/RESET button flashes (in yellow) and the buzzer sounds. This operation is different between the IMO and DNV modes.

- IMO mode
 - 1) The WATCH/RESET button flashes (in yellow) every second for 15 seconds after the selected time interval ends.
 - 2) The WATCH/RESET button flashes (in yellow) an additional 15 seconds after the selected time interval ends, accompanied by a 15-second audible alarm.

3. TIMER RESET PANEL, CABIN PANEL

- DNV mode
 - 1) The **WATCH/RESET** button flashes (in yellow) every second from 30 seconds before the selected time interval ends and continues until 15 seconds before the interval ends.
 - 2) The **WATCH/RESET** button flashes (in yellow) every second for an additional 15 seconds before the selected time interval ends, accompanied by a 15-second audible alarm.

You can reset the watch alarm at the 1st stage (before the alarm is sent to the next stage) with the **WATCH/RESET** button (yellow) on the Timer Reset Panel. If the alarm is sent to the 2nd or 3rd stage, the alarm cannot be stopped from the Timer Reset Panel. To acknowledge the alarm from the 2nd or 3rd stage, use the **BUZ STOP** and **ACK** keys on the Bridge Panel.

Note 1: Press the **WATCH/RESET** button with a touch-and-release action to reset the watch timer. The watch timer is not reset if the button is pressed and held.

Note 2: You can test the lamps in the buttons and the buzzer individually if you press the **WATCH/RESET** and **BRIDGE ALARM** buttons together.

3.2 Cabin Panel

The Cabin Panel is installed in all navigation officers' quarters and in public areas. The Cabin Panel releases audible and visual alarms when a bridge alarm is given, or the OOW did not confirm presence on the bridge within the selected time interval in the watch safety alarm.



CABIN PANEL

3.2.1 DUTY lamp

One-man mode: The DUTY lamp on the Cabin Panel in the quarters of the back-up navigation officer and public areas is illuminated (in yellow). The illuminated yellow lamp indicates that a Cabin Panel is in the 2nd stage of an alarm sequence.

Harbour or attended mode: The DUTY lamp is not illuminated because no alarms are sent to Cabin Panels in the harbour or attended mode. The lamp lights when the track control system or heading control system goes on in the attended mode.

3.2.2 ALARM lamp

Bridge alarm

One-man mode: The ALARM lamp lights (in red) and the buzzer sounds in the 2nd and 3rd stage of the bridge alarm sequence.

Harbour or attended mode: No visual or audible alarms are generated in these modes.

3. TIMER RESET PANEL, CABIN PANEL

Watch safety alarm

One-man mode: The ALARM lamp lights (in red) and the buzzer sounds in response to an alarm sent to the 2nd and 3rd stage.

Attended mode: The ALARM lamp lights (in red) and the buzzer sounds in the 2nd and 3rd stage when the track control system or heading control system goes on.

Note: You can test the lamps in the buttons and the buzzer if you press the **DUTY** and **ALARM** buttons together. The connection between the Cabin Panel, Bridge Panel are also checked. See section 6.4.

4. ADMINISTRATOR MENU (Initial Settings)

The initial settings set the equipment according to the requirements of your ship. Only the administrator of the system can enter the initial settings. All initial settings are entered from the Bridge Panel, on the Administrator menu.

The following occurs within the system during the input of initial settings.

- The system continues to monitor the bridge and watch safety alarms, but alarms are not generated.
- If an alarm is active, you can open the menu after you acknowledge the alarm with the **BUZ STOP** and **ACK** keys.
- After the menu is closed, the last-used operation modes for the bridge alarm and watch safety alarm are restored. (If a device generates an alarm while the menu is open, the bridge alarms start from the 1st stage after the menu is closed.)

If a device gives an alarm while the menu is open, the timer is reset when the menu is closed. (Alarms are not forwarded when the menu is closed.)

4.1 How to Use the Administrator Menu

The menu is closed if you do not operate a control in 60 seconds.

1. Press the **MENU** key. The message “Enter Password” appears.

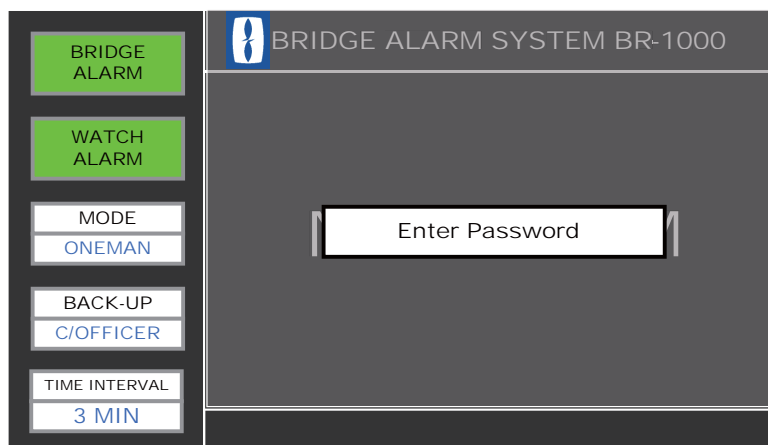

4. ADMINISTRATOR MENU (Initial Settings)

- Press the up, right, down and left arrows on the Cursor pad then press the **ESC** and **LIST** keys to show the Administrator menu. The currently selected item is highlighted in blue.

Administrator Menu	
Description	Set
Mode Select	OneMan
Back-up Officer Select	C/Officer
Captain Back-up	Enable
Watch Time Interval Select (min)	3 min
All Back-up Officer Call Interval (sec)	120 sec
Use Key Beep	Enable

Blue highlight

- Use the up or down arrow to select an item then press the **ENTER** key. An options selection window for the item selected appears.

Mode Select	
◀	OneMan

- Press the same arrow on the Cursor pad that is shown in the window to show available options. If you press the left arrow, other options appear.

Mode Select	
◀	Attended ▶

Mode Select	
	Harbour ▶

- Press the **ENTER** key. The options window closes and the option selected for the item appears in yellow on the menu.

Administrator Menu	
Description	Set
Mode Select	Harbour
Back-up Officer Select	C/Officer
Captain Back-up	Enable
Watch Time Interval Select	3 min
All Back-up Officer Call Interval	120 sec
Use Key Beep	Enable

Selected option (yellow)

- Do steps 3-5 to set other items.

7. Press the **ESC** key to quit. You are asked “Do you want to save?”.

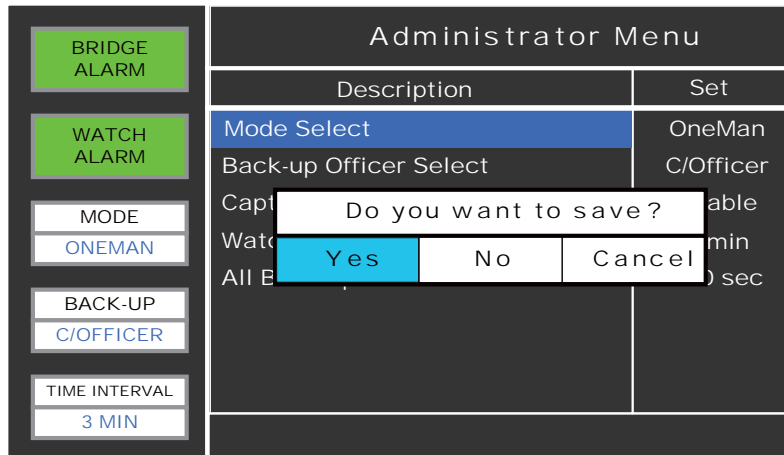

8. Use the arrow pads to select Yes then press the **ENTER** key.

Your settings are saved then the standby display appears. If you select No, the settings are not saved and the Alarm List appears. Use Cancel to return to the Administrator menu.

Note: After the menu is closed, the bridge alarm and watch safety alarm are reset. In the “Pending” condition the menu is open then closed and the bridge alarm starts from the 1st stage. (This also occurs if there is no key operation at the password entry screen for one minute.) if this occurs, use the **BUZ STOP** and **ACK** keys to stop the alarm. If those keys are not operated, the alarm is forwarded to the Cabin Panel.

The next several sections describe the contents of the Administrator menu.

4.2 Mode Select (Operation Mode)

There are three operation modes. The operation of the bridge alarm and watch safety alarm changes with the operating mode.

Operation mode	Bridge alarm				Watch safety alarm			
	HCS* ¹ or TCS* ² : OFF		HCS or TCS: ON		HCS or TCS: OFF		HCS or TCS: ON	
	SYS FUNC* ³	ALM FWD* ⁴	SYS FUNC	ALM FWD	SYS FUNC	ALM FWD	SYS FUNC	ALM FWD
Harbour	OFF	None	OFF	None	OFF	None	OFF	None
Bridge Attended	OFF	None	ON	Yes	ON	None	ON	None
One-Man	ON	Yes	ON	Yes	ON	Yes	ON	Yes

*¹ HCS=Heading Control System

*² TCS=Track Control System

*³ SYS FUNC=System Function

*⁴ ALM FWD=Alarm forward

4.2.1 Harbour mode

Use this mode when you enter a harbor. The bridge alarm system is OFF in this mode. The BRIDGE ALARM box is gray and the Bridge Panel continues to monitor the equipment. If a bridge alarm is generated, the pop-up display appears on the Bridge Panel, but the Bridge Panel and Timer Reset Panel do not release the audible alarm. Alarms are not sent to the Cabin Panels.

The display shown below appears when you change the operating mode to the harbour mode.

- The BRIDGE ALARM and WATCH ALARM boxes are gray. A gray box indicates that the related function is OFF. HARBOUR in the MODE box is red.

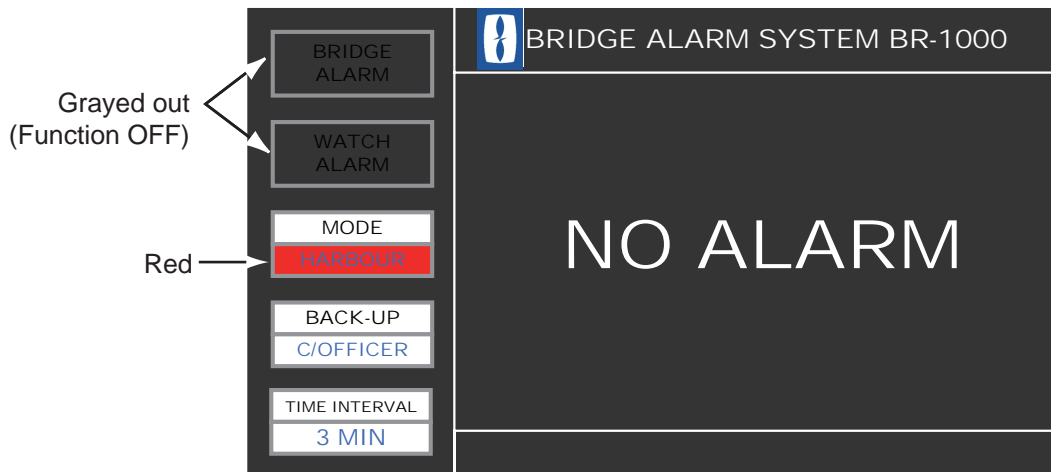

- The buzzer sounds. Press the **BUZ STOP** and **ACK** keys. HARBOUR then is colored yellow.

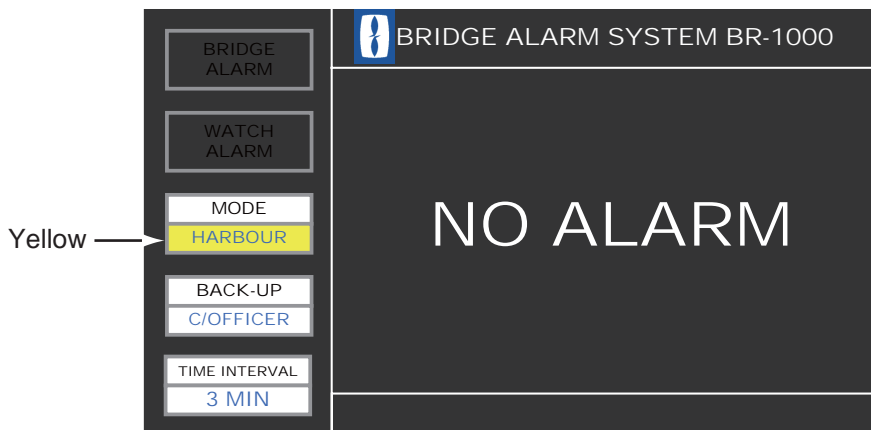

4.2.2 Bridge attended mode

Use this mode when you are underway and more than one navigator (including the Captain) is on the bridge. The BRIDGE ALARM box on the Bridge Panel is green. The WATCH ALARM box is gray and the MODE-ATTENDED box is white.

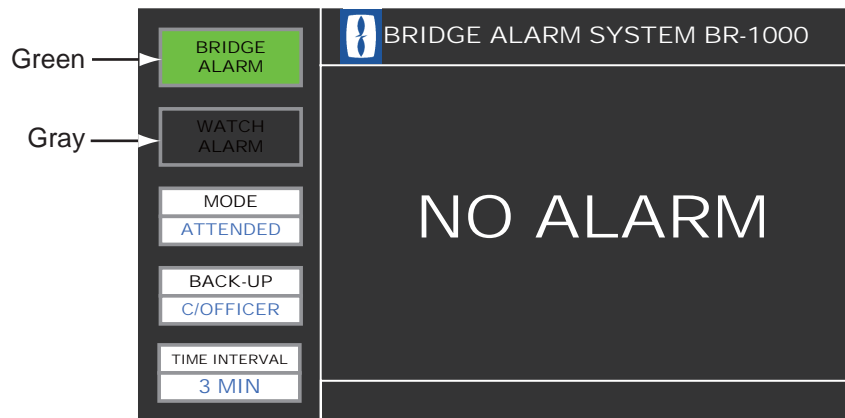

4.2.3 One-man mode

Use this mode on the open sea when only one OOW is on the bridge; for example, nighttime. The BRIDGE ALARM and WATCH ALARM boxes are green. Green means respective function is active. The MODE-ONE MAN box is white.

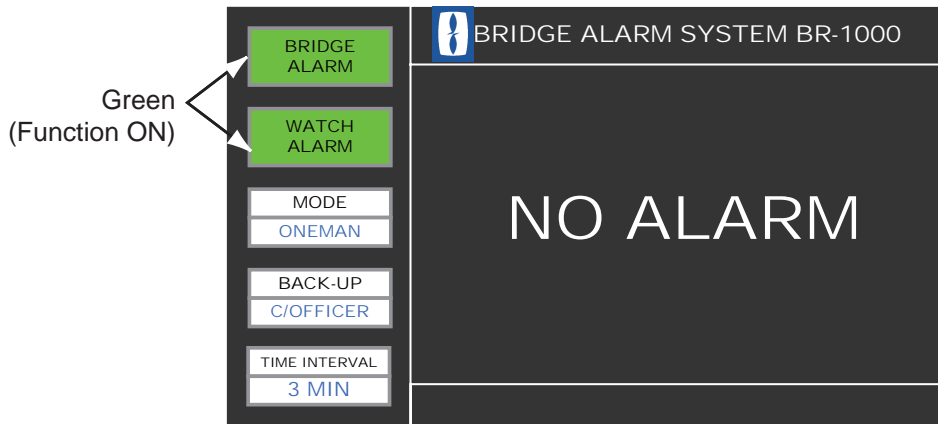

Notes

- The harbour mode is different from the bridge attended mode. The watch safety alarm is OFF always even when the track control system or heading control system is turned ON.
- The watch safety system activates in the bridge attended mode when the Track Control System or Heading Control System is turned ON. When one is turned on, the Bridge Panel operates as follows.
 - 1) When the track control system or heading control system is turned ON, the help area indicates that the watch safety system is activated.
 - 2) The operator presses the **BUZ STOP** and **ACK** keys to stop the buzzer and acknowledge the alarm.
 - 3) The message in the help area disappears.
 - 4) The WATCH ALARM box lights in green and the watch safety system activates.
 - 5) The DUTY lamp lights on the Cabin Panel in the quarters of the back-up navigation officer. Even if the DUTY lamp lights the alarm is not forwarded.
- In the bridge attended mode, the following occurs when the track control system or heading control system is turned off.
 - 1) When track control system or heading control system is turned OFF, the system operates with the selected operating mode.
 - 2) The DUTY lamp goes off on the Cabin Panel in the quarters of the back-up navigation officer and the Cabin Panels in public areas.

4.3 Back-up Officer

When an alarm is generated and the OOW does not acknowledge the alarm, the alarm is sent to the quarters of the back-up navigation officer after the selected time interval has elapsed. This section shows you how to select a back-up navigation officer.

1. Open the Administrator menu, select [Back-up Officer Select] and press the **ENTER** key.
The back-up officer selection window appears. The names shown in the window were set at installation. To change the names, contact a FURUNO agent or dealer.
2. Use the left or right arrow on the Cursor pad to display a name. For example, C/Officer, 1/Officer, 2/Officer, 3/Officer. If those names have been registered, the window looks like the ones shown below.

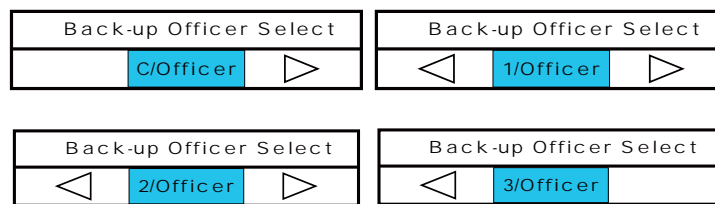

3. Press the **ENTER** key to close the window. The name of the selected back-up officer appears in the Set column in the Administrator menu.
4. Press the **ESC** key to quit. The selected back-up officer appears in the BACK-UP box at the bottom left corner of the screen.



4.4 Captain Back-up

Select whether to include the Captain as a back-up navigation officer. That is, select whether to forward the alarm to the Cabin Panel in the Captain's room in the 2nd stage or the 3rd stage.

Select [Enable] or [Disable]. See the description below.



Selection	Function
Enable	The Captain is included in the 2nd stage. The DUTY lamp lights, and in the 2nd stage the ALARM lamp lights and the buzzer sounds.
Disable	The Captain is not included in the 2nd stage. The DUTY lamp is off. In the 3rd stage, the ALARM lamp lights and the buzzer sounds.

4.5 Watch Time Interval

Set the operation confirmation time for the watch safety alarm. The range is 3-12 (min). If the OOW does not confirm presence within this time period, the alarm is forwarded.

Watch Time Interval Select (min)		
	3 min	▶

The selected interval appears in the TIME INTERVAL box.

TIME INTERVAL
3 MIN

4.6 All Back-up Officer Call Interval

Set the time interval of the 2nd stage. If the **BUZ STOP** and **ACK** keys on the Bridge Panel are not operated within this period, the alarm is forwarded to the 3rd stage. The possible settings are 90, 120, 150 and 180 (seconds).

All Back-up Officer Call Interval (sec)		
	90 sec	▶

All Back-up Officer Call Interval (sec)		
◀	120 sec	▶

All Back-up Officer Call Interval (sec)		
◀	150 sec	▶

All Back-up Officer Call Interval (sec)		
◀	180 sec	

4.7 Use Key Beep

A beep sounds when a key on the Bridge Panel is operated. You can turn this beep on or off.

Use Key Beep		
	Disable	▶

Use Key Beep		
◀	Enable	

Selection	Function
Enable	Beep sounds when a key is operated.
Disable	Beep does not sound when a key is operated.

5. CALL FUNCTIONS

5.1 Back-up Officer Call

The back-up officer call feature allows the OOW to easily call the Captain or other navigator from the bridge when there is an emergency. This function is available in all operation modes and operates independently of the bridge alarm and watch safety alarm.

Operating procedure

1. Press the **CALL BK-UP** key on the Bridge Panel.



- Bridge Panel
 - BRIDGE ALARM box flashes in red.
 - WATCH ALARM box flashes in red.
 - Buzzer sounds.
- Cabin Panel in Captain's room
 - ALARM lamp lights.
 - Buzzer sounds.
- Cabin Panel in the quarters of the back-up navigation officer
 - ALARM lamp lights.
 - Buzzer sounds.
- All Cabin Panels in public areas
 - ALARM lamp lights.
 - Buzzer sounds.

Note: The alarm is not generated by the Cabin Panels in the rooms of officers not selected as back-up navigation officers.

2. If the call is not reset within the time set for the 2nd stage interval (All Back-up Officer Call Interval, see section 4.6), the alarm is generated from the Cabin Panels in the rooms of all navigation officers.
3. Press the **CALL BK-UP** key on the Bridge Panel. The audible and visual alarms are stopped at all units.

Note: This alarm is not generated from the Timer Reset Panel, and cannot be stopped with the **BUZ STOP** and **ACK** keys. The setting for Captain Backup is ignored.

5.2 Navigation Officer Call

The OOW can call the Cabin Panel of the back-up officer or the Cabin Panel in a public area. Use this feature when it is necessary to contact a navigation officer. This feature is available in all modes.

The navigation officer call operates as follows:

1. The ALARM lamp on the called Cabin Panel lights and the buzzer sounds.
2. The officer who received the call (ALARM lamp lights, buzzer sounds) goes to the bridge.
3. The OOW confirms that the called officer has arrived and then cancels the call.

Note: A navigation officer call is canceled when a bridge alarm or watch safety alarm is generated.

Operating procedure

1. Check that the Bridge Panel shows NO ALARM or PENDING ALARM then press the **ESC** key.



The Navigation Officer Call screen appears. A list of all the names of Cabin Panels (set at installation) appears.

	Navigation Officer Call	
	Cabin Panel	Cabin Panel
BRIDGE ALARM	Captain	Public 1
WATCH ALARM	C/Officer	Public 2
MODE	1/Officer	Public 3
ONEMAN	2/Officer	Public 4
BACK-UP	3/Officer	Public 5
C/OFFICER		
TIME INTERVAL		
3 MIN		

Note: This screen is closed if there is no key operation within 60 seconds.

2. Operate the arrows on the Cursor pad to select the officer or public area to call.
3. Press the **ENTER** key. The name of the called Cabin Panel appears in red. The called Cabin Panel's ALARM lamp lights and the buzzer sounds.
4. To call other officers or public areas, repeat steps 2 and 3 to select a Cabin Panel.

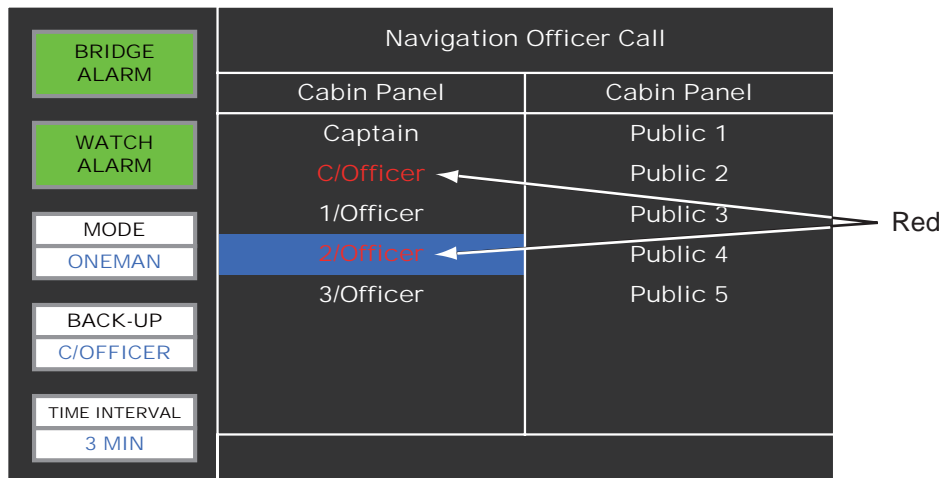

Navigation officer call screen (cabin panels currently being called are shown in red)

Note: When a bridge alarm or watch safety alarm is generated during a navigation officer call, the call is cancelled to process the bridge alarm or watch safety alarm.



5. To cancel a navigation officer call, select the Cabin Panel then press the **ENTER** key.
The highlight is removed from the name of the Cabin Panel, and the audible and visual alarms are stopped at the called Cabin Panel.
6. To cancel all navigation officer calls, press the **ESC** key. The standby display appears.

5. CALL FUNCTIONS

This page is intentionally left blank.

6. MAINTENANCE, TROUBLESHOOTING

This chapter provides maintenance and troubleshooting procedures for the user.

 WARNING	NOTICE
 <p>ELECTRICAL SHOCK HAZARD Do not open the equipment.</p> <p>This equipment uses high voltage that can cause electrical shock. Only qualified persons can work inside the equipment.</p>	<p>Do not apply paint, anti-corrosive sealant or contact spray to plastic parts or equipment coating.</p> <p>Those items contain products that can damage plastic parts and equipment coating.</p>

6.1 Maintenance

Maintenance is important to keep good performance. Check the items shown in the table monthly.

Item	Check point	Comments
Cables	Check that all cables are firmly fastened. Check the cables for corrosion and rust.	Connect the cables that have loosened. Replace any damaged cables.
Cabinet	Dust on the cabinets	Remove dust with a dry clean cloth. Do not use commercial cleaners to clean the equipment. Those cleaners can remove paint and markers.
LCD on Bridge Panel	Dust on the LCD	Wipe the LCD carefully to prevent scratching, using tissue paper and an LCD cleaner. To remove dirt or salt deposits, use an LCD cleaner, wiping slowly with tissue paper so as to dissolve the dirt or salt. Change paper frequently so the salt or dirt will not scratch the LCD. Do not use solvents such as thinner, acetone or benzene for cleaning.

6.2 Fuse Replacement

The fuse in the power cable for the Bridge Panel protects the Bridge Panel from over-voltage and overcurrent. If the power cannot be turned on, check if the fuse has blown. If the fuse has blown, replace the fuse with one of the same rating. If the fuse blows again, contact your dealer.

 **WARNING**

 **Use the proper fuse.**
Use of a wrong fuse can result in damage to the equipment and cause fire.

Name	Type	Code No.
Fuse	FGB0-A 125V 3A PBF	000-155-850-10

6.3 Troubleshooting

If something appears to be wrong with the equipment, follow the procedure in the table below to restore normal operation. If you cannot restore normal operation, do not check inside the equipment. Get a qualified technician to check the equipment.

Problem	Remedy
Bridge Panel does not function after you press the BRILL key.	<ul style="list-style-type: none"> • Check if the AC-DC Power Supply unit is powered. (The power lamp is on if powered.) • Check if the breaker on the AC-DC Power Supply unit has activated. (The orange button on the front panel is “out”.) Check if the power lamp is illuminated. • Check if the fuse in the power cable for the Bridge Panel has blown. • Check that the power connector is connected. • Check for corrosion on the power cable. • Check if the power cable is damaged.
A key on the Bridge Panel is operated, but there is no response.	Reset the power and operate the key. If the key does not operate, contact your dealer.
When the Bridge Panel is started, the start-up screen shows ROM NG or RAM NG.	Reset the power. If NG appears again, contact your dealer.
An alarm is not sent to a Cabin Panel.	Do the procedure in section 6.4 to check the wiring in the Cabin Panel.

6.4 How to Check Connection Between Bridge Panel and Cabin Panels

You can check the connection between the Bridge Panel and each Cabin Panel. The tested Cabin Panel sends a test signal to the Bridge Panel through the Processor Unit. The Bridge Panel receives the test signal then commands the Cabin Panel to light its lamps and give the buzzer for three seconds.

This test is not available for the Timer Reset Panels (incl. Watertight Timer Reset Panel) because they are fitted on the same bridge as the Bridge Panel.

The sequence to check the connection is shown below.

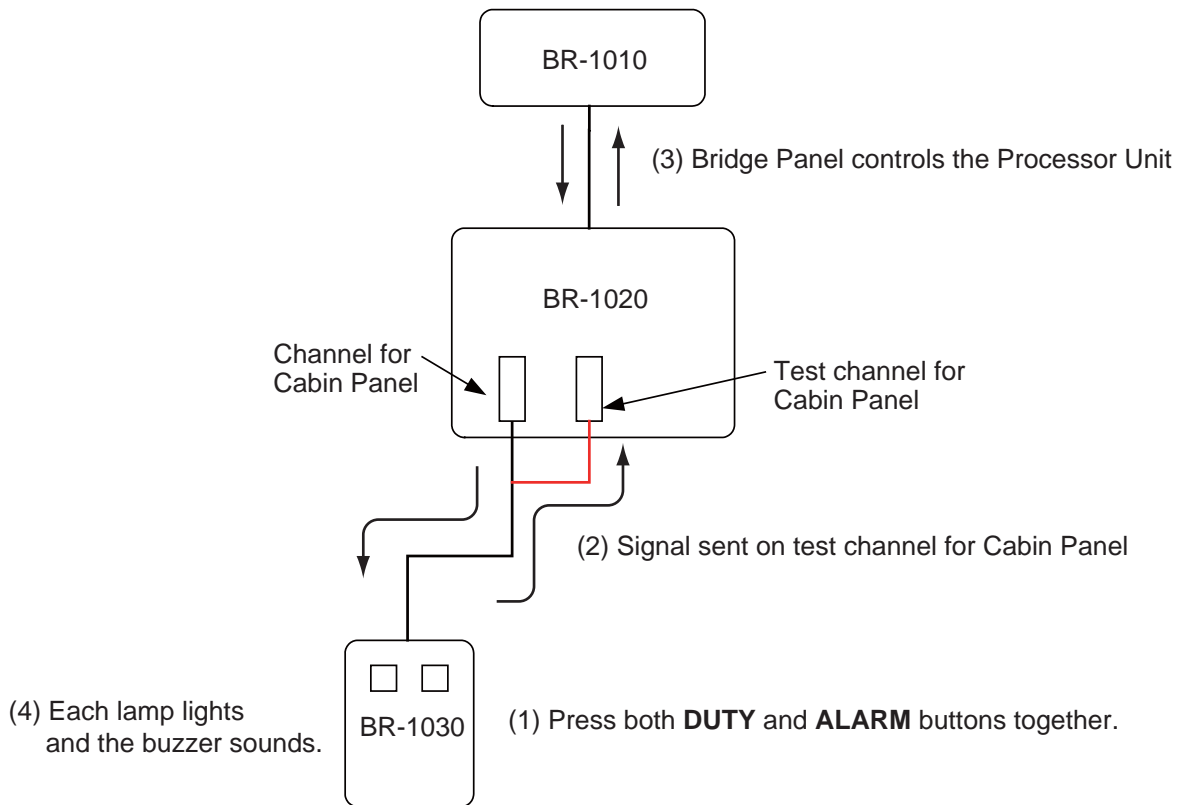

Press the **ALARM** and **DUTY** keys together on a Cabin Panel to test. The following occurs:

- The test signal is input to the test channel for the tested Cabin Panel.
- The Bridge Panel controls the Processor Unit to tell the tested Cabin Panel to light its lamps and give the buzzer for three seconds.
- The tested Cabin Panel lights its lamps and gives the buzzer for three seconds.

Note 1: The watch alarm timer is not reset during the test.

Note 2: A Cabin Panel that is currently forwarding an alarm cannot be tested. However, you can test the Cabin Panels that are not forwarding an alarm. (For example, in the 2nd stage, a Cabin Panel other than the one in the back-up officer's quarters can be tested.)

APPENDIX 1 MENU TREE

Administrator Menu (for the system administrator)

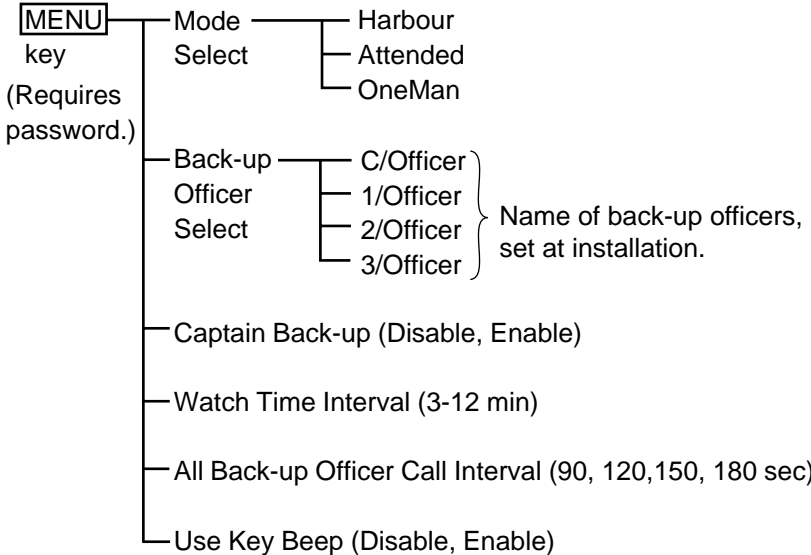

Alarm List Edit Menu (For the serviceman. See the installation manual.)

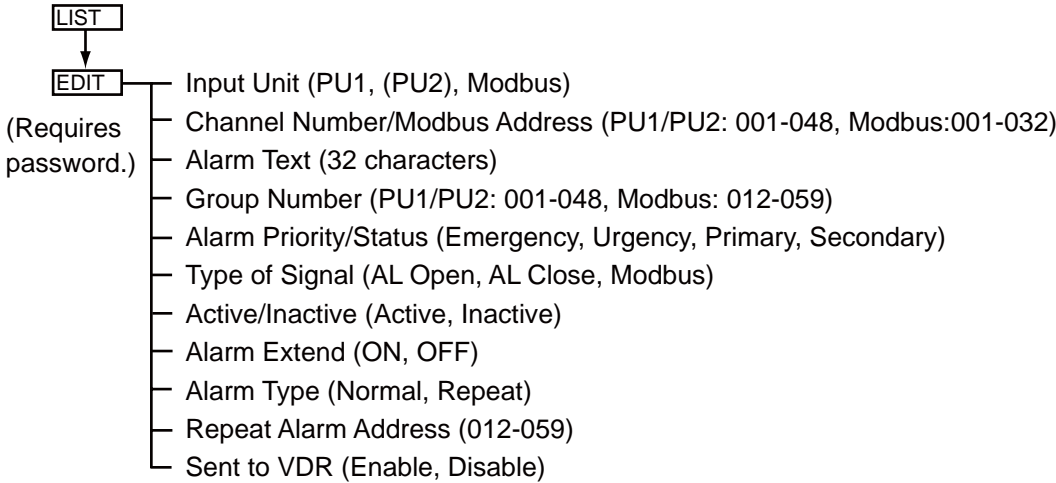

Service Menu (For the serviceman. See the installation manual.)

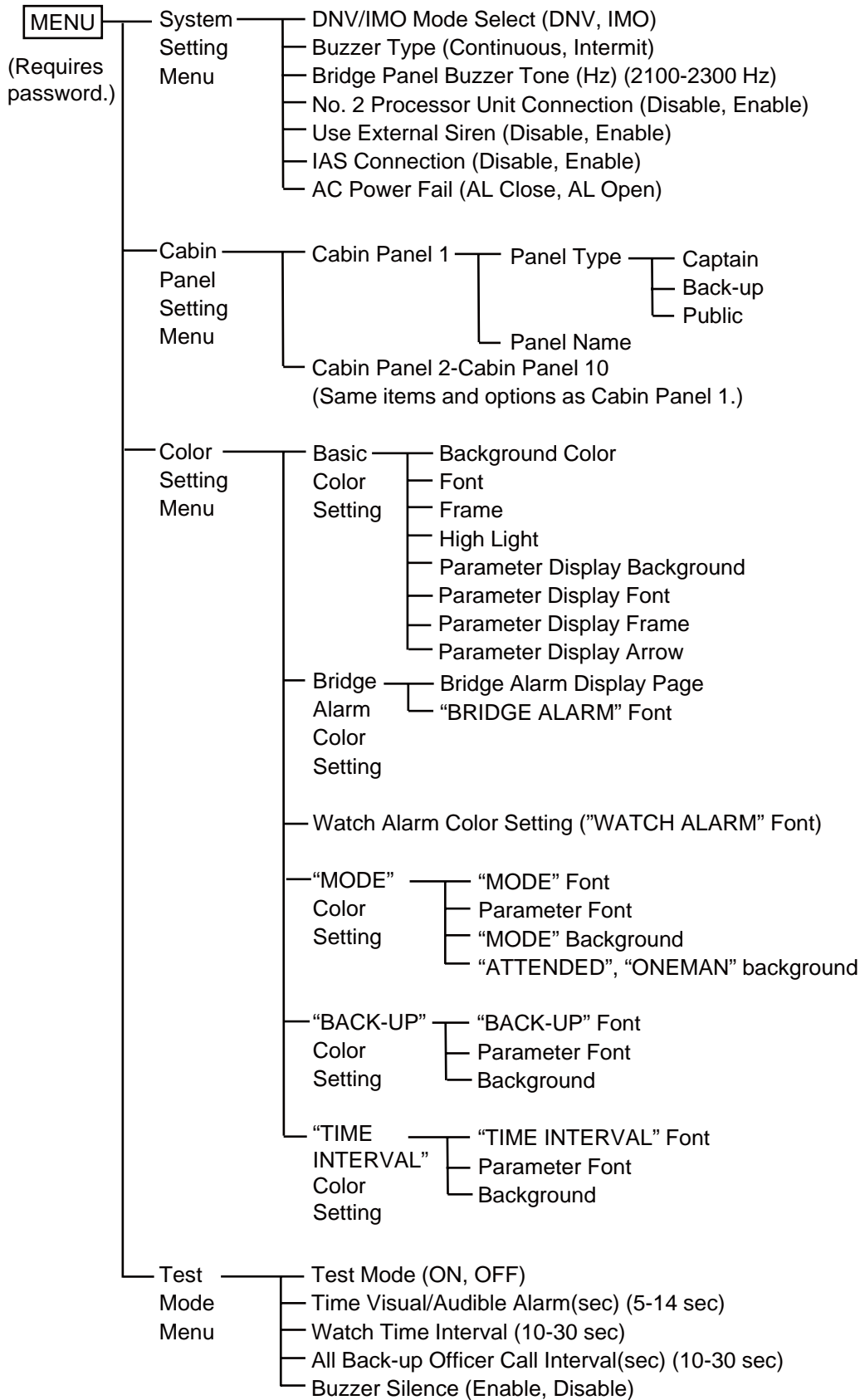

**SPECIFICATIONS OF BRIDGE ALARM SYSTEM
BR-1000**

1 BRIDGE PANEL

- 1.1 Indication system 7-inch color LCD, 480 x 234 dots
- 1.2 Brilliance 0.4 to 700 cd
- 1.3 Status indication Alarm and status
- 1.4 Alarm control Alarm acknowledge, watch safety alarm and reset control
- 1.5 Alarm information output 1 ch (for VDR)
- 1.6 LAN 1 ch (for processor unit)
- 1.7 Clock input 1 ch (for GPS)

2 PROCESSOR UNIT

- 2.1 LAN Ethernet: 100base-TX
- 2.2 Input port
 - Alarm 48 ch
 - Local ACK 12 ch
 - Operator's fitness 7 ch
 - Cabin panel test 5 ch
 - Autopilot mode HCS mode: 1ch, TCS mode: 1 ch
 - Power fail 1 ch
- 2.3 Output port
 - Remote ACK 12 ch
 - System failure 2 ch
 - External siren 1 ch
- 2.4 MODBUS 2 ch (for IAS)
- 2.5 Cabin panel control 14 sets max. (4 sets: parallel connection)
- 2.6 Timer reset panel control 4 sets max.

3 CABIN PANEL

- 3.1 Input voltage 12VDC: 3.5 mA or less (supplied from processor unit)
- 3.2 Visible alarm Alarm lamp, Duty lamp
- 3.3 Audible alarm Buzzer

4 TIMER RESET PANEL/ WATERTIGHT TIMER RESET PANEL

- 4.1 Input voltage 12VDC: 3.5 mA or less (supplied from processor unit)
- 4.2 Visible alarm Watch alarm lamp, Bridge alarm lamp
- 4.3 Audible alarm Buzzer
- 4.4 Signal output Timer reset

5 POWER SUPPLY

- 5.1 Bridge panel 12-24 VDC: 1.2-0.6 A (supplied from PR-240)
- 5.2 Processor unit 24 VDC: 2.0 A (supplied from PR-240)
- 5.3 AC/DC power supply unit (PR-240)
 - Input 100-115/200-230 VAC: 4 A max, 1 phase, 50/60Hz and
24VDC for backup
 - Output 24VDC: 8 A max.

6 ENVIRONMENTAL CONDITION

- 6.1 Ambient temperature -15°C to +55°C
- 6.2 Relative humidity 93% at 40°C
- 6.3 Degree of protection
 - Processor unit IP20
 - Bridge/cabin/timer reset panel IP22
 - Watertight timer reset panel IP56 (rear panel: IP20)
 - AC/DC power supply unit IP20
- 6.4 Vibration IEC 60945

7 COATING COLOR

- 7.1 Processor unit N3.0
- 7.2 Bridge/cabin/timer reset panel N2.5
- 7.3 AC/DC power supply unit N1.0

INDEX

A

- Administrator menu 4-1
- All back-up officer call interval..... 4-8

B

- BACK-UP box 2-4
- Back-up officer selection 4-7
- Bridge alarm
 - description 1-1
 - generation 2-6
- BRIDGE ALARM box 2-4
- Bridge attended mode 4-5
- BRILL key..... 2-2, 2-3
- Brilliance..... 2-3

C

- Cabin panel
 - operation 3-3
 - troubleshooting..... 6-4
- Call back-up 5-1
- Captain back-up 4-7
- Control description 2-1

F

- Fuse replacement 6-2

H

- Harbor mode 4-4
- Help area..... 2-5, 2-9

I

- Information area 2-4

K

- Key beep 4-8

M

- Maintenance..... 6-1
- Menu tree AP-1
- MODE box..... 2-4

N

- Navigation officer call 5-2

O

- One-man bridge attended mode 4-6
- Operation help..... 2-12
- Operation mode 4-3
- Operational event..... 2-11

P

- Power ON/OFF 2-2

S

- Software history v
- Standby display 2-4
- Status area..... 2-4
- System configuration..... vi

System description

- bridge alarm 1-1
- watch safety 1-2
- System failure 2-9

T

- TIME INTERVAL box 2-5
- Timer reset panel 3-1
- Troubleshooting
 - cabin panel..... 6-4
 - general 6-3

W

- WATCH ALARM box..... 2-4
- Watch safety alarm
 - description 1-2
 - generation 2-7
- Watch time interval..... 4-8
- Watertight timer reset panel 3-1