

# FURUNO

# OPERATOR'S MANUAL

MARINE RADAR

---

MODEL 1932 MARK-2/1942 MARK-2

---



**FURUNO ELECTRIC CO., LTD.**  
NISHINOMIYA, JAPAN

© **FURUNO ELECTRIC CO., LTD.**

9-52, Ashihara-cho,  
Nishinomiya, Japan

Telephone: 0798-65-2111  
Telefax: 0798-65-4200

•Your Local Agent/Dealer

All rights reserved.

Printed in Japan

FIRST EDITION : AUG. 1998  
C : APR. 3, 2001

(YOSH)

PUB. No. OME-34620  
MODEL1932/1942 MARK-2



\* 00080835400 \*



# SAFETY INSTRUCTIONS

## DANGER



### Stay away from transmitting scanner.

The radar scanner emits microwave radiation which can be harmful to the human body, particularly the eyes. Never look directly into the scanner radiator from a distance of less than 1 m when the radar is in operation.



### Radio Frequency Radiation Hazard

The radar scanner emits electromagnetic radio frequency (RF) energy which can be harmful, particularly to your eyes. Never look directly into the scanner aperture from a close distance while the radar is in operation or expose yourself to the transmitting scanner at a close distance.

Distances at which RF radiation levels of 100 and 10 W/m<sup>2</sup> exist are given in the table below.

**Note:** If the scanner unit is installed at a close distance in front of the wheel house, your administration may require halt of transmission within a certain sector of scanner revolution. This is possible—Ask your FURUNO representative or dealer to provide this feature.

MODEL	Radiator type	Distance to 100 W/m <sup>2</sup> point	Distance to 10 W/m <sup>2</sup> point
1932 MK-2	XN10A	Worst case 0.2 m	Worst case 3.0 m
1942 MK-2	XN12A	Nil	Worst case 2.5 m

<b>⚠ WARNING</b>	
	<p><b>ELECTRICAL SHOCK HAZARD</b> Do not open the equipment.</p> <p>Only qualified personnel should work inside the equipment.</p>
	<p><b>Turn off the radar power switch before servicing the scanner unit. Post a warning sign near the switch indicating it should not be turned on while the scanner unit is being serviced.</b></p> <p>Prevent the potential risk of being struck by the rotating scanner and exposure to RF radiation hazard.</p>
<p><b>Do not disassemble or modify the equipment.</b></p> <p>Fire, electrical shock or serious injury can result.</p>	
<p><b>Turn off the power immediately if water leaks into the equipment or the equipment is emitting smoke or fire.</b></p> <p>Continued use of the equipment can cause fire or electrical shock.</p>	
<p><b>Use the proper fuse.</b></p> <p>Fuse rating is shown on the equipment. Use of a wrong fuse can result in equipment damage.</p>	
<p><b>Keep heater away from equipment.</b></p> <p>Heat can alter equipment shape and melt the power cord, which can cause fire or electrical shock.</p>	

<b>⚠ CAUTION</b>	
<p><b>Do not use the equipment for other than its intended purpose.</b></p> <p>Use of the equipment as a stepping stool, for example, can result in personal injury or equipment damage.</p>	
<p><b>No one navigation device should ever be solely relied upon for the navigation of a vessel.</b></p> <p>Always confirm position against all available aids to navigation, for safety of vessel and crew.</p>	

Two warning labels are attached to the display unit and scanner unit. Do not remove these labels. If labels are peeling off or are illegible, contact a FURUNO agent or dealer.

**<Display Unit>**  
Name: Warning Label (1)  
Type: 86-003-1011-0  
Code no.: 100-236-230



**<Scanner Unit>**  
Name: Radiation Warning Label  
Type: 03-142-3201-0  
Code no.: 100-266-890



# FOREWORD

---

Congratulations on your choice of the FURUNO MODEL 1932/1942 MARK-2 Marine Radar. We are confident you will see why the FURUNO name has become synonymous with quality and reliability.

For over 50 years FURUNO Electric Company has enjoyed an enviable reputation for innovative and dependable marine electronics equipment. This dedication to excellence is furthered by our extensive global network of agents and dealers.

Your radar is designed and constructed to meet the rigorous demands of the marine environment. However, no machine can perform its intended function unless properly installed and maintained. Please carefully read and follow the recommended procedures for, operation and maintenance.

We would appreciate hearing from you, the end-user, about whether we are achieving our purposes.

Thank you for considering and purchasing FURUNO equipment.

## Features

Your radar has a large variety of functions, all contained in a remarkably small cabinet.

The main features of the MODEL 1932/1942 MARK-2 are:

- Traditional FURUNO reliability and quality in a compact, lightweight and low-cost radar.
- Durable brushless scanner motor.
- On-screen alphanumeric readout of all operational information.
- Standard features include EBL (Electronic Bearing Line), VRM (Variable Range Marker), Guard Alarm, Display Off Center, and Echo Trail.
- Watchman feature periodically transmits the radar to check for radar targets which may be entering the alarm zone.
- Ship's position in latitude and longitude and Loran C Time Differences, range and bearing to a waypoint, and ship's speed/heading/course can be shown in the bottom text area. (Requires a navigation aid which can output such data in IEC 61162 format.)
- Zoom feature provided.
- Optional Auto Plotter ARP-10 acquires and automatically tracks 5 targets plus 5 targets manually, or 10 targets manually.

# TABLE OF CONTENTS

<b>FOREWORD</b> .....	iii	3.5 Suppressing Radar Interference ....	3-3
<b>MENU TREE</b> .....	v	3.6 Selecting Pulsewidth .....	3-4
<b>TABLE OF CONTENTS BY INDICATION, MARKER</b> .....	vi	3.7 Guard Alarm .....	3-4
<b>SYSTEM CONFIGURATION</b> ....	vii	3.8 Watchman .....	3-5
<b>1. PRINCIPLE OF OPERATION</b>		3.9 Displaying Navigation Data .....	3-6
1.1 What is Radar? .....	1-1	3.10 OTHER MENU Description .....	3-7
1.2 How Ships Determined Position Before Radar .....	1-1	3.11 Function Controls .....	3-8
1.3 How Radar Determines Range .....	1-1	3.12 Suppressing Noise .....	3-8
1.4 How Radar Determines Bearing.....	1-1	3.13 Adjusting Brilliance of Markers .....	3-8
1.5 Radar Wave Speed and Scanner Rotation Speed .....	1-1	3.14 Outputting Target Position .....	3-8
1.6 The Radar Display .....	1-1	3.15 Dead Sector .....	3-8
<b>2. BASIC OPERATION</b>		<b>4. FALSE ECHOES</b>	
2.1 Control Description.....	2-1	4.1 Multiple Echoes .....	4-1
2.2 Turning the Radar On/Off.....	2-2	4.2 Side-lobe Echoes .....	4-1
2.3 Transmitting .....	2-2	4.3 Indirect Echoes .....	4-2
2.4 Stand-by .....	2-2	4.4 Blind and Shadow Sectors .....	4-2
2.5 Selecting the Range .....	2-3	4.5 SART (Search and Rescue Transponder) .....	4-5
2.6 Adjusting Picture Brilliance .....	2-3	<b>5. MAINTENANCE &amp; TROUBLE-SHOOTING</b>	
2.7 Adjusting Receiver Sensitivity .....	2-3	5.1 Preventive Maintenance .....	5-1
2.8 Adjusting the A/C SEA Control (reducing sea clutter) .....	2-3	5.2 Replacing the Fuse .....	5-1
2.9 Adjusting the A/C RAIN Control (reducing rain clutter) .....	2-4	5.3 Troubleshooting .....	5-2
2.10 Erasing the Heading Marker, North Marker .....	2-5	5.4 Self Test .....	5-3
2.11 Measuring the Range .....	2-5	5.5 Life Expectancy of Magnetron .....	5-3
2.12 Measuring the Bearing .....	2-6	<b>6. OPERATION OF ARP-10 (OPTION)</b>	
2.13 Using the Offset EBL.....	2-6	6.1 General .....	6-2
2.14 Offcentering the Picture .....	2-7	6.2 ARP-10 MENU Operation .....	6-2
2.15 Zoom .....	2-8	6.3 Acquiring Targets .....	6-4
<b>3. MENU OPERATION</b>		6.4 Displaying Target Data .....	6-5
3.1 Basic Menu Operation .....	3-1	6.5 Mode and Length of Vectors .....	6-6
3.2 Selecting the Presentation Mode ...	3-1	6.6 Past Position Display .....	6-6
3.3 Magnifying Long Range Echoes (echo stretch) .....	3-2	6.7 Operational Warnings .....	6-6
3.4 Echo Trail .....	3-2	<b>SPECIFICATIONS</b> .....	<b>SP-1</b>
		<b>INDEX</b> .....	<b>IN-1</b>
		<b>Declaration of Conformity (MODEL 1932 MARK-2)</b>	
		<b>Declaration of Conformity (MODEL 1942 MARK-2)</b>	

# MENU TREE

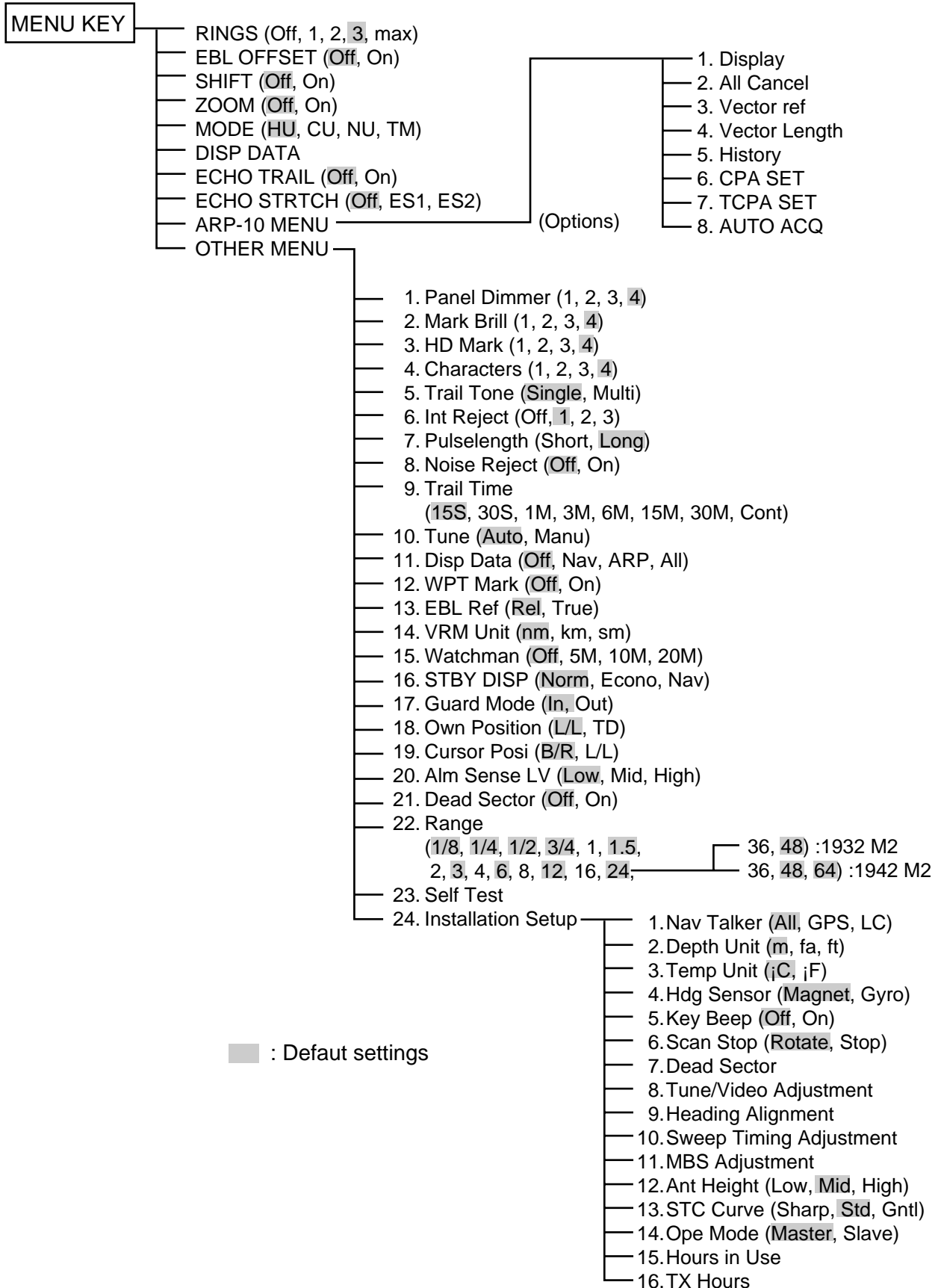

# TABLE OF CONTENTS BY INDICATION, MARKER

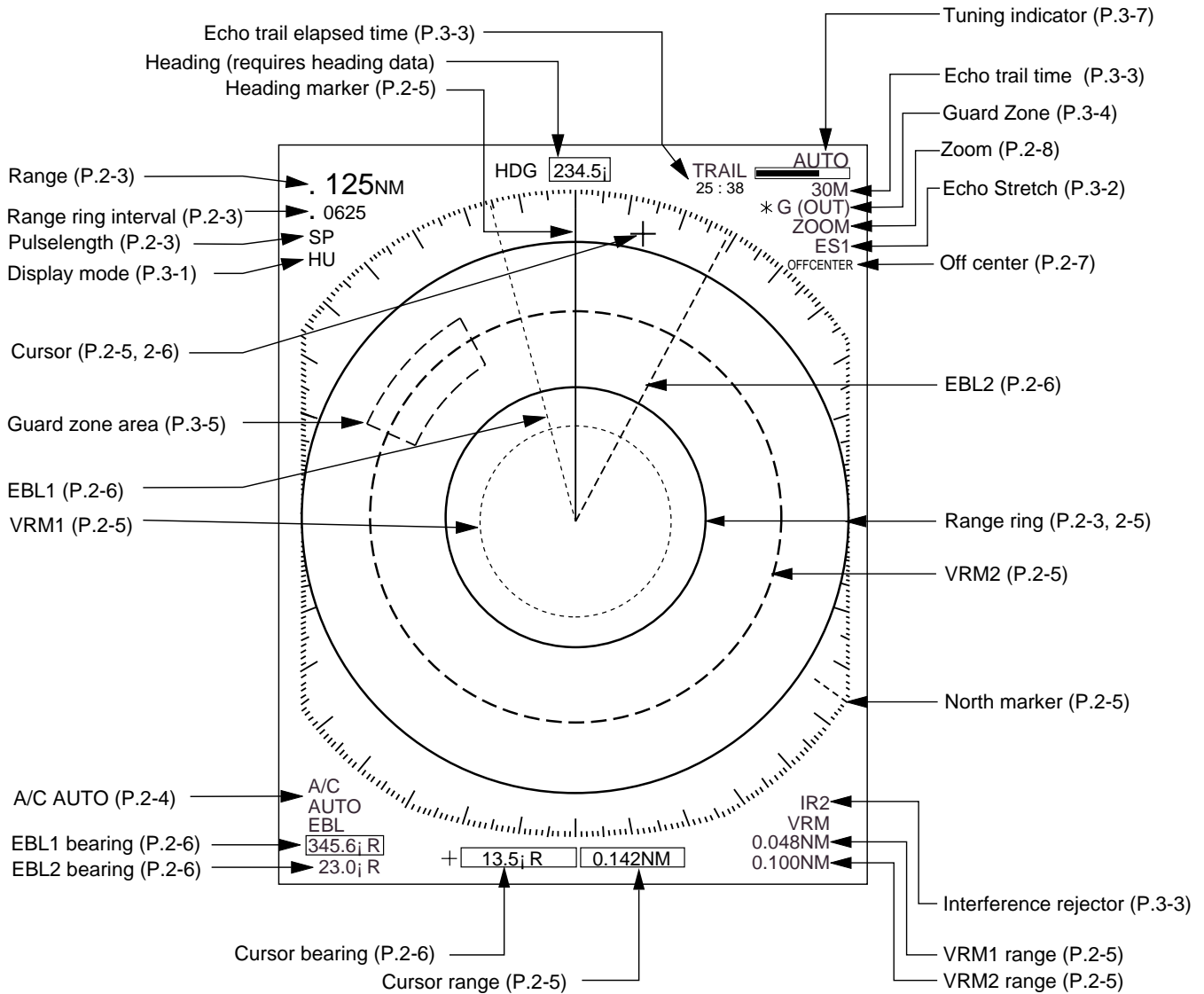



# SYSTEM CONFIGURATION

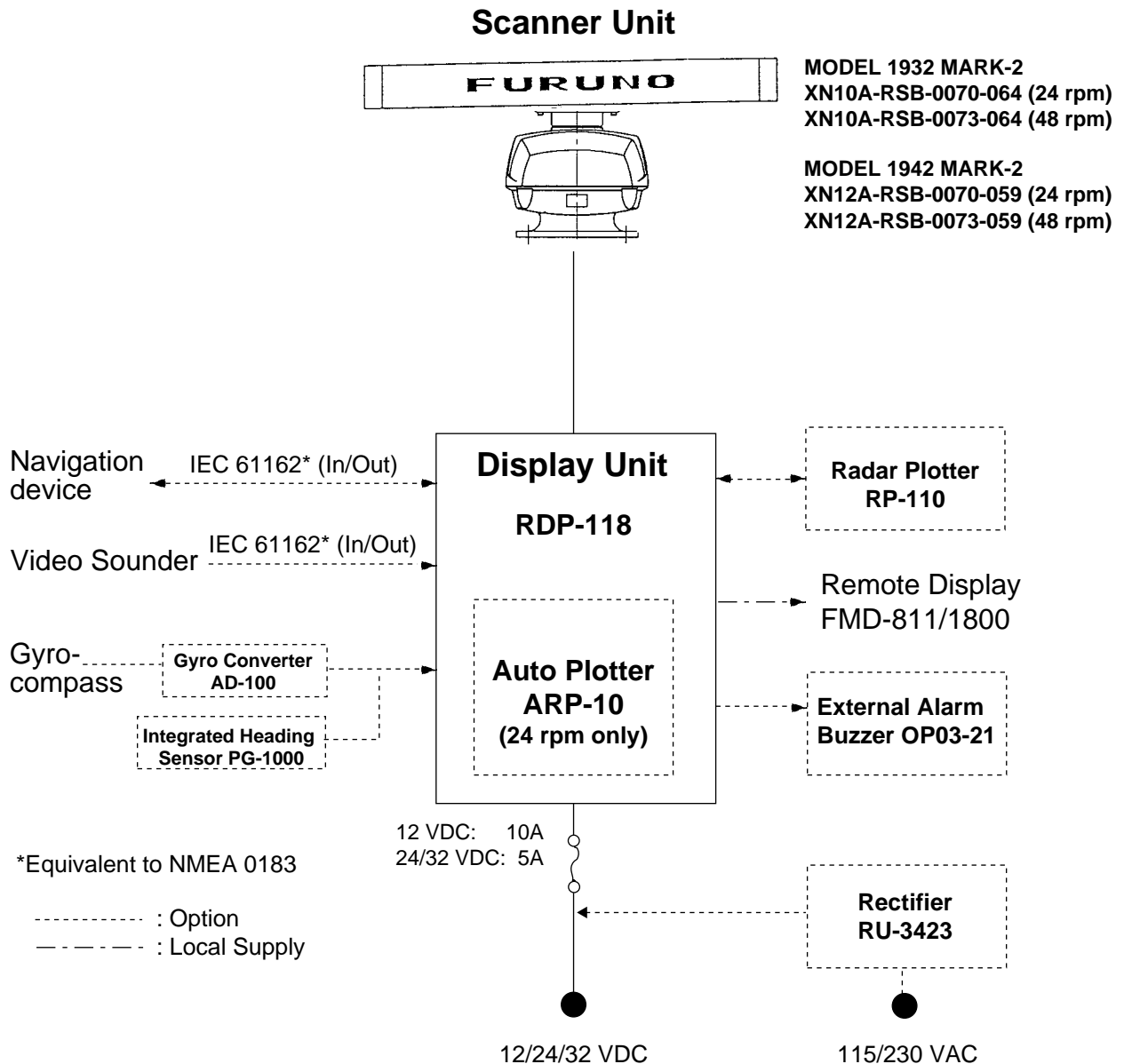

**Note:** Even though the display unit meets waterproof standard IPX-5, the connection of external buzzer, radar plotter and/or remote display can affect waterproofness. Watertight integrity cannot be guaranteed. When these modification has been done, the display unit should not be mounted where exposed.

# 1. PRINCIPLE OF OPERATION

---

## 1.1 What is Radar?

The term "RADAR" is an acronym meaning Radio Detection And Ranging. Although the basic principles of radar were developed during World War II, echoes as an aid to navigation is not a new development.

## 1.2 How Ships Determined Position Before Radar

Before the invention of radar, when running in fog near a rugged shoreline, ships would sound a short blast on their whistles, fire a shot, or strike a bell. The time between the origination of the sound and the returning of the echo indicated how far the ship was from the cliffs or the shore. The direction from which the echo was heard indicated the relative bearing of the shore.

## 1.3 How Radar Determines Range

Radar determines the distance to the target by calculating the time difference between the transmission of a radar signal and the reception of the reflected echo. It is a known fact that radar waves travel at a nearly constant speed of 162,000 nautical miles per second. Therefore the time required for a transmitted signal to travel to the target and return as an echo to the source is a measure of the distance to the target. Note that the echo makes a complete round trip, but only half the time of travel is needed to determine the one-way distance to the target. This radar automatically takes this into account in making the range calculation.

## 1.4 How Radar Determines Bearing

The bearing to a target found by the radar is determined by the direction in which the radar scanner is pointing when it emits an electronic pulse and then receives a returning echo. Each time the scanner rotates pulses are transmitted in the full 360 degree circle, each pulse at a slightly different bearing from the previous one. Therefore, if one knows the direction in which the signal is sent out, one knows the direction from which the echo must return.

## 1.5 Radar Wave Speed and Scanner Rotation Speed

Note that the speed of the radar waves out to the target and back again as echoes is extremely fast compared to the speed of rotation of the scanner. By the time radar echoes have returned to the scanner, the amount of scanner rotation after initial transmission of the radar pulse is extremely small.

## 1.6 The Radar Display

The range and bearing of a target is displayed on what is called a Plan Position Indicator (PPI). This display is essentially a polar diagram, with the transmitting ship's position at the center. Images of target echoes are received and displayed at their relative bearings, and at their distance from the PPI center.

With a continuous display of the images of targets, the motion of the transmitting ship is also displayed.

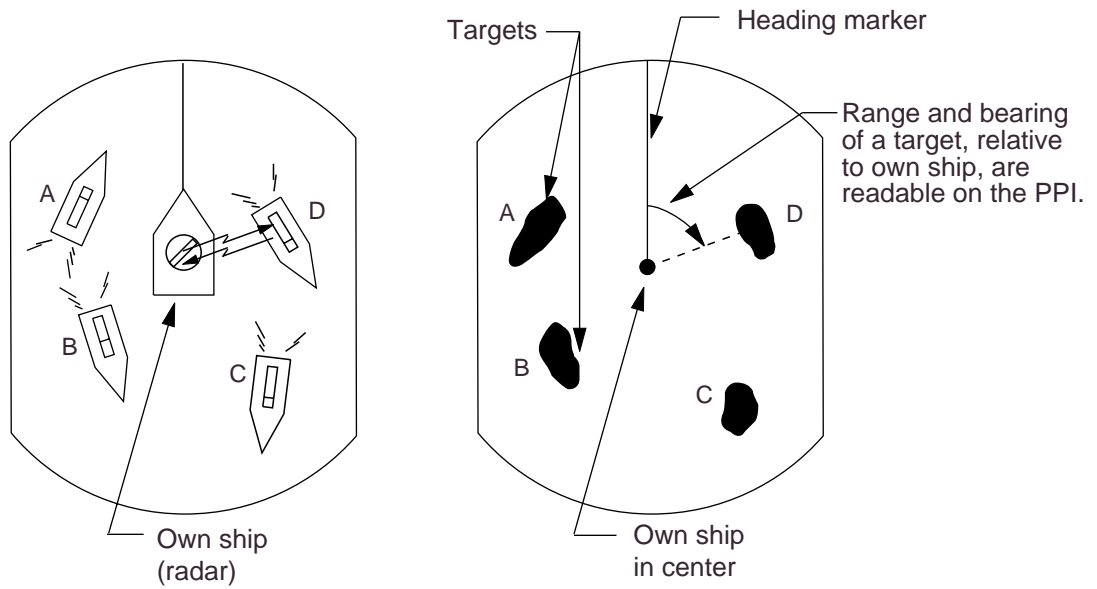

**(A) Bird's eye view of situation**

**(B) Radar picture of (A)**

*Figure 1-1 How radar works*

# 2. BASIC OPERATION

## 2.1 Control Description

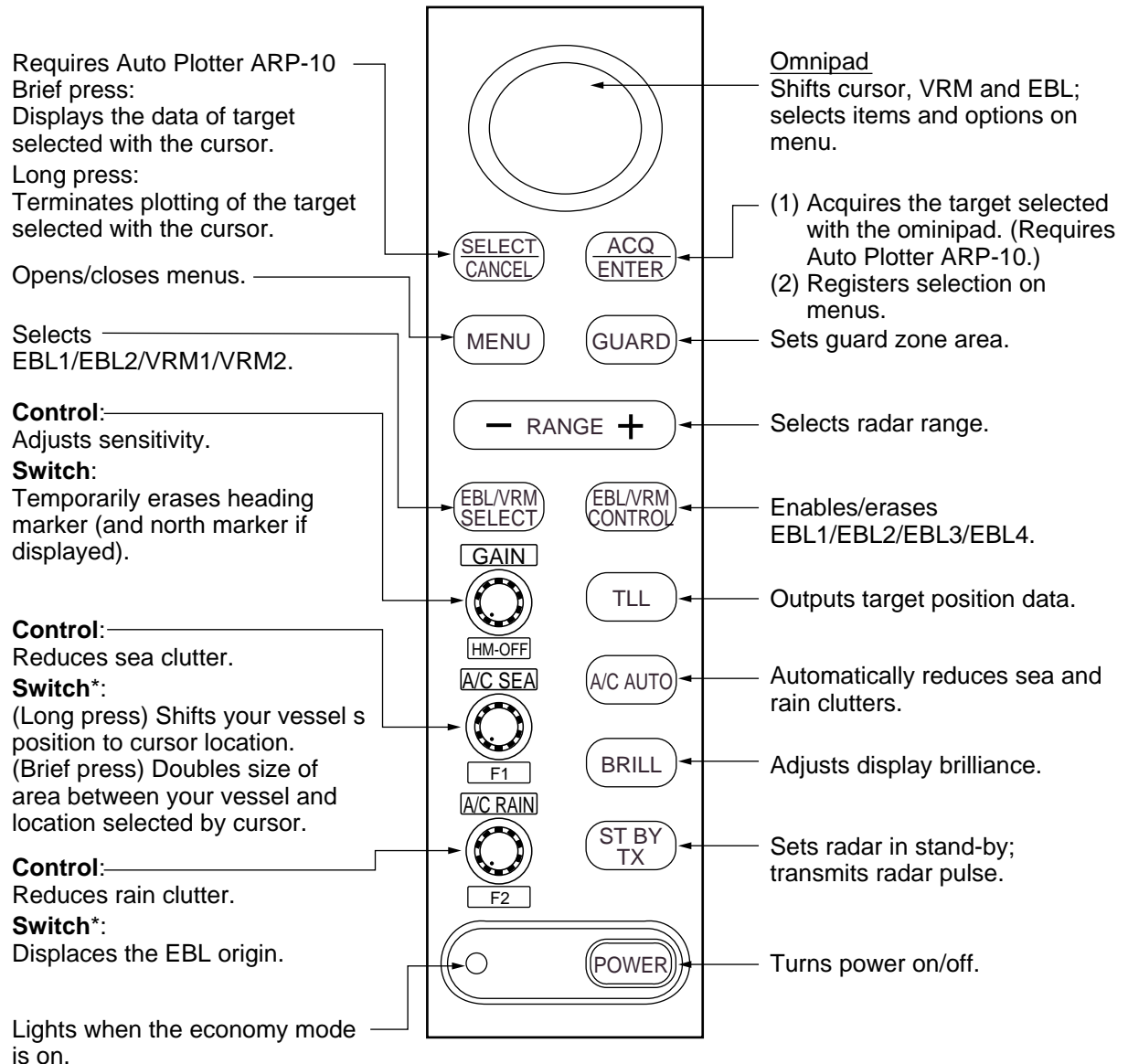

\*Default switch function.

Figure 2-1 Control panel

## 2.2 Turning the Radar On/Off

Press the [POWER] key to turn the radar on or off.

The control panel lights and a timer displays the time remaining for warm up of the magnetron (the device which produces radar pulses), counting down from 1:30 to 0:01.

## 2.3 Transmitting

After the power is turned on and the magnetron has warmed up, STBY (Stand-By) appears at the screen center. This means the radar is now fully operational.

Press the [STBY TX] key to transmit.

When transmitting, any echoes from targets appear on the display. This radar displays echoes in eight tones of green according to echo strength.

## 2.4 Stand-by

When you won't be using the radar for an extended period, but you want to keep it in a state of readiness, place it in stand-by by pressing the [STBY TX] key. The display shows "STBY," navigation data, or goes into the economy mode depending on menu setting. (More on menu operation later.)

### Economy mode

The CRT can be set to automatically turn itself off when in stand-by, to reduce power consumption. This feature is called the "economy mode." Power consumption in the economy mode is 28 W. When the economy mode is on, the lamp next to the [POWER] key lights.

### Navigation data display during stand-by

If a navigation aid inputs navigation data to this radar in IEC 61162 format, navigation data can be displayed during stand-by. You can turn the navigation data display on/off through the menu. Figure 2-2 shows a typical navigation data display during stand-by.

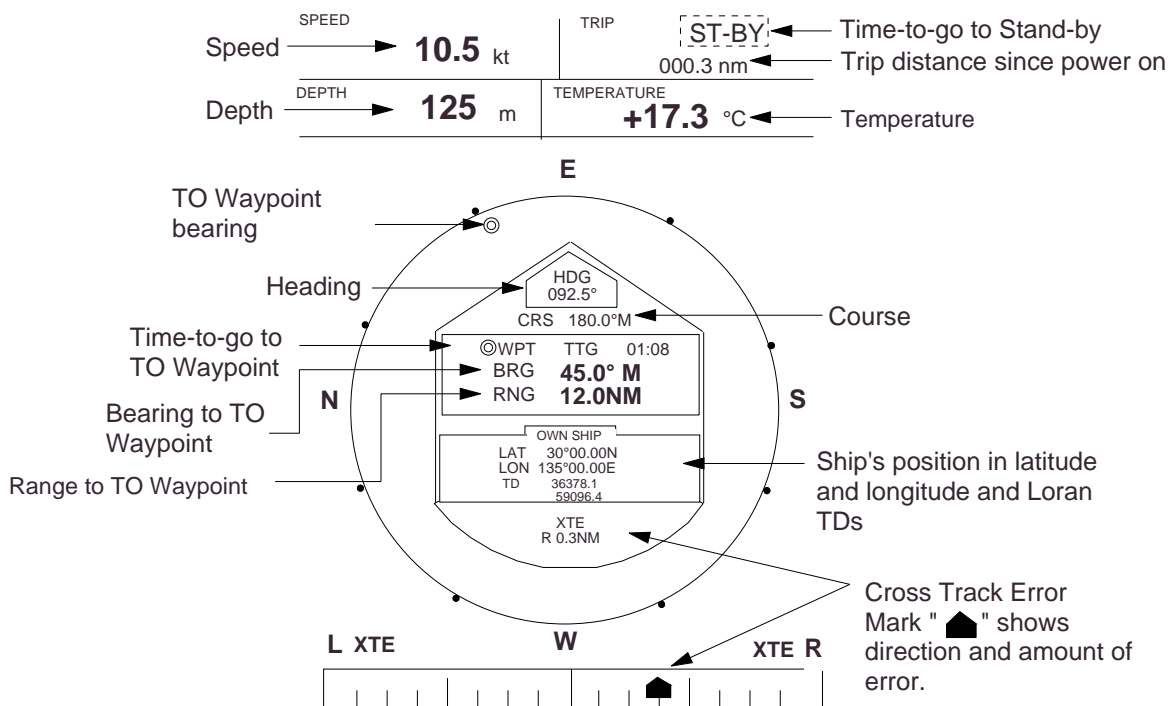

Figure 2-2 Typical navigation data display during stand-by

**Note1:** Availability of a particular display item depends on incoming data.

**Note2:** When Range to Waypoint reaches 0.1 nm, the WPT marker jumps to dead ahead even though a difference may exist between heading and BRG to WPT.

**Note3:** When cross track error exceeds 1 nm on either side, the XTE mark starts blinking.

## 2.5 Selecting the Range

The range selected automatically determines the range ring interval, the number of range rings, pulselength and pulse repetition rate, for optimal detection capability in short to long ranges.

You can select which ranges and pulselength (for 1.5 and 3 mile ranges) to use through the menu. The range, range ring interval and pulselength appear at the top left-hand corner of the display.

### To select a range;

Press the [- RANGE +] key. The range and range ring interval appear at the top left corner of the display.

### Tips for selecting the range

- When navigating in or around crowded harbors, select a short range to watch for possible collision situations.
- If you select a lower range while on open water, increase the range occasionally to watch for vessels that may be heading your way.

## 2.6 Adjusting Picture Brilliance

The [BRILL] key adjusts the brilliance of the radar picture in sixteen levels. The current level momentarily appears on the screen whenever the [BRILL] key is pressed.

## 2.7 Adjusting Receiver Sensitivity

The [GAIN] control adjusts the sensitivity of the receiver. It works in precisely the same manner as the volume control of a broadcast receiver, amplifying the signals received.

The proper setting is such that the background noise is just visible on the screen. If you set up for too little sensitivity, weak echoes may be missed. On the other hand excessive sensitivity yields too much background noise; strong targets may be missed because of the poor contrast between desired echoes and the background noise on the display.

To adjust receiver sensitivity, transmit on long range, and adjust the [GAIN] control so background noise is just visible on the screen.

## 2.8 Adjusting the A/C SEA Control (reducing sea clutter)

Echoes from waves can be troublesome, covering the central part of the display with random signals known as "sea clutter." The higher the waves, and the higher the scanner above the water, the further the clutter will extend. Sea clutter appears on the display as many small echoes which might affect radar performance. (See the left-hand figure in Figure 2-3.) When sea clutter masks the picture, adjust the [A/C SEA] control to reduce the clutter.

### How the A/C SEA control works

The [A/C SEA] control reduces the amplification of echoes at short ranges (where clutter is the greatest) and progressively increases amplification as the range increases, so amplification will be normal at those ranges where there is no sea clutter.

## Adjusting the A/C SEA control

The proper setting of the A/C SEA should be such that the clutter is broken up into small dots, and small targets become distinguishable.

If the control is set too low, targets will be hidden in the clutter, while if it is set too high, both sea clutter and targets will disappear from the display. In most cases adjust the control until clutter has disappeared to leeward, but a little is still visible windward.

1. Confirm that the sensitivity is properly adjusted, and then transmit on short range.
2. Adjust the [A/C SEA] control so small targets are distinguishable but some clutter remains on the display.

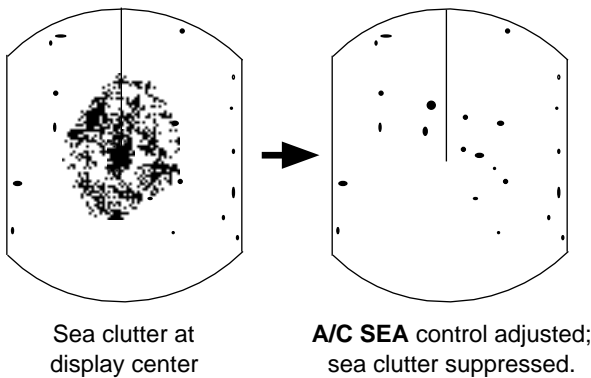
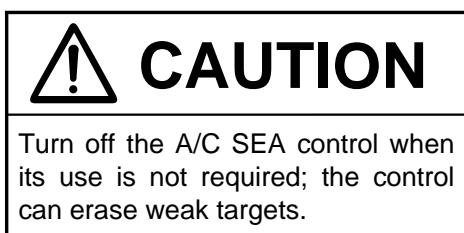

Figure 2-3 How to adjust the A/C SEA control

## Tip for adjusting the A/C SEA

A common mistake is to over-adjust the circuit so all the clutter is removed. As an example set up for maximum A/C SEA. You will see how the center of the display becomes dark. This dark zone can be dangerous (targets may be missed), especially if the sensitivity is not properly adjusted. Always leave a little clutter visible on the display to be sure weak echoes will not be suppressed. If there is no clutter visible on the display, turn off the circuit.



## 2.9 Adjusting the A/C RAIN Control (reducing rain clutter)

The vertical beamwidth of the scanner is designed to see surface targets even when the ship is rolling. However, by this design the scanner will also detect rain clutter (rain, snow, hail, etc.) in the same manner as normal targets. Figure 2-4 shows the appearance of rain clutter on the display.

### Adjusting A/C RAIN

When rain clutter masks echoes, adjust the [A/C RAIN] control. This control splits up these unwanted echoes into a speckled pattern, making recognition of solid targets easier.

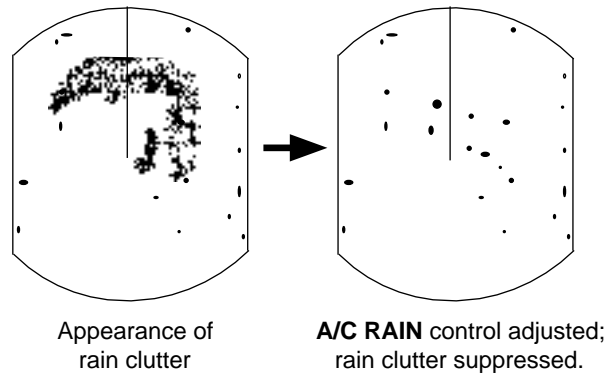

Figure 2-4 Effect of A/C RAIN

**Note:** In addition to reducing clutter, the [A/C RAIN] control can be used in fine weather to clarify the picture when navigating in confined waters. However, with the circuit activated the receiver is less sensitive. Therefore, turn off the circuit when its function is not required.

## Automatic adjustments of A/C SEA and A/C RAIN

Push the [A/C AUTO] key. "A/C AUTO" appears at the bottom left-hand corner of the display when the A/C AUTO circuit is on. You can fine tune by adjusting the [A/C SEA], [A/C RAIN] and [GAIN] controls.

## 2.10 Erasing the Heading Marker, North Marker

The heading marker or north marker (available with gyrocompass connection) may occasionally mask a target. To view the target, you can temporarily erase the heading marker and north marker by pressing and holding down the [GAIN (HM OFF)] control. Release the control to re-display the markers.

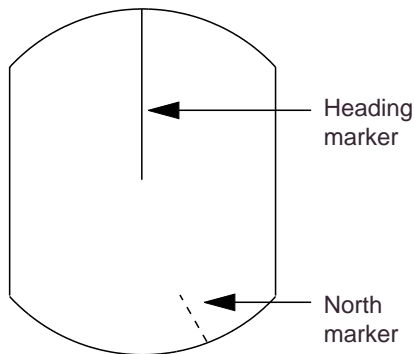

Figure 2-5 Heading marker and north marker

## 2.11 Measuring the Range

You can measure the range to a target three ways: by the range rings, by the cursor, and by the VRM (Variable Range Marker).

### Measuring range by range rings

Count the number of rings between the center of the display and the target. Check the range ring interval and judge the distance of the echo from the inner edge of the nearest ring.

### Measuring range by cursor

Operate the omnipad to place the cursor intersection on the inside edge of the target echo. The range to the target, as well as the bearing, appears at the bottom of the display.

## Measuring range by VRM

1. Press the [EBL/VRM SELECT] key to circumscribe a VRM readout (at the bottom right-hand corner). Each press of the key selects the readout of EBL1, EBL2, VRM1 or VRM2 in that order.



Figure 2-6 Display bottom, showing location of EBL and VRM readouts

2. Press the [EBL/VRM CONTROL] key to enable control of the VRM by the omnipad.
3. Operate the omnipad to place the outside edge of the VRM on the inside edge of the target. The omnipad must be operated within five seconds after pressing the [EBL/VRM CONTROL] key, otherwise the VRM cannot be operated.
4. Check the VRM readout at the bottom right-hand corner of the display to find the range to the target.
5. To anchor the VRM, press the [EBL/VRM CONTROL] key.

To erase the VRM, press and hold down the [EBL/VRM CONTROL] key about two seconds.

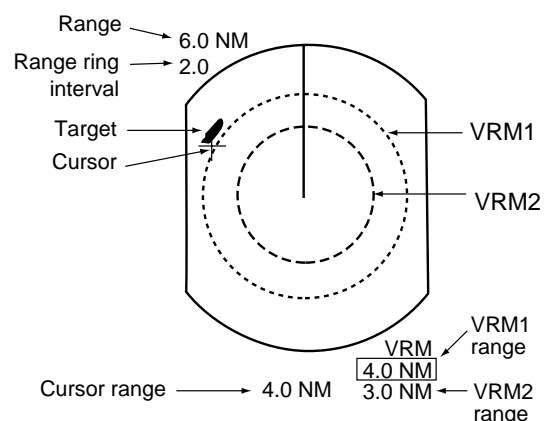

Figure 2-7 Measuring range by the cursor, range rings and VRM

**Note:** You can display the range readout of the VRM and cursor in nautical miles, statute miles or kilometers. For details see the next chapter.



## 2.12 Measuring the Bearing

There are two ways to measure the bearing to a target: by the cursor, and by the EBL (Electronic Bearing Line).

### Measuring bearing by cursor

Operate the omnipad to bisect the target with the cursor intersection. The bearing to the target appears at the bottom of the display.

### Measuring bearing by EBL

1. Press the [EBL/VRM SELECT] key to circumscribe an EBL readout (at the bottom left-hand corner). Each press of the key selects the readout of EBL1, EBL2, VRM1 or VRM2 in that order.
2. Press the [EBL/VRM CONTROL] key to enable control of the EBL by the omnipad.
3. Operate the omnipad to bisect the target with the EBL. The omnipad must be operated within five seconds after pressing the [EBL/VRM CONTROL] key, otherwise the EBL cannot be operated.
4. Check the EBL readout at the bottom left-hand corner of the display to find the bearing to the target.
5. To anchor the EBL, press the [EBL/VRM CONTROL] key.

To erase the EBL and its readout, press and hold down the [EBL/VRM CONTROL] key about two seconds.

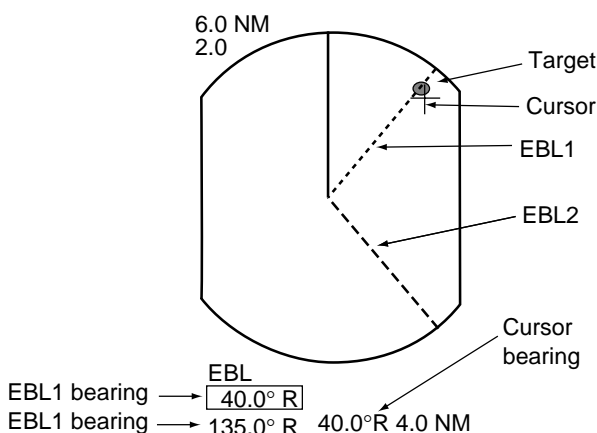

Figure 2-8 How to measure bearing by EBL and cursor

**Note:** The bearing readout for the EBL and the cursor can be displayed in relative or true bearing (true bearing requires heading sensor input). For north up and course up display modes the bearing reference is always true. For details see the next chapter.

### Tips for measuring bearing

- Bearing measurements of smaller targets are more accurate; the center of larger target pips is not as easily identified.
- Bearings of stationary or slower moving targets are more accurate than bearings of faster moving targets.
- To minimize bearing errors keep echoes in the outer half of the picture by changing the range scale; angular difference becomes difficult to resolve as a target approaches the center of the display.

## 2.13 Using the Offset EBL

The offset EBL provides two functions: predict collision course of a radar target and measure the range and the bearing between two targets.

### Predicting collision course

1. Operate the omnipad to place the cursor on the center of the target.
2. Press the [EBL/VRM SELECT] key to choose the EBL1 readout, and then press the [EBL/VRM CONTROL] key.
3. Press the [MENU] key, select EBL OFFSET from the menu, and then press the [ACQ/ENTER] key.
4. Press the [EBL/VRM CONTROL] key.
5. Operate the omnipad so EBL1 passes through the center of the target.

If the target tracks along the EBL towards the center of the display (your vessel's position), the target may be on a collision course.

To cancel the offset EBL, select EBL OFFSET from the menu and press the [ACQ/ENTER] key.

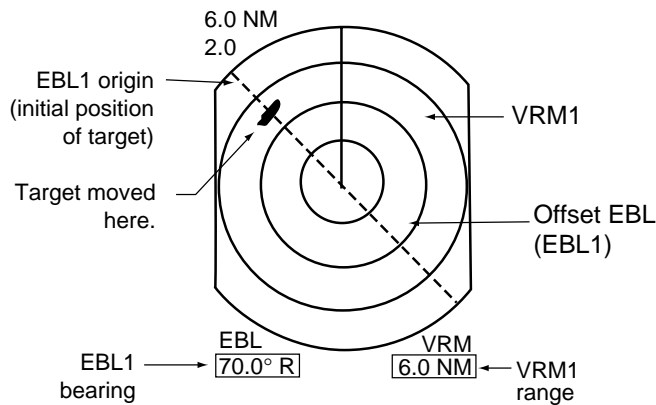

Figure 2-9 Predicting collision course by using the offset EBL

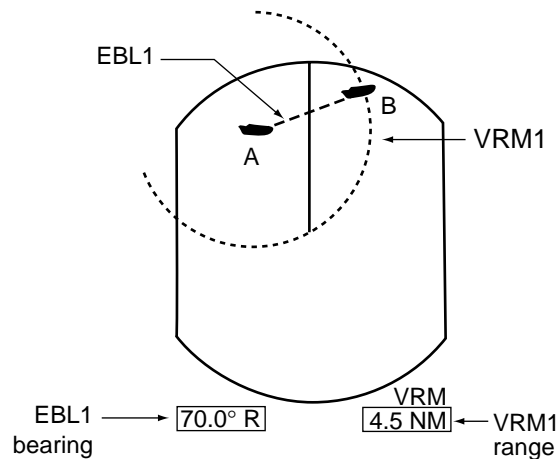

Figure 2-10 Measuring the range and bearing between two targets by using the offset EBL

## Measuring range and bearing between two targets

The procedure which follows shows how to measure the range and bearing between target "A" and target "B" in Figure 2-10.

1. Operate the omnipad to place EBL1's origin (cursor) on the center of target "A."
2. Press the [EBL/VRM SELECT] key to choose the EBL1 readout and then press the [EBL/VRM CONTROL] key.
3. Press the [MENU] key, select EBL OFFSET from the menu, and then press the [ACQ/ENTER] key. EBL1's origin shifts to cursor location.
4. Press the [EBL/VRM CONTROL] key.
5. Operate the omnipad to bisect target "B" with EBL1. Check the EBL1 readout to find the bearing between target "A" and target "B."
6. Press the [EBL/VRM SELECT] key to choose the VRM1 readout. Operate the omnipad to place the outside edge of VRM1 on the inside edge of target "B." Check the VRM1 readout to find the range between target "A" and target "B."
7. To cancel the offset EBL, select EBL OFFSET from the menu, and then press the [ACQ/ENTER] key.

## 2.14 Offcentering the Picture

Your vessel's position can be offcentered to 75% of the range in use to view the situation around your vessel without changing the range or size of targets.

1. Press the omnipad to set the cursor where desired.
2. Press the [F1 (A/C SEA)] control if its function is set for SHIFT (default setting), or select SHIFT from the menu. OFFCENTER appears at the top right corner of the display when the picture is offcentered.

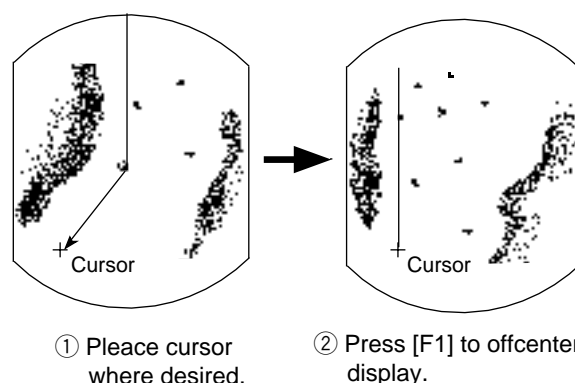

- ① Place cursor where desired.
- ② Press [F1] to offcenter display.

Figure 2-11 Offcentering the picture

## Cancelling offcentered picture

Press the [F1 (A/C SEA)] control (if function is SHIFT).

## 2.15 Zoom

The zoom feature allows you to double the size of the area between your vessel and any location within the current range to take a closer look at an area of interest.

1. Select location with the cursor.
2. Press and hold down the [F1 (A/C SEA)] control about two seconds if its function is set for ZOOM (default setting), or select ZOOM from the menu. Zoom appears at the top right corner when the ZOOM function is on.

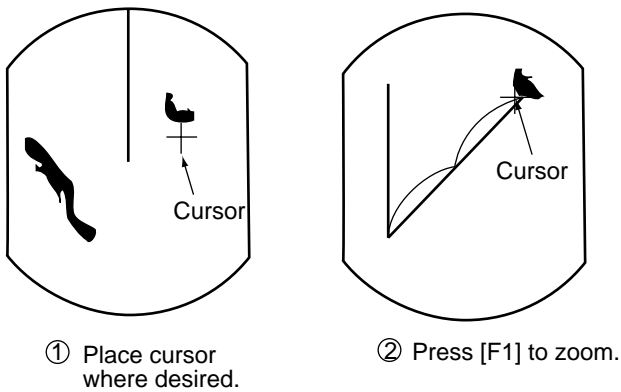

*Figure 2-12 Zoom function*

**Note:** Zoom is cancelled when range or presentation mode is changed.

### **Cancelling zoom**

Press the [F1 (A/C SEA)] control again.

# 3. MENU OPERATION

## 3.1 Basic Menu Operation

The menu mostly contains less-often used functions which once preset do not require regular adjustment. To open or close the menu, press the [MENU] key. You can select items and options from the menu with the omnipad. The complete menu appears on page v.

1. Press the [MENU] key to display the main menu.

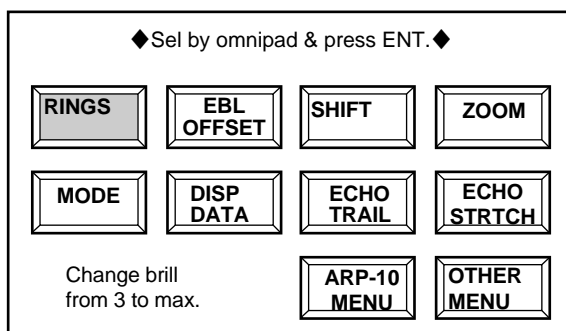

Figure 3-1 Main menu

2. Press the omnipad to select item. For example, select RINGS. A message appears at the bottom of the menu window.
3. Press the [ACQ/ENTER] key to select setting. Each time this key is pressed, the message changes. For the RINGS menu, the message sequence is as shown below.

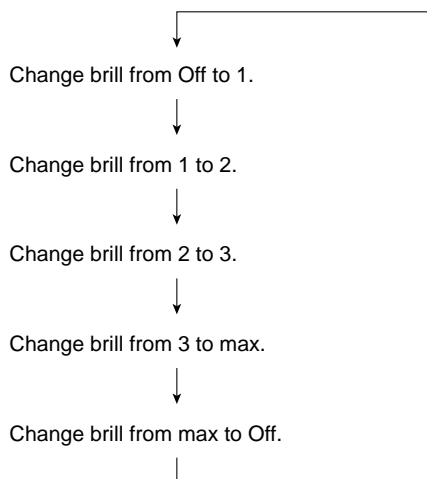

Figure 3-2 Messages for RINGS menu

4. Press the [MENU] key to close the menu.

## 3.2 Selecting the Presentation Mode

With heading sensor connection, this radar provides four presentation modes: head-up, course-up, north-up and true motion.

1. Press the [MENU] key.
2. Operate the omnipad to select “MODE.”
3. Press the [ACQ/ENTER] key.

The display and the display mode indication at the top left-hand corner of the display change in the sequence of HU (heading up), CU (course up), NU (north up) and TM (true motion) when the [ACQ/ENTER] key is pressed. If there is no heading sensor connection, the display mode is always HU.

4. Press the [MENU] key to close the menu.

**Note:** The radar begins operation with last selected display mode (except course up) whenever the unit is turned on. Note however that head up is selected when course up was the last used mode.

### Head up

The picture is oriented so the heading marker is at the top of the display. This mode is useful for navigation in congested waters.

### Course up

The course up mode shows ship’s heading by the heading marker, at the top of the display. To get heading desired, steer vessel in direction desired, and then show “CU” at the top left-hand corner of the display.

## North up

North is at the top of the display and the heading marker moves with ship's heading. This mode is useful for determining ship's position and as a navigation monitor on a nautical chart. The picture is stabilized against yaw of vessel, thereby reducing smear of target echoes.

## True motion

True motion displays own ship and moving objects in their true motion.

## 3.3 Magnifying Long Range Echoes (echo stretch)

Normally, the reflected echoes from long range targets appear on the display as weaker and smaller blips even though they are compensated by the radar's internal circuitry. The echo stretch function magnifies these small blips in all ranges. Two types of echo stretch are available: ES1 which stretches echoes in bearing direction and ES2 which stretches them in both range and bearing directions.

### To turn the echo stretch on or off;

1. Press the [MENU] key to open the menu.
2. Select "ES."
3. Each press of the [ACQ/ENTER] key changes the echo stretch function status in the sequence of ES1, ES2 and OFF. ES1 or ES2 appears at the top right-hand corner of the display when echo stretch is on.

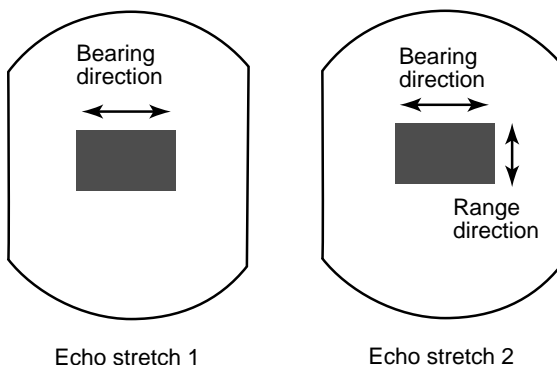

Figure 3-3 Echo stretch

**Note1:** This function magnifies not only targets but also sea clutter and radar interference. For this reason be sure the sea clutter and radar interference are sufficiently suppressed before activating the echo stretch.

**Note2:** ES2 is not available on short range.

## 3.4 Echo Trail

You can show the movement of all radar targets relative to your vessel in afterglow. This function is useful for alerting you to possible collision situations.

### Starting echo trail

1. Press the [MENU] key to open the menu.
2. Select "ECHO TRAIL" by the omnipad.
3. Select "ACTIVATE" by pressing the [ACQ/ENTER] key.

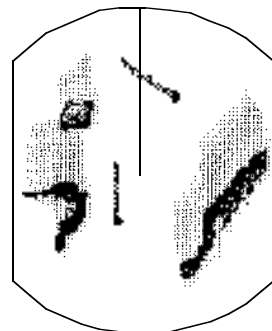

Figure 3-4 How the echo trail feature works

TRAIL, the echo trail time selected (on "OTHERS MENU") and elapsed time appear at the top right-hand corner of the display. Then, afterglow starts extending from all targets.

**Note:** Trails are restarted when range or mode is changed or zoom or offcenter is turned on.

## Fixed time trail

1. When the elapsed time clock counts up to the trail time selected, the elapsed time display freezes.
2. The oldest portions of trails are erased so only the latest trail, equal in length to the trail time selected, is shown.
3. Trail continues.

For example, the one minute trail time is selected. When the elapsed time clock counts up to 60 seconds, the elapsed time display freezes at "60," but the latest one minute of trail are erased and then trail continuous.

## Continuous trail

The maximum continuous trail time is 99 minutes and 59 seconds. When the elapsed time clock counts up to that time the elapsed time display is reset to zero and trail begins again.



## Cancelling echo trail

Select "OFF (deactivate)" at "ECHO TRAIL" on the menu.

## Changing trail attributes

Trail gradation and trail time can be selected on the OTHERS menu.

*Table 3-1 Trail attributes*

Item in OTHERS menu	Description
Trail Tone	Trails can be shown in single or multiple gradations. Multiple paints trails getting thinner with time just like the afterglow on an analog PPI radar.  <div style="display: flex; justify-content: space-around; align-items: center;"> <div style="text-align: center;"> <p>Single</p>  </div> <div style="text-align: center;"> <p>Multiple</p>  </div> </div>
Trail Time	Trail time can be set for 15 sec., 30 sec., 1 min., 3 min., 6 min., 15 min., 30 min., or continuous.

## 3.5 Suppressing Radar Interference

Radar interference may occur when near another shipborne radar operating in the same frequency band as your radar. Its on-screen appearance is many bright dots either scattered at random or in the form of dotted lines extending from the center to the edge of the display. Figure 3-5 illustrates interference in the form of curved spokes. Interference effects are distinguishable from normal echoes because they do not appear in the same place on successive rotations of the scanner.

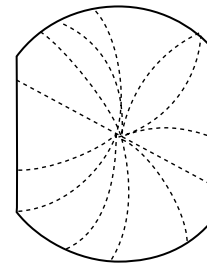

*Figure 3-5 Radar interference*

Four levels of interference are available, including off; IR1, IR2, IR3 and OFF. IR3 provides the highest level of rejection.

1. Press the [MENU] key.
2. Select "OTHERS MENU" and press the [ACQ/ENTER] key.

[ OTHERS ]				
Select item by omnipad and press ENTER key.				
1. Panel Dimmer	1	2	3	4
2. Mark Brill	1	2	3	4
3. HD Mark	1	2	3	4
4. Characters	1	2	3	4
5. Trail Tone	Single	Multi		
6. Int Reject	Off	1	2	3
7. Pulselength	Short	Long		
8. Noise Reject	Off	On		
9. Trail Time	15S	30S	1M	
	3M	6M	15M	30M
10. Tune	Auto	Manu		
11. Disp Data	Off	Nav	ARP	All
12. WPT Mark	Off	On		
13. EBL Ref	Rel	True		
14. VRM Unit	nm	km	sm	
15. Watchman	Off	5M	10M	20M
16. STBY Disp	Norm	Econo	Nav	
17. Guard Mode	In	Out		
18. Own Position	L/L	TD		
19. Cursor Posi	R/B	L/L		
20. Alm Sense LV	Low	Mid	Hig	
21. Dead Sector	Off	On		
22. Range	1/8	1/4	1/2	3/4
	1	1.5		
	2	3	4	6
	8	12	16	14
				16 43 64
23. Self Test				
24. Installation Setup				

\*Max range  
1932M2: 48  
1942M2: 64

*Figure 3-6 OTHERS menu*

3. Select "6. Int Reject."
4. Select level desired by operating the omnipad.
5. Press the [ACQ/ENTER] key.
6. Press the [MENU] key to close the menu.

IR1, IR2 or IR3 appears at the bottom right corner on the display when the interference rejection circuit is turned on.

### 3.6 Selecting Pulsewidth

Pulsewidth is the time in microseconds necessary to transmit a single radar pulse. The longer the pulsewidth the greater the direction range capability, however range accuracy and range resolution are reduced.

Pulsewidth can be selected to short or long on the 1.5 and 3 nautical mile ranges.

1. Press the [MENU] key.
2. Select "OTHER MENU" and press the [ACQ/ENTER] key.
3. Select "7. Pulselength."
4. Select Short or Long by pressing the omnipad.
5. Press the [ACQ/ENTER] key to select.
6. Press the [MENU] key to close the menu.

### 3.7 Guard Alarm

The guard alarm allows the operator to set the desired range and bearing for a guard zone. When ships, islands, landmasses, etc. violate the guard zone an audible alarm sounds and the offending target blinks to call the operator's attention.

	<h2>CAUTION</h2>
<p>The guard alarm is a useful anti-collision aid, but does not relieve the operator of the responsibility to also keep a visual lookout for possible collision situations. The alarm should never be used as the sole means for detecting possible collision situations.</p>	

### Selection of guard zone type

The guard alarm can be set to sound when a target either enters or exits the guard zone. You can select which type of guard alarm you want through the menu.

#### In alarm

The alarm sounds on targets entering the guard zone. "G (IN)" appears at the top right-hand corner when the In alarm is selected.

#### Out alarm

The alarm sounds on targets exiting the guard zone. "G (OUT)" appears at the top right-hand corner when the Out alarm is selected.

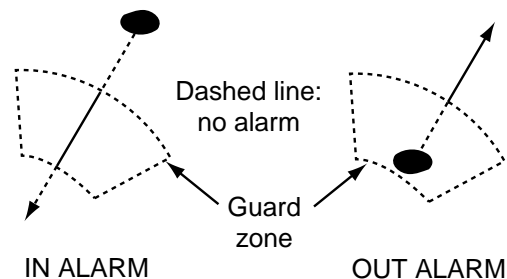

Figure 3-7 In and Out alarms

### Selecting guard zone type

1. Press the [MENU] key, select "OTHERS MENU," and then press the [ACQ/ENTER] key.
2. Select "17. Guard Mode" and "In" (alarm on target entering zone) or "Out" (alarm on target exiting zone) by operating the omnipad.
3. Press the [ACQ/ENTER] key.
4. Press the [MENU] key to close the menu.

### Setting a guard zone

1. Mentally create the guard zone you want to set. Figure 3-8 shows an example.
2. Operate the omnipad to set the cursor on point A (or B). Press the [GUARD] key. "\*G (IN)" or "\*G (OUT)," with asterisk blinking, appears at the top right-hand corner of the display. See Figure 3-8 (2). (The asterisk indicates the guard zone is partially set.)

- Operate the omnipad to set the cursor on point C (or D). See Figure 3-8 (3).
- Press the [GUARD] key. The asterisk disappears. See Figure 3-8 (4).

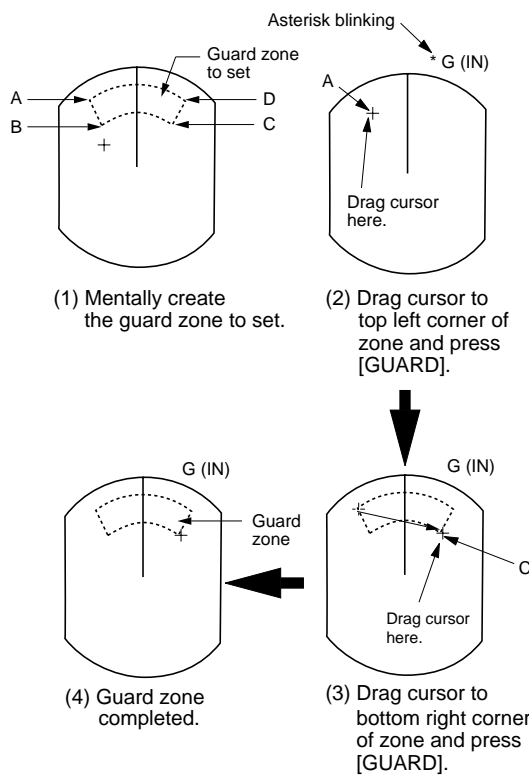

Figure 3-8 How to set the guard zone

### Silencing the audible alarm

Any radar targets violating the guard zone will trigger the audible alarm. You can silence the audible alarm by pressing the [GUARD] key. When this is done, "G(ACKN)" replaces "G(IN)." This means the alarm is acknowledged. Press the key again to reactivate the alarm. You may select minimum echo strength which triggers the guard alarm. This can be done at "20, Alm Sence Lv" on the "OTHER MENU."

### Cancelling the guard zone and guard alarm

Press and hold down the [GUARD] key until the guard zone disappears.

### Notes on the guard alarm

- The alarm is a useful anti-collision aid, but does not relieve the operator of the responsibility to also keep a visual lookout for possible collision situations.
- When the radar range is less than one half of the guard zone range, the guard zone disappears and "G (IN)" or "G (OUT)" appears in inverse video. If this happens, raise range to re-display the guard zone.
- A target echo does not always mean a landmass, reef, ships or surface objects but can imply returns from sea surface or precipitation. As the level of these returns varies with environment, the operator should properly adjust the A/C SEA, A/C RAIN and GAIN to be sure the alarm system does not overlook target echoes.

### 3.8 Watchman

The watchman function periodically transmits the radar for one minute to check for targets in a guard zone. If it finds change in the zone from the previous transmission it transmits the radar continuously. This feature is useful when you do not need the radar's function continuously but want to be alerted to radar targets in a specific area.

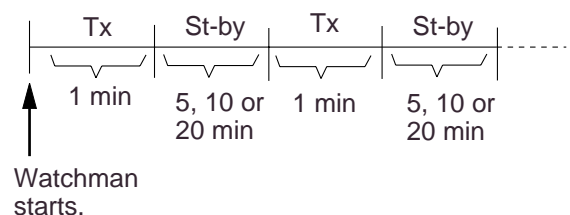

Figure 3-9 How watchman works

### How watchman works

When the time selected for the watchman rest period has elapsed, the radar automatically transmits for one minute to check the condition inside the guard zone. If there is no change, the radar goes into stand-by. ("WATCHMAN" appears during stand-by.) If there is change, the radar sounds the audible alarm, cancels the watchman function and transmits continuously.



## Turning on watchman

1. Create a guard zone (usually 360 degrees) with the guard alarm function.
2. Press the [MENU] key.
3. Select "OTHERS MENU."
4. Press the [ACQ/ENTER] key.
5. Select "15. Watchman."
6. Operate the omnipad to select watchman rest period; 5 minutes, 10 minutes or 20 minutes.
7. Press the [ACQ/ENTER] key.
8. Press the [MENU] key to close the menu.

"WATCHMAN" appears at the top of the screen, the radar transmits for one minute to check for targets inside the guard zone, and then the CRT shuts off and the radar goes into stand-by.

## Cancelling watchman

Go into the "OTHERS" menu, and set "15. Watchman" for OFF.

**Note 1:** Watchman can be used without a guard zone.

**Note 2:** The alarm sounds just before the radar starts or stops transmitting.

## 3.9 Displaying Navigation Data

Navigation data can be displayed at the screen bottom if this radar receives navigation input in IEC 61162 format. Navigation data includes

- Position in latitude and longitude or Loran-C time differences
- Range, bearing and time-to-go to both waypoint selected on the navigator and the cursor
- Speed.

(If the navigation input includes destination data, the waypoint marker, shown by a dashed ring with a line extending from it to the screen center appears. This marker can be turned on/off the "OTHER MENU")

## To turn navigation data on or off;

1. Press the [MENU] key.
2. Select "DISP DATA."
3. Press the [ACQ/ENTER] key.
4. Press the [ACQ/ENTER] key to select the navigation display.
5. Press the [MENU] key to close the menu.

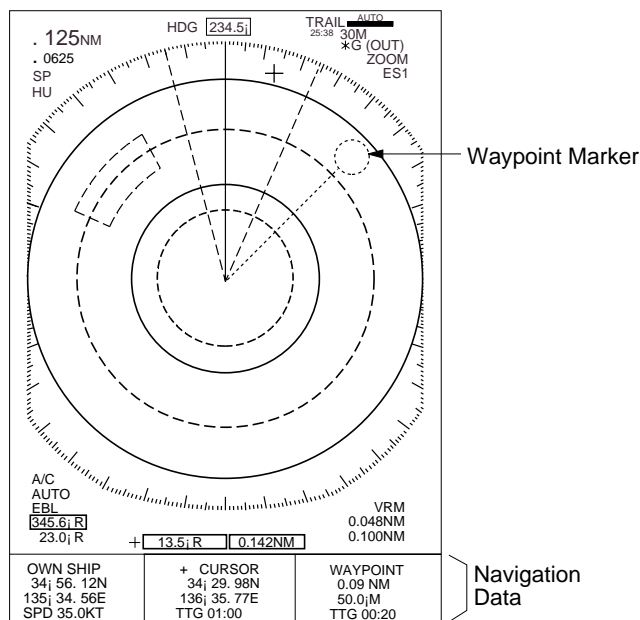

Figure 3-10 Typical navigation data display

### 3.10 OTHER MENU Description

The table below summarizes the OTHER menu.

*Table 3-2 OTHER MENU Description*

Item	Description
1. Panel Dimmer	Selects level of panel backlight.
2. Mark Brill	Selects brilliance of VRM, EBL, cursor, guard zone and WP marker.
3. HD Mark	Selects brilliance of heading marker.
4. Characters*	Selects brilliance of characters.
5. Trail Tone	Selects brilliance of echo trails.
6. Int Reject	Selects level of interference rejection.
7. Pulselength	Selects pulselength for 1.5 and 3 mile ranges.
8. Noise Reject	Selects "On" to reject noise.
9. Trail Time	Selects the echo trail time.
10. Tune	Selects automatic or manual tuning. To tune manually;  <ol style="list-style-type: none"> <li>1. Select "Manu" by the omnipad.</li> <li>2. Press the [ENTER] key to enable manual tuning.</li> <li>3. While pressing and holding down the [GAIN] control, operate the omnipad to obtain best tuning condition, observing the tuning indicator bar (1.0~11.9V).</li> <li>4. Press the [ENTER] key.</li> </ol> "MANUAL" appears at the top right-hand corner when manual tuning is in effect.
11. Disp Data	Select the down source to display. Selects data to display; Nav, ARP, or All (both Nav and ARP).
12. WPT Mark	Selects "On" to display the waypoint marker.
13. EBL Ref	Selects EBL reference for relative or true.
14. VRM Unit	Selects distance unit of VRM and cursor for nm, km or sm.
15. Watchman	Turns watchman on (set rest period) or off.
16. STBY Disp	Select the display to use at stand-by; display "STBY" or navigation data, or go into the economy mode.
17. Guard Mode	Select condition which triggers guard alarm; targets entering guard zone (In), target exiting guard zone (out).
18. Own Position	Select position display format; L/L on Loarn TD.
19. Cursor Posi	Display the cursor data in range/bearing or lat/long.
20. Alm Sense LV	Select minimam echo strength which triggers guard alarm.
21. Dead Sector	Select "On" to display the dead sector.
22. Range	Select ranges to use.
23. Self Test	Test keys, ROM and RAM; checks antenna rotation speed, and displays program no.
24. Installation Setup	Displays to the installation setup menu.

**\*Note:** Level 1 and 2 are same brilliance while the menu is displayed. The brilliance changes after the menu is erased.

### 3.11 Function Controls

The function controls (F1 and F2) work like the auto-dialing feature of a telephone, automatically executing the function assigned to them. The function can be turned off by pressing appropriate function control again.

#### Default settings

F1: Shift (brief press) or Zoom (long press)

F2: Ring brilliance

#### How to register menu items

1. Press the [MENU] key.
2. Press [A/C SEA] (F1) or [A/C RAIN] (F2) to open the function menu.



Figure 3-11 Function menu

3. Select function desired.
4. Press the [ACQ/ENTER] key.
5. Press the [MENU] key to close the menu.

### 3.12 Suppressing Noise

Electrical noise can be suppressed by turning on “8. NOISE REJ” on the OTHERS menu.

### 3.13 Adjusting Brilliance of Markers

“2. Mark Brill” on the OTHER menu adjusts the brilliance of markers other than the heading marker.

### 3.14 Outputting Target Position

Radar target position data can be output to a navaid in IEC 61162 format. Select the radar target with the cursor, and then press and hold down the [TLL] key to output the data. This function requires position data and heading signal.

### 3.15 Dead Sector

When the scanner is installed at a close distance in front of the wheelhouse the radar should be set not to transmit within that area, to prevent microwave hazard. Ask your FURUNO representative or dealer to provide this feature.

# 4. FALSE ECHOES

Occasionally false echoes appear on the screen at positions where there is no target. In some cases the effects can be reduced or eliminated. The operator should familiarize himself or herself with the appearance and effects of these false echoes, so as not to confuse them with echoes from legitimate contacts.

## 4.1 Multiple Echoes

Multiple echoes occur when a short range, strong echo is received from a ship, bridge, or breakwater. A second, a third or more echoes may be observed on the display at double, triple or other multiples of the actual range of the target as shown in Figure 4-1. Multiple reflection echoes can be reduced and often removed by decreasing the sensitivity or properly adjusting the A/C SEA.

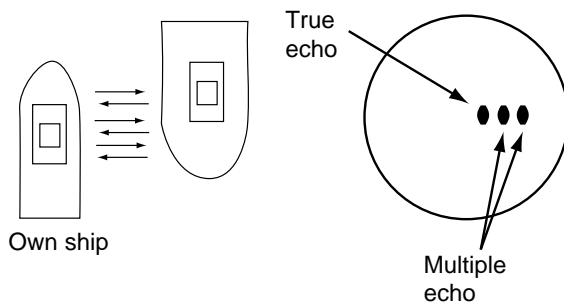

Figure 4-1 Multiple echoes

## 4.2 Side-lobe Echoes

Every time the scanner rotates, some radiation escapes on each side of the beam—called “side-lobes.” If a target exists where it can be detected by the side-lobes as well as the main-lobe, the side-lobe echoes may be represented on both sides of the true echo at the same range, as shown in Figure 4-2. Side-lobes show usually only at short ranges and from strong targets. They can be reduced through careful reduction of the sensitivity or proper adjustment of the A/C SEA.

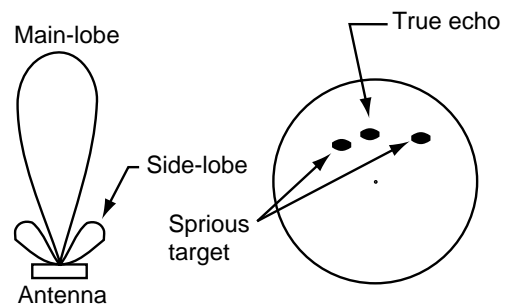

Figure 4-2 Side-lobe echoes

### 4.3 Indirect Echoes

Indirect echoes may be returned from either a passing ship or returned from a reflecting surface on your own ship, for example, a stack. In both cases, the echo will return from a legitimate contact to the scanner by the same indirect path. The echo will appear on the same bearing of the reflected surface, but at the same range as the direct echo. Figure 4-3 illustrates the effect of an indirect echo. Indirect echoes may be recognized as follows:

- they usually occur in a shadow sector
- they appear on the bearing of the obstruction but at the range of the legitimate contact
- when plotted, their movements are usually abnormal, and
- their shapes may indicate they are not direct echoes.

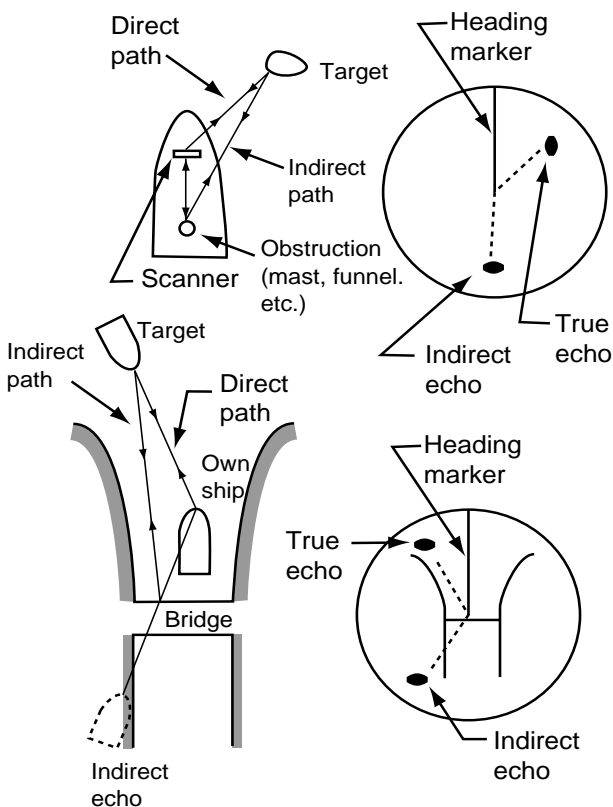

Figure 4-3 Indirect echoes

### 4.4 Blind and Shadow Sectors

Funnels, stacks, masts, or derricks in the path of antenna may reduce the intensity of the radar beam. If the angle subtended at the antenna is more than a few degrees a blind sector may be produced. Within the blind sector small targets at close range may not be detected while larger targets at much greater ranges may be detected. See Figure 4-4.

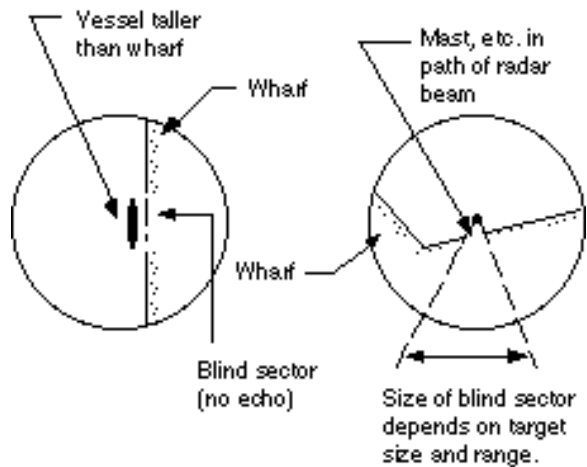

Figure 4-4 Blind and shadow sectors

## 4.5 SART (Search and Rescue Transponder)

A Search and Rescue Transponder (SART) may be triggered by any X-Band (3 cm) radar within a range of approximately 8 n.miles. Each radar pulse received causes it to transmit a response which is swept repetitively across the complete radar frequency band. When interrogated, it first sweeps rapidly ( $0.4 \mu\text{s}$ ) through the band before beginning a relatively slow sweep ( $7.5 \mu\text{s}$ ) through the band back to the starting frequency. This process is repeated for a total of twelve complete cycles. At some point in each sweep, the SART frequency will match that of the interrogating radar and be within the pass band of the radar receiver. If the SART is within range, the frequency match during each of the 12 slow sweeps will produce a response on the radar display, thus a line of 12 dots equally spaced by about 0.64 nautical miles will be shown.

When the range to the SART is reduced to about 1 nm, the radar display may show also the 12 responses generated during the fast sweeps. These additional dot responses, which also are equally spaced by 0.64 nm, will be interspersed with the original line of 12 dots. They will appear slightly weaker and smaller than the original dots.

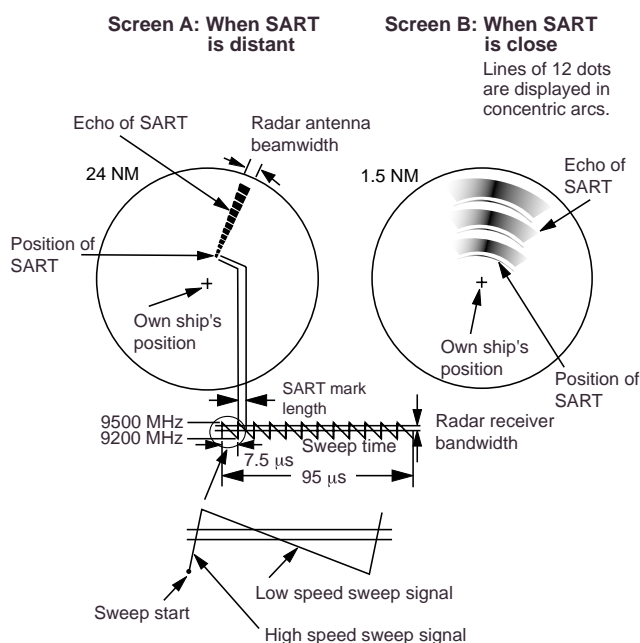

Figure 4-5 SART display

## Showing SART marks on the radar display

To show the SART marks only on the radar display, detune the radar receiver manually. This erases or weakens all normal radar echoes, but, the SART marks are not erased because the SART response signal scans over all frequencies in the 9 GHz band. When the radar approaches the SART in operation, the SART marks will enlarge to large arcs, blurring a large part of the screen. Reduce the sensitivity and adjust the sea clutter control of the radar.

## Summary to detect SART response

1. Use range scale of 6 or 12 nm as the spacing between the SART responses is about 0.6 nm (1125 m) to distinguish the SART.
2. Turn off the automatic clutter suppression.
3. Turn off the Interference Rejector.

## General remarks on receiving SART

### Radar range scale

When looking for a SART it is preferable to use either the 6 or 12 nautical mile range scale. This is because the total displayed length of the SART response of 12 (or 24) dots may extend approximately 9.5 nautical miles beyond the position of the SART and it is necessary to see a number of response dots to distinguish the SART from other responses.

### SART range errors

When responses from only the 12 low frequency sweeps are visible (when the SART is at a range greater than about 1 nm), the position at which the first dot is displayed may be as much as 0.64 nm beyond the true position of the SART. When the range closes so that the fast sweep responses are seen also, the first of these will be no more than 150 meters beyond the true position.

# 5. MAINTENANCE & TROUBLESHOOTING

This chapter tells you how to keep your radar in good working order. Before reviewing this chapter please read the safety information which follows.

## DANGER

**Turn off the power before performing any maintenance or troubleshooting procedure.**

Hazardous voltages can shock, burn or cause death. Only qualified personnel totally familiar with electrical circuits should work inside the units.

---

**RF RADIATION HAZARD**

The radar scanner emits high frequency radio radiation which can be harmful, particularly to your eyes.

Never look directly into the scanner from a distance of less than two feet when the radar is in operation as you could injure the cornea of your eyes. Always make sure the radar is set to stand-by or is turned off before starting work on the scanner unit.

## 5.1 Preventive Maintenance

Regular maintenance is important for good performance. Always keep the equipment as free as possible from dirt, dust, and water splashes. Make sure all screws securing the components are properly tightened.

A maintenance program should be established and should at least include the items listed in Table 5-1.

## 5.2 Replacing the Fuse

The fuse in the power cable protects the equipment against reverse polarity of ship's mains, overcurrent, and equipment fault. If the fuse blows, find the cause before replacing it. Never use an incorrect fuse - serious damage to the equipment may result and void the warranty.

12V: 10A fuse  
24/32V: 5A fuse

## CAUTION

**Use the proper fuse.**

Use of a wrong fuse can result in equipment damage.

*Table 5-1 Recommended maintenance program*

Period	Item	Check point	Remarks
3 to 6 months	Exposed nuts and bolts on scanner unit	Check for corroded or loosened nuts and bolts. If necessary, clean and repaint them thickly. Replace them if heavily corroded.	Sealing compound may be used instead of paint. Apply a small amount of grease between nuts and bolts for easy removal in future.
	Scanner radiator	Check for dirt and cracks on radiator surface. Thick dirt should be wiped off with soft cloth dampened with fresh water. If a crack is found, apply a slight amount of sealing compound or adhesive as a temporary remedy, then call for repair.	Do not use plastic solvent (acetone) for cleaning. If you need to remove ice from scanner unit, use a wooden hammer or plastic head hammer. Crack on the unit may cause water ingress, causing serious damages to internal circuits.
6 months to 1 year	Display unit connectors	Check for tight connection and corrosion.	If corroded, contact your dealer for replacement.

## 5.3 Troubleshooting

Table 5-2 contains simple troubleshooting procedures which you can follow to try to restore normal operation. If you cannot restore normal operation, do not attempt to check inside any unit of the radar system. Any repair work is best left to a qualified technician.

*Table 5-2 Troubleshooting table*

<b>If...</b>	<b>But...</b>	<b>Then...</b>
you pressed the [POWER] key to turn on the radar	the control panel does not light	<ul style="list-style-type: none"> <li>• try adjusting the control panel back-lighting on the OTHERS menu.</li> <li>• battery may have discharged.</li> <li>• check fuse in power cable.</li> </ul>
	nothing appears on the display or display contrast is poor	<ul style="list-style-type: none"> <li>• try adjusting the brilliance.</li> </ul>
	characters are distorted	<ul style="list-style-type: none"> <li>• request service.</li> </ul>
the radar has warmed up and you pressed the [STBY TX] key to transmit	the scanner does not rotate	<ul style="list-style-type: none"> <li>• the problem may be in scanner unit. Request service.</li> </ul>
	characters and indications are abnormal	<ul style="list-style-type: none"> <li>• have a qualified technician check the set.</li> </ul>
you have adjusted the gain with A/C RAIN and A/C SEA off	neither noise nor targets appear (indications and markers do)	<ul style="list-style-type: none"> <li>• check signal cable for damage.</li> </ul>
	neither indications nor markers appear (noise and targets do)	<ul style="list-style-type: none"> <li>• check signal cable for damage.</li> </ul>
	the sweep (radial line sweeping around the display) is not synchronized with scanner rotation	<ul style="list-style-type: none"> <li>• the problem may be in the scanner unit. Request service.</li> </ul>
	there is no change in sensitivity	<ul style="list-style-type: none"> <li>• request service.</li> </ul>
a key is pressed	nothing happens	<ul style="list-style-type: none"> <li>• key may be faulty. Request service.</li> </ul>



## 5.4 Self Test

The self test facility checks the keyboard, ROM and RAM for proper operation.

1. Press the [MENU] key.
2. Select "OTHER MENU".
3. Select "23. Self Test" and press the [ACQ/ENTER] key. The following display appears.

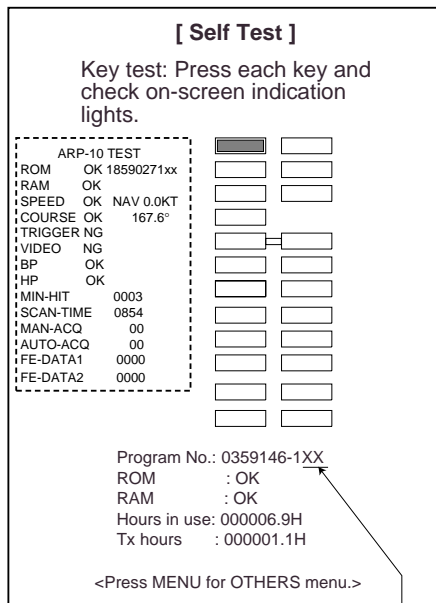

Version no.  
11 and after is available  
with MARK-2 series.

Figure 5-1 Self test screen

4. The ROM and RAM are automatically checked. If NG (No Good) appears to the right of ROM or RAM indication, contact your dealer for advice. ARP-10 TEST results appear only when optional ARP-10 board is mounted.
5. To check the keyboard, press any key except [ACQ/ENTER] and [POWER] keys. The pressed key's on-screen location lights in black while the key is pressed, if the key is operating properly.

6. Press the [ACQ/ENTER] key to check the display circuit. The following pattern should appear.

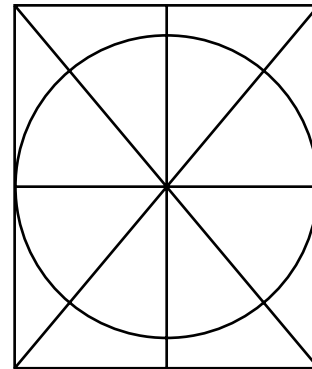

Figure 5-2 Test pattern

7. To return to the Self Test menu, press the [MENU] key.
8. To escape from the self test, press the [MENU] key.

## 5.5 Life Expectancy of Magnetron

The following table shows the life expectancy of the magnetrons.

Table 5-3 Life expectancy of magnetrons

Model	Type	Code no.	Life expectancy
1932 M2	E3571	000-137-527	2,000-3,000 hours (Including stand-by)
1942 M2	MG5389	000-135-146	

## 6. OPERATION OF ARP-10 (OPTION)

### **WARNING**

No one navigational aid should be relied upon for the safety of vessel and crew. The navigator has the responsibility to check all aids available to confirm position. Electronic aids are not a substitute for basic navigational principles and common sense.

- This auto plotter automatically tracks an automatically or manually acquired radar target and calculates its course and speed, indicating them by a vector. Since the data generated by the auto plotter are based on what radar targets are selected, the radar must always be optimally tuned for use with the auto plotter, to ensure required targets will not be lost or unwanted targets such as sea returns and noise will not be acquired and tracked.
- A target does not always mean a land-mass, reef, ships or other surface vessels but can imply returns from sea surface and clutter. As the level of clutter changes with environment, the operator should properly adjust the A/C SEA, A/C RAIN and GAIN controls to be sure target echoes are not eliminated from the radar screen.

### **CAUTION**

The plotting accuracy and response of this auto plotter meets IMO standards. Tracking accuracy is affected by the following:

- Tracking accuracy is affected by course change. One to two minutes is required to restore vectors to full accuracy after an abrupt course change. (The actual amount depends on gyrocompass specifications.)
- The amount of tracking delay is inversely proportional to the relative speed of the target. Delay is on the order of 15–30 seconds for high relative speed; 30–60 seconds for low relative speed.

Display accuracy is affected by the following:

- Echo intensity
- Radar transmission pulsewidth
- Radar bearing error
- Gyrocompass error
- Course change (own ship or target)

This ARPA board is not available with 42 rpm radar.

### **NOTICE**

Heading data required for plotting function.

## 6.1 General

The Auto Plotter ARP-10 is an optional circuit board which is accommodated in the display unit of this radar (24 rpm only) radars. It requires heading data to function.

The Auto Plotter permits manual or automatic acquisition and automatic tracking of up to 10 radar targets. An internal microprocessor calculates target data such as speed and course and displays the results in alphanumeric data and by vector. To ensure the reliability of the displayed target data, the radar must be properly adjusted for minimum sea returns and noise.

### Principal specifications

#### Acquisition and tracking

- Acquisition of up to 10 targets between 0.2 and 16 nm.
- Automatic tracking of up to 10 acquired targets between 0.1 and 16 nm.

#### Vectors

Vector length: 30 s, 1, 3, 6, 15, 30 min.

Orientation: True velocity or relative velocity

Past positions: 5 past positions at intervals of 15, 30 s, 1, 2, 3, 6 min.

Alarm: Visual and audible alarms against targets violating CPA/TCPA limits, Visual alarm against lost targets

Target discrimination: A target measuring about 800 m or more in the radial or circumferential direction is regarded as a landmass and not acquired or tracked. Echoes smaller than about 800 m are regarded as true targets.

#### Keys used for auto plotter

The ARP-10 uses the following touchpad keys. Given below is a brief description of these keys.

**MENU:** opens/closes the main menu.

#### **SELECT/CANCEL:**

A long press terminates plotting of the target selected with the cursor, and a brief press displays the data of the target selected with the cursor.

**ACQ/ENTER:** Acquires the target selected with the cursor.

## 6.2 ARP-10 MENU Operation

The ARP-10 MENU contains the following items.

**Display:** Turns on/off the plot symbols, past positions and target data.

**All Cancel:** Cancels the tracking of all targets.

**Vector Ref:** Selects relative or true vectors. To select your choice, open the ARP-10 menu. Select "3 Vector Ref" to Relative or True, and then, press the [ACQ/ENTER] key.

**Vector Length:** Selects vector time.

**History:** Selects past position plot interval.

**CPA Set:** Selects CPA alarm limit. When a target is predicted to come within this limit, an audible alarm sounds and at the same time the corresponding target symbol changes to a blinking triangle.

**Note:** If the preset CPA limit is set at OFF, a target which is on collision course will not produce an alarm.

**TCPA Set:** Selects TCPA alarm limit.

**Auto ACQ:** Turns on/off Auto Acquisition Area.

### Activating the auto plotter

To activate the Auto Plotter, follow the steps shown below.

1. Adjust the GAIN, A/C SEA and A/C RAIN controls for proper radar picture.
2. Press the [MENU] key to open the main menu.

3. Select "ARP-10 MENU."
4. Press the [ACQ/ENTER] key to display the ARP menu.

5. Select the menu item "1. Display."
6. Select "On."
7. Press the [ACQ/ENTER] key.
8. Press the [MENU] key to close the menu.

[ ARP MENU ]		
Select item by omnipad and press ENTER key.		
1. Display	Off	<b>On</b>
2. All Cancel		
3. Vector Ref	Rel	<b>True</b>
4. Vector Length		30S IM
		3M 6M 15M <b>30M</b>
5. History		<b>Off</b> 15S 30S 1M
		2M 3M 6M
6. CPA Set		<b>Off</b> 0.5 1nm 2nm
		3nm 5 nm 6nm
7. TCPA Set		<b>30S</b> 1M 2M 3M
		4M 5M 6M 12M
8. Auto ACQ	<b>Off</b>	On

### Deactivating the auto plotter

To deactivate the Auto Plotter;

1. Open the "ARP-10 MENU."
2. Select the "1. Display."
5. Select "Off."
6. Press the [ACQ/ENTER] key.
7. Press the [MENU] key to close the menu.

Figure 6-1 ARP Menu

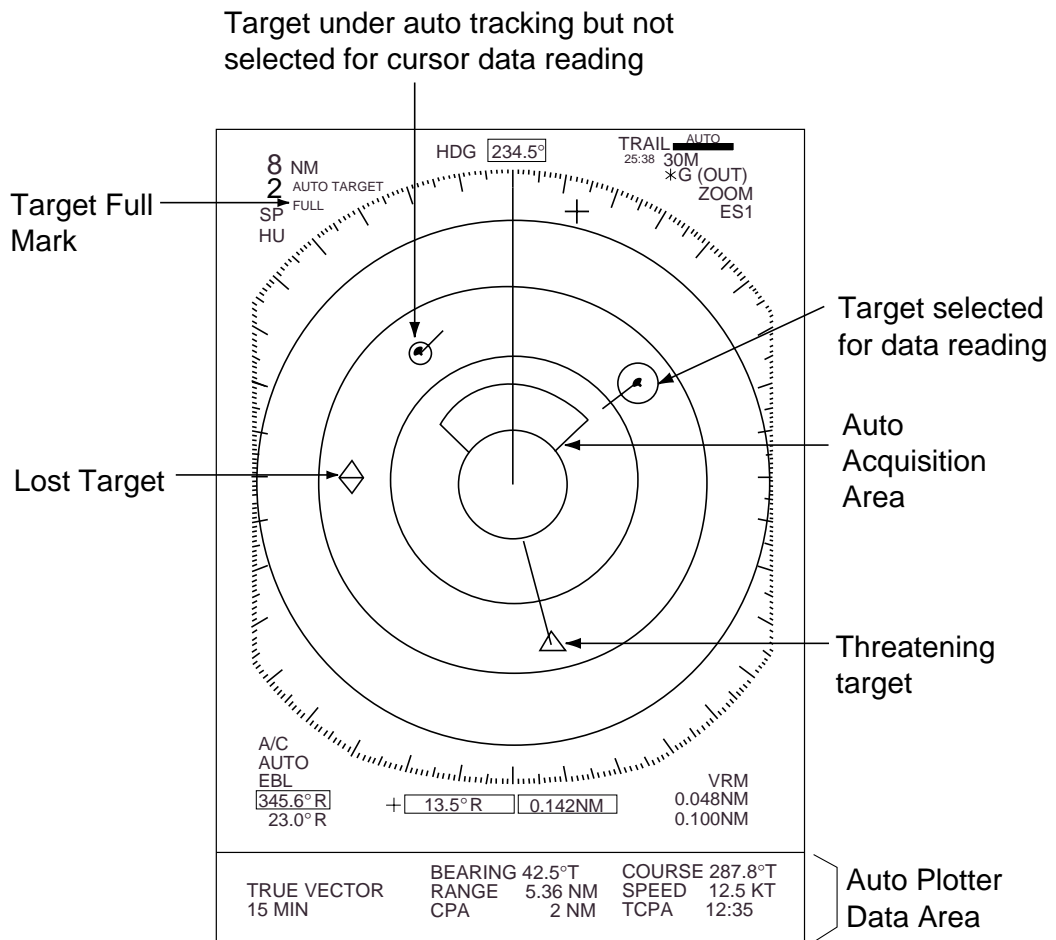

Figure 6-2 ARPA display

## 6.3 Acquiring Targets

### Manual acquisition

Follow the steps below to manually acquire a target. Up to 10 targets can be manually acquired.

1. Place the cursor (+) on a target of interest by operating the omnipad.
2. Press the [ACQ/ENTER] key.

The plot symbol changes its shape according to the status as below. A vector appears in about one minute after acquisition indicating the target's motion trend. If the target is consistently detected for three minutes, the plot symbol changes to a solid mark. If acquisition fails, the target symbol blinks and disappears shortly thereafter.

 **SQUARE (dotted)**

Immediately after acquisition - Plot symbol shown in broken lines.

 **SQUARE (dotted with a vector)**

One minute after acquisition - Vector still unreliable.

 **CIRCLE (Solid with a vector)**

3 minutes after acquisition - Plot symbol changes to a solid circle indicating the stable tracking condition.

 **LARGE CIRCLE**

The plot symbol of a target under tracking becomes twice as large as the normal symbol when the target is selected for data reading.

**Note 1:** The target to be acquired should be within 0.2 to 16 nm from own ship and not obscured by sea or rain clutter for successful acquisition.

**Note 2:** When you want to acquire 11th target, cancel tracking of the one of less important targets.

**Note 3:** When the auto acquisition mode (Auto ACQ) is on, up to five targets can be acquired. For details, see next section titled Automatic Acquisition.

### CAUTION

When a tracked target nears another tracked target, the targets may be "swapped." When two targets come close to each other, one of the two can become a "lost target." Should this happen, reacquisition of the "lost target" is required after the two targets have separated.

### Automatic acquisition

The Auto Plotter ARP-10 can acquire up to five targets automatically by setting the Auto Acquisition area predefined in the system. If Auto ACQ is selected after more than five targets have been manually acquired, only the remaining capacity of targets can be automatically acquired. (For example; when seven targets are acquired manually, and then the Auto ACQ is switched on only three targets can be acquired automatically.) When five targets have been automatically acquired, "AUTO TARGET FULL" message appears at top left corner on the display.

### Setting auto acquisition area

Auto acquisition area is predefined between 2.0 and 2.5 nm in range and 45° on either side of the heading marker in bearing. If a target come into this area, it is acquired automatically.

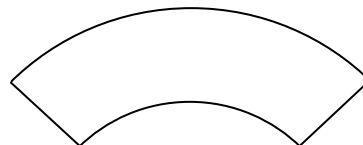

Figure 6-3 Auto acquisition area

Follow the steps shown below to activate the auto acquisition area.

1. Open the "ARP-10 MENU."
2. Select "8. Auto ACQ."
3. Select "On."
4. Press the [ACQ/ENTER] key.
5. Press the [MENU] key to close the menu.

## Terminating Tracking of Targets

When the Auto Plotter has acquired 10 targets, no more acquisition occurs unless targets are lost. Should this happen, cancel tracking of individual targets or all targets by the procedure described below.

### Individual targets

Place the cursor (+) on a target which you do not want to be tracked any longer by operating the omnipad and press and hold down the [SELECT/CANCEL] key.

### All targets

All targets can be canceled from "ARP-10 MENU" at a time.

1. Open the "ARP-10 MENU."
2. Select "2. All Cancel."
3. Press the [ACQ/ENTER] key.

## 6.4 Displaying Target Data

The Auto Plotter calculates motion trends (range, bearing, course, speed, CPA and TCPA) of all targets under tracking at the ARP Data area.

To turn ARP data on;

1. Press the [MENU] key.
2. Select "DISP DATA."
3. Press the [ACQ/ENTER] key to select the message for "ARP" or "NAV" or "ARP."

4. Press the [ACQ/ENTER] key.
5. Press the [MENU] key to close the menu.

### CAUTION

At the speed under 5 kts the target data is displayed with a delay because of filtration.

Place the cursor on a wanted target and press the [SELECT/CANCEL] key. Data on the selected target is displayed at the bottom of the screen. The symbol of the selected target gets twice as large as the normal circle. The data includes the following:

**RNG/BRG (Range/Bearing):** Range and bearing from own ship to the last-plotted or selected target position with suffix "T" (True) or "M" (Magnetic). For true bearings suffix "T" is used in case of gyrocompass input and suffix "M" is used in case of magnetic compass input.

**COURSE/SPEED (Course/Speed):** Course and speed are displayed for the last-plotted or selected target with suffix "T" (True) or "M" (Magnetic). For true bearings suffix "T" is used in case of gyrocompass input and suffix "M" is used in case of magnetic compass input.

**CPA (Closest Point of Approach):** is the closest range a target will approach to own ship. Do not mix it with the operator preset CPA alarm limit.

**TCPA:** The time to CPA measured with present speeds of own ship and the targets. Both CPA and TCPA are automatically calculated. When a target ship has passed clear of own ship, the CPA is displayed and the TCPA appears as "\*\*.\*". TCPA is counted up to 99.9 min. and beyond this it is indicated as TCPA>99.9 min.

## 6.5 Mode and Length of Vectors

### True or relative vector (vector mode)

Target vectors are displayed relative to own ships reading (Relative) or with reference to North (True). Own ship does not have a vector in relative mode.

### Vector length

From the ARP-10 MENU, Vector Length can be set to 30 seconds, 1, 3, 6, 15 or 30 minutes and the selected vector time is indicated on the screen.

The vector tip shows an estimated position of the target after the selected vector time elapses. It can be valuable to extend the vector length to evaluate the risk of collision with any target.

## 6.6 Past Position Display

The Auto Plotter displays equally time-spaced dots (maximum five dots) marking the past positions of any targets being tracked.

If a target changes its speed, the spacing will be uneven. If it changes course, its plotted course will not be a straight line in TM mode.

To turn past position display on or off do the following:

1. Open the ARP-10 menu.
2. Select History.
3. Select plot interval among 15, 30 seconds, 1, 2, 3 or 6 minutes. Select OFF to erase the past position display.
4. Press the [ACQ/ENTER] key.
5. Press the [MENU] key.

## 6.7 Operational Warnings

There are two main situations which cause the ARP-10 to trigger visual and audible alarms:

- CPA/TCPA alarm
- Lost target alarm

### CPA/TCPA alarm

#### **CAUTION**

The CPA/TCPA alarm feature should never be relied upon as a sole means for detecting the risk of collision.

The navigator is not relieved of the responsibility to keep visual lookout for avoiding collisions, whether or not the radar or other plotting aid is in use.

Visual and audible alarm are generated when the predicted CPA and TCPA of any target become less than their preset limits. The audible alarm continues for 10 seconds.

The ARP-10 continuously monitors the predicted range at the Closest Point of Approach (CPA) and predicted time to CPA (TCPA) of each tracked target to own ship.

When the predicted CPA of any target becomes smaller than a preset CPA alarm range and its predicted TCPA less than a preset TCPA alarm limit, the ARP-10 releases an audible alarm. In addition, the target plot symbol changes to a triangle and flashes together with its vector. The flashing of the triangle plot symbol and vector remain on the screen until the dangerous situation is no longer present or you intentionally terminate tracking of the target by using the [SELECT/CANCEL] key.

Provided that this feature is used correctly, it will help prevent the risk of collision by alerting you to threatening targets. It is important that GAIN, A/C SEA, A/C RAIN and other radar controls are properly adjusted and the Auto Plotter is set up so that it can track targets effectively.

CPA/TCPA alarm ranges must be set up properly taking into consideration the size, tonnage, speed, turning performance and other characteristics of own ship.

Follow the steps shown below to set the CPA/TCPA alarm ranges:

1. Open the "ARP-10 MENU."
2. On the "CPA Set" line, select a CPA limit desired. (Off, 0.5, 1, 2, 3, 5, 6 nm)
3. Press the [ACQ/ENTER] key.
4. On the "TCPA Set" line, select a TCPA limit desired. (30s, 1, 2, 3, 4, 5, 6, 12M)
5. Press the [ACQ/ENTER] key.
6. Press the [MENU] key to close the menu.

### **Lost target alarm**

When the system detects a loss of a tracked target, the target symbol becomes a flashing diamond.



# SPECIFICATIONS OF MARINE RADAR MODEL 1932/1942 MARK-2

## 1. GENERAL

- (1) Indication System                      PPI Daylight display, raster scan, 8 tones in monochrome  
 (2) Range, Pulselength (PL) & Pulse Repetition Rate (PRR)

		Range (nautical miles)																		
PL	PRR	0.125	0.25	0.5	0.75	1	1.5	2	3	4	6	8	12	16	24	36	48	64		
SP	2100 Hz	0.08 $\mu$ s																		
MP	1200 Hz					0.3 $\mu$ s														
LP	600 Hz*								0.8 $\mu$ s											

\*550 Hz on 48 nm range or more

Maximum Range;                              MODEL 1932 M2: 48 nm, MODEL 1942 M2: 64 nm

- (3) Range Resolution                        20 m  
 (4) Bearing Discrimination                1.9°  
 (5) Minimum Range                         25 m (0.25 NM range)  
 (6) Bearing Accuracy                        Within 1°  
 (7) Bearing Resolution                      4°  
 (8) Range Ring Accuracy                  0.9 % of range or 8 m, whichever is the greater

## 2. SCANNER UNIT

- (1) Radiator                                    Slotted waveguide array  
 (2) Polarization                                Horizontal  
 (3) Antenna Rotation Speed                24 rpm or 48 rpm nominal  
 (4) Radiator Length                         M1932M2: 100 cm (XN10A), M1942M2: 120 cm (XN12A)  
 (5) Horizontal Beamwidth                 M1932M2: 2.4°, M1942M2: 1.9°  
 (6) Vertical Beamwidth                     M1932M2: 27°, M1942M2: 22°  
 (7) Sidelobe Attenuation                  Within  $\pm 20^\circ$  of main-lobe: less than -24 dB  
     Outside  $\pm 20^\circ$  of main-lobe: less than -30 dB

## 3. TRANSCEIVER MODULE

- (1) Frequency                                 9410 MHz  $\pm 30$  MHz (X band)  
 (2) Modulation                                P0N  
 (3) Peak Output Power                    M1932M2: 4 kW nominal, M1942M2: 6 kW nominal  
 (4) Modulator                                 FET Switching Method  
 (5) Intermediate Frequency                60 MHz  
 (6) Tuning                                      Automatic or manual  
 (7) Receiver Front End                      MIC (Microwave IC)

- (8) Bandwidth Tx pulselength 0.08  $\mu$ s and 0.3  $\mu$ s: 25 MHz  
Tx pulselength 0.8  $\mu$ s: 3 MHz
- (9) Duplexer Circulator with diode limiter

#### 4. DISPLAY UNIT

- (1) Indication System PPI Daylight display, raster scan, 8 tones in monochrome
- (2) Picture Tube 10 inch rectangular monochrome CRT  
effective display area more than 150 mm

(3) Range, Range Interval, Number of Rings

Range (NM)	0.125	0.25	0.5	0.75	1	1.5	2	3	4	6	8	12	16	24	36	48	64
Ring Interval (NM)	0.0625	0.125	0.125	0.25	0.25	0.5	0.5	1	1	2	2	3	4	6	12	12	16
Number of Rings	2	2	4	3	4	3	4	3	4	3	4	4	4	4	3	4	4

Maximum Range; MODEL 1932 M2: 48 nm, MODEL 1942 M2: 64 nm

- (4) Markers Heading Line, Bearing Scale, Range Rings,  
Variable Range Marker (VRM1, VRM2),  
Electronic Bearing Line (EBL1, EBL2),  
Tuning Bar, Cursor, Parallel Cursor,  
Alarm Zone, Waypoint Mark (navigation input required),  
North Mark (heading sensor input required)
- (5) Alphanumeric Indications Range, Range Ring Interval, Pulselength (SP, MP, LP),  
Display Mode (HU,CU,NU,TM),  
Interference Rejection (IR1,IR2,IR3),  
VRM (1, 2), EBL (1, 2), Automatic A/C SEA (A/C AUTO),  
Stand-by (ST-BY), Radar Alarm (G(IN), G(OUT), G(ACKN)),  
Echo Stretch (ES1, ES2), Cursor Range, Bearing or L/L Position,  
Echo Tailing (TRAIL), Trailing Time, Trailing Elapsed Time,  
Navigation Data (navigation input required),  
Heading (HDC, heading sensor input required)
- (6) Input Data NMEA0183 (Ver.1.5/2.0), current loop
- Own ship's position: GGA>RMC>RMA>GLL (accept GLL in NMEA Version 1.5 only)
- Speed: RMC>RMA>VTG>VHW
- Heading (True): HDT>HDG<sup>\*1</sup>>HDM<sup>\*1</sup>>VHW>VHW<sup>\*1</sup>
- Heading (Magnetic): HDM>HDG<sup>\*1</sup>>HDT<sup>\*1</sup>>VHW>VHW<sup>\*1</sup>
- Course (True): RMC>RMA>VTG
- Course (Magnetic): VTG>RMC>RMA
- Waypoint (Range, Bearing): RMB>BWC>BWR
- Loran time difference: RMA>GLC>GTD
- Water depth: DPT>DBT>DBK>DBS

Water temperature: MTW>MDA  
 Time: ZDA  
 Cross track error: RMB>XTE>APB  
 \*1: calculate by magnetic drift.

(7) Output Data NMEA0183 (Version1.5/2.0), RS-422  
 TLL (target data) and RSD

## 5. ENVIRONMENTAL CONDITION

(1) Ambient Temperature Scanner Unit: -25°C to +70°C  
 Display Unit: -15°C to +55°C  
 (2) Relative Humidity 95 % or less at +40°C  
 (3) Waterproofing Scanner Unit: IPX6  
 Display Unit: IPX4

## 6. POWER SUPPLY & POWER CONSUMPTION

(1) Power Supply 12/24/32 VDC (10.8 to 41.6 VDC)  
 (2) Voltage and Current 24rpm: 12 VDC/7.5A, 24VDC/3.8A, 32VDC/2.8A  
 48rpm: 12 VDC/8.8A, 24VDC/4.4A, 32VDC/3.3A  
 (3) Power Consumption 24rpm: 70 W to 90 W (100 kt)  
 48rpm: 85 W to 105 W (70 kt)

## 7. DIMENSIONS AND MASS

See the Outline Drawings

## 8. COATING COLOR

(1) Display Unit Panel: N3.0  
 Chassis: 2.5GY5/1.5  
 (2) Scanner Unit N9.5

## 9. COMPASS SAFE DISTANCE

(1) M1932M2  
 Display Unit Standard: 1.1 m Steering: 0.8 m  
 Scanner Unit Standard: 1.0 m Steering: 0.8 m  
 (2) M1942M2  
 Display Unit Standard: 0.75 m Steering: 0.6 m  
 Scanner Unit Standard: 1.1 m Steering: 0.8 m

# Index

## A

Acquisition ..... 6-4  
A/C AUTO key ..... 2-4  
ACQ/ENTER key ..... 6-2  
A/C RAIN control ..... 2-4  
A/C SEA control ..... 2-3  
Auto plotter ..... 6-2

## B

Bearing measurement ..... 2-6  
Blind sectors ..... 4-4  
Brilliance ..... 2-3, 3-8  
BRILL key ..... 2-3

## C

Course Up ..... 3-1  
CPA/TCPA alarm ..... 6-6

## D

Dead sector ..... 3-8

## E

EBL ..... 2-6  
Echo stretch ..... 3-2  
Echo trail ..... 3-2  
Economy mode ..... 2-2

## F

Function controls (F1, F2) ..... 3-8  
Fuse ..... 5-1

## G

Gain control ..... 2-3  
Guard alarm ..... 3-4  
Guard alarm sensitivity ..... 3-5  
Guard key ..... 3-4, 3-5  
Guard zone ..... 3-4

## H

Head up ..... 3-1  
Heading marker ..... 2-5

## I

Indirect echoes ..... 4-1  
Interference ..... 3-3

## L

Lost target alarm ..... 6-7

## M

Magnetron ..... 5-3  
Maintenance ..... 5-1  
Multiple Echoes ..... 4-1  
Menu tree ..... v

## N

Navigation data ..... 2-2, 3-6  
Noise ..... 3-8  
North marker ..... 2-5  
North up ..... 3-2

## O

OTHERS menu ..... 3-7  
Offcenter ..... 2-7  
Offset EBL ..... 2-6

## P

POWER key ..... 2-2  
Presentation mode ..... 3-1  
Power on/off ..... 2-2  
Program No. .... 5-3  
Pulsewidth ..... 2-3, 3-4  
Pulselength ..... 2-3

## R

Range key ..... 2-3  
Range measurement ..... 2-5  
Range rings ..... 2-5

## S

SART ..... 4-2  
SELECT/CHANCEL key ..... 6-2  
Self Test (keyboard, RAM, ROM) ..... 5-3  
Sensitivity ..... 2-3  
Shadow Sectors ..... 4-2  
Side-lobe Echoes ..... 4-1  
Stand-by ..... 2-2  
ST BY/TX key ..... 2-2  
System configuration ..... vii

## T

TLL key ..... 3-8  
Trail tone ..... 3-3  
Trail time ..... 3-3  
Transmitting ..... 2-2  
Troubleshooting ..... 5-3

## V

Vector length ..... 6-6  
Vector mode ..... 6-6  
VRM ..... 2-5

## W

Watchman ..... 3-5

## Z

Zoom ..... 2-8

**FURUNO****FURUNO ELECTRIC CO., LTD.**

9-52 Ashihara-Cho, Nishinomiya City, 662-8580, Hyogo, Japan

Tel: +81 798-65-2111 Fax: +81 798-65-4200

Pub NO. DOC-290

**Declaration of Conformity**We **FURUNO ELECTRIC CO., LTD.**-----  
(Manufacturer)

9-52 Ashihara-Cho, Nishinomiya City, 662-8580, Hyogo, Japan

-----  
(Address)

declare under our sole responsibility that the product

**Marine radar Model 1932 MARK-2 for recreational crafts  
(Serial No. 3380-0001)**-----  
(Model name, serial number)

is in conformity with the essential requirements as described in the Directive 1999/5/EC of the European Parliament and of the Council of 9 March 1999 on radio equipment and telecommunications terminal equipment (R&amp;TTE Directive) and satisfies all the technical regulations applicable to the product within this Directive

**EN 60945: 1997-01 (IEC 945 Third edition: 1996-11)  
KSR 142, Annex 1**-----  
(title and/or number and date of issue of the standard(s) or other normative document(s))

For assessment, see

- Statement of Opinion N° 00214120/AA/00 of 11 December 2000 issued by KTL Certification, The Netherlands
- Test report KTL 98323220 of 8 October 1998 and KTL 98323222 of 1 October 1998

On behalf of Furuno Electric Co., Ltd.

**Hiroaki Komatsu  
Manager,  
International Rules and Regulations****Nishinomiya City, Japan  
December 28, 2000**-----  
(Place and date of issue)-----  
(name and signature or equivalent marking of authorized person)

**FURUNO****FURUNO ELECTRIC CO., LTD.**

9-52 Ashihara-Cho, Nishinomiya City, 662-8580, Hyogo, Japan

Tel: +81 798-65-2111 Fax: +81 798-65-4200

Pub NO. DOC-291

**Declaration of Conformity**  **0560**We **FURUNO ELECTRIC CO., LTD.**-----  
(Manufacturer)

9-52 Ashihara-Cho, Nishinomiya City, 662-8580, Hyogo, Japan

-----  
(Address)

declare under our sole responsibility that the product

**Marine radar Model 1942 MARK-2 for recreational crafts  
(Serial No. 3380-0001)**-----  
(Model name, serial number)

is in conformity with the essential requirements as described in the Directive 1999/5/EC of the European Parliament and of the Council of 9 March 1999 on radio equipment and telecommunications terminal equipment (R&amp;TTE Directive) and satisfies all the technical regulations applicable to the product within this Directive

**EN 60945: 1997-01 (IEC 945 Third edition: 1996-11)  
KSR 142, Annex 1**-----  
(title and/or number and date of issue of the standard(s) or other normative document(s))

For assessment, see

- Statement of Opinion N° 00214120/AA/00 of 12 December 2000 issued by KTL Certification, The Netherlands
- Test report KTL 98323221 of 1 October 1998

On behalf of Furuno Electric Co., Ltd.

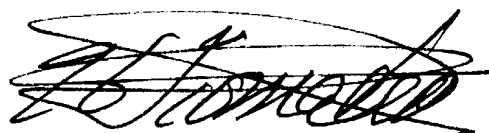
**Hiroaki Komatsu  
Manager,  
International Rules and Regulations****Nishinomiya City, Japan  
December 28, 2000**-----  
(Place and date of issue)-----  
(name and signature or equivalent marking of  
authorized person)