

Statement:

This manual is the intellectual property of Foxconn, Inc. Although the information in this manual may be changed or modified at any time, Foxconn does not obligate itself to inform the user of these changes.

Trademark:



All trademarks are the property of their respective owners.

Version:

User's Manual V1.1 for N570SM2AA motherboard.

P/N: 91-181N57M21E-00-G

Symbol description:

-  **Note:** refers to important information that can help you to use motherboard better.
-  **Attention:** indicates that it may damage hardware or cause data loss, and tells you how to avoid such problems.
-  **Warning:** means that a potential risk of property damage or physical injury exists.

More information:

If you want more information about our products, please visit Foxconn's website: <http://www.foxconnchannel.com>

This product and its accessories are produced after 13th Aug., 2005 and comply with the WEEE2002/96EC directive.

Declaration of conformity



HON HAI PRECISION INDUSTRY COMPANY LTD
66 , CHUNG SHAN RD., TU-CHENG INDUSTRIAL DISTRICT,
TAIPEI HSIEN, TAIWAN, R.O.C.

declares that the product

Motherboard
N570SM2AA

is in conformity with

(reference to the specification under which conformity is declared in
accordance with 89/336 EEC-EMC Directive)

- EN 55022: 1998/A2: 2003 Limits and methods of measurements of radio disturbance characteristics of information technology equipment
- EN 61000-3-2:2000 Electromagnetic compatibility (EMC)
Part 3: Limits
Section 2: Limits for harmonic current emissions
(equipment input current \leq 16A per phase)
- EN 61000-3-3/A1:2001 Electromagnetic compatibility (EMC)
Part 3: Limits
Section 2: Limits of voltage fluctuations and flicker in low-voltage supply systems for equipment with rated current \leq 16A
- EN 55024/A2:2003 Information technology equipment-Immunity characteristics limits and methods of measurement

Signature :

Place / Date : TAIPEI/2006

Printed Name : James Liang

Position/ Title : Assistant President

Declaration of conformity



Trade Name: WinFast
Model Name: **N570SM2AA**
Responsible Party: PCE Industry Inc.
Address: 458 E. Lambert Rd.
Fullerton, CA 92835
Telephone: 714-738-8868
Facsimile: 714-738-8838

Equipment Classification: FCC Class B Subassembly
Type of Product: Motherboard
**Manufacturer: HON HAI PRECISION INDUSTRY
COMPANY LTD**
Address: 66 , CHUNG SHAN RD., TU-CHENG
INDUSTRIAL DISTRICT, TAIPEI HSIEN,
TAIWAN, R.O.C.

Supplementary Information:

This device complies with Part 15 of the FCC Rules. Operation is subject to the following two conditions : (1) this device may not cause harmful interference, and (2) this device must accept any interference received, including interference that may cause undesired operation.

Tested to comply with FCC standards.

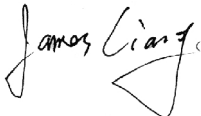
Signature : 

Date : 2006

Table of Contents

Chapter 1 Product Introduction

Main Features	2
Layout	4
Rear Panel Ports	5

Chapter 2 Installation Instructions

CPU	8
Memory	11
Power Supply	13
Other Connectors	14
Expansion Slots	18
Jumpers	19

Chapter 3 BIOS Description

Enter BIOS Setup	21
Main menu	21
Standard CMOS Features	23
Tiger Central Control Unit	25
Advanced BIOS Features	28
Advanced Chipset Features	31
Integrated Peripherals	32
Power Management Setup	37
PnP/PCI Configurations	40
PC Health Status	41
Load Fail-Safe Defaults	42
Load Optimized Defaults	42
Set Supervisor/User Password	42
Save & Exit Setup	43
Exit Without Saving	43



Table of Contents

Chapter 4 Driver CD Introduction



Utility CD content	45
Installing drivers	46
Installing Utilities	46

Chapter 5 Directions for Bundled Software

TIGER ONE	48
Fox LiveUpdate	55

Appendix

NVIDIA SLI™ Technology	62
NVIDIA RAID	65
Audio Configuration	77



i Attention:

1. Attach the CPU and heatsink using silica gel to ensure full contact.
2. It is suggested to select high-quality, certified fans in order to avoid damage to the motherboard and CPU due high temperatures.
3. Never turn on the machine if the CPU fan is not properly installed.
4. Ensure that the DC power supply is turned off before inserting or removing expansion cards or other peripherals, especially when you insert or remove a memory module. Failure to switch off the DC power supply may result in serious damage to your system or memory module.

i Attention:

We cannot guarantee that your system will operate normally while over-clocked. Normal operation depends on the over-clock capacity of your device.

i Attention:

Since BIOS programs are upgraded from time to time, the BIOS description in this manual is just for reference. We do not guarantee that the content of this manual will remain consistent with the actual BIOS version at any given time in the future.

i Attention:

The pictures of objects used in this manual are just for your reference. Please refer to the physical motherboard.

This manual is suitable for motherboard of N570SM2AA. Each motherboard is carefully designed for the PC user who wants diverse features.

- L with onboard 10/100M LAN (Default is omitted.)
- K with onboard Gigabit LAN
- 6 with 6-Channel audio (Default is omitted.)
- 8 with 8-Channel audio
- E with 1394 function
- S with SATA function
- 2 with DDR2 function
- R with RAID function
- H comply with RoHS directives

You can find PPID label on the motherboard. It indicates the functions that the motherboard has.

For example:



The letters On the black mark of the PPID label mean that the motherboard supports 6-Channel Audio (-6)(default), onboard 10/100M LAN (-L)(default), 1394 port (-E), SATA function (-S).

Chapter 1

Thank you for buying WinFast N570SM2AA series motherboard. This series of motherboard is one of our new products, offers superior performance, and uses the advanced NVIDIA nForce® 570 SLI MCP.

This chapter includes the following information:

- ❖ Main Features
- ❖ Layout
- ❖ Rear I/O Ports

Main Features

Size

- ATX form factor of 12 inch x 9.6 inch

Microprocessor

- Supports AMD® Socket AM2 Athlon™ 64 X2 Dual-Core, Athlon™ 64 FX, Athlon™ 64 and Sempron™ processor
- Supports HyperTransport up to 2000MT/s

MCP

- NVIDIA nForce® 570 SLI MCP

System Memory

- Four 240-pin DIMM slots
- Supports Dual-Channel DDR2 533/667/800
- Supports up to 8GB DDR2 memory

USB 2.0 Ports

- Supports hot plug
- Ten USB 2.0 ports (four rear panel ports, three onboard USB headers providing six extra ports)
- Supports wake-up from S1 and S3 mode
- Supports USB 2.0 protocol up to 480Mbps transmission rate

Onboard Serial ATA II

- 300MBps data transfer rate
- Seven Serial ATA II and one E-SATA1 connectors
- NVIDIA MediaShield™ RAID with support for RAID 0, RAID 1, RAID 0+1, RAID 5

Dual Onboard LAN (-K)

- Two LAN interface built-in onboard
- Supports 10/100/1000 Mbit/sec Ethernet

Chapter 1 Product Introduction

Onboard 1394 (-E) (optional)

- Supports hot plug
- Two 1394a ports with rate of transmission at 400 Mbps

Onboard Audio (-8)

- Supports 8-channel audio
- Supports S/PDIF output
- Supports Jack-Sensing function

Dual PCI Express x16

- Slot PCI-E1_X16 supports PCI Express X16
 - Supports 4 GB/sec bandwidth
- Slot PCI-E2_X16 supports PCI Express X8
 - Supports 2 GB/sec bandwidth
- Low power consumption and power management features

Green Function

- Supports ACPI (Advanced Configuration and Power Interface)
- Supports S0 (normal), S1 (power on suspend), S3 (suspend to RAM), S4 (Suspend to disk - depends on OS), and S5 (soft - off)
- Supports AMD® Cool 'n' Quiet™ technology

Expansion Slots

- Two PCI slots
- Two PCI Express x1 slot
- Two PCI Express x16 Graphics slots

Layout

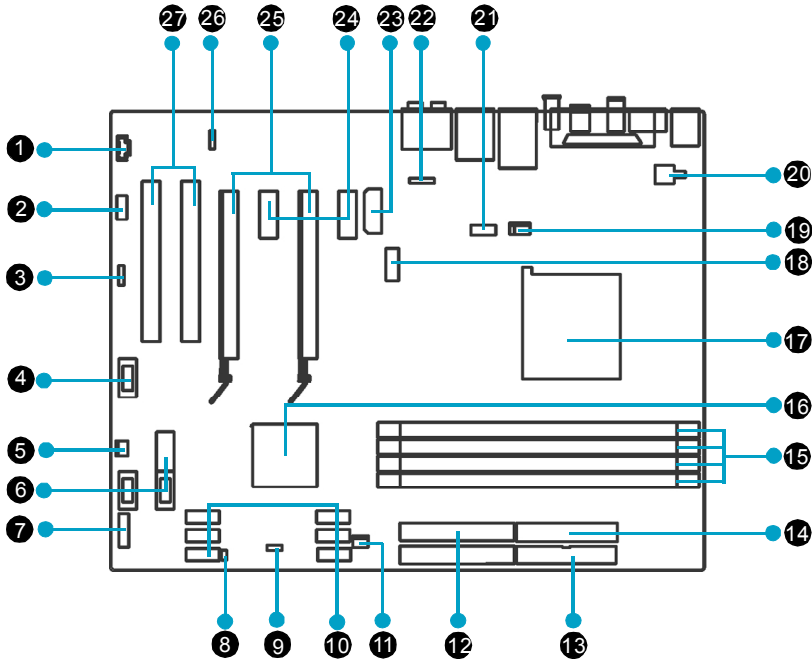

- | | |
|------------------------------------|-----------------------------------|
| 1. CD_IN Connector | 15. DDR2 DIMM Slots |
| 2. Front Audio Connector | 16. nForce® 570 SLI MCP |
| 3. Speaker Connector | 17. Socket AM2 |
| 4. Front 1394 Connector (optional) | 18. Serial ATA II Connector |
| 5. SYS_FAN Connector | 19. CPU FAN Connector |
| 6. Front USB Connectors | 20. 4-pin ATX_12V Power Connector |
| 7. Front Panel Connector | 21. COM1 Connector |
| 8. Chassis Intruder Connector | 22. IrDA Header |
| 9. Clear CMOS Jumper | 23. PWR3 Connector |
| 10. Serial ATA II Connectors | 24. PCI Express X1 Slots |
| 11. FAN Connector | 25. PCI Express X 16 Slots |
| 12. ATA 133/100/66 IDE Connectors | 26. SPDIF_OUT Connector |
| 13. FDD Connector | 27. PCI Connectors |
| 14. 24-pin ATX Power Connector | |



Note: The above motherboard layout is provided for reference only, please refer to the physical motherboard.

Rear I/O Ports

This motherboard provides the ports as below:

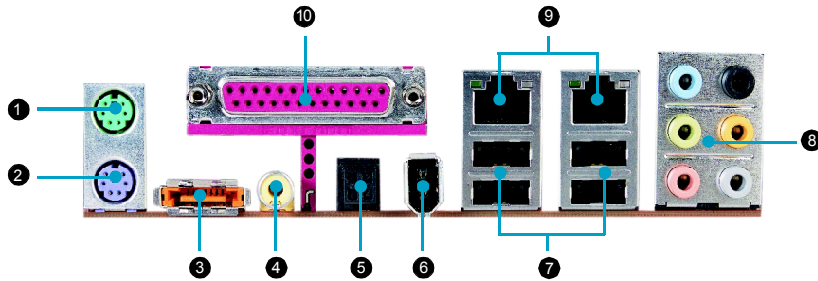

1. PS/2 Mouse Port

This port is used to connect a PS/2 mouse.

2. PS/2 Keyboard Port

This port is used to connect a PS/2 keyboard.

3. External SATA Port

This port is used to connect an external SATA box or a Serial ATA port multiplier and enables smart setup and hot-plug function.

4. Coaxial S/PDIF Out Port

This port is used to connect an external audio output device via a coaxial S/P-DIF cable.

5. Optical S/PDIF Out Port

This port is used to connect an external audio output device via a optical S/P-DIF cable.

6. 1394a Port(optional)

This port is used to connect a 1394 device.

7. USB 2.0 Ports

The four ports are used to connect USB 2.0/1.1 devices.

Chapter 1 Product Introduction

8. Line in, Line out, Microphone, Rear, LEF/CEN, Side Jacks

Port	2-channel	4-channel	6-channel	8-channel
Blue	Line In	Line In	Line In	Line In
Green	Line Out	Front Speaker Out	Front Speaker Out	Front Speaker Out
Pink	Mic In	Mic In	Mic In	Mic In
Orange	-	-	Center/Subwoofer	Center/Subwoofer
Black	-	Rear Speaker Out	Rear Speaker Out	Rear Speaker Out
Grey	-	-	-	Side Speaker Out

9. LAN Ports

Left : Link/Active LED		Right: Speed LED	
Status	Description	Status	Description
Off	No Link	Off	10 Mbps Connection
Green	Linked	Green	100 Mbps Connection
Blinking	Data Activity	Orange	1 Gbps Connection

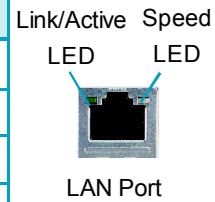

10. Parallel Port

The port is used to connect a parallel port device, such as a printer.

Chapter 2

This chapter introduces the hardware installation process, including the installation of the CPU, memory, power supply, slots, and pin headers, and the mounting of jumpers. Caution should be exercised during the installation of these modules. Please refer to the motherboard layout prior to any installation and read the contents in this chapter carefully.

This chapter includes the following information:

- ❖ CPU
- ❖ Memory
- ❖ Power supply
- ❖ Other Connectors
- ❖ Expansion Slots
- ❖ Jumpers

CPU

This motherboard supports AMD Socket AM2 Athlon™ 64 X2 Dual-Core, Athlon™ 64 FX, Athlon™ 64 and Sempron™ processor with Hyper-Transport Technology.

i Attention:

The CPU pins must be properly aligned with the holes in the socket, otherwise the CPU may be damaged.

For the detailed CPU vendor list qualified on this motherboard, please visit the website: <http://www.foxconnchannel.com>

Installation of CPU

Follow these steps to install the CPU.

1. Unlock the socket by pressing the lever sideways, then lift it up to a 90° angle.

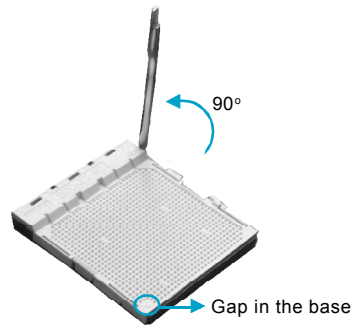

2. Align the cut edge to the gap in the base of the socket. Carefully insert the CPU into the socket until it fits in place.

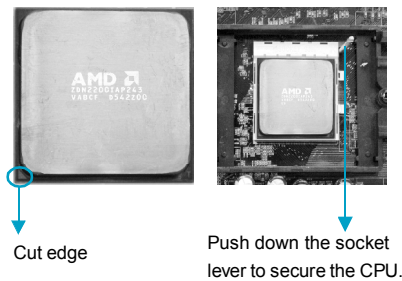

3. When the CPU is in place, press it firmly on the socket while you push down the socket lever to secure the CPU. The lever clicks on the side tab to indicate that it is locked.

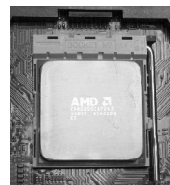

Installation of CPU Fan

New technology allows processors to run at higher and higher frequencies. To avoid problems arising from high-speed operation, for example, overheating, you need to install the proper fan. The following procedure is provided for reference only, please refer to your CPU fan user guide for the actual procedure.

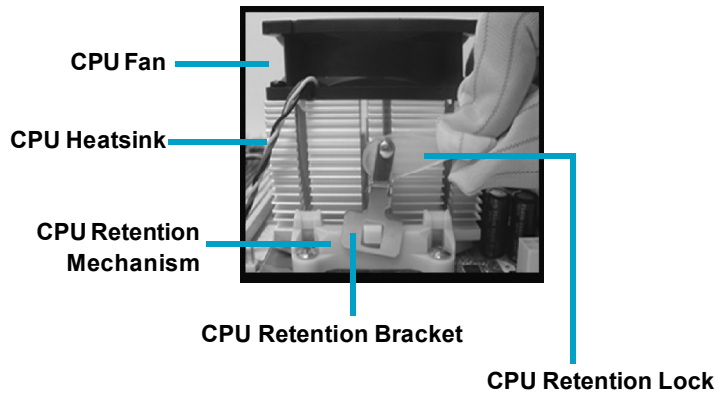

1. Locate the CPU retention mechanism base (surrounds the CPU socket).

2. If required, apply a light coating of silica gel to the top of the CPU.

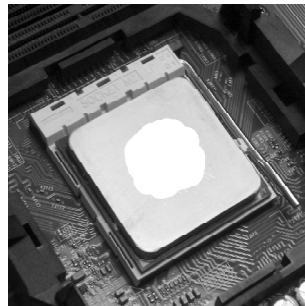

NOTE: The CPU heatsink may have a pre-applied thermal compound. In that case, the silica gel is not required.

Chapter 2 Installation Instructions

3. Place the cooling set onto the retention mechanism. Attach one end of the retention bracket to retention mechanism.

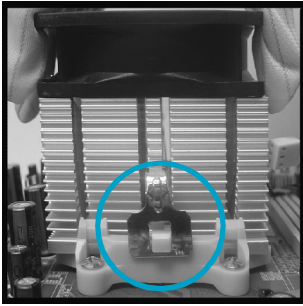

4. Align the other end of the retention bracket to fasten the cooling set on the top of the retention mechanism.

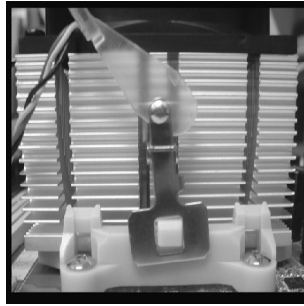

5. Push down the retention bracket lock on the retention mechanism to secure the heatsink and fan to module base.



6. Connect the fan's power cable to the appropriate 4-pin terminal on the motherboard.

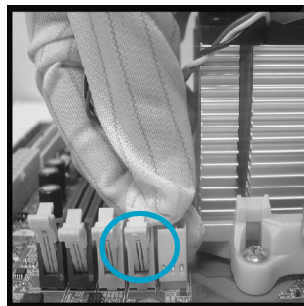

Memory

This motherboard includes four 240-pin slots with 1.8V for DDR2. These slots support 256 Mb, 512 Mb and 1 Gb DDR2 technologies for x8 and x16 devices, and support dual channel DDR2 memory technology up to 10.7GB/s. You must install at least one memory bank to ensure normal operation.

Recommended Memory Configurations

The following table list is the recommended memory configurations. Please install the memory according to the list.

Mode	DIMM1	DIMM2	DIMM3	DIMM4
Single Channel	Populated			
		Populated		
			Populated	
				Populated
	Populated		Populated	
		Populated		Populated
	Populated			Populated
Dual Channel	Populated	Populated		
			Populated	Populated
	Populated	Populated	Populated	Populated

Installation of DDR2 Memory

1. There is only one gap near the center of the DIMM slot, and the memory module can be fixed in one direction only. Unlock a DIMM slot by pressing the module clips outward.
2. Align the memory module to the DIMM slot, and insert the module vertically into the DIMM slot.

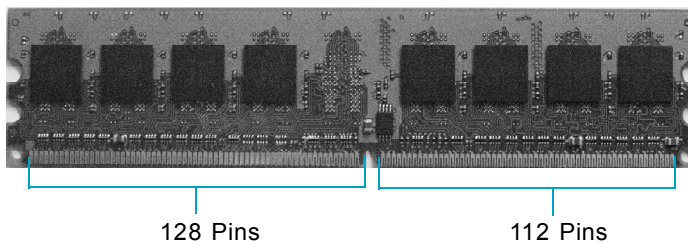

3. The plastic clips at both sides of the DIMM slot will lock automatically.

Chapter 2 Installation Instructions

Warning :

Be sure to unplug the AC power supply before adding or removing expansion cards or other system peripherals, especially the memory devices, otherwise your motherboard or the system memory might be seriously damaged.

For the detailed memory support list on this motherboard, please visit the website: <http://www.foxconnchannel.com>

Power Supply

This motherboard uses an ATX power supply. In order to avoid damaging any devices, make sure that they have been installed properly prior to connecting the power supply.

24-pin ATX power connector: PWR1

PWR1 is the ATX power supply connector. Make sure that the power supply cable and pins are properly aligned with the connector on the motherboard. Firmly plug the power supply cable into the connector and make sure it is secure.

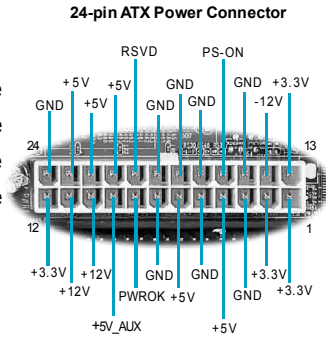

4-pin ATX_12 V Power Connector: PWR2

The 4-pin ATX 12V power supply connects to PWR2 and provides power to the CPU.

4-pin ATX_12 V Power Connector

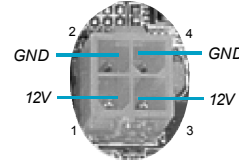

Exclusive Graphics Power Connector: PWR3

This connector is a auxiliary power for graphics card. Exclusive power for graphics card is for better graphics performance and for future upgrade usage.

Exclusive Graphics Power Connector

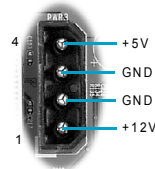

Other Connectors

This motherboard includes connectors for FDD device, IDE devices, Serial ATA devices, USB devices, and others.

FDD Connector: FLOPPY

This motherboard includes a standard FDD connector, supporting 360K, 720K, 1.2M, 1.44M, and 2.88M FDDs.

IDE Connector: PIDE , SIDE

The IDE connector supports Ultra ATA 133/100/66 IDE hard disk drives. Connect the cable's blue connector to the IDE connector, then connect the gray connector to the slave device (hard disk drive) and the black connector to the Ultra ATA master device. If you install two hard disks, you must configure the second drive as a slave device by setting its jumper accordingly. Refer to the hard disk documentation for the jumper settings.

Attention:

Ribbon cables are directional, therefore, make sure to always connect with the cable on the same side as pin 1 of the PIDE or FLOPPY connector on the motherboard.

Chapter 2 Installation Instructions

Front Panel Connector: FP1

This motherboard includes one connector for connecting the front panel switch and LED indicators.

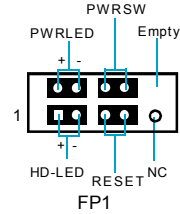

HDD LED Connector (HDD-LED)

The connector connects to the case's HDD indicator LED indicating the activity status of hard disks.

Reset Switch (RESET)

Attach the connector to the Reset switch on the front panel of the case; the system will restart when the switch is pressed.

Power LED Connector (PWRLLED)

Attach the connector to the power LED on the front panel of the case. The Power LED indicates the system's status. When the system is in S0 status, the LED is on. When the system is in S1, S3, S4, S5 status, the LED is off.

Power Switch Connector (PWRSW)

Attach the connector to the power button of the case. Pushing this switch allows the system to be turned on and off rather than using the power supply button.

Audio Connector: F_AUDIO_1

The audio connector supports HD audio standard. It provides two kinds of audio output choices: the Front Audio, the Rear Audio. Front Audio supports re-tasking function.

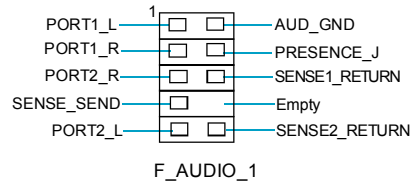

Serial ATA II Connectors: SATA_1, SATA_2, SATA_3, SATA_4, SATA_5, SATA_6, E_SATA2

The Serial ATA II connectors are used to connect the Serial ATA II devices to the motherboard. These connectors support the thin Serial ATA II cables for primary storage devices. The current Serial ATA II interface allows up to 300MB/s data transfer rate.

E_SATA2 Connector Supports RAID 0, RAID 1, RAID 0+1, JBOD Function. The other serial ATA II connectors support RAID 0, RAID 1, RAID 0+1, RAID 5 Function.

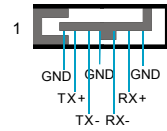

SATA II Connector

Fan Connectors: CPU_FAN, SYS_FAN, FAN

The fan speed can be detected and viewed in “PC Health Status” section of the CMOS Setup. These fans will be automatically turned off after the system enters S3, S4 and S5 mode.

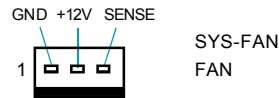

SYS-FAN FAN

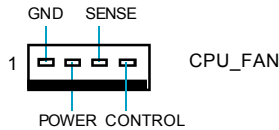

CPU_FAN

USB Headers: F_USB1, F_USB2, F_USB3

Besides four USB ports on the rear panel, the series of motherboards also have three 10-pin headers on board which may connect to front panel USB cable to provide additional six USB ports.

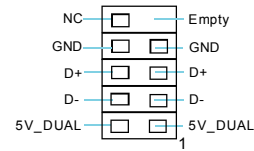

F_USB 1/2/3

Additional COM Connector: COM1

This motherboard provides an additional serial COM header for your machine.

Connect one side of a switching cable to the header, then attach the serial COM device to the other side of the cable.

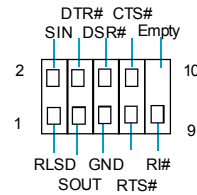

COM1

Chapter 2 Installation Instructions

IEEE 1394a Connector: F_1394_1 (optional)

The 1394 expansion cable can be connected to either the front (provided that the front panel of your chassis is equipped with the appropriate interface) or rear panel of the chassis.

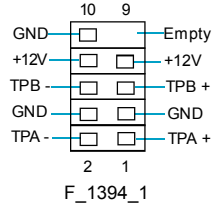

Speaker Connector: SPEAKER

The speaker connector is used to connect speaker of the chassis.

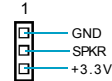

Audio Connectors: CD_IN

CD_IN is Sony standard CD audio connectors, it can be connected to a CD-ROM drive through a CD audio cable.

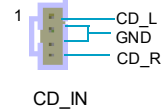

Chassis Intruder Connector: INTR

The connector connects to the chassis security switch on the case. The system can detect the chassis intrusion through the status of this connector. If the connector has been closed once, the system will send a message. To utilize this function, set "Case Open Warning" to "Enabled" in the "Power Management Setup" section of the CMOS Setup. Save and exit, then boot the operating system once to make sure this function takes effect.

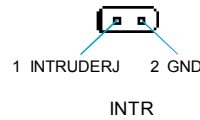

IrDA Connector: IR

This header supports wireless transmitting and receiving device. Before using this function, configure the settings of IR Mode from the "Integrated Peripherals" section of the CMOS Setup.

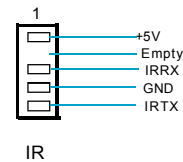

S/PDIF-OUT Connector: SPDIF_OUT

The SPDIF OUT Connector is capable of providing digital audio to external speakers or compressed AC3 data to an external Dolby digital decoder.

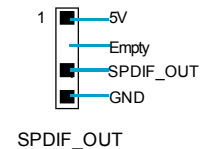

Expansion Slots

This motherboard includes two 32-bit master PCI bus slots, two PCI Express x 1 slots, and two PCI Express x 16 slots.

PCI Slots

The expansion cards can be installed in the two PCI slots. PCI slots support cards such as a LAN card, USB card, SCSI card and other cards that comply with PCI specifications.

PCI Express x1 Slots

This motherboard has Two PCI Express x1 slots that designed to accommodate less bandwidth-intensive cards, such as a modem or LAN card.

PCI Express x16 Slots

This motherboard has two PCI Express x16 slots that reserved for graphics or video cards. The difference in bandwidth between the x16 and x1 slots is notable to be sure. This motherboard design enables the support of dual PCI-Express graphics cards technology such as “SLI technology” and multiple display.







For the detailed PCI Express x16 graphics cards support list on this motherboard, please visit the website: <http://www.foxconnchannel.com>

Jumpers

The users can change the jumper settings on this motherboard if needed. This section explains how to use the various functions of this motherboard by changing the jumper settings. Users should read the following content carefully prior to modifying any jumper settings.

Description of Jumpers

- For the jumpers on this motherboard, pin 1 can be identified by the silk-screen printed “Δ” next to it. However, in this manual, pin 1 is simply labeled as “1”.
- The following table provides some explanation of the jumper pin settings. User should refer to this when adjusting jumper settings.

Jumper	Diagram	Definition	Description
		1-2	Set pin1 and pin2 closed
		2-3	Set pin2 and pin3 closed
		Closed	Set the pin closed
		Open	Set the pin opened

Clear CMOS Jumper: CLR_CMOS

The motherboard uses the CMOS RAM to store all the set parameters. The CMOS can be cleared by removing the CMOS jumper.

How to clear CMOS?

- Turn off the AC power supply and connect pins 1 and 2 together using the jumper cap.
- Return the jumper setting to normal (pins 2 and 3 together with the jumper cap).
- Turn the AC power supply back on.

NORMAL
(Default)



CLEAR



CLR_CMOS

Warning:

- Disconnect the power cable before adjusting the jumper settings.
- Do not clear the CMOS while the system is turned on.

Chapter 3

This chapter tells how to change system settings through the BIOS Setup menus. Detailed descriptions of the BIOS parameters are also provided.

You have to run the Setup Program when the following cases occur:

1. An error message appears on the screen during the system POST process.
2. You want to change the default CMOS settings.

This chapter includes the following information:

- ❖ Enter BIOS Setup
- ❖ Main Menu
- ❖ Standard CMOS Features
- ❖ Tiger Central Control Unit
- ❖ Advanced BIOS Features
- ❖ Advanced Chipset Features
- ❖ Integrated Peripherals
- ❖ Power Management Setup
- ❖ PnP/PCI Configurations
- ❖ PC Health Status
- ❖ Load Fail-Safe Defaults
- ❖ Load Optimized Defaults
- ❖ Set Supervisor/User Password
- ❖ Save & Exit Setup
- ❖ Exit Without Saving

Enter BIOS Setup

The BIOS is the communication bridge between hardware and software, correctly setting up the BIOS parameters is critical to maintain optimal system performance. Power on the computer, when the following message briefly appears at the bottom of the screen during the POST (Power On Self Test), press key to enter the Award BIOS CMOS Setup Utility.

Press TAB to show POST Screen, DEL to enter SETUP, ESC to enter Boot Menu.

 **Note:**

We do not suggest that you change the default parameters in the BIOS Setup, and we shall not be responsible for any damage that result from any changes that you make.

Main Menu

The main menu allows you to select from the list of setup functions and two exit choices. Use the arrow keys to select among the items and press <Enter> to accept or go to the sub-menu.

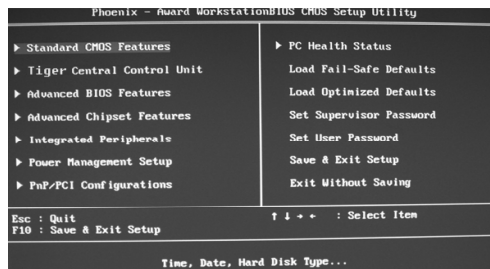

Main Menu

The items in the main menu are explained as below:

Standard CMOS Features

The basic system configuration can be set up through this menu.

Tiger Central Control Unit

The special features can be set up through this menu.

Advanced BIOS Features

The advanced system features can be set up through this menu.

Advanced Chipset Features

The values for the chipset can be changed through this menu, and the system performance can be optimized.

Integrated Peripherals

All onboard peripherals can be set up through this menu.

Power Management Setup

All the items of Green function features can be set up through this menu.

PnP/PCI Configurations

The system's PnP/PCI settings and parameters can be modified through this menu.

PC Health Status

This will display the current status of your PC.

Load Fail-Safe Defaults

The default BIOS settings can be loaded through this menu.

Load Optimized Defaults

The optimal performance settings can be loaded through this menu, however, the stable default values may be affected.

Set Supervisor Password

The supervisor password can be set up through this menu.

Set User Password

The user password can be set up through this menu.

Save & Exit Setup

Save CMOS value settings to CMOS and exit setup.

Exit Without Saving

Abandon all CMOS value changes and exit setup.

Standard CMOS Features

This sub-menu is used to set up the standard CMOS features, such as the date, time, HDD model and so on. Use the arrow keys select the item to set up, and then use the <PgUp> or <PgDn> keys to choose the setting values.

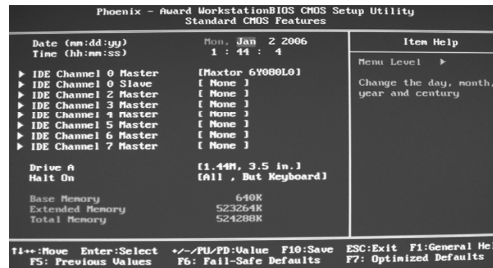

Standard CMOS Features Menu

Date

This option allows you to set the desired date (usually as the current day) with the <day><month><date><year> format.

Day—weekday from Sun. to Sat., defined by BIOS (read-only).

Month—month from Jan. to Dec..

Date—date from 1st to 31st, can be changed using the keyboard.

Year—year, set up by users.

Time

This option allows you to set up the desired time (usually as the current time) with <hour><minute><second> format.

IDE Channel 0 Master/Slave & IDE Channel 2/3/4/5/6/7 Master

While entering Setup, the BIOS automatically detects the presence of IDE devices. There is a separate sub-menu for each IDE device, select a device item then press <Enter> to display the IDE information. The values opposite the dimmed items (Capacity, Head, Sector, Cylinder, Precomp, Landing Zone) are not user-configurable. These values show "0" if no IDE device is installed in the system.

Drive A

This option allows you to select the kind of FDD to be installed, including "None", [360K, 5.25 in], [1.2M, 5.25 in], [720K, 3.5 in], [1.44M, 3.5 in] and [2.88 M, 3.5 in].

Halt On

This category determines whether or not the computer will stop if an error is detected during powering up.

All Errors	Whenever the BIOS detects a nonfatal error, the system will stop and you will be prompted.
No Errors	The system boot will not stop for any errors that may be detected.
All, But Keyboard	The system boot will not stop for a keyboard error; but it will stop for all other errors.
All, But Diskette	The system boot will not stop for a diskette error; but it will stop for all other errors.
All, But Disk/Key	The system boot will not stop for a keyboard or disk error, but it will stop for all other errors.

Memory

This is a Display-Only Category, determined by POST (Power On Self Test) of the BIOS.

Base Memory	The BIOS POST will determine the amount of base (or conventional) memory installed in the system.
Extended Memory	The BIOS determines how much extended memory is present during the POST.
Total Memory	Total memory of the system.

Tiger Central Control Unit

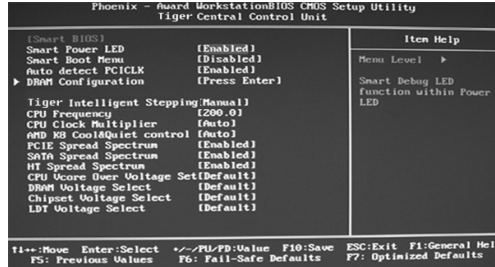

Tiger Central Control Unit Menu

❖ [Smart BIOS]

Smart Power LED

Smart debug LED function within power LED. Enable this function, the power LED status can show the system status of POST process.

System Status	Power LED Status
Normal	on
No CPU Fan	blinking once (blinking 0.5 sec., off 0.5 sec.)
No Display	blinking once (blinking 2 sec., off 2 sec.)
No Memory	blinking twice
Post Error Message	blinking thrice

Smart Boot Menu

Smart boot menu with a timer to let user to control boot device easily.

❖ Auto Detect PCI Clk

This option is used to set whether the clock of an unused PCI slot will be disabled to reduce electromagnetic interference. The setting values are Disabled and Enabled.

❖ DRAM Configuration

Press Enter to set the items of DRAM Configuration.

❖ PCIE clock

This option is used to set PCIE overclock function.

❖ **Tiger Intelligent Stepping**

User can select different overclocking option by this item. The available setting values are: Manual, Auto, Power gaming, Data Mining, Office, Energy Saving.

❖ **CPU Frequency**

This option is used to set CPU Frequency.

❖ **CPU Clock Multiplier**

This option is used to set CPU Clock Multiplier.

❖ **AMD K8 Cool& Quiet Control**

This option is used to control AMD K8 Cool&quiet Technology.

❖ **PCIE Spread Spectrum**

If you enable PCIE spread spectrum, it can significantly reduce the EMI (Electro-Magnetic Interference) generated by PCIE. The setting values are Disabled and Enabled.

❖ **SATA Spread Spectrum**

If you enable SATA spread spectrum, it can significantly reduce the EMI (Electro-Magnetic Interference) generated by SATA. The setting values are Disabled and Enabled.

❖ **HT Spread Spectrum**

If you enable HT spread spectrum, it can significantly reduce the EMI (Electro-Magnetic Interference) generated by HT. The setting values are Disabled and Enabled.

❖ **CPU Vcore Over Voltage Setting**

This option is used to set CPU Vcore over voltage.

❖ **DRAM Voltage Select**

This option is used to set the DRAM voltage.

❖ **Chipset Voltage Select**

This option is used to set the Chipset voltage.

❖ **LDT Voltage Select**

This option is used to set the LDT voltage.

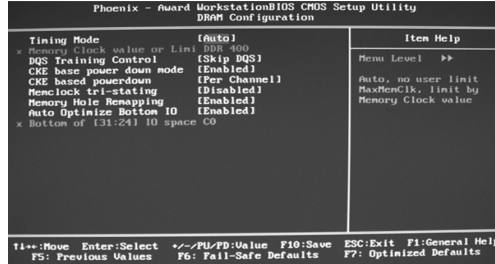

DRAM Configuration Menu

❖ Timing Mode

This option is used to set timing mode.

❖ DQS Training Control

This option controls the DQS training .

❖ CKE base Power down mode

This option is used to set the CKE base Power down mode.

❖ CKE based Powerdown

This option controls the CKE based power down.

❖ Memory hole Remapping

This option is used to enable or disable the memory hole remapping.

❖ Auto Optimize Bottom IO

This option is used to set the auto optimize bottom IO.

❖ Bottom of [31:24] IO space

This option is used to set Bottom of [31:24] IO space.

Advanced BIOS Features

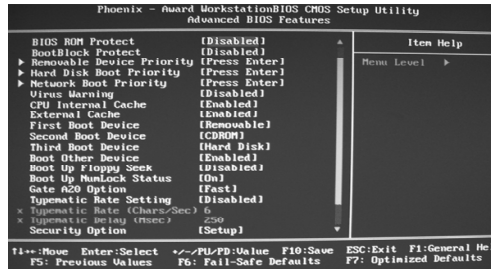

Advanced BIOS Features Menu

❖ BIOS ROM Protect

This option is used to enable or disable BIOS ROM Protect function.

❖ BootBlock Protect

This option is used to enable or disable BootBlock Protect function.

❖ Removable Device Priority

This option is used to remove the priority for removable device startup. After pressing <Enter>, you can remove the removable device using the <PageUp>/<PageDn> or Up/Down arrow keys, and change the removable device priority using <+> or <->. To exit this option, press <Esc>.

❖ Hard Disk Boot Priority

This option is used to select the priority for HDD startup. After pressing <Enter>, you can select the HDD using the <PageUp>/<PageDn> or Up/Down arrow keys, and change the HDD priority using <+> or <->. To exit this option, press <Esc>.

❖ CD-ROM Boot Priority

This option is used to select the priority for CD-ROM startup. After pressing <Enter>, you can select the CD-ROM using the <PageUp>/<PageDn> or Up/Down arrow keys, and change the CD-ROM priority using <+> or <->. To exit this option, press <Esc>.

❖ **Network Boot Priority**

This option is used to select the priority for network boot startup. After pressing <Enter>, you can select the network boot using the <PageUp>/<PageDn> or Up/Down arrow keys, and change the network boot priority using <+> or <->. To exit this option, press <Esc>.

❖ **Virus Warning**

This option is used to set up the virus warning message for the IDE HDD boot sector. When enabled, a warning message will appear on the screen if any program intends to write information to the boot sector.

Note: Such function provides protection to the startup sector only; it does not protect the entire hard disk.

❖ **CPU Internal Cache**

This option is used to turn on or off the CPU L1 and L2 cache.

❖ **External Cache**

This option is used to turn on or off the CPU external cache. The available setting values are: Disabled and Enabled. Leave this item at the default value for better performance.

❖ **First/Second/Third Boot Device**

This option allows you to set the boot device sequence. The available setting values are: Floppy, LS120, Hard Disk, CDROM, ZIP100, USB-FDD, USB-ZIP, USB-CDROM, Legacy LAN, NVIDIA Boot Age and Disabled.

❖ **Boot Other Device**

With this item enabled, the system will search all other possible locations if it fails to find one in the devices specified under the first, second and third boot devices.

❖ **Boot Up Floppy Seek**

If this option is enabled, BIOS will activate the floppy drive during the system boot and the drive's indicator will flash after the activation. The magnetic head will move back and forth from A to B.

❖ **Boot Up NumLock Status**

This option defines if the keyboard Num Lock key is active when your system is started.

❖ **Typematic Rate Setting**

If this option is enabled, you can use the following two items to see the typematic rate and the typematic delay settings for your keyboard.

❖ **Typematic Rate (Chars/Sec)**

Use this option to define how many characters per second a held-down key generated.

❖ **Typematic Delay (Msec)**

Use this option to define how many milliseconds must elapse before a held-down key begins generating repeat characters.

❖ **Security Option**

When it is set to “Setup”, a password is required to enter the CMOS Setup screen; When it is set to “System”, a password is required not only to enter CMOS Setup, but also to start up your PC.

❖ **APIC Mode**

This option is used to enable or disable APIC function.

❖ **Full Screen LOGO Show**

This option allows you to enable or disable the full screen logo. The available setting values are: Disabled and Enabled.

❖ **Small Logo (EPA) Show**

This option allows you to enable or disable the EPA logo. The available setting values are: Disabled and Enabled.

Advanced Chipset Features

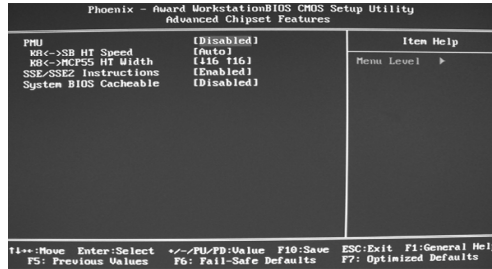

Advanced Chipset Features Menu

❖ PMU

This option is used to enable or disable PWU function.

❖ K8<->SB HT Speed

These options are used to set the bandspeed of the link's transmitter of K8 <->SB.

❖ K8<->MCP55 HT Width

These options are used to set the bandwidth of the link's transmitter of K8 <->MCP55.

❖ SSE/SSE2 Instructions

It is used to set enable or disable Intel SSE/SSE2 instructions.

❖ System BIOS Cacheable

Select "Enabled" to allow catching of the system BIOS which may improve performance. If any other program writes to this memory area, a system error may result.

Integrated Peripherals

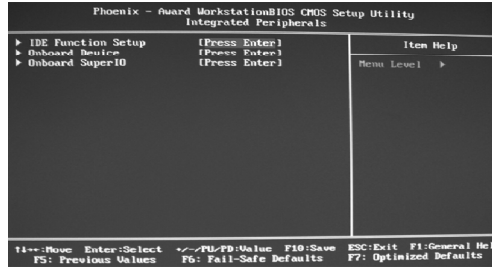

Integrated Peripherals Menu

❖ IDE Function Setup

Press enter to set IDE Function Setup.

❖ Onboard Device

Press enter to set Onboard Device.

❖ Onboard Super IO

Press enter to set Onboard Super IO.

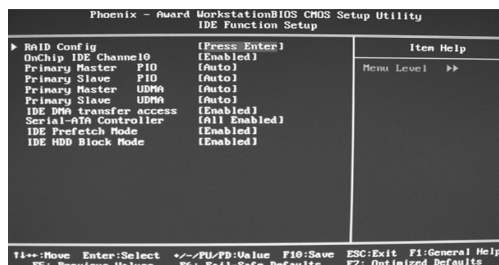

IDE Function Setup Menu

❖ RAID Config

Press <Enter> to set the items of RAID configuration function.

❖ OnChip IDE Channel 0

This option is used to set the onchip IDE channel 0. The available settings are: Disabled and Enabled.

❖ Primary Master/Slave PIO

These two items let you assign which kind of PIO (Programmer Input/Output) is used by IDE devices. Choose "Auto" to let the system auto detect which PIO mode is best, or select a PIO mode from 0-4.

❖ Primary Master/Slave UDMA

UDMA technology provides faster access to IDE devices. If you install a device that supports UDMA, change the appropriate items on this list to Auto. The available setting values are: Disabled and Auto.

❖ IDE DMA transfer access

This option is used to enable or disable IDE DMA transfer access.

❖ Serial-ATA Controller

This option is used to enable or disable Serial-ATA controller.

❖ IDE Prefetch Mode

This option is used to enable or disable IDE prefetch mode.

❖ IDE HDD Block Mode

This option is used to set whether the IDE HDD block mode is allowed.

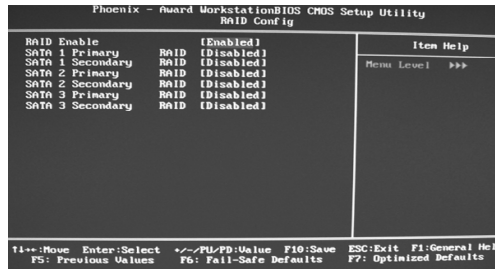

RAID Config Menu

❖ RAID Enable

This item is available for you to enable or disable the onboard RAID function.

❖ SATA 1/2/3 Primary/Secondary

These features allow user to enable or disable the RAID function for each SATA hard disk drive.

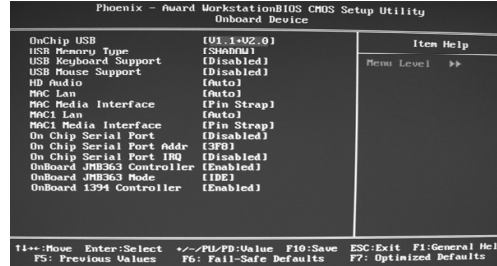

Onboard Device Menu

❖ Onchip USB

This option is used to set whether the USB Controller is enabled.

❖ USB Memory Type

This option is used to set the USB Memory type.

❖ USB Keyboard Support

This option is used to set whether the USB keyboard controller is enabled in a legacy operating system (such as DOS). The available setting values are: Disabled and Enabled.

❖ USB Mouse Support

This option is used to set whether the USB mouse controller is enabled in a legacy operating system (such as DOS). The available setting values are: Disabled and Enabled.

❖ HD Audio

This option is used to set whether onboard AC97 Audio is enabled. The available setting values are: Disabled and Auto.

❖ MAC / MAC1 LAN

This option is used to set whether MAC LAN device is enabled.

❖ MAC / MAC1 Media Interface

This option is used to set MAC Media Interface.

❖ MAC LAN Boot ROM

This option is used to decide whether to invoke the boot ROM of the MAC LAN chip.

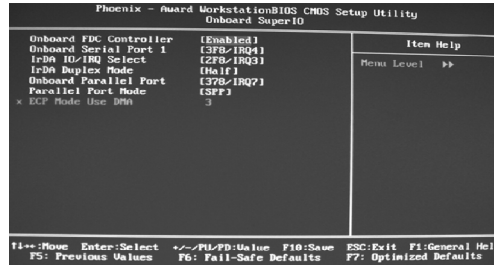

Onboard SuperIO Menu

❖ Onboard FDC Controller

This option is used to set whether the Onboard FDC Controller is enabled. The available setting values are: Disabled and Enabled.

❖ Onboard Serial Port 1

This option is used to assign the I/O address and interrupt request (IRQ) for the onboard serial port 1.

❖ IrDA IO/IRQ Select

Use this option to select the IO/IRQ mode. The setting value is determined by the infrared module installed on the board.

❖ IrDA Duplex Mode

This item enables you to determine the infrared function of the onboard infrared chip.

❖ Onboard Parallel Port

This option allows you to determine onboard parallel port controller I/O address and interrupt request (IRQ). The setting values are: Disabled, 378/IRQ7, 278/IRQ5 and 3BC/IRQ7.

❖ Parallel Port Mode

Select an address and corresponding interrupt for the onboard parallel port. The setting values are: SPP, EPP, ECP, ECP+EPP.

❖ ECP Mode Use DMA

When the Parallel Port Mode is set to ECP or ECP+ EPP, this option is used to select the channel for the ECP mode. The setting values are: 1 and 3.

Power Management Setup

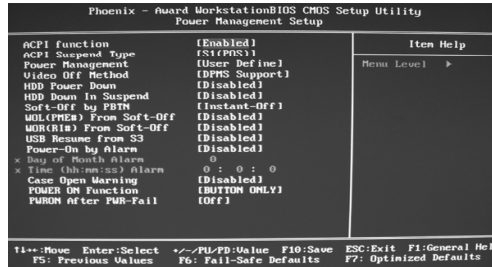

Power Management Setup Menu

❖ **ACPI function**

ACPI stands for “Advanced Configuration and Power Interface”. ACPI is a standard that defines power and configuration management interfaces between an operating system and the BIOS. In other words, it is a standard that describes how computer components work together to manage system hardware. In order to use this function the ACPI specification must be supported by the OS (for example, Windows2000 or WindowsXP). The available setting values are: Enabled and Disabled.

❖ **ACPI Suspend Type**

This option is used to set the energy saving mode of the ACPI function. When you select “S1 (POS)” mode, the power will not shut off and the supply status will remain as it is, in S1 mode the computer can be resumed at any time. When you select “S3 (STR)” mode, the power will be cut off after a delay period. The status of the computer before it enters STR will be saved in memory, and the computer can quickly return to previous status when the STR function wakes. When you select “S1 & S3” mode, the system will automatically select the delay time.

❖ **Power Management**

This option is used to set the power management scheme. Available settings are: User Define, Min Saving and Max Saving.

❖ Video Off Method

This option is used to define the video off method. “Blank Screen” mode means that after the computer enters power saving mode, only the monitor will close, however, the vertical and horizontal scanning movement of the screen continues. When you select the “V/H SYNC + Blank” mode the vertical and horizontal scanning movement of screen stops when the computer enters power saving mode. “DPMS Supported” mode is a new screen power management system, and it needs to be supported by the monitor you’re using.

❖ HDD Power Down

This option is used to turn off hard disk power if the hard disk is idle for a given period of time. The setting values are Disabled and 1Min-15Min.

❖ HDD Down In Suspend

This option is used to define the continuous HDD idle time before the HDD enters power saving mode. The setting values are Disabled and Enabled.

❖ Soft-Off by PBTN

This option is used to set the power down method. This function is only valid for systems using an ATX power supply. When “Instant-Off” is selected, press the power switch to immediately turn off power. When “Delay 4 Sec.” is selected, press and hold the power button for four seconds to turn off power.

❖ WOL(PME#) From Soft-Off

When set to Enable, the feature allows your system to be awakened from the power saving modes through any event on PME (Power Management Event)

❖ WOR(RI#) From Soft-Off

If this item is enabled, it allows the system to resume from a software power down or power saving mode whenever there is an incoming call to an installed fax/modem. This function needs to be supported by the relevant hardware and software.

❖ USB Resume From S3

This item is used to set the system to wake up by USB equipment when it is in S3 (Suspend to RAM) mode.

❖ Power-On by Alarm

This option is used to enable or disable the feature of booting up the system on a scheduled time/date. The setting values are Disabled and Enabled.

❖ Date of Month Alarm

When the Power-On by Alarm set as “Enabled”, this option will be modified. It is used to set the timing for the start-up date. The setting values contain 0 - 31.

❖ Time (hh: mm: ss) Alarm

When the Power-On by Alarm set as “Enabled”, this option will be modified. It is used to set the timing for the start-up date. The setting values contain hh: 0-23; mm: 0-59; ss: 0-59

❖ Case Open Warning

This option is used to enable or disable case open warning function.

❖ POWER ON Function

This option is used to set the power on method for your PC. Setting values include: Any KEY, Mouse Click, Both, BUTTON ONLY.

❖ PWRON After PWR-Fail

This item is used to set what action the PC will take with the power supply when it resumes after a sudden power failure. The available options are: Off (remain in turn off status), On (auto power on) and Former-Sts (resume with the previous status).

PnP/PCI Configurations

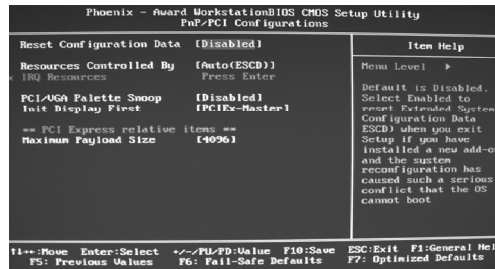

PnP/PCI Configurations Menu

❖ Reset Configuration Data

This option is used to set whether the system is permitted to automatically distribute IRQ DMA and I/O addresses when each time that the machine is turned on. The setting values are: Disabled and Enabled.

❖ Resources Controlled By

This option is used to define the system resource control scheme. If all cards you use support PnP, then select Auto (ESCD) and the BIOS will automatically distribute interruption resources. If the ISA cards you installed not supporting PnP, you will need to select “Manual” and manually adjust interruption resources in the event of hardware conflicts. However, since this motherboard has no ISA slot, this option does not apply.

❖ IRQ Resources

Press the <Enter> key, then manually set IRQ resources.

❖ PCI/VGA Palette Snoop

If you use a non-standard VGA card, use this option to solve graphic acceleration card or MPEG audio card problems (e.g., colors not accurately displayed). The setting values are: Disabled and Enabled.

❖ Init Display First

This option is used to set which display device will be used first when your PC starts up.

❖ Maximum Payload Size

This option is used to set maximum TLP payload size for PCI Express devices. The unit is byte.

PC Health Status

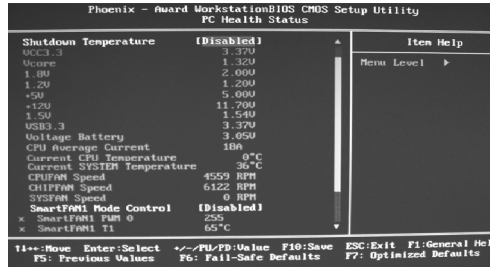

PC Health Status Menu

❖ Shutdown Temperature

This option is used to set the system temperature upper limit. When the temperature exceeds the setting value, the motherboard will automatically cut off power to the computer.

❖ VCC 3.3/Vcore/1.8V/1.5V/+5V/+12V/VSB3.3/Voltage Battery

The current voltages will be automatically detected by the system.

❖ Current CPU/System Temperature

The current system/CPU temperature will be automatically detected by the system.

❖ SYSTEM/CPU/FAN1 FAN

The system/CPU fan speed will be automatically detected by the system.

❖ Smart FAN1 Mode Control

This option is used to enable or disable smart fan function. “PWM Mode” can enable smart fan function.

❖ Smart FAN1 PWM 0

This option is used to set smart fan1 PWM 0.

❖ Smart FAN1 T 1

This option is used to set smart fan1 temperature 1 value.

❖ CPU Average Current

This option is used to set CPU current status.

Load Fail-Safe Defaults

Press <Enter> to select this option. A dialogue box will pop up that allows you to load the default BIOS settings. Select <Y> and then press <Enter> to load the defaults. Select <N> and press <Enter> to exit without loading. The defaults set by BIOS set the basic system functions in order to ensure system stability. But if your computer cannot POST properly, you should load the fail-safe defaults to restore the original settings. Then carry out failure testing. If you only want to load the defaults for a single option, you can select the desired option and press the <F6> key.

Load Optimized Defaults

Select this option and press <Enter>, and a dialogue box will pop up to let you load the optimized BIOS default settings. Select <Y> and then press <Enter> to load the optimized defaults. Select <N> and press <Enter> to exit without loading. The defaults set by BIOS are the optimized performance parameters for the system, to improve the performance of your system components. However, if the optimized performance parameters are not supported by your hardware devices, it will likely cause system reliability and stability issues. If you only want to load the optimized default for a single option, select the desired option and press the <F7> key.

Set Supervisor/User Password

The access rights and permissions associated with the Supervisor password are higher than those of a regular User password. The Supervisor password can be used to start the system or modify the CMOS settings. The User password can also start the system. While the User password can be used to view the current CMOS settings, these settings cannot be modified using the User password. When you select the Set Supervisor/User Password option, the following message will appear in the center of the screen, which will help you to set the password:

Enter Password:

Enter your password, not exceeding 8 characters, then press <Enter>. The password you enter will replace any previous password. When prompted, key in the new password and press <Enter>.

If you do not want to set a password, just press <Enter> when prompted to enter a password, and in the screen the following message will appear. If no password is keyed in, any user can enter the system and view/modify the CMOS settings.

Password Disabled!!!
Press any key to continue ...

Under the menu “Advanced BIOS Features”, if you select “System” from the Security Option, you will be prompted to enter a password once the system is started or whenever you want to enter the CMOS setting program. If the incorrect password is entered, you will not be permitted to continue.

Under the menu “Advanced BIOS Features”, if you select “Setup” from the Security Option, you will be prompted to enter a password only when you enter the CMOS setting program.

Save & Exit Setup

When you select this option and press <Enter>, the following message will appear in the center of the screen:

SAVE to CMOS and EXIT (Y/N)?Y

Press <Y> to save your changes in CMOS and exit the program; press <N> or <ESC> to return to the main menu.

Exit Without Saving

If you select this option and press <Enter>, the following message will appear in the center of the screen:

Quit Without Saving (Y/N)?N

Press <Y> to exit CMOS without saving your modifications; press <N> or <ESC> to return to the main menu.

Chapter 4

The utility CD that came with the motherboard contains useful software and several utility drivers that enhance the motherboard features.

This chapter includes the following information:

- ❖ Utility CD content
- ❖ Start to install drivers

Utility CD content

This motherboard comes with one Utility CD. To begin using the CD, simply insert the CD into your CD-ROM drive. The CD will automatically displays the main menu screen.



1. Driver

Using this choice, you can install all the drivers for your motherboard. You should install the drivers in order and you need to restart your computer after the drivers all installed.

- A. NVIDIA Chipset Driver
- B. Realtek HDA Audio Driver
- C. JMB RAID Driver

2. Utility

Use this option to install additional software programs.

- A. TIGER ONE
- B. Fox LiveUpdate
- C. Microsoft DirectX 9.0
- D. Adobe Acrobat Reader
- E. Create RAID Driver Floppy

3. Click on dynamic WinFast logo to visit our homepage.

Installing Drivers

There are two ways to install drivers, manual or auto. Click the drivers that you want to install and begin the setup steps by manual. Or you just click “One Click Setup” button to install the drivers by auto after install Intel Chipset Driver.

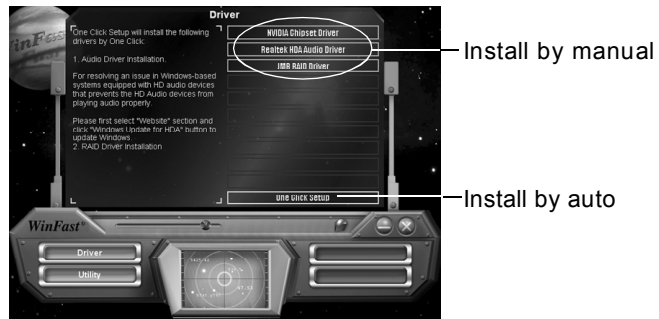

Installing Utilities

You can select the utilities that you want to install and begin the setup steps.

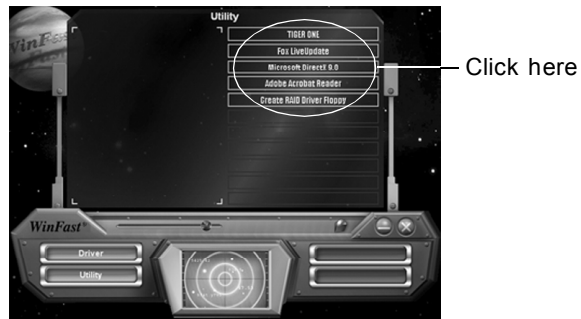

Chapter 5

This chapter will introduce how to use attached software.

This chapter provides the following information:

- ❖ TIGER ONE
- ❖ Fox LiveUpdate

TIGER ONE

TIGER ONE is a powerful utility for easily modifying system settings. It also allows users to monitor various temperature values, voltage values, frequency and fan speed at any time.

With TIGER ONE, you can

- Modify system performance settings, such as bus speeds, CPU voltages, fan speed, and other system performance options that are supported by the BIOS
- Monitor hardware temperature, voltage, frequency and fan speed

Supported Operating Systems:

- Windows 2000
- Windows XP (32-bit)

Using TIGER ONE:

1. Main Page

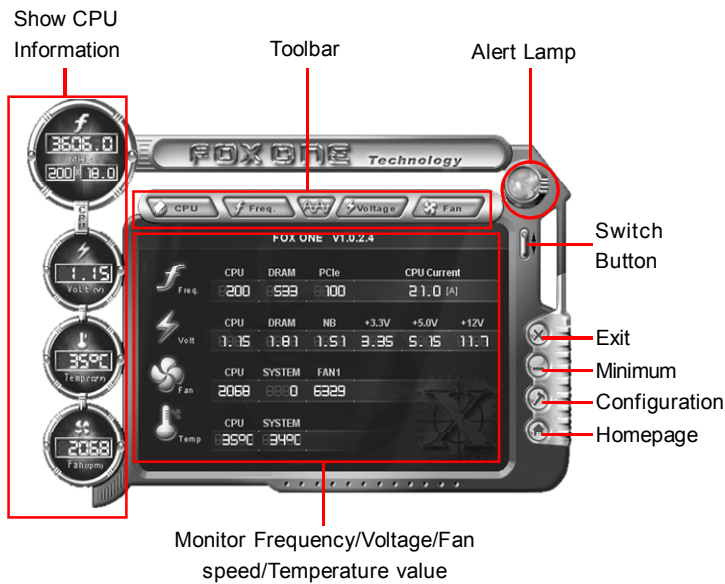

Chapter 5 Directions for Bundled Software

Toolbar

Use the toolbar to navigate to other pages.

Alert Lamp

When the system is in healthy status, the alert lamp color is green. When the system is in abnormal status, the alert lamp color is red.

Switch Button

Click this button, it will shorten to below figure. It helps you to monitor your system healthy status at any time.



Exit

Click this button to exit the program.

Minimum

Click this button to minimize the window.

Configuration

Click this button to configure the parameters for the program. It determines which items will be shown in shorten mode.

Homepage

Click this button to visit Foxconn motherboard website.

2. CPU Page - CPU Control

This page lets you select and run the TIGER ONE developed benchmarks to determine the current performance level of the system. You can also adjust by manual. Only this page is set to Manual Adjustment, the Freq., Voltage, and Fan pages can be adjusted by manual.

Chapter 5 Directions for Bundled Software

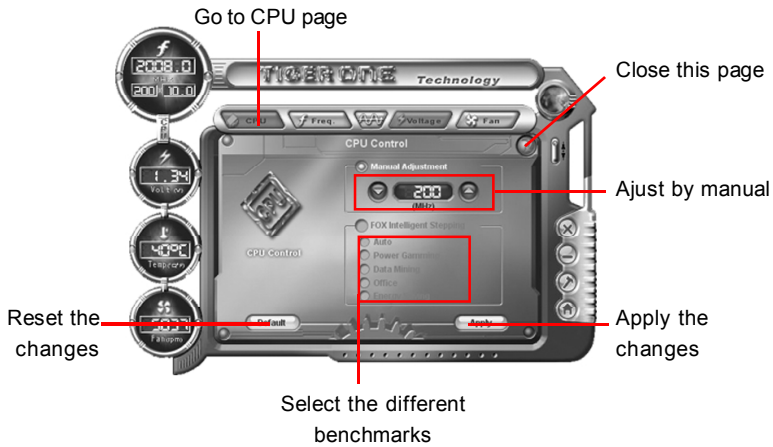

3. Freq. Page - Frequency Control

This page lets you set memory and PCI Express frequency by manual.

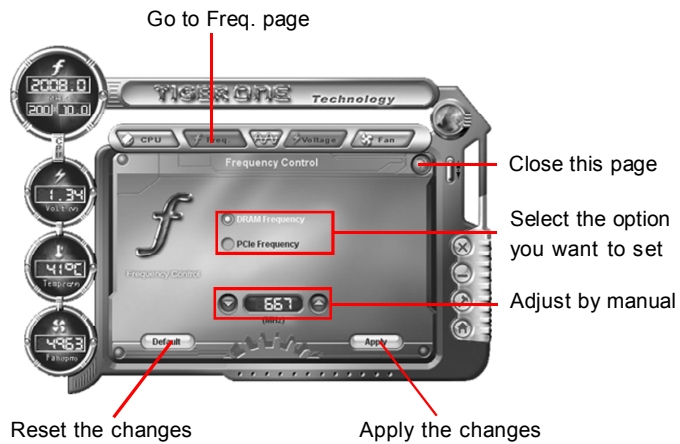

4.1 Limit Setting - CPU Temp.

This page lets you to set CPU high limit temperature and enable the alert function.

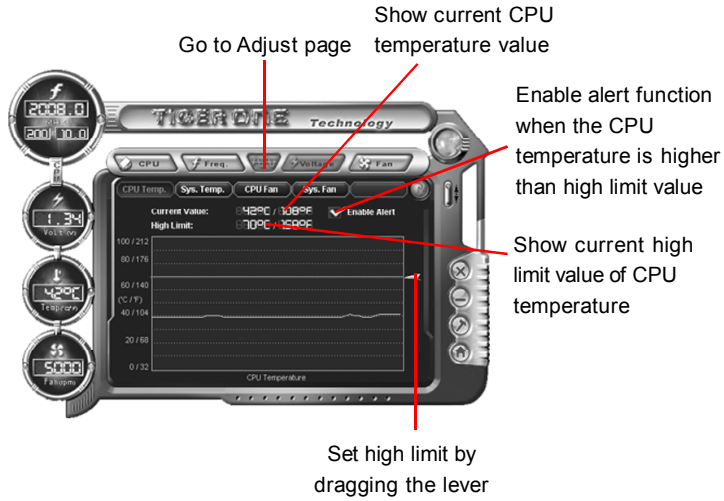

4.2 Limit Setting - Sys Temp.

This page lets you to set system high limit temperature and enable the alert function.

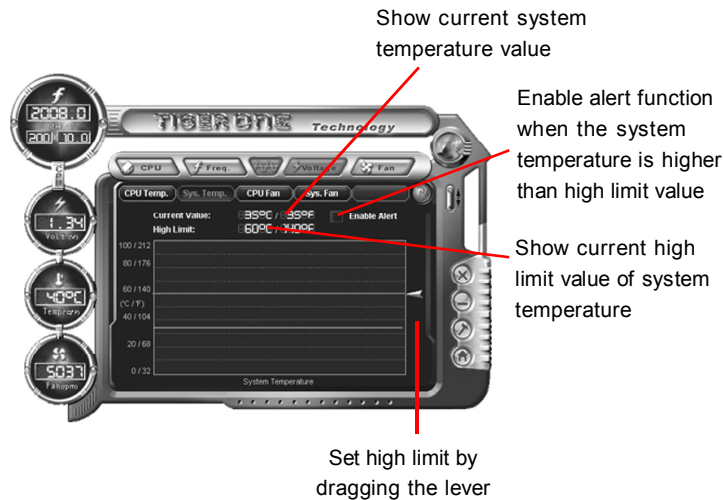

4.3 Limit Setting - CPU Fan

This page lets you to set CPU fan low limit rpm and enable the alert function.

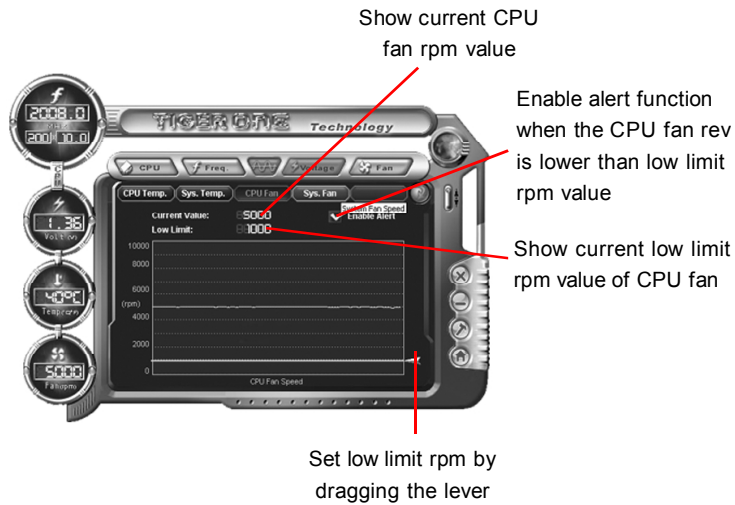

4.4 Limit Setting - Sys Fan

This page lets you to set system low limit rpm and enable the alert function.

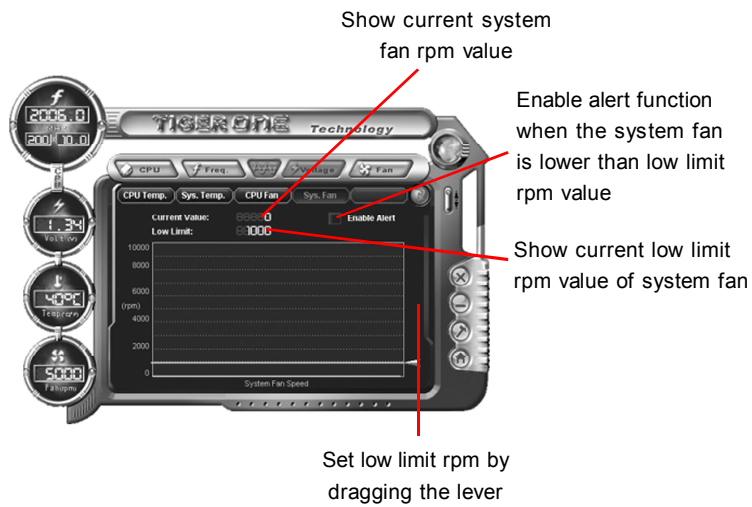

4.5 Limit Setting - Chassis Fan

This page lets you to set chassis fan low limit rpm and enable the alert function.

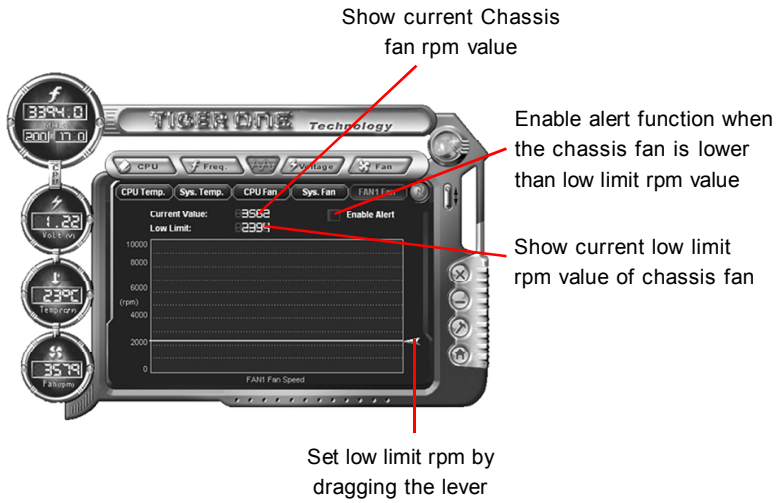

5. Voltage Page - Voltage Control

This page lets you set CPU voltage, memory voltage and North Bridge voltage by manual.

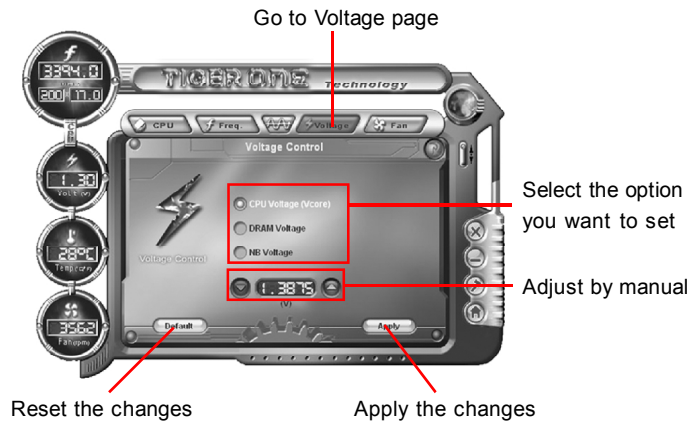

6. Fan Page - Fan Control

This page lets you enable smart Fan function or set fan speed by manual.

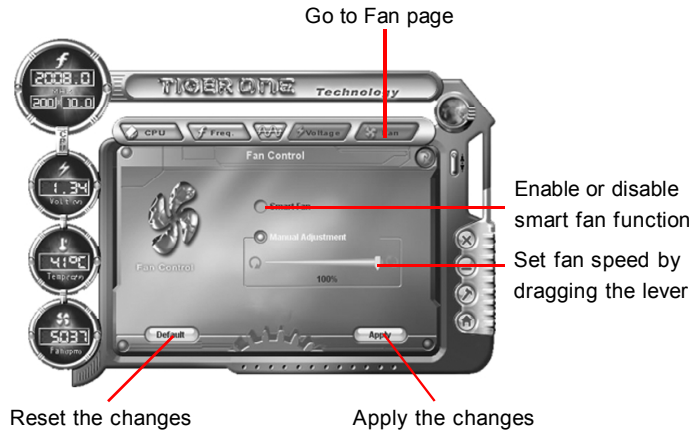

Fox LiveUpdate

Fox LiveUpdate is a useful utility for backuping and updating the system BIOS, drivers and utilities by local or online.

Supported Operating Systems:

- Windows 2000
- Windows XP (32-bit and 64-bit)
- Windows 2003 (32-bit and 64-bit)

Using Fox LiveUpdate:

1.1 Local Update - BIOS Info.

This page lets you know your system BIOS information.

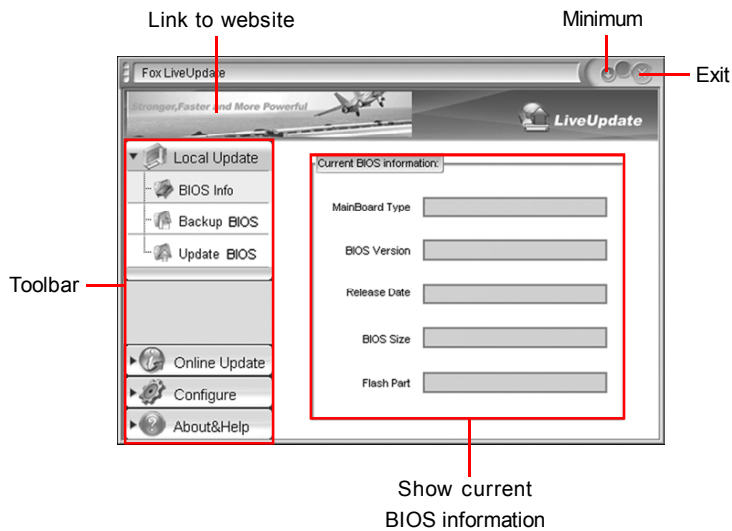

1.2 Local Update - Backup

This page lets you backup your system BIOS. Click “Backup”, then give a name. Click “Save” to finish the backup operation.

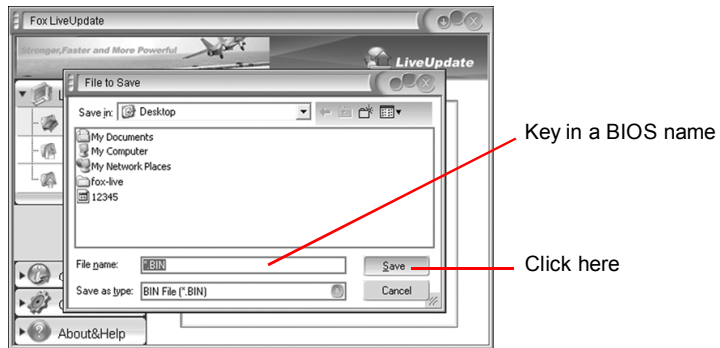

1.3 Local Update - Update

This page lets you update your system BIOS from Internet. After click “Update”, there will show warning message, please read it carefully. If you still want to continue, click “Yes”. Then load a local BIOS file and follow the wizard to finish the operation.

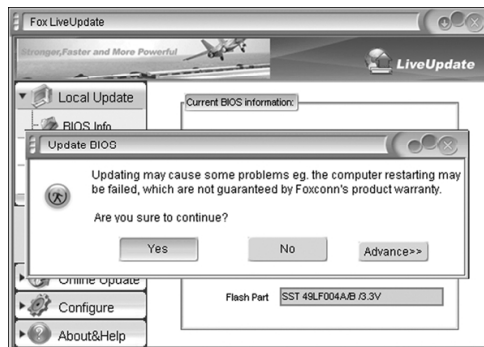

 **Note:**

Fox LiveUpdate will auto backup BIOS before update because we have enabled this function in Configure option.

2.1 Online Update - Update BIOS

This page lets you update your system BIOS from Internet. Click “start”, it will search the new BIOS from Internet. Then follow the wizard to finish the update operation.

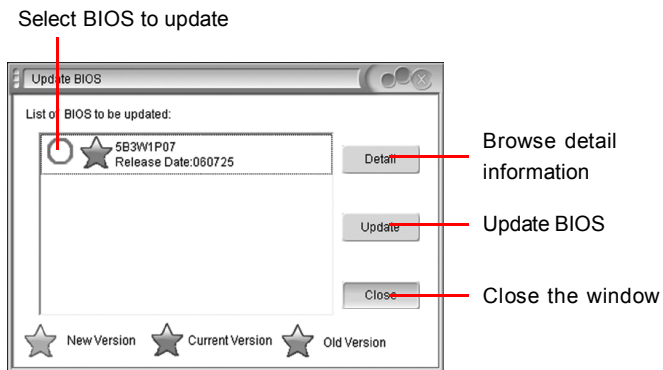
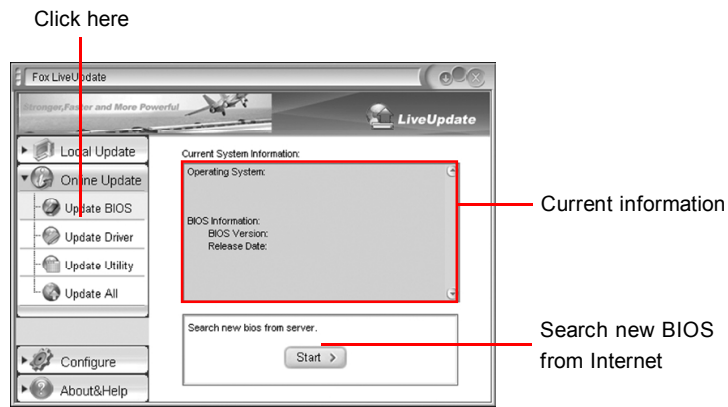

2.2 Online Update - Update Driver

This page lets you update your system drivers from Internet. Click “start”, it will search the new drivers from Internet. Then follow the wizard to finish the update operation.

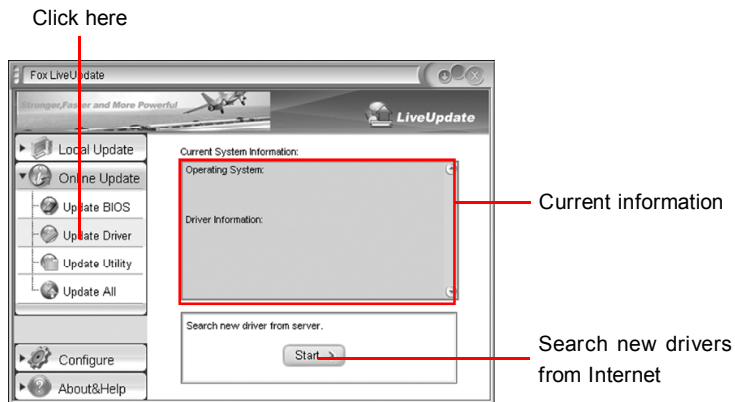

Select the drivers to update

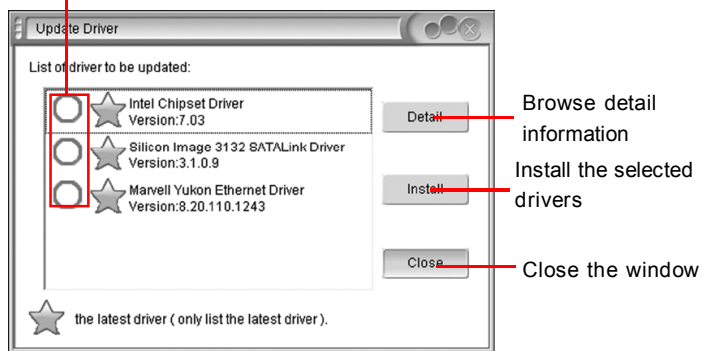

2.3 Online Update - Update Utility

This page lets you update utilities from Internet. Click “start”, it will search the new utilities from Internet. Then follow the wizard to finish the update operation.

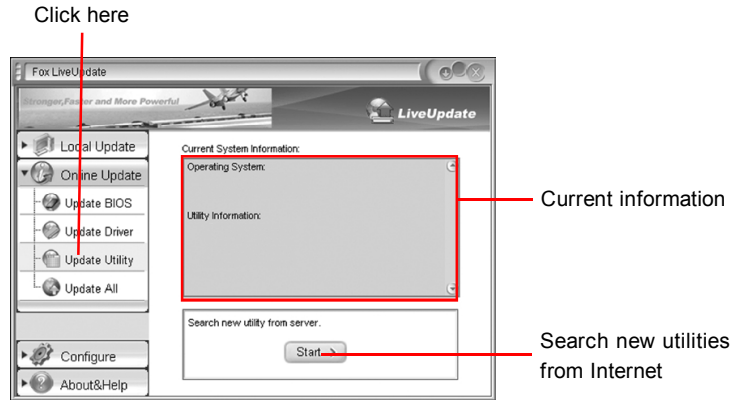

2.4 Online Update - Update All

This page lets you update your system drivers from Internet. Click “start”, it will search all new BIOS/drivers/utilities from Internet. Then follow the wizard to finish the update operation.

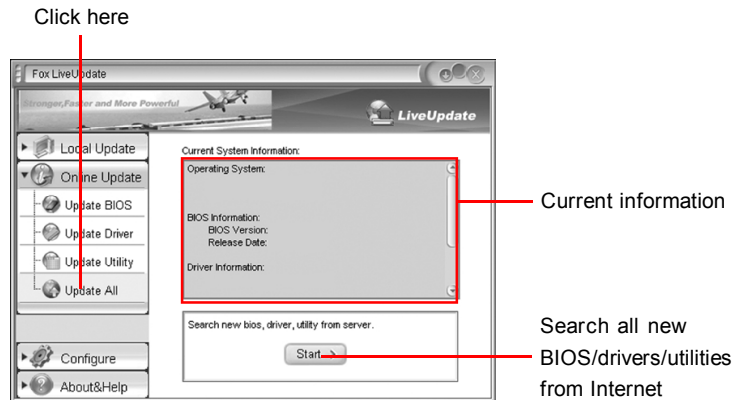

3.1 Configure - option

This page lets you set auto search options. After your setting, the utility will start searching and related information will show on the task bar.

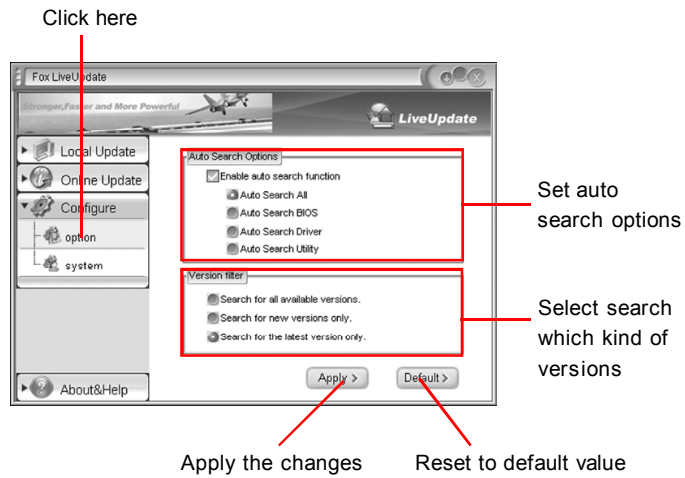

Note:

When enable auto search function, Fox LiveUpdate will appear searching result on task-bar. Double click the icon, you can see the detail information.

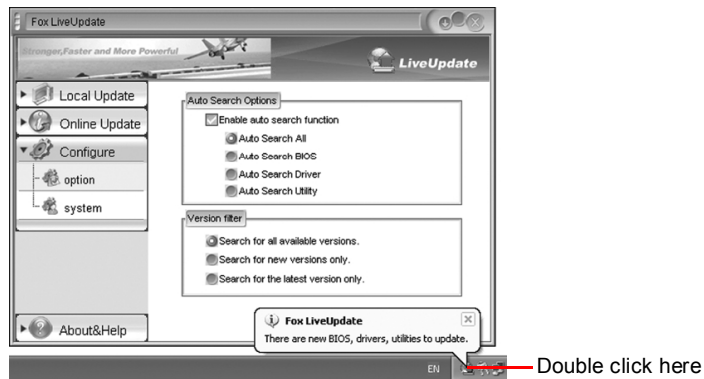

3.2 Configure - System

This page lets you set the backup BIOS location and change different skin of the utility.

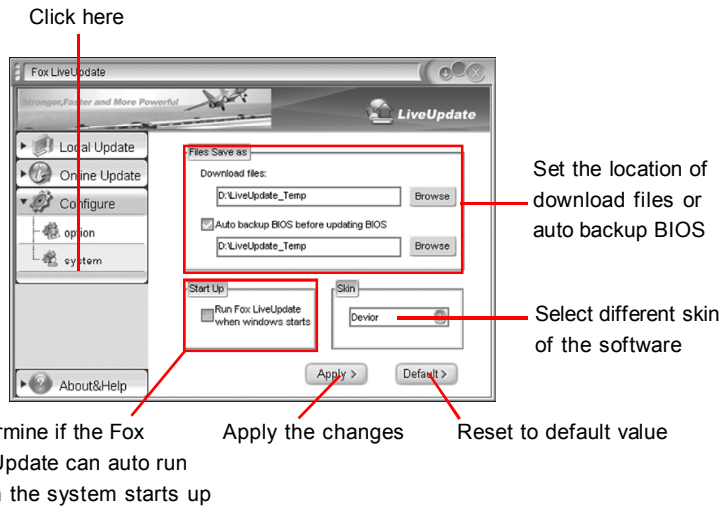

4. About & Help

This page shows some information about Fox LiveUpdate.

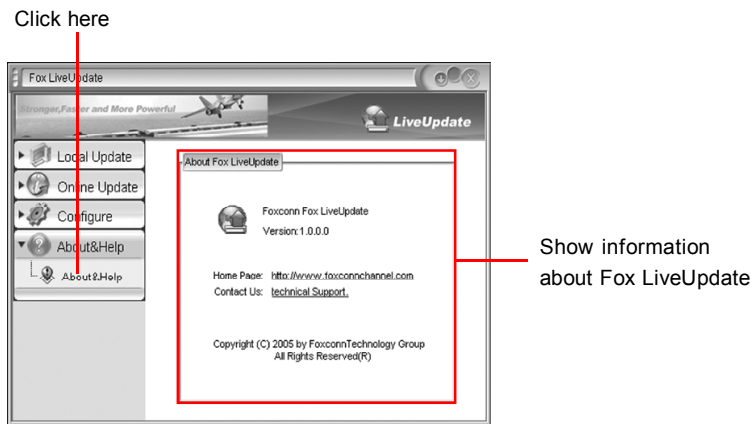

NVIDIA SLI™ Technology

1. Introduction

NVIDIA® SLI™ (Scalable Link Interface) technology takes advantage of the increased bandwidth of the PCI Express™ bus architecture, and features intelligent hardware and software solutions to deliver earth-shattering PC performance in a multi NVIDIA GPU solution.

NVIDIA® nForce™5 SLI MCPs (media and communications processors) offer blistering graphics performance and overall PC performance for both AMD and Intel platforms. With the power of SLI™ technology you get the ability to connect two NVIDIA SLI-Ready PCI Express™ graphics cards for mind-blowing game play with brilliant and intensive 3D graphics.

2. Using SLI™ Technology

Step1. Install two SLI-Ready Graphic cards on the two PCI Express x16 slots.

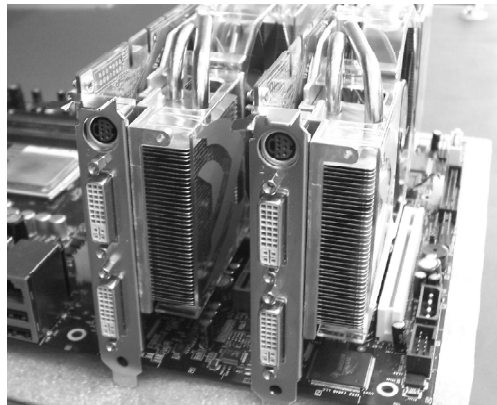

Step2. Connect power extension cable to the graphics card power connector and power supply connector.

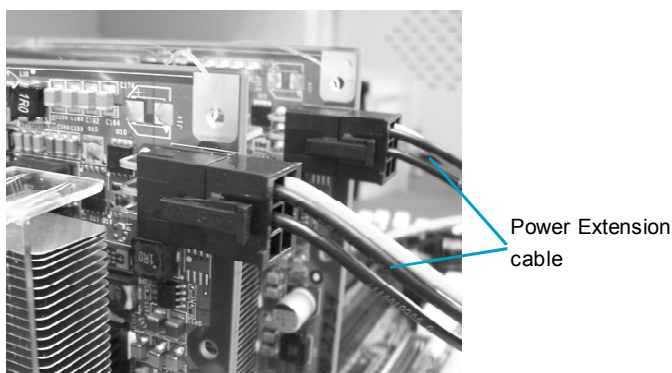

Step 3. Install the SLI Bridge Board to the goldfingers on each graphics card. Make sure that the connector is firmly in place.



Step 4. Connect the 4-pin ATX power cable to the Auxiliary power connector to secure the system is stable.

Step 5. Power on your computer and boot into Operating System.

Step 6. Install the NVIDIA graphics card drivers and restart your computer.

Step 7. Right-click the mouse --> Select "Properties"--> Select "Setting" --> Click "Advanced" --> Select "GeForce xxx xxx" --> Click "SLI multi-GPU" --> Click "Enable SLI multi-GPU".

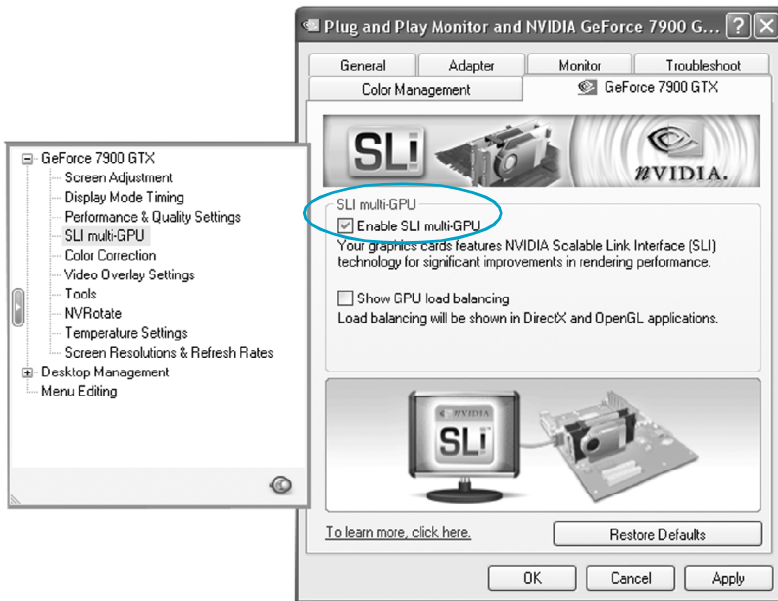

NVIDIA RAID

RAID Arrays

This section describes the following types of RAID arrays that NVIDIA RAID supports:

❖ RAID 0

RAID 0 defines a disk striping scheme that improves the disk read and write times for many applications.

❖ RAID 1

RAID 1 defines techniques for mirroring data.

❖ RAID 0+1

RAID 0+1 combines the techniques used in RAID 0 and RAID 1 arrays.

❖ RAID 5

RAID 5 provides fault tolerance and better utilization of disk capacity.

❖ Spanning (JBOD)

JBOD provides a method for combining drives of different sizes into one large disk.

Summary of RAID Configurations

Array	Advantages	Drawbacks	# Hard Disks	Fault Tolerance
RAID 0	High data throughput.	No fault tolerance.	multiple	None
RAID 1	100% data redundancy.	Requires two drives for the storage space of one drive.	2	Yes
RAID 0+1	Optimized for both 100% data redundancy and performance. Allows spare disks.	Requires two drives for the storage space of one drive - the same as RAID level 1.	4+	Yes
RAID 5	Fault tolerance and better utilization of disk space.	Decreased write performance due to parity calculations.	3+	Yes
JBOD	Combines and uses the capacity of odd size drives.	Decreases performance because of the difficulty in using drives concurrently or to optimize drives for different uses.	multiple	No

Additional RAID Features

NVIDIA RAID offers the following additional features:

❖ Free Disk and Dedicated Spare Disk

A Free Disk or Dedicated Disk can be automatically used in case one drive of a fault-tolerant array fails. NVIDIA RAID defines a fault-tolerant array as either RAID 1, RAID 0+1, or RAID 5. A free disk can be used by any available fault-tolerant array, while a dedicated disk can be used only by the array to which it is assigned.

❖ Bootable RAID

This allows you to install the operating system onto the RAID volume.

❖ Morphing

Morphing is the ability to convert from one RAID mode to another RAID mode. This allows the user to upgrade their current disk or array for better performance, higher security, and increased capacity. More importantly, this is accomplished without having to go through multiple steps. The morphing feature gives the user an upgradeable option to manage storage easily.

❖ Hot Plug Array

A nice flexibility feature is the ability to move MediaShield RAID arrays from one nForce system to another. Since most nForce systems support SATA hot plug capability, you can add/remove a RAID array even while the system is running. This is done using the Hot Plug Array wizard.

Features and Benefits Summary

Features	Benefits
Spare Drive and Dedicated Drive Support	<ul style="list-style-type: none"> Allows the user to dedicate a "spare" disk as a hot standby in the event of a array failure. Offers additional protection in case of a failure in a mirrored array.
Bootable RAID	<ul style="list-style-type: none"> Supports the use of a RAID drive for loading the operating system at power up for optimal performance
Morphing	<ul style="list-style-type: none"> Allows the user to upgrade for more performance, security, and capacity. Allows the user to change the current state of a disk/array to another array with a one step process called "morphing", without losing any data during the configuration change.
Disk Failure Identification	<ul style="list-style-type: none"> Notifies the user when a disk fails and indicates which one to replace.
Hot Plug Array	<ul style="list-style-type: none"> Allows the user to safely add a drive to the array when needed.

Basic Configuration Instructions

The following are the basic steps for configuring NVIDIA RAID:

Non-Bootable RAID Array

1. Choose the hard disks that are to be RAID enabled in the system BIOS.
2. Specify the RAID level, either Mirroring (RAID 1), Striping (RAID 0), Stripe Mirroring (RAID 0+1), or Spanning (JBOD) and create the desired RAID array.
3. Install the operating system on one hard disk, then reboot the computer.
4. Run the Windows nForce Setup application and install the RAID driver.
5. Initialize the NVRAID Array.

Bootable RAID Array

1. Choose the hard disks that are to be RAID enabled in the system BIOS.
2. Specify the RAID level, either Mirroring (RAID 1), Striping (RAID 0), Mirrored Striping (RAID 0+1), or Spanning (JBOD) and create the desired RAID array.
3. Boot from the Windows CD, then press F6 when the Windows Setup appears.
4. Insert the RAID driver floppy to Install the nForce RAID driver.
5. Initialize the NVRAID Array.

Setting Up the BIOS

1. Start up the computer, then press **Delete** to enter the BIOS setup. Select **Integrated Peripherals**, use the arrow keys to select **IDE Function Setup**, then press **Enter**.

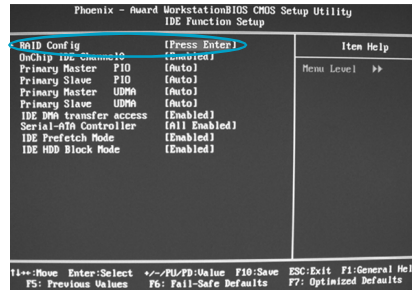

2. Use the arrow keys to select the **RAID Config**, then press **Enter**.

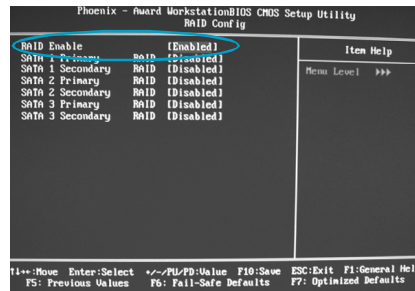

3. From the RAID Config window, enabled the **RAID Enable**, the other items would be light, then you can enable the disk that you want to use as RAID disks.

4. Press F10 to save the configuration and exit.

Entering the RAID BIOS Setup

1. After rebooting your PC, wait until you see the RAID software prompting you to **PRESS F10**. The RAID prompt appears as part of the system POST and boot process prior to loading OS.
2. Press <N>, and the NVIDIA RAID Utility --- **Define a New Array** window will appear. The default **RAID Mode** is set to **Mirroring** and the default **Striping Block** is set to **Optimal**.

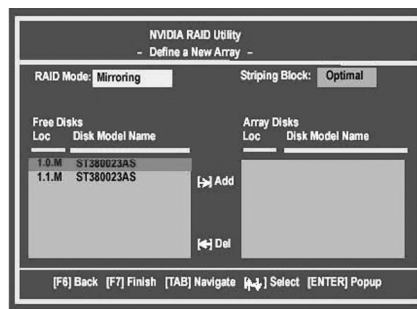

Understanding the “Define a New Array” Window

Use the Define a New Array window to

- Select the RAID Mode
- Set up the Striping Block
- Specify which disks to use for the RAID Array

Depending on the platform used, the system have one or more adapters. In a typical system there are usually one channel and multiple adapters, and each adapter have a slave and a master.

The adapter/channel/master/slave status of each hard disk is given in the Loc (location) columns of the Free Disks and Array Disks lists.

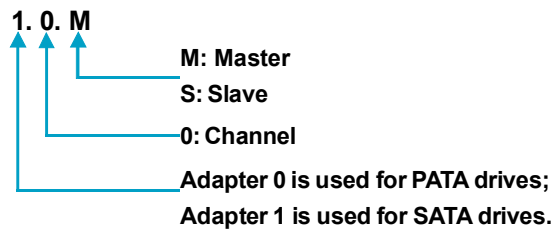

In the example above, 1.0.M means the hard drive is attached to Adapter 1, Channel 0, and the drive is set to Master. The following is a list of all possible combinations:

Parallel ATA

- 0.0.M Adapter 0, Channel 0, Master
- 0.0.S Adapter 0, Channel 0, Slave

Serial ATA

- 1.0.M Adapter 1, Channel 0, Master
- 1.1.M Adapter 1, Channel 1, Master
- 2.0.M Adapter 2, Channel 0, Master
- 2.1.M Adapter 2, Channel 1, Master
- 3.0.M Adapter 3, Channel 0, Master
- 3.1.M Adapter 3, Channel 1, Master

Note: There is no such thing as Slave drive in Serial ATA. All drives are considered to be Master since there is a one to one connection between the drive and the channel.

Using the Define a New Array Window

If necessary, press the tab key to move from field to field until the appropriate field is high lighted.

• Selecting the RAID Mode

By default, this is set to [Mirroring]. Change to a different RAID mode, press the down arrow keys until the mode that you want appears in the RAID Mode box—either [Mirroring], [Striping], [Spanning], [Stripe Mirroring] or RAID 5.

 **Note:** Not all RAID levels are supported on all platforms.

• Selecting the Striping Block Size

Striping Block size is given in kilobytes, and affects how data is arranged on the disk. It is recommended to leave this value at the default [Optimal], which is 32KB, but the values can be between [4 KB] and [128 KB].

• **Assigning the Disks**

The disks that you enabled from the RAID Config BIOS setup page appear in the **Free Disks** block. These are the drives that are available for use as RAID array.

To designate a free disk to be used as a RAID array:

1. Tab to the **Free Disks** section. The first disk in the list is selected.
2. Move it from the Free Disks block to the Array Disks block by pressing the right arrow key (→). The first disk in the list is moved, and the next disk in the list is selected and ready to be moved.
3. Continue pressing the right-arrow key (→) until all the disks that you want to use as RAID array appear in the **Array Disks** block.

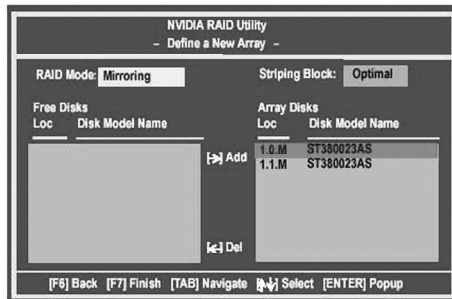

It shows that two disks have been assigned as RAID1 array disks in the figure above.

Completing the RAID BIOS Setup

1. After assigning your RAID array mode, press **F7**. The Clear disk data windows prompt appears.

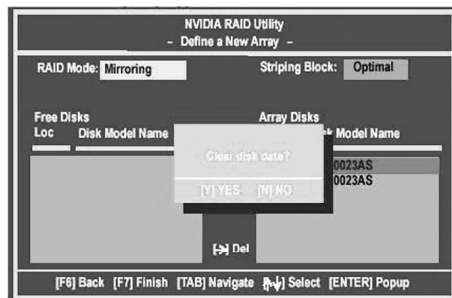

2. Press **Y** if you want to wipe out all the data from the RAID array, otherwise press **N**. You must choose **Yes** if the drives were previously used as RAID drives. The **Array List** window appears, where you can review the RAID arrays that you have set up.

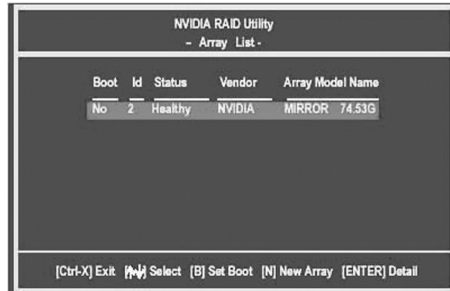

3. Use the arrow keys to select the array that you want to set up, then press **Enter**. The **Array Detail** window appears.

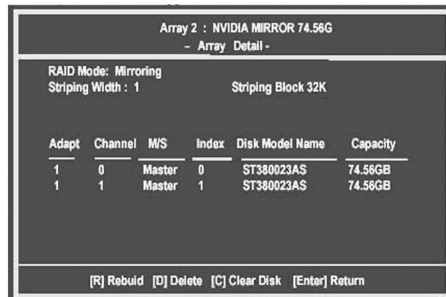

4. If you want to mark this disk as empty and wipe out all its contents then press **C**.
 5. At the prompt, press **Y** to wipe out all the data, otherwise press **N**.
 6. Press **Enter** again to go back to the previous window and then press **F10** to exit the RAID setup.

NVIDIA RAID Utility Installation

Installing the NVIDIA RAID Software Under Windows (for Non-bootable RAID Array)

This section describes how to setup the application and install the RAID software .

1. Start the nForce Setup program to open the NVIDIA Windows nForce Drivers page.

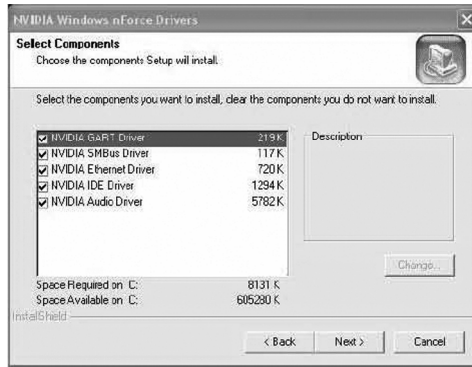

2. Select the modules that you want to install.

Make sure that the "NVIDIA IDE Driver" is selected.

You must install the NVIDIA IDE driver in order to enable NVIDIA RAID. If you do not install the NVIDIA IDE driver, NVIDIA RAID will not be enabled.

3. Click **Next** and then follow the instructions.
4. After the installation is completed, be sure to reboot the PC.
5. After the reboot, initialize the newly created array.

Installing the RAID Driver (for bootable RAID Array)

1. Create an F6 install floppy by using the “-x” option, then copy all files in “...\\IDE\\WinXP\\sataraid” to a floppy disk. (For Windows 2000, substitute “Win2K” in the path.) After you complete the RAID BIOS setup, boot from the Windows CD, and the Windows Setup program starts.
2. Press **F6** and wait for the Windows Setup screen to appear.

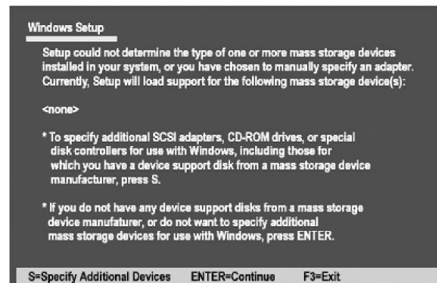

3. Specify the NVIDIA drivers:

(1) Insert the floppy that has the RAID driver, press **S**. The Windows Setup screen appears as below:

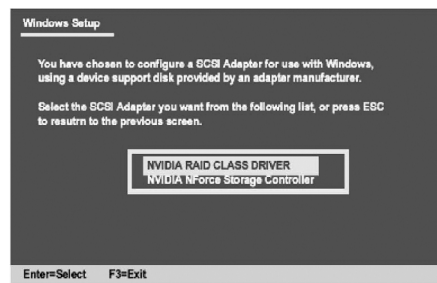

- (2) Select “NVIDIA RAID CLASS DRIVER” and then press **Enter**.
- (3) Press **S** again at the Specify Devices screen, then press **Enter**.
- (4) Select “NVIDIA NForce Storage Controller” and then press **Enter**. The following Windows Setup screen appears listing both drivers:



4. Press Enter to continue with operating system Installation. Be sure to copy the files from the floppy is complete, then take out the floppy.

5. Follow the instructions on how to install operating system. During the GUI portion of the installation you might be prompted to click Yes to install the RAID driver. Click Yes as many times as needed in order to finish the installation. This will not be an issue with a signed driver.

Note: Each time you add a new hard drive to a RAID array, the RAID driver will have to be installed under Windows once for that hard drive. After that, the driver will not have to be installed.

Initializing and Using the Disk Array

The RAID array is now ready to be initialized under Windows.

1. Launch Computer Management by clicking “Start” → “Settings” → “Control Panel” then open the “Administrative Tools” folder and double click on “Computer Management”.



2. Follow screen instructions to install. While finished, the “Computer Management” window appears.

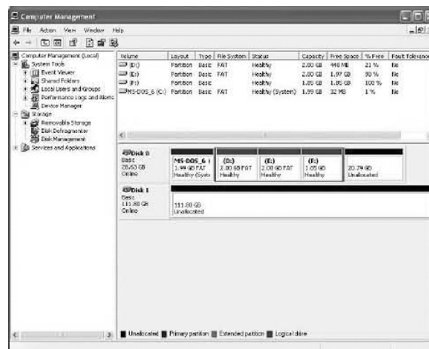

The actual disks listed will depend on your system, and the unallocated partition is the total combined storage of two hard disks. You must format the unallocated disk space in order to use it.

3. Format the unallocated disk space. Right click “Unallocated space”, select “New Partition...” and follow the wizard. After the drive has been formatted, it is ready for use.

Audio Configuration

The ALC882 provide 10 channels of DAC that simultaneously support 7.1 sound playback, plus 2 channels of independent stereo sound output (multiple streaming) through the Front-Out-Left and Front-Out-Right channels. Flexible mixing, mute, and fine gain control functions provide a complete integrated audio solution for next generation multimedia PCs.

Now we will tell you how to install audio driver and use Realtek HD Audio Manager.

1. Click “Audio Driver” button and follow the installation wizard to install Realtek audio driver from Driver CD.

2. After the driver is correctly installed, you will find the icon  on the task bar. Double click it to display the Realtek HD Audio Manager.

3. Main Menu Introduction

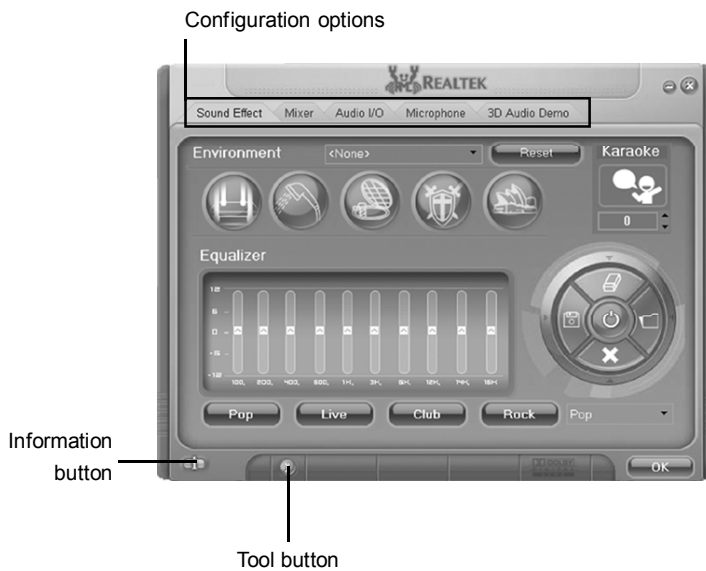

4. Sound Effect Introduction

Allows you to set your listening environment, adjust the equalizer, set the Karaoke, or select pre-programmed equalizer settings.

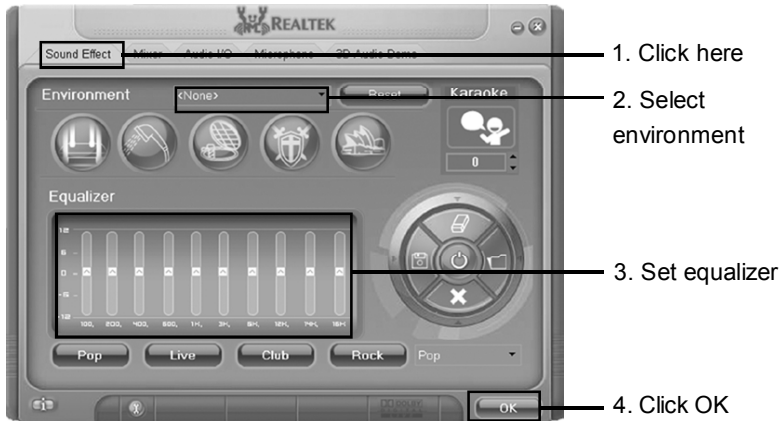

5. Mixer Introduction

Allows you to set audio output and audio input volume.

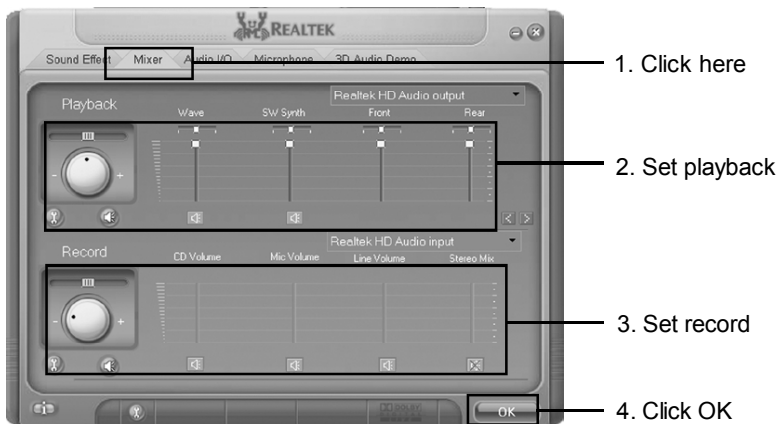

6. Audio I/O Introduction

Allows you to configure your input/output settings.

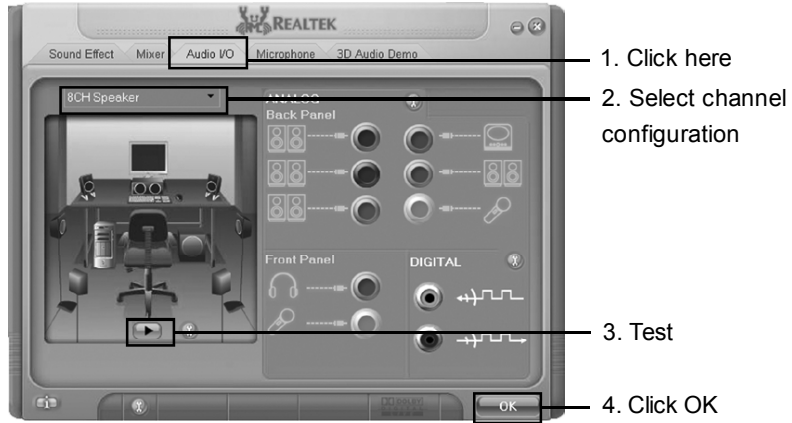

7. Microphone Introduction

Allows you to configure your input/output settings and to check if your audio devices are connected properly.

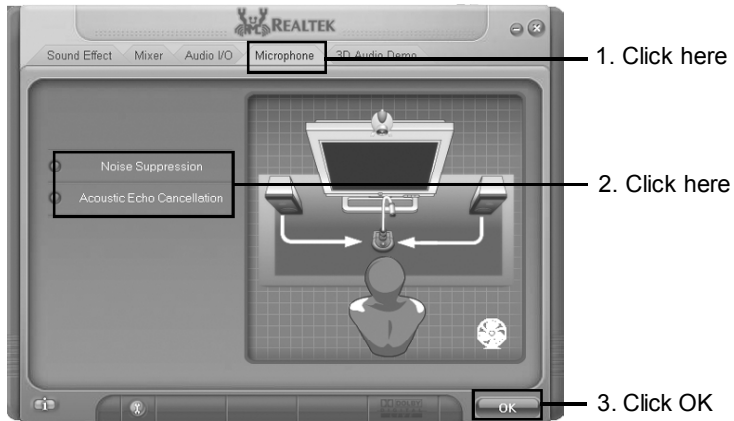

8. 3D Audio Demo Introduction

This option gives you a demonstration of the 3D audio feature.

