

Fostex

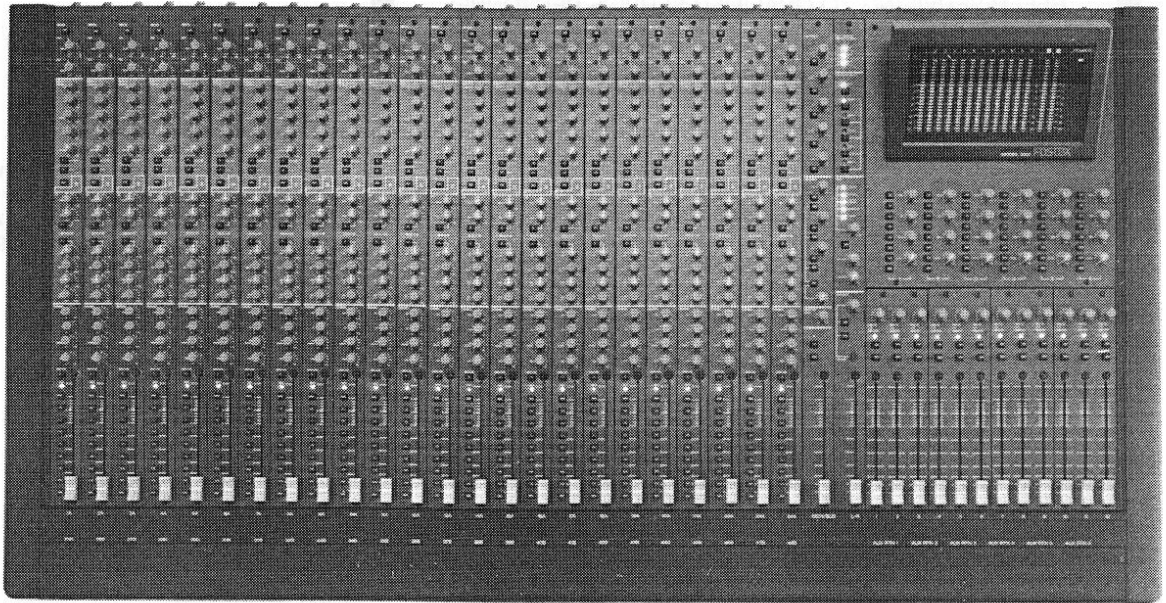

MIXING CONSOLE
Model 2412

Operation Manual

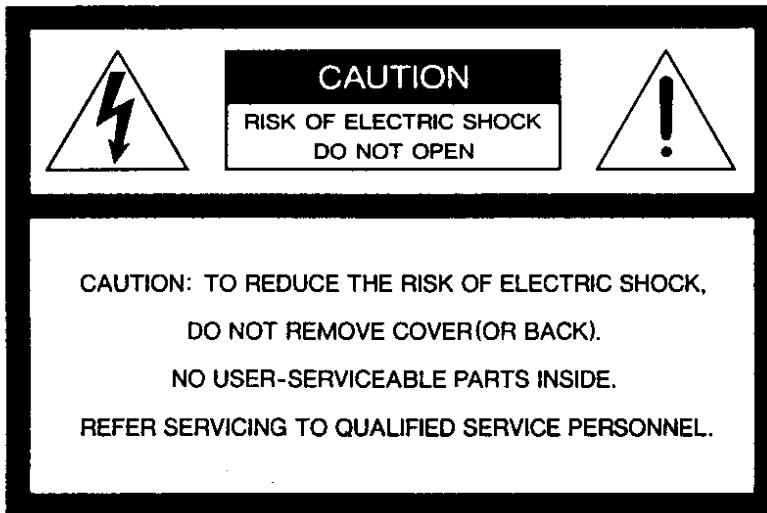

The lightning flash with arrowhead symbol, within an equilateral triangle, is intended to alert the user to the presence of uninsulated "dangerous voltage" within the product's enclosure that may be of sufficient magnitude to constitute a risk of electric shock to persons.



The exclamation point within an equilateral triangle is intended to alert the user to the presence of important operating and maintenance (servicing) instructions in the literature accompanying the appliance.

"WARNING"

"TO REDUCE THE RISK OF FIRE OR ELECTRIC SHOCK, DO NOT EXPOSE THIS APPLIANCE TO RAIN OR MOISTURE."

SAFETY INSTRUCTIONS

1. Read Instructions — All the safety and operating instructions should be read before the appliance is operated.
2. Retain Instructions — The safety and operating instructions should be retained for future reference.
3. Heed Warnings — All warnings on the appliance and in the operating instructions should be adhered to.
4. Follow Instructions — All operating and use instructions should be followed.
5. Water and Moisture — The appliance should not be used near water — for example, near a bathtub, washbowl, kitchen sink, laundry tub, in a wet basement, or near a swimming pool, and the like.
6. Carts and Stands — The appliance should be used only with a cart or stand that is recommended by the manufacturer.
7. Wall or Ceiling Mounting — The appliance should be mounted to a wall or ceiling only as recommended by the manufacturer.
8. Ventilation — The appliance should be situated so that its location or position does not interfere with its proper ventilation. For example, the appliance should not be situated on a bed, sofa, rug, or similar surface that may block the ventilation openings; or, placed in a built-in installation, such as a bookcase or cabinet that may impede the flow of air through the ventilation openings.
9. Heat — The appliance should be situated away from heat sources such as radiators, heat registers, stoves, or other appliances (including amplifiers) that produce heat.
10. Power Sources — The appliance should be connected to a power supply only of the type described in the operating instructions or as marked on the appliance.
11. Grounding or Polarization — The precautions that should be taken so that the grounding or polarization means of an appliance is not defeated.
12. Power Cord Protection — Power supply cords should be routed so that they are not likely to be walked on or pinched by items placed upon or against them, paying particular attention to cords at plugs, convenience receptacles, and the point where they exit from the appliance.
13. Cleaning — The appliance should be cleaned only as recommended by the manufacturer.
14. Nonuse Periods — The power cord of the appliance should be unplugged from the outlet when left unused for a long period of time.
15. Object and Liquid Entry — Care should be taken so that objects do not fall and liquids are not spilled into the enclosure through openings.
16. Damage Requiring Service — The appliance should be serviced by qualified service personnel when:
 - A. The power supply cord or the plug has been damaged; or
 - B. Objects have fallen, or liquid has been spilled into the appliance; or
 - C. The appliance has been exposed to rain; or
 - D. The appliance does not appear to operate normally or exhibits a marked change in performance; or
 - E. The appliance has been dropped, or the enclosure damaged.
17. Servicing — The user should not attempt to service the appliance beyond that described in the operating instructions. All other servicing should be referred to qualified service personnel.



An appliance and cart combination should be moved with care. Quick stops, excessive force, and uneven surfaces may cause the appliance and cart combination to overturn.

Table of Contents

Section I. Features	2
Section II. Safety Precautions	5
Section III. Impedance	6
Section IV. Level Setting	7
Section V. Parametric EQ	8
Section VI. Names and Functions of Controls	9
<i>Input Module</i>	<i>9</i>
Input Section	
Monitor/Submix Section	
High and Low Equalizer Section	
Mid-Range Equalizer Section	
Input Channel Section	
<i>Monitor/Submix Module</i>	<i>13</i>
Auxiliary Master Section	
Foldback Sends Section	
Monitor/Submix Master Section	
<i>Stereo Master Module</i>	<i>16</i>
Phantom Power Status	
Snapshot Mutes	
★ <i>Snapshot Mute Operation</i>	<i>16</i>
Solo Master/Monitor Section	
Talkback/Stereo Master Section	
<i>AUX Return Module</i>	<i>20</i>
<i>Group Master Module</i>	<i>21</i>
<i>Meter Pod</i>	<i>22</i>
<i>Rear Panel</i>	<i>23</i>
Section VII. Basic Signal Flow	27
Route 1: Recording the input sound sources on a multitrack recorder.	
Route 2: Monitoring the output signal of a multitrack recorder while recording.	
Section VIII. Application	33
1. Original Recording Section	
2. Overdubbing	
3. Mixdown	
Section IX. Specifications	38
Block Diagrams	
Appendix: MIDI Interface	

Section I. Features

Introduction

Thank you for purchasing our 2412 console. With proper care and maintenance, the 2412 will give you years of reliability and great sound. The Fostex 2412 has been designed for the professional audio market. As such, this manual will be somewhat technical in nature. We have included data and diagrams that should be helpful to those professional engineers who use this console. However, we hope that this manual is both clearly written and simple enough for the novice user to understand. If you have any questions or comments regarding this manual, the 2412, or any other Fostex product, do not hesitate to contact your authorized Fostex Service Department. We will be happy to help you in any way we can.

Features

The 2412 is designed to be a superb recording console. The 2412 has two groups of 24 channel inputs for a total of 48 inputs. The twelve group output is designed to work directly with a 24 track recorder and, especially, our G24S. The advanced electronics, noise free operation, sophisticated circuitry, and quality construction make the 2412 an ideal console for the studio and its precision size makes it an outstanding choice for live recording situations. The same requirements that make the 2412 so valuable to the recording engineer also make it perfect for anyone who demands flexibility, versatility and sonic accuracy in sound reinforcement.

Features include :

■ The 2412 has A and B input sections totaling 48 inputs. Each section has two AUX, one foldback, and solo. The equalizer section comprises two fixed band equalizers and two variable sweep midrange parametric equalizers. These equalizers may be split between the two input sections or used exclusively for one section. The equalizer section may be used for either inputs A or B, or may be subdivided between the two. In other words, input A can be assigned to the parametric equalizer while input B is assigned to the fixed band equalizer or vice versa.

■ Phantom power is supplied to all 24 channels. A select switch enables a choice of power supply to the input section via 8 channel modules. Please note that this switch is after the meters in the circuit and its operation will not effect them.

■ The 2412 has six AUX RTN. Each one has one AUX, foldback, and solo.

■ There are fourteen bargraph meters (12 groups and L/R). For solo monitoring, the L/R meter indicates the solo monitor level.

■ All channel inputs (MIC/LINE, TAPE IN), as well as, group and stereo and mon/sub outputs have insert jacks.

■ The 2412 mixer uses our own patented faders. These faders have a conductive rubber assembly that is much smoother and more accurate than conventional brush types. In addition, these faders will last longer and are quieter (less than 20 μ Vp-p noise level).

■ The 2412 features MIDI control by either NOTE or CONTROL CHANGE messages. In addition to single channel capability, the 2412 features OMNI ability. This feature enables the controller to receive messages on all channels. Functions such as mute OFF/ON, scene changes via the scene storage mode, L-R panning, etc. can be automated with a MIDI sequencer.

■ With the 2412's scene preview mode, the user can store four different mute scenes in a nonvolatile memory. This feature is extremely useful when a variety of mute set ups are necessary for recording or performance.

■ The controls of the 2412 are logically laid out by function enabling the engineer to set up the console quickly and accurately in a variety of situations.

Midi Snapshots Mutes

This section captures desk mute status into a designated scene. Using this feature permits a preview of a designated mute scene via two color mute and routing LEDs. The green LEDs indicates the channel

mute will be active if the scene is executed. There are four different snapshot storage locations (A-D). When pressing the MUTE button, the red LEDs will light. For details on how to use this function, please see the information under "Snapshot Mutes" in the discussion of controls and functions, items 48 and 49.

Section II. Safety Precautions

- The Fostex power supply unit that comes with the 2412 may be used with either 50 or 60 Hz without any change. Absolutely do not use a power supply of another manufacturer. If the 2412 is to be used in an area with another voltage, please check with your nearest Fostex dealer for the proper power supply unit.
- When disconnecting the power supply unit from an AC outlet, always grasp the plug itself. Pulling on the cord may damage it.
- Do not plug the power supply into an AC outlet with wet or damp hands. Doing so may cause a severe electrical shock.
- It is dangerous to use any electrical appliance with a worn or frayed cord. If the cord has been damaged, please contact your nearest Fostex dealer for repair or replacement.
- Do not open the 2412's case or power supply unit. There are no user serviceable parts inside either unit. Electrical shock could result from opening these units. Fostex will void the warranty on any products so tampered with.
- Be careful not to allow water or foreign objects to enter the 2412 or its power supply unit. Severe damage could result. If water, etc. accidentally gets inside, immediately pull out the power supply cord from the AC outlet and contact your nearest Fostex dealer or service station.
- To avoid damage to the 2412 or any monitor speakers, be sure to switch on the 2412 before turning on any peripheral equipment that is connected to it. Also, when plugging or unplugging any microphones or "line in" components, be sure that the input volume or fader is set to "minimum".

Section III. Impedance

Input and Output Impedance Values for the 2412.

Input and output impedance must be considered when connecting any peripheral equipment to the mixer. Impedance is the resistance value against alternating currents, such as sound signals, within the circuits of an electrical sound device. The unit of measurement is the ohm (Ω). If the impedance of the mixer does not match that of any peripheral equipment that may be connected, the results can range from distortion to serious damage to the mixer or peripheral equipment. In general, output impedance should be low and input impedance should be high. For information on input and output impedance values of the 2412, please refer to the specifications at the end of this manual.

< Note >

Always use a direct box when connecting any outputs rated in watts to the input section of the 2412. Failure to do this may result in serious damage to the power amplifier circuit as well as other components of the console.

Section IV. Level Setting

< INPUT MODULE >

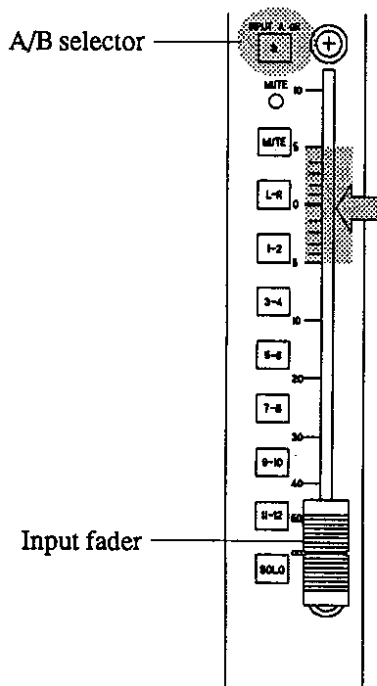
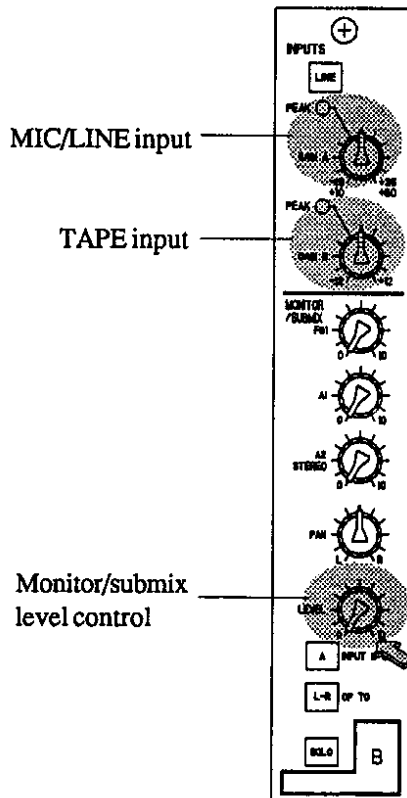

Level settings of the 2412 and sources connected to the mic/line input jack are controlled by the input A gain knob.

Gain should be adjusted so that the Peak Indicator A LED does not light too frequently.

As the best range of the input fader for low noise and distortion is 0 +/- 5 dB, the fader should be preset to this position before gain A is adjusted. If the channel input selector is set to A, the input A gain knob will be adjusted.

Sources connected to the tape input jack are adjusted by the input B gain knob and are indicated by peak indicator B. This assumes that input B has been selected. In the case of sending a signal to the monitor/submix section, the monitor/submix level knob works the same as an input fader.

< NOTE >

Set the monitor/submix knob to 10, its maximum position, and adjust the input volume with the individual A and B gain knobs.

← indicates a location of Unity Gain.

Section V. The Parametric Equalizer

Shelving EQ (HI: 11KHz, LO: 45Hz)

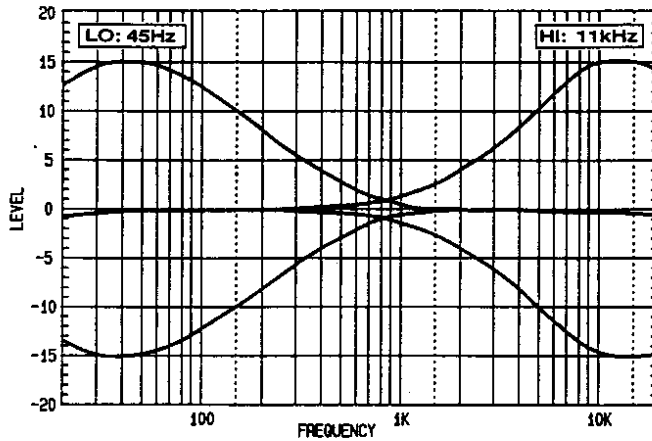

Parametric EQ (MID LO: 60Hz - 1.2KHz)

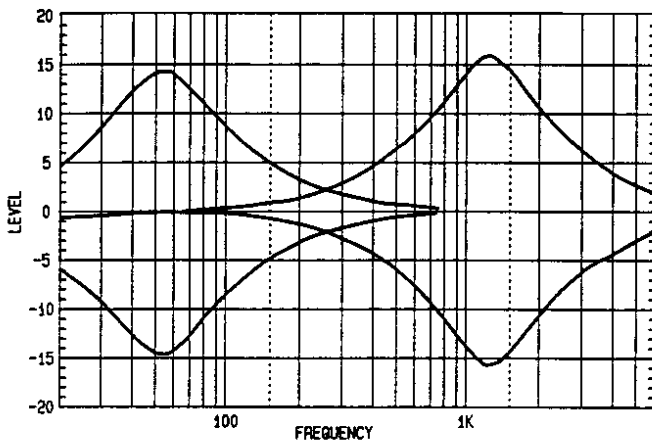

Parametric EQ (HI MID: 1KHz - 16KHz)

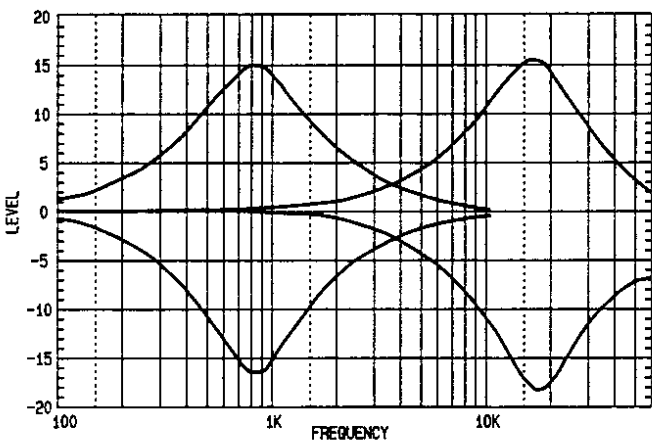

Two fixed frequency shelving type equalizers, as well as, two variable band parametric equalizers are assigned to each channel of the 2412. The mid low band equalizer may be set from 60 Hz to 1.2kHz, and the high mid band equalizer from 1kHz to 16kHz. The frequencies selected may be boost or cut ± 15 dB. These controls are particularly effective in controlling fundamental and harmonic overtones which determine the timbre of the human voice and most musical instruments. It is important to remember that, for the best and most natural amplified and recorded sound, microphone placement is the first alternative chosen by professional engineers. A different microphone or a different placement of a microphone can have a significant effect on recorded sound. It is only after microphone placement has been finalized, that judicious use of the midrange controls should be used.

Section VI. Names and Functions of Controls

NOTE: Letters in parenthesis are identical to panel lettering.

Input Module (X 24)

Input Section

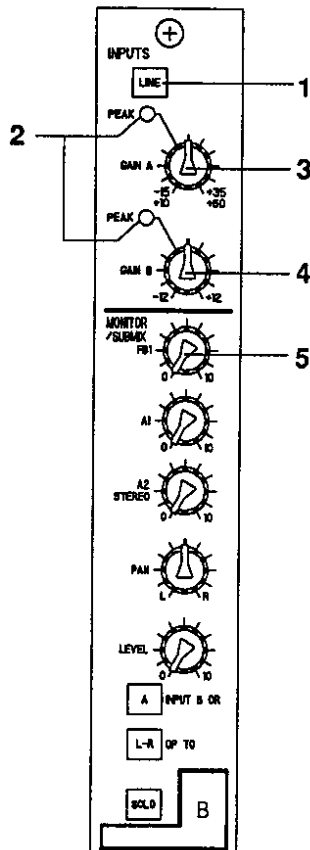

1. Line Switch [LINE]

Use this switch to assign the signal to input A, MIC or LINE. The lower position is LINE.

2. Peak LED [PEAK]

The upper LED indicates overload of the pre-amp of input A (MIC/LINE). The lower LED indicates in the same way as input B (TAPE). The lighting level is +26dB.

3. Gain Control A [GAIN A]

This control adjusts input A gain. Usually, this is a microphone input with variable gain of 10dB to 60dB. When switched to line (LINE switch [1]), gain levels are variable from -15dB to +35dB. This wide gain range precludes the need to use any pads. Use the LINE switch [1] to select line (jack) input to input A.

4. Gain Control B [GAIN B]

This control adjusts the gain for input B. Gain is -12dB to +12dB.

Monitor/Submix Section

5. Foldback 1 Gain [FB1]

This controls the foldback or monitor gain. The pre "level" signal is sent to the FB1 buss. When overdubbing, and the A/B selector [10] is set to "B" while using the monitor gain level [9] for control room monitoring, this control may be used for a separate mix for musicians in the studio room. In P.A. applications, this control may be used for a stage monitor mix. This enables the operator to have two monitor mixes on stage, i.e., a louder mix for the drummer and

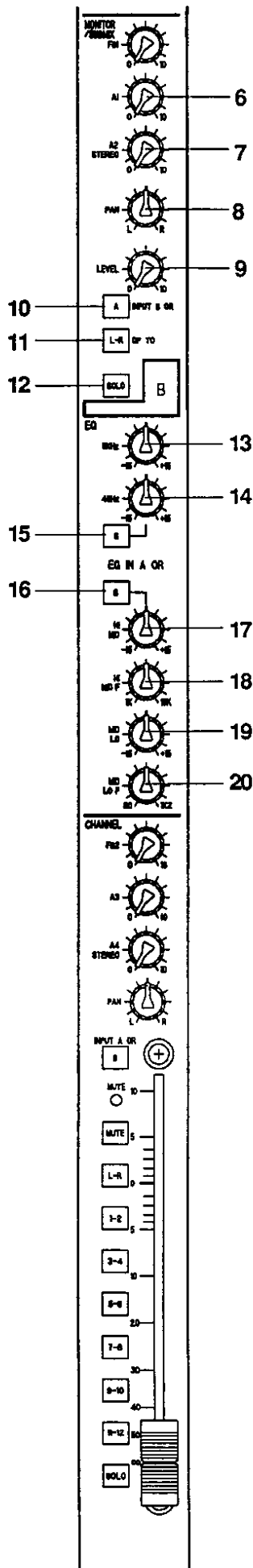

a softer mix for the singer, etc.

6. Auxiliary 1 [A1]

This adjusts the auxiliary 1 output. The post "level" signal is sent to the AUX 1 buss. When overdubbing and "B" is selected [10], use this control for effect level. When mixing down and "A" is selected, use this for submixing synchronized MIDI sound modules.

7. Auxiliary 2 [A2 STEREO]

This controls the gain for auxiliary 2. This is a stereo output. The signal is sent "post" level to the AUX 2 buss. When using stereo effectors, use this gain control.

8. Auxiliary 2 Pan Pot / Monitor/Submix Pan Pot [PAN]

This controls the panning of the auxiliary 2 and monitor/submix signal simultaneously. Please note that control [7] and control [8] work in co-ordination to route these signals.

9. Monitor/Submix Gain [LEVEL]

The signal gain that is selected by the A/B selector [10] is controlled here.

10. A/B Selector [[A] INPUT B OR]

This selects input from gain A or B. In the up position, input B, as an independent input is selected. In the down position, input A is selected. Input B is selected for inline tape monitoring purposes.

11. Assignment Button [[L-R] OP TO]

This is the L-R assignment button for stereo/monitor/submix. Up position is monitor/submix buss. Down position is stereo buss.

12. Solo Button [SOLO]

Solo button for monitor/submix. When this button is pushed, the solo LED "B INPUTS" on the master module will light. This solo is stereo and is post fade.

High and Low Frequency Equalizer Section

13. Fixed Band EQ [HF 11kHz]

This controls the fixed band equalizer for inputs A or B. This EQ controls the high end of the signal.

14. Fixed Band EQ [LF 45Hz]

The fixed band equalizer for inputs A or B. This EQ controls the low range of the signal.

15. Select Button [EQ IN A OR [B]].

This button selects either input A or B for the fixed band equalizer. The up position selects A. The down position selects B.

Mid-Range Equalizer Section

16. Select Button [EQ IN A OR [B]]

This button functions the same as [15]. Please note that you may assign input A or B to either section of the equalizer independently. Both the high/low and mid range equalizer sections are assigned to input signal path A.

17. Boost/Cut [HI MID]

18. Select Frequency [HI MDF]

These two knobs work together to adjust the high end of the midrange frequencies. Control [17] adjusts the output, while control [18] selects the frequency to be equalized. A ± 15 dB cut or boost can be applied in a range of 1kHz to 16kHz with this section.

19. Boost/Cut [MID LO]

20. Select Frequency [MID LOF]

These two knobs work together in the same manner as [17] and [18] above. These are for controlling the low midrange. The variable sweep is from 60Hz to 1.2kHz.

Input Channel Section

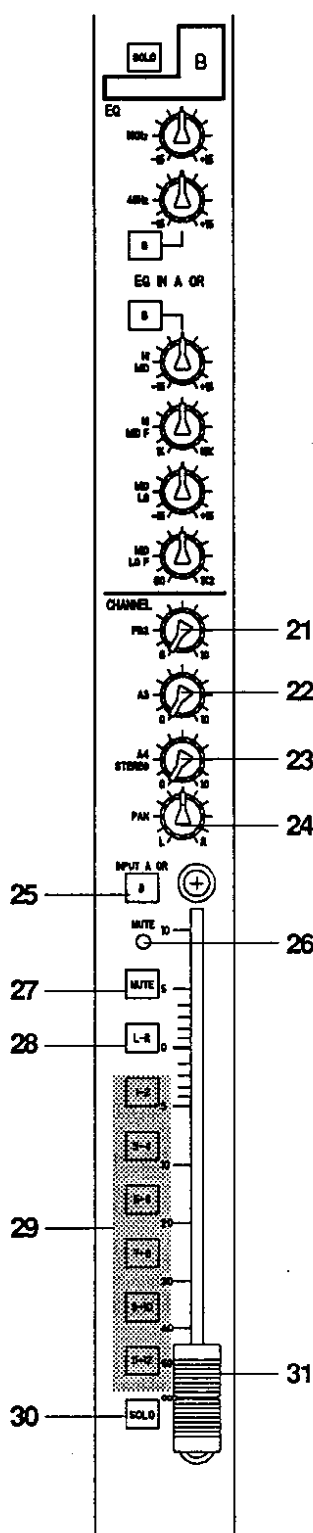

21. Foldback 2 Gain [FB2]

This controls the foldback 2 gain. This pre-fader and pre-EQ signal is sent to the FB2 buss.

22. Auxiliary 3 [A3]

This functions the same as auxiliary 1 [6]. The post fader signal is sent to the AUX3 buss.

23. Auxiliary 4 [A4 STEREO]

This control functions the same as auxiliary 2 [7]. This controls the stereo post fader output and sends the post fader signal to the AUX4 buss.

24. Auxiliary 4 Pan Pot/Assignment Pan Pot [PAN]

This control places the signal in the stereo mix and Auxiliary 4. The pan control positions the signal between odd/even busses to groups and the L/R.

25. Input Select [INPUT A OR [B]]

This button selects input A or B. The up position is A while the down position is B.

26. Mute LED [MUTE]

This LED indicates whether muting on the channel is active. This LED indicates the status of the Scene/MIDI controlled channel routing. Red indicates audio mute is active while green indicates preview mode.

27. Mute Button [MUTE]

Pressing this button activates muting on this channel.

28. Stereo Assign Switch [L-R]

This L-R button is the master stereo control. Use this button to assign the channel to the overall stereo mix.

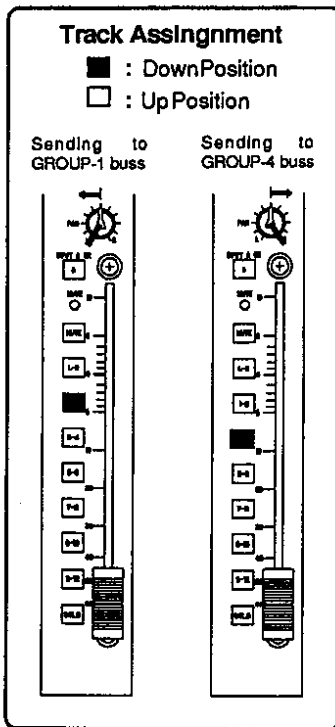

29. Track Assignment Buttons [1-2, 3-4,, 11-12]

These buttons assign the individual input to any or all groups 1-12. The up position is off. To assign an input, press the desired button and then use the pan knob [24] to assign to either an odd or even numbered channel. As an example, when pressing down 1-2, L becomes 1 and R becomes 2.

30. Solo Button [SOLO]

Press this button for solo monitor. This solo is stereo and is post fade. When this button is pressed, the solo LED "A INPUTS" on the stereo master module will be lit.

31. Input Fader

This fader adjusts the signal output of the channel input section.

Monitor/Submix Module (X 1)

Auxiliary Master Section

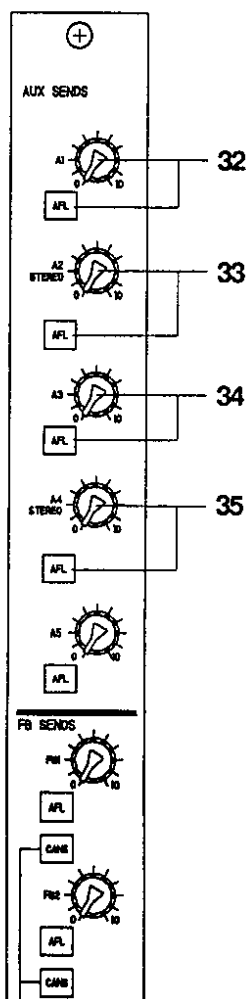

32. AUX 1 Master/AFL Button [A1/AFL]

This knob controls the master level of AUX 1 buss. When pressing the AFL button, the solo "AUX RTN/SEND" LED will be lit on the stereo master module. This controls the post AUX 1 Master level signal to stereo solo buss.

33. AUX 2 Master/AFL Button [A2 STEREO/AFL]

This knob controls the master level of AUX 2 stereo buss. This button controls the Post AUX 2 Master level to stereo in-place solo buss (the same as [32]).

34. AUX 3 Master/AFL Button [A3/AFL]

Post AUX 3 Master controls the master level of AUX buss 3 and the signal level to the stereo solo buss.

35. AUX 4 Master/AFL Button [A4 STEREO/AFL]

This functions the same as [33].

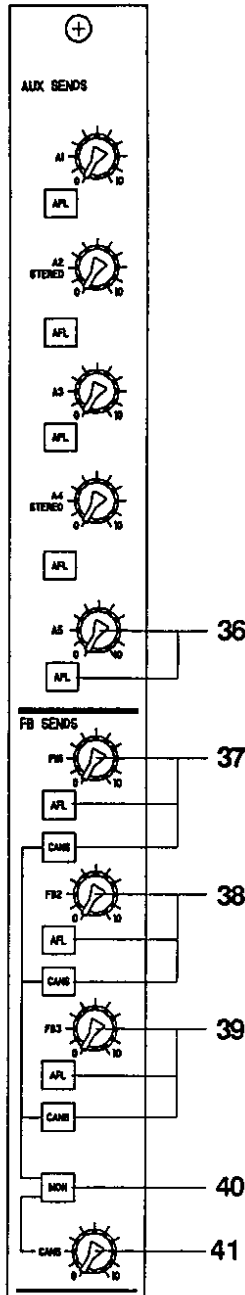

36. AUX 5 Master/AFL Button [A5/AFL]

This functions the same as [32].

Foldback Sends Section

37. Foldback 1 Master/AFL Button/CANS Button [FB1/AFL/CANS]

This knob is the master output level control of foldback 1 buss. AFL button controls the post FB1 master level signal to the solo buss. When this button is pressed, the solo LED "FB/MON MIX" on the stereo master module will be lit. CANS button switches the FB1 signal to the headphone mix. This is effective only when the MON button [40] is in the up position.

38. Foldback 2 Master/AFL Button/CANS Button [FB2/AFL/CANS]

This knob is the master output level control of foldback 2 buss. AFL button controls the post FB2 master level signal to the solo buss. CANS button switches the FB2 signal to the headphone mix.

39. Foldback 3 Master/AFL Button/CANS Button [FB3/AFL/CANS]

This knob is the master output level control of foldback 3 buss. AFL button controls the post FB3 master level signal to the solo buss. CANS button switches the FB3 signal to the headphone mix.

< NOTE >

37, 38, and 39 all function in an identical manner.

40. Monitor Button [MON]

This control selects the control room monitor signal path to the headphones. In the up position, each foldback signal is selected. In the down position, the same signal as MON OUT jack is selected.

41. CANS Master [CANS]

The master headphone output control is located here.

Monitor/Submix Master Section

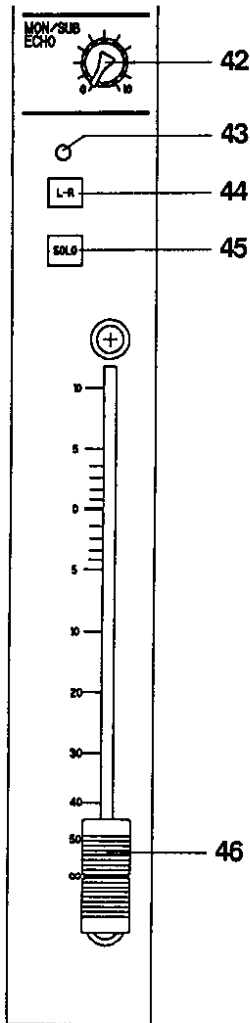

42. Echo Return [MON/SUB ECHO]

Mon/Sub Echo is an independent stereo input to the monitor/submix buss. This input is ideal for effectors such as echo, reverb, etc. for monitoring.

43. Mute LED

This LED indicates the routing of the MON/SUBMIX output to the stereo buss. When pressing the L-R button [44], this LED will be lit red. In the preview mode it will be lit green (the same as the MUTE LED [26]). This LED will light when the L-R master is muted.

44. MON/SUB to L-R Mute Button[L-R]

This is a momentary type switch that toggles the output status of the "monitor/submix" to "left/right" master buss. This control functions the same as the MUTE button [27].

45. Solo Button[SOLO]

While pressing this button, Solo LED "FB MON/MIX" on the stereo master module will be lit. This sends the monitor/submix master fader signal to in-place stereo solo buss.

46. Monitor/Submix Master Fader

This fader controls output level of the monitor/submix jack.

Stereo Master Module (X 1)

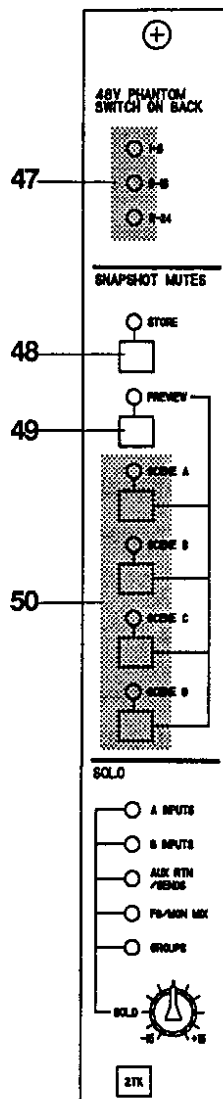

Phantom Power Status

47. Phantom Power Indicators [1-8, 9-16, 17-24]

These indicators are for the 48V phantom power supply. The power is switched in 8 modules per bank with the rear panel switches [96].

Snapshot Mutes

48. Store button/LED [STORE]

This button "captures" the current mute status into designated mute scene.

49. Preview button/LED [PREVIEW]

This button is for confirmation and editing of the scene memory. It permits a non-destructive preview of a designated mute scene via two color mute and routing LEDs. Green light indicates that the channel will be active if the scene is executed. When executed, the LEDs will be red.

50. Scene A through D/LED [SCENE A~D]

This recalls the various scenes in a nonvolatile memory.

Snapshot Mute Operation

- Store the Memory.**
1. Create the mute pattern by using each MUTE button [27].
 2. Press the STORE button [48]. The LED will light.
 3. Select one, A through D, and push the desired SCENE button. The SCENE LED will light.
 4. In about a second, both LED's will extinguish. The scene has been stored.

Recall the Scene Memory.

1. Check that the STORE and PREVIEW LEDs are extinguished.
2. Press the desired SCENE button [50]. The SCENE status will be indicated by each LED and will be executed.

<NOTE>

After recalling the memory, if you press any of the MUTE buttons, the selected SCENE LED will be extinguished. The LED will not light again if you press the same MUTE button.

Confirmation of the Memory by Preview Mode.

The preview mode is for monitoring the memorized pattern. This pattern will be indicated by green LEDs. This is a preview mode and will not execute the mute pattern.

1. Press the PREVIEW button [49]. The LED will light.
2. Press the desired SCENE button. LED will also light. The mute scene will be indicated by the green LEDs.
3. Press another scene button, and that stored pattern will be indicated.
4. To cancel the preview mode, press the PREVIEW button.

<NOTE>

After a red LED is lit by pressing a MUTE button, entering the preview mode will cause it to light green. The LED will then be amber, a mixture of red and green.

Editing of the Memory with the Preview Mode.

1. Press the PREVIEW button [49] (LED will be lit).
2. Press the desired SCENE button [50] (LED will light).
3. The mute pattern can be changed by pressing each MUTE button [27].
4. Press the STORE button and, then, the SCENE button.
5. In about a second, the new scene will be stored.

Clearing the Scene Pattern.

1. When in the store or preview modes, press the STORE and PREVIEW buttons at the same time.
2. The scene pattern will now be cleared. In addition, the STORE and PREVIEW modes will be canceled.

Solo Master/Monitor Section

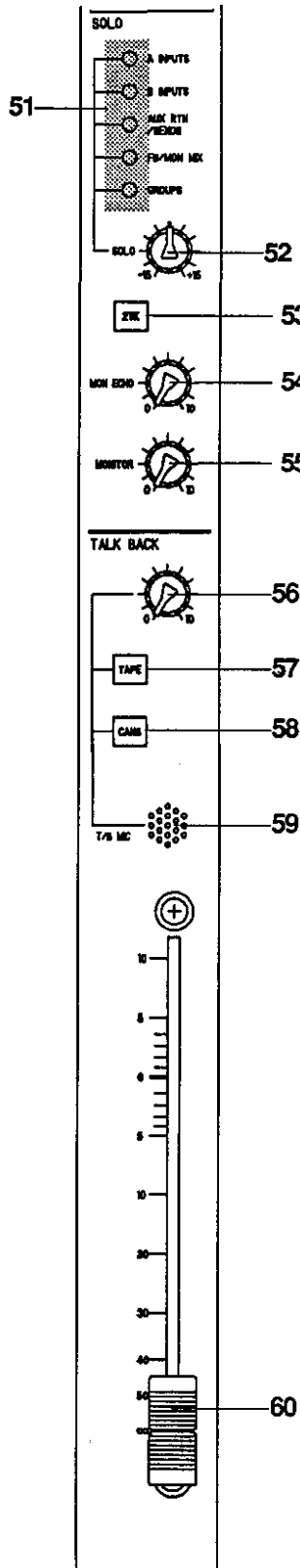

51. Solo LEDs

[A INPUTS, B INPUTS, AUX RTN/SEND, FB/MON MIX, GROUPS]

These five LEDs indicate the territory of solo activity in the console.

A INPUTS:	When pressing the SOLO A button on the input module, will be lit.
B INPUTS:	When pressing the SOLO B button on the input module, will be lit.
AUX RTN/SEND:	When pressing the SOLO button on the AUX RTN module, will be lit. or When pressing the AFL button on the AUX master section, will be lit.
FB/MON MIX:	When pressing the AFL button on the FB SENDS section, will be lit. or When pressing the SOLO button on the monitor/submix section, will be lit.
GROUPS:	When pressing the SOLO button on the group master module, will be lit.

52. Solo Master [SOLO]

This controls the output of the stereo SOLO monitor. When only solo monitoring, the L-R bargraphs will indicate solo levels.

53. Two Track Button [2TK]

This selects the "two track" signal for the control room monitor circuit (monitor output level [55]). When this button is pressed, only the 2 track signal can be monitored.

54. Monitor Echo [MON ECHO]

This controls the stereo monitor echo to the control room monitor. This is an independent input, i.e., MON ECHO jack to the MON OUT jack.

55. Monitor Output [MONITOR]

This adjusts the level of the signal to the control room monitor output (MON OUT jack).

Talkback/Stereo Master Section

56. Talkback Level [TALK BACK]

This controls the built in talkback microphone.

57. Tape Assign Button [TAPE]

This is for talking to the group 1 through 12. This button allows you to talk to group 1 through 12 and record your voice into monitor.

58. Cans Assign Button [CANS]

Press this button to talk to anyone connected to this circuit (FB1~FB3) via headphones.

59. Talkback Microphone [T/B MIC]

This is the internal front panel mounted electret microphone.

60. Stereo Master Fader

This fader is the L-R master output fader. Please note that these faders are our patented conductive roller faders.

Aux Return Module (X 1)

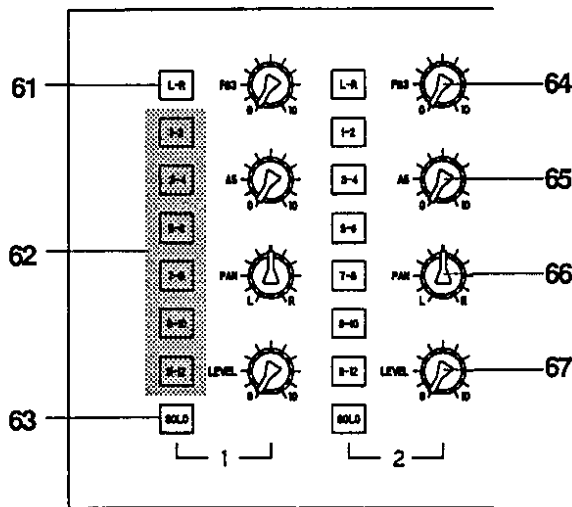

61, 62. Assignment Buttons

[L-R, 1-2, 3-4, ..., 11-12]

These buttons are for assigning the AUX RETURN section. With these buttons, you may assign to the master stereo mix or to individual group channels. Use L-R to select input signal to the main stereo buss via the pan pot. The routing matrix selects the AUX RETURN signal to any or all groups 1-12. Routing is odd/even via the pan pot.

63. Solo Button [SOLO]

Use this button for stereo solo of aux return input. When pressing this button, the solo LED "AUX RTN/SEND in the stereo master module will be lit.

64. Foldback 3 [FB3]

This control is the pre-gain control for [67]. This pot sends the signal to the FB3 buss.

65. Auxiliary 5 [A5]

This controls the signal strength to the auxiliary section via the A5 buss. This control is the post gain control for [67].

66. Pan Pot [PAN]

This is the pan pot for the AUX RTN section. This pan pot assigns the signal into the stereo mix or to individual group channels.

67. AUX Return Level Control [LEVEL]

This controls the level of AUX RTN input.

Group Master Module (X 4)

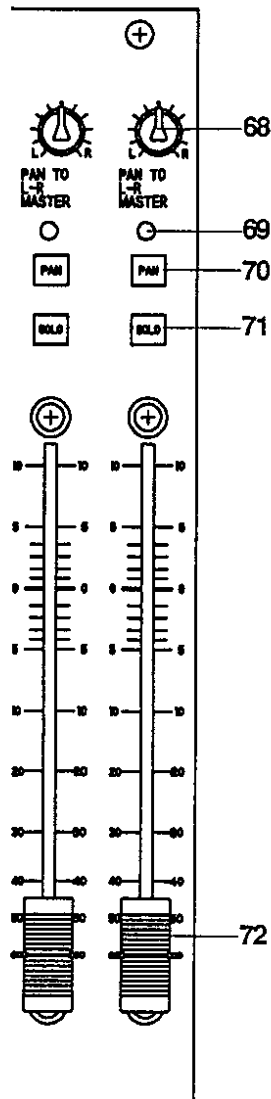
**68. Pan Pot to L-R Master [PAN TO L-R MASTER]**

Assigns the buss position of each buss signal when mixing the output signal of the group buss to the L-R master.

69. Mute LED

This LED lights when the group out to the L-R master is muted. After the assignment has been made, the status LED will extinguish.

70. Pan Pot Mute Button [PAN]

This control functions as a mute button for group to L-R. After the assignment has been made, the mute LED will extinguish.

71. SOLO Button [SOLO]

This sends the group master fader signal to the stereo solo buss. While pressing this button, "GROUPS" on the stereo master module will light.

72. Group Master Fader

This fader controls the output level of each group output.

Meter Pod

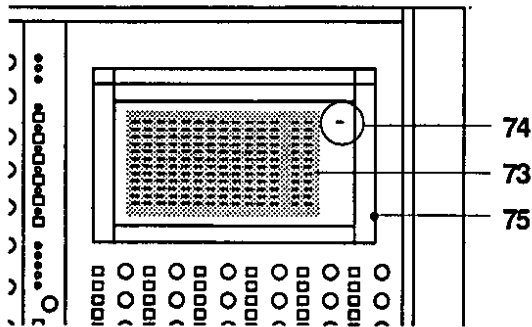

73. Meter Segments [1~12/L,R]

The 12 bar meter segments are visual monitors of the group output. Each bar is composed of 12 segments. In addition, there are two bars for stereo output. All meters have a peak hold function. Peak hold time is about one second. When using any of the solo buttons, the L-R bars will indicate solo buss level.

74. Power Indicator [POWER]

The red light indicates that power is ON.

< NOTE >

The power switch is on the power supply unit.

75. Headphone Output [PHONES]

The headphone signal is output here. It is the same signal as the CANS jack. CANS MASTER [41] controls the output level for both outputs.

Rear Panel

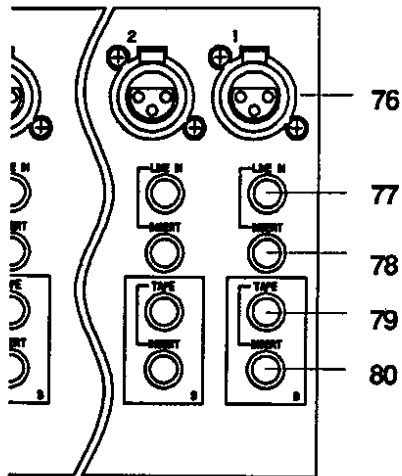
**76. Microphone Inputs [MIC]**

These are balanced microphone inputs for XLR balanced connectors.

< NOTE >

When using as unbalanced inputs, connect pin 1 and pin 2 as ground. Pin 3 is hot. This will deactivate the phantom power switch.

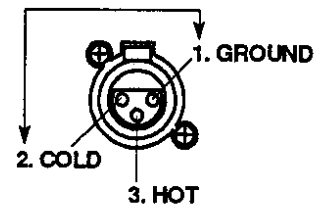
**77, 78. Line Level Inputs/Insert Jacks [LINE IN/INSERT]**

The line inputs are for standard 1/4 inch stereo plugs. The INSERT inputs are for connecting peripheral equipment or inputting effectors on individual channels. In the insert jack, the tip is send and the ring is receive.

79, 80. Tape Inputs/Insert Jacks [TAPE/INSERT]

Connect tape recorders or other recording devices here. Please see specifications for further information.

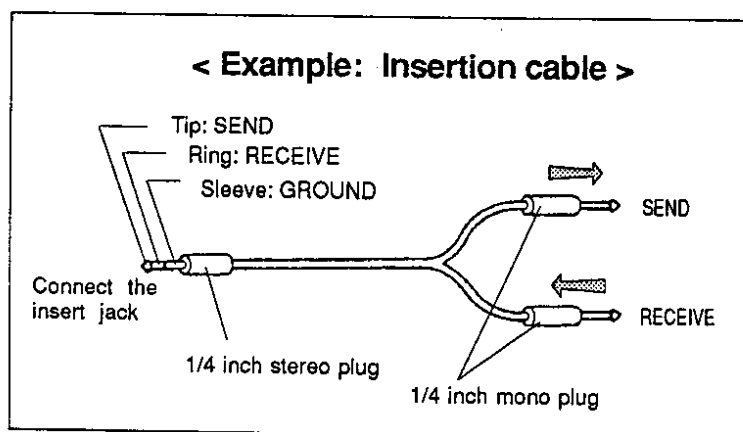

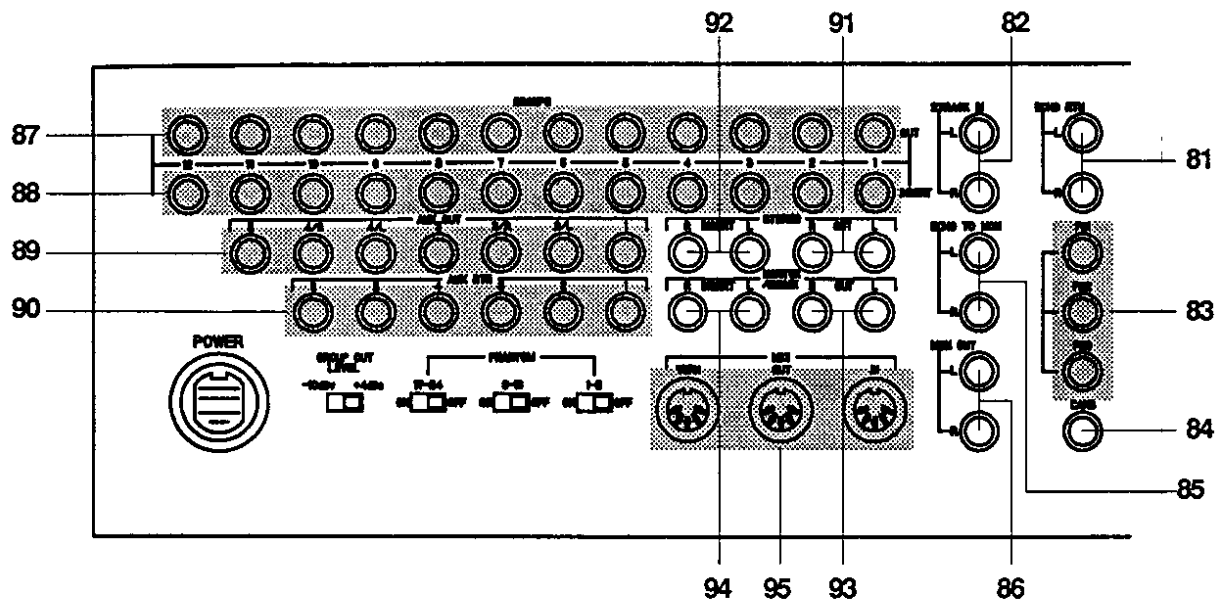

81. Monitor/Submix Echo [ECHO RTN L/R]

These 1/4 inch stereo phone jacks are the echo return jacks.

82. Tow Track Input [2 TRACK IN L/R]

This input is for the two track stereo input. Use this input when connecting a master recorder.

83. Foldback Output [FB1, FB2, FB3]

The foldback signal is output here. This is a pseudo balanced circuit. Connect an amplifier and speaker here for foldback monitor.

84. Head Phone Signal Output [CANS]

Plug in a 1/4 inch stereo phone jack here for headphone signal. The tip of the jack is left while the ring is right.

< NOTE >

This output is the same as the headphone jack on the bar graph pod.

85. Monitor Echo [ECHO TO MON L/R]

Plug in here for monitor echo. Normally, this is used to plug in an effector for the monitor circuit.

86. Monitor Output [MON OUT L/R]

The monitor signal is output here. Connect an amplifier here for control room monitoring.

87, 88. Groups Output/Insert Jack [GROUPS OUT 1-12]

This section is the main output of the console. Connect the 2412 to the recorder here. Use the INSERT jack to introduce sound effectors/processors into the signal chain for that particular channel. The group output jacks are pseudo balanced.

89. AUX Output [AUX OUT 1, 2L/R, 3, 4L/R, 5]

Auxiliary is output here. The jacks are 1, 2L, 2R, 3, 4L, 4R, 5.

90. AUX Return [AUX RTN 1~6]

Auxiliary returns, numbered 1 thru 6, are located here. In normal practice, aux return is connected in parallel to outputs of a MIDI sound or effectors module.

91, 92. Stereo Output/Insert Jack [STEREO OUT L/R]

Stereo output is here. The jacks include stereo L and R in addition to INSERT L and R.

93, 94. Monitor Submix Output/Insert Jack

[MONITOR/SUBMIX OUT L/R]

The monitor/submix signal is output here. Stereo L- R, as well as, inserts L and R are located here.

95. MIDI Connection [MIDI IN/OUT/THRU]

This is the MIDI connection to the console. Settings are IN, OUT, and THRU. Please refer to "MIDI interface" for more details.

96. Phantom Switch [PHANTOM 1-8, 9-16, 17-24 ON/OFF]

Phantom power is switchable in groups of eight. The phantom switch LED [47] on the stereo master module will light.

97. Group Output Level [GROUP OUT LEVEL +4dBu/-10dBV]

Group out has two nominal output levels controlled by a sliding switch. One level is -10dBV while the other is +4dBu.

98. Power Connector [POWER]

This is the power connection for the console. Please do not disconnect this cord while the power is on, as damage to the board or electrical shock may result. It is IMPORTANT to pull the securing ring back before attempting to remove the power cord. Also, it is IMPORTANT to use only a Fostex power supply that has been specifically made for the 2412. If you are in need of a different input rated power supply, i.e., you have moved to a country with different public utility electric values, contact your nearest Fostex dealer to

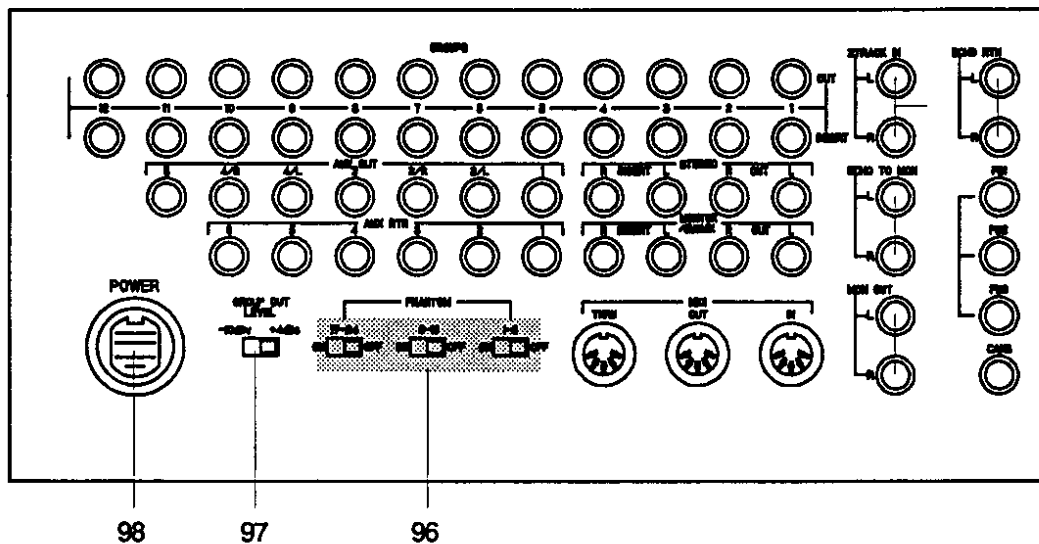

Section VII. Basic Signal Flow

In general, the basic signal flow of the sound signal during multitrack recording can be separated into two routes.

**ROUTE 1: RECORDING THE INPUT SOUND SOURCES
ON A MULTITRACK RECORDER.**

**ROUTE 2: MONITORING THE OUTPUT SIGNAL OF A
MULTITRACK RECORDER WHILE RECORDING.**

To illustrate this, we will assume that you are recording a live situation with an 2412 and a Fostex G24S. Please refer to the following illustration.

ROUTE 1: The input signal from the various instruments and microphones is sent to the input faders via the input selector, then assigned to group busses by the assign switches and pan knobs. Then the overall level is adjusted by the group master faders and finally the signal is output to the G24S via the group out jacks.

ROUTE 2: The output signals of the G24S are sent to tape input. Then, according to the balance setting of aux pan, they are sent to aux buss (L,R). The combined signals are level adjusted with the aux master level knob and/or the cans level knob. By adjusting these levels, monitoring of the recording process is possible.

< **NOTE** > These two signal paths are separate and distinct. Almost all console problems are inevitably the result of confusing these two functions. If you experience loss of signal, ground loops, feed back or other potential problems in signal flow, please consider the above.

Basic Signal Flow For Multitrack Recording

There are two signal paths routed through the 2412. Signal path one sends the sound signal through the console and to a multitrack recorder. Signal path two is the signal from the recorder being monitored via the console. The 2412 console can perform these two functions simultaneously. These are two separate and distinct sources. If these sources are confused, unwanted feedback, loss of signal, and etc. will result.

Route 1: Recording the input sound sources on a multitrack recorder.

- In the diagram, the 2412 console is connected to a Fostex G24S and two sound effectors.
 - The signal is from a microphone via the mic input. The mic/line switch is set to "mic". Input level is controlled by gain A. There is no insert connection.
 - The signal is next sent to the A/B selector (A is Chosen). The signal then goes to the input fader. The signal is adjusted at the fader and then sent to the mute switch. If the mute switch is off, the signal goes to the stereo assignment pan pot. After that, the signal goes to the assignment switch.
 - After the position has been assigned, the signal goes to the group 1-12 buss. From there, it is sent via the group insert to the group master fader. This output, 1 to 12, is hard wired to tracks 1 to 12 of the G24S. Please note that the G24S has parallel input connections 1 to 12 and 13 to 24. In other words, track 1 is connected to 13, track 2 to 14, track 3 to 15, etc.
- < NOTE > The foldback 2 signal is also effected by the input A/B selector. For purpose of simplicity, this block diagram does not show this.
- Aux 3, Aux 4, and L-R buss go to the Aux Out via the Aux 3 and Aux 4 master controls. These signals are sent to the effectors and then returned via the Aux 1-4 jacks. This signal is assigned by the stereo pan pot and stereo assignment switch. The signal is then sent to the mix group 1-12 group buss.

Route 1: Recording the input sound sources on a multitrack recorder.

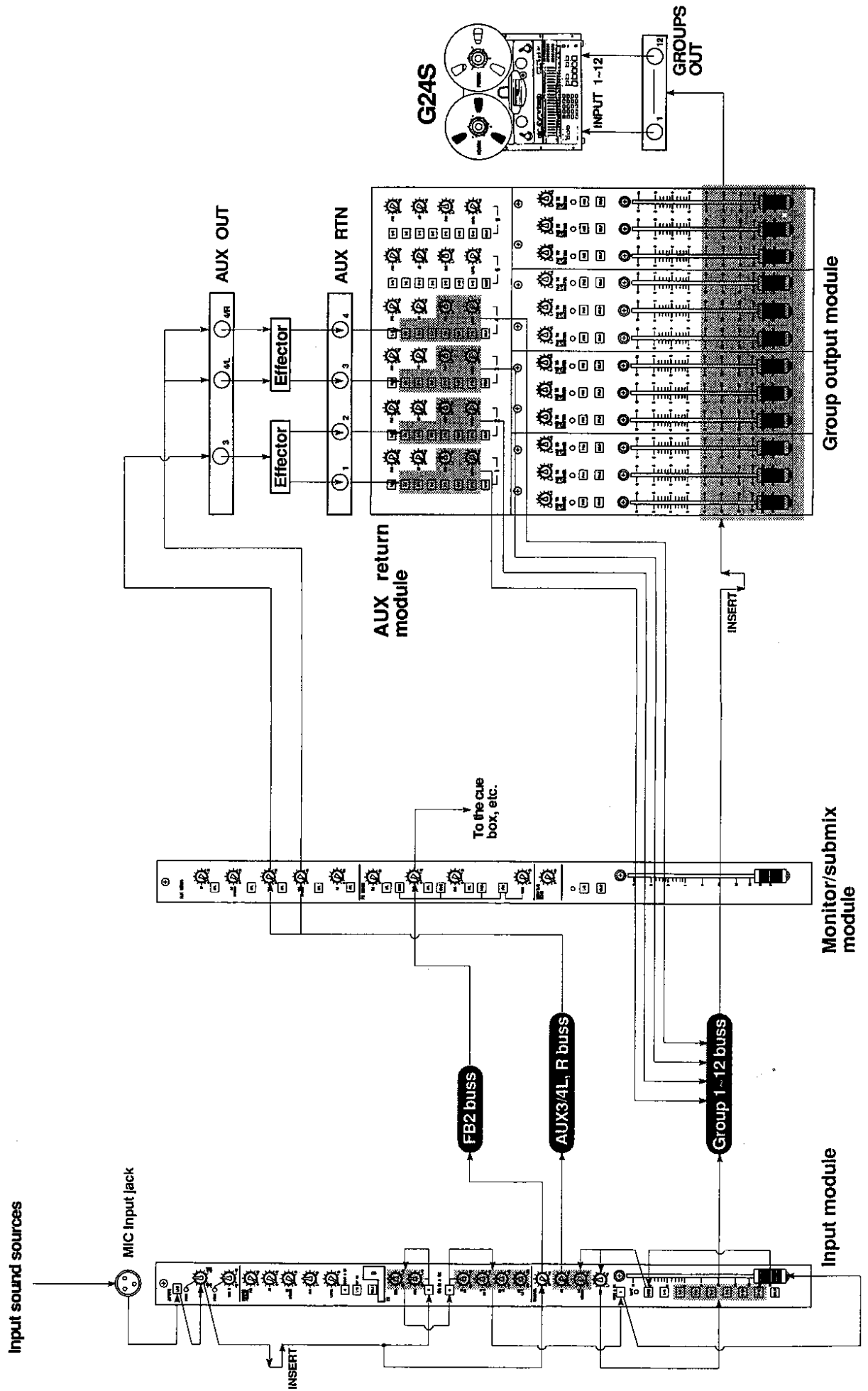

Route 2: Monitoring the output signal of a multitrack recorder while recording.

- The signal from the recorder is sent to the input jacks of the 2412.
- This signal is controlled by the input B control.
- The signal then goes to the shelving EQ A/B selector via the tape insert jacks (nothing inserted). Position A is selected. Because the input signal is routed through the EQ section, the monitored signal from the recorder bypasses this section, as well as, the parametric EQ section. The signal is sent to FB 1, FB 1 master, and the FB 1 jack before the EQ section. FB 1 is for the musician's monitor.
- After bypassing the EQ section, the signal goes to the monitor/submix A/B selector. In this example, B position has been selected. The signal then goes to the monitor/submix level control.

Route 2: Monitoring the output signal of a multi-track recorder while recording.

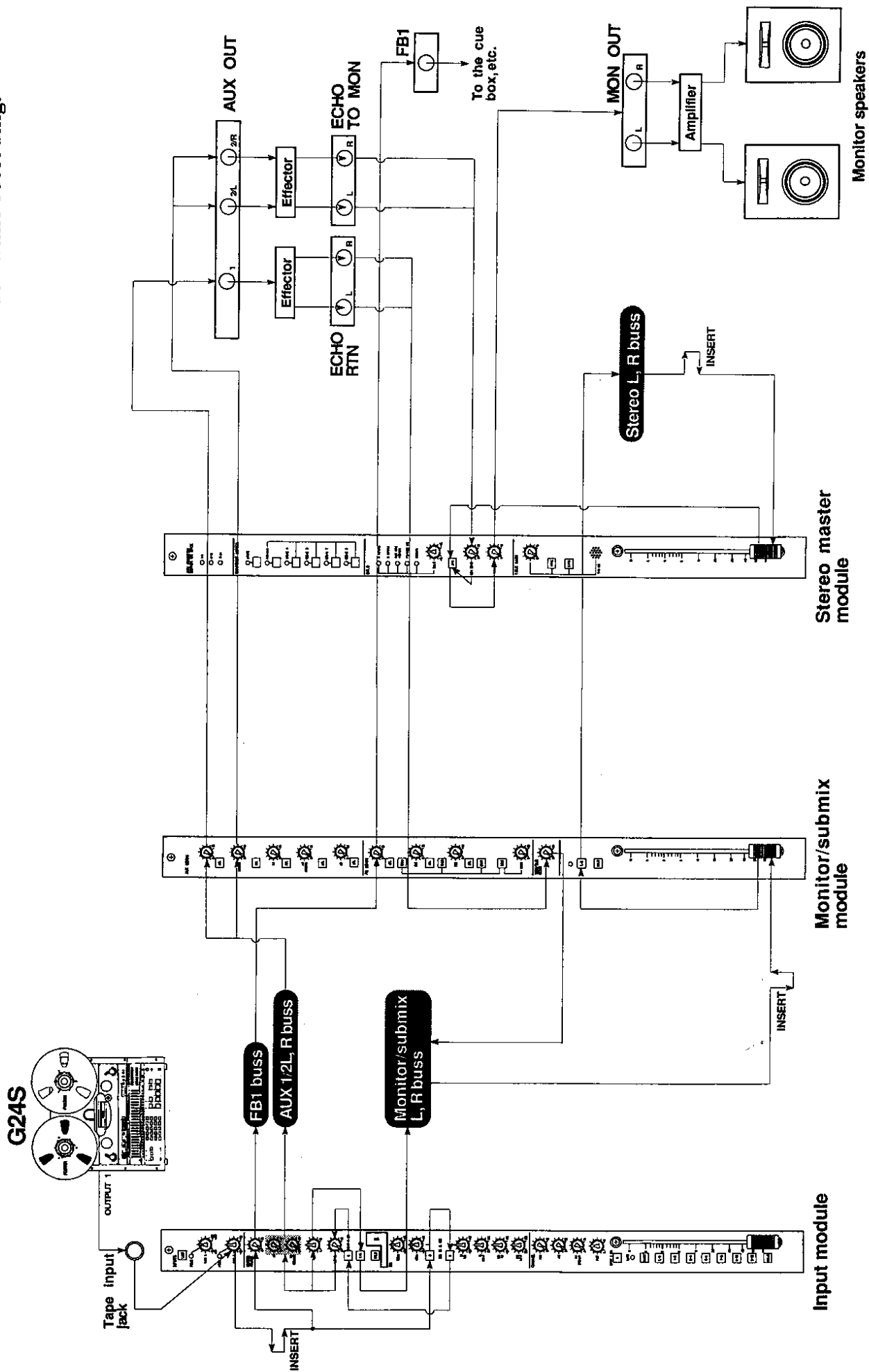

Section VIII. Application

The following information should help in understanding the many different functions the 2412 performs. We have tried to cover as many different aspects as possible. However, every situation is unique and you may have to use this information as a basis for your own needs.

Application Examples

We hope that the preceding sections have been helpful to you in explaining the many functions of the 2412. The following section gives examples of how the 2412 may be connected to other equipment. Every application of the 2412 will be different. However, by examining these examples, it is hoped that the use of the 2412 for basic procedures will be clarified.

Multitrack Recording

The following diagram illustrates one of the basic configurations when using the 2412 for multitrack recording situations. Please use this chart when deciding future configurations with your peripheral equipment.

1. Original Recording Section

This section will describe multitrack recording with the G24S.

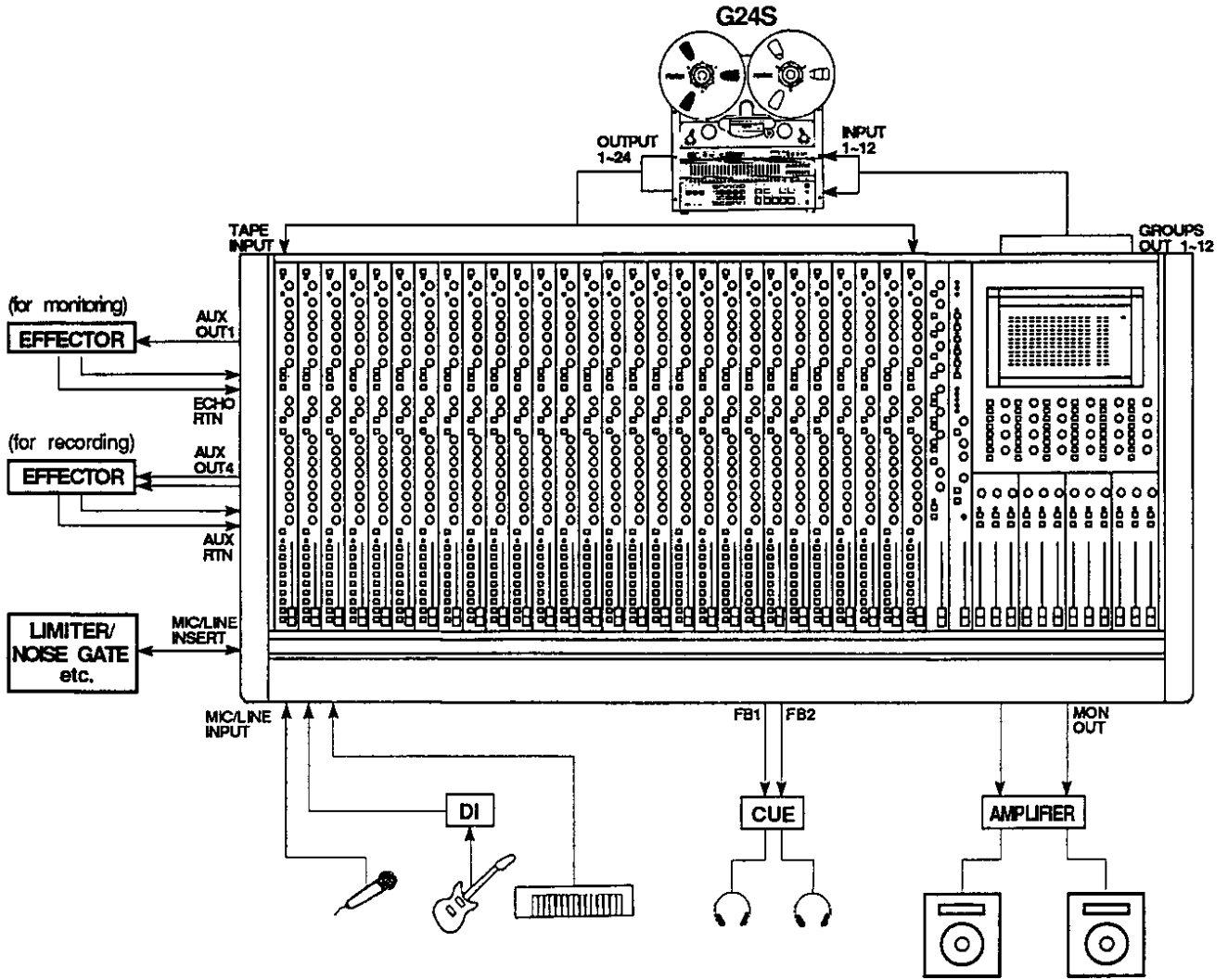

- Step 1. Rhythm Section.
- Step 2. Microphone, keyboard signal, bass guitar through a direct box. This recording is done via input section assignment to the group fader to the G24S tracks.
- At this time a decision about the use of phantom power must be made. If you are using condenser microphones, then phantom power must be used. Otherwise, there is no need to use this option.
- The electric guitar and bass may be plugged into a microphone input. If these instruments are to be plugged into the console, we recommend the use of a direct box for impedance matching. If necessary, a limiter can be introduced into the recording chain at the MIC/LINE insert jack.
- When recording drums in a multi-microphone situation, we recommend the use of a noise gate to prevent unwanted masking of the recorded sound as well as to reduce "booming" from drum heads.
- The signal from the G24S is connected to the MON/SUBMIX section. You can monitor this signal from the monitor jack via the MON/SUBMIX master fader. To monitor the effect sound, use the Monitor/Submix Echo jack. Effect volume is controlled by the MON/SUBMIX Echo Level control.
- Effector output for recording signal is found at the aux return jack to aux return module. This signal is sent to any group buss and then to the G24S.
- For musicians monitoring, use Fold Back volume 1 and 2. A good monitor sound can be found here.

2. Overdubbing

Overdubbing, the process of recording new material with that previously recorded, is possible using the 2412 and a G24S. You can monitor the playback signal from the G24S during RECORD mode. This signal can be monitored via the MON/SUBMIX section.

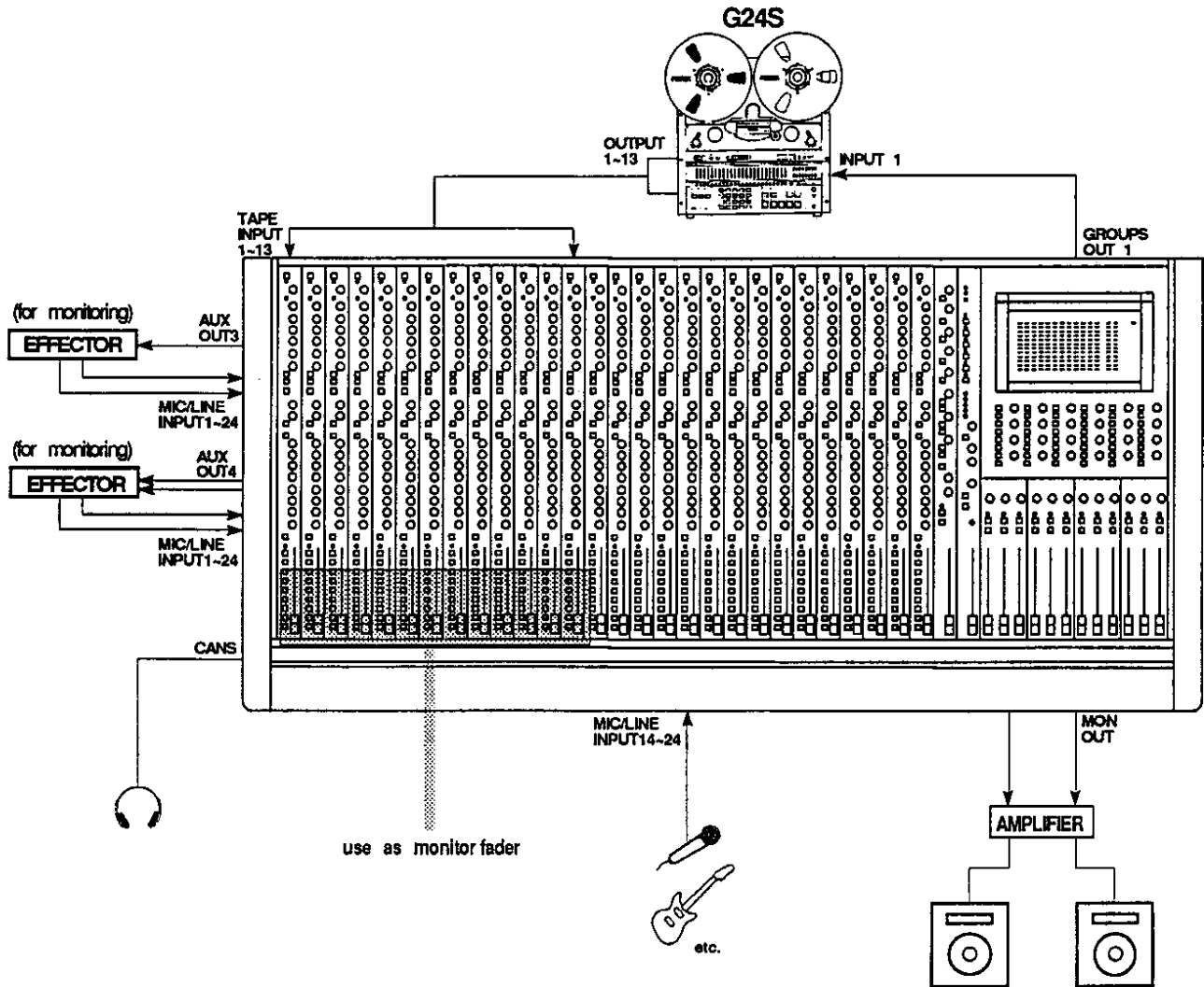

During any overdubbing, the monitor should be set similar to a mixdown, i.e., a good mix.

The following is a good practice when overdubbing.

Example: Tracks 1-12 are recorded. Track 13 will be used for overdubbing.

- A sound source is applied to 14-24 inputs, MIC or LINE. These signal groups go to group master fader 1. Then this signal is sent to track 13.
- Tracks 1-12 playback and the track 13 recorded signal are mixed and sent to the stereo buss L-R. This combined output is sent to monitor out.
- Effect output of monitor can be connected to any channel.

3. Mixdown

- Effect output of monitor can be connected to any channel.

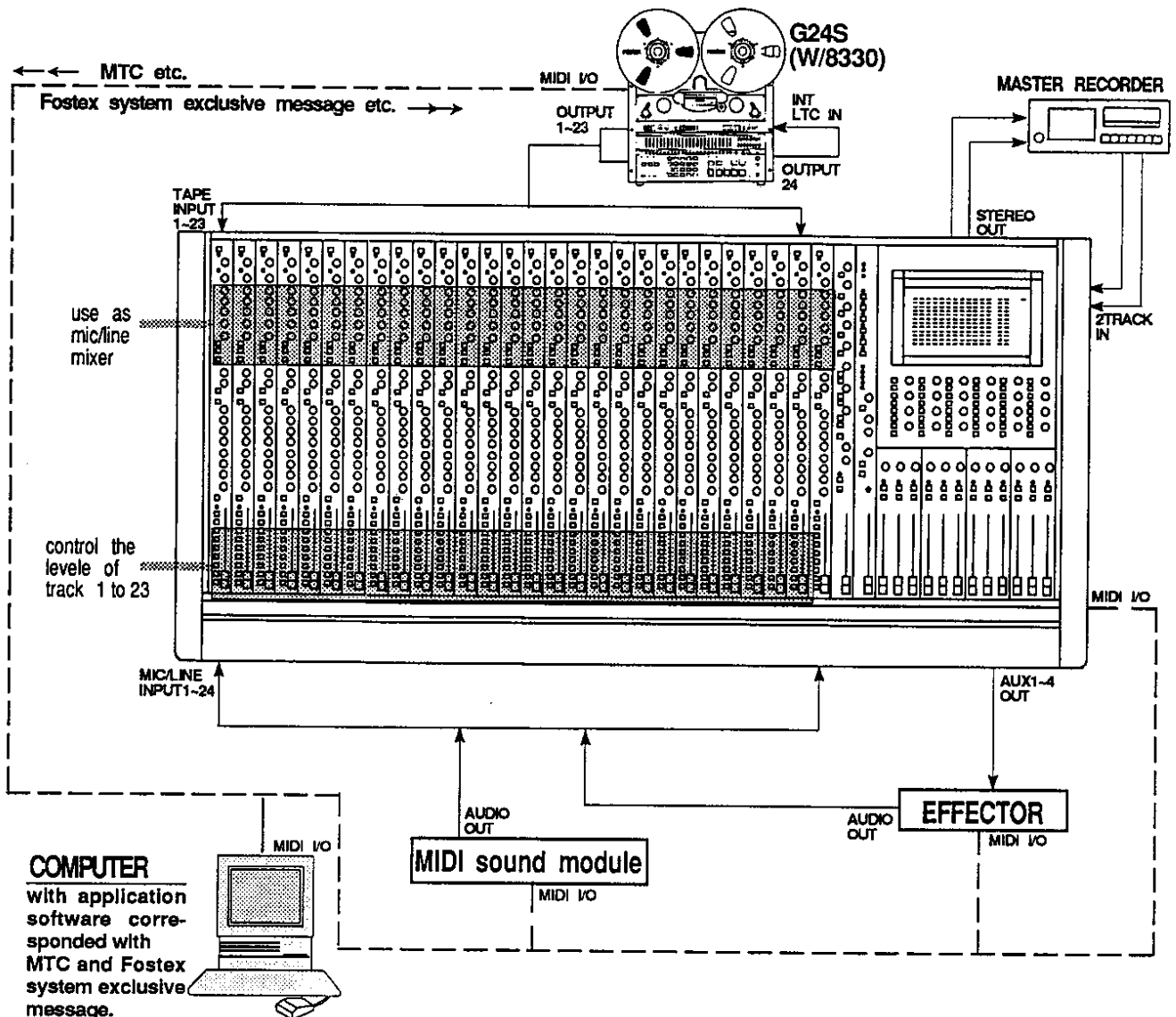

Every track of the G24S signal goes to the input fader and is then mixed with the other input signals.

- If the G24S has an 8330 synchronizer card installed, TC mute on/off can be controlled by a MIDI signal from a computer control.
- Tracks 1-23 are assigned via the L-R buss.

Alternate Method

In this method, the signal is sent to the group Master fader. It is possible to group these signals. Next, assign these signals to the master fader via the L-R pan pot.

< NOTE >

When a MIDI signal generator output is connected to the MIC/LINE input jack, this signal is sent to the MON/SUBMIX section and is then assigned to the stereo L-R buss.

Section IX. Specifications

MIC INPUT (X24)	Mic Impedance	3k Ω or less
	Input Impedance	13k Ω balanced, XLR type
	Level (nominal)	-70dBV to -20dBV
	(minimum)	-80dBV
	(maximum)	+8dBV
LINE INPUT (X24)	Impedance	20k Ω stereo phone jack, bal.
	Level (nominal)	-45dBV to +5dBV
	(minimum)	-55dBV
	(maximum)	+33dBV
TAPE INPUT (X24)	Impedance	20k Ω stereo phone jack, bal
	Level (nominal)	-8dBu to +16dBu
	(minimum)	-18dBu
	(maximum)	+32dBu
INSERT SEND (X24)	Load Impedance	10k Ω or high, phone jack
	Output Level	-10dBV (0.3V)
	(maximum)	+18dBV
INSERT RCV (X24)	Impedance	10k Ω , phone jack
	Level (nominal)	-10dBV (0.3V)
GROUP OUTPUT (X12)	Load Impedance	10k Ω or high, phone jack
	Output Level	+4dBu/-10dBV (0.3V) switchable
	(maximum)	+20dBu/+18dBV
STEREO OUTPUT (L, R) Monitor Submix Output (L, R) FB (Mono X3) AUX OUTPUT (Mono X3, L, R X2)	Load Impedance	10k Ω or high, phone jack
	Output Level	+4dBu
	(maximum)	+20dBu
MONITOR OUT (L, R)	Load Impedance	10k Ω or high, phone jack
	Output Level	+4dBu
	(maximum)	+20dBu
HEADPHONE OUT (L, R)	Load Impedance	8~50 Ω ,stereo phone jack
	Max Output Level	500mW
AUX RETURN (X6) 2 TRACK INPUT (L, R)	Input Impedance	20k Ω bal., stereo phone jack
	Level (nominal)	+4dBu
ECHO RETURN (L, R) ECHO TO MON (L, R)	Input Impedance	20k Ω unbal., stereo phone jack
	Level (nominal)	+4dBu

EQUALIZER	Sweep	60 to 1.2kHz \pm 15dB 1kHz to 16kHz \pm 15dB
	Shelving	11kHz \pm 15dB 45Hz \pm 15dB
FREQUENCY RESPONSE	Mic. Input	20~20kHz +1/-2dB
	Line Input	20~20kHz +1/-1.5dB
	Headphone Out	20~20kHz +1/-3dB
EQUIVALENT INPUT NOISE	-128dBV unwt'd./-130dBV wtd. (IEC/ANSI)	
T.H.D	Group Out	0.05% (at 1kHz, nominal level)
	Headphone Out	0.1% (at 1kHz, 10mW/50 Ω)
CROSSTALK	better than 80dB (at 1kHz)	
POWER REQUIREMENTS	120V/60Hz, 95W	
	220/240V/50Hz, 95W	
PHYSICAL DIMENSIONS	Model 2412:	1108(W) X 582(D) X 203(H)
	Power supply unit:	122(W) X 231(D) X 93(H)
WEIGHT (net)	Model 2412:	25kg
	Power supply unit:	5kg
PHANTOM POWER	DC48V	

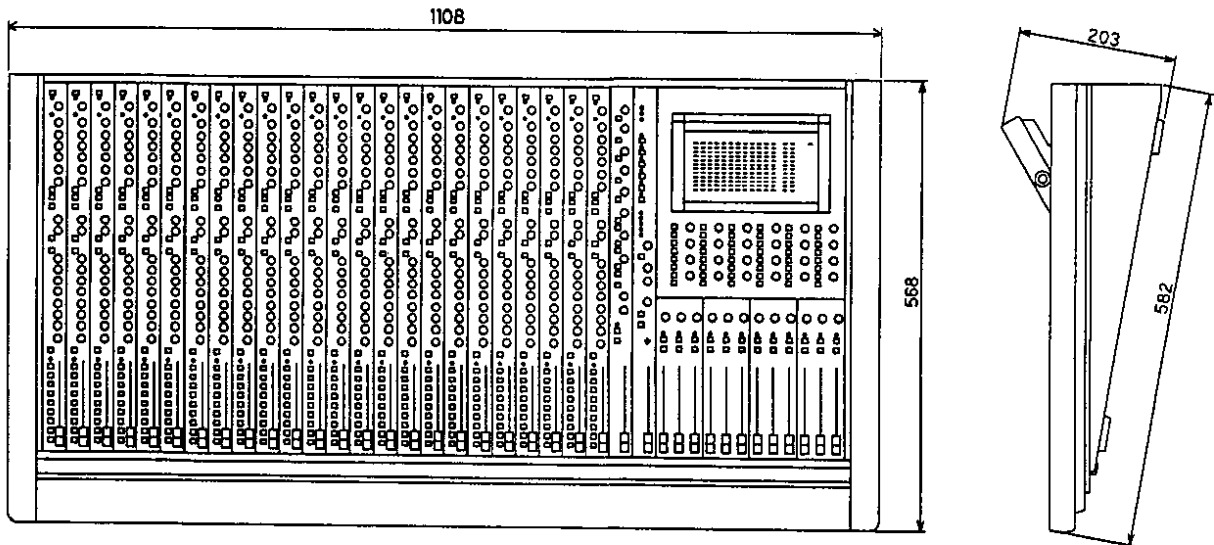

BLOCK DIAGRAMS

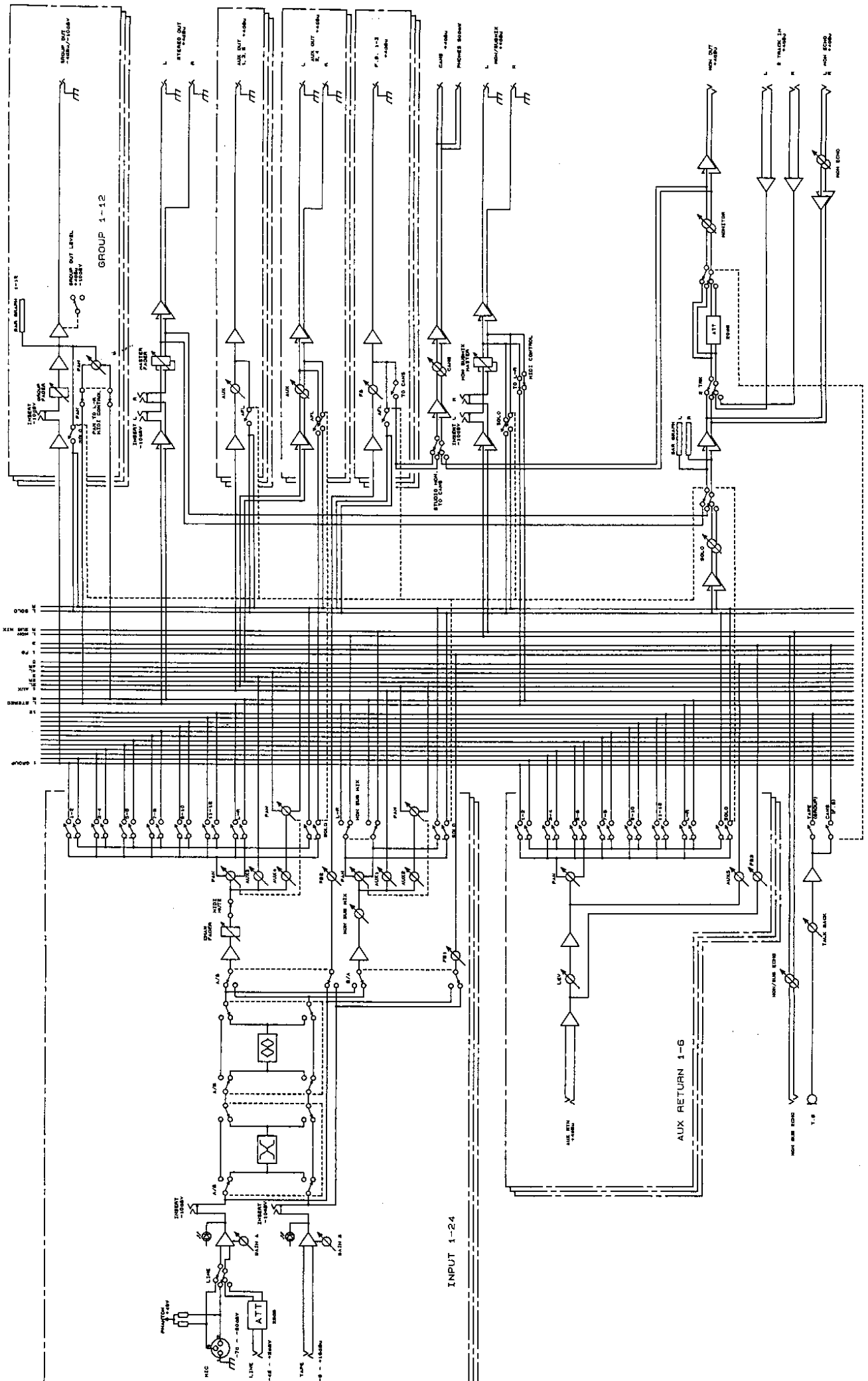

Appendix: MIDI Interface

Table of Contents	<p>The 2412 MIDI interface..... 2</p> <p>Setting up a MIDI channel..... 2</p> <p>Recall and clear the mute pattern by PROGRAM CHANGE..... 3</p> <p>Setting the MUTE, L-R, PAN switches to ON/OFF 3</p> <p>Initializing procedure</p> <p style="padding-left: 40px;">Selecting the kind of MIDI message..... 3</p> <p style="padding-left: 40px;">Selecting the NOTE message..... 4</p> <p style="padding-left: 40px;">Selecting the CONTROL CHANGE message..... 4</p> <p>Operation</p> <p style="padding-left: 40px;">Controlling the 2412 from the MIDI keyboard 6</p> <p style="padding-left: 40px;">Automation by MIDI sequencer 8</p> <p style="padding-left: 80px;">When selecting the NOTE message..... 8</p> <p style="padding-left: 80px;">When selecting the CONTROL CHANGE message..... 9</p> <p>Storing the memory by MIDI..... 11</p> <p>About the other MIDI messages..... 11</p>
--------------------------	--

Introduction

The 2412 can be MIDI controlled. Mute switches, scene memories, and muting can be controlled by a MIDI keyboard or sequencer. When using a MIDI sequencer synchronized to a recorder, the mute switches on the 2412 may be synchronized as well. This is an excellent feature during mixdown operations when rapid and varied muting sequences are required. The MIDI controls may be programmed allowing you to sequence the mutes accurately in real time. While these procedures may initially seem complex, with a little practice they are very easy. Please use the following information to set up the 2412 for MIDI control operations.

The 2412 MIDI interface

The 2412 has various MIDI functions. It can:

- receive a PROGRAM CHANGE, and change snap shot patterns.
- receive a NOTE ON/OFF or the CONTROL CHANGE message, change muting ON or OFF, and control the L-R, PAN switches.
- receive a CONTROL CHANGE message and automatically store the status of the mute, L-R, PAN switches to scenes A through D memory.

Setting up a MIDI channel

The 2412 uses the mute switch of the input module for setting the MIDI channel. To set the MIDI channel for either transmitting or receiving, while pressing the mute switch of the channel that you wish to set, turn the power on. This process will set the MIDI channel.

<Input module channel 5>

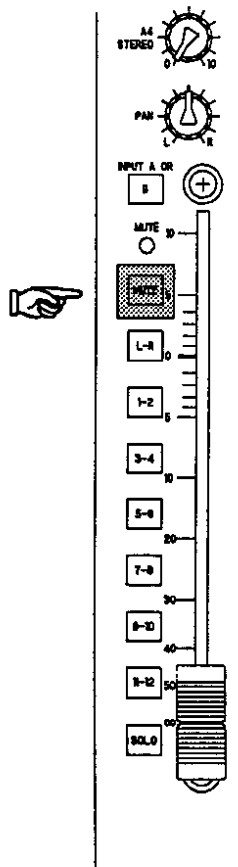

<Input module channel 5>

Example: Setting the MIDI channel to "five".

While pressing the mute switch of channel five, turn the power on.

<NOTES>

- If the power is turned on without pressing a mute switch, the MIDI channel will automatically be set to 1.
- When pressing multiple switches, the MIDI channel is assigned to the smallest number.
- When initially turning on the power, the 2412 will be in the OMNI "OFF" mode. In the OMNI "OFF" mode, the 2412 receives only one set channel MIDI message. After receiving an OMNI "ON" message, the 2412 will enter the OMNI "ON" mode. In the OMNI "ON" mode, the 2412 can receive "all channel" MIDI messages.

Recall and clear the mute pattern by PROGRAM CHANGE

By sending a PROGRAM CHANGE message to the MIDI IN connector, the 2412 can recall snapshot patterns stored in memory scenes A through D. Programs number one through four are each applied to scenes A through D. Applying program number zero will clear the recalled memory.

Program change byte composition of program number "3".

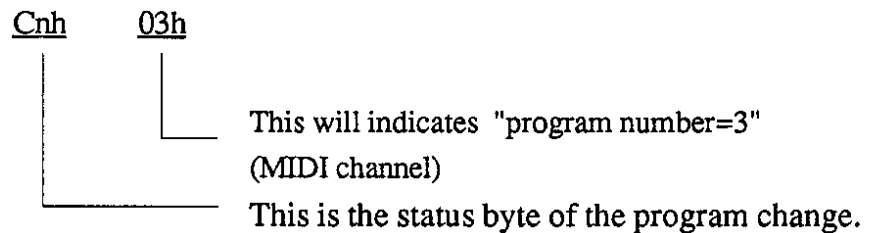

- * Each byte "h" indicates the hexadecimal.
- * Please refer to the specific MIDI equipment manual for further information.

< NOTE >

Scene A, when assigned to program number "1", is not "0". Pressing the scene keys recalls the memories and outputs the program change messages of the program number that is applied to the scene memory from the MIDI OUT connector (when the store and preview indicators are extinguished). Pressing the STORE and PREVIEW buttons clears the recalled memory and outputs the program change messages.

Setting the MUTE, L-R, PAN switches to ON/OFF

Initializing Procedure

Selecting the kind of MIDI message

When controlling MUTE, L-R, and PAN switches by MIDI messages, the 2412 may be switched to either NOTE ON/OFF or CONTROL CHANGE.

< NOTE >

When turning on the power, the 2412 automatically enters the NOTE ON/OFF message mode. If you are using NOTE ON/OFF messages only, the following operations are not necessary.

Selecting the NOTE message

When assigning NOTE message mode control, transmit the CONTROL CHANGE message to the 2412 as follows:

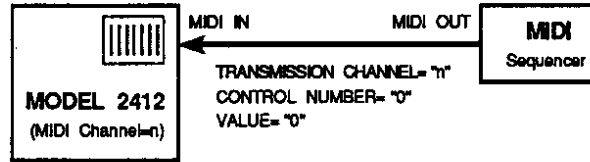

Byte composition of CONTROL CHANGE message

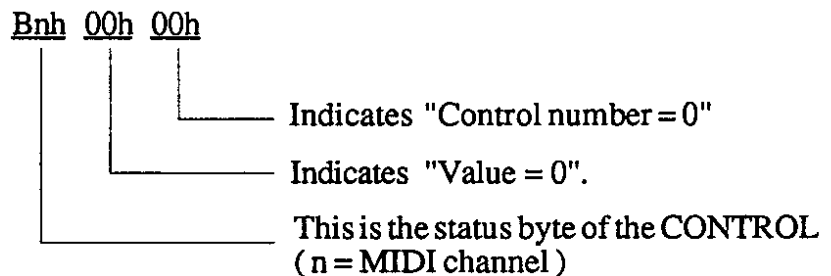

- * Each byte "h" indicates the hexadecimal.
- * Please refer to the specific MIDI equipment manual for the writing and transmitting of CONTROL CHANGE messages.

Example 1: When setting the 2412 MIDI channel to "8":
Transmit to the 2412 **"B7h 00h 00h"**.

Example 2: When setting the 2412 MIDI channel to "12":
Transmit to the 2412 **"BBh 00h 00h"**.

Selecting the CONTROL CHANGE message

When assigning the control mode with the CONTROL CHANGE message, transmit the CONTROL CHANGE message as follows to the 2412.

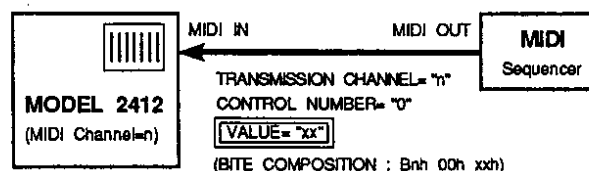

< NOTE >

The "xx" range of the 2412 MIDI commands is 19h to 60h (decimal: 25 to 96). Please stay within this range when setting MIDI commands with the 2412.

The relationship between the "xx" values and the 2412 switches shows as follows.

"yy" works as follows: 00h is switch "OFF", except when 00h is assigned to switch "ON".

Control number to be transmitted for the switch ON/OFF in the control change message	XX	XX + 1	→	XX + 23	XX - 24	XX - 19	XX - 18	→	XX - 8
Switch names	MUTE switch of channel 1	Muteswitch of channel 2	→	MUTE switch of channel 24	L-R assign switch (MON/SUB module)	PAN switch of Group 1 (Group module)	PAN switch of Group 2 (Group module)	→	PAN switch of Group 12 (Group module)

Example 1: When transmitting "xx = 20h (value = 32)" to the 2412.

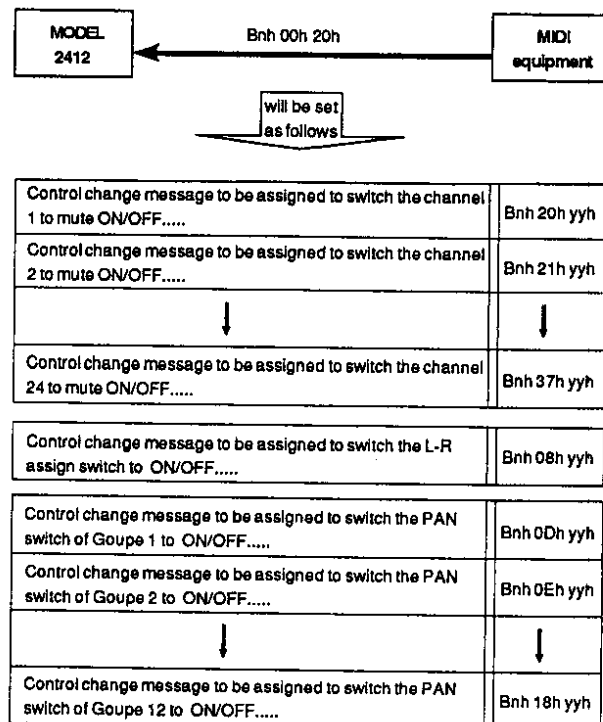

Example 2: When the control number "25" (hexadecimal: 19h) is assigned to channel 1 mute switch, the same as, "26" is channel 2,, "48" is channel 24, transmit **B5h 00h 19h** to the 2412. At the same time, control number "1" will be assigned to the L-R assign switch, and "6" ~ "17" to group 1 to 12 PAN switches.

Operation

Controlling the 2412 from a MIDI keyboard

At power ON, the default setting of the 2412 is NOTE message. The following is the simplest operation using the keyboard. It is not necessary to assign a MIDI message.

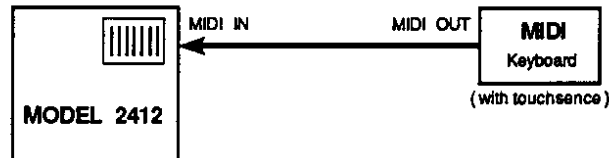

1. After checking that power is off to the 2412 and MIDI keyboard, connect the MIDI cables as shown in Figure 6, Turn the keyboard on, then the 2412. Match the MIDI channel of both the keyboard and the 2412. Please refer to "Setting the MIDI channel" for details.
2. Press the middle "C" key (equals note number: 60) on the keyboard firmly. Channel 1 of the 2412 will be mute "ON".
3. Next, press the same key softly, Channel 1 will be mute "OFF".
4. In the same manner, push the "B" key one octave up; channel 24 will be changed to mute on/off.

When controlling the 2412 with note messages, each channel is controlled by a note and is operated by how hard the operator presses the key, i.e., firmly for "ON" and lightly for "OFF".

Byte composition of NOTE ON message

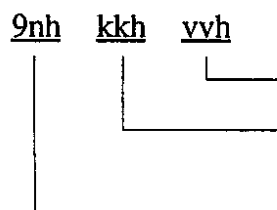

velocity

note number

This is the status byte of the NOTE ON message.

(n = MIDI channel)

* Each byte "h" is indicated the hexadecimal.

Note number The 2412 presets the note number "60" (center C) to channel 1 MUTE switch, "61" to channel 2....., up to "83" for channel 24. Also, note numbers "41" through "52" are assigned to group 1 to 12 PAN switches, as well as "36" to the L-R assign switch. These default parameters can not be changed.

Velocity NOTE ON with a velocity range 01h to 3Fh (decimal: 1 to 63) is assigned to switch "OFF". Conversely, NOTE ON with the velocity range 40h to 7Fh (decimal: 64 to 127) is assigned to switch "ON".

NOTE OFF NOTE OFF** has no meanings to the 2412. However, the MIDI standard is standardized as follows:

"NOTE ON and NOTE OFF must be used as a pair."

** This means NOTE OFF has status byte "8nh" and/or NOTE ON that has a velocity equal to 00h (decimal: 0).

When transmitting a NOTE ON message to the 2412, please transmit a NOTE OFF message with the same note number at the same time.

Example: when assigning channel 4 mute to "ON", transmit to the 2412:

"96h 3Fh 7Fh 86h 3Fh 40h"

or "96h 3Fh 7Fh 96h 3Fh 00h"

The following shows the relationship between note number and switches, and also between velocity and switch ON/OFF.

Receiving note number		Switch number	Receiving velocity	
hexadecimal	decimal		01h-3Fh(hexadecimal) 1-63(decimal)	40h-7Fh(hexadecimal) 64-127(decimal)
3Ch	60	Channel 1 MUTE switch	OFF	ON
3Dh	61	Channel 2 MUTE switch	OFF	ON
3Eh	62	Channel 3 MUTE switch	OFF	ON
↓	↓	↓	↓	↓
53h	83	Channel 24 MUTE switch	OFF	ON
29h	41	Group 1 PAN switch		
↓	↓	↓		
34h	52	Group 12 PAN switch		
24h	36	L-Assign switch	OFF	ON

Automation by MIDI sequencer

The 2412 switch control is done automatically by using a MIDI sequencer as follows:

Connecting

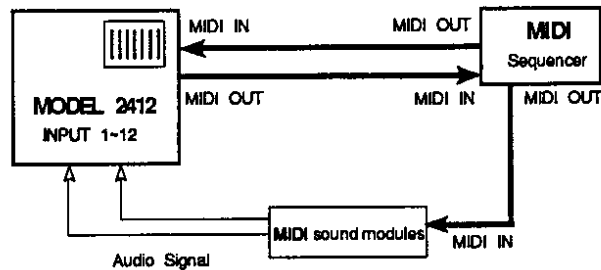

When selecting the Note messages

When selecting the NOTE message mode, changing ON to OFF or OFF to ON by pressing the 2412's switch, NOTE ON messages will be output from the 2412 MIDI OUT connector only when the PREVIEW indicator is turned off. The note number is applied to that switch. When switching to OFF, the NOTE message will be output with velocity "01h". When switching ON, the NOTE message will be output with velocity "7Fh".

Example 1: When pressing the mute switch of channel 2 and muting is canceled. `90h 3Dh 01h` will be transmitted from the MIDI OUT connector.

Example 2: When pressing the mute switch of channel 1, muting is executed. `9Bh 3Ch 7Fh` is transmitted from the MIDI OUT connector.

Channels 1 to 24 muting is controlled by the keyboard. To turn muting "ON", press the key firmly (fortissimo) Conversely, to turn the muting "OFF" press the respective control key softly (pianissimo). This information is transmitted from the MIDI OUT connector and is recorded by the sequencer and played back. The following procedure is for setting up automation sequences:

1. Connect the 2412 and MIDI sequencer, MIDI sources as shown below.

2. Initialize the MIDI sequencer. Details are....., Set the MIDI sequencer to record the NOTE message that the 2412 outputs, and assign the recording MIDI track, etc.
3. Playback another track (recorded information), or playback a multitrack recorder that is synchronized to the MIDI sequencer, and monitor the outputs. Finally, input something to the 2412 and check the mute on/off application by pressing the mute switches.
4. Start the MIDI sequencer in real time writing mode. Press the mute switch before starting the music and record the mute pattern at the music's starting point. In other words, in real time write, the initial settings of mute status at the beginning of the piece of music. This is very important for "setting up" the following mute pattern status. Otherwise, mute settings from a previous piece of music will be in effect at the start of the new recording/performance.
5. As the music is played, press the mute switch and write the necessary NOTE messages to the sequencer.
6. After you have finished, play back the sequencer to check the mute pattern for correctness.

<NOTE>

The preceding procedure controls the mute switch. The PAN mute and/or MON/SUB TO L-R switches may also be controlled in the same manner.

When selecting the CONTROL CHANGE message

When selecting CONTROL CHANGE, message mode and changing the OFF/ON status, all commands will be output from the 2412 MIDI OUT connector unless the 2412 is in preview mode. When selecting OFF, the CONTROL CHANGE message will be output with the value "00h". When selecting ON, the CONTROL CHANGE message will be output with the value "7fh".

Example 1: While using the CONTROL CHANGE message mode, transmit "B0h, 00h and 20h" to the 2412. When the mute is canceled by pressing the channel 2 mute switch, "B0h, 21h, 00h" is transmitted from the MIDI OUT connector.

When using a CONTROL CHANGE message, channels 1 to 24 mute switches work the same as switches that output the CONTROL CHANGE message with control numbers "xx" to "xx + 23". When entering "ON" by pressing the mute switch, a CONTROL CHANGE message with the value "7Fh" and a control number is transmitted from the MIDI OUT connector. When entering "OFF", the CONTROL CHANGE message with a value "00h" as well as the control number are transmitted. These messages are recorded to the MIDI sequencer and playback. The following is the procedure for automation control of the 2412:

1. Connect the 2412, the MIDI sequencer, and the MIDI sources as below:
2. Initialize the MIDI sequencer. Details are...., Set up the MIDI sequencer to record the control change message that the 2412 outputs, and assign the MIDI track, etc.
3. As with NOTE message check, input something to the 2412 to check if you are correctly turning the mute on and off.
4. Start the MIDI sequencer in real time writing mode. As with the NOTE message mode, be sure to record the initial mute pattern at a point just before the beginning of the recorded material. In addition, when using a CONTROL CHANGE message, record (Bnh 00h xxh) to assign the CONTROL CHANGE message from the previous pattern. This is very important; when you turn the power off and back on again the 2412 will automatically return to the NOTE message mode. In addition, the 2412 will not recognize any value assigned to "xx". Because the 2412 cannot output a CONTROL CHANGE message, (Bnh 00h xxh), please write this with the MIDI sequencer's step write mode, or send it to the sequencer from another piece of MIDI equipment.

5. Use the mute switch to write the CONTROL CHANGE messages to the sequencer as the music is played.

6. Playback the sequencer after performing the above steps and check the mute pattern (changing). Record the CONTROL CHANGE message as either "00h" or "7Fh". When "00h" is received, the 2412 will switch off the mute switch. When receiving "7Fh" the 2412 switches on the mute switch.

<NOTE>

The above described procedure is for the mute switch. However, the same principles apply to the PAN MUTE and/or MON/SUB TO L-R switches.

Storing the memory by MIDI

By sending a CONTROL CHANGE message with the control number "120 (78h)", the 2412 can store the current status of each switch in scenes A through D memory. The values 1 to 4 (01h to 04h) are applied to scenes A to D.

Example: Send a CONTROL CHANGE message with the control number "120 (78h) and the control value "2" to the 2412 (Bnh 78h 02h). The current ON/OFF switch pattern is stored to the Scene B memory.

<NOTE>

Pressing the STORE and SCENE keys stores the memories and outputs the CONTROL CHANGE message from the MIDI OUT connector.

About the other MIDI messages

LOCAL ON/OFF When the 2412 receives a LOCAL OFF message, the mute will not switch on or off even though the mute switch has been pressed. However, this MIDI message will be output. After receiving a LOCAL ON message, the 2412 will reset.

OMNI ON/OFF When the 2412 receives an OMNI ON message, the 2412 will recognize MIDI messages on all MIDI channels. In this mode, press the 2412 switches, and the 2412 will output MIDI messages, transmitting on the currently set MIDI channel. After receiving an OMNI OFF message, the 2412 will reset.

Fostex

FOSTEX CORPORATION

3-2-35 Musashino, Akishima-shi, Tokyo, Japan 196

FOSTEX CORPORATION OF AMERICA

15431, Blackburn Ave., Norwalk, CA 90650, U.S.A.

FOSTEX (UK) LTD.

Unit 1 Jackson Way Great Western Industrial Park Southall Middx UB2 4SA U.K.