

# 233

## True-rms Remote Display Digital Multimeter

PN 3465366

September 2009

© 2009 Fluke Corporation. All rights reserved. Printed in USA. Specifications are subject to change without notice.

All product names are trademarks of their respective companies.

### **LIMITED WARRANTY AND LIMITATION OF LIABILITY**

This Fluke product will be free from defects in material and workmanship for three years from the date of purchase. This warranty does not cover fuses, disposable batteries, or damage from accident, neglect, misuse, alteration, contamination, or abnormal conditions of operation or handling. Resellers are not authorized to extend any other warranty on Fluke's behalf. To obtain service during the warranty period, contact your nearest Fluke authorized service center to obtain return authorization information, then send the product to that Service Center with a description of the problem.

THIS WARRANTY IS YOUR ONLY REMEDY. NO OTHER WARRANTIES, SUCH AS FITNESS FOR A PARTICULAR PURPOSE, ARE EXPRESSED OR IMPLIED. FLUKE IS NOT LIABLE FOR ANY SPECIAL, INDIRECT, INCIDENTAL OR CONSEQUENTIAL DAMAGES OR LOSSES, ARISING FROM ANY CAUSE OR THEORY. Since some states or countries do not allow the exclusion or limitation of an implied warranty or of incidental or consequential damages, this limitation of liability may not apply to you.

Fluke Corporation  
P.O. Box 9090  
Everett, WA 98206-9090  
U.S.A.

Fluke Europe B.V.  
P.O. Box 1186  
5602 BD Eindhoven  
The Netherlands

## ***Introduction***

The Fluke 233 (hereafter the Meter) is a compact and easy to operate tool for electrical and electronic circuit measurements.

### **⚠ ⚠ Warning**

**Read "Safety Information" before you use the Meter.**

## ***How to Contact Fluke***

Use one of the telephone numbers below to speak with a Fluke representative:

Technical Support USA: 1-800-44-FLUKE (1-800-443-5853)

Calibration/Repair USA: 1-888-99-FLUKE (1-888-993-5853)

Canada: 1-800-36-FLUKE (1-800-363-5853)

Europe: +31 402-675-200

Japan: +81-3-3434-0181

Singapore: +65-738-5655

Anywhere in the world: +1-425-446-5500

Or, visit Fluke's website at [www.fluke.com](http://www.fluke.com).

To register your product, visit <http://register.fluke.com>.

To see, print, or download the latest manual supplement, visit <http://us.fluke.com/usen/support/manuals>.

## Safety Information

The Meter complies with:

- ISA-82.02.01
- CAN/CSA C22.2 No. 61010-1-04
- ANSI/UL 61010-1:2004
- EN 61010-1:2001
- EN 61326-1:2006
- EN 61326-2-2:2006
- ETSI EN 300 328 V1.7.1:2006
- ETSI EN 300 489 V1.8.1:2008
- FCC Part 15 Subpart C Sections 15.207, 15.209, 15.249 FCCID: T68-F233
- RSS-210 IC: 6627A-F233
- Measurement Category III, 1000V, Pollution Degree 2
- Measurement Category IV, 600V, Pollution Degree 2

In this manual, a **Warning** identifies the conditions and procedures that cause a dangerous situation to the user. A **Caution** identifies the conditions and procedures that could cause damage to the Meter, equipment under test damage, or permanent data loss.

The symbols used on the Meter and in this manual are shown in Table 1.

### Warning

To prevent possible electrical shock or personal injury, follow these guidelines:

- **Use this Meter only as specified in this manual or the protection can be compromised.**
- **Do not use the Meter if it is damaged. Before you use the Meter, examine the case. Look for cracks or missing plastic. Carefully look at the insulation around the terminals.**
- **Make sure the battery door is closed and locked before you operate the Meter.**
- **Replace the batteries when the battery indicator () appears.**

- Remove the test leads from the Meter before the battery door on the Meter base is opened.
- Examine the test leads for damaged insulation or exposed metal. Measure the test leads for continuity. Replace damaged test leads before you use the Meter.
- Do not apply more than the rated voltage, shown on the Meter, between the terminals or between a terminal and earth ground.
- Do not operate the Meter with the battery door removed or the case open.
- Be careful around voltages >30 V ac rms, 42 V ac peak, or 60 V dc. These voltages pose a shock hazard.
- Use only the replacement fuse specified by the manual.
- Use the correct terminals, function, and range for measurements.
- Do not work alone.
- For current measurements, connect the Meter to the circuit after you remove circuit power. Always put the Meter in series with the circuit.
- Connect the common test lead before the live test lead and remove the live test lead before the common test lead.
- Do not use the Meter if it operates incorrectly. Protection can be compromised. If you are unsure, have the Meter examined.
- Do not use the Meter around explosive gas, vapor or in damp or wet environments.

















- Use only specified 1.5-V AA batteries (three in the Meter base and two in the display), correctly installed, for Meter power.
- Comply with local and national safety requirements when in hazardous locations.
- Only use test leads that have the same voltage, category, and amperage ratings as the Meter and that are approved by a safety Agency.
- Measure a known voltage first to make sure that the Meter operates correctly. If you are unsure, have the Meter examined.
- Use protective equipment, as directed by local or national authorities when in hazardous work areas.
- Measure the test leads for continuity before use. Do not use if the resistance is high or noisy.
- Use only specified replacement parts in the Meter.
- Keep fingers behind the finger guards on the probes.

**⚠ Caution**

To prevent damage to the Meter or to the equipment under test, follow these guidelines:

- Disconnect circuit power and discharge all high-voltage capacitors before you do diode tests or measure resistance, continuity, or capacitance.
- Use the correct terminals, function, and range for all measurements.
- Before a current measurement, do the fuse test.

**Table 1. Electrical Symbols**

|   |   |   |  |
|---|---|---|--|
|  | AC (Alternating Current)  |  | Earth ground   |
|  | DC (Direct Current)   |  | Fuse   |
|  | Hazardous voltage   |  | Conforms to European Union directives.   |
|  | Risk of Danger. Important information.<br>See Manual.   |  | Conforms to relevant Canadian Standards Association directives.  |
|  | Battery. Low battery when shown.  |  | Double insulated   |
|  | Continuity test or continuity beeper tone.  |  | Capacitance  |
| <b>CAT III</b>  | IEC Measurement Category III<br>CAT III equipment has protection against transients in equipment in fixed-equipment installations, such as distribution panels, feeders and short branch circuits, and lighting systems in large buildings. | <b>CAT IV</b>   | IEC Measurement Category IV<br>CAT IV equipment has protection against transients from the primary supply level, such as an electricity meter or an overhead or underground utility service. |
|  | Do not discard this product as unsorted municipal waste. Go to the Fluke website for recycling data.  |  | Diode  |
|  | Examined and licensed by TÜV Product Services.  |  | Conforms to relevant Australian standards.   |

## Features

See Tables 3 through 4 for a list of Meter features with a short feature description.

Table 2. Display

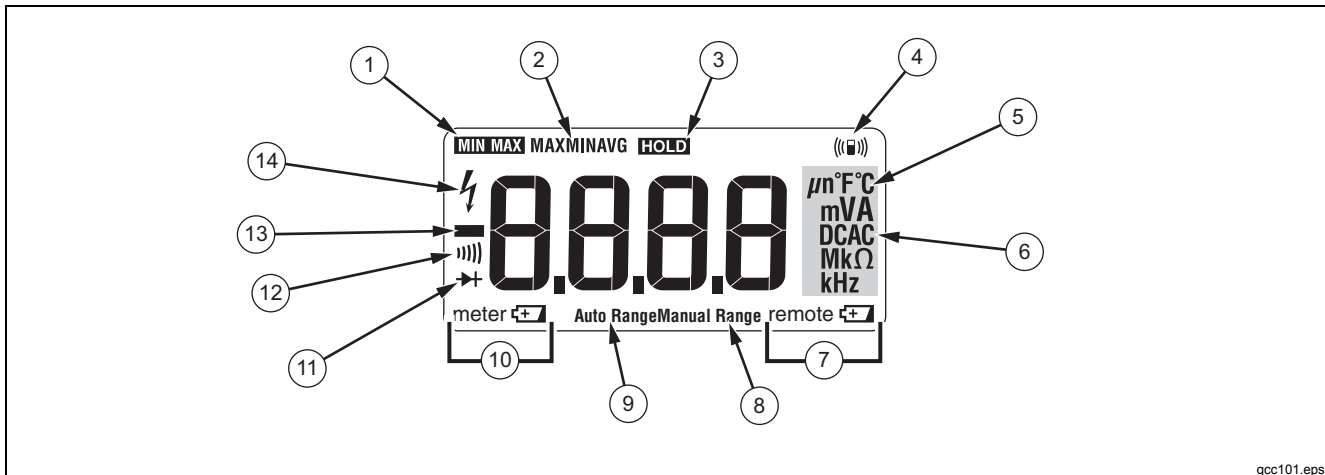

gcc101.eps

| No. | Symbol         | Indication  |
|-----|----------------|---|
| 1   | <b>MIN MAX</b> | MIN MAX AVG mode on.                              |
| 2   | MAX MIN AVG    | Maximum, minimum, or average measurement shown.   |
| 3   | <b>HOLD</b>    | Display hold on. Display freezes the measurement. |



**Table 2. Display (cont.)**







| No. | Symbol   | Indication   |
|-----|--|--|
| 4   | ((□))  | Radio connection indicator.  |
| 5   | °C, °F   | degrees Celsius, degrees Fahrenheit  |
| 6   | <b>A</b>   | amperes (amps)   |
|     | <b>V, mV</b>   | volts, millivolts  |
|     | <b>μF, nF</b>  | microfarad, nanofarad  |
|     | DC AC  | Direct current or alternating current.   |
|     | <b>Ω, MΩ, kΩ</b>   | ohm, megohm, kilohm  |
|     | <b>Hz, kHz</b>   | hertz, kilohertz   |
| 7   | remote  | Battery low warning for the display module.  |
| 8   | Manual Range   | Manual range set.  |
| 9   | Auto Range   | Auto range set.  |
| 10  | meter   | Battery low warning for Meter base.  |
| 11  |         | Diode test mode.   |
| 12  | )))  | Continuity test.   |
| 13  | -  | Input is a negative value.   |
| 14  | ⚡  |  Hazardous voltage. Measured input voltage $\geq 30$ V, or voltage overload condition (OL). For frequency measurements $> 1$ kHz, the ⚡ symbol and high-voltage LED is unspecified. |

Table 3. Inputs

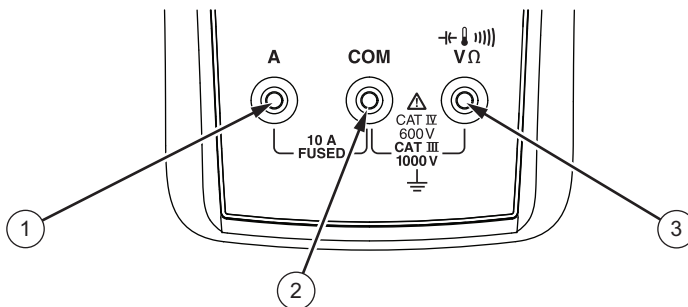

gcc110.eps

| No. | Terminal  | Description   |
|-----|---|---|
| 1   | A   | Input for 0 A to 10.00 A current measurements.  |
| 2   | COM   | Common terminal for all measurements.   |
| 3   | <br>VΩ | Input for voltage, continuity, resistance, diode, capacitance, temperature, and frequency measurements. |

**Table 4. Function Switch Positions**

| Switch Position  | Description   |
|--|---|
| $\tilde{V}_{Hz}$<br><b>Hz (button)</b>   | AC voltage from 0.06 to 1000 V.<br>Frequency from 5 Hz to 50 kHz.   |
| $\overline{V}$   | DC voltage from 0.001 V to 1000 V.  |
| $\overline{mV}$  | AC voltage from 6.0 to 600.0 mV, dc-coupled. DC voltage from 0.1 to 600.0 mV.   |
| $\Omega$   | Ohms from 0.1 $\Omega$ to 40 M $\Omega$ .<br>Continuity beeper turns on at <20 $\Omega$ and turns off at >250 $\Omega$ .  |
| $\overleftarrow{F} \rightarrow$  | Farads from 1 nF to 9999 $\mu$ F.<br>Diode Test. OL shows in the display when the input voltage is >2.0 V.  |
| $\uparrow$   | Temperature.  |
| $\tilde{A}_{Hz}$<br><b>Hz (button)</b>   | AC current from 0.1 A to 10 A (>10 to 20 A, 30 seconds on, 10 minutes off). >10.00 A display flashes.<br>>20 A, <b>OL</b> is shown. DC-coupled.<br>Frequency from 45 Hz to 5 kHz. |
| $\overline{A}$   | DC current from 0.001 A to 10 A (>10 to 20 A, 30 seconds on, 10 minutes off). >10.00 A display flashes.<br>>20 A, <b>OL</b> is shown.   |
| Note: All ac functions are true-rms. AC voltage is ac-coupled. AC mV and ac amps are dc-coupled. |   |

## Error Messages

Table 5 contains possible error messages and the steps to clear the error.

**Table 5. Error Messages**

| <b>Error Messages</b> |  |
|-----------------------|--|
| <b>bAtt d ISP</b>     | Display-module batteries must be replaced before the Meter will operate.             |
| <b>bAtt bASE</b>      | Meter-base batteries must be replaced before the Meter will operate.                 |
| <b>CAL Err</b>        | Calibration necessary. Meter calibration is necessary before the Meter will operate. |
| <b>EEPROM Err</b>     | Internal error. The Meter must be repaired before it will operate.                   |
| <b>rF Err</b>         | Loss of radio connection with the Meter base.  |

**Remote Operation**

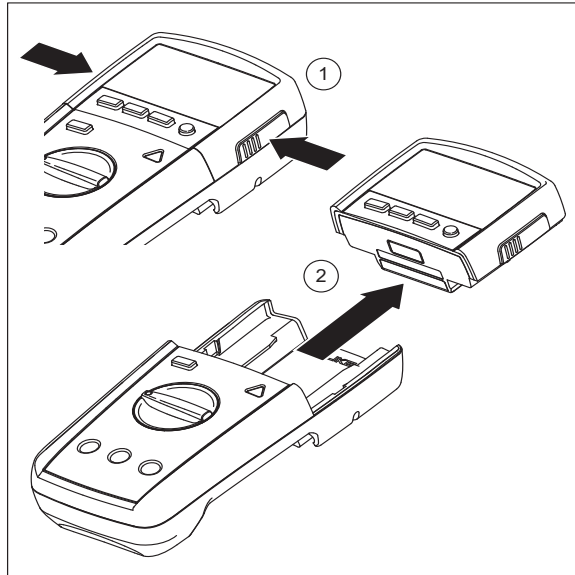

gcc114.eps

**Figure 1. Display Module Separation**

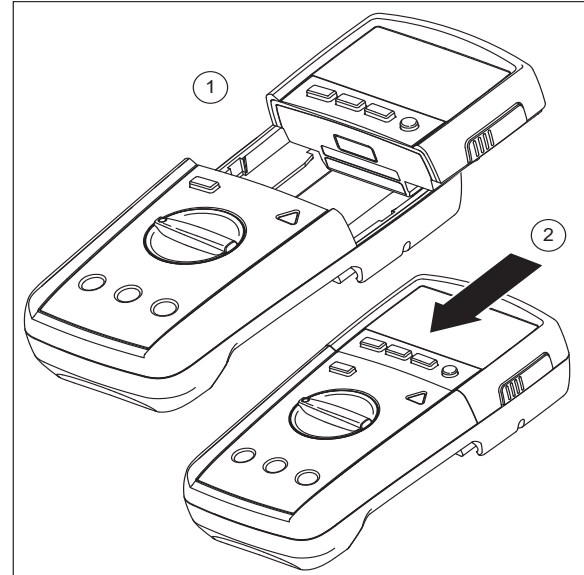

gcc115.eps

**Figure 2. Dock Display Module with Meter Base**

## Fuse Test

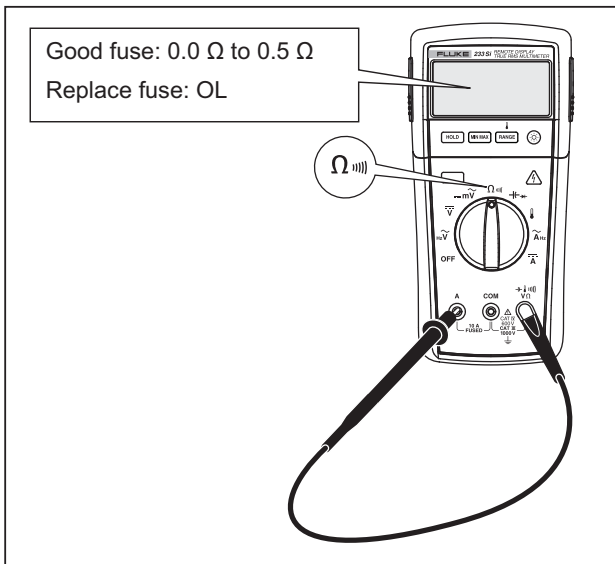

gcc105.eps

Figure 3. Fuse Test

## Battery Replacement

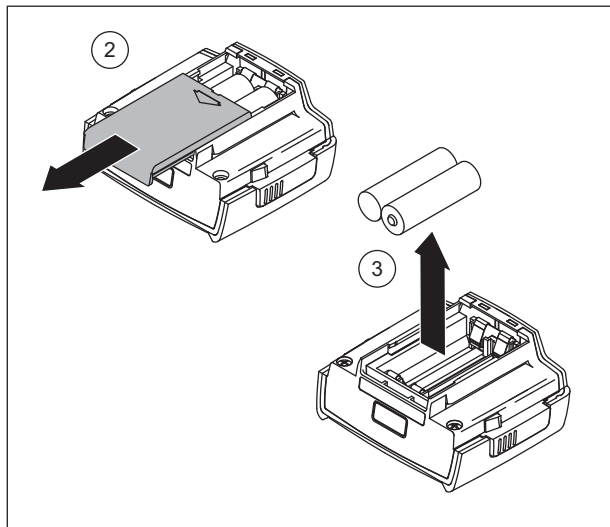

gcc111.eps

Figure 4. Display-Module Battery Removal

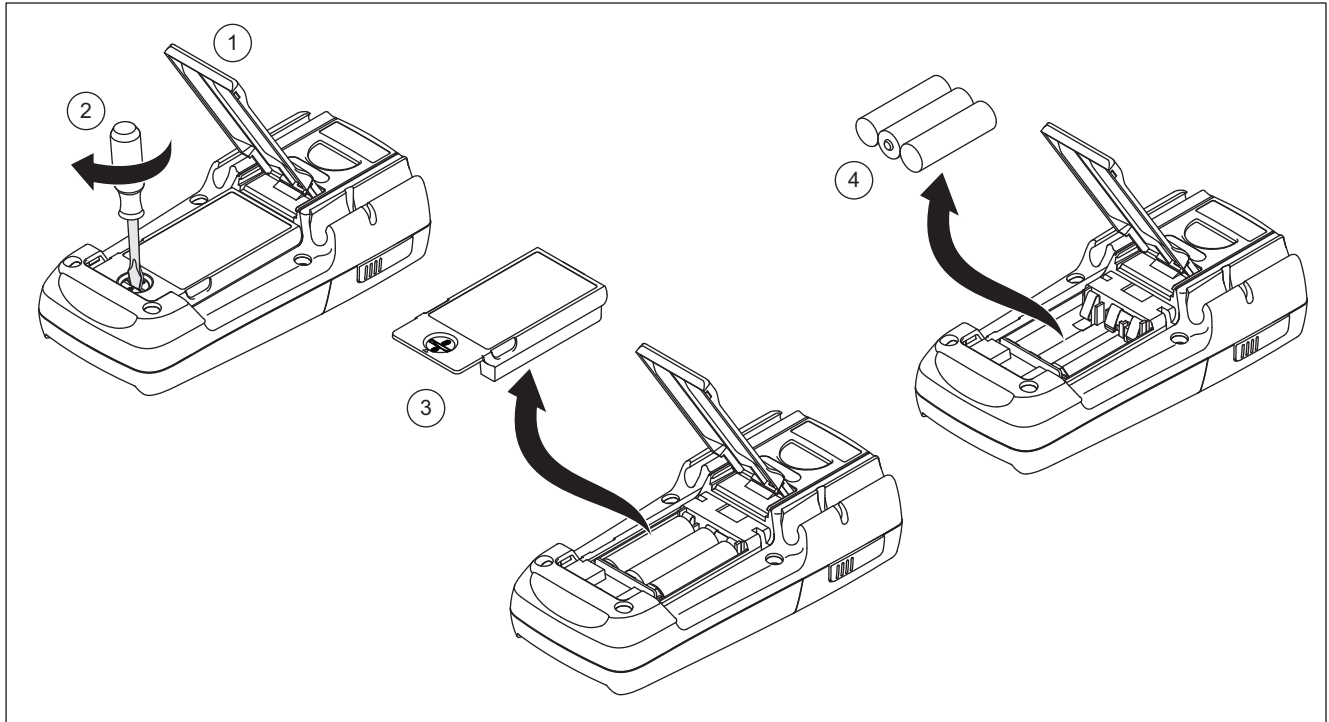

**Figure 5. Meter Base Battery Replacement**

gcc112.eps

## General Specifications

|  |  |
|--|--|
| <b>Maximum voltage between any terminal and earth ground</b> ..... | 1000 V rms   |
| <b>⚠ Fuse for A inputs</b> .....                                   | 11 A, 1000 V 17000A interrupt rating Fuse  |
| <b>Altitude</b>  |  |
| Operating .....  | 2,000 meters   |
| Storage .....  | 12,000 meters  |
| <b>Temperature</b>   |  |
| Operating .....  | -10 °C to +50 °C   |
| Storage .....  | -40 °C to +60 °C   |
| <b>Temperature coefficient</b> .....                               | 0.1 X (specified accuracy) / °C (< 18 °C or > 28 °C)   |
| <b>Electromagnetic Compatibility (EN 61326-1:2006)</b> ....        | In an RF field of 3 V/m, accuracy = specified accuracy except in temperature: specified accuracy $\pm 5$ °C (9 °F)                                     |
| <b>Wireless Frequency</b> .....                                    | 2.4 GHz ISM Band 10 meter range  |
| <b>Relative Humidity</b> .....                                     | Maximum noncondensing, 90 % at 35 °C, 75 % at 40 °C, 45 % at 50 °C, 0 % to 70 % for 40 M $\Omega$ range  |
| <b>Battery Type</b>  |  |
| Meter base .....   | Three AA Alkaline batteries, NEDA 15A IEC LR6  |
| Display module .....   | Two AA Alkaline batteries, NEDA 15A IEC LR6  |
| <b>Battery Life</b> .....  | 400 hrs typical (Alkaline)   |
| <b>Shock</b> .....   | 1 Meter drop 6 sides per IEC 61010   |
| <b>Safety Compliance</b> .....                                     | Complies with ANSI/ISA S82.01-2004, CSA 22.2 No. 61010-1-04 to 1000 V Measurement Category III and 600 V Measurement Category IV.                      |
| <b>Certifications</b> .....  | CSA, TÜV (EN61010), C $\text{\textcircled{C}}$ ,  (N10140), VDE, GOST |