



User Guide



myflavia.com

© 'FLAVIA' ®/™/® MASTERFOODS 2005
280-01198



myflavia.com
888 MYFLAVIA (888 693 5284)

WELCOME TO THE FLAVIA® WORLD.

You've made the right choice. The FLAVIA® FUSION™ drinks station offers 30 delicious drinks to suit your every mood.

From an exquisite range of round-the-globe coffees, to fresh leaf teas. From well being infusions, to total indulgence. FLAVIA® FUSION™ is all about choices.

The FLAVIA® world gives whatever you want, whatever you're like. Be inspired. With FLAVIA® FUSION™ you can mix and match and invent your own drink creations.

What are you waiting for? Stop reading, and start brewing. Keep this handy little guide on how your FLAVIA® FUSION™ drinks station works. If you have any questions go to myflavia.com or call 888 MYFLAVIA (888 693 5284). Your FLAVIA® friends are always there to help.

THIS PRODUCT IS FOR HOUSEHOLD USE ONLY.

PLEASE READ AND SAVE THIS USER GUIDE FOR FUTURE REFERENCE.

ASSISTANCE

To ORDER DRINKS or SPARE PARTS, or for general assistance - go on line at myflavia.com or call 888 MYFLAVIA (888 693 5284).

When ordering drinks at myflavia.com or 888 MYFLAVIA (888 693 5284), register the serial number of your FLAVIA® FUSION™ drinks station to facilitate any future warranty claim.

SHORT CORD INSTRUCTIONS

A short power supply cord is provided to reduce the risk resulting from becoming entangled in or tripping over a long cord. If an extension cord is used:

1. The marked electrical rating of the cord set or extension cord should be at least as great as the electrical rating of the appliance.
2. The cord should be arranged so that it will not drape over the counter-top or table-top where it can be pulled on by children or tripped over unintentionally.

WARRANTY

Conditions of limited Warranty

Your FLAVIA® FUSION™ drinks station is covered by a one year limited warranty from the date of purchase under normal use within the home.

If within 1 year from the purchase date of your FLAVIA® FUSION™ drinks station it should cease to function correctly due to mechanical or electrical failure, FLAVIA® will, at its discretion, repair or replace your FLAVIA® FUSION™ free of charge.

FLAVIA® will only pay for repair or replacement provided proof of purchase is seen. In order to ensure this, you should either keep your original purchase receipt or register your machine online at myflavia.com or call 888 MYFLAVIA (888 693 5284) and register with one of our Customer Service assistants.

The warranty is not valid if a defect is caused through poor maintenance of your FLAVIA® FUSION™ drinks station, lack of descaling, incorrect use (including the use of non FLAVIA® approved products), general wear and tear or if alterations or repairs have been carried out by a non-authorised service provider.

FLAVIA® reserves the right to offer an alternative appliance in the event that an exact replacement is not available. This will not affect your statutory rights.

Warranty claim process

In the event that your FLAVIA® FUSION™ should cease to function correctly, firstly refer to the TROUBLE SHOOTING GUIDE on page 16 of this guide.

If your FLAVIA® FUSION™ still does not work then call our FLAVIA® Customer Service Team on 888 MYFLAVIA (888 693 5284) where a technical consultant will be waiting to assist you. You will be asked for proof of purchase if you have not registered your FLAVIA® FUSION™ drinks station previously.

If they are unable to resolve the issue over the telephone then they will authorise the replacement of your FLAVIA® FUSION™ drinks station.

Please note that FLAVIA® will endeavour to replace your FLAVIA® FUSION™ drinks station with a replica unit. However in the event that this is not feasible, FLAVIA® will offer you an alternative. Please note that your replacement FLAVIA® FUSION™ drinks station, may have been refurbished to an as new condition. This will not affect your statutory rights or any warranty remaining on the product.

When ordering drinks at myflavia.com or 888 MYFLAVIA (888 693 5284), register the serial number of your FLAVIA® FUSION™ drinks station to facilitate any future warranty claim.

Problem	Solution
Water leaks from the appliance	Make sure that the Pack Door is fully closed when brewing beverages. Make sure the water Reservoir has not been filled beyond the MAX indication line. Make sure the Drip Tray is not overflowing. In all other cases, switch off and unplug the appliance immediately and contact the FLAVIA® Customer Service Team.
Beverages are too strong and/or small Beverages are too weak and/or large	Adjust the volume of beverage dispensed (see the GETTING THE MOST FROM YOUR APPLIANCE section on page 8). Choose an alternative strength beverage from the extensive FLAVIA® range.
Liquid splashes out of, or misses altogether, the cup	Ensure the Brew Head is as close to the top of the cup as possible during brewing. Ensure your cup or mug is placed in the centre of the Cup Stand.
The Volume Control does not vary the size of drinks brewed on the left or right Selection Buttons	This is normal. The Volume Control only varies the size of drinks brewed on the middle Selection Button.

IMPORTANT SAFEGUARDS

To prevent harm or injury to those using the appliance or to any other persons and/or property.

READ THE FOLLOWING SAFETY INSTRUCTIONS

GENERAL USE

- ⚠ Always place the appliance out of reach of children. Children and persons unfamiliar with the appliance should only use it under supervision. Not observing these precautions may cause burns, electric shock or other injury.
- ⚠ Do not place the appliance on an unstable surface or surfaces that can be affected by heat. The appliance may tip over causing damage or injury.
- ⚠ Do not place the appliance close to walls or furniture. Steam and heat could damage walls and furniture, causing a change to the color or shape.
- ⚠ Never place the appliance outside. This appliance is for indoor use only.
- ⚠ Never use the appliance at altitudes above 2500m.
- ⚠ Never overfill the appliance with water as this may result in electric shock.
- ⚠ Never put anything other than water in the Water Reservoir. Do not put milk, alcohol or anything other than cold water in the Water Reservoir. This may result in serious damage to the appliance.
- ⚠ Never use packs that have been stored in the refrigerator or freezer.
- ⚠ Never tilt or shake the appliance, as this may result in spillage which could lead to electric shock.
- ⚠ Never turn the appliance upside down, as this may result in spillage and/or serious damage to the machine.
- ⚠ Never use without placing a cup or mug under the water outlet. Hot water may splash against the Drip Tray causing burns.
- ⚠ Never attempt to dismantle, repair or modify the appliance in any way. Any attempt to do so may result in fire or injury. Always contact the FLAVIA® Customer Service Team.
- ⚠ Do not immerse the appliance in water. This may result in an electric shock.
- ⚠ Never use the appliance to store ice. Condensation could occur creating a potential source of electric shock or malfunction.
- ⚠ Only clean specified areas.
- ⚠ Ensure that the mug or cup you use is the right size for the beverage you are brewing. Failure to do so could lead to overflow and may cause burns.

- ⚠ Never remove the cup during brewing as this may cause burns.
- ⚠ Never open the Pack Door during brewing cycle as this may cause burns.
- ⚠ Do not move the appliance while a cup or mug is on the Cup Stand. This may cause burns.

ELECTRICAL SUPPLY AND CORD

- ⚠ Never do anything that might cause damage to the Cord or Plug (such as modifying, bending, stretching or twisting them or placing hot or heavy objects on them). If the appliance is used when damaged, electrical short circuit or fire may result. If in need of repair please contact the FLAVIA® Customer Service Team.
- ⚠ Clean Plug regularly, a build up of dust on the Plug will attract condensation, which could lead to cable damage resulting in fire. Remove the Plug and clean with a dry cloth.
- ⚠ Make sure the Plug is correctly inserted into the outlet. A loose connection or damaged Plug may cause electric shock or generate heat resulting in fire.
- ⚠ 120 V outlet must not be used with other appliances, the heat generated may result in fire.
- ⚠ Never plug or unplug the appliance with wet hands. This may result in electric shock.
- ⚠ Remove the plug from the socket only when the appliance is not in use. Deteriorating insulation may result in electric shock and/or fire.
- ⚠ When unplugging the appliance, always pull by the Plug – NOT THE CORD!

POLARIZED PLUG

This appliance is fitted with a polarized Plug (one blade is wider than the other) as a safety feature.

To reduce the risk of electric shock:

- ⚠ Fit the Plug into the outlet in the correct way
- ⚠ If the Plug does not properly fit in to the outlet at first, reverse it.
- ⚠ If the Plug still does not fit, contact a qualified electrician.
- ⚠ Do not attempt to modify the Plug in any way.

SAVE THESE SAFETY INSTRUCTIONS.

TROUBLE SHOOTING GUIDE

If you experience a problem with this appliance, you may find a solution in the table below. If the table below does not provide a solution to your problem or if you have any additional questions please see the section titled ASSISTANCE on page 1 of this booklet.

Problem	Solution
The appliance does not operate	Check that the Plug is correctly inserted in to the outlet. Check that the Power switch is in the ON position.
The appliance does not brew beverages when used for the first time	The appliance must be primed with water before using it for the first time, so that the boiler will be completely filled with water. Prime the appliance (see PREPARING YOUR APPLIANCE FOR USE on page 6) before brewing beverages.
The 3 Indicator Lights flash quickly	Check that the Water Reservoir is correctly fitted to the machine and/or filled to the MAX indication line.
The 3 Indicator Lights flash slowly	The appliance is heating the water to the optimum temperature for brewing. This may take up to 90 seconds.
The 3 Indicator Lights are off	The appliance has seen no activity for at least 40 minutes and has gone in to "Power Save" mode. To power up the machine press any Selection Button or open the Pack Door. The machine will now re-heat the water to the optimum temperature.
The right Indicator Light is flashing	This will occur when the first pack of a 2-pack beverage is complete. Insert the 2 nd pack and press the right button to complete your beverage. If you choose to cancel, simply press the left or middle button to do so.
The Indicator Lights display a sequence other than those mentioned above	Contact the FLAVIA® Customer Service Team (see ASSISTANCE section on page 1)
The Pack Door cannot be closed	Check that the Pack Door is correctly fitted to the appliance. Please note: When closing the Pack Door with a pack present, you will feel some resistance, this is only the seal of the pack being pierced and is perfectly normal. Please check that nothing is blocking the "latch."
The pack cannot be pierced	Check that the pack is correctly inserted, and that the Pack Door is correctly fitted to the appliance.
The appliance makes a "pop" sound shortly after the Selection button is pressed	Occasionally a "pop" may be heard at the start of a beverage being brewed, this is normal and is confirmation of the optimal freshness of your beverage.
The amount of beverage dispensed is repeatedly too small and/or is dispensing too slowly	The boiler and internal parts of the machine have become blocked with scale. See the DESCALING YOUR APPLIANCE section on page 15.

DESCALING YOUR APPLIANCE

Regular descaling will prolong the life of your appliance and will ensure optimal brewing performance for the life of your brewer. If the machine is used twice per day on average, the appliance must be descaled at least once every 3 months.

Remove the Water Filter from the Water Reservoir if fitted. Fill the Water Reservoir up to the MAX indication line with white wine vinegar or descaler and water, according to the descaler manufacturers guidelines. Fit the Water Reservoir to the machine.

! Use only citric acid based descaler.

Remove the drip tray and place a bowl with a capacity of at least 45 fl.oz under the Brew Head.

Switch the appliance on and wait until the 3 indicator lights are lit continuously.

Following the process BREWING YOUR BEVERAGES (from page 11), insert a USED pack into the Brew Head.
If available, please insert a used instant pack e.g. Choco or Creamy Topping.

Adjust the Volume Control to the maximum setting.

1. Press the MIDDLE selection button (coffee/tea). Allow the machine to operate.
2. Repeat this until the water reservoir is empty.
3. Remove, empty and replace the bowl on the appliance.

Repeat steps 1 - 3, three times with new white wine vinegar or a new mixture of descaler.

Empty the Water Reservoir to remove any remaining descaler.

Flush the machine with fresh water following the steps 1 - 3, three times.

! The appliance has no other user-serviceable parts. Any other service should be performed only by the FLAVIA® Customer Service Team.

TABLE OF CONTENTS

Features of your Appliance

Preparing your Appliance for use

Getting the most from your Appliance

Filling your Appliance with water

Brewing your Beverages

Brewing 2-pack Beverages

Cleaning and Maintenance of your Appliance

Descaling your Appliance

Trouble-shooting Guide

Warranty

FEATURES OF YOUR APPLIANCE

Ref.	Part Name	Spare or accessory
1	Water Reservoir	Yes
2	Lid	Yes
3	Water Filter	Yes
4	Drip Tray	Yes
5	Cup Stand	Yes
6	Pack Door	Yes
7	Pack Holder	
8	Top Ring	
9	Brew Head	
10	Brew Head Adjustment Button	
11	Beverage Selection Buttons	
12	Indicator Lights	
13	Volume Control	
14	Power Switch	
15	Power Cord	
16	Plug	
17	User Guide	Yes

To order spare parts or accessories contact the FLAVIA® Customer Service Team. (see section titled ASSISTANCE at the start of this guide).

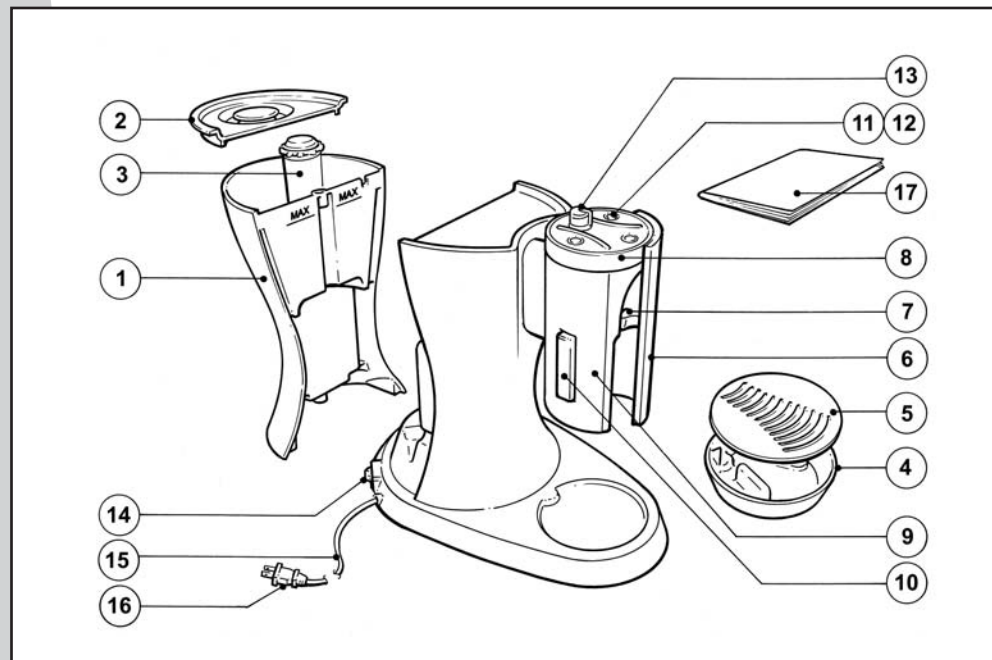

Your appliance may differ slightly from that illustrated in this guide.

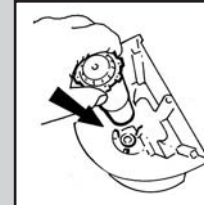
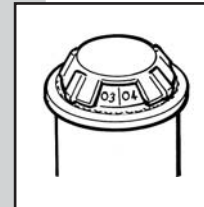

Periodic Maintenance

Your appliance is supplied with a Water Filter to ensure the optimal quality of water used in brewing your beverages. To maintain the quality of beverages brewed, while protecting and extending the life of your appliance, you will need to replace this filter periodically.

The recommended replacement frequency is every 50 litres (approximately 250 beverages) or 2 months whichever comes first. The frequency of replacement depends on the number of drinks brewed.

There is a rotating disk on the filter to set the replacement date. You can set both the month and the week of the month.

Water Filter Replacement

To remove old filter - remove the Lid (and Water Reservoir if necessary) from the appliance. Pull the Filter firmly upward to remove it.

To install a new Filter – remove the Filter from its packaging and push the small end of the Filter down firmly into the round location at the bottom of the Water Reservoir.

Continued use of the Filter will inhibit the build up of scale and reduce the need for periodic descaling.

Storage

If the appliance has been used and therefore primed, it should only be used or stored in a frost free environment to prevent it from becoming damaged. Before storing the appliance you should remove and empty the Water Reservoir. After a period of storage we recommend that you rinse the Water Reservoir and brew 2 drinks with fresh water to cleanse the appliance.

CLEANING AND MAINTENANCE OF YOUR APPLIANCE

- ⚠ Never immerse the appliance in water or any other liquid. Always turn the appliance off and unplug it before cleaning.

Daily maintenance

Fill the Water Reservoir or empty the Drip Tray if required. Any other daily maintenance should be unnecessary.

Weekly maintenance

Wipe the outside of the appliance with a damp cloth.

Open the Pack Door and wipe the inside surfaces of the Pack Holder with a damp cloth.

The Pack Door, Drip Tray and Cup Stand should be washed with a wet cloth.

- ⚠ Do not clean with brushes or scouring agents as this may damage the surface of your appliance.
- ⚠ Do not wash with excessive amounts of water, it could get into the machine causing a malfunction.
- ⚠ Do not use cleaning agents as they may leave a residue on the appliance.
- ⚠ Do not apply any products containing benzene, they may damage the surface of your appliance.

How to remove the Pack Door

Open the Pack Door as described in section 4 BREWING YOUR BEVERAGES.

Pull the Pack Door straight down to remove.

The Pack Door should only be removed in the open position.

To re-fit the Pack Door, push straight up until you feel a "click."
The Pack Door should only be re-fitted in the open position.

- ⚠ Do not attempt to operate the appliance without the Pack Door fitted.

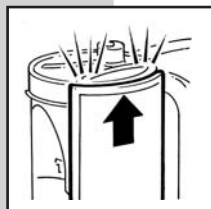
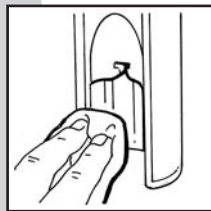

PREPARING YOUR APPLIANCE FOR USE

- ⚠ YOU CANNOT BREW BEVERAGES IF YOU HAVE NOT PRIMED THE APPLIANCE FIRST!

The priming cycle fills the boiler with water. After this your appliance will be ready to use.

Remove the Water Reservoir from the machine.

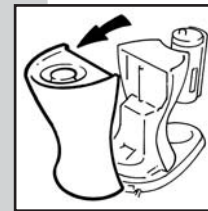

Remove the Lid. Inside you will find a Water Filter. Remove the Filter from its packaging and install, small end first, by pushing it firmly into the round location at the bottom of the Water Reservoir.

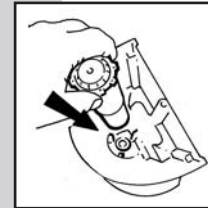

Fill the Water Reservoir with cold water up to the MAX indication line and put it back on to the appliance. Replace the Lid.

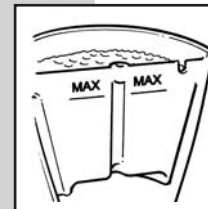

Put the Plug into a 120V AC electrical outlet.



Put the Drip Tray onto the appliance in the position indicated. *Ensure the Pack Door is closed and the Brew Head is in the down position.*



- ⚠ DO NOT fit the Cup Stand at this stage.

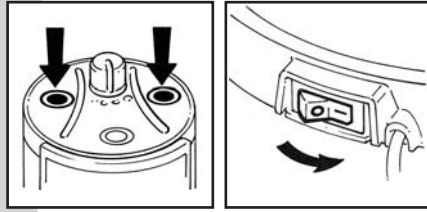

Press the left and right selection buttons down simultaneously.
While holding these down switch the machine on.

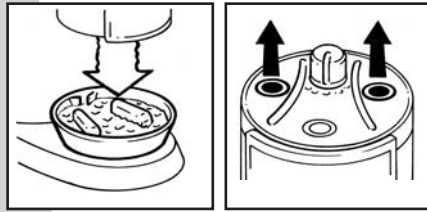

Continue to hold down the buttons until water is dispensed into the Drip Tray.
It will take up to 20 seconds to fully prime the appliance and water to appear. This is normal.

Release both buttons.

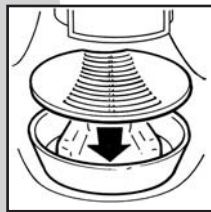

Empty the Drip Tray and return it to the appliance.
Place the Cup Stand on top of the Drip Tray.

YOUR APPLIANCE IS NOW READY TO USE!

The appliance will now start to brew your beverage.
The indicator light of the selection button pressed will flash slowly while your beverage is brewing.
The appliance automatically supplies the optimal amount of water. Each button delivers the drink with its own unique brew cycle. This means that water may flow from the pack or from the Jet system. This is normal. The brew cycle may also include a number of pauses. This is normal.

- ⚠ **Do not open the door or attempt to remove the pack before brewing has finished.**
You can interrupt the brewing process at any time by pressing any of the 3 selection buttons. The machine however will not complete the interrupted beverage.
- ⚠ **Take care when removing the pack immediately after interrupting the brewing process as it will be HOT and may drip HOT WATER.**
- ⚠ **Do not remove the Water Reservoir during brewing as the next beverage brewed will be too small.**

When Brewing is complete, the appliance will automatically stop.
Open the Pack Door, remove the used pack and discard it.

- ⚠ **Take care when removing the pack immediately after brewing has finished as it will be HOT.**

BREWING 2-PACK BEVERAGES

Follow the steps on page 11 of this guide.

At the end of the 1st brew, the right hand indicator light will flash.
This is a prompt to insert the 2nd pack.

- ⚠ **Open the Pack Door, remove the used pack and discard it. Take care when removing the pack immediately after brewing has finished as it will be HOT.**

Insert the 2nd pack, close the Pack Door and push the right hand selection button.
Push the pack fully into the Brew Head until it "clicks" into position.

The machine will start to brew the 2nd pack of your beverage.

At the end of the 2nd brew, the 3 indicator lights will flash.

- ⚠ **Open the Pack Door, remove the used pack and discard it. Take care when removing the pack immediately after brewing has finished as it will be HOT.**

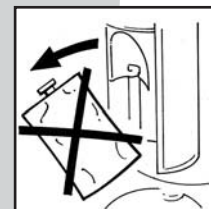
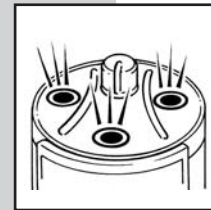
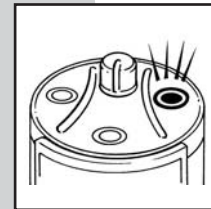
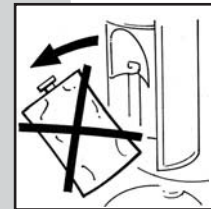

BREWING YOUR BEVERAGES

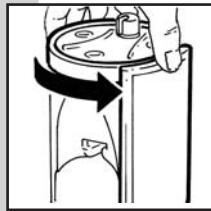

Open the Pack Door by rotating the Top Ring a quarter turn counter clockwise.

! Do not attempt to open or close by the Pack Door itself.

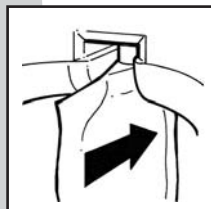

Insert the pack in to the Brew Head.
Push the pack fully in to the Brew Head until it "clicks" into position.

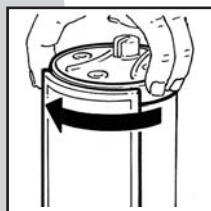

Close the Pack Door fully by rotating the Top Ring a quarter turn clockwise.
When closing the door you will feel some resistance, this is only the seal of the pack being pierced and is perfectly normal.

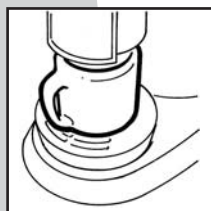

Place a cup or mug on the Cup Stand.
Use a mug or cup of the correct size for the beverage.
! To minimize the risk of splashing, position the Brew Head as close to the top of the cup or mug as possible.

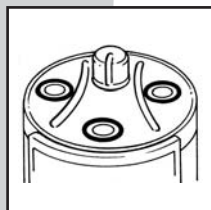

Press a Selection Button.
Press the middle button for all Coffee, Tea and Wellbeing beverages.
Press the right button for all 2-pack beverages (e.g. Cappuccino).
Press the left button for Choco and other beverages.

GETTING THE MOST FROM YOUR APPLIANCE

Pure Water For The Finest Hot Beverages Every Time

For a great-tasting hot beverage in every cup, replace the FLAVIA® filter every two months. FLAVIA® filter cartridges will help protect your FLAVIA® FUSION™ drinks station and extend its life. The organic ion exchangers and activated charcoal reduce heavy metals and other contaminants, as well as substances such as chlorine which could impair the flavor and aroma of your hot beverage. The filter goes straight in the reservoir and does not require any accessories or take up any extra space. It's easy to order FLAVIA® Filters. Go to myflavia.com or call 888 MYFLAVIA (888 693 5284).

Packs

Packs should be stored in a cool dry place.
If unopened, your packs are good until the best before date shown on the back of the pack.

! Packs should not be stored in a refrigerator or freezer.

Cups/Mugs

! To avoid spillage or burns, please ensure the correct size mug or cup is always used.

Beverage Selection Buttons

Your appliance is fitted with 3 selection buttons, which enable a wide choice of beverages to be made with the push of a button. The button to press depends on your particular choice of beverage (see the table below).

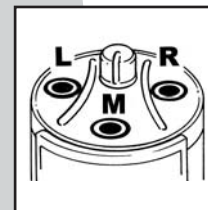

Selection button	Graphic	Beverages to be brewed
Left		Choco Other *
Middle		Coffees Teas Wellbeing range
Right		Frothy 2-pack beverages e.g. Cappuccino (Creamy Topping then Coffee) Mochaccino (Choco then Coffee) Chococcino (Creamy Topping then Choco) Chai Latte (Creamy Topping then Chai Tea)

* (exciting new FLAVIA® drinks coming)

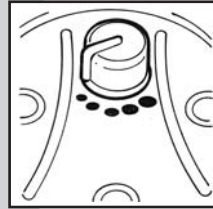

Beverage Volume Control

Your FLAVIA® appliance is designed to brew the optimal beverage every time. However, you can tailor your Coffee, Tea and Wellbeing beverages to your own particular tastes by using the Beverage Volume Control. The control settings deliver the following beverage volumes.

This control only varies the size of beverages prepared on the middle button (Coffee, Tea, and Wellbeing range).

Control Setting	Graphic	Approx. Beverage Size (fl.oz)
1 (smallest)	◦	3
2	◦	4 1/3
3	◉	5 2/3
4	●	7
5 (largest)	●	8 1/3

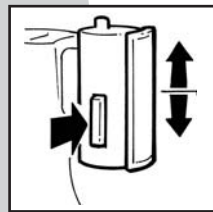

Brew Head Adjustment

You can easily adapt your appliance to accommodate your favorite mug or cup by simply adjusting the height of the Brew Head. The Drip Tray can also be removed to accommodate your travel mug.

Position the Brew Head close to the top of your cup or mug to minimize the splash from your appliance.

FILLING THE APPLIANCE WITH WATER

Remove the Water Reservoir from the appliance.

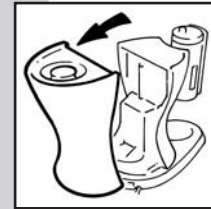

Remove the Lid and fill the Water Reservoir with cold water up to the MAX indication line and put it back on to the appliance.

We recommend filtered drinking water only. A full reservoir allows you to make up to six 7 oz. beverages.

! Never pour anything other than cold water in to the reservoir.



Switch the appliance on.

The 3 Indicator Lights will flash slowly while the water is heating up (which will take about 90 seconds).

The appliance is ready for use when the 3 Indicator Lights are lit continuously.

