



www.fisher-price.com

H5698
Instructions



Please keep this instruction sheet for future reference,
as it contains important information.

Requires three "AA" **alkaline** batteries (not included).

Adult assembly is required.

Tool required for battery installation:

Phillips screwdriver (not included).



Parts

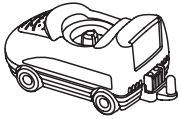

Train Engine

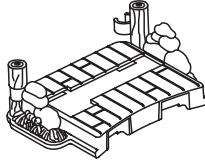

Farm Base

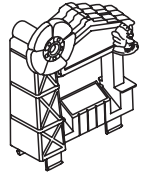

Farm



2 Train Cars



Tree Swing

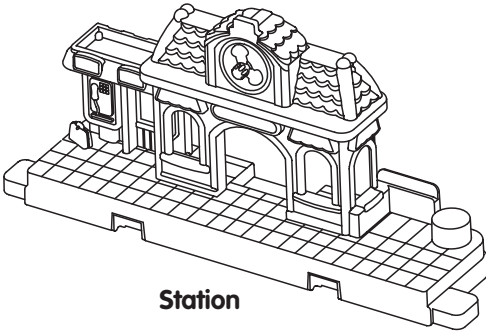

Station

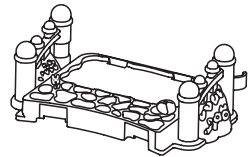

Tree Swing Base

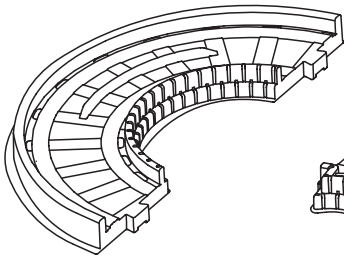

3 Track Pieces

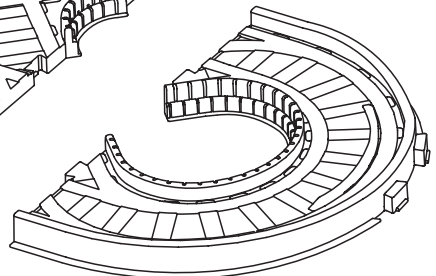
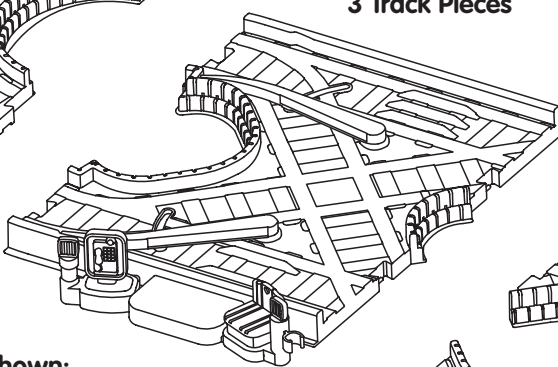

Parts Not Shown:
Flower Pot
Apple Crate
Cargo
3 Figures

Assembly

1

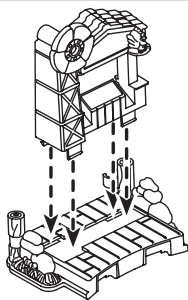

- **"Snap"** the farm into the farm base.

2

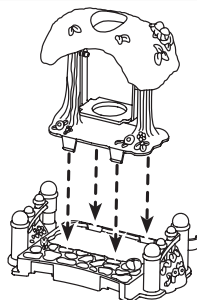

- **"Snap"** the tree house into the tree house base.

3

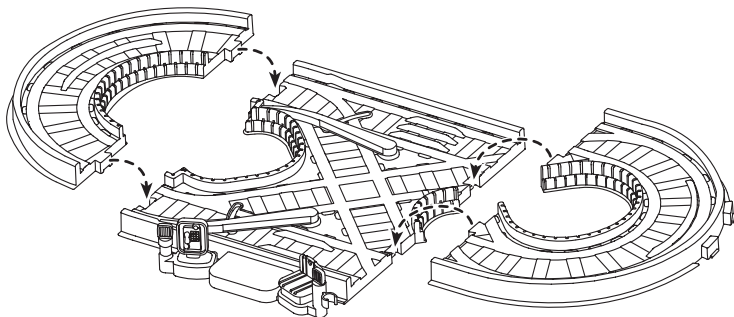

- Fit the two curved track pieces onto the center track, as shown.

4

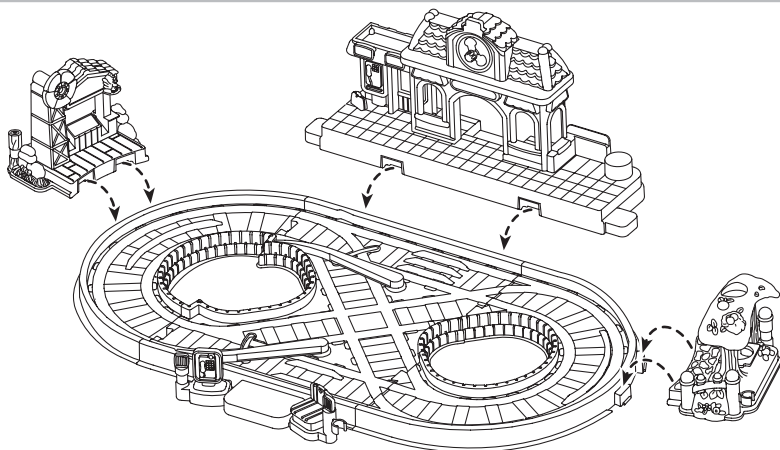

- Fit the farm, station and tree house onto the tabs around the track, as shown.

Battery Installation

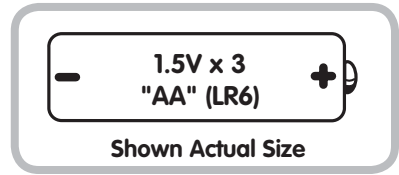
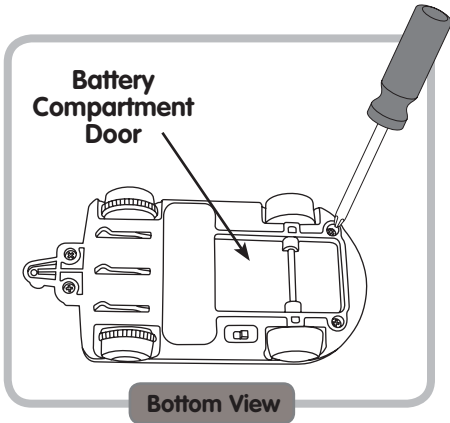

Battery Safety Information

Batteries may leak fluids that can cause a chemical burn injury or ruin your toy. To avoid battery leakage:

- Locate the battery compartment door on the bottom of the train engine.
- Loosen the screws in the battery compartment door with a Phillips screwdriver. Remove the battery compartment door.
- Insert three "AA" (LR6) **alkaline** batteries.

Hint: We recommend using **alkaline** batteries for longer life.

- Replace the battery compartment door and tighten the screws with a Phillips screwdriver. Do not over-tighten.
- When sounds or motions become faint or stop, it's time for an adult to change the batteries!

- Do not mix old and new batteries or batteries of different types: alkaline, standard (carbon-zinc) or rechargeable (nickel-cadmium).
- Insert batteries as indicated inside the battery compartment.
- Remove batteries during long periods of non-use. Always remove exhausted batteries from the toy.
- Dispose of batteries safely. Do not dispose of batteries in a fire. The batteries may explode or leak.
- Never short-circuit the battery terminals.
- Use only batteries of the same or equivalent type, as recommended.
- Do not charge non-rechargeable batteries.
- Remove rechargeable batteries from the toy before charging.
- If removable, rechargeable batteries are used, they are only to be charged under adult supervision.

CAUTION

To prevent entanglement, keep hair away from wheels.

Fun Sounds Around the Track!

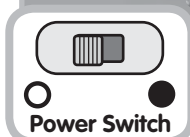

- Locate the power switch on the bottom of the train engine.
- Slide the switch to the ● position to turn the toy on and to the ○ position to turn it off.
- Place a figure in the train engine and press down.
- As the train travels around the track, you'll hear sound effects as it passes the farm and the tree swing. At the station, the train stops to play a song.
- Use the train off the track too!

Note: If your child is not actively playing with the train, it goes to sleep. To "wake up" the train, press down on a figure in the driver's seat.

- For best performance, use on hard, flat surfaces. We do not recommend using the train engine on carpets.

Care

- Wipe the surface with a clean cloth dampened with a mild soap and water solution. Do not immerse this toy.
- This toy has no consumer serviceable parts. Do not take this toy apart.

Consumer Information

Questions? We'd like to hear from you!

Call Fisher-Price® Consumer Relations, toll-free at **1-800-432-5437**, 8 AM - 6 PM EST Monday through Friday. Hearing-impaired consumers using TTY/TDD equipment, please call 1-800-382-7470. Or, visit us on line at **www.service.fisher-price.com**.

Write to us at:

Fisher-Price® Consumer Relations
636 Girard Avenue
East Aurora, New York 14052.

FCC Note (United States Only)

Note: This equipment has been tested and found to comply with the limits for a Class B digital device, pursuant to Part 15 of the FCC Rules. These limits are designed to provide reasonable protection against harmful interference in a residential installation. This equipment generates, uses and can radiate radio frequency energy and, if not installed and used in accordance with the instructions, may cause harmful interference to radio communications. However, there is no guarantee that interference will not occur in a particular installation. If this equipment does cause harmful interference to radio or television reception, which can be determined by turning the equipment off and on, the user is encouraged to try to correct the interference by one or more of the following measures:

- Reorient or relocate the receiving antenna.
- Increase the separation between the equipment and receiver.
- Consult the dealer or an experienced radio/TV technician for help.

Note: Changes or modifications not expressly approved by the manufacturer responsible for compliance could void the user's authority to operate the equipment.

For countries outside the United States:

CANADA: Questions? 1-800-432-5437. Mattel Canada Inc., 6155 Freemont Blvd., Mississauga, Ontario L5R 3W2; www.service.mattel.com.

GREAT BRITAIN: [Mattel UK Ltd, Vanwall Business Park, Maidenhead SL6 4UB](http://Mattel_UK_Ltd_Vanwall_Business_Park_Maidenhead_SL6_4UB). Helpline: 01628 500302.

AUSTRALIA: Mattel Australia Pty. Ltd., 658 Church Street, Locked Bag #870, Richmond, Victoria 3121 Australia. Consumer Advisory Service 1300 135 312.

NEW ZEALAND: 16-18 William Pickering Drive, Albany 1331, Auckland.

ASIA: Mattel East Asia Ltd, Room 1106, South Tower, World Finance Centre, Harbour City, Tsimshatsui, HK, China.